



Allen-Bradley

*Hand-Held
Undecoded Bar
Code Scanner*

*Cat. No. 2755-HUG-4,
2755-HUG-9*

**User
Manual**



Important User Information

Because of the variety of uses for the products described in this publication, those responsible for the application and use of this control equipment must satisfy themselves that all necessary steps have been taken to assure that each application and use meets all performance and safety requirements, including any applicable laws, regulations, codes and standards.

The illustrations, charts, sample programs and layout examples shown in this guide are intended solely for purposes of example. Since there are many variables and requirements associated with any particular installation, Allen-Bradley does not assume responsibility or liability (to include intellectual property liability) for actual use based upon the examples shown in this publication.

Allen-Bradley publication SGI-1.1, *Safety Guidelines for the Application, Installation, and Maintenance of Solid-State Control* (available from your local Allen-Bradley office), describes some important differences between solid-state equipment and electromechanical devices that should be taken into consideration when applying products such as those described in this publication.

Reproduction of the contents of this copyrighted publication, in whole or in part, without written permission of Allen-Bradley Company, Inc., is prohibited.

Throughout this manual we use notes to make you aware of safety considerations:



ATTENTION: Identifies information about practices or circumstances that can lead to personal injury or death, property damage or economic loss.

Attention statements help you to:

- identify a hazard
- avoid the hazard
- recognize the consequences

Important: Identifies information that is critical for successful application and understanding of the product.

Table of Contents

Preface

Intended Audience	P-1
Contents of this Manual	P-2
Related Publications	P-3
Laser Warning Symbol	P-3

Chapter 1 Scanner Features

Scanner Features	1-2
LED Indicators	1-3
Safety Labels	1-4
Scanning Ranges	1-5
Standard Range Scanner (Catalog No. 2755-HUG-4)	1-6
Extended Range Scanner (Catalog No. 2755-HUG-9)	1-7
Accessories	1-8

Chapter 2 Connecting and Operating Scanner

Compatible Decoders	2-1
Scanner Cable	2-2
Connecting the Scanner to a Decoder	2-3
Operating the Scanner	2-5
Spotter Beam	2-6
Automatic Shutoff	2-6
Audible Response	2-6
Operating Tips	2-7

Chapter 3 Troubleshooting and Maintenance

Troubleshooting the Scanner	3-2
Cleaning the Scan Window	3-4

Specifications

Appendix A

Connector Pinouts

Appendix B

European Union Directive Compliance

Appendix C

Glossary

Using this Manual

Read this preface to familiarize yourself with the rest of the manual. This preface covers the following topics:

- intended audience
- chapter contents
- laser warning symbol
- related publications

Intended Audience

No special knowledge is required to understand this document or to use the scanner. Undecoded scanners require a decoder. We assume that you are familiar with the operation and cable inputs to your decoder.

Contents of this Manual

The following table briefly describes the contents of each section.

Chapter	Title	Contents
Preface	Using this Manual	Describes the purpose, background, and scope of this manual. Also provides a list of related publications.
1	Scanner Features	Overview of the scanner. Includes read range charts and description of accessory items.
2	Connecting and Operating the Scanner	Describes how to connect the scanner to a decoder. Operating tips are also provided.
3	Troubleshooting and Maintenance	Provides solutions to the most common operating problems. Also includes instructions on cleaning the scan window.
Appendix A	Specifications	Provides physical, electrical and environmental specifications.
Appendix B	Scanner Connector Pinouts	Provides scanner pinout signal names and a brief description of each.
Appendix C	European Union Compliance Directives	Lists requirements for use of scanner within the European Union.
Glossary		Provides definitions for commonly used terminology.
Inside Back Cover	Bar Code Test Symbols	Sample symbols useful for testing the operation of your bar code system.

Related Publications

Below is a list of related publications you may need to refer to when using the scanners.

Publication No.	Title
2755-921	Bar Code Basics Describes bar code symbologies, equipment, and typical applications.
2755-833	User Manual for DS/DD Series B Enhanced Decoders
2755-ND010	User Manual for Single-Head Enhanced Decoder (Catalog No. 2755-DS1A)
2755-ND011	User Manual for Dual-Head Enhanced Decoder (Catalog No. 2755-DD1A)
2755-2.37	Product Data Sheet for Bulletin 2755 Gun Adapter (Catalog No. 2755-NC16)

Laser Warning Symbol

Be aware of the following laser caution symbols.

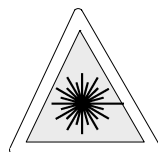

Scanner Features

This chapter describes the features of the standard and extended range, undecoded scanners. Included are descriptions of:

- major features
- LEDs
- scanning ranges
- safety labels
- accessories

Scanner Features

The scanners use a low power visible (red) laser diode for scanning. The trigger turns on the laser which scans a label at approximately 36 scans per second.

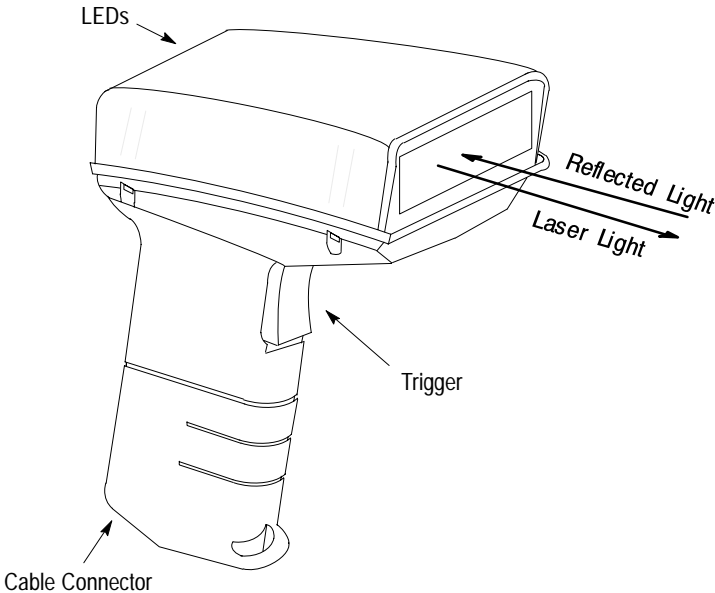

The laser beam:

- exits through the scan window
- reflects off the label back through the window
- is detected by a sensor in the scanner

When a label is read, the laser beam is automatically turned off until the trigger is pressed again. If no label is read, the laser beam automatically turns off after approximately 3 seconds and remains off until the trigger is released and pressed again.

Note: The Extended Range Scanner (Catalog No. 2755-HUG-9) has a two position trigger. The first detent provides a spotter beam and the second position provides a scan line.

LED Indicators

On the back of the scanner there is a clear window through which two LEDs are visible.

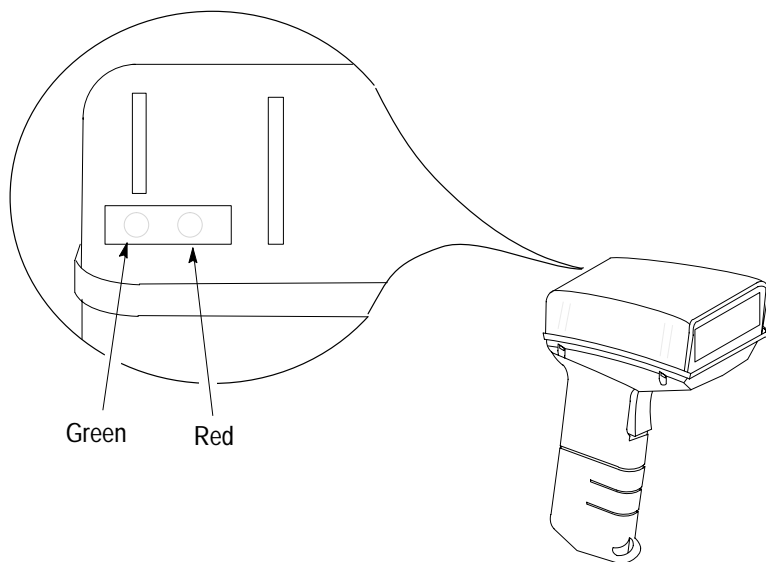

Green LED = Good Read, indicating that a bar code symbol has been scanned and decoded. LED remains on until the next scan (trigger pressed).

Red LED = Scanning, indicating that the laser light is on.

Safety Labels

The scanners use a low power visible laser diode. As with any bright light source, you should avoid staring directly into the beam. Momentary exposure to a CDRH Class II laser is not known to be harmful.

The following figure shows the location of all safety labels as they appear on the scanner.

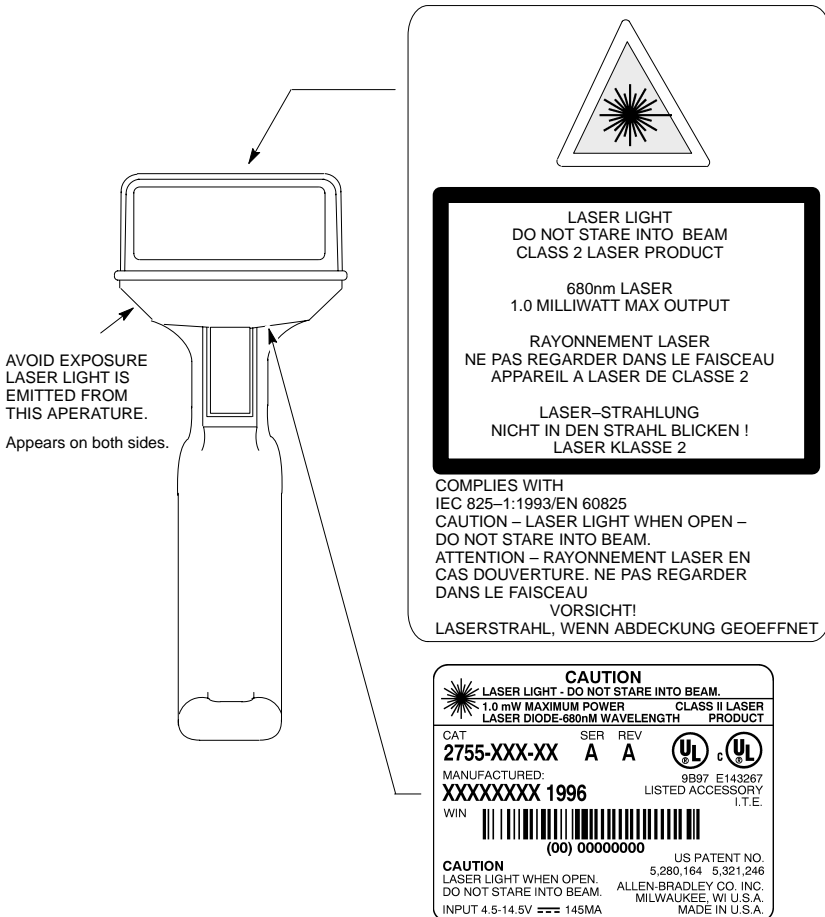

Scanning Ranges

The scanners can read bar code symbols at various distances depending upon the bar code symbol density (width of narrow bars or spaces). The following table lists the read ranges for both the standard and extended range scanners.

Minimum Symbol Density	Standard Range (Catalog No. 2755-HUG4) Inches / Centimeters	Extended Range (Catalog No. 2755-HUG9) Inches / Meters
5.0 mil (.13 mm)	1.25 in to 2.7 in (3.2 cm to 6.9 cm)	Not Applicable
7.5 mil (.19 mm)	1.0 in to 7.0 in (2.5 cm to 17.8 cm)	5.0 in to 11 in (0.13 m to 0.28 m)
10.0 mil (.25 mm)	Data Not Available	4.0 to 13 in (0.10 m to 0.33 m)
15.0 mil (.38 mm)	Data Not Available	4.0 to 60 in (0.10 m to 1.52 m)
20.0 mil (.51 mm)	1.0 in to 27 in (2.5 cm to 69 cm)	5.0 to 65 in (0.13 m to 1.65 m)
40.0 mil (1.02 mm)	4.5 in to 37 in (11.4 cm to 94 cm)	14 in to 120 in (0.36 m to 3.05 m)
55.0 mil (1.40 mm)	7 in to 50 in (17.8 cm to 127 cm)	24 in to 156 in (0.61 m to 3.96 m)
70.0 mil (1.78 mm) Reflective	Not Applicable	96 in to 276 in 2.43 m to 7.01 m
100 mil (1.02 mm) Reflective	Not Applicable	96 in to 420 in (2.44 m to 10.67 m)

Standard Range Scanner
Catalog No. 2755-HUG4

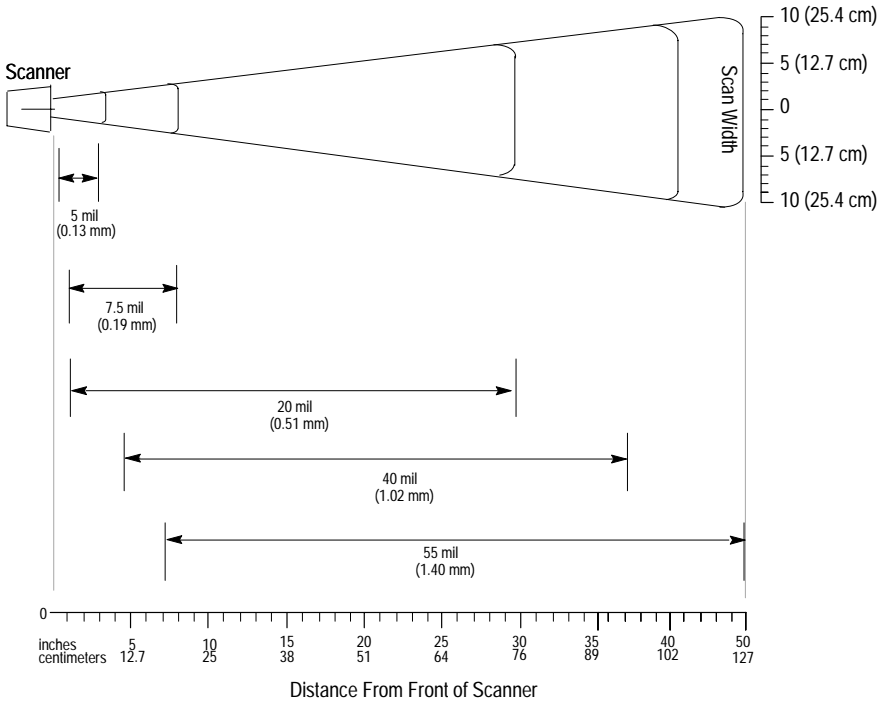

**Extended Range Scanner
Catalog No. 2755-HUG9**

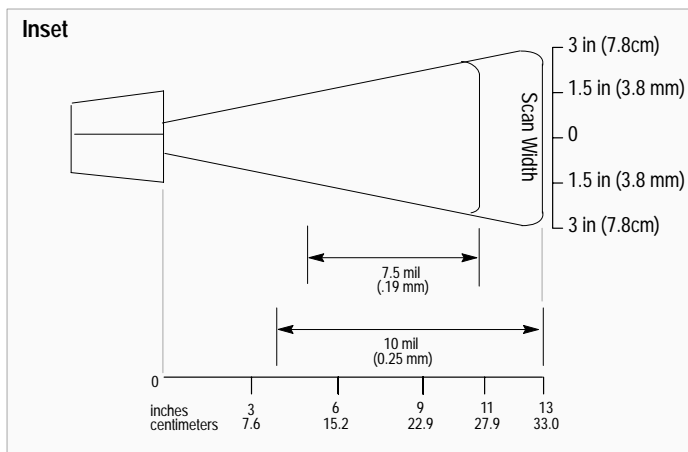
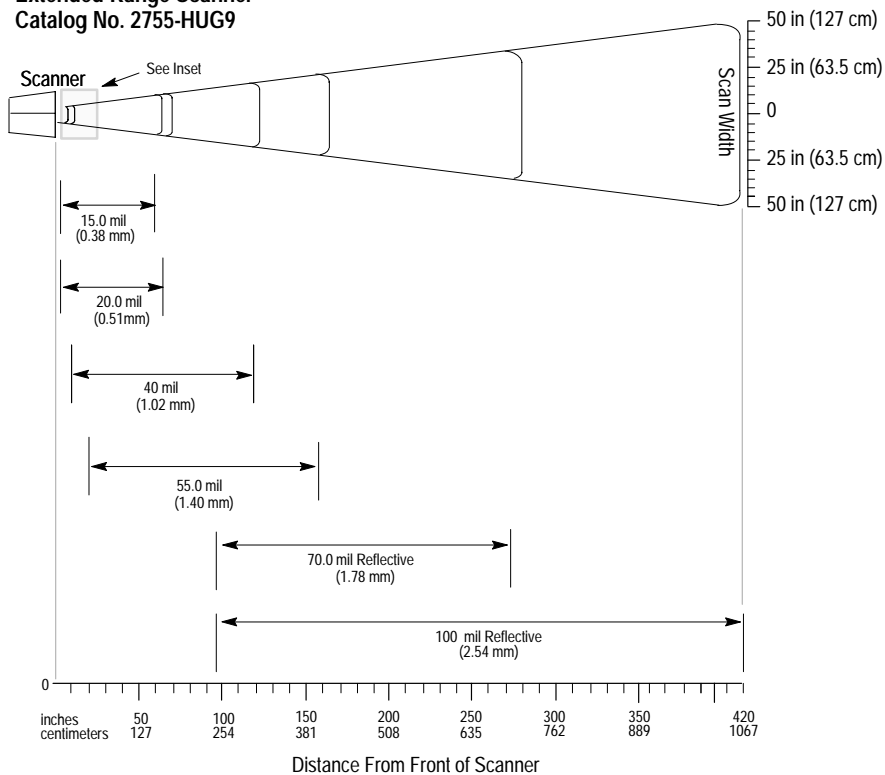

Accessories

The following accessories are available.

Scanner Cables – Connect scanner to A-B decoder. See page 2-2 for connections.

- 8 ft. / 2.44 meter
(Catalog No. 2755-HUC-GA1-08)
- 15 ft. / 4.57 meter
(Catalog No. 2755-HUC-GA1-15)
- 20 ft. / 6.1 meter
(Catalog No. 2755-HUC-GA1-20)

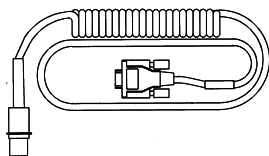

Adjustable Stands – Holds scanner at adjustable angles and heights for hand-free scanner operation.

- 5 to 18 inch (127 to 457 mm) height
(Catalog No. 2755-HFN-K1)
- 9 to 16 inch (229 to 406 mm) height
(Catalog No. 2755-HFN-K2)

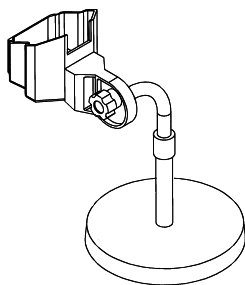

Multi-mount Stand – Rubber-coated, fixed mount holder for counter or wall mounting.

- (Catalog No. 2755-HFN-K3)

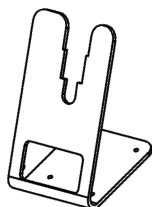

Protective Boot – Heavy canvas boot provides additional protection for the scanner.

- (Catalog No. 2755-HFN-H1)

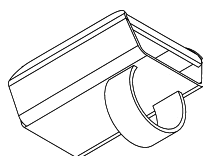

Connecting and Operating Scanner

This chapter describes how to connect and test the operation of the scanner. Sections include:

- compatible decoding devices
- installing / removing the interface cable
- connecting to a decoder
- operating scanner

Safety



ATTENTION: Caution - use of controls or adjustments or performance of procedures other than those specified herein may result in hazardous laser light exposure.

Compatible Decoders

The undecoded scanners are compatible with the following Allen-Bradley decoders:

- Bulletin 2708-DH5 Attended Workstations
- Multi-Purpose Bar Code WorkStation
(Catalog No. 2755-DH1)
- Single or Dual-Head Enhanced Bar Code Decoder
(Catalog No. 2755-DD1x, -DS1x)

Scanner Cable

The scanner cables connect to the bottom of the scanner handle. See page 1–8 for lengths available.

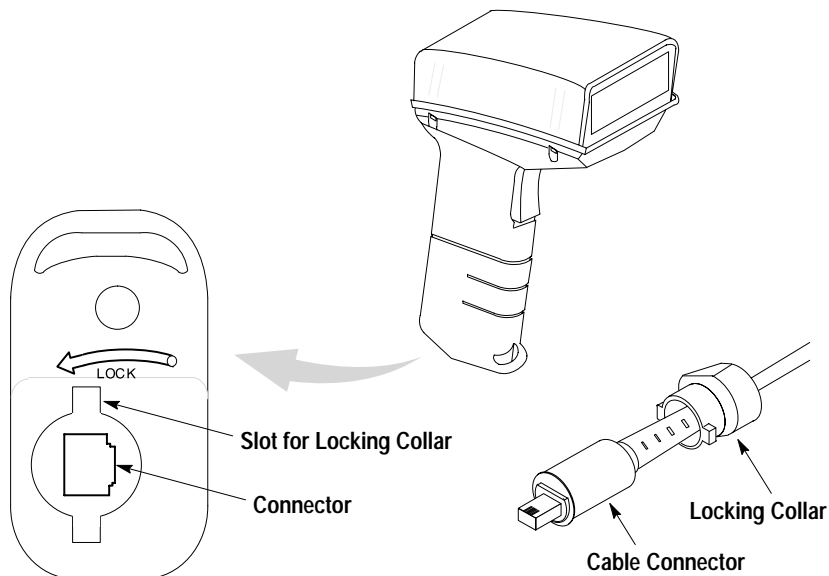

To attach the scanner cable to the scanner.

1. Pull back the locking collar from the connector.
2. Insert the cable connector into the scanner.
3. Align the tabs on the locking collar with the slots on the handle.
4. Push in and turn the locking collar counterclockwise to lock.
Connector is locked when flat edge of locking collar aligns with the flat edge of the scanner handle.

Remove a scanner cable by rotating the locking collar clockwise until the cable can be pulled out of the scanner.

Connecting the Scanner to a Decoder

The scanner interface cable connects to the input port of the decoder. The following table summarizes the cable and connectors required for each decoder.

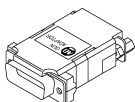

Note: A Gun Adapter (Catalog No. 2755-NC16) may be required to connect the scanner to some Series B decoders.

Decoder Type	2755-NC16 Series B Gun Adapter
Bulletin 2708-DH5 Attended WorkStations	No
Multi-Purpose Bar Code WorkStation (Catalog No. 2755-DH1)	No
Single or Dual-Head Enhanced Bar Code Decoder (Catalog No. 2755-DS1A, -DD1A)	Required



ATTENTION: Do not install or remove the scanner cables or connectors until the power to the scanner and decoder is turned off. Failure to follow this caution may result in damage to the scanner or decoder.



ATTENTION: Make sure you use the Series B Gun Adapter (Catalog No. 2755-NC16, Series B). If you are upgrading from an earlier version Allen-Bradley hand-held scanner (such as the 2755-G2 or -G3) which used the Series A gun adapter, you will need to purchase the series B gun adapter.

The 2755-NC16 Gun Adapter connects to the decoder input port as shown below for the Enhanced Decoder, the High Speed Decoder is similar.

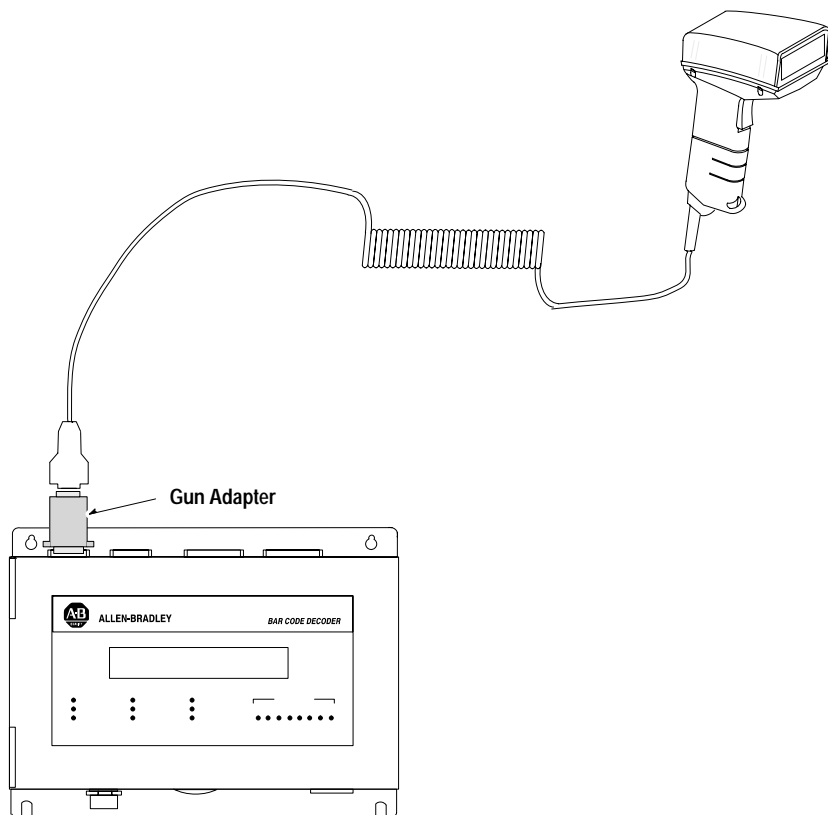

Operating the Scanner

1. Check your connections.

- Is the scanner cable securely attached?
- If connecting to a High Speed or Enhanced decoder, is the Gun Adapter present?
- Is power applied to the decoder?

2. Test the scanner

Aim the scanner at the work surface and press the trigger. You should see the red beam on the work surface, and the red LED on the back of the scanner should be on.

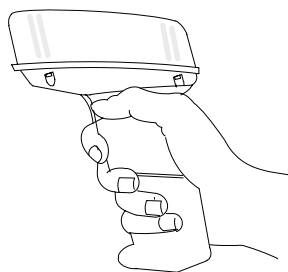

3. Scan a label.

Scan a bar code. Adjust the scanner position so that the scan beam is centered on the bar code and overlaps both sides. When the scanner has read a symbol:

- You will hear a beep from the decoder (if enabled).
- The green LED will turn on and remain on until the next scan.

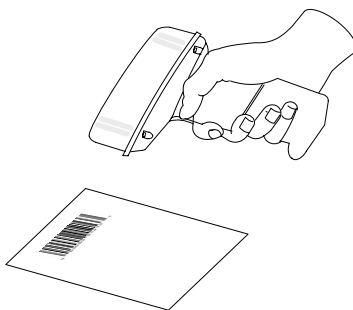

Spotter Beam

The Extended Range Scanner (Catalog No. 2755-HUG-9) has a two position trigger. The first detent turns on a spotter beam. Center the spotter beam over the center of the symbol or press the trigger all the way to start the scan beam.

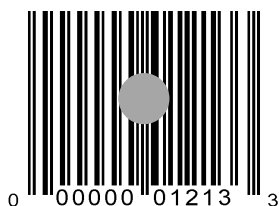

Correct



Incorrect

Automatic Shutoff

The scanner will automatically stop scanning after a bar code symbol has been read. If no symbol is decoded, the scanner will automatically stop after approximately 4 seconds. You must release and press the trigger again to resume scanning.

Audible Response

When scanning a bar code symbol, listen for a single short beep from the decoder. This beep indicates that the bar code has been successfully scanned. Some decoders cannot provide an audible response.

Note: You will not hear an audible response if you are using the scanner with Allen-Bradley unattended decoders (Catalog No. 2755-DS1x, -DD1x).

Operating Tips

Scan Symbols at an Angle

Do not hold the scanner directly perpendicular to the symbol being scanned. Hold the scanner at a slight angle.

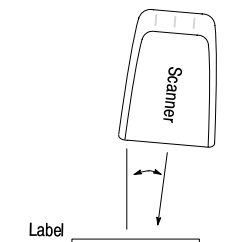

Scan the Entire Symbol

Hold the scanner so that the scan beam crosses the entire symbol.

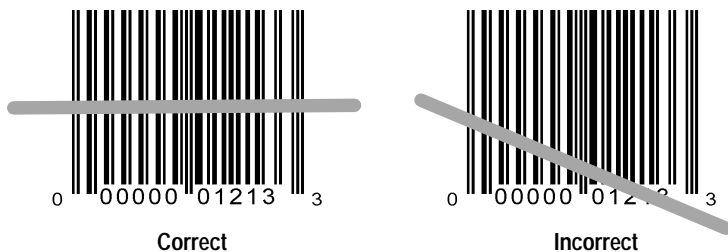

Also as general rule:

- the larger the symbol, the farther away you should hold the scanner.
- hold the scanner closer for symbols that have bars that are close together.

Troubleshooting and Maintenance

This chapter describes how to troubleshoot and maintain the scanner.

- troubleshooting chart
- cleaning the scan window
- Allen-Bradley Global Technical Support

Troubleshooting the Scanner

This section provides a list of the most common operating problems, the probable causes, and suggested corrective actions.

Problem	Probable Cause(s)	Corrective Action
No Scan Beam.	<ol style="list-style-type: none"> 1. Decoder not on. 2. Scan beam has timed out. 3. Defective scanner cable. 4. Defective scanner. 	<ol style="list-style-type: none"> 1. Verify that decoder is on. 2. Normal operation. Release trigger completely and scan again. 3. If possible, try another scanner cable. 4. If possible, try another scanner using the same connections. Contact Allen-Bradley Global Support (GTS).
Scan Beam Appears as a Dot Not a line	<ol style="list-style-type: none"> 1. Trigger on Extended Range Scanner is not fully pressed. 2. Defective scanner. 	<ol style="list-style-type: none"> 1. Extended Range Scanner has a 2 position trigger. The first position is for the spotter beam. Press the trigger to the next position for scanning. 2. Contact Allen-Bradley Global Technical Support.

Problem	Probable Cause(s)	Corrective Action
Scan Beam Present, Symbols Not Read	<ol style="list-style-type: none"> 1. Scanner not held at slight angle to symbol. 2. Scan beam not crossing entire symbol. 3. Decoder not programmed to read the type of bar code you are scanning. 4. Poor quality bar code symbols. 5. Loose cable connections. 6. Gun adapter not being used. 	<ol style="list-style-type: none"> 1. Hold scanner at an angle to the symbol. 2. Make sure scan beam crosses every bar or space on the symbol. 3. Make sure the decoder is configured for the type of bar code symbols you are scanning. 4. Use the symbols provided on the inside back cover for testing. 5. Check for loose cable connections. 6. If you are connecting the scanner to a High Speed or Enhanced decoder, you must use a Gun Adapter (Catalog No. 2755-NC16, Series B).

Cleaning the Scan Window

You may need to clean the window of the scanner. **Carefully** clean the window by first removing loose particles of dirt with clean air. Then use an *optical quality cloth* moistened with an *optical quality cleaning fluid* for **plastic lenses** and wipe the window in a single direction (don't wipe cloth back and forth across window). Do not leave streaks.



ATTENTION: Do not use abrasive materials such as disposable wipes and facial tissue. Do not use solvents like alcohol or acetone. These materials will damage the window or the finish on the scanner.



ATTENTION: The scanner has no serviceable parts. Do not open the housing of the scanner.

A-B Technical Support

If you should require assistance or need additional information on operating the scanner or Allen-Bradley decoder, contact Allen-Bradley Global Technical Services (GTS) at **(216) 646-6800**.

Specifications

Optical

Nominal Scan Rate	33 to 39 scans/second
Wavelength (nominal)	675 nm (Visible Red)
Maximum Roll (Skew)	
-HUG-4	$\pm 40^\circ$ from normal
-HUG-9	$\pm 10^\circ$ from normal
Maximum Pitch	
-HUG-4	$\pm 55^\circ$ from normal
-HUG-9	$\pm 45^\circ$ from normal
Depth of Field	See page 1-5
Print Contrast (Minimum)	50% absolute dark/light differential
Ambient Light Immunity	
Incandescent	350 ft. candles (3766 lux)
Fluorescent	450 ft. candles (4844 lux)
Sodium Vapor	350 ft. candles (3766 lux)
Mercury Vapor	450 ft. candles (4844 lux)

Electrical

Supply Voltage	4.8 to 14.0V DC
Current	110 mA at 5V DC (typical)

Mechanical

Dimensions	
Inches	5.0 (L) x 2.8 (W) x 6.3 (H)
Millimeters	127 (L) x 71 (W) x 160 (H)
Weight	8.5 oz (240 g)

Environmental

- Operating Temperature -22° to 122°F (-30° to 50°C)
- Storage Temperature -40° to 140°F (-40° to 60°C)
- Humidity 5% to 95% (noncondensing)
- Drop Test 6ft (1.8 meter) to concrete

Laser Certifications

- CDRH Class II laser product
- IEC 825 Class 2

Agency Certifications

- UL and CUL Listed
- CE marked for all applicable directives

Scanner Pinout Connections

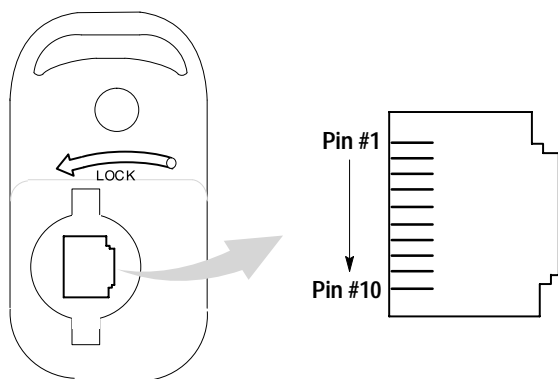

Pin	Signal Name	Function
1, 2	Power	Power input (4.8 to 14V DC).
3	Ground	Power and signal ground.
4	Enable	Signal input to power-up the scanner, turn on the laser, turn on scanning motor.
5	Start of Scan	Synchronizes decode logic with the scanner.
6	Trigger Switch	Connected to trigger switch. This output is grounded when the switch is pressed.
7	Decode LED	Controls green decode LED.
8	Digitized Bar Pattern	Output provides a series of pulses proportional to the widths of the bar code being scanned.
9	Motor Fail	Powers down laser if scan motor fails.
10	Not Used	

European Union Directive Compliance **CE**

If the Hand Held Undecoded Scanner is installed within the European Union or EEA regions and has the CE mark, the following regulations apply.

EMC Directive

Undecoded Hand-Held Bar Code Scanners

This apparatus is tested to meet EMC Directive 89/336/EEC and Low Voltage Directive 73/23/EEC using the following standards, in whole or in part:

- EN 55 022 : 1988
- EN 50 082-1 : 1992
 - IEC 801.2 : 1988
 - IEC 801.3 : 1988
 - IEC 801.4 : 1988
- EN 60 950 : 1992 + A1:1993 + A2:1993
- EN 60 825-1 : 1994

The product described is intended for use in an industrial environment.

Declarations of Conformity

A copy of the Declaration of Conformity is provided on the next page. This document declares that the scanners conform to the applicable directives.

DECLARATION OF CONFORMITY

This Declaration of Conformity is suitable to the European Standard EN 45014, "General criteria for supplier's declaration of conformity." The basis for the criteria has been found in international documentation, particularly in: ISO/IEC Guide 22, 1982, "Information on manufacturer's declaration of conformity with standards or other technical specifications."

Allen-Bradley liability under this declaration is limited to that set forth in the current Allen-Bradley publication 6500, Terms and Conditions of Sale as well as similar publications from Allen-Bradley affiliates doing business in the European Community.

Applied Council Directive(s):
Electromagnetic Compatability Directive (EMC) 89/336/EEC,
Low Voltage Directive 73/23/EEC,
and amending directives 91/263/EEC, 92/31/EEC, 93/68/EEC

We,			
Manufacturer:	Allen-Bradley Company, Inc. 1201 South 2nd Street Milwaukee, WI 53204 U.S.A.	Authorized Representative in the Community (and location of Responsible Person):	Allen-Bradley, subsidiary of Rockwell International GmbH Düsselberger Str. 15 D-42781 Haan, Germany

declare under our sole responsibility that the product(s) (name, type/model, batch/serial number):

Hand Held Barcode Scanners identified by the following Allen-Bradley Catalog Number: Bul 2755-HUG-4, -HUG-4X, -HUG-9, -HUG-9X, -HDG-4, -HDG-4X

to which this declaration relates is in conformity with the relevant provisions of the following standard(s) or other normative document(s):

EN 55 022 : 1988
EN 50 082-1 : 1992 (IEC 801.2 : 1988, IEC 801.3 : 1988, IEC 801.4 : 1988)
EN 60 950 : 1992 + A1 : 1993 + A2 : 1993
EN 60 825-1 : 1994

Test Information is maintained at:
Allen-Bradley Company, Inc.
1201 South Second Street
Milwaukee, WI 53204 USA

Year of CE Marking (Low Voltage Directive): 1996

We, the undersigned, hereby declare that the product(s) specified above conforms to the listed directive(s) and standard(s).

Manufacturer
Signature

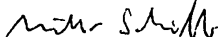

Authorized Representative in the Community through its Responsible Person
Signature

i.v. 

Full Name: Robert Gardiner
Position: Manager, Quality Engineering
Date: 11 Sept, 1996

Full Name: Viktor Schiffer
Position: Engineering Manager
Date: 11 Sept, 1996

Glossary

A

ASCII

American Standard Code for Information Interchange. A 7 bit-plus-parity code representing 128 letters, numerals, punctuation marks, and control characters. It is a standard data transmission code in the U.S.

B

Bit

Binary digit. One bit is the basic unit of binary information. Generally, eight consecutive bits compose one byte of data. The pattern of 0 and 1 values within the byte determines its meaning.

Byte

On an addressable boundary, eight adjacent binary digits (0 and 1) combined in a pattern to represent a specific character or numeric value. Bits are numbered from the right, 0 through 7, with bit 0 the low-order bit. One byte in memory can be used to store one ASCII character.

C

CDRH

Center for Devices and Radiological Health. A federal agency responsible for regulating laser product safety. This agency specifies various laser operation classes based on power output during operation.

Check Digit

A digit used to verify a correct symbol decode. The scanner inserts the decoded data into an arithmetic formula and checks that the resulting number matches the encoded check digit. Check digits are required for UPC but are optional for other symbologies. Using check digits decreases the chance of substitution errors when a symbol is decoded.

Codabar

A discrete self-checking code with a character set consisting of digits 0 to 9 and six additional characters: (- \$: / , +).

Code 128

A high density symbology which allows the controller to encode all 128 ASCII characters without adding extra symbol elements.

Code 3 of 9 (Code 39)

A versatile and widely used alphanumeric bar code symbology with a set of 43 character types, including all uppercase letters, numerals from 0 to 9, and 7 special characters (- . / + % \$ and space). The code name is derived from the fact that 3 of 9 elements representing a character are wide, while the remaining 6 are narrow.

Code 93

An industrial symbology compatible with Code 39 but offering a full character ASCII set and a higher coding density than Code 39.

Continuous Code

A bar code or symbol in which all spaces within the symbol are parts of characters. There are no intercharacter gaps in a continuous code. The absence of gaps allows for greater information density.

D

Decode

To recognize a bar code symbology (e.g., UPC/EAN) and then analyze the content of the specific bar code scanned.

Decode Algorithm

A decoding scheme that converts pulse widths into data representation of the letters or numbers encoded within a bar code symbol.

Discrete Code

A bar code or symbol in which the spaces between characters (intercharacter gaps) are not part of the code.

Discrete 2 of 5

A binary bar code symbology representing each character by a group of five bars, two of which are wide. The location of wide bars in the group determines which character is encoded; spaces are insignificant. Only numeric characters (0 to 9) and START/STOP characters may be encoded.

E

EAN

European Article Number. This European/International version of the UPC provides its own coding format and symbology standards. Element dimensions are specified metrically. EAN is used primarily in retail.

H

Host Computer

A computer that serves other terminals in a network, providing such services as computation, database access, supervisory programs, and network control.

I

IEC

International Electrotechnical Commission. This international agency regulates laser safety by specifying various laser operation classes based on power output during operation.

Intercharacter Gap

The space between two adjacent bar code characters in a discrete code.

Interleaved Bar Code

A bar code in which characters are paired together, using bars to represent the first character and the intervening spaces to represent the second.

Interleaved 2 of 5

A binary bar code symbology representing character pairs in groups of five bars and five interleaved spaces. Interleaving provides for greater information density. The location of wide elements (bar/spaces) within each group determines which characters are encoded. This continuous code type uses no intercharacter spaces. Only numeric (0 to 9) and START / STOP characters may be encoded.

L

Laser

An acronym for Light Amplification by Stimulated Emission of Radiation. The laser is an intense light source. Light from a laser is all the same frequency, unlike the output of an incandescent bulb. Laser light is typically coherent and has a high energy density.

Laser Diode

A gallium-arsenide semiconductor type of laser connected to a power source to generate a laser beam. This laser type is a compact source of coherent light.

P

Parameter

A variable that can have different values assigned to it.

Programming Mode

The state in which a scanner is configured for parameter values. See **SCANNING MODE**.

Q

Quiet Zone

A clear space, containing no dark marks, which precedes the start character of a bar code symbol and follows the stop character.

S

Scanner

An electronic device used to scan bar code symbols and produce a digitized pattern that corresponds to the bars and spaces of the symbol. Its three main components are:

1. Light source (laser or photoelectric cell) - illuminates a bar code.
2. Photodetector - registers the difference in reflected light (more light reflected from spaces).
3. Signal conditioning circuit - transforms optical detector output into a digitized bar pattern.

Scanning Mode

The scanner is energized, programmed, and ready to read a bar code.

Scanning Sequence

A method of programming or configuring parameters for a bar code reading system by scanning bar code menus.

Self Checking Code

A symbology that uses a checking algorithm to detect encoding errors within the characters of a bar code symbol.

Start / Stop Character

A pattern of bars and spaces that provides the scanner with start and stop reading instructions and scanning direction. The start and stop characters are normally to the left and right margins of a horizontal code.

Symbol

A scannable unit that encodes data within the conventions of a certain symbology, usually including start/stop characters, quiet zones, data characters, and check characters.

Symbology

The structural rules and conventions for representing data within a particular bar code type (e.g. UPC/EAN, Code 39).

U**UPC**

Universal Product Code. A relatively complex numeric symbology. Each character consists of two bars and two spaces, each of which can be any of four widths. The standard symbology for retail food packages in the United States.

A

Accessories

- Protective Boot, 1-8
- Scanner Cable, 1-8
- Stands, 1-8

Audience, Intended, P-1

B

Boot, Protective, 1-8

C

Cable, Scanner, 2-2

Certifications, A-2

Cleaning, 3-4

Contents, Manual, P-2

D

Decoders, 2-1

- Compatible, 2-1
- Connecting, 2-3
- Supported, 2-3

E

Electrical Specifications, A-1

Environmental Specifications, A-2

F

Features, 1-2

G

Global Technical Support, 3-4

Gun Adapter, 2-3

L

Label, Scanning, 2-5

Laser

- Certifications, A-2
- Warning Label, 1-4
- Warning Symbol, P-3

LEDs

- Good Read, 1-3
- Location, 1-2
- Red, 1-3

M

Mechanical Specifications, A-1

O

Operation, 2-5

Optical Specifications, A-1

P

Protective Boot, 1-8

Publication, Related, P-3

R

- Read Range
 - Extended Range Scanner, 1-7
 - Standard Scanner, 1-6
- Read Ranges, 1-5
- Related Publications, P-3

S

- Scanner
 - Cable, 1-8, 2-2
 - Cleaning, 3-4
 - Features, 1-2
 - Operating, 2-5
 - Pinout Connections, B-1
 - Testing, 2-5
 - Troubleshooting, 3-2
- Scanner , Read Ranges, 1-5
- Scanning
 - Labels, 2-5
 - Tips, 2-7
- Specifications
 - Electrical, A-1
 - Environmental, A-2
 - Mechanical, A-1
 - Optical, A-1
- Stands, Standard and Adjustable, 1-8
- Support, GTS, 3-4

T

- Technical Support, GTS, 3-4
- Telephone No., Technical Support, 3-4
- Testing, 2-5
- Troubleshooting, 3-2

W

- Warning
 - Laser Light, P-3
 - Safety Label, 1-4

TEST SYMBOLS



1 2 3 4 5

Code 128



1 2 3 4 5

Code 93



A 1 2 3 4 B

Codabar



A 1 2 3 4 B

Code 39

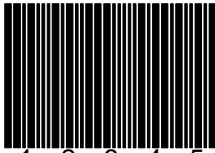

1 2 3 4 5

Discrete 2 of 5



1 2 3 4 5

EAN 128



1 2 3 4 5 6 7 8 9 10 19

EAN 13



1 2 3 4 5 6 7 0

EAN 8

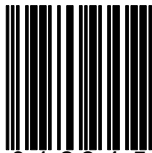

0 1 2 3 4 5

Interleaved 2 of 5



1 2 3 4 5 6 7 8 9 0 1 2

UPC A



0 1 2 3 4 5 6 5

UPC E



Allen-Bradley

Worldwide representation.



Argentina • Australia • Austria • Bahrain • Belgium • Brazil • Bulgaria • Canada • Chile • China, PRC • Colombia • Costa Rica • Croatia • Cyprus • Czech Republic • Denmark • Ecuador • Egypt • El Salvador • Finland • France • Germany • Greece • Guatemala • Honduras • Hong Kong • Hungary • Iceland • India • Indonesia • Ireland • Israel • Italy • Jamaica • Japan • Jordan • Korea • Kuwait • Lebanon • Malaysia • Mexico • Netherlands • New Zealand • Norway • Pakistan • Peru • Philippines • Poland • Portugal • Puerto Rico • Qatar • Romania • Russia-CIS • Saudi Arabia • Singapore • Slovakia • Slovenia • South Africa, Republic • Spain • Sweden • Switzerland • Taiwan • Thailand • Turkey • United Arab Emirates • United Kingdom • United States • Uruguay • Venezuela • Yugoslavia

Allen-Bradley Headquarters, 1201 South Second Street, Milwaukee, WI 53204 USA, Tel: (1) 414 382-2000 Fax: (1) 414 382-4444