



A Broadband IP Expert in Every Truck

TECH-X™ PLUS FIELD TESTER

Spirent's Tech-X Plus Field Tester ensures service providers worldwide can install and troubleshoot next-generation broadband xDSL, FTTx and IP services while increasing service efficiency with automated and integrated fault diagnostics.

HIGHLIGHTS

- Emulate an ADSL, ADSL 2, and ADSL 2+ modem with upstream/downstream and graphical results
- Analyse IPTV streams to determine your customer's Quality of Experience
- Verify high-speed internet service using Ping, TraceRoute, Web Browser and OAM loopbacks.
- Find faults with a resistive fault locator (RFL) and a 26kft (8km) time domain reflectometer (TDR)
- Pre-qualify pairs for xDSL services with spectrum and noise analysis, and insertion loss to 12MHz
- Quickly see faults or view results on a large graphical display

For true end-to-end testing, service providers can use Tech-X Plus to test from the customer's media gateway to the DSLAM and then on to the ATM/Ethernet backbone; and then to the Internet, voice, or video service provider.

Tech-X Plus' expert copper, DSL, and IP diagnostics eliminate the need for a technician to be expert at new technologies. Tech-X Plus diagnostics automatically indicate the source of the problem and in plain English suggest the next steps.

By using one of the numerous connection options with test automation, the field technician quickly gains access to central office support and network resources during installation or troubleshooting.

Thorough testing of the end-users' voice, video, and data service reduces the customer's wait between the service order initiation and service availability. In addition, if service interruptions occur, the resolution time is drastically reduced. With Tech-X Plus, service providers can confidently increase broadband IP service availability while attracting and retaining satisfied customers.

COMPREHENSIVE COPPER FAULT ANALYSIS

Using the Multimeter (DVOM) features in Tech-X Plus, technicians easily identify AC and DC faults shown by large screen results and help menus. Tests for voltage, current, capacitance (opens), resistance, and balance identify the presence of these faults. After faults are shown to exist, the Tech-X Plus' precise, long-range TDR finds the location of those faults with a simple push of a button. In addition, high-resistive faults can be found using the instrument's unmatched RFL feature.

DSL PRE-QUALIFICATION

The Tech-X Plus locates all types of faults. It is equipped with wideband noise and loss tests that provide qualitative testing and impairment diagnosis for pre-qualifying the loop before deployment of xDSL services. Furthermore, wideband Power Spectral Density (PSD) can be used to identify noise disturbers and is shown on a large graphical screen.

DSL AND IP SERVICE INSTALLATION

In addition to copper qualification measurements, Tech-X Plus performs complete DSL service testing. Using a combination of modem emulation, DSL expert diagnostics, and various ATM/IP tests such as Ping, TraceRoute and even a Web Browser, Tech-X Plus helps your technicians verify that your customer's service is working. Plain text and graphical results enable isolation of in-home wiring, local loop faults, noise disturbers, bad or missing DSLAM cards, and mis-configured port configurations.



Quick configuration and analysis

- LEDs for quick indication of pass/fail, alarms
- Test-specific diagrams for visual confirmation of test being performed
- Directional arrows and function keys for navigation



- Quick review of key configurations
- Most common next measurements
- Easy entry of dialers, IP addresses

KEY PRODUCT FEATURES

Automated Test Scripts

Tech-X Plus provides one-button test scripts tailored to service-specific Methods and Procedures (M&Ps). These scripts provide a quick indication that all required measurements have been made and that service levels have been met. As tests are performed, the user is automatically informed whether the results pass or fail pre-defined thresholds. These thresholds can be customized by a manager. This process standardizes testing and offers technicians the highest degree of confidence the service works properly and additional dispatches are not required.

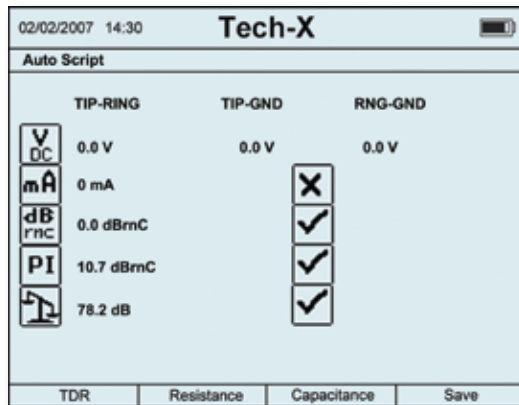

Copper qualification script

Data Storage

All test results can be stored on the Tech-X Plus using a timestamp, a unique name and other pertinent information. Field supervisors can automatically receive collected results that provide a real-time assessment of crew progress. If results do not pass thresholds, the supervisor can be immediately notified. These results also identify technicians who are not consistently following M&Ps or who may need additional training. Such trending information is also valuable for plant engineering and planning.

Expert Analysis

The Tech-X Plus employs Spirent's automated expert diagnostics to accelerate troubleshooting in the field. By pressing a single button, an automated test is performed, and its results are immediately analyzed and correlated to identify faults. The faults are prioritized according to the greatest impact on service. For field technicians, guesswork is removed from testing. Quick isolation and repair of faults is ensured.



Multiple test and access interfaces

APPLICATIONS

xDSL Modem Emulation

Tech-X Plus emulates the xTU-R, enabling field technicians to separate network issues from in-house problems. The instrument emulates the xTU-R (customer modem) and trains with the DSLAM in the central office or remote terminal. By training with the DSLAM, results such as upstream/downstream rates, noise margin and errors are provided. Graphical results such as bits/bin and noise/bin are easily viewable on a large screen.

The Tech-X has a single onboard modem that emulates ADSL, ADSL2, and ADSL2+. This removes the need for multiple plug-in modules to be carried by the field technician which can end up damaged or lost.

DSL Expert Diagnostics*

ADSL 2/2+ standards provide Management Information Bases (MIBs) for service technicians to obtain expert diagnostics on the source of low data rates. This can be done without interpreting hundreds of individual results. Using the DSL Expert Diagnostics option, a technician receives a report indicating disturbers such as bridged taps, missing micro filters, WB noise (e.g., T1, HDSL) and how they directly impact the data rate. Results are provided in plain text.

This option guides troubleshooting activities. The field technician avoids wasting time on problems that do not impact the data rate, thereby minimizing MTTR. The Tech-X Plus diagnostics option eliminates the need for each dispatched technician to be an expert at these new technologies. Fault isolation is quickly and reliably performed.

Tech-X	
02/02/2007 14:30	
DSL Expert Analysis	
In-Home Analysis	
Microfilter Needed:	No
Downstream Data Rate Reductions	
Crosstalk Disturbers:	1376 kbps
AM and NB Disturbers:	64 kbps
Bridged Taps:	1549 kbps
Loop Estimate	
Loop Length:	9600 feet
Number of Bridged Taps:	2
Bridged Tap Length:	517 feet, 1079 feet
Sync ATU-C	Save

DSL Expert Diagnostics

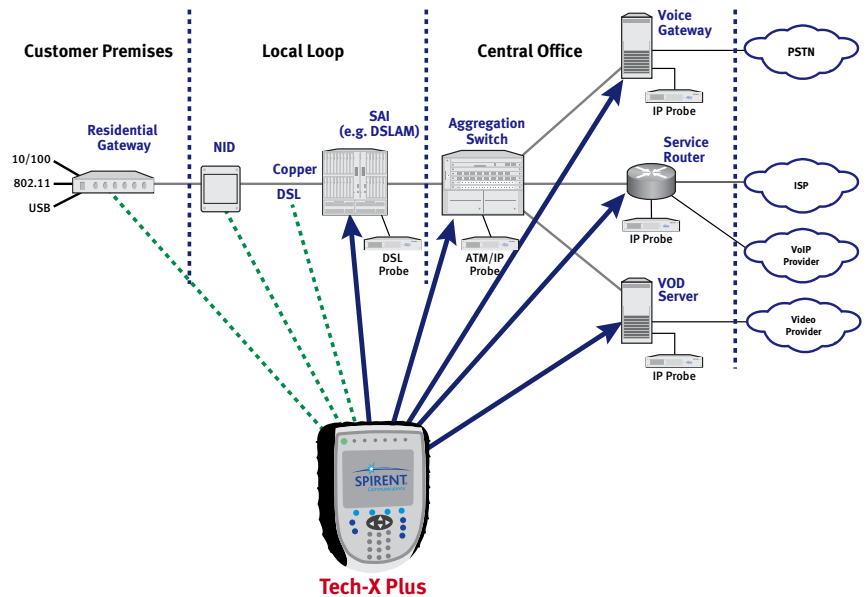

A single solution for broadband IP field testing

IP Video Testing

The Tech-X Plus provides field technicians with a comprehensive, yet easy to use tool for diagnosing problems with IPTV deployments. One button testing provides the user with a quick indication as to the Quality of Experience as received by the user. This measurement is a VMOS score, which is a numeric value between 1 and 5 that is used as a rating of the TV picture as seen by the customer. Should a more detailed analysis be required, measurements such as jitter, delay and packet loss can all be performed.

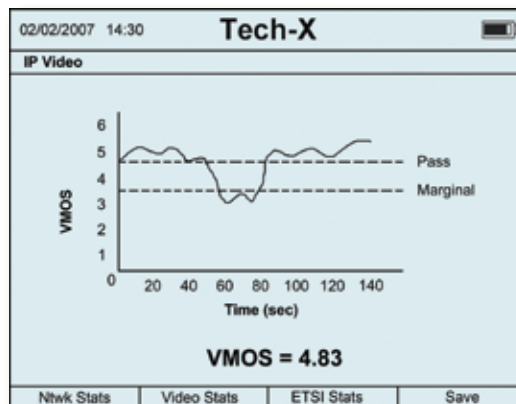

IP Video Testing

*Available for North American units only

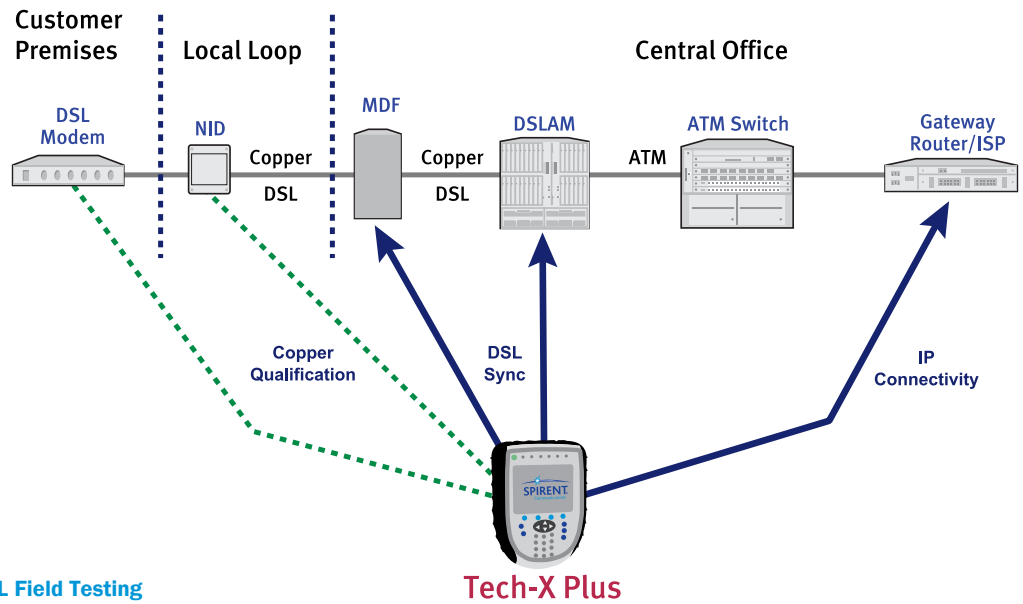

xDSL Field Testing

Tech-X Plus

IP/ATM Testing

Once the xDSL link has been activated, the customer’s data, voice, and video services must be verified with various IP and ATM measurements. The field technician should attempt to verify connectivity to the Internet service provider (ISP) using various IP measurements such as an IP ping. By using a URL in a ping or trace route test, the technician is assured the customer can reach the desired IP address and that the domain name server (DNS) works properly. Tests such as a TraceRoute identify where excessive delay is introduced or how far the customer’s traffic can traverse the network before a failure. By using Tech-X Plus features, the technician verifies without entering the customer’s home, thereby decreasing time at each job.

resistive balance, current and battery voltage. Furthermore, the Tech-X Plus identifies faults such as opens, shorts, battery crosses, bad splices, and more.

Web Browser

The Web browsing feature further enhances the field technician’s ability to verify DNS operation and can also be used to provide a fast, visual confirmation to the customer that their service is fully operational and thereby eliminates the need for the field technician’s laptop to be carried in the field.

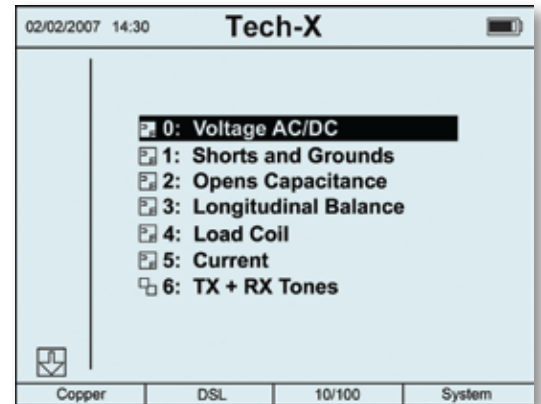

Multimeter

KEY COPPER FEATURES

Multimeter (DVOM)

Voltage, current, resistance, and capacitance (opens) measurements can be performed to determine loop length, capacitive and

Time Domain Reflectometer

Tech-X Plus provides an extremely high-precision TDR so that load coils, bridged taps and faults can be found with ease. Fully functional and simple to operate, this TDR reduces time spent trying to locate the fault. Other TDR highlights include:

- Large graphical display for easy fault finding and analysis
- Isolation of faults 26,000ft (8km) away
- Auto detection of faults such as opens, short, bidgetaps, and more

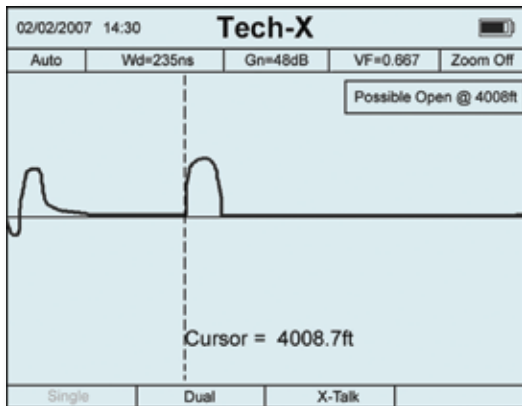

Time Domain Reflectometer

Resistive Fault Locator (RFL)

RFL analysis is used for high-resistance faults that normally cannot be found by a TDR. Loop resistance, insulation resistance, and accurate location of ground and battery faults are easily found with a touch of a button.

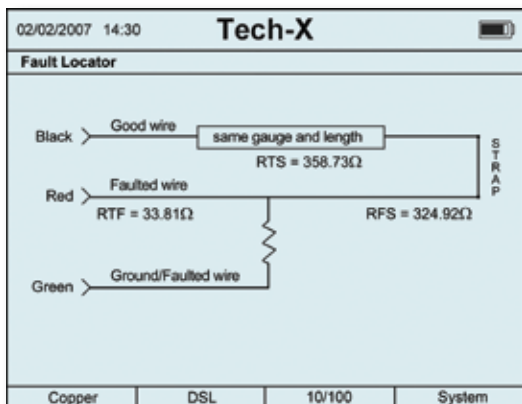

Resistive Fault Locator

Wideband Services Testing

DSL and other digital services require the loop be pre-qualified before service is installed. The Tech-X Plus performs wideband (WB) insertion loss up to 12MHz for comprehensive loss characterization of the copper pair. In addition, the Power Spectral Density feature automatically identifies noise disturbers of DSL service such as HDSL, T1 and others. These higher bandwidths are important for qualifying services such as ADSL 2+, VDSL and VDSL2, which far exceed the 1.1MHz spectrum covered by traditional ADSL testers. Graphical and numerical analyses of noise in WB frequencies quickly isolate and resolve trouble associated with intermittent modem sync and/or data rate. Lastly, a WB longitudinal balance measurement is available

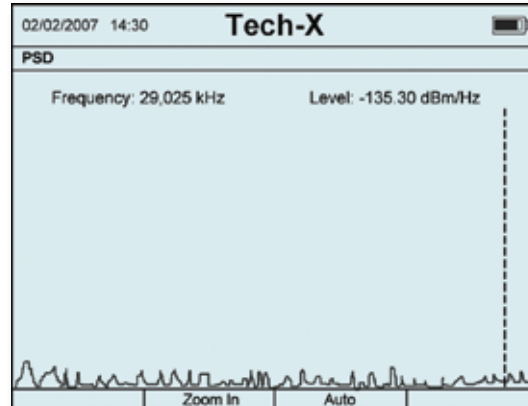

30MHz Spectral Analysis

for stressing the copper pair at DSL frequencies to verify the noise immunity of the pair.

Installation of Voice Services

Various features such as drawing dial-tone, C-Message noise, VF loss and DVOM tests enable field technicians to ensure the voice (e.g. POTS) service meets service criteria after the copper pair has been conditioned. Various test numbers such as quiet termination, milliwatt and “drop battery” can be stored in the unit for automatic dialling before the measurement is made. Using the built-in speaker, the field technician can listen to various tones being received.

In-Band Controllable Remote Unit

The Tech-X Plus has an optional remote unit, simplifying field testing of wideband insertion loss measurements. Once placed on the correct pair, the remote unit reduces truck rolls and time consumed waiting for other technicians to complete a job. This unit can be remotely configured via the line under test and DTMF tones to perform various measurements. For example, the remote unit can be instructed to send wideband tones for the Tech-X Plus to receive. Lastly, once the trouble has been fixed, the field technician remotely configures a through mode and immediately places the customer back in service.

The Remote Unit also operates as a far end strap when running the RFL test. The Tech-X Plus will automatically command the Remote Unit to open and short the pair as necessary in order to obtain the required measurements. This cuts down on the number of journeys that must be made to the far end of the pair which are normally required when using a manual strap.

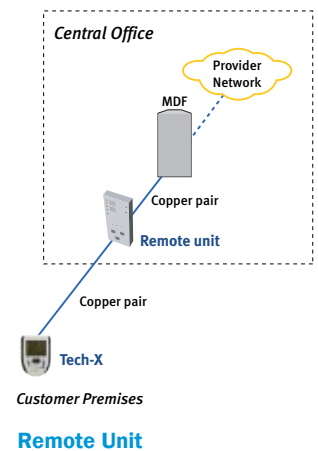

Remote Unit

xDSL Specifications	
Line Modulations	<ul style="list-style-type: none"> ■ ANSI T1.413 Issue 2 ■ ADSL G.DMT (G.992.1/2 Annex A) ■ ADSL 2 (G.992.3/4 Annex A) ■ ADSL 2+ (G.992.5 Annex A) ■ Reach-Extended ADSL 2 (G.992.3 Annex L) ■ G.Lite (G.992.2)
Emulations	<ul style="list-style-type: none"> ■ xTU-R
IP Encapsulations	<ul style="list-style-type: none"> ■ PPPoE (RFC 2516) ■ PPPoA/LLC (RFC 2364) ■ PPPoA/VC-Mux (RFC 2364) ■ Bridged Ethernet
IP Connectivity Tests	<ul style="list-style-type: none"> ■ ICMP Ping ■ TraceRoute ■ Name Server Lookup ■ ISP Authentication
ATM Connectivity Tests	<ul style="list-style-type: none"> ■ ATM F4 OAM Loopback ■ ATM F5 OAM Loopback
Line Results	<ul style="list-style-type: none"> ■ Data Mode ■ Line Format ■ DSLAM Vendor ■ Modem State ■ Modem Error Condition ■ Output Power
Up/Downstream Results	<ul style="list-style-type: none"> ■ Line Rate Actual ■ Line Rate Max ■ Line Rate Capacity ■ Fast Bit Rate ■ Interleaved Bit Rate ■ Noise margin (dB) ■ Attenuation (dB) ■ Link Uptime ■ Correctable FEC Errors ■ Uncorrectable CRC Errors ■ Interleave path HEC Errors ■ Loss of Signal ■ Severely Errored Seconds ■ Errored Seconds ■ Severe Errors ■ Loss (dBm) ■ Power ■ Signal Attenuation (dBm/Hz) ■ Received Blocks ■ Transmitted Blocks ■ Corrected Blocks ■ Uncorrected Blocks ■ Interleaved Delay ■ Interleaved Depth ■ HEC Error Count ■ Total HEC Count
10/100 Specifications	
IP Results	<ul style="list-style-type: none"> ■ IP address ■ Gateway address ■ DNS address

IP Video Specifications	
Test Parameters	
Tests	Channel quality, Channel change time
Channel Guides	Up to 4
Encapsulation	MPEG2 (MPEG2TS) over UDP, MPEG2 (MPEG2TS) over RTP over UDP, H.264 (MPEG2TS) over RTP over UDP.
Codec	UDP, MPEG2, H.264, MPEG 1 Layer II audio, MPEG2 audio, DOLBY AC-3 audio
Video Stream Metrics	
Video Stream Metrics	<ul style="list-style-type: none"> ■ I,B, P Frames Recieved ■ I, B, P Frames Lost ■ I, B, P Frame Discards ■ I, B, P Frames Errored ■ FEC Effectiveness ■ Opt FEC Block Size ■ Opt FEC Correctable Pkts ■ Ratio of Peak to Mean Bandwidth
Video Stream Description	<ul style="list-style-type: none"> ■ Stream Type ■ Image Size ■ Image Type ■ GoP Type ■ GoP Length Avg ■ Codec Robustness ■ Content Sensitivity ■ Receive Rate ■ Peak Receive Rate
Perceptual Quality Metrics	
Perceptual Quality Metrics	<ul style="list-style-type: none"> ■ Video MOS (text and graph) ■ Audio MOS ■ Audio/Video MOS ■ Video Service Transmission Quality (VSTQ) ■ VSPQ ■ Gap VSPQ ■ Burst VSPQ ■ VSMQ ■ Peak SNR
Transport Metrics	
Network Stats	<ul style="list-style-type: none"> ■ Packets (Received, Lost, Discards) ■ Frame Rate ■ Packets OOS ■ Burst MIU Lost ■ Burst Duration Avg ■ Gap MIU Lost ■ Gap Duration Avg ■ Channel (Change, Join, Leave)
TR101 MPEG Stats	<ul style="list-style-type: none"> ■ Sync Loss ■ Sync Byte Error ■ Continuity Error ■ Transport Header Error ■ PCR Repetition Error ■ PCR Discontinuity Error ■ PTS Error
Jitter/Delay Stats	<ul style="list-style-type: none"> ■ MAPDV Avg ■ PPDV ■ Delay (Max & Avg) ■ Jitter (Max & Avg)
Expert Degradation Analysis	
<ul style="list-style-type: none"> ■ Network Packet Loss ■ Jitter Buffer Discard ■ Video Codec Type ■ Delay 	

Copper Specifications

	Range	Resolution	Accuracy	Additional Information
DC Voltage	0 to $\pm 5V$ $\pm 5V$ to 300V	0.2V 0.1V	$\pm 2\% \pm 1$ digit $\pm 2\% \pm 1$ digit	Impedance: 100 k Ω
AC Voltage	0 to 5V 5 to 250V	0.1V 0.2V	$\pm 2\% \pm 1$ digit $\pm 2\% \pm 1$ digit	Impedance: 100 k Ω
Resistance	0 - 2 k Ω 2 - 20 k Ω 20 - 200 k Ω 200 k - 2 M Ω 2 M - 20 M Ω	1 Ω 10 Ω 100 Ω 1 k Ω 10 k Ω	$\pm 2\% \pm 1\Omega$ $\pm 2\% \pm 10\Omega$ $\pm 2\% \pm 100\Omega$ $\pm 2\% \pm 1$ k Ω $\pm 2\% \pm 10$ k Ω	
Insulation Resistance	10 to 100 k Ω 100 k Ω to 1 M Ω 1 M Ω to 10 M Ω 10 M Ω to 100 M Ω 100 M Ω to 2 G Ω	100 Ω 1 k Ω 10 k Ω 100 k Ω 1 M Ω	$\pm 2\%$ $\pm 2\%$ $\pm 2\%$ $\pm 2\%$ $\pm 5\%$	Voltages: 30, 95, 500V
Loop Resistance	0 - 10 k Ω	1 Ω	$\pm 2\% \pm 1\Omega$	
Open/Capacitance Meter	0 to 2000 nF	0.1 nF	$\pm 2\% \pm 1$ digit	
Loop Current	0 to 150 mA	1 mA	2% ± 1 digit	Load: 430 Ω
Noise Metallic	0 to 90 dBmC	1 dBmC	± 2 dBmC	Filter: C weighted
Noise Balance	90 dBmC	1 dB	± 2 dB	Filter: C weighted
VF Longitudinal Balance	100 Hz to 4 kHz 0 to 90 dB	0.1 dB	± 1.0 dB	
WB Longitudinal Balance	10 kHz to 12 MHz 0 to 50 dB	0.1 dB	± 5.0 dB	
VF Insertion Loss	100 Hz - 4 kHz 0 to 90 dB	0.1 dB	± 1.0 dB	Output Level: 0 dBm from remote device Impedance: 100 Ω
Wideband Insertion Loss	10 kHz to 12 MHz 0 to 90 dB	0.1 dB	± 1.0 dB	Output Level: 0 dBm from remote device Impedance: 100 Ω or 135 Ω
PI Noise Balance	0 to 90 dB	0.1 dBm	± 2.0 dB	C-message, Psophmetric, and D filter support
Power Spectral Density (2.5 MHz test)	0 to -140 dBm/Hz 10 kHz to 2.5 MHz	0.1 dBm 4.8 kHz	± 1 dBm/Hz ± 1.0 dBm	Impedance: 100 Ω , 135 Ω or Hi-Z Resolution specs are with zoom enabled
Power Spectral Density (12 MHz test)	0 to -140 dBm/Hz 10 kHz to 8 MHz 8 to 12 MHz	0.1 dBm 5 kHz 5 kHz	± 1.0 dBm ± 1 dBm/Hz ± 2 dBm/Hz	Impedance: 100 Ω , 135 Ω or Hi-Z Resolution specs are with zoom enabled
Time Domain Reflectometry (TDR)	300ft / 100m 1,300ft / 400m 3,000ft / 1km 6,500ft / 2km 13,000ft / 4km 26,000ft / 8km	0.5ft / 0.15m 1.7ft / 0.5m 4ft / 1.3m 8ft / 2.6m 17ft / 5.2m 34ft / 10.4m	$\pm 0.5\%$ of range	Vertical Sensitivity: 90 dB in steps of 6 dB Resolution specs are with zoom enabled
Resistance Fault Locator (RFL)	Location Range: 0 to 39,000ft / 12km Resistance fault range: 0 to 20 M Ω		3-wire: $\pm 0.2\%$ 4-wire: $\pm 0.2\%$	
Remote Device				Open Pair Short Pair In-service/Through mode Send tones (800 Hz to 2.5 MHz)
Wideband Noise	30 dBm to 90 dBm	0.1 dBm	± 1 dBm	E Filter Impedance: 135 Ω F Filter Impedance: 135 Ω G Filter Impedance: 100 Ω
Impulse Noise	E Filter - 30 - 110 dBm F Filter - 40 - 110 dBm F Filter - 40 - 110 dBm	± 0.1 dB ± 0.1 dB ± 0.1 dB	± 0.1 dB ± 0.1 dB ± 0.1 dB	Impedance: 135 Ω Impedance: 135 Ω Impedance: 100 Ω Time duration up to 24 hours Maximum of 8 noise events recorded per second

TECH-X PLUS FIELD TESTER

General Specifications

Physical Characteristics

Dimensions (H x W x D)	Tech-X Plus 2.95 in. x 6.06 in. x 8.66 in., 75 mm x 155 mm x 220 mm Remote Unit 10.0 in. x 3.74 in. x 1.57 in., 255 mm x 95 mm x 40 mm
Weight	Tech-X Plus 3.3 lb., 1.49 kg. Remote Unit 1.58 lb., 0.72 kg.
Display	Transflective LCD with backlight and adjustable contrast 320x240 pixels (1/4 VGA)
Case Material	FR ABS Polycarbonate
LED Indicators	Sync, Copper, Data, Errors, Alarms, Charge
Communications Interfaces	USB 2.0 10/100 Base-T, 3.5 mm headset jack
Test Interfaces	10/100Base-T (x2) 4 mm (x5)

Power Specifications

AC Operations	External AC adaptor/charger NOTE: Adaptor will charge battery while Tech-X Plus is in use.
Battery Type	LiON rechargeable
Battery Life	Tech-X Plus 8-10 hours, depending on use Remote Unit 7-24, depending on use
Battery Recharge Time	Tech-X Plus 3-4 hours Remote Unit 12 hours

Environmental Requirements

Operating Temperature	-10°C to 50°C (14°F to 122°F)
Storage Temperature	-32°C to 70°C (-25°F to 158°F)
Humidity Tolerance	0 to 93% RH at +40°C (104°F)
Bump	IEC 68-2-29
Drop	IEC 68-2-32
Vibration	IEC 68-2-6
Shock	IEC 68-2-27
Water/Dust Ingress	IP52

Ordering Information

Model

Tech-X Plus – Combo copper/ADSL2 tester (T4200-X-X)	Incl. DVOM, opens, load coil, balance, VF TIMS, current, noise, and ADSL/ADSL2+ (ATU-R) Emulation
--	---

Copper Options

Multimeter (DVOM)/Voiceband Option	Incl. DVOM, opens, load coil, balance, VF TIMS, noise, etc.
TDR Option	26,000ft/8km Time Domain Reflectometer
RFL Option	Resistive Fault Location
PSD/Wideband TIMS Option	WB TIMS, PSD, WB Longitudinal Balance up to 12MHz.

xDSL Options

ADSL 2/2+ (ATU-R) Basic Option	ADSL/ADSL2/ADSL2+ (ATU-R) Emulation
DSL Expert Diagnostics Option	Automatic loop and in-house fault analysis and data rate impact
IP/ATM Analysis Option	IP Ping, Trace route, ATM loopbacks, etc.

IP Options

Basic IP Option	Basic IP Option; IP Ping, Trace route, DHCP/Static addressing
Web Browser Option	Capability for viewing web pages
IP Video Option	IPTV statistics and analysis

NOTE: All units are shipped standard with a carrying case, charger, leads, batteries, and an instruction manual. Additional cables and a large carrying case can be ordered as desired.

SPIRENT GLOBAL SERVICES

Spirent Global Services provides a variety of professional services, support services and education services – all focused on helping customers meet their complex testing and service assurance requirements. For more information, visit the Global Services Web site at www.spirent.com/gs or contact your Spirent sales representative.



Spirent Communications
15200 Omega Drive
Rockville, MD 20850-3240
USA

SALES AND INFORMATION
sales-spirent@spirent.com
www.spirent.com

Americas
T: +1 301.590.3600
F: +1 301.590.3698

Europe, Middle East, Africa
T: +33 1 6137.2250

Asia Pacific
T: +852 2511.3822