



**Small, simple, reliable – the Mini Line
CLV503 / CLV505 / ICR803**

The small giants amongst stationary bar code scanners

The Mini Line: CLV503, CLV505, ICR803

Contents

The Mini Line: CLV503, CLV505, ICR803	2
Typical industries and applications	4
The devices of the Mini Line	5
Device features	6
Product selection guide	7
Technical data	8
Readable code types and test codes	9
Dimensional drawings and reading field diagrams CLV503 / CLV505	10
Dimensional drawings and reading field diagrams ICR803	11
Ordering information devices and power supply	12
Accessories	13
Configuration	14



Every millimetre counts when space is limited.

Nevertheless, it is essential that the codes are reliably identified – and SICK offers products with its familiar dependability.

Mini Line devices are hardly bigger than a USB plug and are easy to install in the tightest of spaces.

Impressive qualities: small, easy and reliable – the Mini Line.

Typical industries and applications

The devices of the Mini Line are ideal when the need for reliable code reading is high but the space available is limited.

Kiosk

- Access control, e.g.
 - Car parks
 - Airports
 - Ticket terminals
 - Swimming pools/trade fairs/ events
- Information terminals
- Vending/recycling machines
- Automatic lottery machines



Car park entrance



Ticket machine

Pharmaceuticals

- Clinical analyses

Electronics industry

- Circuit board identification



Access control at trade fair



Access control at station

Automotive

- Inspection machines

Robotics

- Mounted on robot arms, e.g. in data storage centres



Bar codes on test tubes

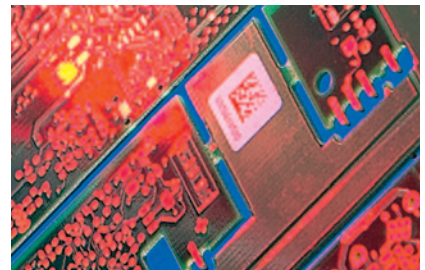

Data Matrix codes on circuit boards

Your benefits:

- Small size
- Low weight
- Reliable reading even with poorly printed codes
- Simple commissioning

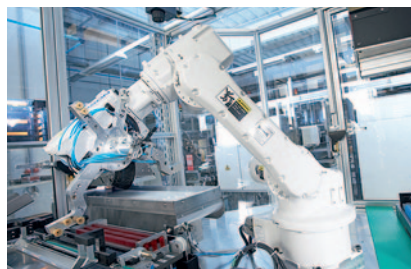

Robotics

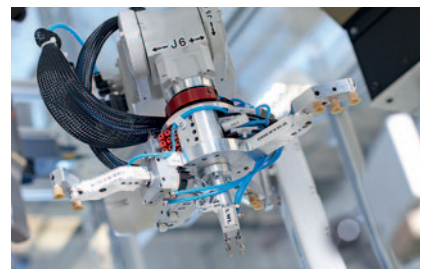

Mounted on robot arms

The devices of the Mini Line



CLV503 / CLV505

CLV503 and CLV505 devices use **laser technology** (line or grid scanners).

They scan the barcode to be identified for light and dark bars. The reflected light is received by the laser scanner, whereby the light from the black bars is weaker than that from the white spaces. The signal received is digitized and then decoded.

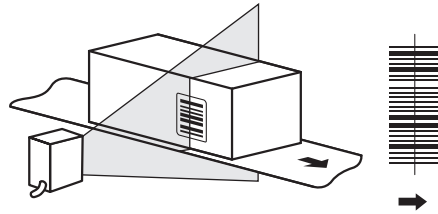

Allocation of the scanning line(s) for the bar code and conveyor system



ICR803

ICR803 devices use **camera technology**.

They record an image of the object and search through this with image processing algorithms for 1D or 2D codes, which are then decoded. The codes can be identified with one device and omni-directionally (360°). Image processing also permits the identification of OCR-A and OCR-B fonts.

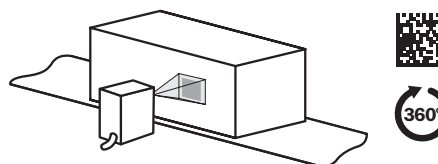

Omnidirectional code reading

Device features



Code reading

While the target codes must be **aligned** for the CLV503/CKV505, the ICR803 reads **omnidirectionally**, i.e. in any orientation.

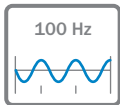

Scanning frequency

The CLV503 has a scanning frequency of 100 Hz. With its **rotating mirror wheel**, the CLV505 achieves a scanning frequency of 1,000 Hz and is thus also suitable for higher transport speeds of up to 5 m/s*).

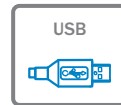
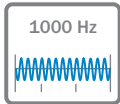

Electrical connection

The devices of the Mini Line are available with pre-assembled **USB cables**, while the ICR803 is also available with an **RS 232 cable**. If, in the case of the CLV503/CLV505, the RS 232 interface is selected, variants are available with cables and **open wire ends**.

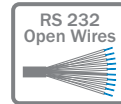

Image processing

Thanks to **camera technology**, the ICR803 can capture and transmit images of objects with its WVGA chip.























Control elements of CLV503



Control elements of CLV505

*) Application-dependent

Product selection guide

Device feature	CLV503	CLV505	ICR803
Readable code types (see also page 9)	 	 	  
OCR	-	-	
Code reading			
Scanning frequency			-
Electrical connections	 	 	 
Image processing	-	-	
Technical data	<ul style="list-style-type: none"> ● From page 8 		
Readable code types/test codes	<ul style="list-style-type: none"> ● From page 9 		
Dimensional drawings and reading field diagrams	<ul style="list-style-type: none"> ● From page 10 	<ul style="list-style-type: none"> ● From page 10 	<ul style="list-style-type: none"> ● From page 11
Ordering information	<ul style="list-style-type: none"> ● From page 12 		
Accessories	<ul style="list-style-type: none"> ● From page 13 		



USB and open wire ends for CLV503/CLV505



Compact ICR803 housing - no moving parts

Technical data



	CLV503	CLV505	ICR803-A/-B
Scanner design	1D Code Reader		2D Image Code Reader
Light source			
LED illumination	-		Visible red light (630 nm)
LED aiming line	-		Visible green light (530 nm)
Laser diode (wavelength)	Visible red light (650 nm)		-
Laser class of device ¹⁾	Class 2		-
MTTF ²⁾ of laser diode	10,000 h		-
Immunity to ambient light	2,000 lx		Max. 100,000 lx
Resolution	0.15 mm to 1.0 mm		ICR803-A: 0.19 mm (1D); 0.21 mm (2D) ICR803-B: 0.33 mm (1D); 0.38 mm (2D)
Usable aperture	Max. 44°	Max. 40°	-
Scanning /decoder frequency	100 Hz	1,000 Hz	-
Bar code print contrast (PCS)	90%; min. 45 %		-
Acoustic indicators ³⁾	Beeper (buzzer)		Beeper
Clock reading pulse	Digital input/command		Manual trigger, command or Presentation Mode, hardware trigger via CDB405
Data interfaces	USB keyboard wedge, USB serial, RS 232		USB keyboard wedge, USB serial, RS 232 TTL
Digital switching inputs	1 x input for clock reading pulse		-
Digital switching outputs	1 x GoodRead, 1 x NoRead		-
Electrical connection	1.5 m cable with USB or open wire ends		RJ45 socket: separate RJ45 cable to USB or 9-pin D Sub for RS 232
Operating voltage	5 V DC ± 10 %		
Power consumption	Typ. 85 mA, max. 150 mA	Typ. 205 mA, max. 500 mA	Typ. 350 mA
Weight	18.5 g without cable	30 g without cable	37 g without cable
Dimensions	30 mm x 43.3 mm x 20 mm	29 mm x 34.5 mm x 17 mm	49 mm x 40 mm x 25 mm
Enclosure rating	IP 43	IP 54	-
Laser protection	JIS-C-6802 class 2, IEC 60825-1 class 2, FDA CDRH class II		-
EMC testing	Emission of interference acc. to EN 61000-6-3:2007-01; immunity to interference acc. to EN 61000-6-1:2007-01 ⁴⁾	Emission of interference acc. to EN 61000-6-3:2007-01; immunity to interference acc. to EN 61000-6-2:2007-01 ⁵⁾	Emission of interference acc. to EN 55022:1998/A1:2000/A2:2003 Class A ITE; immunity to interference acc. to EN 55024: 1998/A1:2001/A2:2003 ITE
Product complies with	CE, FCC ⁶⁾ , VCCI, RoHs		CE, FCC ⁶⁾ , RoHs
Operating temperature	-10 to 45 °C	0 to 45 °C	0 to 50 °C
Relative air humidity	20 to 85 %, non-condensing	5 to 90 %, non-condensing	5 to 95 %, non-condensing

¹⁾ According to IEC 60825-1 and EN 60825-1, see warning sign on device for publication date; ²⁾ MTTF = Mean Time To Failure; ³⁾ Can be deactivated;

⁴⁾ CLV503-0110: Protection from ESD is required by either grounded or ESD safe mounting. The USB cable length shall not exceed 3 m; CLV503-0000: Device must either be mounted on an isolated support or be protected from ESD; ⁵⁾ Safe mounting with ESD; ⁶⁾ FCC = Federal Communications Commission

Readable code types and test codes

Description	CLV503	CLV505	ICR803
1D codes, linear			
Chinese Post	•	•	•
Codabar	•	•	•
Codablock			•
Code 11	•	•	
Code 32 PARAF			•
Code 39	•	•	•
Code 93	•	•	•
Code 128	•	•	•
GS1 Databar-14	•	•	•
GS1 Databar Expanded	•	•	•
GS1 Databar Limited	•	•	•
GS1 Databar Truncated	•	•	•
IATA	•	•	•
Industrial 2 of 5	•	•	•
Interleaved 2 of 5	•	•	•
ISBN-ISMN-ISSN	•	•	•
JAN/UPC/EAN	•	•	•
Korean Postal Authority code	•	•	•
Matrix 2 of 5	•	•	•
MSI-Plessey/UK-Plessey	•	•	•
Postcode			•
S-Code	•	•	
Telepen	•	•	•
Tri-Optic	•	•	
1D codes, stacked			
GS1 Databar-14 Stacked	•	•	•
GS1 Databar Expanded Stacked	•	•	•
GS1 Databar Stacked	•	•	•
GS1 Databar with Composite A/B	•	•	
MicroPDF417	•	•	•
PDF417	•	•	•
2D codes			
Aztec			•
Data Matrix			•
Maxicode			•
QR-Code			•
OCR			
OCR-A, OCR-B			•
Image capture			
BMP, JPEG, TIFF			•



Code 128



Interleaved 2 of 5



EAN 13



PDF417



Data Matrix



QR-Code

Dimensional drawings and reading field diagrams CLV503 / CLV505

Dimensional drawing CLV503

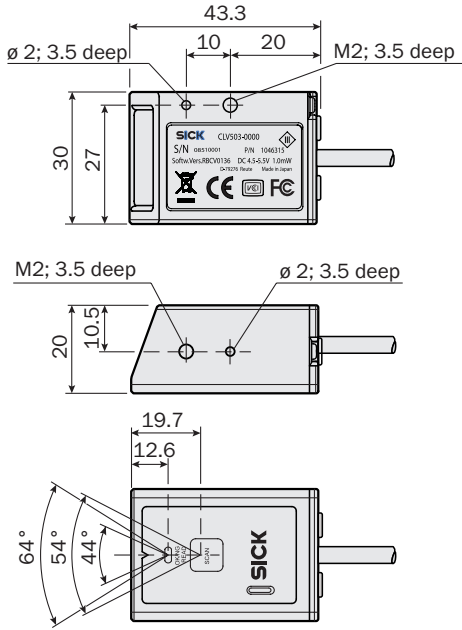

Dimensional drawing CLV505

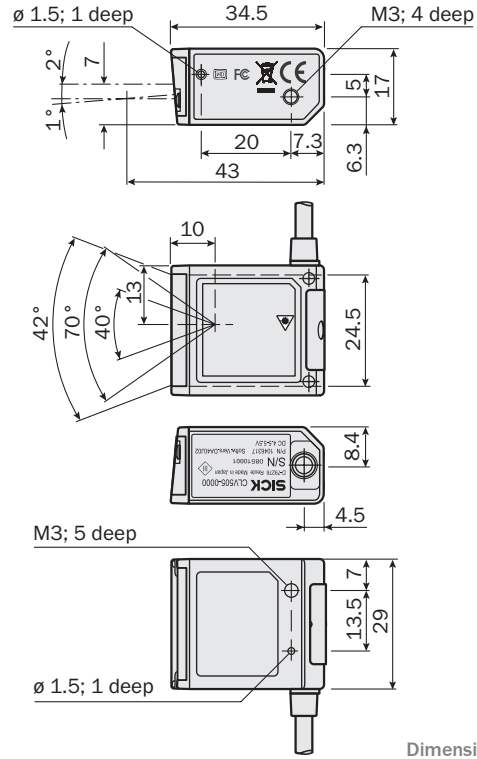

Dimensions in mm

Reading field diagram CLV503

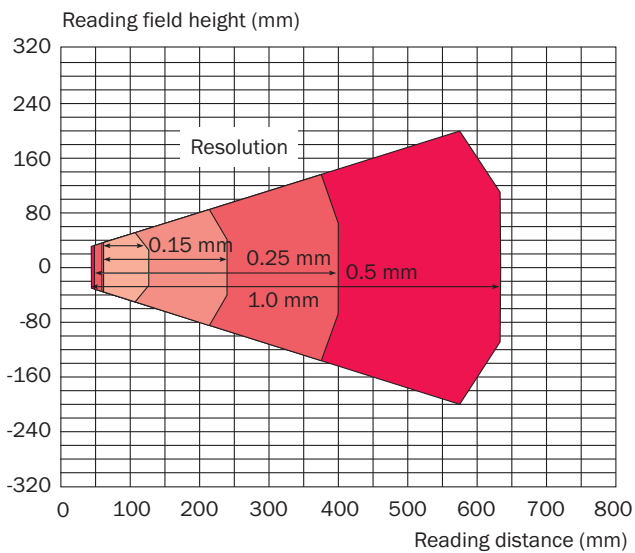

Reading field diagram CLV505

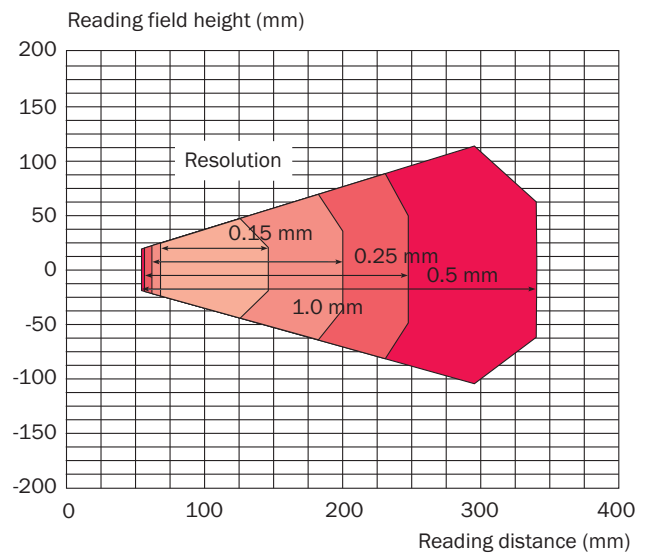

Dimensional drawings and reading field diagrams ICR803

Dimensional drawing ICR803

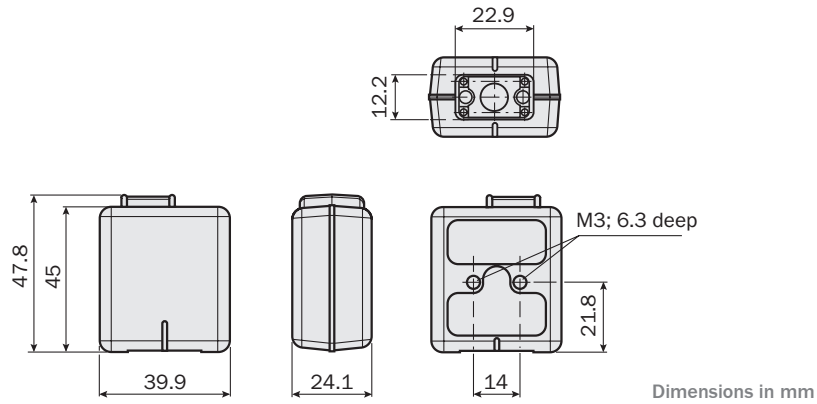

Reading field diagram ICR803-A

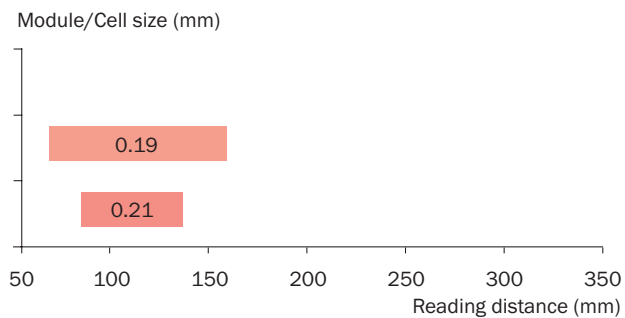

Reading field diagram ICR803-B

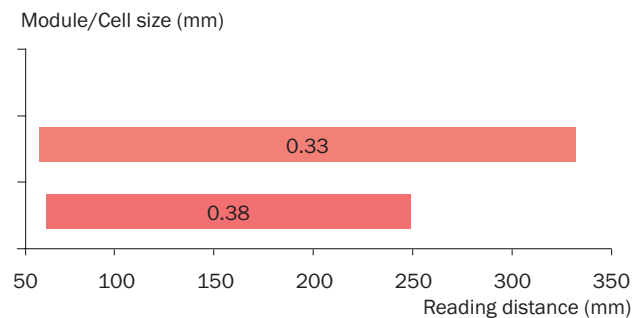

Ordering information devices and power supply

CLV503

Order no.	Type	Description
1046315	CLV503-0000	Line scanner, front reading window, cable with open wire ends, RS 232 data interface
1046316	CLV503-0110	Line scanner, front reading window, cable with USB plug, USB VCP/HID data interface

CLV505

Order no.	Type	Description
1046317	CLV505-0000	Line scanner, front reading window, cable with open wire ends, RS 232 data interface
1046318	CLV505-0110	Line scanner, front reading window, cable with USB plug, USB VCP/HID data interface
1046319	CLV505-1000	Grid scanner, front reading window, cable with open wire ends, RS 232 data interface
1046320	CLV505-1110	Grid scanner, front reading window, cable with USB plug, USB VCP/HID data interface

ICR803



Order no.	Type	Description
Geräte		
6034210	ICR803-A0201	2D Image Code Reader ICR803-A0201, optical version A, RS 232 data interface
6034212	ICR803-A0271	2D Image Code Reader ICR803-A0201, optical version A, USB data interface
6034211	ICR803-B0201	2D Image Code Reader ICR803-A0201, optical version B, RS 232 data interface
6034213	ICR803-B0271	2D Image Code Reader ICR803-A0201, optical version B, USB data interface

Power supply, power supply cables



Order no.	Type	Description	CLV503	CLV505	ICR803
6034941	PS5U-42E	5 V DC, input voltage 100 to 240 V at 47 to 63 Hz, incl. power supply cable with European safety plug			•
6034942	PS5U-43E	5 V DC, input voltage 100 to 240 V at 47 to 63 Hz, incl. power supply cable with UK plug			•
6034790	PS5U-41E	5 V DC, input voltage 100 to 240 V at 47 to 63 Hz, incl. power supply cable with USA plug			•
6034354		Power supply cable with flat European plug			•
6034357		Power supply cable with Australian plug			•

Accessories

Cables and connectors

Order no.	Length	Description		CLV503	CLV505	ICR803
6028232	2.4 m	Straight USB cable				•
6033047	2.4 m	Straight RS 232 TTL cable, 2.4 m length, external power supply (see page 12) necessary				•
6028186	2.4 m	Straight RS 232 TTL cable, 2.4 m length, power supply on pin 9				•
1027093		Connection module CDB405-001 with integrated 24/5 V DC converter				•
6034935	2 m	Straight RS 232 TTL cable, 2 m length, for connection of ICR803 to CDB405-001				•
6032516	2.8 m	USB spiral cable				•
6012109	2.4 m	RS 232 TTL spiral cable, external power supply device necessary (see page 12)				•
6025955	2.4 m	RS 232 TTL spiral cable, power supply on pin 9				•
6010019		D-Sub plug-in connector insert, 15-pin HD receptacle strip (socket), manual solder connection		•	•	
6010020		D-Sub plug-in connector insert, 15-pin HD receptacle strip (plug), manual solder connection		•	•	
6009438		D-Sub plug-in connector housing (metal) for 9-pin/15-pin HD inserts		•	•	

Brackets

Order no.	Description		CLV503	CLV505	ICR803
2050021	Mounting bracket for CLV503		•		
2050022	Mounting bracket for CLV505			•	
2050023	Mounting bracket for ICR803				•

Configuration

Parameterisation of Mini Line devices takes place via configuration bar codes.

Via configuration bar codes

Starting from the basic default settings, it is easy to change the most important parameter values to adapt to the application with the help of the configuration bar codes provided (see Quick Start for the particular product).

An online tool is available at <http://setup-mini-line.sick.com> for the expanded configuration. This tool also provides the configuration in the form of configuration bar codes.

It really is this easy:

- Go to the graphic user interface at <http://setup-mini-line.sick.com>
- Select the bar code for the desired configuration and print it out
- Scan the configuration bar code

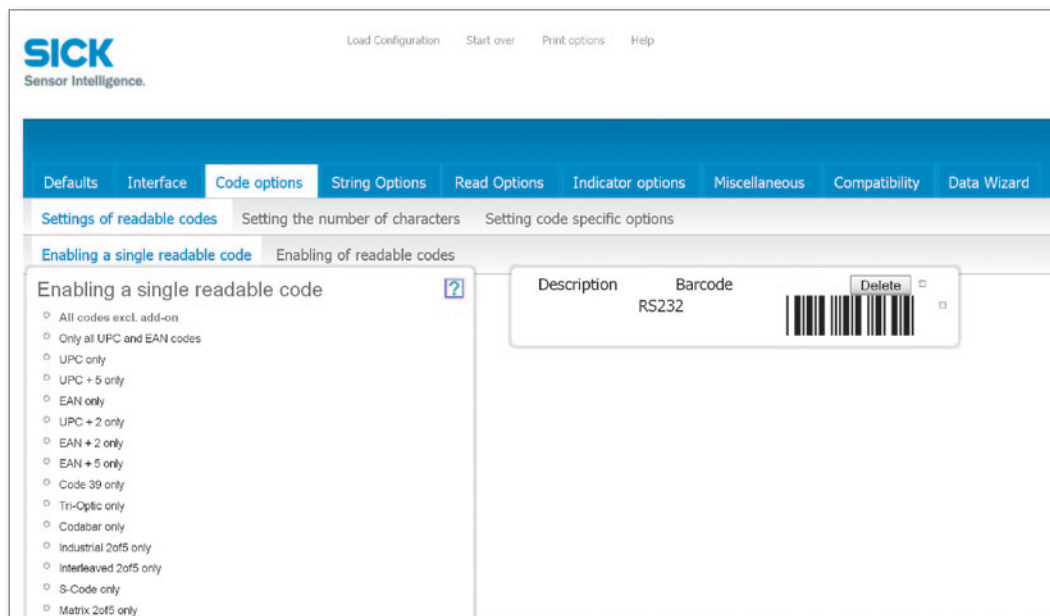

SICK Service for optimized Auto Ident solutions

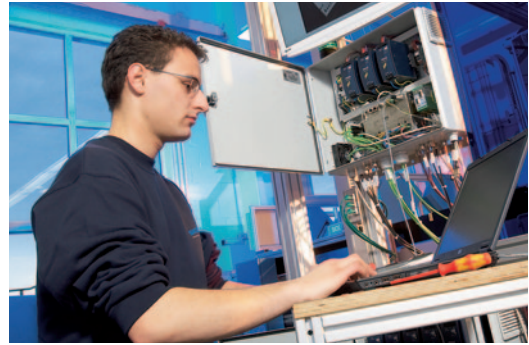

Pre-Sales

Application consulting

- Examination of economic practicality
- Assessment of cost-determining parameters
- SICK engineering teams propose best possible individual solution

Engineering

- Intelligent solutions resulting from combination of individual systems
- SICK Quality Management System ensures the high dependability of customer systems

Project management

- SICK project management teams ensure optimum project progress from the planning phase to acceptance

After-Sales

Maintenance

SICK scanners and RFID systems are maintenance-free. Regular cleaning and adjustment work is, however, recommended to ensure optimum performance during the whole operating period, e.g.

- to detect changes in the application
- to repair any damage

Troubleshooting and spare parts

- Co-ordinated spare part and repair concept
- Development of economically interesting models
- Such models and other services agreed in service contracts

Installation phase

Installation and commissioning

- SICK service technicians carry out installation worldwide
- SICK engineers carry out commissioning
- Optimum configuration

Site management

- Smooth project progress through co-ordination of work on site

Acceptance

- SICK Service Specialists confirm the agreed performance features during a trial phase under practical conditions

Hotline

- SICK sales organisations can be contacted via a free technical Hotline
- Questions receive rapid answers or are forwarded to the relevant specialist departments without delay

Training

- Comprehensive training program at SICK or on site
- Tailor-made, product-specific courses for project planners, commissioning technicians and maintenance staff
- Participants receive support in the achievement of their particular tasks within the works

SICK supports you during every phase of your Auto Ident projects – for technically and economically optimum solutions.

FACTORY AUTOMATION

With its intelligent sensors, safety systems, and auto idet applications, SICK realises comprehensive solutions for factory automation.

- Non-contact detecting, counting, classifying, and positioning of any types of object
- Accident protection and personal safety using sensors, as well as safety software and services



LOGISTICS AUTOMATION

Sensors made by SICK form the basis for automating material flows and the optimisation of sorting and warehousing processes.

- Automated identification with bar code and RFID reading devices for the purpose of sorting and target control in industrial material flow
- Detecting volume, position, and contours of objects and surroundings with laser measurement systems



PROCESS AUTOMATION

Analyzers and Process Instrumentation by SICK MAIHAK provides for the best possible acquisition of environmental and process data.

- Complete systems solutions for gas analysis, dust measurement, flow rate measurement, water analysis or, respectively, liquid analysis, and level measurement as well as other tasks



8012891/2009-04_SS
Subject to change without notice · 00 WB USmod int32

Worldwide presence with subsidiaries in the following countries:

Australia
Belgium/Luxembourg
Brasil
Česká Republika
China
Danmark
Deutschland
España
France
Great Britain
India
Israel
Italia
Japan

Nederlands
Norge
Österreich
Polska
Republic of Korea
Republika Slovenija
România
Russia
Schweiz
Singapore
Suomi
Sverige
Taiwan
Türkiye
USA/Canada/México

Please find detailed addresses and additional representatives and agencies in all major industrial nations at www.sick.com

Handed over by:

