



Description

Series 6000 photoelectric sensors provide reliable general purpose sensing in a compact package.

Each Series 6000 sensor has a single red output indicator. The Transmitted Beam Light Source has a red power indicator. Each sensor has a clutch-protected four-turn adjustment potentiometer.

Each sensor can be supplied with a 3m (9.8ft) four or five conductor PVC cable or with a 4-pin DC or AC micro-style quick disconnect on the end of a 300mm (12in) length cable (“pigtail”). Mating DC and AC micro-style quick disconnect cables are available, refer to page 5–1.

Low voltage DC sensors have both NPN and floating PNP outputs. Typical response is 1ms, and unique High Speed Diffuse and High Speed Fiber Optic versions offer a fast 200µs response time.

Two AC/DC versions are available. 20–132V AC/DC sensors offer a single 300mA Power MOSFET output. 20–264V AC/DC sensors offer a single 150mA Power MOSFET output. Light Operate or Dark Operate is selected by catalog number for all Series 6000 sensors.

A custom Swivel/Tilt mounting bracket is available for the Series 6000. This bracket allows the sensor to be tilted 10° in any direction and swiveled 360°. In addition, three different right angle steel mounting brackets are available, see page NO TAG.

General Specifications

Light Source	See Selection Guide
Unit Protection	Reverse Polarity, False Pulse
Supply Voltage	10–30V DC; 20–132V AC/DC; 20–264V AC/DC
Current Consumption	35mA maximum
Output Type	Both NPN and PNP (DC); MOSFET (AC/DC)
Output Mode	Light or dark operate by model
Output Rating	See Selection Guide
Response Time	See Selection Guide
Housing Material	Noryl
Lens Material	Acrylic
LED Indicators	See User Interface on page 1–160
Connection Types	3m 300V cable, 4-pin DC micro QD, 4-pin AC micro QD
Supplied Accessories	Mounting kit #129–106–1 and 129–106–2
Optional Accessories	Mounting brackets, reflectors, cordsets
Operating Environment	NEMA 3, 4X, 6, 12, 13 (IP67)
Vibration	10–55Hz, 1mm amplitude, meets or exceeds IEC 60947–5–2
Shock	30g with 1ms pulse duration, meets or exceeds IEC 60947–5–2
Operating Temperature	–40°C to +56°C (–40°F to +150°F)
Relative Humidity	95% max
Approvals	UL listed, CSA approved, and CE marked for all applicable directives

Features

- Compact cylindrical package
- Wide selection of sensing modes
- Universal supply voltage models
- Both NPN or PNP outputs (DC)
- Fast response time
- Variety of connection types

General Information

Wiring Diagrams page 1–160
Dimensions page 1–161

Accessories

Quick-Disconnect Cables page 5–1
Mounting Brackets page 1–301
Reflectors page 1–310

Sensing Modes

Retroreflective page 1–162
Polarized Retroreflective page 1–163
Retroreflective Code Reader page 1–164
Standard Diffuse page 1–165
Fixed Focus Diffuse page 1–166
Sharp Cutoff Diffuse page 1–167
Wide Angle Diffuse page 1–168
High Speed Diffuse page 1–169
Transmitted Beam page 1–170
Infrared Glass Fiber Optic page 1–171
Visible Red Plastic Fiber Optic page 1–172

User Interface Panel

Label	Color	State	Status
Output	Red	OFF	Sensor output de-activated
		ON	Sensor output activated

Wiring Diagrams

DC All Models Except Transmitted Beam Source and High Speed Diffuse

Cable Version

Models: 42SR_6_2 and 6_3

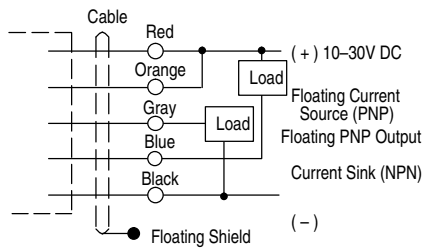

Transmitted Beam Source (42SRL-6000)

Cable Version

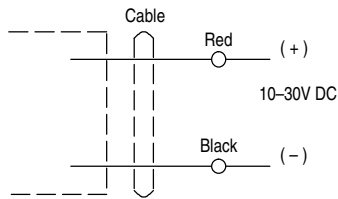

High Speed Diffuse (42SRP-6302)

Cable Version—NPN Outputs

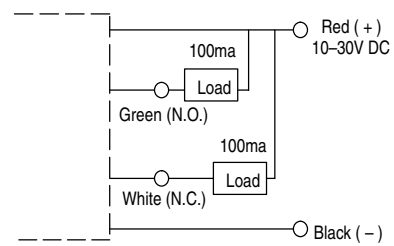

Quick-Disconnect Versions

Models: 42SR_6_2-QD and 6_3-QD

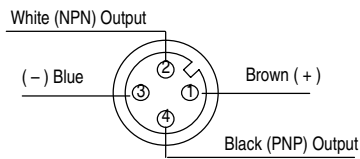

Quick-Disconnect Version

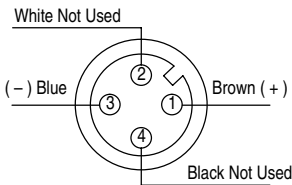

Quick-Disconnect Version

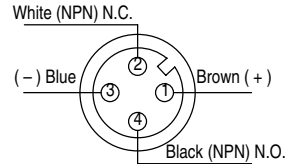

AC/DC All Models Except Transmitted Beam Source

Cable Versions

Models: 42SR_6_4 and 6_5

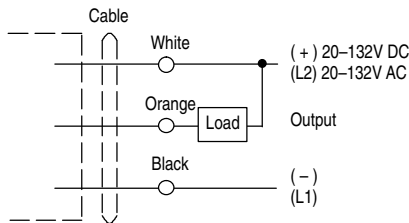

Models: 42SR_6_6 and 6_7

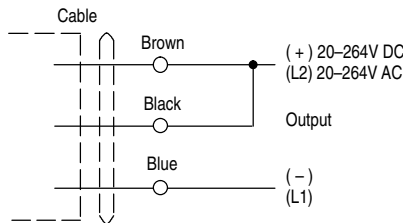

Quick-Disconnect Versions

Models: 42SR_6_4-QD thru 6_7-QD

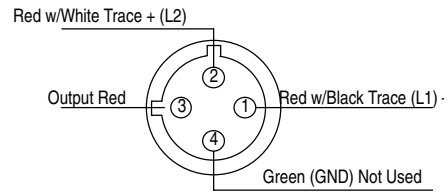

Transmitted Beam Source (42SRL-6006)

Cable Version

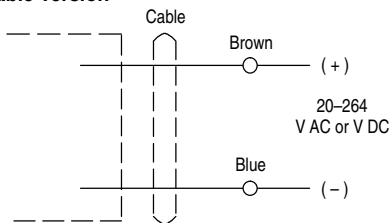

Quick-Disconnect Version

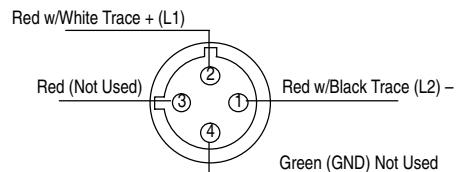

Note: Details regarding connection of Allen-Bradley Series 6000 photoelectric sensors to Allen-Bradley Programmable Controllers can be found in publication 42-2.0.

All wire colors shown refer to Allen-Bradley quick-disconnect cables.

Dimensions—mm (inches)

DC Models

All Models Except Fiber Optic

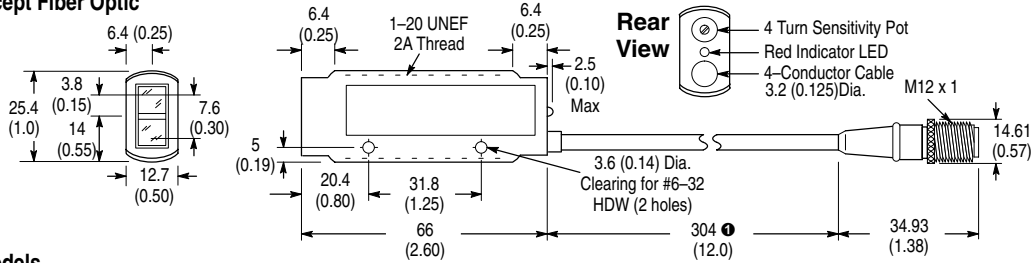

Fiber Optic Models

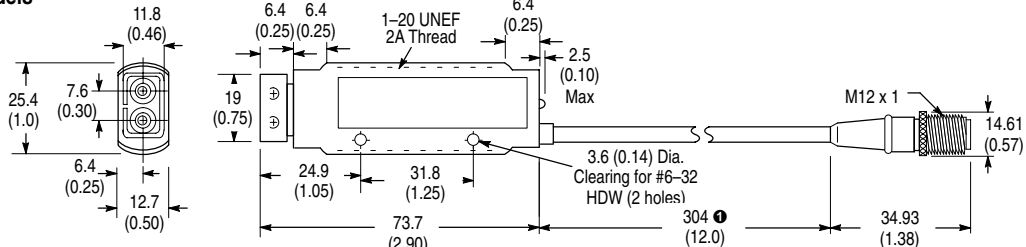

● Quick-disconnect cable length shown. Cable versions length is 10ft (3m).

Connector Version

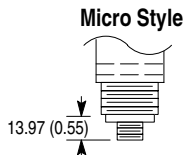

Thread Size

	AC	DC
Micro	1/2-20 UNF 2 Keyways	M12 x 1 1 Keyway

All Models Except Fiber Optic

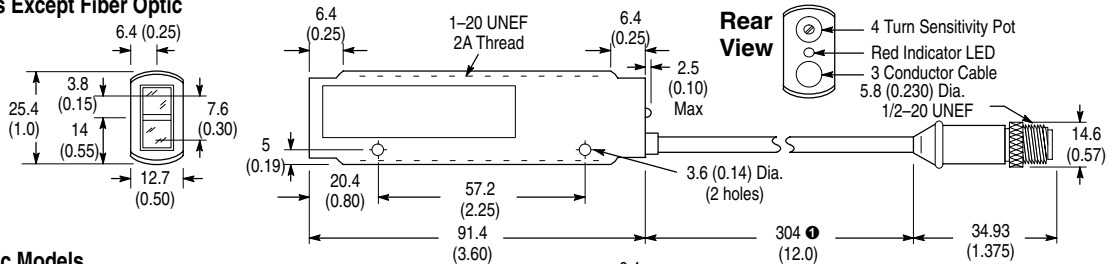

Fiber Optic Models

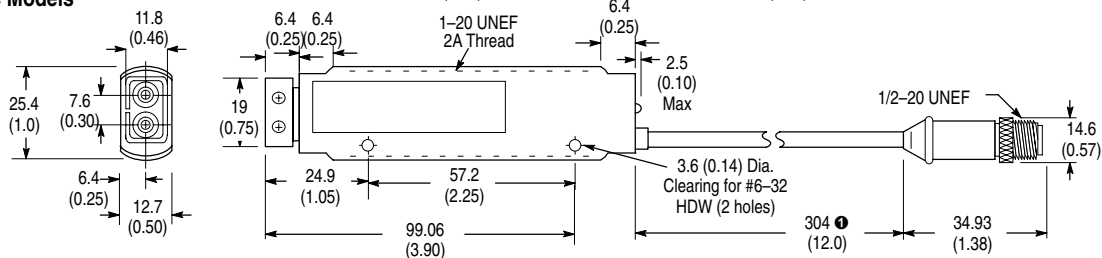

● Quick-disconnect cable length shown. Cable versions length is 10 ft (3m).

Supplied Accessories

Mounting Kit #129-106-1 contains 2 plastic nuts, anti-vibration mount, and slip pads.

Mounting Kit #129-106-2 contains 2 plastic nuts, anti-vibration mount, slip pads, and fiber optic mounting hardware.

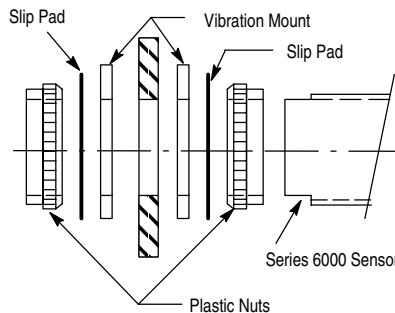

Plastic Nuts

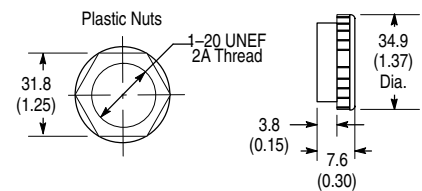

Series 6000 Retroreflective

Compact Style

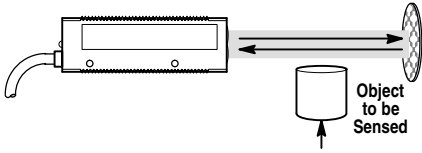

QD Cordsets and Accessories

Description	Catalog or Page Number
2m (6.5ft) 4-pin DC Micro QD Cordset	889D-F4AC-2
2m (6.5ft) 4-pin AC Micro QD Cordset	889R-F4AEA-2
Other Cordsets	5-26, 5-44
Terminal Chambers	5-19
Mounting Brackets	60-2618
Right Angle Mirror	60-2052
76mm (3in) Diameter Reflector	92-39
32mm (1.25in) Diameter Reflector	92-47

Typical Response Curve

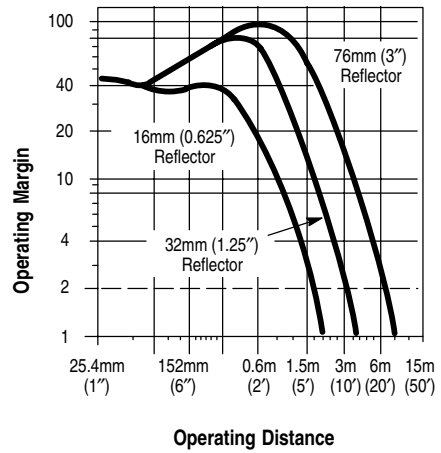

Specifications

Field of View	3°
Emitter LED	Infrared 880nm

Selection Guide

Operating Voltage Supply Current	Sensing Distance @ 1X Margin	Output Energized	Output Type Capacity Response Time	Max Leakage Current	Connection Type	Catalog Number
10-30V DC 35mA	25.4mm (1in) to 9m (30ft) with 76mm (3") Reflector	Light	NPN and PNP 200mA 1ms	1µA	3m cable	42SRU-6002
		Dark			4-pin DC micro QD	42SRU-6002-QD
20-132V AC/DC 50-60Hz 1.2VA		Light	Power MOSFET 300mA AC/DC 12ms AC, 5ms DC	1mA	3m cable	42SRU-6003
		Dark			4-pin DC micro QD	42SRU-6003-QD
		Light			3m cable	42SRU-6004
		Dark			4-pin AC micro QD	42SRU-6004-QD
20-264V AC/DC 50-60Hz 1.2VA	Light	Power MOSFET 150mA AC/DC 18ms AC, 10ms DC	1.5mA	3m cable	42SRU-6005	
	Dark			4-pin AC micro QD	42SRU-6005-QD	
	Light			3m cable	42SRU-6006	
	Dark			4-pin AC micro QD	42SRU-6006-QD	
					3m cable	42SRU-6007
					4-pin AC micro QD	42SRU-6007-QD

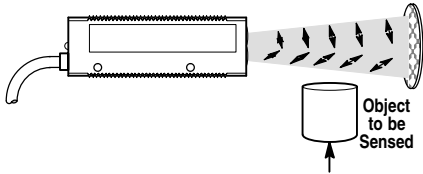

QD Cordsets and Accessories

Description	Catalog or Page Number
2m (6.5ft) 4-pin DC Micro QD Cordset	889D-F4AC-2
2m (6.5ft) 4-pin AC Micro QD Cordset	889R-F4AEA-2
Other Cordsets	5-26, 5-44
Terminal Chambers	5-19
Mounting Brackets	60-2618
Right Angle Mirror	60-2052
76mm (3in) Diameter Reflector	92-39
32mm (1.25in) Diameter Reflector	92-47

Typical Response Curve

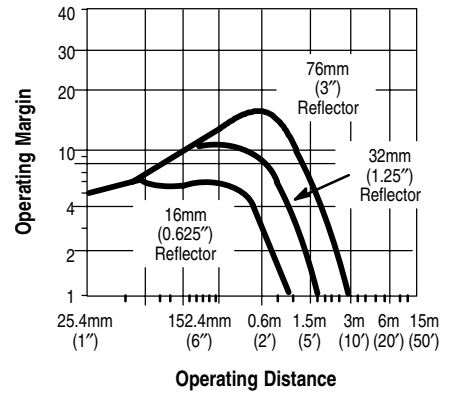

Specifications

Field of View	3°
Minimum Sensing Distance	50.8mm (2in)
Emitter LED	Visible red 660nm
Indicator LED	Red: Output

Selection Guide

Operating Voltage Supply Current	Sensing Distance @ 1X Margin	Output Energized	Output Type Capacity Response Time	Max Leakage Current	Connection Type	Catalog Number
10-30V DC 35mA	50.8mm (2in) to 3m (10ft) with 76mm (3") Reflector	Light	NPN and PNP 200mA 1ms	1μA	3m cable	42SRU-6202
		Dark			4-pin DC micro QD	42SRU-6202-QD
20-132V AC/DC 50-60Hz 1.2VA		Light	Power MOSFET 300mA AC/DC 12ms AC, 5ms DC	1mA	3m cable	42SRU-6203
					Dark	4-pin DC micro QD
		Light			3m cable	42SRU-6204
					Dark	4-pin AC micro QD
20-264V AC/DC 50-60Hz 1.2VA	Light	Power MOSFET 150mA AC/DC 18ms AC, 10ms DC	1.5mA	3m cable	42SRU-6205	
				Dark	4-pin AC micro QD	42SRU-6205-QD
	Light			3m cable	42SRU-6206	
				Dark	4-pin AC micro QD	42SRU-6206-QD
	3m cable	42SRU-6207				
	4-pin AC micro QD	42SRU-6207-QD				

Series 6000 Retroreflective Code Reader

Compact Style

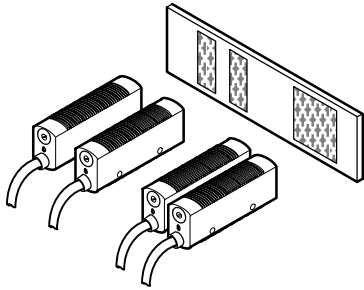

Designed to sense retroreflective tape marks arranged in geographic code pattern on a flat surface. Two models with different modulating frequencies permit close mounting without interference. Versions 6402 and 6412 differ in modulation frequency.

Specifications

Field of View	3°
Emitter LED	Visible red 660nm

QD Cordsets and Accessories

Description	Catalog or Page Number
2m (6.5ft) 4-pin DC Micro QD Cordset	889D-F4AC-2
2m (6.5ft) 4-pin AC Micro QD Cordset	889R-F4AEA-2
Other Cordsets	5-26, 5-44
Terminal Chambers	5-19
Mounting Brackets	60-2618
Right Angle Mirror	60-2052

Typical Response Curve

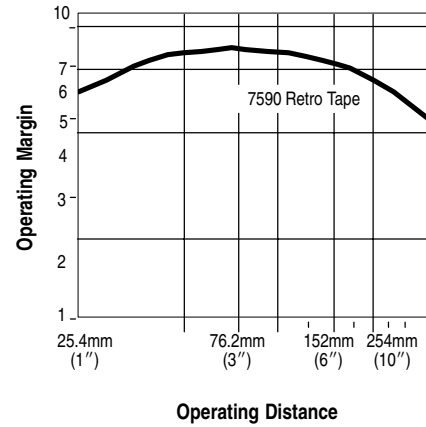

Operating Distance with Reflective Tape

0.25in Tape 0.5in Centers	25mm-178mm (1in-7in)
0.5in Tape 0.5in Centers	25mm-152mm (1in-6in)
0.5in Tape 1in Centers	25mm-254mm (1in-10in)

Selection Guide

Operating Voltage Supply Current	Sensing Distance	Output Energized	Output Type Capacity Response Time	Max Leakage Current	Connection Type	Catalog Number
10-30V DC 30mA	25mm (1.0in) to 254mm (10in)	Light 7590 Retro Tape	NPN and PNP 200mA 2ms	1µA	3m cable	42SRU-6402
					4-pin DC micro QD	42SRU-6402-QD
			NPN and PNP 200mA 1.5ms		3m cable	42SRU-6412
					4-pin DC micro QD	42SRU-6412-QD

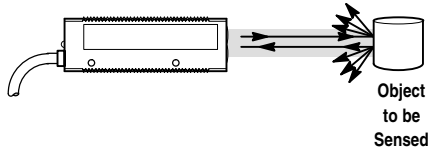

QD Cordsets and Accessories

Description	Catalog or Page Number
2m (6.5ft) 4-pin DC Micro QD Cordset	889D-F4AC-2
2m (6.5ft) 4-pin AC Micro QD Cordset	889R-F4AEA-2
Other Cordsets	5-26, 5-44
Terminal Chambers	5-19
Mounting Brackets	60-2618
Right Angle Mirror	60-2052

Typical Response Curve

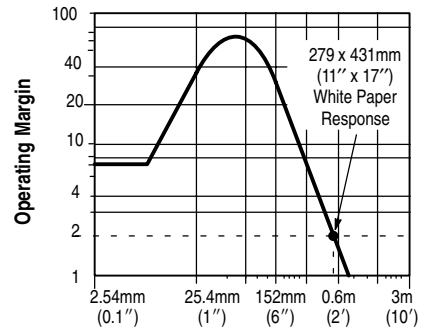

Specifications

Field of View	7.5°
Emitter LED	Infrared 880nm

Selection Guide

Operating Voltage Supply Current	Sensing Distance @ 1X Margin	Output Energized	Output Type Capacity Response Time	Max Leakage Current	Connection Type	Catalog Number	
10-30V DC 35mA	2.54mm (0.1in) to 760mm (30in) to White Paper	Light	NPN and PNP 200mA 1ms	1μA	3m cable	42SRP-6002	
		Dark			4-pin DC micro QD	42SRP-6002-QD	
20-132V AC/DC 50-60Hz 1.2VA		Light	Power MOSFET 300mA AC/DC 12ms AC, 5ms DC	1mA	3m cable	42SRP-6003	
		Dark			4-pin DC micro QD	42SRP-6003-QD	
		20-264V AC/DC 50-60Hz 1.2VA	Light	Power MOSFET 150mA AC/DC 18ms AC, 10ms DC	1.5mA	3m cable	42SRP-6004
			Dark			4-pin AC micro QD	42SRP-6004-QD
20-264V AC/DC 50-60Hz 1.2VA	Light	Power MOSFET 150mA AC/DC 18ms AC, 10ms DC	1.5mA	3m cable	42SRP-6005		
	Dark			4-pin AC micro QD	42SRP-6005-QD		
	Light			3m cable	42SRP-6006		
	Dark	4-pin AC micro QD	42SRP-6006-QD				
	Light	3m cable	42SRP-6007				
	Dark	4-pin AC micro QD	42SRP-6007-QD				

Series 6000 Fixed Focus Diffuse

Compact Style

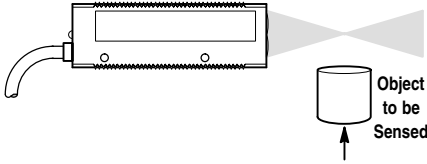

QD Cordsets and Accessories

Description	Catalog or Page Number
2m (6.5ft) 4-pin DC Micro QD Cordset	889D-F4AC-2
2m (6.5ft) 4-pin AC Micro QD Cordset	889R-F4AEA-2
Other Cordsets	5-26, 5-44
Terminal Chambers	5-19
Mounting Brackets	60-2618
Right Angle Mirror	60-2052

Typical Response Curve

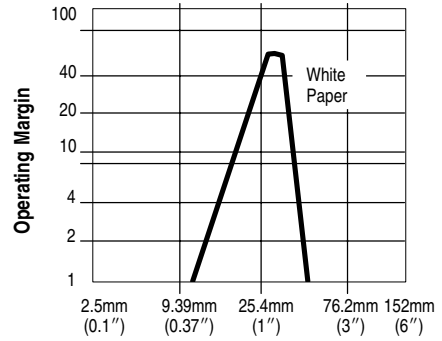

Specifications

Field of View	0.15cm (0.06in) square
Emitter LED	Visible red 660nm

Selection Guide

Operating Voltage Supply Current	Max Sensing Distance @ 1X Margin	Output Energized	Output Type Capacity Response Time	Max Leakage Current	Connection Type	Catalog Number	
10-30V DC 35mA	27.9mm (1.1in) to 28mm (1.1in) to White Paper	Light	NPN and PNP 200mA 1ms	1µA	3m cable	42SRP-6022	
		Dark			4-pin DC micro QD	42SRP-6022-QD	
		Light	3m cable		42SRP-6023		
			4-pin DC micro QD		42SRP-6023-QD		
20-132V AC/DC 50-60Hz 1.2VA		27.9mm (1.1in) to 28mm (1.1in) to White Paper	Light	Power MOSFET 300mA AC/DC 12ms AC, 5ms DC	1mA	3m cable	42SRP-6024
			Dark			4-pin AC micro QD	42SRP-6024-QD
			Light	3m cable		42SRP-6025	
				4-pin AC micro QD		42SRP-6025-QD	
20-264V AC/DC 50-60Hz 1.2VA	27.9mm (1.1in) to 28mm (1.1in) to White Paper		Light	Power MOSFET 150mA AC/DC 18ms AC, 10ms DC	1.5mA	3m cable	42SRP-6026
			Dark			4-pin AC micro QD	42SRP-6026-QD
			Light	3m cable		42SRP-6027	
				4-pin AC micro QD		42SRP-6027-QD	

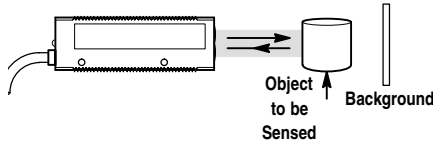

Specifications

Field of View	7.5°
Emitter LED	Infrared 880nm

QD Cordsets and Accessories

Description	Catalog or Page Number
2m (6.5ft) 4-pin DC Micro QD Cordset	889D-F4AC-2
2m (6.5ft) 4-pin AC Micro QD Cordset	889R-F4AEA-2
Other Cordsets	5-26, 5-44
Terminal Chambers	5-19
Mounting Brackets	60-2618
Right Angle Mirror	60-2052

Typical Response Curve

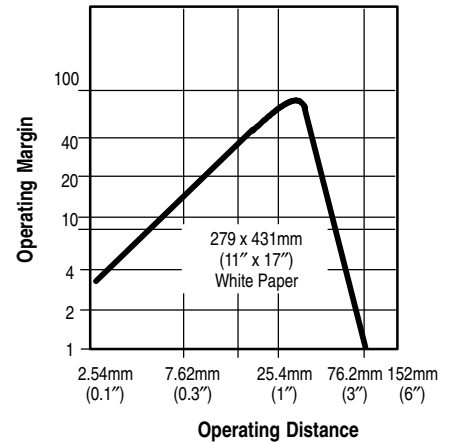

Selection Guide

Operating Voltage Supply Current	Sensing Distance @ 1X Margin	Output Energized	Output Type Capacity Response Time	Max Leakage Current	Connection Type	Catalog Number	
10-30V DC 35mA	5mm (0.2in) to 76mm (3in) to White Paper	Light	NPN and PNP 200mA 1ms	1μA	3m cable	42SRP-6032	
		Dark			4-pin DC micro QD	42SRP-6032-QD	
		20-132V AC/DC 50-60Hz 1.2VA	Light	Power MOSFET 300mA AC/DC 12ms AC, 5ms DC	1mA	3m cable	42SRP-6034
			Dark			4-pin AC micro QD	42SRP-6034-QD
20-264V AC/DC 50-60Hz 1.2VA			Light	Power MOSFET 150mA AC/DC 18ms AC, 10ms DC	1.5mA	3m cable	42SRP-6035
			Dark			4-pin AC micro QD	42SRP-6035-QD
		20-264V AC/DC 50-60Hz 1.2VA	Light	Power MOSFET 150mA AC/DC 18ms AC, 10ms DC	1.5mA	3m cable	42SRP-6036
			Dark			4-pin AC micro QD	42SRP-6036-QD
20-264V AC/DC 50-60Hz 1.2VA	Light		Power MOSFET 150mA AC/DC 18ms AC, 10ms DC	1.5mA	3m cable	42SRP-6037	
	Dark				4-pin AC micro QD	42SRP-6037-QD	

PHOTOSWITCH® Photoelectric Sensors
Series 6000 Wide Angle Diffuse
Compact Style

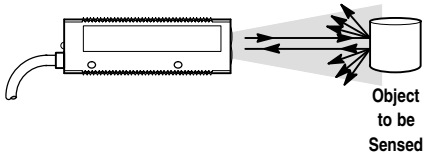

QD Cordsets and Accessories

Description	Catalog or Page Number
2m (6.5ft) 4-pin DC Micro QD Cordset	889D-F4AC-2
2m (6.5ft) 4-pin AC Micro QD Cordset	889R-F4AEA-2
Other Cordsets	5-26, 5-44
Terminal Chambers	5-19
Mounting Brackets	60-2618
Right Angle Mirror	60-2052

Typical Response Curve

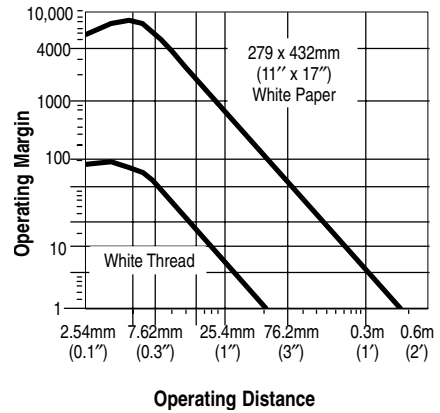

Specifications

Field of View	62°
Emitter LED	Infrared 880nm

Selection Guide

Operating Voltage Supply Current	Sensing Distance @ 1X Margin	Output Energized	Output Type Capacity Response Time	Max Leakage Current	Connection Type	Catalog Number
10-30V DC 35mA	2.54mm (0.1in) to 380mm (15in) to White Paper	Light	NPN and PNP 200mA 1ms	1µA	3m cable	42SRP-6012
		Dark			4-pin DC micro QD	42SRP-6012-QD
20-132V AC/DC 50-60Hz 1.2VA		Light	Power MOSFET 300mA AC/DC 12ms AC, 5ms DC	1mA	3m cable	42SRP-6013
		Dark			4-pin DC micro QD	42SRP-6013-QD
		Light			3m cable	42SRP-6014
		Dark			4-pin AC micro QD	42SRP-6014-QD
20-264V AC/DC 50-60Hz 1.2VA	Light	Power MOSFET 150mA AC/DC 18ms AC, 10ms DC	1.5mA	3m cable	42SRP-6015	
	Dark			4-pin AC micro QD	42SRP-6015-QD	
	Light			3m cable	42SRP-6016	
	Dark			4-pin AC micro QD	42SRP-6016-QD	
					3m cable	42SRP-6017
					4-pin AC micro QD	42SRP-6017-QD

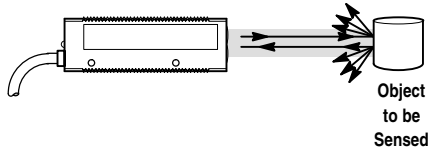

QD Cordsets and Accessories

Description	Catalog or Page Number
2m (6.5ft) 4-pin DC Micro QD Cordset	889D-F4AC-2
2m (6.5ft) 4-pin AC Micro QD Cordset	889R-F4AEA-2
Other Cordsets	5-26, 5-44
Terminal Chambers	5-19
Mounting Brackets	60-2618
Right Angle Mirror	60-2052

Typical Response Curve

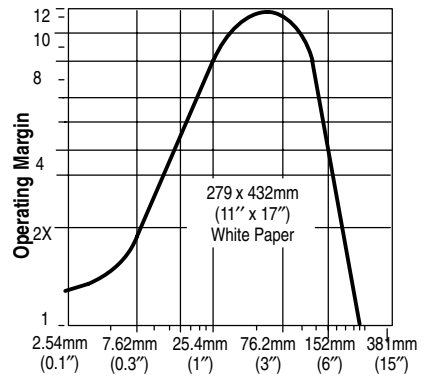

Specifications

Field of View	7.5°
Emitter LED	Infrared 880nm

Operating Distance

Selection Guide

Operating Voltage Supply Current	Sensing Distance @ 1X Margin	Output Energized	Output Type Capacity Response Time	Max Leakage Current	Connection Type	Catalog Number
10-30V DC 35mA	7.6mm (0.3in) to 254mm (10in) to White Paper	Light	Complementary NPN 100mA 200µs	1µA	3m cable	42SRP-6302
					4-pin DC micro QD	42SRP-6302-QD

Series 6000 Transmitted Beam

Compact Style

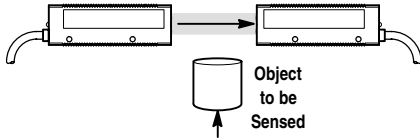

QD Cordsets and Accessories

Description	Catalog or Page Number
2m (6.5ft) 4-pin DC Micro QD Cordset	889D-F4AC-2
2m (6.5ft) 4-pin AC Micro QD Cordset	889R-F4AEA-2
Other Cordsets	5-26, 5-44
Terminal Chambers	5-19
Mounting Brackets	60-2618
Right Angle Mirror	60-2052

Typical Response Curve

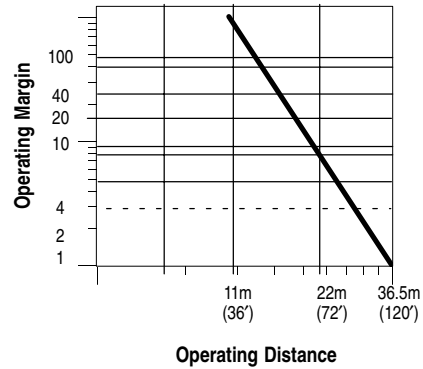

Specifications

Field of View	7.5°
Emitter LED	Infrared 880nm

Selection Guide for Light Source

Operating Voltage Supply Current	Sensing Distance @ 1X Margin	Output Type Capacity Response Time	Max Leakage Current	Connection Type	Catalog Number
10-30V DC 15mA	2.54mm (0.1in) to 36.6m (120ft)	—	—	3m cable	42SRL-6000
				4-pin DC micro QD	42SRL-6000-QD
20-264V AC/DC 50-60Hz 1VA				3m cable	42SRL-6006
4-pin AC micro QD				42SRL-6006-QD	

Selection Guide for Receiver

Operating Voltage Supply Current	Output Energized	Output Type Capacity Response Time	Max Leakage Current	Connection Type	Catalog Number
10-30V DC 15mA	Light	NPN and PNP 200mA 5ms	1µA	3m cable	42SRR-6002
	Dark			4-pin DC micro QD	42SRR-6002-QD
				3m cable	42SRR-6003
	4-pin DC micro QD			42SRR-6003-QD	
20-264V AC/DC 50-60Hz 1VA	Light	Power MOSFET 300mA AC/DC 18ms AC, 10ms DC	1mA	3m cable	42SRR-6006
	Dark			4-pin AC micro QD	42SRR-6006-QD
				3m cable	42SRR-6007
	4-pin AC micro QD			42SRR-6007-QD	

QD Cordsets and Accessories

Typical Response Curve

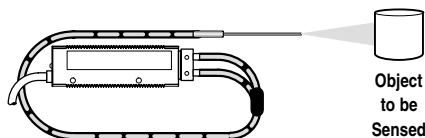

Description	Catalog or Page Number
2m (6.5ft) 4-pin DC Micro QD Cordset	889D-F4AC-2
2m (6.5ft) 4-pin AC Micro QD Cordset	889R-F4AEA-2
Other Cordsets	5-26, 5-44
Terminal Chambers	5-19
Mounting Brackets	60-2618
Right Angle Mirror	60-2052

Depends on Glass or Plastic Fiber Optics selected. See Fiber Optic sections, page 1-245.

Specifications

Field of View	Depends on Glass Fiber Optics selected. See Glass Fiber Optic section, page 1-245.
Emitter LED	Infrared 880nm

Selection Guide

Operating Voltage Supply Current	Sensing Distance @ 1X Margin	Output Energized	Output Type Capacity Response Time	Max Leakage Current	Connection Type	Catalog Number		
10-30V DC 30mA (High Speed)	Depends on Fiber Optic cable selected	Light	NPN and PNP 200mA 200µs	1µA	3m cable	42SRF-6502		
		Dark			4-pin DC micro QD	42SRF-6502-QD		
10-30V DC 35mA		Light	NPN and PNP 200mA 1ms		3m cable	42SRF-6503		
		Dark			4-pin DC micro QD	42SRF-6503-QD		
20-132V AC/DC 50-60Hz 1.2VA		Light	Power MOSFET 300mA AC/DC 12ms AC, 5ms DC		1mA	3m cable	42SRF-6002	
		Dark				4-pin DC micro QD	42SRF-6002-QD	
		20-264V AC/DC 50-60Hz 1.2VA		Light	Power MOSFET 150mA AC/DC 18ms AC, 10ms DC	1.5mA	3m cable	42SRF-6003
				Dark			4-pin DC micro QD	42SRF-6003-QD
20-132V AC/DC 50-60Hz 1.2VA		Light	Power MOSFET 300mA AC/DC 12ms AC, 5ms DC	1mA		3m cable	42SRF-6004	
		Dark				4-pin AC micro QD	42SRF-6004-QD	
20-264V AC/DC 50-60Hz 1.2VA		Light	Power MOSFET 150mA AC/DC 18ms AC, 10ms DC	1.5mA	3m cable	42SRF-6005		
		Dark			4-pin AC micro QD	42SRF-6005-QD		
20-132V AC/DC 50-60Hz 1.2VA	Light	Power MOSFET 300mA AC/DC 12ms AC, 5ms DC	1µA	3m cable	42SRF-6006			
	Dark			4-pin DC micro QD	42SRF-6006-QD			
20-264V AC/DC 50-60Hz 1.2VA	Light	Power MOSFET 150mA AC/DC 18ms AC, 10ms DC	1.5mA	3m cable	42SRF-6007			
	Dark			4-pin AC micro QD	42SRF-6007-QD			

Series 6000 Visible Red Plastic Fiber Optic

Compact Style

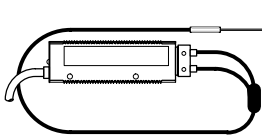

Object
to be
Sensed

QD Cordsets and Accessories

Description	Catalog or Page Number
2m (6.5ft) 4-pin DC Micro QD Cordset	889D-F4AC-2
2m (6.5ft) 4-pin AC Micro QD Cordset	889R-F4AEA-2
Other Cordsets	5-26, 5-44
Terminal Chambers	5-19
Mounting Brackets	60-2618
Right Angle Mirror	60-2052

Typical Response Curve

Depends on Glass Fiber Optics selected. See Series 5000 and 6000 Fiber Optic section, page 1-296.

Specifications

Field of View	Depends on Plastic or Glass Fiber Optics selected. See Plastic Fiber Optic section, page 1-296 and Glass Fiber Optic section, page 1-245.
Emitter LED	Visible 660nm

Selection Guide

Operating Voltage Supply Current	Sensing Distance @ 1X Margin	Output Energized	Output Type Capacity Response Time	Max Leakage Current	Connection Type	Catalog Number
10-30V DC 35mA (High Speed)	Depends on Glass or Plastic Fiber Optics selected	Light	NPN and PNP 200mA 200µs	1µA	3m cable	42SRF-6302
		Dark			4-pin DC micro QD	42SRF-6302-QD
10-30V DC 35mA		Light	NPN and PNP 200mA 1ms	1µA	3m cable	42SRF-6102
		Dark			4-pin DC micro QD	42SRF-6102-QD
20-132V AC/DC 50-60Hz 1.2VA		Light	Power MOSFET 300mA AC/DC 12ms AC, 5ms DC	1mA	3m cable	42SRF-6103
		Dark			4-pin DC micro QD	42SRF-6103-QD
20-264V AC/DC 50-60Hz 1.2VA		Light	Power MOSFET 150mA AC/DC 18ms AC, 10ms DC	1.5mA	3m cable	42SRF-6104
		Dark			4-pin AC micro QD	42SRF-6104-QD
	3m cable				42SRF-6105	
	4-pin AC micro QD	42SRF-6105-QD				
20-264V AC/DC 50-60Hz 1.2VA	Light	Power MOSFET 150mA AC/DC 18ms AC, 10ms DC	1.5mA	3m cable	42SRF-6106	
	Dark			4-pin AC micro QD	42SRF-6106-QD	
20-264V AC/DC 50-60Hz 1.2VA	Light	Power MOSFET 150mA AC/DC 18ms AC, 10ms DC	1.5mA	3m cable	42SRF-6107	
	Dark			4-pin AC micro QD	42SRF-6107-QD	