

TEC

TEC Laser Scanner

LS-770 SERIES

Owners Manual

Document No. EO1-19028B

TEC CORPORATION

Operation Manual Safety Precautions

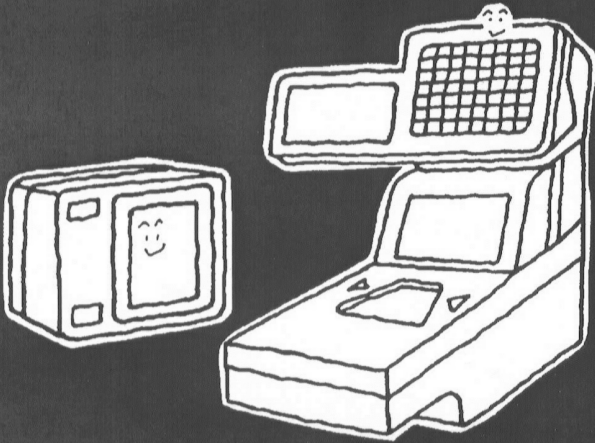

- Read these "Safety Precautions" and the "Owner's Manual" carefully before use.
- After reading these manuals, be sure to keep them near the machines for future reference.
- The contents of these "Safety Precautions" may include items not contained in the specifications of the product you have purchased.

This Operation Manual and the products (machines) which you have purchased contain indications which should be observed in order to use the machines safely and prevent harm to yourself and others and damage to property. The meanings of these indications and symbols are given below. Read these indications and become familiar with their contents before reading this Operation Manual.



WARNING

This indicates that there is the risk of **death** or **serious injury** if the machines are improperly handled disregarding this indication.



CAUTION

This indicates that there is the risk of personal **injury** or **damage** to objects if the machines are improperly handled disregarding this indication.

Meanings of Each Symbol



This symbol indicates warning items (including cautions). Specific warning contents are drawn inside the triangle. (the symbol on the left indicates a general caution.)



This symbol indicates prohibited actions (prohibited items). Specific prohibited contents are drawn inside or near the symbol. (the symbol on the left indicates "no disassembling".)



This symbol indicates actions which must be performed. Specific instructions are drawn inside the symbol. (the symbol on the left indicates "disconnect the power cord plug from the outlet.")



WARNING



Any other than the specified power voltage (AC) is prohibited.

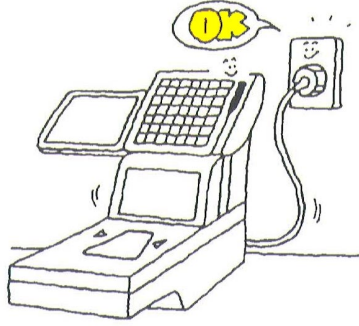

■ Do not use voltages other than the power voltage (AC) specified on the rating plate., as this may cause **fire** or **electric shock**.



Prohibited

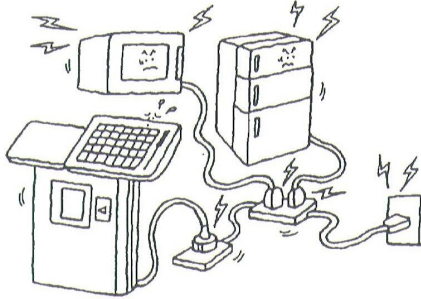

■ If the machines share the same outlet with any other electrical appliances, which consume larger amounts of power, the voltage will fluctuate widely each time these appliances operate. Be sure to provide an exclusive outlet for the machine as this may cause the machines to **malfunction**.



Prohibited

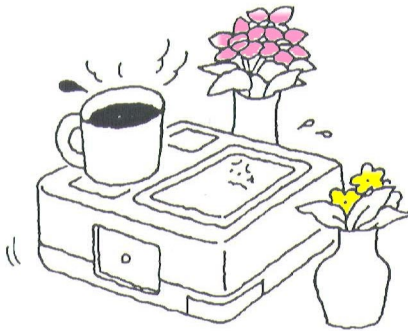

■ Do not place metal objects or water-filled containers such as flower vases, flower pots or mugs, etc. on top of the machines. If metal objects or spilled liquid enter the machines, this may cause **fire** or **electric shock**.



Prohibited



■ Do not insert or drop metal, flammable or other foreign objects into the machines through the ventilation slits, as this may cause **fire** or **electric shock**.



No disassembling.

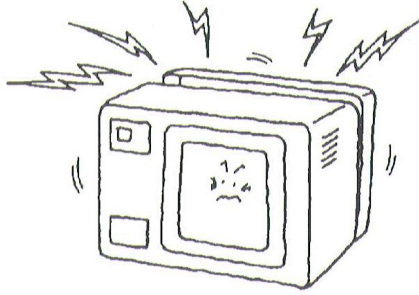

■ Do not detach the rear cover, cabinet, or any other cover. The insides of the machines contain high-voltage, sharp and hot parts, etc., which may cause **electric shock** or **injury**.



Prohibited

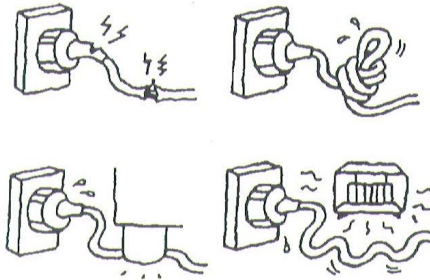

■ Do not scratch, damage or modify the power cords. Also, do not place heavy objects on, pull on, or excessively bend the cords, as this may cause **fire** or **electrical shock**.



WARNING



No disassembling.

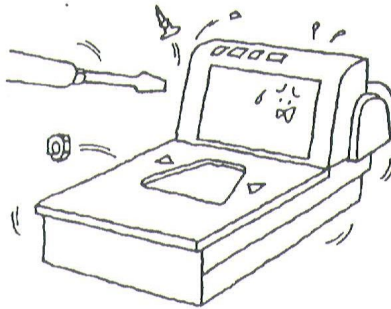

■ Do not attempt to repair or modify the machines by yourself, as this may cause **fire** or **electric shock**. Contact the sales agent (or maintenance and service agent) for any questions related to repairs.



Disconnect the plug.

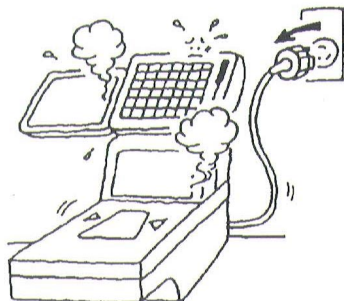

■ Continue use of the machines in an abnormal condition such as when the machines are producing smoke or strange smells any cause **fire** or **electric shock**. In these cases, immediately turn off the power switches and disconnect the power cord plugs from the outlet. Then, contact your sales agent (or maintenance and service agent).



Disconnect the plug.

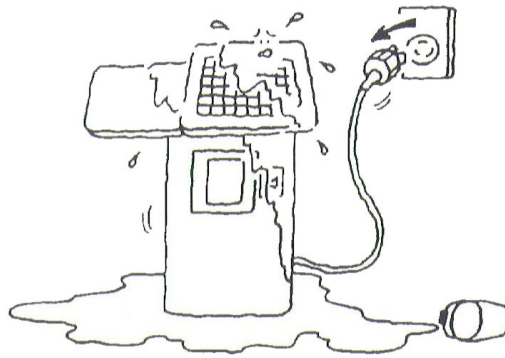

■ If or foreign objects (metal fragments, water, liquids) enter the machines, first turn off the power switches and disconnect the power cord plugs from the outlet, and then contact your sales agent (or maintenance and service agent). Continued use of the machine in that condition may cause **fire** or **electric shock**.



Disconnect the plug.

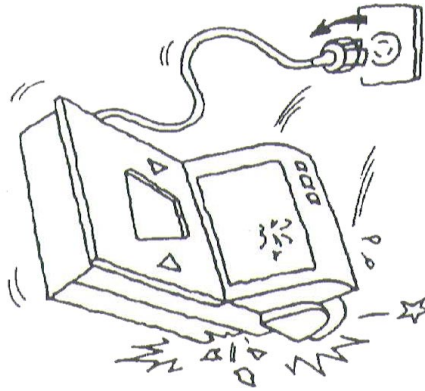

■ If the machines are dropped or their cabinets damaged, first turn off the power switches and disconnect the power cord plugs from the outlet, and then contact your sales agent (or maintenance and service agent). Continued use of the machine in that condition may cause **fire** or **electric shock**.



Prohibited

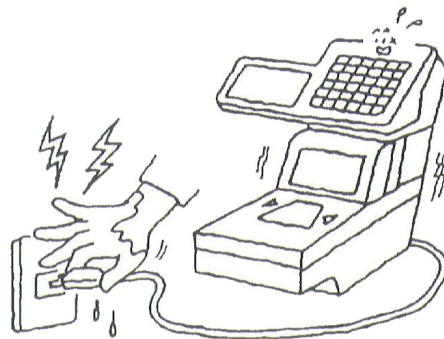

■ Do not plug in or unplug the power cord plug with wet hands as this may cause **electric shock**.



Connect a grounding wire.

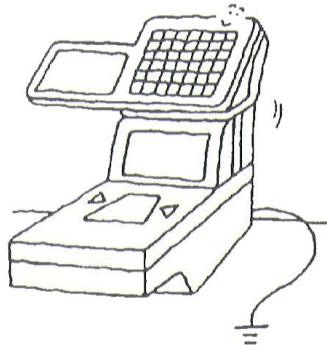

■ Connect grounding wires to the machines. If an electric leak occurs without grounding wires connected, it may cause **fire** or **electric shock**. If for some reason grounding wires cannot be connected, contact your sales agent (or maintenance and service agent).



WARNING



Prohibited

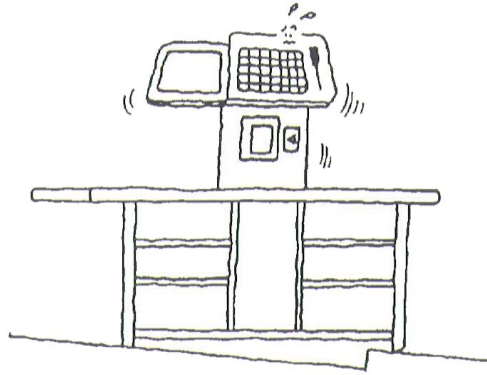

■ [Precautions During Installation]

■ Do not place the machines on unstable or slanted surfaces, as they may drop or fall and cause **injury**.



Prohibited

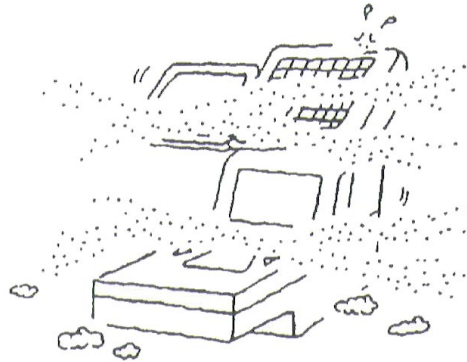

■ Do not place the machines in humid or dusty environments, as this may cause **fire** or **electric shock**.



Prohibited

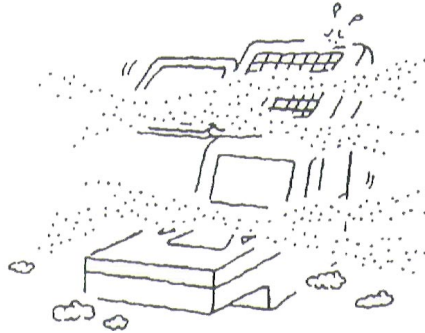

■ Do not place the machines in locations exposed to smoke or steam such as on kitchen tables or near humidifiers, as this may cause **fire** or **electric shock**.



Prohibited



■ Do not block the ventilation slits of the machines, as this will cause heat to build up inside the machines and may cause **fire**.



CAUTION



Prohibited

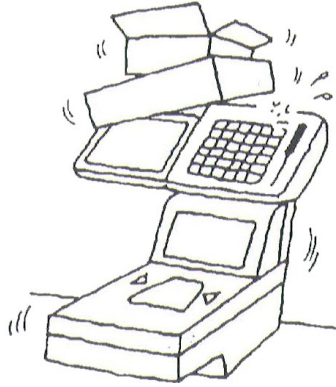

■ Do not place heavy objects on top of the machines, as these items may become unbalanced and fall causing **Injury**.



Disconnect the plug.

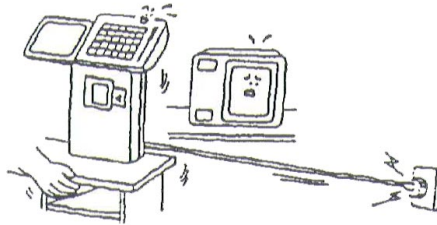

[Precautions When Moving the Machines]

■ When moving the machines, be sure to first unplug the power cords. Moving the machines with the power cords plugged in may damage the cords and cause **fire** or **electric shock**.



CAUTION



Caution

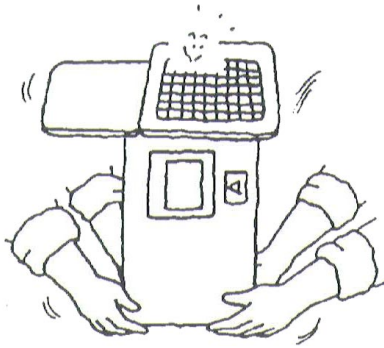

■ Be sure to move large scale machines with tow or more people. In addition, machines should be moved after first confirming that connecting wires between machines and externally connected wires, etc. have been removed. Failure to observe these precautions may result in **injury**.



Disconnect the plug.

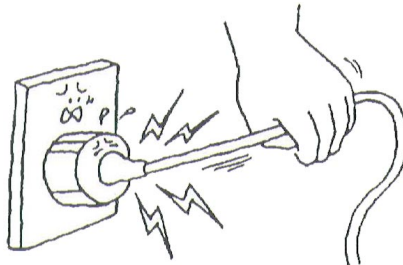

■ When unplugging the power cords, be sure to hold and pull on the plug portion. Pulling on the cord portion may cut or expose the internal wires and cause **fire** or **electric shock**.



Caution

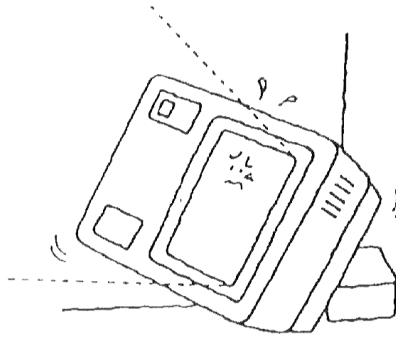

■ Do not remove the glass surface (top window) except for cleaning, as using the machine in this condition may **adversely affect people's eyes.**



Caution

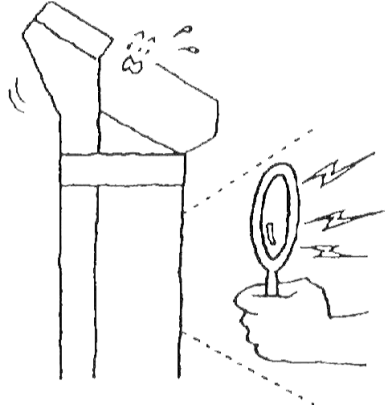

■ Using the laser beam with large mirrors or optical equipment will result in **increased risk to people's eyes.**



CAUTION

● Requesting Regarding Maintenance

- Utilize our maintenance services.

After purchasing the machines, contact your sales agent once per year or so to have the inside of the machines cleaned. Otherwise, dust will build up inside the machines and may cause fire or malfunction. Cleaning is particularly effective before humid rainy seasons.

- Our maintenance service performs the periodical checks and other work required to maintain the quality and performance of the machines, preventing accidents beforehand. For details, please consult your sales agent or maintenance and service agent.

- Using insecticides and other chemicals

Do not expose the machines to insecticides or other volatile solvents, as this will deteriorate the cabinet or other parts or cause the paint to peel.

● Cleaning

- When cleaning the machines, be sure to first unplug the power cord from the outlet for safety reasons.

- Do not use benzene or alcohol, etc., as these solvents will deteriorate the cover or cause the paint to peel. Leaving rubber or vinyl products in contact with the machines for long periods may leave stains on the machine surfaces.

- Cleaning the covers and keyboards: Wipe the covers and keyboards with a soft cloth. When using a chemically treated cloth, be sure to follow the precautions specified for it.

Cleaning the display units:

- Turn off the power and then wipe the display unit with a dry cloth. Do not rub or knock the display units with a hard object as they are easily damaged. Do not use thinner or other solvents.

- Use a neutral detergent diluted with water when the machines are particularly dirty.
 - 1) Soak a cloth in the detergent fluid and wring it out tightly. Then wipe off the dirt with the cloth.
 - 2) Finish by wiping the machines off with a dry cloth.

TABLE OF CONTENTS

	Page
1. INTRODUCTION.....	1
2. PRECAUTIONS.....	1
3. APPEARANCE AND NOMENCLATURE	2
4. OPERATING PROCEDURE	4
5. BARCODE READING	5
6. MAINTENANCE.....	7
7. TROUBLESHOOTING.....	8
8. SPECIFICATIONS.....	10
9. LASER SAFETY.....	11

1. INTRODUCTION

Thank you for purchasing the TEC LS-770 Laser Scanner.

This instruction manual provides a description of the functions and handling of the LS-770 and should be read carefully to ensure optimum performance. Since every consideration has been given safety and reliability, there is no danger of damaging the machine by incorrect operations.

Please read to this manual whenever you have questions concerning the LS-770. This scanner has been manufactured under strict quality control and should give you full satisfaction.

- The specification described in this manual may be modified by TEC, if necessary.
- Be sure to keep this manual on hand for future reference.

2. PRECAUTIONS

- (1) This scanner is a precision machine. Do not subject the scanner to sudden shocks.
- (2) Do not press the switches too strongly.
- (3) This scanner is designed in consideration of waterproofing. However, do not place the scanner where it will be splashed with water.
- (4) Clean the cover by wiping with a dry cloth or cloth soaked with detergent and wrung out thoroughly. Never use thinner or other volatile solvent for cleaning.
- (5) Avoid using the scanner where it would be subject to vibration or direct sunlight.
- (6) Be sure to install the scanner on a flat surface.
- (7) The scanner must be connected to a supply of the proper rated voltage.
- (8) Do not place the scanner where it will be subject to sudden temperature change or high humidity.
- (9) Do not plug or unplug the cables too strongly.
- (10) Do not place the scanner where it will be exposed to dust.
- (11) Do not touch the Scanner Window directly. Clean the Scanner Window periodically to prevent reading ability from lowering.

WARNING

Never attempt to perform maintenance activities which are not described in this manual.

3. APPEARANCE AND NOMENCLATURE

3.1 Appearance

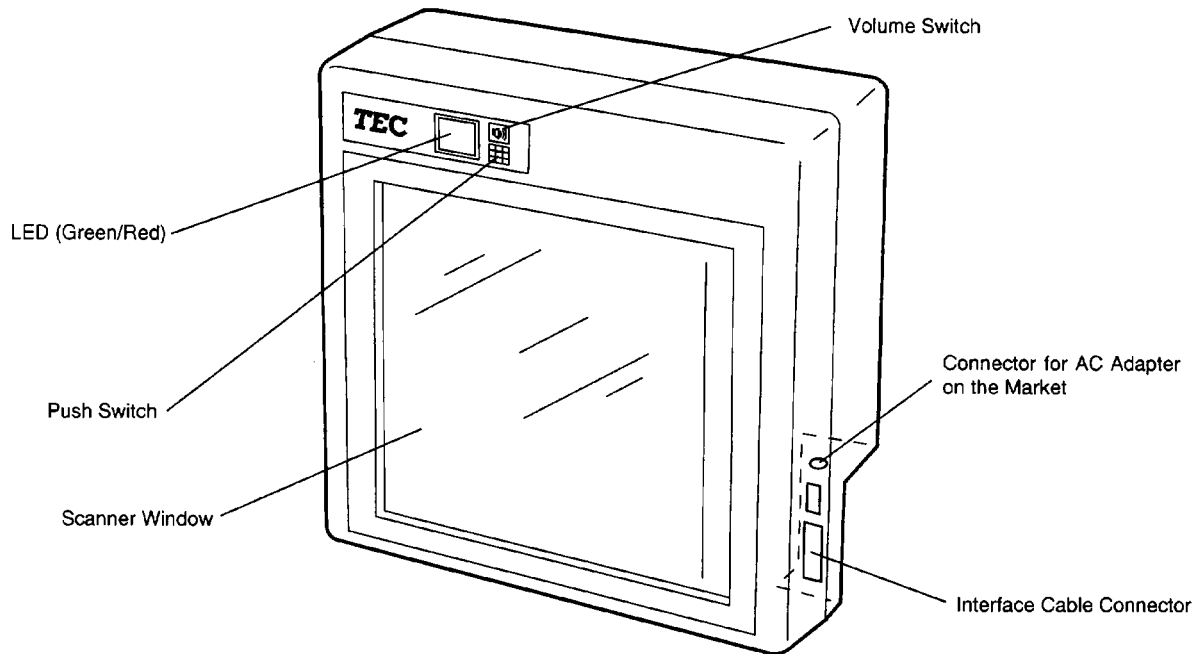

- | | |
|---|---|
| Scanner Window: | Read a barcode of an item.
(For barcode readable range, refer to 5. BARCODE READING.) |
| Connector for AC Adapter on the market: | Connects the AC Adapter on the market.
(Complying with EIAJ RC6705.) |
| Interface Cable Connector: | Connects the Interface Connector Cable (26-pin). OCIA type or RS-232C type can be selected according to the host (ECR/POS) specification. |

3.2 Switch Panel

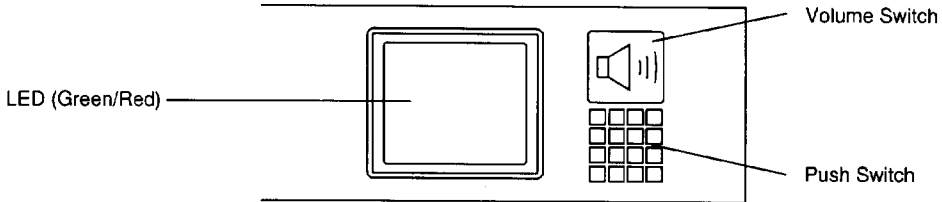

LED(Green/Red): Indicates scanner status using two-color LED (green and red).
(The red LED lights when the LS-770 is ready to read a barcode and the green LED lights when a barcode is read normally.)

Push Switch: Pressed to return the LS-770 to reading standby state in auto-power off mode.)

Volume Switch: Adjusts the buzzer volume of the LS-770. Each time the volume switch is pressed, the buzzer volume changes as follows:

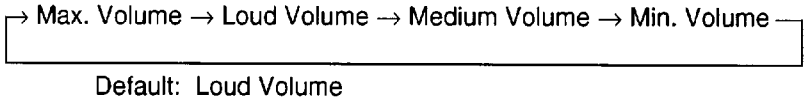

Each time the volume switch is pressed while pressing the push switch, the buzzer tone changes as follows:

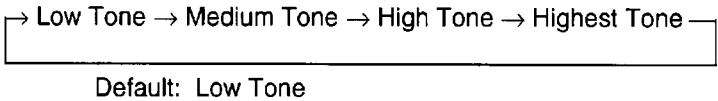

3.3 Accessory

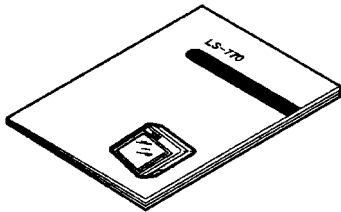

Owner's Manual (1 pc.)

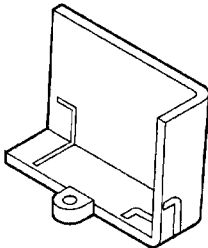

Connector Cover (1 pc.)



Double Sems Screw (1 pc.)

3.4 Optional Parts

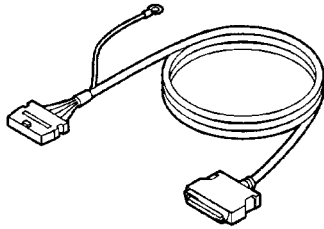

Interface Cable (OCIA)
Model Name: IFC-750-OC

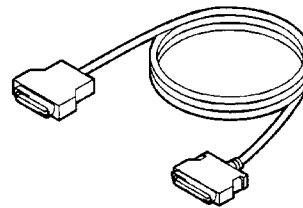

Interface Cable (RS-232C)
Model Name: IFC-750-RS-09F (26P-9P <Female>)
IFC-750-RS-25F (26P-25P <Female>)
IFC-750-RS-25M (26P-25P <Male>)

4. OPERATING PROCEDURE

Power Supply

(1) When the AC Adapter on the market is used:

When the AC adapter is equipped with the power switch, the scanner is turned on and off by turning on and off the power switch. When the AC Adapter is not equipped with the power switch, the power is supplied by plugging in the power cord (no RPC function can be used).

(2) When the power is supplied from the host (ECR/POS):

The power can be supplied via the interface cable. If the host can control power supply to the scanner, the host turns the scanner on and off.

Auto-Power Off Function

To save electricity, this scanner has a function that laser and the motor are automatically turned off when the scanner does not read barcodes for a prescribed time. At auto-power off time, the LS-770 enters reading standby state by pressing the Push Switch. Since the laser and motor are turned on when the merchandise detect sensor detects something, the LS-770 also enters reading standby state when anything like a hand is put above the Scanner Window

5. BARCODE READING

The LS-770 reads barcode in the following range.

5.1 Scanning Direction

The scanning pattern generated by an optical head unit is designed to achieve the best reading performance when an article is scanned as illustrated below.

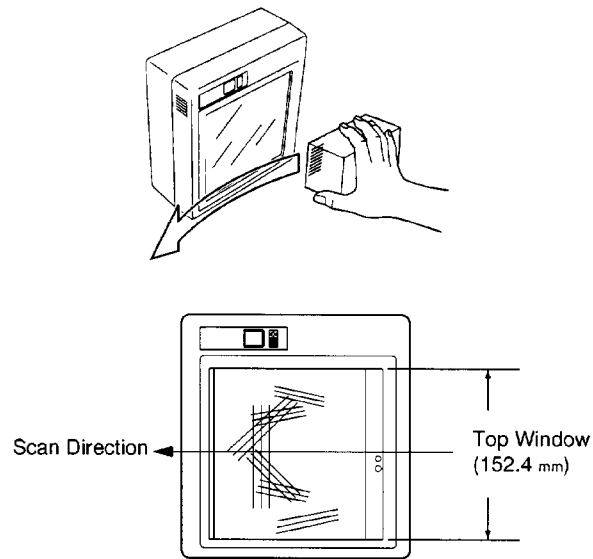

<LS-770 seen from the above>

5.2 Effective Scanning Zone

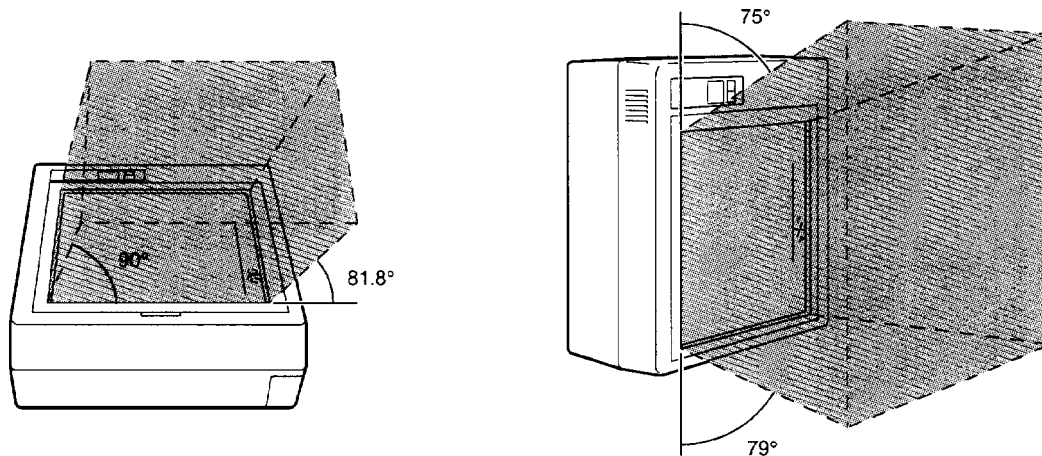

5.3 How to Read

Target the center of the Scanner Window so that the scanner can read a barcode of an item in the range at 50 mm to 200 mm above from the Scanner Window surface.

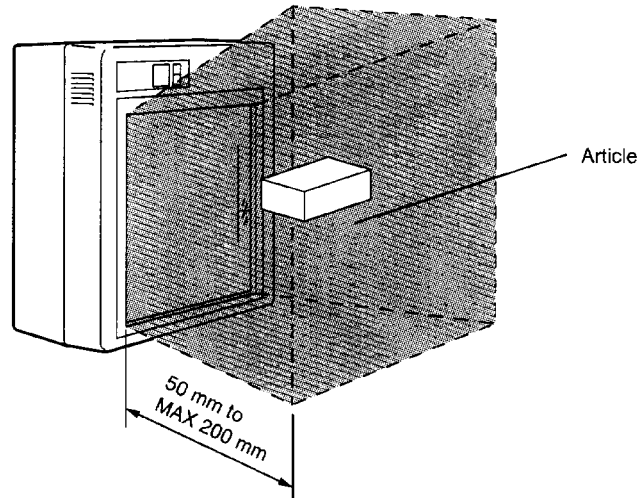

<LS-770 seen from the front>

CAUTION

1. Do not contact the item and the Scanner Window.
2. Moving the item perpendicularly to the Scanner Window makes it difficult to read the barcode.

Readable Barcode: EAN/JAN-13, EAN/JAN-8, UPC-A and UPC-E, UPC-D1 to D4,
EAN-13/8 and UPC-A/E with Supplemental 2 or 5 digits,
ITF (Interleaved 2 of 5), NW7 (CODABAR), CODE39, CODE93, CODE128

6. MAINTENANCE

To maintain reading precision above the prescribed level, keep the Scanner Window clean. To clean the Top Window, use a soft cloth. Remove the Top Window as shown in the figure below, and wipe the Top Window softly using a dry soft cloth. When the Top Window is badly soiled, use a cloth after moistening it with water and wringing water from it. Then wipe the Top Window again using a dry cloth. Clean the Under Window in the same manner. Be careful not to damage the Under Window, since it is made of acrylic and easily damaged.

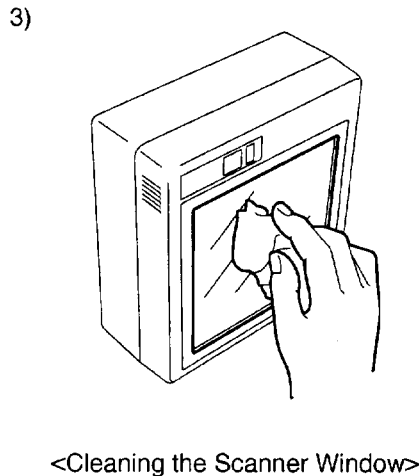
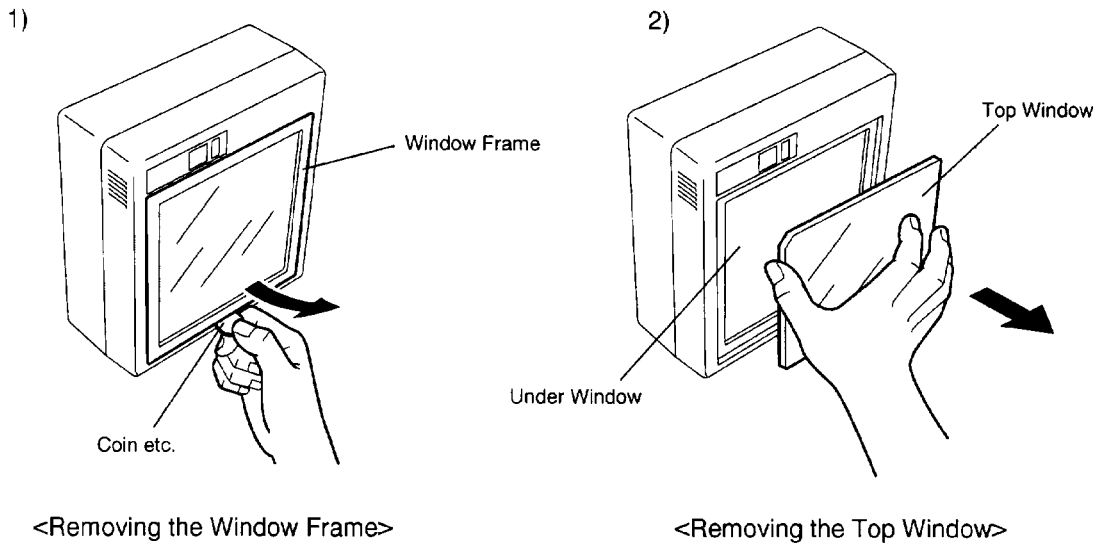

- Reassemble the Top Window so that the window cut part will be placed on the convex part of the Top Window Holder.

7. TROUBLESHOOTING

- When an error is detected at the power ON...

This scanner has the self-diagnosis function to detect an internal error when the power is turned ON. If an error is found at this time, the scanner informs you of error occurrence by the LED and the buzzer. Number of the LED flickering and the buzzer beep is predetermined according to the error contents as shown below. The error indication is repeated at the one second interval until the power of the scanner is turned OFF. In case of the error occurrence, inform your TEC representative of the error status.

Error Indication		Error Contents
Red LED	Buzzer	
Flickers once.	Single Tone once	ROM Error
Flickers twice.	Single Tone twice	RAM Error
Flickers three times.	Single Tone three times	EEPROM Error
Flickers four times.	Single Tone four times	Decoder IC Error
Flickers five times.	Single Tone five times	Motor Error
Flickers six times.	Single Tone six times	Laser Error

- When an error is detected during the normal operation...

This scanner also detects an internal error during the normal operation. If an error is found during the normal operation, the scanner informs you of error occurrence by the LED and the buzzer. Number of the LED flickering and the buzzer beep is predetermined according to the error contents as shown below. The error indication is repeated at the one second interval until the power of the scanner is turned OFF. In case of the error occurrence, inform your TEC representative of the error status.

Error Indication		Error Contents
Red LED	Buzzer	
Flickers three times.	Single Tone three times	EEPROM Error
Flickers five times.	Single Tone five times	Motor Error
Flickers six times.	Single Tone six times	Laser Error

- When the power of the scanner is not turned ON...

Cause	Action
• The power plug of the AC adapter is not inserted, or is not securely inserted.	• Insert the power plug into the power outlet securely.
• The power is not supplied to the power outlet.	• Check the power supply using another electrical appliance.
• The connector of the interface cable has been detached in case of the scanner of which power is controlled from the host terminal.	• Attach the connector securely.
• The power of the host terminal is OFF in case of the scanner of which power is controlled from the host terminal.	• Turn the power of the host terminal ON.

When a trouble still exists after taking the actions described above, ask your TEC representative.

- When the scanner cannot read a barcode...

Cause	Action
• The top window of the scanner is dirty or dewed.	• Clean the top window.
• Barcode system does not correspond to the scanner specification.	• Reading a barcode is unavailable. Use the barcode system corresponding to the scanner specification.
• Barcode has a defect. (Print of a barcode is too light, dirty, blurred, or defaced.)	• Reading a barcode is unavailable. Read a perfect barcode attached to the same article. Enter the barcode of the article manually by the keyboard. (However, depending on the function of the host terminal.)
• Angle to read a barcode is not appropriate.	• Read the barcode at the appropriate angle. (Refer to page 5 in details.)
• Barcode to be read is too near to the top window or too far from the top window.	• Read the barcode in the effective scanning zone. (Refer to pages 5 and 6.)

When a trouble still exists after taking the actions described above, ask your TEC representative.

- When the scanned data is not transferred to the host terminal...

Cause	Action
• The connector of the interface cable has been detached.	• Attach the connector securely.

When a trouble still exists after taking the action described above, ask your TEC representative.

8. SPECIFICATIONS

8.1 Scanner Main Body

Dimensions: 200 (W) x 90 (D) x 220 (H) mm (Vertical standing dimensions)

Weight: 1.5 kg

Readable code: EAN/JAN-13, EAN/JAN-8, UPC-A, UPC-E, UPC-D1 to D4, EAN-13/8 and UPC-A/E with Supplemental 2 or 5 digits, ITF (Interleaved 2 of 5), NW7 (CODABAR), CODE39, CODE93, CODE128

Interface: OCIA or RS-232C

Reading Height: Up to 200 mm above from the Scanner Window surface

Input Power: 12 VDC \pm 10%

8.2 Interface Cable (Option)

Cable Length: 5.0 m

9. LASER SAFETY

■ Maintenance and Safety

1. Caution—use of controls or adjustments or performance of procedures other than those specified herein may result in hazardous radiation exposure.
2. The use of optical instruments including a magnifying glass with this product will increase eye hazard.
3. Avoid viewing direct laser beam for a long time.

■ Radiant Energy

The LS-770 is an IEC Class 1 and CDRH Class 'Ka laser product. The system uses an embedded Class 'Lb VLD (Visible Laser Diode) operating at 670 nm, in an optomechanical scanner, resulting in less than 1.5 microwatts radiated power observed through 1000 seconds. Maximum peak output power is 540 microwatts.

■ Label

- The following labels are placed on the back side of the LS-770.

<US Type>

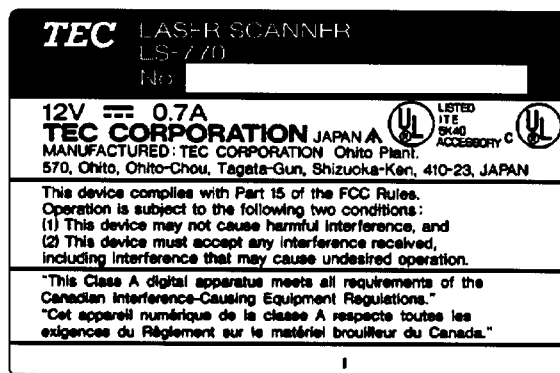

<QM Type>

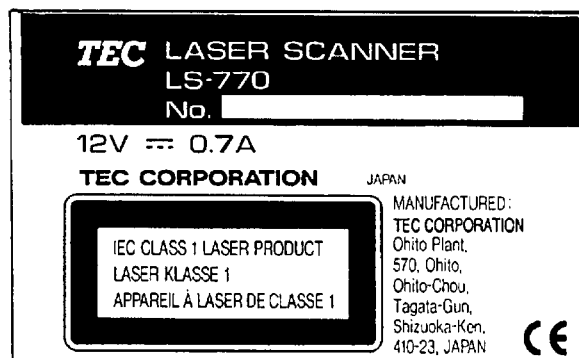

- The following label is placed inside the body of the LS-770.
<US Type>

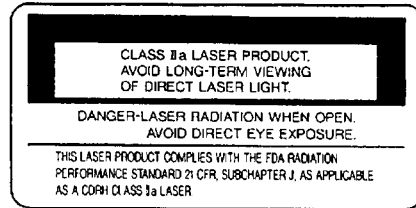



TEC
TEC CORPORATION