

S P T 1 7 0 0 S e r i e s



symbol[®]



© 1999 - 2001 SYMBOL TECHNOLOGIES, INC. All rights reserved.

Symbol reserves the right to make changes to any product to improve reliability, function, or design.

Symbol does not assume any product liability arising out of, or in connection with, the application or use of any product, circuit, or application described herein.

No license is granted, either expressly or by implication, estoppel, or otherwise under any patent right or patent, covering or relating to any combination, system, apparatus, machine, material, method, or process in which Symbol products might be used. An implied license only exists for equipment, circuits, and subsystems contained in Symbol products.

Symbol and the Symbol logo are registered trademarks of Symbol Technologies, Inc. Other product names mentioned in this manual may be trademarks or registered trademarks of their respective companies and are hereby acknowledged.

Symbol Technologies, Inc.
One Symbol Plaza
Holtsville, N.Y. 11742-1300
<http://www.symbol.com>

Patents

This product is covered by one or more of the following U.S. and foreign Patents:

U.S. Patent No. 4,460,120; 4,496,831; 4,593,186; 4,603,262; 4,607,156; 4,652,750; 4,673,805; 4,736,095; 4,758,717; 4,816,660; 4,845,350; 4,896,026; 4,897,532; 4,923,281; 4,933,538; 4,992,717; 5,015,833; 5,017,765; 5,021,641; 5,029,183; 5,047,617; 5,103,461; 5,113,445; 5,130,520; 5,140,144; 5,142,550; 5,149,950; 5,157,687; 5,168,148; 5,168,149; 5,180,904; 5,216,232; 5,229,591; 5,230,088; 5,235,167; 5,243,655; 5,247,162; 5,250,791; 5,250,792; 5,260,553; 5,262,627; 5,262,628; 5,266,787; 5,278,398; 5,280,162; 5,280,163; 5,280,164; 5,280,498; 5,304,786; 5,304,788; 5,306,900; 5,321,246; 5,324,924; 5,337,361; 5,367,151; 5,373,148; 5,378,882; 5,396,053; 5,396,055; 5,399,846; 5,408,081; 5,410,139; 5,410,140; 5,412,198; 5,418,812; 5,420,411; 5,436,440; 5,444,231; 5,449,891; 5,449,893; 5,468,949; 5,471,042; 5,478,998; 5,479,000; 5,479,002; 5,479,441; 5,504,322; 5,519,577; 5,528,621; 5,532,469; 5,543,610; 5,545,889; 5,552,592; 5,557,093; 5,578,810; 5,581,070; 5,589,679; 5,589,680; 5,608,202; 5,612,531; 5,619,028; 5,627,359; 5,637,852; 5,664,229; 5,668,803; 5,675,139; 5,693,929; 5,698,835; 5,705,800; 5,714,746; 5,723,851; 5,734,152; 5,734,153; 5,742,043; 5,745,794; 5,754,587; 5,762,516; 5,763,863; 5,767,500; 5,789,728; 5,789,731; 5,808,287; 5,811,785; 5,811,787; 5,815,811; 5,821,519; 5,821,520; 5,823,812; 5,828,050; 5,850,078; 5,861,615; 5,874,720; 5,875,415; 5,900,617; 5,902,989; 5,907,146; 5,912,450; 5,914,478; 5,917,173; 5,920,059; 5,923,025; 5,929,420; 5,945,658; 5,945,659; 5,946,194; 5,959,285; 6,002,918; 6,021,947; 6,047,892; 6,050,491; 6,053,413; 6,056,200; 6,065,678; 6,067,297; 6,068,190; 6,082,621; 6,084,528; 6,088,482; 6,092,725; 6,101,483; 6,102,293; 6,104,620; 6,114,712; 6,115,678; 6,119,944; 6,123,265; 6,131,814; 6,138,180; 6,142,379; D305,885; D341,584; D344,501; D359,483; D362,453; D363,700; D363,918; D370,478; D383,124; D391,250; D405,077; D406,581; D414,171; D414,172; D418,500; D419,548; D423,468; D424,035 D431,158; D430,159; D431,562.

Invention No. 55,358; 62,539; 69,060; 69,187 (Taiwan); No. 1,601,796; 1,907,875; 1,955,269 (Japan).

European Patent 367,299; 414,281; 367,300; 367,298; UK 2,072,832; France 81/03938; Italy 1,138,713.

rev. 09/00

Introduction

Congratulations on your purchase of Symbol Technologies' SPT 1700 Series Terminal! The unique combination of pocket size, Personal Information Management software, RF communication via Symbol's Spectrum24® wireless network (SPT 174X) or wide area network (SPT 173X), printing support and 1- and 2-dimensional scanning capability make this product superior for use in a wide range of applications.

About This Guide

This guide covers the procedures for the basic set up and use of the terminal. Specific topics covered include:

- *Parts of the SPT 1700* on page 2
- *Getting Started with the SPT 1700* on page 4
- *Charging the Battery* on page 4
- *Installing the Battery* on page 4
- *Starting the SPT 1700* on page 6
- *Using the SPT 1700* on page 8
- *Using the Contrast Control* on page 8
- *Writing with the Stylus* on page 8
- *Icon Descriptions* on page 10
- *Scanning 1-D Bar Codes with the SPT 1700* on page 12
- *Scanning PDF417 (2-D) Bar Codes* on page 13
- *Initiate A Network Connection* on page 14
- *Resetting Your SPT 1700 Terminal* on page 10
- *Maintaining the SPT 1700* on page 14
- *Troubleshooting* on page 15
- *Service Information* on page backcover.

The *SPT 1700 Product Reference Guide* (p/n 70-37544-xx), available from Symbol or your Reseller, details the applications available on the SPT 1700.

Parts of the SPT 1700

The following illustration indicates each part of the SPT 1700 Terminal.

Front View

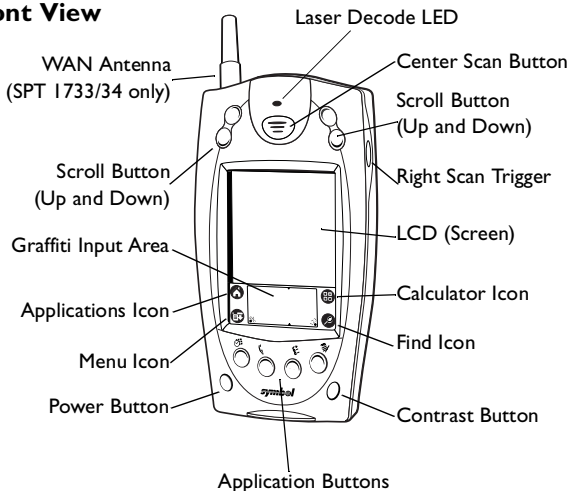

Left View

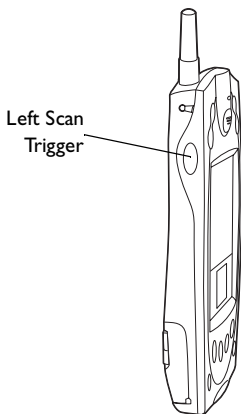

Q u i c k R e f e r e n c e

Parts of the SPT 1700 (continued)

Back View

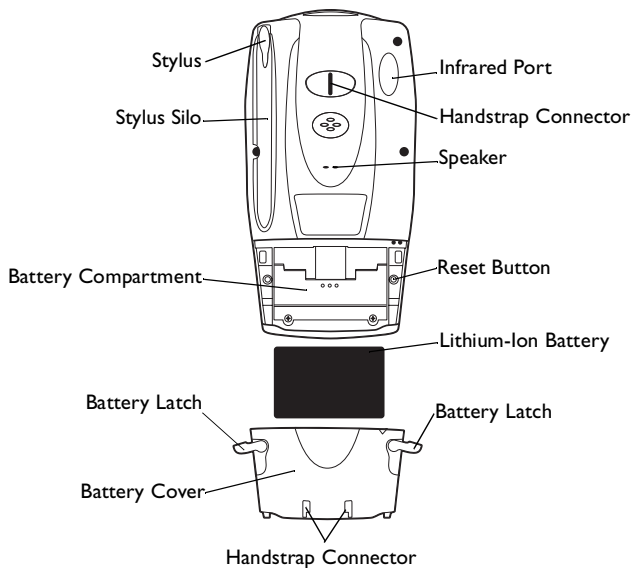

Top View

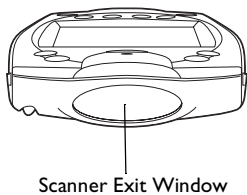

Bottom View

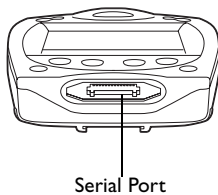

Getting Started with the SPT 1700

Before you can use your SPT 1700, perform the basic set up procedures covered on the following pages. Specifically:

- Charge and Install the Battery
- Start the SPT 1700
- Initiate the network connection (SPT 174X/173X only).

Installing the Battery

To install the battery in your SPT 1700:

1. Open the latches on the battery cover and lift it away from the SPT 1700.
2. Insert the lithium-ion battery in the battery compartment, making sure it snaps into place.
3. Replace the battery cover and re-secure the latches.

Note: Be careful to position the battery latches completely open while securing the battery cover.

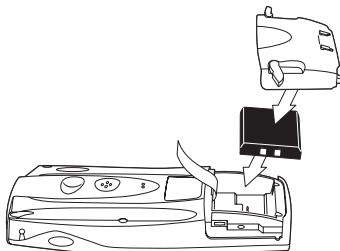
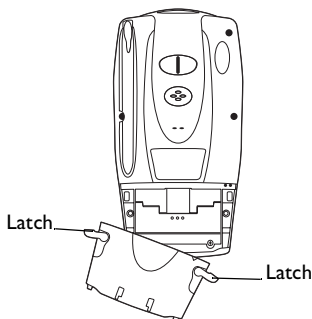

Charging the Battery

Before using your SPT 1700 for the first time, charge the lithium-ion battery using the Cradle, the Synchronization/Charging Cable, or the Universal Battery Charger (UBC). For instructions on using the UBC, see the UBC Quick Reference Guide. Follow these same procedures to recharge the battery.

Q u i c k R e f e r e n c e

Note: The SPT 1700 battery (p/n 20-36098-01) must be used only with the SPT 1700 series terminal.

Using the Cradle to Charge the Battery

To charge the terminal's battery using the cradle:

1. Make sure the battery is installed in the terminal.
2. Plug the cradle into a wall outlet.
3. Insert the SPT 1700 terminal in the cradle:

The terminal's battery is fully charged after approximately two hours. You can also charge a terminal's spare battery by inserting it in the spare battery charging slot on the back of the cradle. The spare battery fully charges in approximately two hours. See the *CRD 1700 Cradle Quick Reference Guide* for more information.

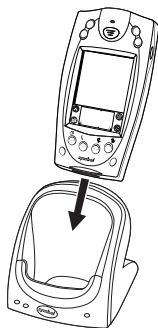

Using the Synchronization/Charging Cable to Charge the Battery

To charge the terminal's battery using the Synchronization/Charging Cable:

1. Make sure the battery is installed in the terminal.
2. Insert the cable into the bottom of the terminal.
3. Plug the power cable into a wall outlet and plug the other end

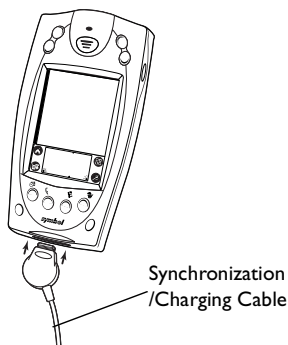

SPT 1700 Series

into the battery charging receptacle on the side of the Synchronization/Charging Cable.

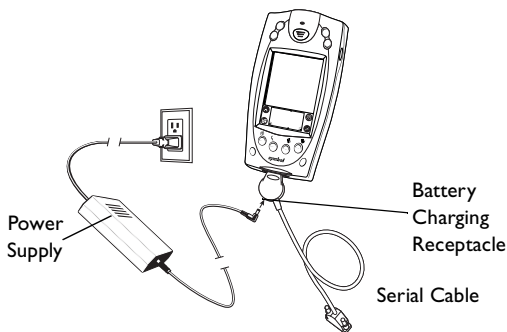

The battery is fully charged after approximately two hours.

Starting the SPT 1700

Press the red power button to start the terminal. If the terminal does not power on, perform a hard reset. See [page 11](#).

Calibrating the Screen

The first time you start your SPT 1700, the Welcome utility appears. Follow the steps to align the internal circuitry of your SPT 1700 with its touch-sensitive screen, the current time and date.

Note: If your SPT 1700 unit came pre-loaded with a custom software application, you may not need to calibrate your screen, in which case you will not see the Welcome utility.

Q u i c k R e f e r e n c e

1. Press the power button on the front panel of your SPT 1700 to display the Welcome utility. (This also displays following a hard reset).

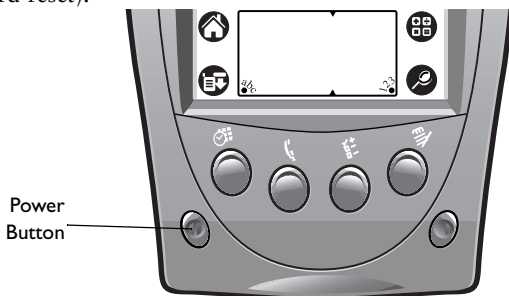

Note: If necessary, adjust the contrast control on the SPT 1700 so the screen is clear and readable. See *Using the Contrast Control* on page 8 for instructions.

2. Follow the instructions on the screen.
3. Tap the exact center of each target that appears on the screen with the tip of the stylus.

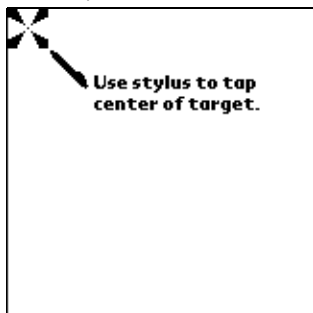

If, at any time, you need to recalibrate the screen, open the Preferences application, tap on the top right corner of the screen, and select the digitizer option from the pull down menu.



Using the SPT 1700

Using the Power Button/Backlight Control

The power button turns the SPT 1700 on and off. This button also serves as your backlight control for low-light conditions. With the unit on, press and hold the power button for approximately 2 seconds to turn the backlight on and off. When the backlight is on, the screen text displays in reverse video.

Using the Contrast Control

The contrast control button is located on the lower right-hand side of the terminal.

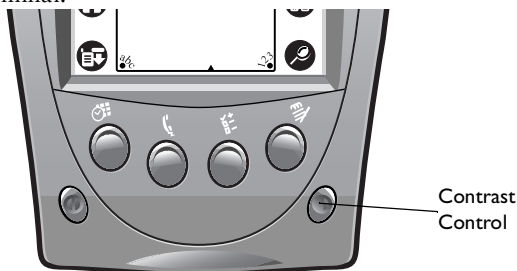

To adjust the contrast:

1. Press the contrast control button, which displays the contrast adjusting bar on the terminal's screen.
2. Using your stylus, adjust the contrast by scrolling the contrast bar until the contrast is set to the desired level, or use either of the scroll buttons on the top of the terminal to adjust the contrast level.
3. Press the contrast control button or tap Done on the terminal screen to turn off the contrast control.

Writing with the Stylus

Your SPT 1700 includes Graffiti handwriting software for entering text and numbers. Graffiti translates stylus strokes into letters or

numbers. See the *SPT 1700 Product Reference Guide*, p/n 70-37544-xx for more information.

Using the Onscreen Keyboard

You can activate the on-screen keyboard any time you need to enter text or numbers on your SPT 1700. Note that you cannot enter Graffiti characters while using the on-screen keyboard.

To use the on-screen keyboard:



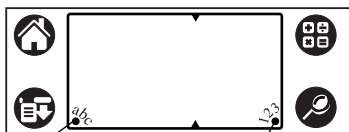

1. Open any SPT 1700 application.
2. Tap any record name, or tap the New button with the tip of the stylus.
3. Tap the left target to open the Alpha keyboard, or tap the right target to open the Numeric keyboard.



Tap here for letters
keyboard

Tap here for numbers
keyboard

Icon Descriptions

<p>Applications Icon</p> 	Exits the current application and lists available applications for selection.
<p>Calculator Icon</p> 	Displays the calculator application.
<p>Menu Icon</p> 	Tap from within an application to display the options menu for the application.
<p>Find Icon</p> 	Tap from within an application to enter search criteria to find an entry.

Resetting Your SPT 1700 Terminal

If your SPT 1700 stops responding to input, you may need to perform a reset.

Performing a Soft Reset

A soft reset restarts the terminal and saves all records and entries stored in your SPT 1700 terminal. After a soft reset, the Palm Computing Platform Logo screen appears followed by the General Preferences screen.

To perform a soft reset, remove the battery cover and gently press the reset button, which is located under the battery cover.

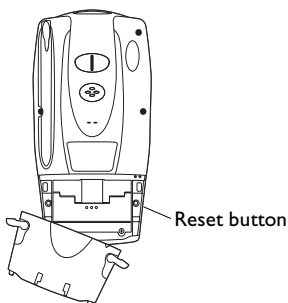

Performing a Hard Reset

A hard reset also restarts your terminal, but erases all records and entries stored in your SPT 1700 terminal. *Therefore, never perform a hard reset unless a soft reset does not solve your problem.*

Note: You can restore any data previously synchronized with your computer during the next HotSync operation.

To perform a hard reset:

1. Remove the battery cover.
2. Hold down the power button on the front of the SPT 1700 terminal, and gently press the reset button on the back of the terminal.
3. Release the reset button, then the power button.
4. When a message appears on the SPT 1700 terminal screen warning that you are about to erase all the data stored on your SPT 1700 terminal, do one of the following:
 - a. Press the upper half of the scroll button on the front of the SPT 1700 terminal to complete the hard reset and display the Digitizer screen.
 - b. Press any other button to perform a soft reset.

Note: With a hard reset, the current date and time are retained. Formats Preferences and other settings are restored to their factory default settings.



Attaching the Handstrap

The SPT 1700 has an optional handstrap which increases comfort when holding the terminal for extended periods of time. To attach the handstrap to the back of the terminal:

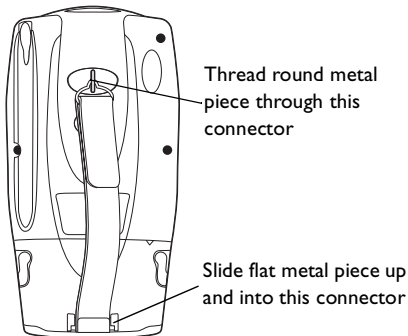

1. Thread the round metal piece through the metal handstrap connection.
2. Slide the flat metal piece into the handstrap connection on the bottom of the terminal.
3. Adjust the velcro® strap to fit your hand.

Scanning I-D Bar Codes with the SPT 1700

The SPT 1700 has an integrated laser bar code scanner which, if your unit has been configured to use scanning input, allows you to collect data by scanning bar codes.

To scan bar codes with the SPT 1700:

1. Start your scanning application.
2. Aim the scanner at the bar code.
3. Press either the right, left or center scan trigger. Make sure the red scan beam covers the entire bar code. The green scan LED lights and a beep sounds to indicate a successful decode.

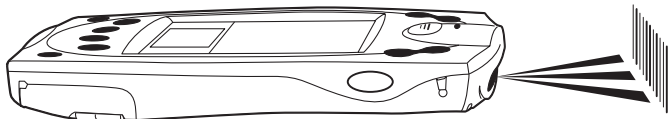

Scanning PDF417 (2-D) Bar Codes

To scan a PDF417 bar code (with a 2-D configured terminal):

1. Aim the scanner at the PDF bar code and press the trigger.
2. Hold the trigger down and keep the scan line parallel to the rows of the symbol.
3. Manually raster the scan line by slowly moving the scanner up and down so it scans the entire bar code at a rate of one inch per second.

A clicking noise lets you know the 2-D bar code is being decoded. If there is no clicking noise when you're scanning the bar code, it's not being scanned properly.

When decoding a very long 2-D bar code, you may notice a slight delay between the time when the terminal completes the decode and the time when the data is displayed on the screen. The first beep you hear indicates a successful decode. The second beep you hear indicates the data has been received by the host. Do not attempt to decode another bar code until you hear the second beep and see the green LED indicating successful decode.

To improve PDF decoding:

- Check that PDF417 scanning is enabled.
- Make sure the scan line extends at least 1/2" past the left and right edges of the bar code.
- Hold the scanner closer for denser symbols, farther away for larger symbols.
- Make sure you scan the top and bottom rows of the symbol.
- Be patient - it may take a few swipes to decode the symbol.



The bar code has been completely decoded when you hear a tone, followed by a short, high tone beep. The green LED stays lit for two seconds or until the next trigger pull.



Initiate A Network Connection

Before using the terminal, set up the Spectrum24, CDPD (Cellular Digital Packet Data) or GSM (Global System for Mobile Communication) network connection. Refer to the *SPT 1700 Series Product Reference Guide*, p/n 70-37544-xx for setup instructions.

A small cursor blinks at the top right-hand corner of the screen when the terminal activates a radio connection (Spectrum24, CDPD or GSM). If you are not connected to the radio, the cursor does not appear.

Maintaining the SPT 1700

For trouble-free service, observe the following tips when using your SPT 1700:

- Do not scratch the screen. Use the supplied stylus or plastic-tipped pens intended for use with a touch-sensitive screen. Never use a pen or pencil or other sharp object on the screen.
- Although your SPT 1700 is water and dust resistant, do not expose it to rain or moisture for an extended period. Treat your SPT 1700 as you would a pocket calculator or other small electronic instrument.
- The touch-sensitive screen of your SPT 1700 contains glass. Do not drop your SPT 1700 or subject it to strong impact.
- Protect your SPT 1700 from temperature extremes. Do not leave it on the dashboard of a car on a hot day, and keep it away from heaters and other heat sources.

Q u i c k R e f e r e n c e

- Do not store or use your SPT 1700 in any location that is extremely dusty, damp or wet.
- If the surface of the SPT 1700 screen becomes soiled, clean it with a soft lens cloth moistened with a diluted window-cleaning solution.

Troubleshooting

SPT 1700 terminal does not turn on:

- Adjust the contrast control.
- Make sure the battery is fully charged and installed properly.
- Replace the battery. If your SPT 1700 terminal still does not operate, try a soft reset; see *Resetting Your SPT 1700*.

Low battery warning after replacing the battery:

- The battery warning message may appear immediately after replacing the battery. In addition, if you check the battery gauge in the Applications Launcher *immediately* after replacing the battery, the gauge may start at “empty” and slowly rise to “full.” This is normal. It takes a minute for the battery gauge to accurately show the condition of the battery.

No sound:

- Check the Sound options in the General Preferences screen. If the option is set to off, there will be no sound. See the *SPT 1700 Product Reference Guide* for more information.

SPT 1700 terminal turns itself off:

- Your SPT 1700 terminal is designed to turn itself off after a period of inactivity. This period can be set at thirty seconds, one minute, two minutes or three minutes. Check the “Auto-off after” setting in the General Preferences screen, and change the setting if you need a longer delay before the automatic shutoff feature activates. See the *SPT 1700 Product Reference Guide* for more information. The terminal also turns itself off when the battery power is extremely low.

SPT 1700 terminal doesn't recognize my handwriting:

- For your SPT 1700 to recognize handwriting input with the stylus, you need to use the Graffiti® character strokes. See the *SPT 1700 Product Reference Guide* for information about how to write Graffiti character strokes.
- Make the Graffiti character strokes in the Graffiti writing area — not on the display part of the screen.
- Make sure you are writing the strokes for letters in the left-hand side, and the strokes for numbers in the right-hand side of the Graffiti writing area.
- Make sure that Graffiti is not shifted into extended or punctuation modes. See the *SPT 1700 Product Reference Guide* for information about shifting into and out of punctuation modes.

Tapping the screen buttons or icons does not activate the corresponding feature:

- Recalibrate the digitizer. Choose Digitizer from the Preferences application pick list and follow the directions on the screen.

When I tap the  icon, nothing happens:

- Not all applications or screens have menus. Try changing to a different application.

Beamed data does not transmit:

- Confirm that the SPT 1700 terminals are 5” apart, the receiver has its IrDA capability enabled, and that the path between the two devices is clear of obstacles.

Note: You cannot overwrite a .prc file via IrDA if it is locked.

When receiving beamed data an out of memory message appears:

- Your SPT 1700 terminal requires at least twice the amount of memory available as the data you are receiving. For example,

Q u i c k R e f e r e n c e

if you are receiving a 30K application, you must have at least 60K free.

Your SPT 1700 unit does not accept scan input:

- Verify that the unit is loaded with a scanning application. See your System Administrator.
- Check to be sure the bar code symbol is not defaced.
- Be sure you are within proper scanning range.
- Be sure the unit is programmed to accept the type of bar code you are scanning.
- If you are expecting a beep on a good decode and don't hear one, check that the application is set to generate a beep on good decode.
- If the scanner stops emitting a laser beam when you press the trigger, check your battery level. When the battery is low, the scanner shuts off before the terminal notifies you of the low battery condition.

Note: If, after performing these checks, the scanner is still not reading symbols, contact your distributor or Symbol Technologies.

Ergonomic Recommendations

Caution: In order to avoid or minimize the potential risk of ergonomic injury follow the recommendations below. Consult with your local Health & Safety Manager to ensure that you are meeting with your company's safety programs to prevent employee injury.

- Reduce or eliminate repetitive motion
- Maintain a natural position
- Reduce or eliminate excessive force
- Keep objects that are used frequently within easy reach
- Perform tasks at correct heights
- Reduce or eliminate vibration
- Reduce or eliminate direct pressure
- Provide adjustable workstations
- Provide adequate clearance
- Provide a suitable working environment
- Improve work procedures.



Regulatory Information

Radio Frequency Interference Requirements

This device has been tested and found to comply with the limits for a Class B digital device pursuant to Part 15 of the Federal Communications Commissions Rules and Regulation. These limits are designed to provide reasonable protection against harmful interference when the equipment is operated in a commercial environment. This equipment generates, uses, and can radiate radio frequency energy and, if not installed and used in accordance with the instruction manual, may cause harmful interference to radio communications. Operation of this equipment in a residential area is likely to cause harmful interference in which case the user will be required to correct the interference at his own expense.

However, there is no guarantee that interference will not occur in a particular installation. If the equipment does cause harmful interference to radio or television reception, which can be determined by turning the equipment off and on, the user is encouraged to try to correct the interference by one or more of the following measures:

- Re-orient or relocate the receiving antenna.
- Increase the separation between the equipment and receiver.
- Connect the equipment into an outlet on a circuit different from that which the receiver is connected.
- Consult the dealer or an experienced radio/TV technician for help.

This device complies with FCC Part 15. Operation is subject to the following two conditions: (1) this device may not cause harmful interference and (2) this device must accept any interference received, including interference that may cause undesired operation.



Important Note: To comply with FCC and Industry Canada RF exposure requirements, this hand-held device is approved for operation in a user's hand when there is 20 cm or more between the antenna and the user's body.

Radio Frequency Interference Requirements - Canada

This Class B digital apparatus meets the requirements of the Canadian Interference-Causing Equipment Regulations.

Cet appareil numérique de la Classe B respecte toutes les exigences du Règlement sur le Matériel Brouilleur du Canada.

CE Marking and European Union Compliance



Products intended for sale within the European Union are marked with the CE Mark which indicates compliance to applicable Directives and European Normes (EN), as follows. Amendments to these Directives or ENs are included:

Applicable Directives

- Electromagnetic Compatibility Directive 89/336/EEC
- Low Voltage Directive 73/23/EEC

Applicable Standards

- EN 55022:1998, Limits and Methods of Measurement of Radio Disturbance Characteristics of Information Technology Equipment
- EN 55024:1998; Information Technology equipment - Immunity characteristics - Limits and methods of measurement
- IEC 1000-4-2:1995; Electromagnetic compatibility (EMC); Part 4:Testing and measurement techniques; Section 4.2:Electrostatic discharge immunity test
- IEC 1000-4-3:1997; Electromagnetic Compatibility (EMC); Part 4:Testing and measurement techniques; Section 3. Radiated, radio frequency, electromagnetic field immunity test.
- IEC 1000-4-4:1995; Electromagnetic compatibility (EMC); Part 4:Testing and measurement techniques; Section 4:Testing electrical fast transient,/Burst immunity.
- IEC1000-4-5:1995; Electromagnetic compatibility (EMC), Part 4:Testing and measurement techniques; Section 5: Surge Immunity
- IEC 1000-4-6:1996; Electromagnetic compatibility (EMC), Part 4:Testing and measurement techniques; Section 6: Immunity to conducted disturbances, induced by radio frequency fields.
- IEC 1000-4-11:1994; Electromagnetic compatibility (EMC), Part 4:Testing and measurement techniques; Section 11: Voltage Dips, Short Interruptions, and Voltage Variations.
- EN 60 950 + A1+A2+A3+A4+A11 - Safety of Information Technology Equipment Including Electrical Business Equipment
- EN 60 825-1 (EN 60 825) - Safety of Devices Containing Lasers



RF Devices

Symbol's RF products are designed to be compliant with the rules and regulations in the locations into which they are sold and will be labeled as required. The majority of Symbol's RF devices are type approved and do not require the user to obtain license or authorization before using the equipment. Any changes or modifications to Symbol Technologies equipment not expressly approved by Symbol Technologies could void the user's authority to operate the equipment.

The Spectrum24 equipment is intended for use throughout the European Economic Area, but its authorization for use in France is restricted as follows:

- PAN European Frequency Range: 2.400 - 2.4835 GHz, identified by -EU suffix to the model number found on the product label.
- **France** - Restrict Frequency Range for use in France: 2.447 - 2.453 GHz, identified on SPT 1742 by the -FR suffix to the model number found on the product label.
- **Belgium** - Operation in an out of doors environment in Belgium must be restricted to 2460 - 2483.5 MHz band.
- **Italy** - Operation in Italy requires a user license.

WARNING: FCC RF EXPOSURE GUIDELINES

To satisfy FCC RF exposure compliance requirements for a portable transmitting device, this device should be used in hand-held, hand-operated configurations only. The device and its antenna should generally maintain a separation distance of 20 cm or more from a person's body; except for the hands and wrists because of higher exposure limit for extremities. This device is designed to be used in a person's hands and its operating configurations, generally do not support normal transmissions while it is carried in pockets or holsters next to a person's body.

Caution: RF Devices

Symbol's RF products are designed to be compliant with the rules and regulations in the locations into which they are sold and will be labeled as required. The majority of Symbol's RF devices are type approved and do not require the user to obtain license or authorization before using the equipment. Any changes or modifications to Symbol Technologies' equipment not expressly approved by Symbol Technologies could void the user's authority to operate the equipment.

Battery Caution

Caution: Danger of explosion if battery is incorrectly replaced. Replace only with the same or equivalent type recommended by the manufacturer. Dispose of used batteries according to the manufacturer's instructions.

Laser Devices

Symbol products using lasers comply with US 21CFR1040.10, and IEC825/EN60825. The laser classification is marked on one of the labels on the product.

Class 1 Laser devices are not considered to be hazardous when used for their intended purpose. The following statement is required to comply with US and international regulations:

Caution: Use of controls, adjustments or performance of procedures other than those specified herein may result in hazardous laser light exposure.

Class 2 laser scanners use a low power, visible light diode. As with any very bright light source, such as the sun, the user should avoid staring directly into the light beam. Momentary exposure to a Class 2 laser is not known to be harmful.

Scanner Labeling

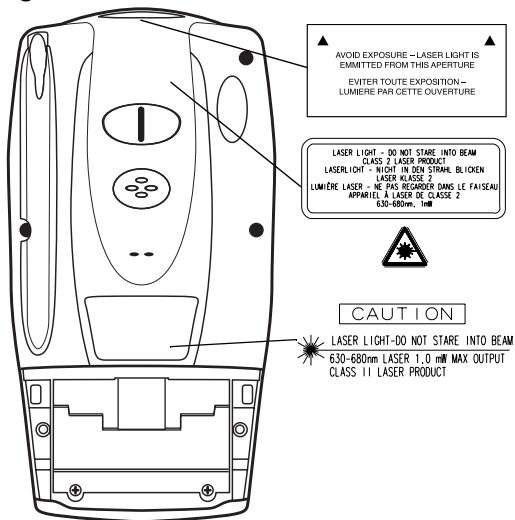

SPT 1700 Series

In accordance with Clause 5, IEC 0825 and EN60825, the following information is provided to the user:



ENGLISH CLASS 1 CLASS 2	CLASS 1 LASER PRODUCT LASER LIGHT DO NOT STARE INTO BEAM CLASS 2 LASER PRODUCT	HEBREW	מוצר לייזר רמה 1 אור לייזר אין להביט אל תוך הזרם מוצר לייזר רמה 2	רמה 1 רמה 2
DANISH KLASSE 1 KLASSE 2	KLASSE 1 LASERPRODUKT LASERLYF SE IKKE IND I STRÅLEN KLASSE 2 LASERPRODUKT AL LASER DI CLASSE 2	ITALIAN CLASSE 1 CLASSE 2	PRODOTTO AL LASER DI CLASSE 1 LUCE LASER NON FISSARE IL RAGGIOPRODOTTO	
DUTCH KLASSE 1 KLASSE 2	KLASSE-1 LASERPRODUKT LASERLICHT NIET IN STRAAL STAREN KLASSE-2 LASERPRODUKT	NORWEGIAN KLASSE 1 KLASSE 2	LASERPRODUKT, KLASSE 1 LASERLYS IKKE STIRR INN I LYSSTRÅLEN LASERPRODUKT, KLASSE 2	
FINNISH LUOKKA 1 LUOKKA 2	LUOKKA 1 LASERTUOTE LASERVALO ÄLÄ TUJOTA SÄDETTÄ LUOKKA 2 LASERTUOTE	PORTUGUESE CLASSE 1 CLASSE 2	PRODUTO LASER DA CLASSE 1 LUZ DE LASER NÃO FIXAR O RAI0 LUMINOSO PRODUTO LASER DA CLASSE 2	
FRENCH CLASSE 1 CLASSE 2	PRODUIT LASER DE CLASSE 1 LUMIERE LASER NE PAS REGARDER LE RAYON FIXEMENT PRODUIT LASER DE CLASSE 2	SPANISH CLASE 1 CLASE 2	PRODUCTO LASER DE LA CLASE 1 LUZ LASER NO MIRE FIJAMENTE EL HAZ PRODUCTO LASER DE LA CLASE 2	
GERMAN KLASSE 1 KLASSE 2	LASERPRODUKT DER KLASSE 1 LASERSTRAHLEN NICHT DIREKT IN DEN LASERSTRAHL SCHAUEN LASERPRODUKT DER KLASSE 2	SWEDISH KLASS 1 KLASS 2	LASERPRODUKT KLASS 1 LASERLJUS STIRRA INTE MOT STRÅLEN LASERPRODUKT KLASS 2	

Q u i c k R e f e r e n c e

DECLARATION OF CONFORMITY

We, **Symbol Technologies, Inc.**

of **One Symbol Plaza, Holtsville, NY 11742-1300, USA**

declare under our sole responsibility that the product

Spectrum24, LA3021, Type II Radio Card

Spectrum24, LA302C, Type II Radio Card

Spectrum24, LA302T, Type II Radio Card

to which this declaration relates, is in conformity with the following standards and/or other normative documents.

ETS 300 328 (November 1996)

ETS 300 826 (November 1997)

EN 60950: 1992 Incl Amdt 1-4, 11

We hereby declare that all essential radio test suites have been carried out and that the above named products is in conformity to all the essential requirements of Directive 1999/5/EC.

The conformity assessment procedure referred to in Article 10(5) and detailed in Annex IV of Directive 1999/5/EC has been followed with the involvement of the following Notified Body(ies):

BABT, Claremont House, 34 Molesey Road, Walton-on-Thames, KT12 4RQ

Identification mark: 0168

The equipment will also carry the Class
2 equipment identifier



The technical documentation relevant to the above equipment can be made available for inspection on application to:

Symbol Technologies EMEA, Symbol Place, Winnersh Triangle, Berkshire, RG 41 5TP, UK

Dornu Narnor

(name)

Director, Regulatory and Technical Sales

(title)

(signature of authorised person)

3, May 2000

(date)

DECLARATION OF CONFORMITY

We, Symbol Technologies, Inc.

of One Symbol Plaza, Holtsville, NY 11742-1300, USA

declare under our sole responsibility that the product

Spectrum24HR, LA4111, Type II Radio Card

Spectrum24HR, LA411T, Type II Radio Card

to which this declaration relates, is in conformity with the following standards and/or other normative documents.

ETS 300 328 (November 1996)

ETS 300 826 (November 1997)

EN 60950: 1992 Incl Amdt 1-4, 11

We hereby declare that all essential radio test suites have been carried out and that the above named products is in conformity to al the essential requirements of Directive 1999/5/EC.

The conformity assessment procedure referred to in Article 10(5) and detailed in Annex IV of Directive 1999/5/EC has been followed with the involvement of the following Notified Body(ies):

BABT, Claremont House, 34 Molesey Road, Walton-on-Thames, KT12 4RQ

Identification mark: 0168

The equipment will also carry the Class
2 equipment identifier



The technical documentation relevant to the above equipment can be made available for inspection on application to:

Symbol Technologies EMEA, Symbol Place, Winnersh Triangle, Berkshire, RG 41 5TP, UK

Dornu Narnor

(name)

Director, Regulatory and Technical Sales

(title)

3, May 2000

(signature of authorised person)

(date)

Warranty

Symbol Technologies, Inc. ("Symbol") manufactures its hardware products in accordance with industry-standard practices. Symbol warrants that for a period of twelve (12) months from date of shipment, products will be free from defects in materials and workmanship.

This warranty is provided to the original owner only and is not transferable to any third party. It shall not apply to any product (i) which has been repaired or altered unless done or approved by Symbol, (ii) which has not been maintained in accordance with any operating or handling instructions supplied by Symbol, (iii) which has been subjected to unusual physical or electrical stress, misuse, abuse, power shortage, negligence or accident or (iv) which has been used other than in accordance with the product operating and handling instructions. Preventive maintenance is the responsibility of customer and is not covered under this warranty.

Wear items and accessories having a Symbol serial number, will carry a 90-day limited warranty. Non-serialized items will carry a 30-day limited warranty.

Warranty Coverage and Procedure

During the warranty period, Symbol will repair or replace defective products returned to Symbol's manufacturing plant in the US. For warranty service in North America, call the Symbol Support Center at 1-800-659-2240. International customers should contact the local Symbol office or support center. If warranty service is required, Symbol will issue a Return Material Authorization Number. Products must be shipped in the original or comparable packaging, shipping and insurance charges prepaid. Symbol will ship the repaired or replacement product freight and insurance prepaid in North America. Shipments from the US or other locations will be made F.O.B. Symbol's manufacturing plant.

Symbol will use new or refurbished parts at its discretion and will own all parts removed from repaired products. Customer will pay for the replacement product in case it does not return the replaced product to Symbol within 3 days of receipt of the replacement product. The process for return and customer's charges will be in accordance with Symbol's Exchange Policy in effect at the time of the exchange.

Customer accepts full responsibility for its software and data including the appropriate backup thereof.

Repair or replacement of a product during warranty will not extend the original warranty term. Symbol's Customer Service organization offers an array of service plans, such as on-site, depot, or phone support, that can be implemented to meet customer's special operational requirements and are available at a substantial discount during warranty period.

General

Except for the warranties stated above, Symbol disclaims all warranties, express or implied, on products furnished hereunder, including without limitation implied warranties of merchantability and fitness for a particular purpose. The stated express warranties are in lieu of all obligations or liabilities on part of Symbol for damages, including without limitation, special, indirect, or consequential damages arising out of or in connection with the use or performance of the product.

Seller's liability for damages to buyer or others resulting from the use of any product, shall in no way exceed the purchase price of said product, except in instances of injury to persons or property.

Some states (or jurisdictions) do not allow the exclusion or limitation of incidental or consequential damages, so the proceeding exclusion or limitation may not apply to you.

Service Information

Before you use the unit, it must be configured to operate in your facility's network and run your applications.

If you have a problem running your unit or using your equipment, contact your facility's Technical or Systems Support. If there is a problem with the equipment, they will contact the Symbol Support Center:

United States	1-800-659-2240	Canada	905-629-7226
United Kingdom	0800 328 2424	Asia/Pacific	337-6588
Australia	1-800-672-906	Austria	1-505-5794
Denmark	7020-1718	Finland	9 5407 580
France	01-40-96-52-21	Germany	6074-49020
Italy	2-484441	Mexico	5-520-1835
Netherlands	315-271700	Norway	66810600
South Africa	11-4405668	Spain	9-1-320-39-09
Sweden	84452900		
Latin America Sales Support		1-800-347-0178 Inside US	
		+1-561-483-1275 Outside US	
Europe/Mid-East Distributor Operations		Contact local distributor or call	
		+44 208 945 7360	

For Frequently Asked Questions and tips on SPT 1700 operation, please visit the Symbol Palm website at <http://www.symbol.com/palm>.



70-37543-03
Revision B — March 2001