

P P T 2 8 0 0 S e r i e s
f o r P o c k e t P C 2 0 0 2

QRG



symbol®

P P T 2 8 0 0 S e r i e s f o r P o c k e t P C 2 0 0 2

© 2001 SYMBOL TECHNOLOGIES, INC. All rights reserved.

Symbol reserves the right to make changes to any product to improve reliability, function, or design.

Symbol does not assume any product liability arising out of, or in connection with, the application or use of any product, circuit, or application described herein.

No license is granted, either expressly or by implication, estoppel, or otherwise under any patent right or patent, covering or relating to any combination, system, apparatus, machine, material, method, or process in which Symbol products might be used. An implied license only exists for equipment, circuits, and subsystems contained in Symbol products.

Symbol and the Symbol logo are registered trademarks of Symbol Technologies, Inc. Other product names mentioned in this manual may be trademarks or registered trademarks of their respective companies and are hereby acknowledged.

Symbol Technologies, Inc.
One Symbol Plaza
Holtsville, N.Y. 11742-1300
<http://www.symbol.com>

Patents

This product is covered by one or more of the following U.S. and foreign Patents:

U.S. Patent No. 4,496,831; 4,593,186; 4,603,262; 4,607,156; 4,652,750; 4,673,805;
4,736,095; 4,758,717; 4,760,248; 4,806,742; 4,816,660; 4,845,350; 4,896,026; 4,897,532;
4,923,281; 4,933,538; 4,992,717; 5,015,833; 5,017,765; 5,021,641; 5,029,183; 5,047,617;
5,103,461; 5,113,445; 5,130,520; 5,140,144; 5,142,550; 5,149,950; 5,157,687; 5,168,148;
5,168,149; 5,180,904; 5,216,232; 5,229,591; 5,230,088; 5,235,167; 5,243,655; 5,247,162;
5,250,791; 5,250,792; 5,260,553; 5,262,627; 5,262,628; 5,266,787; 5,278,398; 5,280,162;
5,280,163; 5,280,164; 5,280,498; 5,304,786; 5,304,788; 5,306,900; 5,321,246; 5,324,924;
5,337,361; 5,367,151; 5,373,148; 5,378,882; 5,396,053; 5,396,055; 5,399,846; 5,408,081;
5,410,139; 5,410,140; 5,412,198; 5,418,812; 5,420,411; 5,436,440; 5,444,231; 5,449,891;
5,449,893; 5,468,949; 5,471,042; 5,478,998; 5,479,000; 5,479,002; 5,479,441; 5,504,322;
5,519,577; 5,528,621; 5,532,469; 5,543,610; 5,545,889; 5,552,592; 5,557,093; 5,578,810;
5,581,070; 5,589,679; 5,589,680; 5,608,202; 5,612,531; 5,619,028; 5,627,359; 5,637,852;
5,664,229; 5,668,803; 5,675,139; 5,693,929; 5,698,835; 5,705,800; 5,714,746; 5,723,851;
5,734,152; 5,734,153; 5,742,043; 5,745,794; 5,754,587; 5,762,516; 5,763,863; 5,767,500;
5,789,728; 5,789,731; 5,808,287; 5,811,785; 5,811,787; 5,815,811; 5,821,519; 5,821,520;
5,823,812; 5,828,050; 5,848,064; 5,850,078; 5,861,615; 5,874,720; 5,875,415; 5,900,617;
5,902,989; 5,907,146; 5,912,450; 5,914,478; 5,917,173; 5,920,059; 5,923,025; 5,929,420;
5,945,658; 5,945,659; 5,946,194; 5,959,285; 6,002,918; 6,021,947; 6,031,830; 6,036,098;
6,047,892; 6,050,491; 6,053,413; 6,056,200; 6,065,678; 6,067,297; 6,068,190; 6,082,621;
6,084,528; 6,088,482; 6,092,725; 6,101,483; 6,102,293; 6,104,620; 6,114,712; 6,115,678;
6,119,944; 6,123,265; 6,131,814; 6,138,180; 6,142,379; 6,172,478; 6,176,428; 6,178,426;
6,186,400; 6,188,681; 6,209,788; 6,216,951; 6,220,514; 6,243,447; 6,244,513; 6,247,647;
6,308,061; 6,250,551; 6,295,031; D305,885; D341,584; D344,501; D359,483; D362,453;
D363,700; D363,918; D370,478; D383,124; D391,250; D405,077; D406,581; D414,171;
D414,172; D418,500; D419,548; D423,468; D424,035; D430,158; D430,159; D431,562;
D436,104.

Invention No. 55,358; 62,539; 69,060; 69,187 (Taiwan); No. 1,601,796; 1,907,875;
1,955,269 (Japan); European Patent 367,299; 414,281; 367,300; 367,298; UK 2,072,832;
France 81/03938; Italy 1,138,713.

rev. 11/01

Introduction

Congratulations on your purchase of Symbol Technologies' PPT 2800 Terminal! Its unique combination of features make this product superior for use in a wide range of applications. These features include:

- Pocket size
- Personal Information Management software
- Microsoft® Windows® Pocket PC 2002 operating system
- RF communication via Symbol's Spectrum24 wireless network or a wide area network (WAN)
- Printing support
- 1 and 2-dimensional scanning capability
- Monochrome LCD or color TFT LCD display.

About This Guide

This guide describes how to set up and use the terminal. The term PPT 2800 refers to the batch, Spectrum24, and WAN versions of the terminal. Specific topics covered include:

- [Parts of the PPT 2800 on page 2](#)
- [Installing Batteries on page 5](#)
- [Charging the Battery on page 6](#)
- [Attaching the Handstrap on page 9](#)
- [Aligning the Screen on page 11](#)
- [Using the PPT 2800 on page 12](#)
- [Using the Stylus on page 13](#)
- [Today Screen on page 14](#)
- [Navigation Bar and Command Bar on page 15](#)
- [Input Methods on page 16](#)
- [Scanning with the PPT 2800 on page 19](#)
- [Resetting Your PPT 2800 Terminal on page 21](#)
- [Maintaining the PPT 2800 on page 23](#)
- [Troubleshooting on page 23.](#)

The *PPT 2800 Series for Pocket PC 2002 Product Reference Guide* (p/n 72-54894-xx), available from your Reseller or from Symbol Technologies, details the applications available for the PPT 2800.

PPT 2800 Series for Pocket PC 2002

Parts of the PPT 2800

Front View

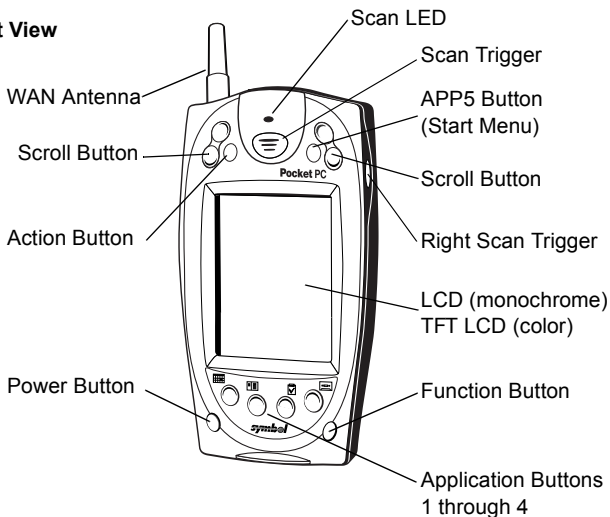

Left View

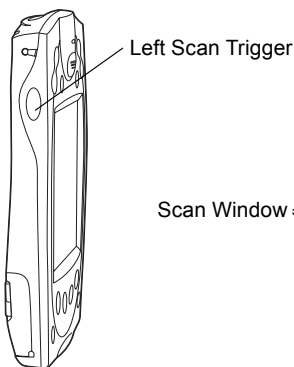

Top View

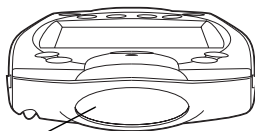

Top View (2D Scanning Terminal)

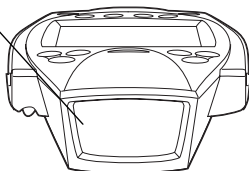

Parts of the PPT 2800 (continued)

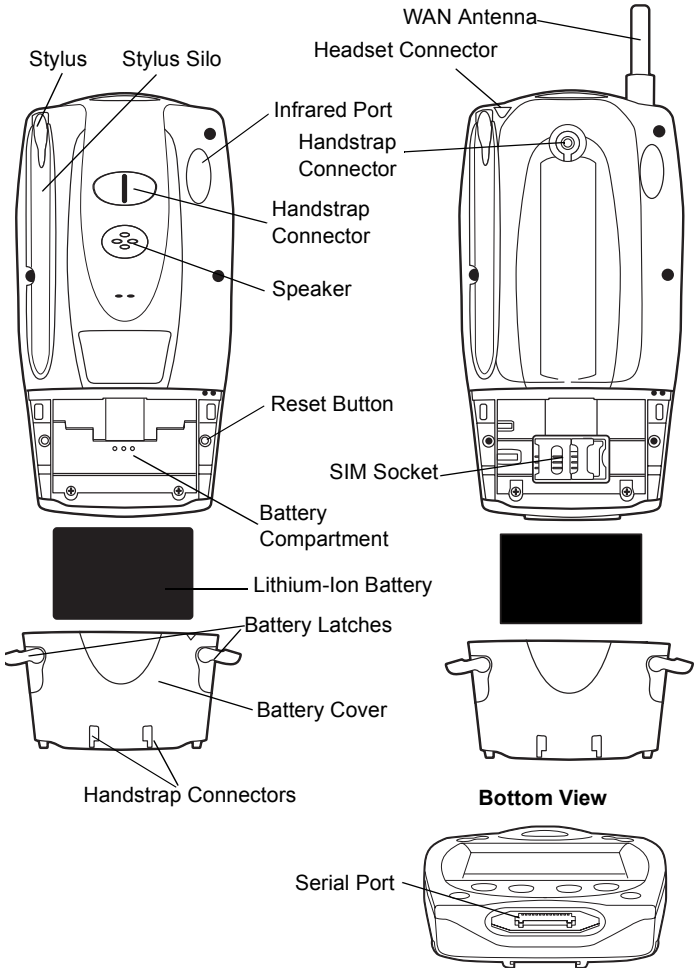

Installing the SIM Card (PPT 2837 Only)

Open the latches on the battery cover and lift it away from the PPT 2837.

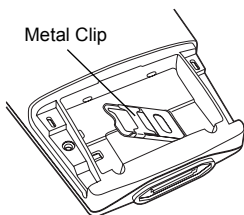

1. Slide the metal clip to the right to release the SIM cardholder, and lift the cardholder up.

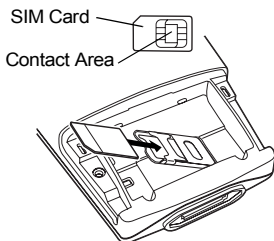

2. Insert the card between the cardholder body and the metal clip; be sure the beveled corner of the SIM card is on the bottom.

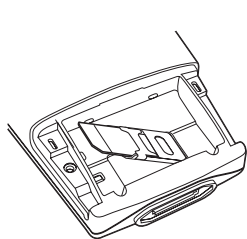

3. Close the cardholder with the contact area of the card facing down, and slide the metal clip to the left to lock it in place.

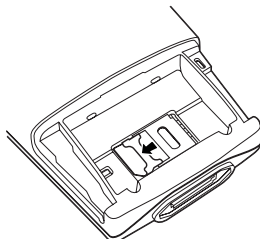

Installing Batteries

Before using your PPT 2800, install a lithium-ion battery:

1. Open the latches on the battery door and lift the battery door away from the PPT 2800.

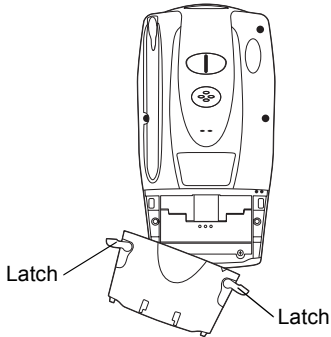

2. Insert the lithium-ion battery in the battery compartment with the battery tether positioned properly (as shown below), making sure the battery snaps into place.

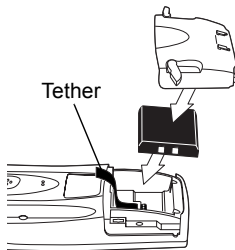

3. Replace the battery cover by inserting the bottom first, then pressing the top in firmly while securing the latches.

Charging the Battery

Before using your PPT 2800 for the first time, charge the lithium-ion battery in the terminal for about 2 1/2 hours, using the cradle or the synchronization cable. Follow these same procedures to recharge the battery.

Your terminal is equipped with a memory backup battery which automatically charges from the fully-charged lithium-ion battery. This backup battery retains data in memory when the terminal's battery is removed, and takes about 10 hours to charge when you first use your terminal.

Note: If you remove your lithium-ion battery before the back-up battery is fully charged, data may be lost. For this reason, DO NOT remove the battery within the first ten hours of use.

Charging the Battery Using the Cradle

1. Plug the cradle into a wall outlet.
2. Insert the PPT 2800 terminal in the cradle.

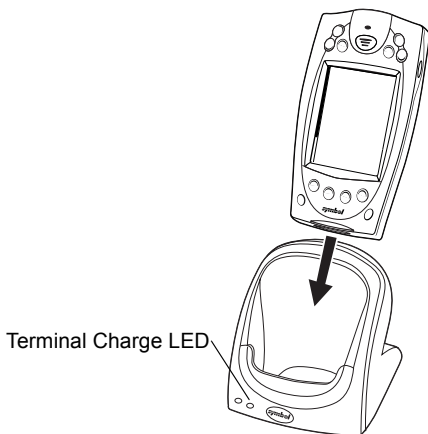

Q u i c k R e f e r e n c e

3. The Terminal Charge LED turns red (may take up to one minute) to indicate charging, then green when the battery is fully charged. The terminal's battery is fully charged after approximately 2 1/2 hours.

Charging a Spare Battery

To recharge a terminal's spare battery, insert it in the spare battery charging slot in the back of the cradle, oriented so the contacts are facing down and toward the back of the cradle. Press the battery down into the slot until firmly seated.

The Spare Battery Charge LED turns red to indicate charging, then green when the battery is fully charged. The battery is fully charged after approximately 2 1/2 hours. See the cradle's *Quick Reference Guide* for more information.

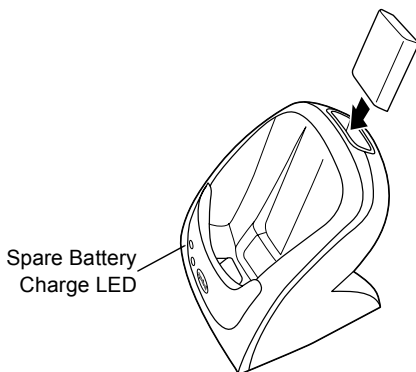

Charging the Battery Using the Synchronization Cable

1. Insert the cable into the bottom of the terminal.

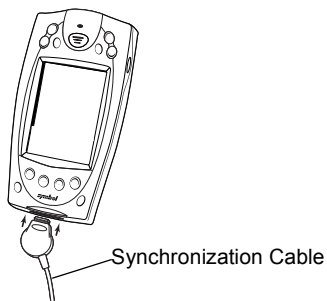

2. Plug the power cable into a wall outlet and plug the other end into the battery charging receptacle on the side of the synchronization cable.

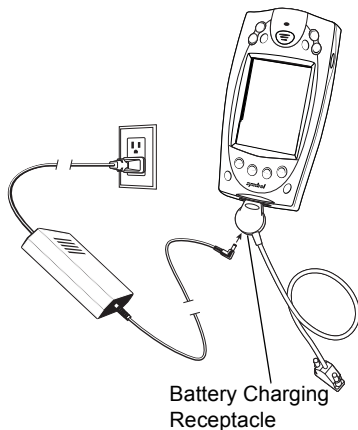

Attaching the Handstrap

The PPT 2800 has an optional handstrap which increases comfort when holding the terminal for extended periods of time. To attach the handstrap to the back of the terminal:

1. Thread the round metal piece through the metal handstrap connector on the back of the terminal.
2. Slide the flat metal piece into the handstrap connection on the bottom of the terminal.

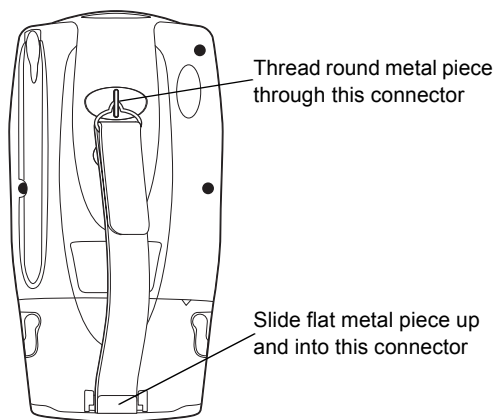

3. Adjust the velcro strap to fit your hand.

Attaching the Wrist Strap

An optional wrist strap is available from Symbol which helps prevent damage to the terminal if you drop it. To attach the wrist strap:

1. Thread the elastic band on the wrist strap through the metal handstrap connector on the back of the terminal.
2. Slip the strap through the elastic band on the other side of the connector, and pull it through to secure the strap to the connector.

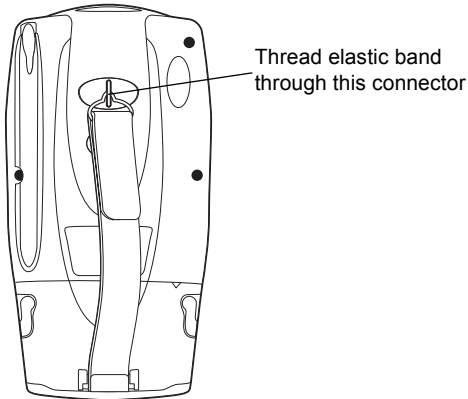

3. Slide your hand through the strap.

Starting the PPT 2800

Press the red power button to start the terminal. If the terminal does not power on, perform a hard reset. See [Performing a Hard Reset on page 22](#).

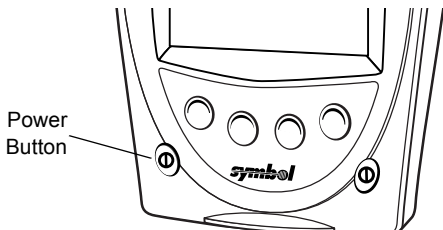

As the terminal initializes its unique Flash File system, the Symbol splash screen displays for about a minute.

When the Welcome screen appears, tap anywhere on the screen to continue to the Align screen. Note that these screens also appear every time you perform a hard reset.

Aligning the Screen

To align your PPT 2800 so the cursor on the touch screen aligns with the tip of your stylus:

1. If necessary, adjust the contrast (monochrome LCD only) on the PPT 2800 so the screen is readable. See [Controlling the Backlight on page 12](#).
2. Remove the stylus from its storage silo on the back of the PPT 2800.

PPT 2800 Series for Pocket PC 2002

3. Tap the center of each target that appears on the screen with the tip of the stylus.

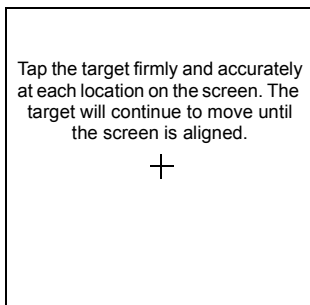

4. Follow the directions on the screen which explain how to use the stylus and pop-up menus, and allow you to set your city and time zone.

Using the PPT 2800

Using the Power Button

Press the power button on the lower left-hand side of the terminal to turn the PPT 2800 on and off.

Controlling the Backlight

The Function button, shown below, allows you to adjust the contrast of the screen and control the backlight.

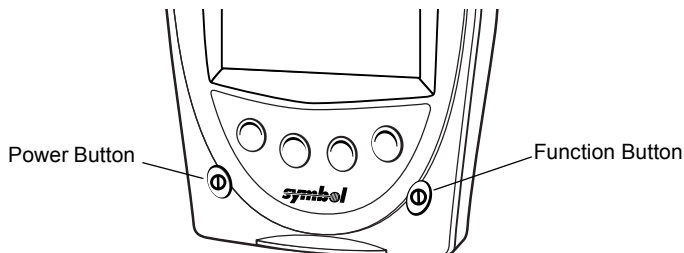

Q u i c k R e f e r e n c e

To adjust the contrast (monochrome LCD) or backlight (color TFT LCD):

1. Press and hold the Function button.
2. Press the “up” scroll button at the top of the terminal to brighten the screen, or the “down” scroll button to darken the screen.

To turn the backlight on or off:

1. Press and hold the Function button.
2. Press any application button.

Using the Stylus

The stylus selects items and enters information. The stylus functions as a mouse.

- **Tap:** Touch the screen once with the stylus to open items and select options.
- **Drag:** Hold the stylus on the screen and drag across the screen to select text and images. Drag in a list to select multiple items.
- **Tap-and-hold:** Tap and hold the stylus on an item to see a list of actions available for that item. On the pop-up menu that appears, tap the action you want to perform.

Today Screen

When you turn on your terminal for the first time each day (or after 4 hours of inactivity), the Today screen appears. You can also display it by tapping , then Today. On the Today screen, you can see important information for the day.

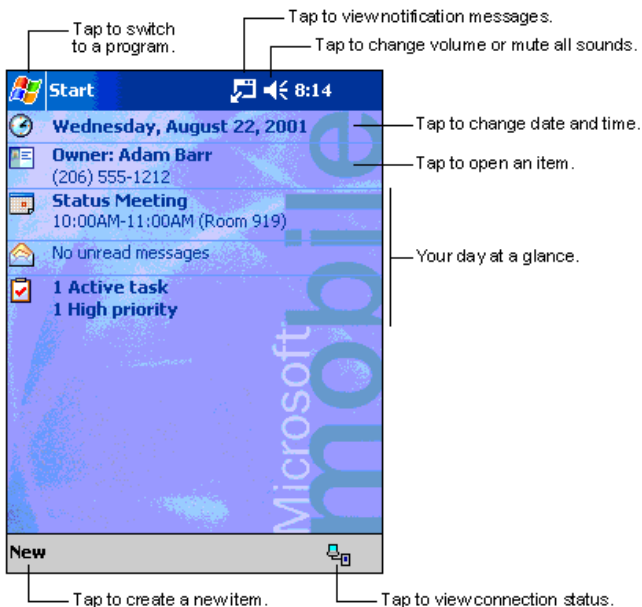

Navigation Bar and Command Bar

The navigation bar at the top of the screen displays the active program and current time, and allows you to select programs and close screens. The command bar at the bottom of the screen contains menus and buttons to perform tasks in programs.

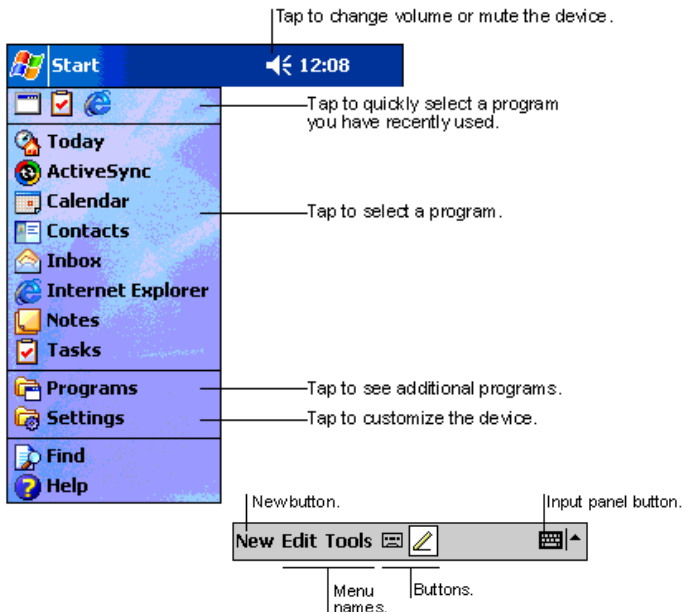

Input Methods

Use the input panel to enter information in any program. You can either type using the soft keyboard or write using Block Recognizer, or the Letter Recognizer. In any case, the characters appear as typed text on the screen.

To show or hide the input panel, tap the Input Panel button. Tap the arrow next to this button to view input methods.

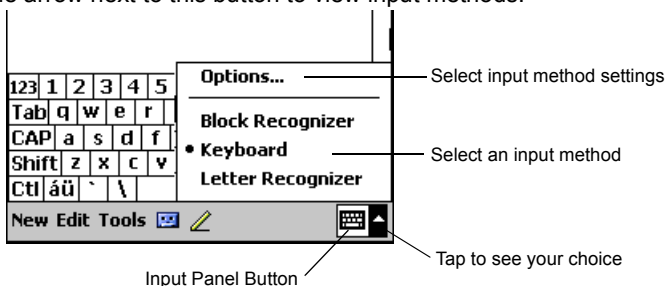

When you use the input panel, your terminal anticipates the word you are typing or writing and displays it above the input panel. When you tap the displayed word, it is inserted into your text at the insertion point. The more you use your terminal, the more words it learns to anticipate.

Using the Soft Keyboard

1. Tap the arrow next to the Input Panel button, then *Keyboard*.
2. On the soft keyboard, tap the keys with your stylus.



Using the Block Recognizer

1. Tap the arrow next to the Input Panel button, then *Block Recognizer*.
2. Write a letter in the left side of the box, or a number in the right side, using special character strokes.

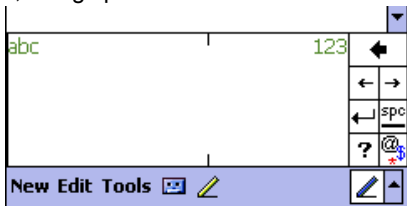

When you write a letter, it is converted to typed text on the screen. For instructions on entering Block Recognizer characters, with Block Recognizer open, tap the question mark next to the writing area, or see *Block Recognizer Characters* on page 18.

Using the Letter Recognizer

1. Tap the arrow next to the Input Panel button, then *Letter Recognizer*.
2. Write letters or numbers in the writing area, just as you would on paper. Write capital letters in the left side of the box, numbers in the right side, and lower case letters in the center.

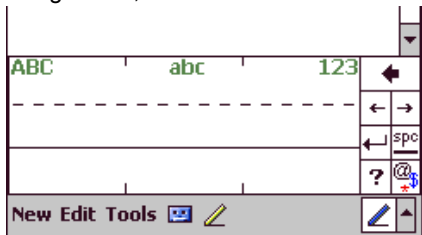

P P T 2 8 0 0 Series for Pocket PC 2 0 0 2

When you write a letter, it is converted to typed text on the screen. For instructions on using Letter Recognizer, with Letter Recognizer open, tap the question mark next to the writing area.

Block Recognizer Characters

The following chart is a partial display of the characters you can write while using the Block Recognizer (the dot on each character is the starting point for writing).

Letter Area

A	a	a			N	n			
B	b	b			O	o	o		
C	C				P	p	p		
D	d	d			Q	q	q		
E	e				R	r	r		
F	f	f			S	s			
G	g	g			T	t	7	7	7
H	h	h			U	u	u		
I	i	i			V	v			
J	j	j			W	w	w		
K	k	k	k	α	X	x	x		
L	l	l	l		Y	y	y		
M	m				Z	z			

Number/Punctuation Area

0	0))			
1	1				+	+			
2	2	2			*	x	∞		
3	3				/				
4	4	4	4	L	\				
5	5	5			?	?	?		
6	6				!	!			
7	7				@	@			
8	8				&	&			
9	9				‘	‘			
>	>				“	“			
•	•				-	-			
((

space	←
back space	→

enter	↵
back space	→

Scanning with the PPT 2800

The PPT 2800 has an integrated scanner which collects data by scanning bar codes. See the *PPT 2800 Series for Pocket PC 2002 Product Reference Guide* for information on configuring your terminal for scanning.

To scan bar codes with the PPT 2800:

1. Aim the scanner at the bar code.
2. Press either the right, left, or center scan trigger. Make sure the red scan beam covers the entire bar code. The green scan LED lights and a beep sounds to indicate a successful decode.

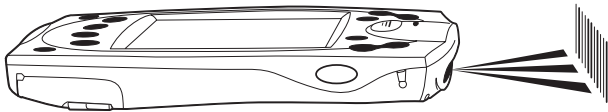

Scanning PDF417 Bar Codes

The 2D scanning PPT 2800 terminal supports PDF417 bar code scanning. The raster pattern has multiple scanning rows to accommodate the PDF417 symbol's multiple rows.

1. Point the scanner at the bar code and press the trigger.
2. Center the aiming pattern on the bar code.
3. As the raster pattern spreads, keep the pattern horizontal to the bar code.



P P T 2 8 0 0 S e r i e s f o r P o c k e t P C 2 0 0 2

4. The terminal indicates a successful scan by changing the LED from red to green, beeping one or more times, and/or displaying the bar code data on the screen.

If the PDF417 symbol is too “tall” where the vertical scan pattern is not high enough to cover it, move the scan pattern slowly down toward the bottom of the symbol, keeping the beam horizontal to the rows, then slowly back up toward the top.

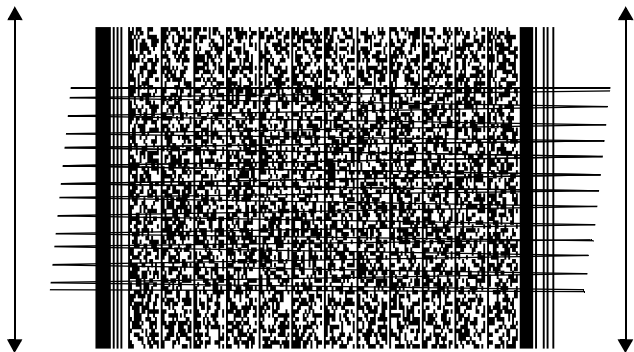

Using a Headset (PPT 28XX Color and PPT 2837 Only)

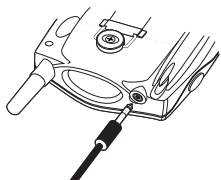

The headset is required for telephony operation.

To use the headset, plug the headset jack into the audio connector on the top of the terminal.

Initiating a Network Connection

Before using the terminal, set up the Spectrum24, CDPD (Cellular Digital Packet Data) or GSM (Global System for Mobile Communication) network connection. Refer to the *PPT 2800 Series for Pocket PC 2002 Product Reference Guide* for setup instructions.

Resetting Your PPT 2800 Terminal

If your PPT 2800 terminal stops responding to input, reset it.

Performing a Soft Reset

A soft reset restarts the terminal and saves all stored records and entries.

Caution: Files that remain open during a soft reset may not be retained.

DO NOT perform a soft reset if the terminal is suspended. Press the Power button to wake the terminal.

To perform a soft reset, hold down both the up and down scroll buttons, then press the App 4 button.

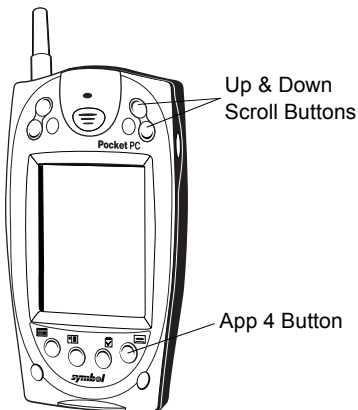

Performing a Hard Reset

A hard reset also restarts your PPT 2800 terminal, but erases all stored records and entries. *Therefore, never perform a hard reset unless a soft reset does not solve your problem.*

Note: You can restore any data previously synchronized with your computer during the next ActiveSync operation. See the *PPT 2800 Cradle Quick Reference Guide* or the *PPT 2800 Series for Pocket PC 2002 Product Reference Guide*.

To perform a hard reset:

1. Remove the battery cover.
2. While holding down the Function button, use the stylus (or similar object *without* a sharp tip) to gently press the reset button.

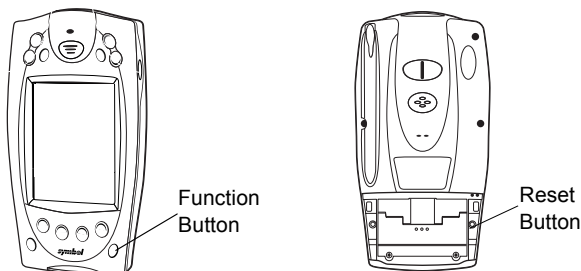

3. Replace the battery cover and press the Power button.
4. As the terminal initializes its unique Flash File system, the Symbol splash screen displays for about a minute.
5. See *Aligning the Screen* on page 11 to perform an initial set-up of the terminal.

Caution: With a hard reset, Formats, Preferences, and other settings are restored to their factory default settings.

Maintaining the PPT 2800

For trouble-free service, observe the following tips when using your PPT 2800:

- Do not scratch the screen. Use the supplied stylus or plastic-tipped pens intended for use with a touch-sensitive screen. Never use a pen or pencil or other sharp object on the screen.
- Although your PPT 2800 is water and dust resistant, do not expose it to rain or moisture for an extended period of time. Treat your PPT 2800 as you would a pocket calculator or other small electronic instrument.
- The touch-sensitive screen of your PPT 2800 contains glass. Do not drop your PPT 2800 or subject it to strong impact.
- Protect your PPT 2800 from temperature extremes. Do not leave it on the dashboard of a car on a hot day, and keep it away from heat sources.
- Do not store or use your PPT 2800 in any location that is extremely dusty, damp or wet.
- If the surface of the PPT 2800 screen becomes soiled, clean it with a soft cloth moistened with a diluted window-cleaning solution.

Troubleshooting

PPT 2800 terminal does not turn on:

- Adjust the contrast/backlight.
- Make sure batteries are installed properly.
- Replace the batteries. If your PPT 2800 terminal still does not operate, try a soft reset, then a hard reset; see *Resetting Your PPT 2800 Terminal* on page 21.

No sound:

- Check the System Volume slider in the **Sounds & Notifications** properties screen (under **Start/Settings**) to make sure

the volume is not turned down.

PPT 2800 terminal turns itself off:

- Your PPT 2800 terminal turns off after a period of inactivity. This period can be set from one to five minutes, in one-minute intervals. Check the **Power** dialog box (in the **System** tab under **Start/Settings**), and change the setting if you need a longer delay before the automatic shutoff feature activates.

PPT 2800 terminal doesn't recognize my handwriting:

- If you're using the Block Recognizer input method, characters must be written a certain way. See the *PPT 2800 Product Reference Guide* for information about how to write character strokes.
- If you're using the Block Recognizer or Letter Recognizer input method, make the character strokes in the lower character entry area on the screen — not on the display part of the screen.
- Make sure you are writing letters and numbers in the appropriate section of the writing area.

Tapping the screen buttons or icons does not activate the corresponding feature:

- Align the screen. Choose **Screen** from the **System** tab under **Start/Settings**, or hold down the Function button and press the Action button.

A message appears stating that your PPT 2800 terminal memory is full:

- Delete unused memos and records. You can save these records on your computer.
- Adjust the memory allocation. Select **Start**, then **Settings**, and select the **System** tab. Tap **Memory** and adjust the slider.

Q u i c k R e f e r e n c e

- If you have installed additional applications on your PPT 2800 terminal, remove them to recover memory. Select **Start**, then **Settings**, and select the **System** tab. Tap **Remove Programs**, select the unused program and tap **Remove**.

Beamed data does not transmit:

- Confirm that the PPT 2800 terminals are 5" apart, and there is a clear path between the two devices.
- Adjust the room lighting or move to a different location.

When receiving beamed data an out of memory message appears:

- Your PPT 2800 terminal requires at least twice the amount of memory available as the data you are receiving. For example, if you are receiving a 30K application, you must have at least 60K free.

Your PPT 2800 unit does not accept scan input:

- Verify that the unit is loaded with a scanning application. See your System Administrator.
- Be sure the symbol is not defaced.
- Be sure you are within proper scanning range.
- Be sure the terminal is programmed to accept the type of bar code you are scanning.
- If you are expecting a beep on a good decode and don't hear one, check that the application is set to generate a beep on good decode.
- If the scanner stops emitting a laser beam when you press the trigger, check your battery level. When the battery is low, the scanner shuts off before the terminal notifies you of the low battery condition.

Note: If the scanner is still not reading symbols, contact your distributor or Symbol Technologies.

END-USER LICENSE AGREEMENT

- You have acquired a device ("DEVICE") that includes software licensed by Symbol Technologies, Inc. ("SYMBOL") from Microsoft Licensing Inc. or its affiliates ("MS"). Those installed software products of MS origin, as well as associated media, printed materials, and "online" or electronic documentation ("SOFTWARE") are protected by international intellectual property laws and treaties. The SOFTWARE is licensed, not sold. All rights reserved.
- IF YOU DO NOT AGREE TO THIS END USER LICENSE AGREEMENT ("EULA"), DO NOT USE THE DEVICE OR COPY THE SOFTWARE. INSTEAD, PROMPTLY CONTACT SYMBOL FOR INSTRUCTIONS ON RETURN OF THE UNUSED DEVICE(S) FOR A REFUND. **ANY USE OF THE SOFTWARE, INCLUDING BUT NOT LIMITED TO USE ON THE DEVICE, WILL CONSTITUTE YOUR AGREEMENT TO THIS EULA (OR RATIFICATION OF ANY PREVIOUS CONSENT).**
- **GRANT OF SOFTWARE LICENSE.** This EULA grants you the following license:
- SOFTWARE includes software already installed on the DEVICE ("DEVICE Software") and MS software contained on the CD-ROM disk ("Desktop Software").

SYSTEM Software. You may use the DEVICE Software as installed on the DEVICE.

Desktop Software. Desktop Software is included with your DEVICE, and you may install and use the Microsoft® Active Sync® 3.5 component on one (1) or more computers to exchange information with one (1) or more computing devices that contain a compatible version of the Microsoft® Pocket PC Software 2002 operating system. For other software component(s) contained in the Desktop Software, you may install and use such components only in accordance with the terms of the printed or online end user license agreement(s) provided with such component(s). In the absence of an end user license agreement for particular component(s) of the Desktop Software, you may install and use only one (1) copy of such component(s) on the DEVICE or a single computer with which you use the DEVICE.

Back-up Copy. If Manufacturer has not included a back-up copy of the DEVICE Software with the DEVICE, you may make a single back-up copy of the DEVICE Software. You may use the back-up copy solely for archival purposes.

Microsoft® Outlook® 2002. If Microsoft Outlook 2002 is included with your Device, the following terms apply to your use of Microsoft Outlook 2002: (i) regardless of the information contained in "Software Installation and Use" section of the online EULA you may install one (1) copy of Microsoft Outlook 2002 on one (1) computer to use, exchange data, share data, access and interact with the DEVICE, and (ii) the EULA for Microsoft Outlook 2002 is between Manufacturer (as defined above) and the end user – not between the PC Manufacturer and end user.

DESCRIPTION OF OTHER RIGHTS AND LIMITATIONS.

- **Speech/Handwriting Recognition.** If the SOFTWARE includes speech and/or handwriting recognition component(s), you should understand that speech and handwriting recognition are inherently statistical processes; that recognition errors are inherent in the processes; that it is your responsibility to provide for handling such errors and to monitor the recognition processes and correct any errors. Neither Manufacturer nor its suppliers shall be liable for any damages arising out of errors in the speech and handwriting recognition processes.
- **Limitations on Reverse Engineering, Decompilation and Disassembly.** You may not reverse engineer, decompile, or disassemble the SOFTWARE, except and only to the extent that such activity is expressly permitted by applicable law notwithstanding this limitation.
- **Single DEVICE.** The DEVICE Software is licensed with the DEVICE as a single integrated product. The DEVICE Software installed in read only memory ("ROM") of the DEVICE may only be used as part of the DEVICE.
- **Single EULA.** The package for the DEVICE may contain multiple versions of this EULA, such as multiple translations and/or multiple media versions (e.g., in the user documentation and in the software). Even if you receive multiple versions of the EULA, you are licensed to use only one (1) copy of the DEVICE Software.
- **Rental.** You may not rent or lease the SOFTWARE.
- **Software Transfer.** You may permanently transfer all of your rights under this EULA, only as

Q u i c k R e f e r e n c e

part of a sale or transfer of the DEVICE, provided you retain no copies, you transfer all of the SOFTWARE (including all component parts, the media and printed materials, any upgrades or backup copies, this EULA and, if applicable, the Certificate(s) of Authenticity), and the recipient agrees to the terms of this EULA. If the Software is an upgrade, any transfer must include all prior versions of the SOFTWARE.

- **Termination.** Without prejudice to any other rights, Manufacturer or MS may terminate this EULA if you fail to comply with the terms and conditions of this EULA. In such event, you must destroy all copies of the SOFTWARE and all of its component parts.

UPGRADES AND RECOVERY MEDIA.

- **DEVICE Software.** If the DEVICE Software is provided by Manufacturer separate from the DEVICE on media such as a ROM chip, CD ROM disk(s) or via web download or other means, and is labeled "For Upgrade Purposes Only" or "For Recovery Purposes Only", you may install one copy of such DEVICE Software onto the DEVICE as a replacement copy for the existing DEVICE Software and use it in accordance with Section 1 of this EULA.
- **Desktop Software.** If any Desktop Software component(s) is provided by Manufacturer separate from the DEVICE on CD ROM disk(s) or via web download or other means, and labeled "For Upgrade Purposes Only" or "For Recovery Purposes Only", you may (i) install and use one copy of such component(s) on the computer(s) you use to exchange data with the DEVICE as a replacement copy for the existing Desktop Software component(s).

COPYRIGHT. All title and intellectual property rights in and to the SOFTWARE (including but not limited to any images, photographs, animations, video, audio, music, text and "applets," incorporated into the SOFTWARE), the accompanying printed materials, and any copies of the SOFTWARE, are owned by MS or its suppliers (including Microsoft Corporation). You may not copy the printed materials accompanying the SOFTWARE. All title and intellectual property rights in and to the content which may be accessed through use of the SOFTWARE is the property of the respective content owner and may be protected by applicable copyright or other intellectual property laws and treaties. This EULA grants you no rights to use such content. All rights not specifically granted under this EULA are reserved by MS and its suppliers (including Microsoft Corporation).

EXPORT RESTRICTIONS. You agree that you will not export or re-export the SOFTWARE to any country, person, or entity subject to U.S. export restrictions. You specifically agree not to export or re-export the SOFTWARE: (i) to any country to which the U.S. has embargoed or restricted the export of goods or services, which as of May 1999 include, but are not necessarily limited to Cuba, Iran, Iraq, Libya, North Korea, Sudan, Syria, and the Federal Republic of Yugoslavia (including Serbia, but not Montenegro), or to any national of any such country, wherever located, who intends to transmit or transport the products back to such country; (ii) to any person or entity who you know of have reason to know will utilize the SOFTWARE or portion thereof in the design, development or production of nuclear, chemical or biological weapons; or (iii) to any person or entity who has been prohibited from participating in U.S. export transactions by any federal agency of the U.S. government.

NOTE ON JAVA SUPPORT. The SOFTWARE may contain support for programs written in Java. Java technology is not fault tolerant and is not designed, manufactured, or intended for use or resale as on-line control equipment in hazardous environments requiring fail-safe performance, such as in the operation of nuclear facilities, aircraft navigation or communication systems, air traffic control, direct life support machines, or weapons systems, in which the failure of Java technology could lead directly to death, personal injury, or severe physical or environmental damage.

PRODUCT SUPPORT. Product support for the SOFTWARE is not provided by MS, its parent corporation, Microsoft Corporation, or their affiliates or subsidiaries. For product support, please refer to the SYMBOL support number provided in the documentation for the DEVICE. Should you have any questions concerning this EULA, or if you desire to contact SYMBOL for any other reason, please refer to the address provided in the documentation for the DEVICE.

P P T 2 8 0 0 S e r i e s f o r P o c k e t P C 2 0 0 2

NO LIABILITY FOR CERTAIN DAMAGES. EXCEPT AS PROHIBIT BY LAW, MS SHALL HAVE NO LIABILITY FOR ANY INDIRECT, SPECIAL, CONSEQUENTIAL OR INCIDENTAL DAMAGES ARISING FROM OR IN CONNECTION WITH THE USE OR PERFORMANCE OF THE SOFTWARE. THIS LIMITATION SHALL APPLY EVEN IF ANY REMEDY FAILS OF ITS ESSENTIAL PURPOSE.

FOR APPLICABLE LIMITED WARRANTIES AND SPECIAL PROVISIONS PERTAINING TO YOUR PARTICULAR JURISDICTION, PLEASE REFER TO YOUR WARRANTY BOOKLET INCLUDED WITH THIS PACKAGE OR PROVIDED WITH THE SOFTWARE PRINTED MATERIALS.

Ergonomic Recommendations

Caution: In order to avoid or minimize the potential risk of ergonomic injury follow the recommendations below. Consult with your local Health & Safety Manager to ensure that you are adhering to your company's safety programs to prevent employee injury.

- Reduce or eliminate repetitive motion
- Maintain a natural position
- Reduce or eliminate excessive force
- Keep objects that are used frequently within easy reach
- Perform tasks at correct heights
- Reduce or eliminate vibration
- Reduce or eliminate direct pressure
- Provide adjustable workstations
- Provide adequate clearance
- Provide a suitable working environment
- Improve work procedures.

Regulatory Information

Radio Frequency Interference Requirements

This device has been tested and found to comply with the limits for a Class B digital device pursuant to Part 15 of the Federal Communications Commissions Rules and Regulation. These limits are designed to provide reasonable protection against harmful interference when the equipment is operated in a commercial environment. This equipment generates, uses, and can radiate radio frequency energy and, if not installed and used in accordance with the instruction manual, may cause harmful interference to radio communications. Operation of this equipment in a residential area is likely to cause harmful interference in which case the user will be required to correct the interference at his own expense.

However, there is no guarantee that interference will not occur in a particular installation. If the equipment does cause harmful interference to radio or television reception, which can be determined by turning the equipment off and on, the user is encouraged to try to correct the interference by one or more of the following measures:

- Re-orient or relocate the receiving antenna.
- Increase the separation between the equipment and receiver.
- Connect the equipment into an outlet on a circuit different from that which the receiver is connected.

Q u i c k R e f e r e n c e

- Consult the dealer or an experienced radio/TV technician for help.

This device complies with FCC Part 15. Operation is subject to the following two conditions: (1) this device may not cause harmful interference and (2) this device must accept any interference received, including interference that may cause undesired operation.

Radio Frequency Interference Requirements - Canada

This device complies with RSS 210 of Industry & Science Canada. Operation is subject to the following two conditions: (1) this device may not cause harmful interference and (2) this device must accept any interference received, including interference that may cause undesired operation.

This Class B digital apparatus complies with Industry Canada Standard ICES-003. Cet appareil numérique de la classe B est conforme à la norme NMB-003 d'Industrie Canada.

CE Marking and European Union Compliance



Products intended for sale within the European Union are marked with the CE Mark which indicates compliance to applicable Directives and European Normes (EN), as follows. Amendments to these Directives or ENs are included:

Applicable Directives

- Electromagnetic Compatibility Directive 89/336/EEC
- Low Voltage Directive 73/23/EEC

Applicable Standards

- EN 55 022 - Limits and Methods of Measurement of Radio Interference Characteristics of Information technology Equipment
- EN55024:1998: Information technology equipment- Immunity characteristics- Limits and methods of measurement.
- ETS 300-826:1997: Electromagnetic compatibility and radio spectrum matters (ERM); Electromagnetic compatibility (EMC) standard for 2.4Ghz wideband transmission systems and high performance radio local area network (Hiperlan) equipment.
- IEC 1000-4-2:1995/EN 61000-4-2:1995; Electromagnetic Compatibility (EMC) Part 4: Testing and Measurement techniques; Section 4.2: Electrostatic discharge immunity test.
- IEC 1000-4-3:1995/EN61000-4-3:1997, Electromagnetic Compatibility (EMC); Part 4 Testing and measurement techniques; Section 3. Radiated, radio frequency electromagnetic field immunity test.
- IEC 1000-4-4:1995/EN61000-4-4:1995; Electromagnetic compatibility (EMC) Part 4; Testing and Measurement techniques; Section 4: Testing electrical fast transient, /Burst Immunity.
- IEC 1000-4-5:1995/EN61000-4-5;1995, Electromagnetic compatibility (EMC),

P P T 2 8 0 0 S e r i e s f o r P o c k e t P C 2 0 0 2

- Part 4:Testing and Measurement techniques;Section 5:Surge Immunity
- IEC 1000-4-6:1996/EN61000-4-6:1996:Electromagnetic compatibility (EMC), Part 4:Testing and Measurement techniques;Section 6: Immunity to conducted disturbances, induced by radio frequency fields.
- IEC 1000-4-11:1994/EN61000-4-11:1994: Electromagnetic compatibility (EMC), Part 4:Testing and Measurement techniques;Section 11:Voltage Dips, Short Interruptions, and Voltage Variations.
- EN 60 950 + Amd 1 + Amd 2 - Safety of Information Technology Equipment Including Electrical Business Equipment
- EN 60 825-1 (EN 60 825) - Safety of Devices Containing Lasers.

RF Devices

Symbol's RF products are designed to be compliant with the rules and regulations in the locations into which they are sold and will be labeled as required. The majority of Symbol's RF devices are type approved and do not require the user to obtain license or authorization before using the equipment. Any changes or modifications to Symbol Technologies equipment not expressly approved by Symbol Technologies could void the user's authority to operate the equipment.

The Spectrum24 equipment is intended for use throughout the European Economic Area, but it's authorization for use in France is restricted as follows:

- **PAN** European Frequency Range: 2.400 - 2.4835 GHz, identified by -EU suffix to the model number found on the product label.
- **France** - Restrict Frequency Range for use in France: 2.447 - 2.453 GHz, identified on PPT 2842 by the -FR suffix to the model number found on the product label.
- **Belgium** - Operation in an out of doors environment in Belgium must be restricted to 2460 - 2483.5 MHz band.
- **Italy** - Operation in Italy requires a user license.

WARNING: FCC RF EXPOSURE GUIDELINES

This device was tested for typical body-worn operations with the Holster providing a minimal spacing of 2.0 cm. from the body to the back of the terminal/antenna. To maintain compliance with FCC RF exposure compliance requirements, use only belt-clips, holsters or similar accessories that maintain a 2.0 cm. separation distance between the user's body and the back of the terminal, including the antenna. The use of third-party belt-clips, holsters and similar accessories should not contain metallic components in its assembly. The use of accessories that do not satisfy these requirements may not comply with FCC RF exposure compliance requirements, and should be avoided.

Caution: RF Devices

Symbol's RF products are designed to be compliant with the rules and regulations in the locations into which they are sold and will be labeled as required. The majority of Symbol's RF devices are type approved and do not require the user to obtain license or authorization before using the equipment. Any changes or modifications to Symbol Technologies' equipment not expressly approved by Symbol Technologies could void the user's authority to operate the equipment.

GSM Regulatory Warnings

Emergency Calls

Please contact your service provider for information about the availability of Emergency Calls.

The GSM version supports Emergency Calls with or without a SIM card fitted. However, as for any other voice call, you must be registered on a GSM network. If you are outside the coverage of a GSM network, or another factor such as insufficient power occurs, then Emergency Call will not work.

P P T 2 8 0 0 S e r i e s f o r P o c k e t P C 2 0 0 2

The procedure for generating an Emergency Call will depend on the application/service currently in use and the network you are connected to. It is recommended that you familiarize yourself with the appropriate procedures required to generate an Emergency Call.

When connected to the Emergency Operator you should have details of your telephone number and location on hand.

Safety Information

The GSM version gives off radio frequency signals in the 900 MHz, 1800 MHz and 1900 MHz frequency bands. The following recommendations are in line with guidelines concerning public exposure to radio frequency electromagnetic energy, issued by various European and International agencies.

Unlike a mobile phone, the transmitter antenna on the GSM version would not (under normal circumstances) be close to the head, and therefore high field strength is not usually encountered. The use of the GSM version is similar to using a mobile phone with a handsfree unit. However, take care to avoid placing any part of your body in proximity to the GSM version antenna when the GSM radio is switched on. In particular, it is recommended that you do not grasp the antenna while the GSM version is operating as this will not only significantly degrade its performance, but also expose your hand to the maximum radio frequency power emitted by the GSM version.

Safety on the Road

The GSM version should not be used by the driver of a vehicle when in motion. Always safely park your vehicle before turning your attention to your device. Always adequately secure your device in a moving vehicle, and do not leave it loose on a passenger seat. Remember that in the event of a sudden stop an unsecured device could cause injury to any occupants as well as damage to the vehicle. If your vehicle has an airbag, do not place any objects, including your device, in the area around the airbag or where the airbag deploys. Any item propelled by an activated airbag could cause serious injury and damage.

When receiving calls on a public highway, mobile units are not permitted to use "warning" devices, which permit the vehicles' horn to sound or the light to flash.

Safety on Aircraft

You are required by law to switch off all electrical apparatus when boarding and leaving an aircraft and at any other time when instructed to do so by a member of the crew. You are not allowed to use any mobile phone, as well as the GSM version, at any time when on board an aircraft, as such use may constitute a danger. In such circumstances please ensure that your GSM version is switched off, disabling attempts to log onto networks.

Pacemakers

It is recommended by pacemaker manufacturers that a minimum of 20cm (8 inches) be maintained between a handheld wireless phone and a pacemaker to avoid any possible interference with the pacemaker. These recommendations are consistent with the independent research by and recommendations of Wireless Technology Research.

Persons with pacemakers:

- Should always keep the phone more than 20cm (8 inches) from their pacemaker when the phone is turned on
- Should not carry the phone in a breast pocket
- Should use the ear opposite the pacemaker to minimize the potential for interference.

If you have any reason to suspect that interference is taking place turn off the GSM version immediately. This may be achieved most rapidly by switching off the device using its on/off button.

Hearing Aids

Some digital wireless phones may interfere with some hearing aids. In the event of such interference you may want to consult your hearing aid supplier to discuss solutions.

Other Medical Devices

The GSM version transmits radio frequency energy and as such has the potential to interfere with inadequately protected medical devices. Consult your physician or the manufacturer of the device to see if any particular device has sufficient protection.

It is good practice to completely turn off the GSM version within a hospital or other medical facility where sensitive medical equipment is in use. In some countries, this is a legal requirement applying to all mobile phones and related equipment.

Effect on Vehicles

RF signals may affect improperly installed or inadequately shielded electronic systems in motor vehicles (including safety systems). Check with the manufacturer or its representative regarding your vehicle. You should also consult the manufacturer of any equipment that has been added to your vehicle.

Posted Facilities

Switch off the GSM version in any facility where posted notices require mobile phones to be switched off.

Potentially Hazardous Atmospheres

Do not take a GSM version into any area with a potentially hazardous atmosphere. The GSM version is not rated for use in such environments and therefore such use may pose a threat of explosion.

P P T 2 8 0 0 S e r i e s f o r P o c k e t P C 2 0 0 2

Such areas are often, but not always, clearly marked. They may include below decks on boats; chemical transfer or storage facilities; fuel filling stations; areas where fuel odors are present such as in a tent or caravan where cooking or heating by bottled gas is taking place; fuel transfer or storage facilities; vehicles using liquid petroleum gas (lpg); areas where the air contains concentrations of grain, dust or metal powders; and any area where you would normally be advised to turn off your vehicle engine.

Blasting Areas

To avoid interference with any blasting operations, turn off your GSM version when in a blasting area and other areas where the use of radio equipment is prohibited. Obey all signs and instructions.

Laser Devices

Symbol products using lasers comply with US 21CFR1040.10, and IEC825-1:1993, EN60825-1:1994+A11:1996. The laser classification is marked on one of the labels on the product.

Class 1 Laser devices are not considered to be hazardous when used for their intended purpose. The following statement is required to comply with US and international regulations:

Caution: Use of controls, adjustments or performance of procedures other than those specified herein may result in hazardous laser light exposure.

Class 2 laser scanners use a low power, visible light diode. As with any very bright light source, such as the sun, the user should avoid staring directly into the light beam. Momentary exposure to a Class 2 laser is not known to be harmful.

Laser Devices

Symbol products using lasers comply with US 21CFR1040.10, and IEC825-1:1993, EN60825-1:1994+A11:1996. The laser classification is marked on one of the labels on the product.

Class 1 Laser devices are not considered to be hazardous when used for their intended purpose. The following statement is required to comply with US and international regulations:

Caution: Use of controls, adjustments or performance of procedures other than those specified herein may result in hazardous laser light exposure.

Class 2 laser scanners use a low power, visible light diode. As with any very bright light source, such as the sun, the user should avoid staring directly into the light beam. Momentary exposure to a Class 2 laser is not known to be harmful.

Q u i c k R e f e r e n c e

Scanner Labeling

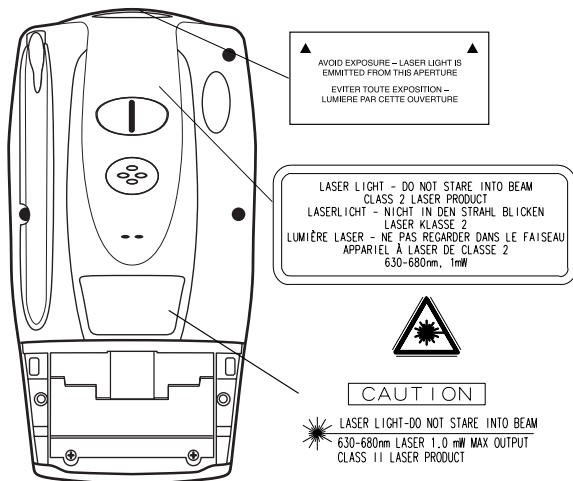

P P T 2 8 0 0 S e r i e s f o r P o c k e t P C 2 0 0 2

In accordance with Clause 5, IEC 0825 and EN60825, the following information is provided to the user:



ENGLISH

CLASS 1 LASER PRODUCT
LASER LIGHT
DO NOT STARE INTO BEAM
CLASS 2 LASER PRODUCT

DANISH

KLASSE 1 LASERPRODUKT
LASERLYF
SE IKKE IND I STRÅLEN
KLASSE 2 LASERPRODUKT
AL LASER DI CLASSE 2

DUTCH

KLASSE 1 LASERPRODUKT
LASERLICHT
NIET IN STRAAL STAREN
KLASSE-2 LASERPRODUKT

FINNISH

LUOKKA 1 LASERTUOTE
LASERVALO
ÄLÄ TUIJOTA SÄDETTÄ
LUOKKA 2 LASERTUOTE

FRENCH

CLASSE 1 PRODUIT LASER DE CLASSE 1
LUMIERE LASER
CLASSE 2 NE PAS REGARDER LE RAYON FIXEMENT
PRODUIT LASER DE CLASSE 2

GERMAN

KLASSE 1 LASERPRODUKT DER KLASSE 1
LASERSTRAHLEN
KLASSE 2 NICHT DIREKT IN DEN LASERSTRAHL SCHAUEN
LASERPRODUKT DER KLASSE 2

HEBREW

מוצר לייזר רמה 1 רמה 1
אור לייזר רמה 2
אין להביט אל תוך הזרם
מוצר לייזר רמה 2

ITALIAN

CLASSE 1 PRODOTTO AL LASER DI CLASSE 1
CLASSE 2 LUCE LASER
NON FISSARE IL RAGGIO/PRODOTTO

NORWEGIAN

KLASSE 1 LASERPRODUKT, KLASSE 1
KLASSE 2 LASERLYS IKKE STIRR INN I LYSSTRÅLEN
LASERPRODUKT, KLASSE 2

PORTUGUESE

CLASSE 1 PRODUTO LASER DA CLASSE 1
CLASSE 2 LUZ DE LASER NÃO FIXAR O RAIO LUMINOSO
PRODUTO LASER DA CLASSE 2

SPANISH

CLASE 1 PRODUCTO LASER DE LA CLASE 1
CLASE 2 LUZ LASER
NO MIRE FIJAMENTE EL HAZ
PRODUCTO LASER DE LA CLASE 2

SWEDISH

KLASS 1 LASERPRODUKT KLAS 1
KLASS 2 LASERLJUS STIRRA INTE MOT STRÅLEN
LASERPRODUKT KLAS 2

EID Number (PPT 2833 Only)

To enable CDPD service, contact your service provider to submit your Electronic Identification number (EID). This number is located on the back of your terminal.

Battery Caution

Caution: Danger of explosion if battery is incorrectly replaced. Replace only with the same or equivalent type recommended by the manufacturer. Dispose of used batteries according to the manufacturer's instructions.

DECLARATION OF CONFORMITY

We, Symbol Technologies, Inc.

of One Symbol Plaza, Holtsville, NY 11742-1300, USA

declare under our sole responsibility that the product

Spectrum24, LA3021, Type II Radio Card

Spectrum24, LA302C, Type II Radio Card

Spectrum24, LA302T, Type II Radio Card

to which this declaration relates, is in conformity with the following standards and/or other normative documents.

ETS 300 328 (November 1996)

ETS 300 826 (November 1997)

EN 60950: 1992 Incl Amdt 1-4, 11

We hereby declare that all essential radio test suites have been carried out and that the above named products is in conformity to al the essential requirements of Directive 1999/5/EC.

The conformity assessment procedure referred to in Article 10(5) and detailed in Annex IV of Directive 1999/5/EC has been followed with the involvement of the following Notified Body(ies):

BABT, Claremont House, 34 Molesey Road, Walton-on-Thames, KT12 4RQ

Identification mark: 0168

The equipment will also carry the
Class 2 equipment identifier



The technical documentation relevant to the above equipment can be made available for inspection on application to:

Symbol Technologies EMEA, Symbol Place, Winnersh Triangle, Berkshire, RG 41 5TP, UK

Dornu Narnor

(name)

Director, Regulatory and Technical Sales

(title)

(signature of authorised person)

3, May 2000

(date)

P P T 2 8 0 0 S e r i e s
f o r P o c k e t P C 2 0 0 2

DECLARATION OF CONFORMITY

We, Symbol Technologies, Inc.
of One Symbol Plaza, Holtville, NY 11742-1300, USA

declare under our sole responsibility that the product(s)

PPT 2837, GSM WAN Terminal

to which this declaration relates, is in conformity with the following standards and/or other normative documents.

Radio GSM: EN 301 419-1 v 4.1.1

EN 301 420 v 4.0.1

EMC: EN 301 489-1 v 1.2.1

EN 301 489-7 v 1.1.1

Safety: EN 60950: 1992 Incl Amdt 1-4, 11

Pr EN 50361:2000

We hereby declare that all essential radio test suites have been carried out and that the above named product(s) is in conformity with all the essential requirements of Directive 1999/5/EC.

The conformity assessment procedure referred to in Article 10(5) and detailed in Annex IV of Directive 1999/5/EC has been followed with the involvement of the following Notified Body(ies):
BABT, Claremont House, 34 Molesey Road, Walton-on-Thames, KT12 4RQ

Identification mark: 0168

The equipment will also carry the
Class 2 equipment identifier

The technical documentation relevant to the above equipment can be made available for inspection on application to:

Symbol Technologies EMEA, Symbol Place, Winnersh Triangle, Berkshire, RG 41 5TP, UK

Alan Parrish

(name)

Director, Regulatory

(title)



(signature of authorised person)

9 September 2001

(date)

Q u i c k R e f e r e n c e

Warranty

Symbol Technologies, Inc. ("Symbol") manufactures its hardware products in accordance with industry-standard practices. Symbol warrants that for a period of twelve (12) months from date of shipment, products will be free from defects in materials and workmanship.

This warranty is provided to the original owner only and is not transferable to any third party. It shall not apply to any product (i) which has been repaired or altered unless done or approved by Symbol, (ii) which has not been maintained in accordance with any operating or handling instructions supplied by Symbol, (iii) which has been subjected to unusual physical or electrical stress, misuse, abuse, power shortage, negligence or accident or (iv) which has been used other than in accordance with the product operating and handling instructions. Preventive maintenance is the responsibility of customer and is not covered under this warranty.

Wear items and accessories having a Symbol serial number, will carry a 90-day limited warranty. Non-serialized items will carry a 30-day limited warranty.

Warranty Coverage and Procedure

During the warranty period, Symbol will repair or replace defective products returned to Symbol's manufacturing plant in the US. For warranty service in North America, call the Symbol Support Center at 1-800-653-5350. International customers should contact the local Symbol office or support center. If warranty service is required, Symbol will issue a Return Material Authorization Number. Products must be shipped in the original or comparable packaging, shipping and insurance charges prepaid. Symbol will ship the repaired or replacement product freight and insurance prepaid in North America. Shipments from the US or other locations will be made F.O.B. Symbol's manufacturing plant.

Symbol will use new or refurbished parts at its discretion and will own all parts removed from repaired products. Customer will pay for the replacement product in case it does not return the replaced product to Symbol within 3 days of receipt of the replacement product. The process for return and customer's charges will be in accordance with Symbol's Exchange Policy in effect at the time of the exchange.

Customer accepts full responsibility for its software and data including the appropriate backup thereof.

Repair or replacement of a product during warranty will not extend the original warranty term.

Symbol's Customer Service organization offers an array of service plans, such as on-site, depot, or phone support, that can be implemented to meet customer's special operational requirements and are available at a substantial discount during warranty period.

General

Except for the warranties stated above, Symbol disclaims all warranties, express or implied, on products furnished hereunder, including without limitation implied warranties of merchantability and fitness for a particular purpose. The stated express warranties are in lieu of all obligations or liabilities on part of Symbol for damages, including without limitation, special, indirect, or consequential damages arising out of or in connection with the use or performance of the product. Seller's liability for damages to buyer or others resulting from the use of any product, shall in no way exceed the purchase price of said product, except in instances of injury to persons or property. Some states (or jurisdictions) do not allow the exclusion or limitation of incidental or consequential damages, so the preceding exclusion or limitation may not apply to you.

Service Information

Before you use the unit, it must be configured to operate in your facility's network and run your applications.

If you have a problem running your unit or using your equipment, contact your facility's Technical or Systems Support. If there is a problem with the equipment, they will contact the Symbol Support Center:

United States ¹	1-800-653-5350 1-631-738-2400	Canada	905-629-7226
United Kingdom	0800 328 2424	Asia/Pacific	337-6588
Australia	1-800-672-906	Austria/Österreich	1-505-5794
Denmark/Danmark	7020-1718	Finland/Suomi	9 5407 580
France	01-40-96-52-21	Germany/Deutschland	6074-49020
Italy/Italia	2-484441	Mexico/México	5-520-1835
Netherlands/Nederland	315-271700	Norway/Norge	66810600
South Africa	11-4405668	Spain/España	+913244000
Sweden/Sverige	84452900		
Latin America Sales Support	1-800-347-0178 Inside US +1-561-483-1275 Outside US		
Europe/Mid-East Distributor Operations	Contact local distributor or call +44 208 945 7360		

¹Customer support is available 24 hours a day, 7 days a week.

For the latest version of this guide go to: <http://www.symbol.com/manuals>



72-54893-01
Revision B — December 2001