



PPT 2800 Series



Product Reference Guide for Pocket PC 2002



***PPT 2800 Series
Product Reference Guide for Pocket PC 2002***

72-54894-03

Revision A

August 2002



© **2001-2002** by Symbol Technologies, Inc. All rights reserved.

No part of this publication may be reproduced or used in any form, or by any electrical or mechanical means, without permission in writing from Symbol. This includes electronic or mechanical means, such as photocopying, recording, or information storage and retrieval systems. The material in this manual is subject to change without notice.

The software is provided strictly on an “as is” basis. All software, including firmware, furnished to the user is on a licensed basis. Symbol grants to the user a non-transferable and non-exclusive license to use each software or firmware program delivered hereunder (licensed program). Except as noted below, such license may not be assigned, sublicensed, or otherwise transferred by the user without prior written consent of Symbol. No right to copy a licensed program in whole or in part is granted, except as permitted under copyright law. The user shall not modify, merge, or incorporate any form or portion of a licensed program with other program material, create a derivative work from a licensed program, or use a licensed program in a network without written permission from Symbol. The user agrees to maintain Symbol’s copyright notice on the licensed programs delivered hereunder, and to include the same on any authorized copies it makes, in whole or in part. The user agrees not to decompile, disassemble, decode, or reverse engineer any licensed program delivered to the user or any portion thereof.

Symbol reserves the right to make changes to any software or product to improve reliability, function, or design.

Symbol does not assume any product liability arising out of, or in connection with, the application or use of any product, circuit, or application described herein.

No license is granted, either expressly or by implication, estoppel, or otherwise under any Symbol Technologies, Inc., intellectual property rights. An implied license only exists for equipment, circuits, and subsystems contained in Symbol products.

Symbol, Spectrum One, and Spectrum24 are registered trademarks of Symbol Technologies, Inc. Other product names mentioned in this manual may be trademarks or registered trademarks of their respective companies and are hereby acknowledged.

Symbol Technologies, Inc.
One Symbol Plaza
Holtsville, New York 11742-1300
<http://www.symbol.com>



Contents

About This Guide

Introductionxi
Chapter Descriptionsxi
Notational Conventionsxii
Related Documentsxiii
Service Informationxiii
Symbol Support Centerxiv

Chapter 1. Getting Started

Chapter Contents	1-1
Introduction	1-3
Unpacking the Terminal	1-3
Parts of the PPT 2800	1-4
Accessories	1-6
Installing Batteries	1-6
Charging the Battery	1-8
Using the Cradle to Charge the Battery	1-8
Charging Spare Batteries	1-10
Using the Synchronization Cable to Charge the Battery	1-11
Checking Battery Power	1-12
Attaching the Handstrap	1-13
Attaching the Wrist Strap	1-13
Starting the PPT 2800	1-15
Aligning the Screen	1-15
Setting Time and Date	1-17
Setting Up Your Terminal	1-17

Chapter 2. Operating the PPT 2800

Chapter Contents	2-1
------------------------	-----

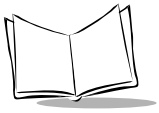

Introduction	2-3
Using the Power Button	2-3
Controlling the Contrast/Backlight	2-3
Using the Stylus	2-3
Today Screen	2-4
Status Icons	2-5
Selecting Programs	2-6
PPT 2800 Application Buttons	2-7
Using the Navigation Bar and Command Bar	2-8
Using Pop-up Menus	2-8
Notifications	2-9
Entering Information	2-10
Entering Information Using the Input Panel	2-10
Selecting Text	2-13
Writing on the Screen	2-13
Drawing on the Screen	2-17
Recording a Message	2-18
Entering Data via the Bar Code Scanner (Scan Wedge)	2-18
Using My Text	2-20
Finding Information	2-21
Scanning	2-22
Scanning PDF417 Bar Codes	2-22
Resetting Your PPT 2800 Terminal	2-23
Performing a Warm Boot	2-23
Performing a Cold Boot	2-24

Chapter 3. Customizing Your PPT 2800

Chapter Contents	3-1
Introduction	3-3
Adjusting Settings	3-3
Flash Storage	3-3
FFS Partitions	3-3
Working with FFS Partitions	3-4
Non-FFS Partitions	3-6
Downloading Partitions to the Terminal	3-6
Assigning Applications to Application Buttons	3-6
Assigning User-Written Applications to Buttons	3-7
Adding Programs	3-8
Adding a Program from the Internet	3-8
Adding a Program to the Start Menu	3-9
Removing Programs	3-10

Chapter 4. Communications

Chapter Contents	4-1
Introduction	4-3
Installing ActiveSync Software	4-3
Performing an ActiveSync for the First Time	4-3
Performing ActiveSync using the Synchronization Cable	4-5
Performing ActiveSync using the Cradle	4-6
Performing Subsequent ActiveSync Operations	4-8
Performing a Remote ActiveSync	4-8

Chapter 5. Applications

Chapter Contents	5-1
Introduction	5-3
Calendar	5-3
Creating Appointments	5-4
Using the Summary Screen	5-5
Creating Meeting Requests	5-5
Contacts	5-6
Using the Summary Screen	5-8
Tasks	5-9
Using the Summary Screen	5-11
Notes	5-12
Inbox	5-14
Synchronizing E-mail Messages	5-14
Connecting Directly to an E-mail Server	5-14
Using the Message List	5-16
Creating E-mail Messages	5-18
Managing E-mail Messages and Folders	5-19

Chapter 6. Companion Programs

Chapter Contents	6-1
Introduction	6-3
Pocket Word	6-3
Typing Mode	6-5
Writing Mode	6-6
Drawing Mode	6-7
Recording Mode	6-7
Pocket Excel	6-8
Tips for Working in Pocket Excel	6-9
MSN® Messenger	6-10
Setting Up Your Account	6-10

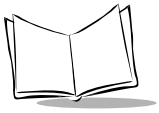

Working with Contacts	6-11
Chatting with Contacts	6-12

Chapter 7. Pocket Internet Explorer

Chapter Contents	7-1
Introduction	7-3
Mobile Favorites	7-3
Favorite Links	7-3
Creating Mobile Favorites	7-3
Saving Memory on your Terminal	7-4
Using AvantGo Channels	7-5
Using Pocket Internet Explorer	7-6
Browsing the Web	7-8

Chapter 8. Connections

Chapter Contents	8-1
Introduction	8-3
Transferring Items Using Infrared	8-4
Connecting to an ISP	8-4
Connecting to Your Network	8-7
Creating a Modem Connection to a Network	8-7
Disconnecting	8-9
Connecting Directly to an E-mail Server	8-9
Setting Up an E-mail Service	8-9
Getting Help Connecting	8-10

Chapter 9. Spectrum24 Network Configuration

Chapter Contents	9-1
Introduction	9-3
Configuring the PPT 2842 (2 MB Radio)	9-4
Network Adapters Properties	9-4
Using PPT 2842 Spectrum24 Settings	9-6
Using NICTT with the PPT 2842	9-13
Configuring the PPT 2846 (11 MB Radio)	9-19
Network Adapters Properties	9-19
Using NICTT with the PPT 2846	9-21

Chapter 10. Wireless Wide Area Network Configuration

Chapter Contents	10-1
Introduction	10-3

Multi-Network Support for IP Data over GPRS	10-3
Creating a GPRS Dial Up Networking (DUN) Connection	10-4
Sample Network Parameter Registry File	10-5
Configuring a CDPD WAN Connection (PPT 2833)	10-8
Configuration Wizard	10-8
Maintenance Screens and Menus	10-13
Modem Menu	10-19
Advanced Menu	10-20
Help	10-22
Configuring a GPRS WAN Connection (PPT 2837)	10-23
Connecting via GPRS	10-26
Configuring a GSM WAN Connection (PPT 2837)	10-28
Connecting via GSM	10-32

Chapter 11. Software Installation on Development PC

Chapter Contents	11-1
Introduction	11-3
Before You Install the SDK	11-3
Symbol Windows CE SDK	11-3
Installing the SDK on the Development PC	11-4
Installing the SDK	11-4
Installing Other Development Software	11-4

Chapter 12. Configuring the Terminal

Chapter Contents	12-1
Introduction	12-3
Starting Terminal Configuration Manager	12-3
Defining Script Properties	12-6
Creating the Script for the Hex Image	12-8
Open a New or Existing Script	12-8
Copy Components to the Script	12-9
Save the Script	12-9
Building the Image	12-10
Sending the Hex Image	12-12
Saving the Script	12-12
Connect The Terminal and Development PC	12-12
Begin the Send in TCM	12-12
Setting Up IPL to Receive the File	12-13
Error Messages	12-18
IPL Error Detection	12-18
TCM Error Messages	12-19
Creating a Splash Screen	12-20

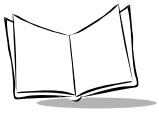

Creating a Splash Screen on Color Terminals 12-20
 Creating a Splash Screen on Monochrome Terminals 12-20
 Loading the Splash Screen via TCM 12-21

Chapter 13. Maintenance and Troubleshooting

Chapter Contents 13-1
 Introduction 13-3
 Maintaining the PPT 2800 13-3
 Troubleshooting 13-3

Appendix A. Block Recognizer Characters

Appendix B. Demo Program

Introduction B-1
 Scan Demo (VC Scan) B-3
 Scanning Data Fields B-3
 Scanning Options B-4
 ActiveX Demo (VB Scan) B-4
 HTML Scan Demo B-5
 Wedge On/Off B-5
 ScanBrowse B-6
 Files B-7
 MagStripe Reader B-8
 Sounds (Audio Sample) B-9
 Images (ImageViewer Sample) B-10
 CE Apps B-11
 About B-12
 Utilities B-12
 Control Panel B-13

Appendix C. GSM Demo Program

Introduction C-1
 GsmDemo Screens C-1
 Main Screen C-2
 Read SMS C-3
 Send SMS C-5
 Dial # C-6
 GsmDemo Menu Commands C-7
 Options Menu/Settings Screen C-7
 Help Menu C-12
 File Menu C-12

Appendix D. Technical Specifications

Environment	D-1
COM Port Definitions	D-2
Pin-Outs	D-3

Index

Feedback

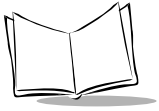

PPT 2800 Series Product Reference Guide for Pocket PC 2002

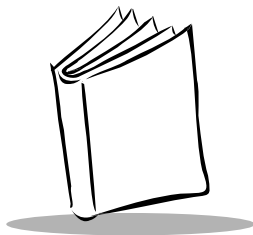

About This Guide

Introduction

The *PPT 2800 Series Product Reference Guide for Pocket PC 2002* provides information about the PPT 2800 Series terminal using the Pocket PC 2002 Operating System, and its accessories. The PPT 2800 Series includes the following variations of the terminal:

- PPT 2800: batch
- PPT 283x: Wireless WAN radio
- PPT 284x: Spectrum24 LAN radio

Chapter Descriptions

Topics covered in this guide are as follows:

- *Chapter 1, Getting Started* explains the physical buttons and controls on your PPT 2800 terminal, how to install and charge the batteries, start your PPT 2800 terminal for the first time, and attach the handstrap and wriststrap.
- *Chapter 2, Operating the PPT 2800* explains how to use your terminal, including instructions for powering on and resetting the terminal, entering information, scanning, and using the stylus.
- *Chapter 3, Customizing Your PPT 2800* explains how to adjust settings on the terminal, and add and delete programs.
- *Chapter 4, Communications* explains how to use Microsoft® ActiveSync™ for communications between the terminal and desktop computer.
- *Chapter 5, Applications* describes how to use the Calendar, Contacts, Tasks, Notes and Inbox applications.

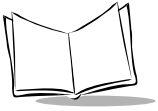

- *Chapter 6, Companion Programs* describes how to use Pocket Word, Pocket Excel, and MSN[®] Messenger.
- *Chapter 7, Pocket Internet Explorer* explains how to set up favorite links and channels, and browse the web on your terminal.
- *Chapter 8, Connections* describes how to connect the terminal to your network and e-mail server, and transfer information via infrared.
- *Chapter 9, Spectrum24 Network Configuration* describes how to configure the Spectrum24 wireless connection.
- *Chapter 10, Wireless Wide Area Network Configuration* describes how to configure the terminal for CDPD or GSM connection.
- *Chapter 11, Software Installation on Development PC* provides instructions for installing the Software Developer's Kit on your host PC.
- *Chapter 12, Configuring the Terminal* describes how to install and use the Terminal Configuration Manager (TCM) and Initial Program Loader (IPL).
- *Chapter 13, Maintenance and Troubleshooting* provides information to help you take proper care of your PPT 2800 terminal and solve problems that may come up.
- *Appendix A, Block Recognizer Characters* details how to write letters on your terminal using the Block Recognizer so they are correctly translated into text.
- *Appendix B, Demo Program* provides an overview of the PPT 2800 demo program applications, such as scanning, setup, diagnostic utilities, and file management.
- *Appendix C, GsmDemo Program* describes how to use the GSM Demo program, which allows you to explore what features GSM and the PPT 2837 terminal offer.
- *Appendix D, Technical Specifications* includes a table listing the technical specifications for the terminal.

Notational Conventions

This document uses these conventions:

- “terminal” or “PPT 2800” refers to any model of PPT 2800.
- “User” refers to anyone using an application on the PPT 2800.
- “You” refers to the End User, System Administrator or Technical Support person using this manual as a reference to install, configure, operate, maintain and troubleshoot the PPT 2800.
- *Italics* are used to highlight specific items in the general text, and to identify chapters and sections in this and related documents. It also identifies names of screens, menus, menu items, and fields within screens.

- Courier text identifies buttons to be tapped or clicked on screens.
- Bullets (•) indicate:
 - lists of alternatives or action items.
 - lists of required steps that are not necessarily sequential.
- Numbered lists indicate a set of sequential steps, i.e., those that describe step-by-step procedures.

Related Documents

The following documents provide more information on your PPT 2800 terminal.

- *PPT 2800 Quick Reference Guide*, p/n 72-54893-xx
- *CRD 2700-1000S Cradle Quick Reference Guide*, p/n 70-38707-xx
- *CRD 2700-4000E 4-Slot Ethernet Cradle Quick Reference Guide*, p/n 72-50357-xx
- *CHX700-4000C 4-Slot Charging Cradle Quick Reference Guide*, p/n 72-50367-xx
- *MDM 3000 Series Modem Module Quick Reference Guide*, p/n 72-42908-xx
- *VCA 3000 Charging Adapter Quick Reference Guide*, p/n 72-51938-xx
- *TRG 3000 Trigger Handle Quick Reference Guide*, p/n 72-51422-xx
- *Symbol Windows CE Software Developer's Kit (SDK)*, available at <http://devzone.symbol.com>.

Service Information

If you have a problem with the PPT 2800 equipment, contact the Symbol Support Center. If your problem cannot be resolved over the phone, you may need to return your equipment for servicing. If that is necessary, you will be given special directions.

Note: *Symbol Technologies is not responsible for any damages incurred during shipment if the approved shipping container is not used. Shipping the units improperly can possibly void the warranty. If the original shipping container has not been kept, contact Symbol to have another sent to you.*

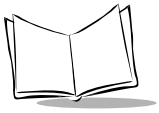

Symbol Support Center

For service information, warranty information or technical assistance contact or call the Symbol Support Center in:

United States¹

Symbol Technologies, Inc.
One Symbol Plaza
Holtsville, New York 11742-1300
1-800-653-5350

United Kingdom

Symbol Technologies
Symbol Place
Winnersh Triangle, Berkshire RG41 5TP
United Kingdom
0800 328 2424 (Inside UK)
+44 118 945 7529 (Outside UK)

Australia

Symbol Technologies Pty. Ltd.
432 St. Kilda Road
Melbourne, Victoria 3004
1-800-672-906 (Inside Australia)
+61-3-9866-6044 (Outside Australia)

Denmark/Danmark

Symbol Technologies AS
Dr. Neergaardsvej 3
2970 Hørsholm
7020-1718 (Inside Denmark)
+45-7020-1718 (Outside Denmark)

Finland/Suomi

Oy Symbol Technologies
Kaupintie 8 A 6
FIN-00440 Helsinki, Finland
9 5407 580 (Inside Finland)
+358 9 5407 580 (Outside Finland)

Canada

Symbol Technologies Canada, Inc.
2540 Matheson Boulevard East
Mississauga, Ontario, Canada L4W 4Z2
905-629-7226

Asia/Pacific

Symbol Technologies Asia, Inc.
230 Victoria Street #04-05
Bugis Junction Office Tower
Singapore 188024
337-6588 (Inside Singapore)
+65-337-6588 (Outside Singapore)

Austria/Österreich

Symbol Technologies Austria GmbH
Prinz-Eugen Strasse 70 / 2.Haus
1040 Vienna, Austria
01-5055794-0 (Inside Austria)
+43-1-5055794-0 (Outside Austria)

Europe/Mid-East Distributor Operations

Contact your local distributor or call
+44 118 945 7360

France

Symbol Technologies France
Centre d'Affaire d'Antony
3 Rue de la Renaissance
92184 Antony Cedex, France
01-40-96-52-21 (Inside France)
+33-1-40-96-52-50 (Outside France)

Germany/Deutschland

Symbol Technologies GmbH
Waldstrasse 66
D-63128 Dietzenbach, Germany
6074-49020 (Inside Germany)
+49-6074-49020 (Outside Germany)

Latin America Sales Support

7900 Glades Road
Suite 340
Boca Raton, Florida 33434 USA
1-800-347-0178 (Inside United States)
+1-561-483-1275 (Outside United States)

Netherlands/Nederland

Symbol Technologies
Kerkplein 2, 7051 CX
Postbus 24 7050 AA
Varsseveld, Netherlands
315-271700 (Inside Netherlands)
+31-315-271700 (Outside Netherlands)

South Africa

Symbol Technologies Africa Inc.
Block B2
Rutherford Estate
1 Scott Street
Waverly 2090 Johannesburg
Republic of South Africa
11-809 5311 (Inside South Africa)
+27-11-809 5311 (Outside South Africa)

Italy/Italia

Symbol Technologies Italia S.R.L.
Via Cristoforo Colombo, 49
20090 Trezzano S/N Naviglio
Milano, Italy
2-484441 (Inside Italy)
+39-02-484441 (Outside Italy)

Mexico/México

Symbol Technologies Mexico Ltd.
Torre Picasso
Boulevard Manuel Avila Camacho No 88
Lomas de Chapultepec CP 11000
Mexico City, DF, Mexico
5-520-1835 (Inside Mexico)
+52-5-520-1835 (Outside Mexico)

Norway/Norge

Symbol's registered and mailing address:
Symbol Technologies Norway
Hoybratenveien 35 C
N-1055 OSLO, Norway

Symbol's repair depot and shipping address:
Symbol Technologies Norway
Enebakkveien 123
N-0680 OSLO, Norway

+47 2232 4375

Spain/España

Symbol Technologies S.L.
C/ Peonias, 2
Edificio Piovera Azul
28042 Madrid, Spain
91 324 40 00 (Inside Spain)
+34 91 324 40 00 (Outside Spain)

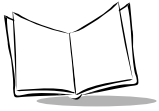

Sweden/Sverige

“Letter” address:

Symbol Technologies AB

Box 1354

S-171 26 SOLNA

Sweden

Visit/shipping address:

Symbol Technologies AB

Solna Strandväg 78

S-171 54 SOLNA

Sweden

Switchboard: 08 445 29 00 (domestic)

Call Center: +46 8 445 29 29 (international)

Support E-Mail:

Sweden.Support@se.symbol.com

¹Customer support is available 24 hours a day, 7 days a week.

If you purchased your Symbol product from a Symbol Business Partner, contact that Business Partner for service.

For the latest version of this guide go to:<http://www.symbol.com/manuals>.

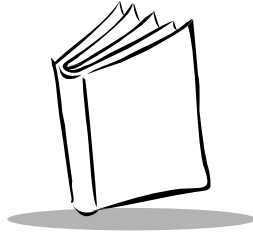

Chapter 1

Getting Started

Chapter Contents

Introduction	1-3
Unpacking the Terminal	1-3
Parts of the PPT 2800	1-4
Accessories	1-6
Installing Batteries	1-6
Charging the Battery	1-8
Using the Cradle to Charge the Battery	1-8
Charging Spare Batteries	1-10
Using the Synchronization Cable to Charge the Battery	1-11
Checking Battery Power	1-12
Attaching the Handstrap	1-13
Attaching the Wrist Strap	1-13
Starting the PPT 2800	1-15
Aligning the Screen	1-15
Setting Time and Date	1-17
Setting Up Your Terminal	1-17

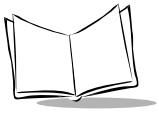

PPT 2800 Series Product Reference Guide for Pocket PC 2002

Introduction

This chapter explains the physical buttons and controls on your PPT 2800 terminal, how to install and charge the batteries, attach the handstrap, and start your PPT 2800 terminal for the first time.

Unpacking the Terminal

Carefully remove all protective material from around the terminal and save the shipping container for later storage and shipping.

Verify that you received all equipment listed on the packing slip and inspect the equipment for damage. If you are missing any equipment or if you find any damaged equipment, contact the Symbol Technologies Support Center immediately. See [page xiv](#) for contact information.

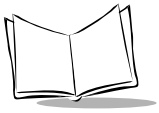

Parts of the PPT 2800

Front View

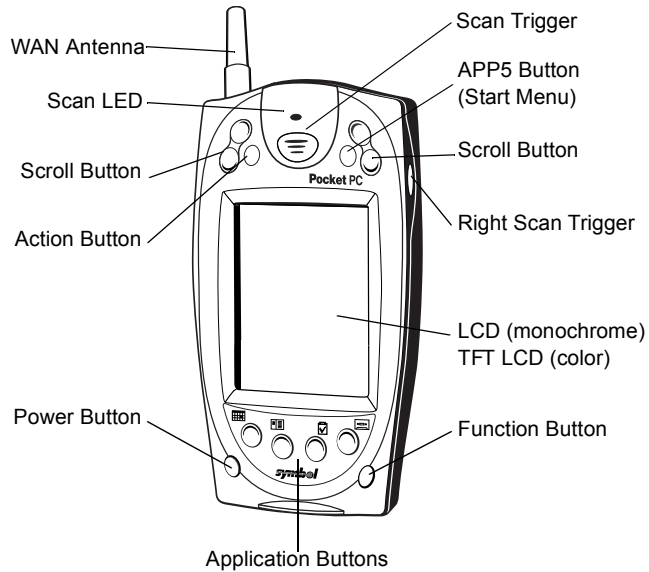

Left View

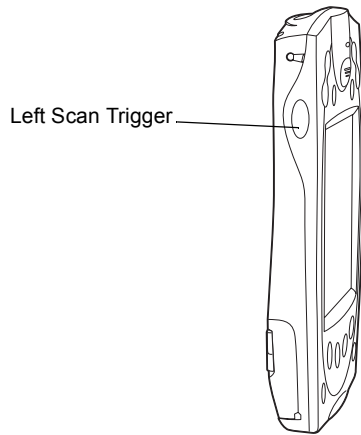

Figure 1-1. Parts of the PPT 2800

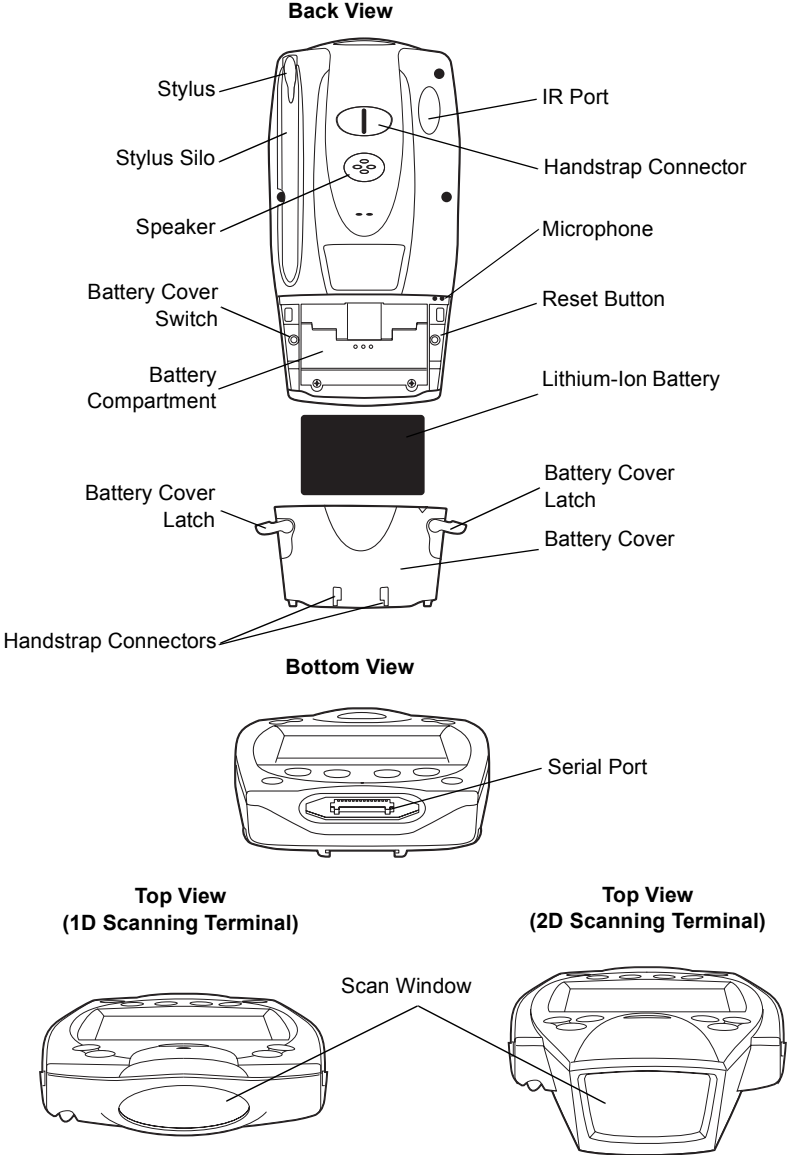
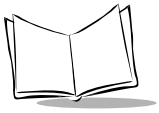

Figure 1-2. Parts of the PPT 2800 (continued)



Accessories

The following accessories are available for the PPT 2800:

- **Synchronization Charging Cable** synchronizes the PPT 2800 with a desktop computer, and can also be used to charge the terminal using an external power supply.
- **CRD 2700-1000S Single-Slot Charging Cradle** and **CHX 2700-4000C 4-Slot Charging Cradle** can also be used to charge the terminal.
- **CRD 2700-4000E 4-Slot Ethernet Cradle** charges the PPT 2800 and synchronizes the terminal with a desktop computer.
- **VCD X700-R000 Vehicle Cradle** powers the terminal and charges its battery, and can be used to communicate with other devices such as printers.
- **MDM 3003 Snap-On Modem Module** allows dial-up connections of the PPT 2800 terminal to a remote host computer, while maintaining the portability of the terminal.
- **VCA 3000 Auto Charging Adapter** connects to the cigarette lighter in a vehicle to charge the terminal.
- **TRG 3000 Trigger Handle** adds a trigger in scanning gun form to the PPT 2800, increasing comfort when using the terminal in scan-intensive applications for extended periods of time.
- **MSR 3006 Magstripe Reader Attachment** snaps on to the PPT 2800 to add magstripe capabilities.

Installing Batteries

Before using your PPT 2800, install the lithium-ion battery. The battery fits behind the battery cover on the back of the PPT 2800.

To install the battery in your PPT 2800:

1. Open the latches on the battery cover and lift the battery cover away from the PPT 2800.

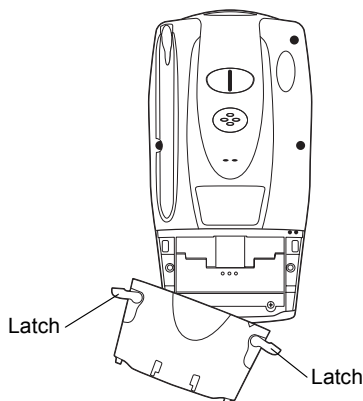

Figure 1-3. Removing the Battery Cover

2. Insert the lithium-ion battery in the battery compartment with the battery tether positioned properly (as shown below), making sure the battery snaps into place.

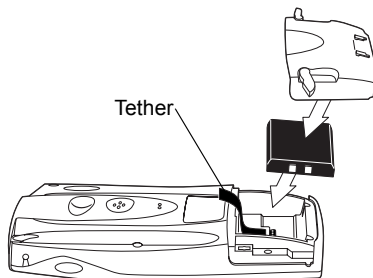
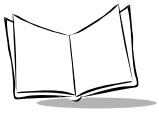

Figure 1-4. Inserting the Battery

3. Replace the battery cover by inserting the bottom first, then pressing the top in firmly while securing the latches.

Note: *Be careful to position the battery latches completely open while placing the battery cover on the terminal.*

Charge the battery in the terminal for approximately 2 1/2 hours before initial use.



Charging the Battery

Before using your terminal for the first time, charge the battery. Also, when battery voltage is low, a warning message appears indicating the battery needs to be charged. You can charge the battery using either the CRD 2700 cradle or the Synchronization Cable.

Your terminal is equipped with a memory backup battery which automatically charges from the fully-charged lithium-ion battery. This backup battery retains data in memory when the terminal's battery is removed, and takes about 10 hours to charge when you first use your terminal.

Note: *If you remove your lithium-ion battery before the backup battery is fully charged, data may be lost. For this reason, DO NOT remove the battery within the first ten hours of use.*

Using the Cradle to Charge the Battery

To charge the terminal's battery using the CRD 2700 cradle:

1. Connect the power supply to the power port on the back of the cradle, and the other end of the power supply to a wall outlet.

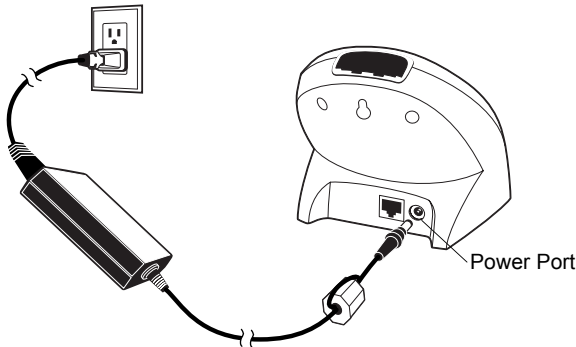

Figure 1-5. Connecting the Power Supply

2. Connect the cradle to your computer by plugging the serial cable into the serial port on the back of the cradle, and the other end of the cable into the serial port on your computer.

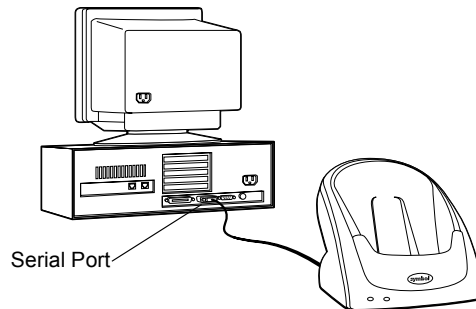

Figure 1-6. Connecting the Cradle to the Host Computer

3. Insert the PPT 2800 terminal in the cradle.

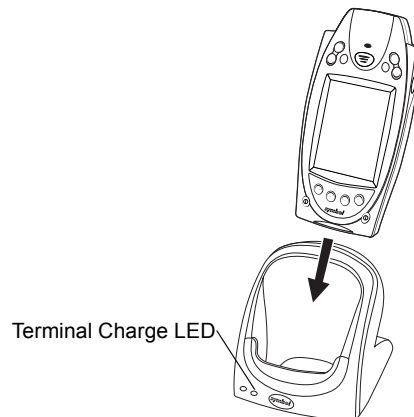

Figure 1-7. Inserting the Terminal in the Cradle

4. The Terminal Charge LED turns red to indicate charging, then green when the battery is fully charged.

Note: *If the cradle is not connected to the host computer via serial cable, the Terminal Charge LED shuts off when the battery is fully charged.*

The terminal's battery is fully charged after approximately 2 1/2 hours.



Note: *If the battery in the terminal is low, the Terminal Charge LED may flicker or turn yellow during an ActiveSync operation. The LED returns to red when the operation is complete.*

Charging Spare Batteries

To charge a spare battery, insert the battery in the spare battery charging slot in the back of the cradle, oriented so the contacts are facing down and towards the back of the cradle. Press the battery down into the slot until firmly seated.

The Spare Battery Charge LED turns red to indicate charging, then green when the battery is fully charged. The battery is fully charged after approximately 2 1/2 hours.

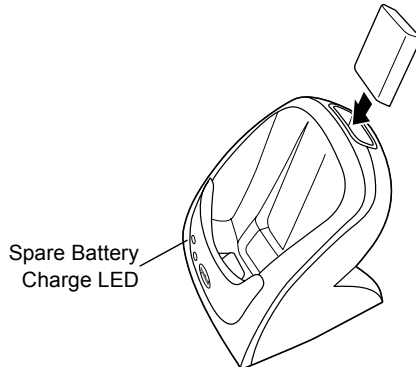

Figure 1-8. Charging the Spare Battery

Using the Synchronization Cable to Charge the Battery

To charge the terminal's battery using the optional Synchronization Cable:

1. Insert the cable into the bottom of the terminal.

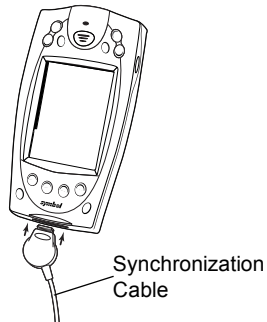

Figure 1-9. Inserting the Cable in the Terminal

2. Plug the power cable into a wall outlet and plug the other end into the battery charging receptacle on the side of the Synchronization Cable.

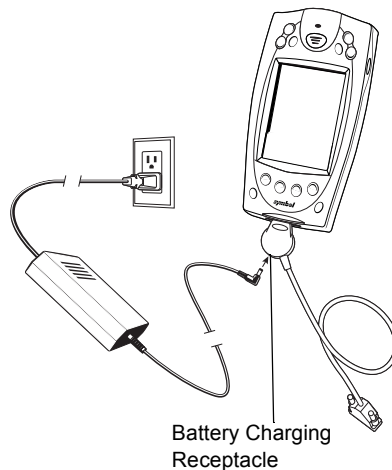
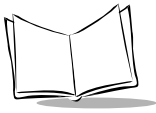

Figure 1-10. Connecting the Power Cable



Checking Battery Power

To check whether the battery in the terminal is charged, tap **Start, Settings, System, Power** to display the following Battery Status screen.

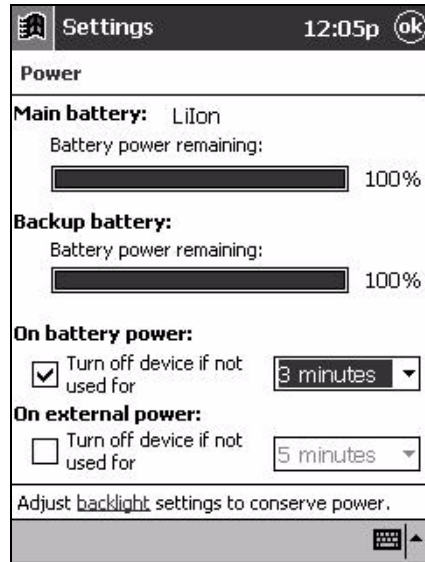

Figure 1-11. Battery Status Screen

To save battery power, set your terminal to turn off after a specified number of minutes on battery power.

Attaching the Handstrap

The PPT 2800 has an optional handstrap which increases comfort when holding the terminal for extended periods of time. To attach the handstrap to the back of the terminal:

1. Thread the round metal piece through the metal handstrap connector on the back of the terminal.
2. Slide the flat metal piece into the handstrap connection on the bottom of the terminal.

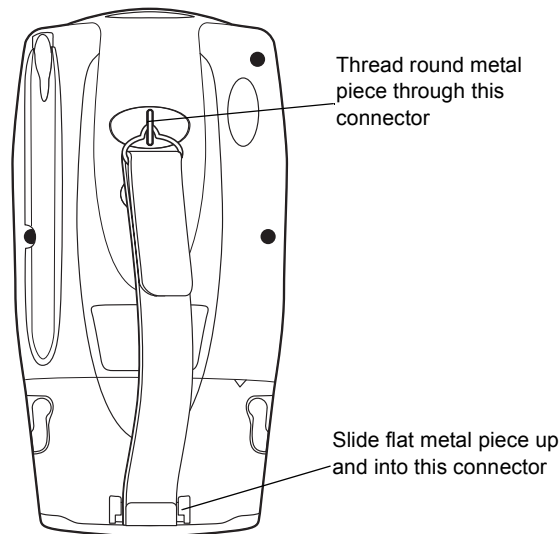

Figure 1-12. Attaching the Handstrap

3. Adjust the velcro strap to fit your hand.

Attaching the Wrist Strap

An optional wrist strap is available which helps prevent damage to the terminal if you drop it. To attach the wrist strap:

1. Thread the elastic band on the wrist strap through the metal handstrap connector on the back of the terminal.

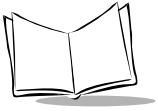

2. Slip the strap through the elastic band on the other side of the connector, and pull it through to secure the strap to the connector.

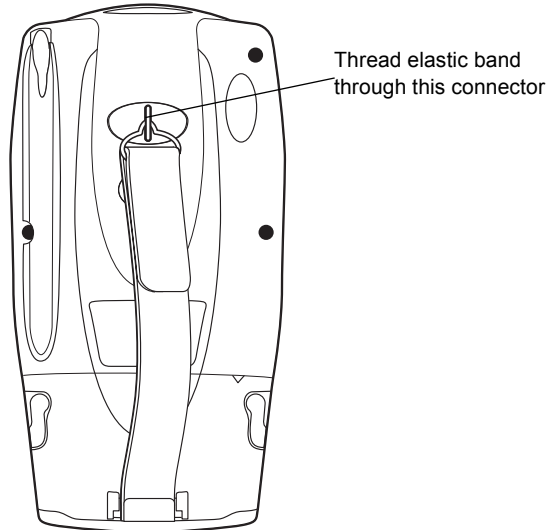

Figure 1-13. Attaching the Wriststrap

3. Slide your hand through the strap.

Starting the PPT 2800

After installing and charging the battery, start the terminal by pressing the red power button. If the terminal does not power on, reset it. See [Performing a Cold Boot](#) on page 2-24.

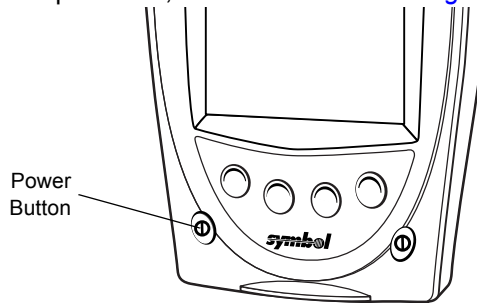

Figure 1-14. Power Button

As the terminal initializes its unique Flash File system, the Symbol splash screen displays for about a minute. When the Welcome screen appears, tap anywhere on the screen to continue to the Align screen.

Aligning the Screen

To align your PPT 2800 so the cursor on the touch screen aligns with the tip of your stylus:

1. If necessary, adjust the contrast on the PPT 2800 so the screen is clear and readable. See [Controlling the Contrast/Backlight](#) on page 2-3 for instructions.
2. Remove the stylus from its storage silo on the back of the PPT 2800.
3. Tap the center of each target that appears on the screen with the tip of the stylus.

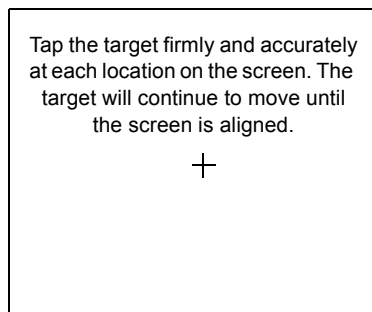
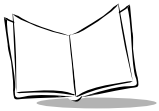

Figure 1-15. Tapping the Target



- Follow the directions on the screen which lead you through a simple exercise illustrating how to use the stylus and pop-up menus.

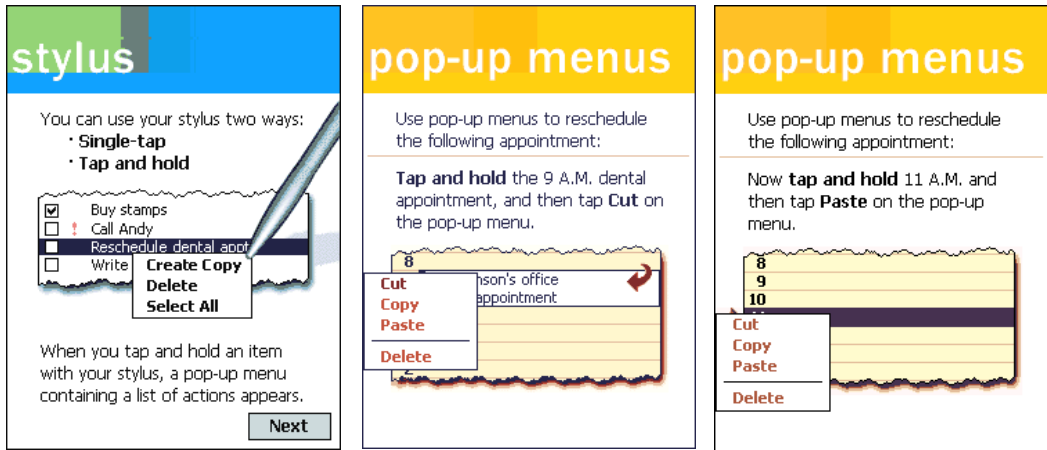

Figure 1-16. Using Pop-up Menus

- Use the drop-down menu to set your time zone, and tap Next.

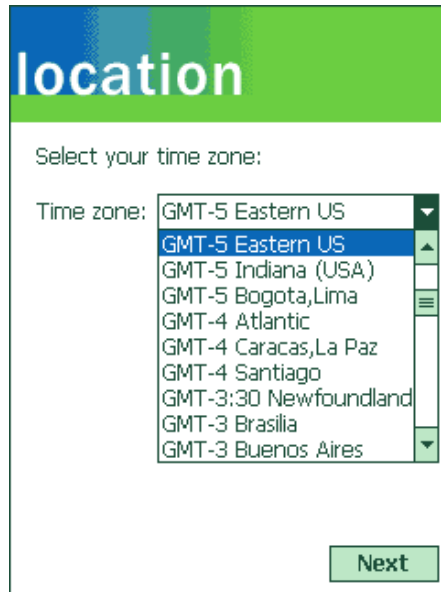

Figure 1-17. Setting Time Zone on the PPT 2800

Note: These initial setup screens appear each time you perform a hard reset.

Setting Time and Date

The Time and Date screen does not appear after setting the time zone. Use the clock control panel applet to set the time and date after a cold boot.

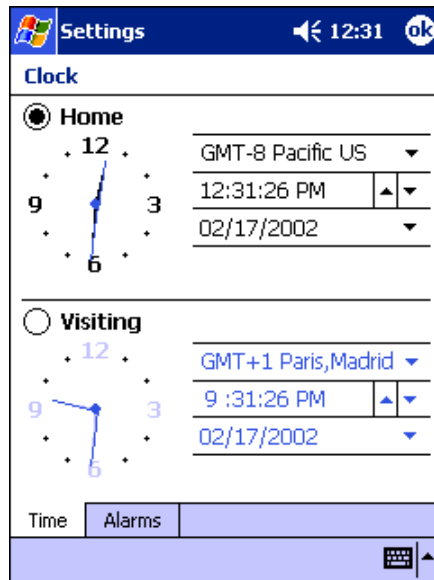
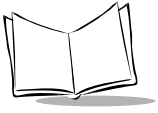

Figure 1-18. Setting Time and Date

Setting Up Your Terminal

Refer to the following chapters for setting up your terminal:

- For customizing the settings on your PPT 2800, see [Chapter 3, Customizing Your PPT 2800](#).
- To set up ActiveSync to synchronize your terminal with your desktop computer, see [Chapter 4, Communications](#).
- To set up connections with a network, ISP, or e-mail server, see [Chapter 8, Connections](#).



- To configure your PPT 284X for Spectrum24, see [Chapter 9, *Spectrum24 Network Configuration*](#).
- To configure your PPT 283X for WWAN support, see [Chapter 10, *Wireless Wide Area Network Configuration*](#).
- To install development software on your development PC, see [Chapter 11, *Software Installation on Development PC*](#).
- To configure your terminal using the Terminal Configuration Manager, see [Chapter 12, *Configuring the Terminal*](#).

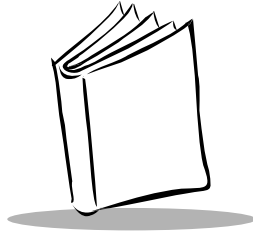

Chapter 2

Operating the PPT 2800

Chapter Contents

Introduction	2-3
Using the Power Button	2-3
Controlling the Contrast/Backlight	2-3
Using the Stylus	2-3
Today Screen	2-4
Status Icons	2-5
Selecting Programs	2-6
PPT 2800 Application Buttons	2-7
Using the Navigation Bar and Command Bar	2-8
Using Pop-up Menus	2-8
Notifications	2-9
Entering Information	2-10
Entering Information Using the Input Panel	2-10
Selecting Text	2-13
Writing on the Screen	2-13
Drawing on the Screen	2-17
Recording a Message	2-18
Entering Data via the Bar Code Scanner (Scan Wedge)	2-18
Using My Text	2-20
Finding Information	2-21
Scanning	2-22
Scanning PDF417 Bar Codes	2-22
Resetting Your PPT 2800 Terminal	2-23
Performing a Warm Boot	2-23
Performing a Cold Boot	2-24

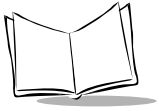

PPT 2800 Series Product Reference Guide for Pocket PC 2002

Introduction

This chapter provides basic instructions for using and navigating your PPT 2800 terminal.

Using the Power Button

Press the red power button on the lower left-hand side of the terminal to turn the PPT 2800 on and off.

Controlling the Contrast/Backlight

The Function button allows you to adjust the contrast of the screen and control the backlight.

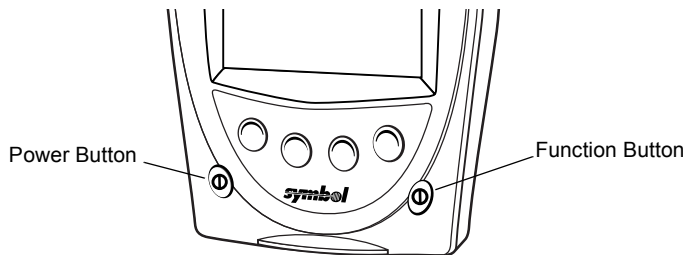

Figure 2-1. Power and Function Buttons

To adjust the contrast (monochrome LCD) or backlight (color TFT LCD):

1. Press and hold the Function button.
2. Press the “up” scroll button at the top of the terminal to lighten the screen, or the “down” scroll button to darken the screen.

To turn the backlight on or off:

1. Press and hold the Function button.
2. Press any Application button.

Using the Stylus

Your PPT 2800 has a stylus for selecting items and entering information. The stylus functions as a mouse.

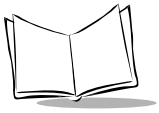

- **Tap:** Touch the screen once with the stylus to open items and select options.
- **Drag:** Hold the stylus on the screen and drag across the screen to select text and images. Drag in a list to select multiple items.
- **Tap-and-hold:** Tap and hold the stylus on an item to see a list of actions available for that item. On the pop-up menu that appears, tap the action you want to perform.

Today Screen

When you turn on your terminal for the first time each day (or after 4 hours of inactivity), the Today screen appears. You can also display it by tapping , then Today. On the Today screen, you can see important information for the day.

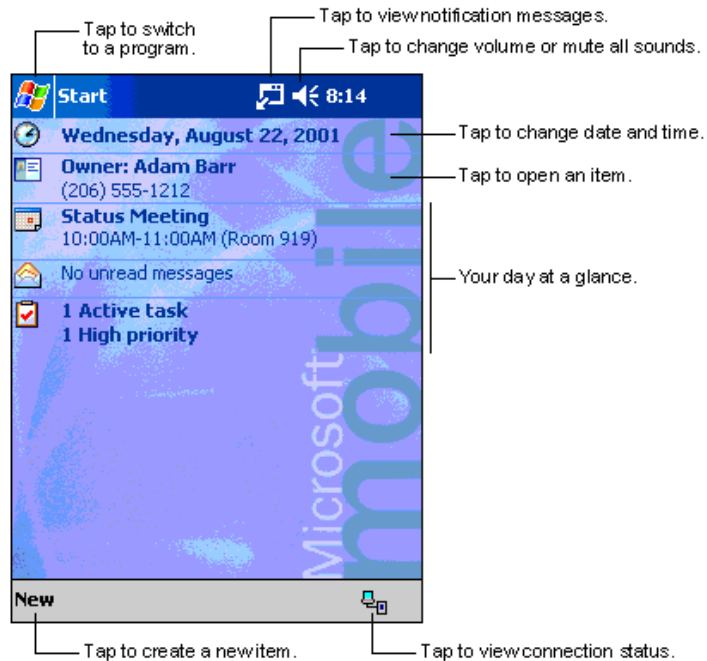













Figure 2-2. Today Screen

Status Icons

You may see the following status icons on the command bar located at the bottom of the screen:

Table 2-1. Status Icons

Icon	Meaning
	Turns all sounds on and off.
	Backup battery is low.
	Main batteries are charging.
	Main batteries are low.
	Main batteries are very low.
	Main batteries are full.
	Connection is active.
	Synchronization is beginning or ending.
	Synchronization is occurring.
	Notification that one or more instant messages were received.
	Notification that one or more e-mail messages were received.
	There are more notification icons than can be displayed. Tap to display remaining icons.

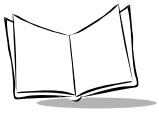

Selecting Programs

To select a program, tap *Start, Programs*, then the program name. (To select which programs appear on the *Program* menu, see [Chapter 3, Customizing Your PPT 2800](#).)

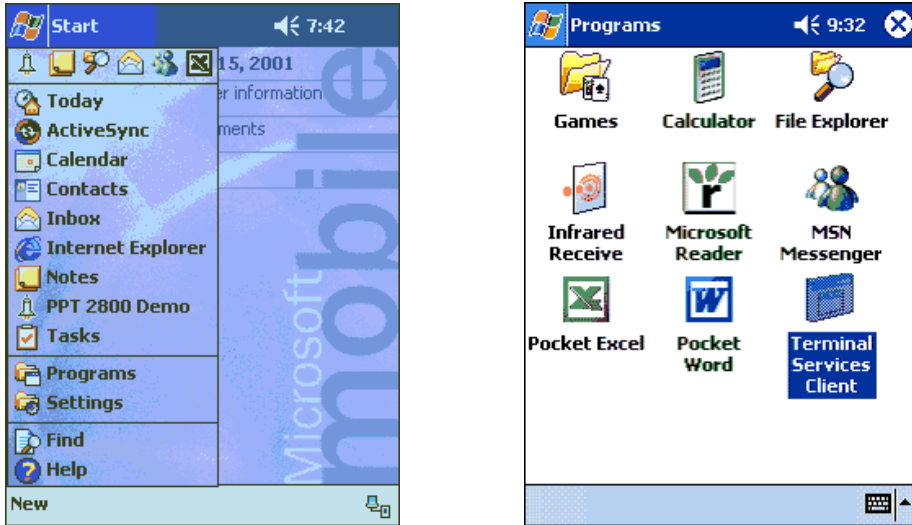





Figure 2-3. Start Menu

Note: Some programs have abbreviated labels for check boxes and drop-down menus. To see the full label, hold the stylus on the label. Drag the stylus off the label so that the command is not carried out.

PPT 2800 Application Buttons

Table 2-2 lists the default programs you can access by pressing an application button on the front of the terminal. The icons on the buttons identify the programs they access.

Table 2-2. Program Icons

Icon	Button	Program	Description
	App 1	Calendar	Keep track of your appointments and create meeting requests.
	App 2	Contacts	Keep track of your friends and colleagues.
	App 3	Tasks	Keep track of your tasks.
	App 4	Notes	Create handwritten or typed notes, drawings, and recordings.

You can assign a different application to each application button. See [Assigning Applications to Application Buttons](#) on page 3-6.

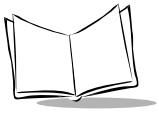

Using the Navigation Bar and Command Bar

The navigation bar at the top of the screen displays the active program and current time, and allows you to select programs and close screens.

Use the command bar at the bottom of the screen to perform tasks in programs. The command bar includes menu names, buttons, and the input panel button. To create a new item in the current program, tap *New*. To see the name of a button, hold the stylus on the button. Drag the stylus off the button so the command is not carried out.

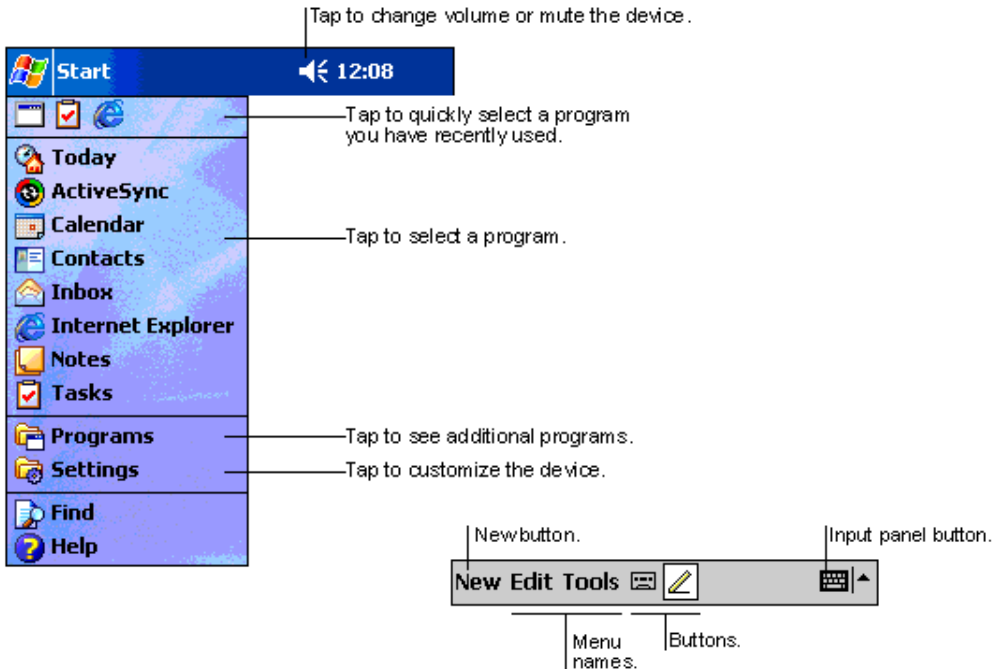

Figure 2-4. Screen Navigation

Using Pop-up Menus

With pop-up menus, you can quickly choose an action for an item. For example, use the pop-up menu in the contact list to delete a contact, make a copy of a contact, or send an e-mail message to a contact. The actions in the pop-up menu vary from program to program.

To access a pop-up menu, hold the stylus on the item you want to perform the action on. When the menu appears, lift the stylus, and tap the action to perform, or tap outside the menu to close it without performing an action.

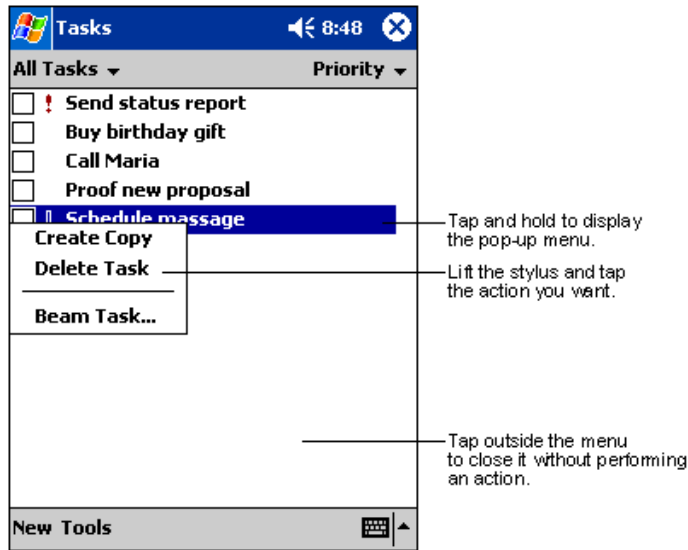

Figure 2-5. Pop-up Menu

Notifications

Your PPT 2800 notifies you when you have something to do. For example, if you've set up an appointment in Calendar, a task with a due date in Tasks, or an alarm in Clock, you'll be notified in any of the following ways:

- a message box appears on the screen
- a sound, which you can set, is played
- a light flashes on your terminal.

To choose reminder types and sounds for your terminal, tap the *Start* menu, then *Settings*. In the *Personal* tab, tap *Sounds & Notifications*. Select the desired options.

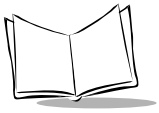

Entering Information

To enter information, you may:

- Use the input panel to enter typed text, either using the soft keyboard or writing characters.
- Write directly on the screen.
- Draw pictures on the screen.
- Speak into the microphone to record a message.
- Scan bar code data into data fields.
- Use Microsoft® ActiveSync® to synchronize or copy information from your desktop computer to your terminal. For more information on ActiveSync, see [Chapter 4, Communications](#) or ActiveSync Help on your desktop computer.

Note: *Microsoft Transcriber input method is not included on your PPT 2800. You may download Transcriber from Microsoft's website and install it in the terminal's RAM.*

Entering Information Using the Input Panel

Use the input panel to enter information in any program. You can either type using the soft keyboard or write using Block Recognizer, or Letter Recognizer. In any case, the characters appear as typed text on the screen.

To show or hide the input panel, tap the Input Panel button. Tap the arrow next to this button to view input methods.

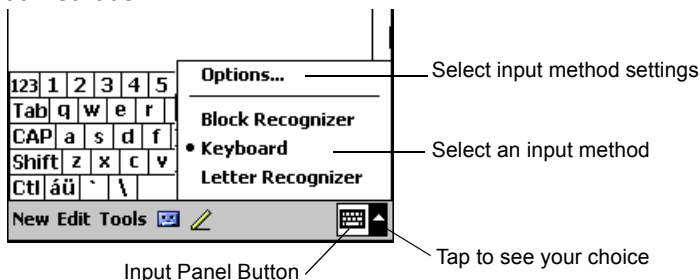

Figure 2-6. Input Panel Button

When you use the input panel, your terminal anticipates the word you are typing or writing and displays it above the input panel. When you tap the displayed word, it is inserted into your text at the insertion point. The more you use your terminal, the more words it learns to anticipate.

To change input settings, such as the number of words suggested at one time, tap *Options* from the Input Panel menu, and tap the tabs to see each setting screen.

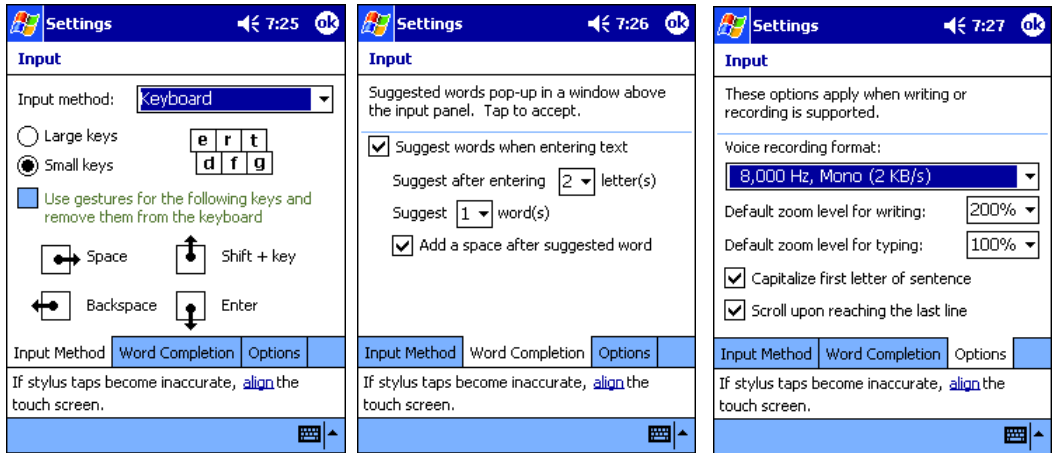

Figure 2-7. Input Panel Options

Using the Soft Keyboard

To type with the soft keyboard:

1. Tap the arrow next to the Input Panel button, then *Keyboard*.
2. On the soft keyboard, tap the keys with your stylus.



Figure 2-8. Soft Keyboard

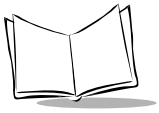

Using the Block Recognizer

To use Block Recognizer:

1. Tap the arrow next to the Input Panel button, then *Block Recognizer*.
2. Write a letter in the left side of the box, or a number in the right side, using special character strokes.

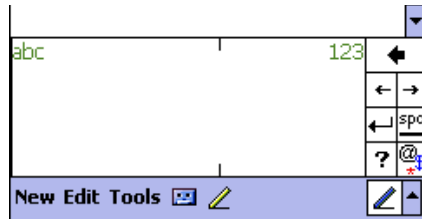

Figure 2-9. Block Recognizer

When you write a letter, it is converted to typed text on the screen. For specific instructions on using Block Recognizer, with Block Recognizer open, tap the question mark next to the writing area, or see [Appendix A, Block Recognizer Characters](#).

Using the Letter Recognizer

To use Letter Recognizer:

1. Tap the arrow next to the Input Panel button, then *Letter Recognizer*.
2. Write letters or numbers in the writing area, just as you would on paper. Write capital letters in the left side of the box, numbers in the right side, and lower case letters in the center.

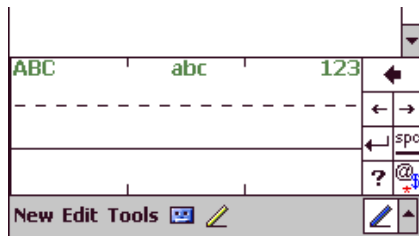

Figure 2-10. Letter Recognizer

When you write a letter, it is converted to typed text on the screen. For instructions on using Letter Recognizer, with Letter Recognizer open, tap the question mark next to the writing area.

Selecting Text

To edit or format typed text, select it by dragging the stylus across the text. Cut, copy, and/or paste text by holding the selected words then tapping an editing command on the pop-up menu, or by tapping the command on the *Edit* menu.

Writing on the Screen

In any program that accepts writing, such as the Notes program and the *Notes* tab in Calendar, Contacts, and Tasks, you can use your stylus to write directly on the screen.

To write on the screen, tap the **Pen** button to switch to writing mode. Lines appear on the screen to guide you.

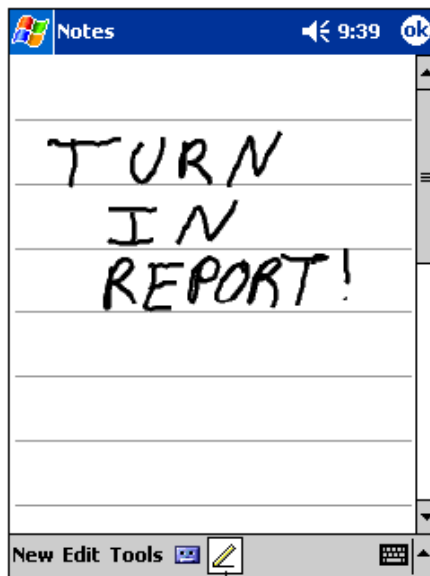

Tap the Pen button and use your stylus like a pen.

Figure 2-11. Writing on the Screen

Note: Some programs that accept writing do not have the Pen button. See the documentation for that program to find out how to switch to writing mode.

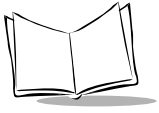

Selecting Writing

To select writing to edit or format:

1. Tap and hold the stylus next to the text you want to select until the insertion point appears.
2. Drag the stylus across the text.

If you accidentally write on the screen, tap *Tools*, then *Undo* and try again. You can also select text by tapping the **Pen** button to deselect it, then dragging the stylus across the screen.

You can cut, copy, and paste written text in the same way you work with typed text: tap and hold the selected words, then tap the command from the pop-up menu, or select the command from the *Edit* menu.

Converting Writing to Text

To convert your writing to text, tap *Tools*, then *Recognize*.

To convert certain words, select them before tapping *Recognize* on the *Tools* menu (or tap and hold the selected words, then tap *Recognize* on the pop-up menu). If a word is not recognized, it is left as writing.

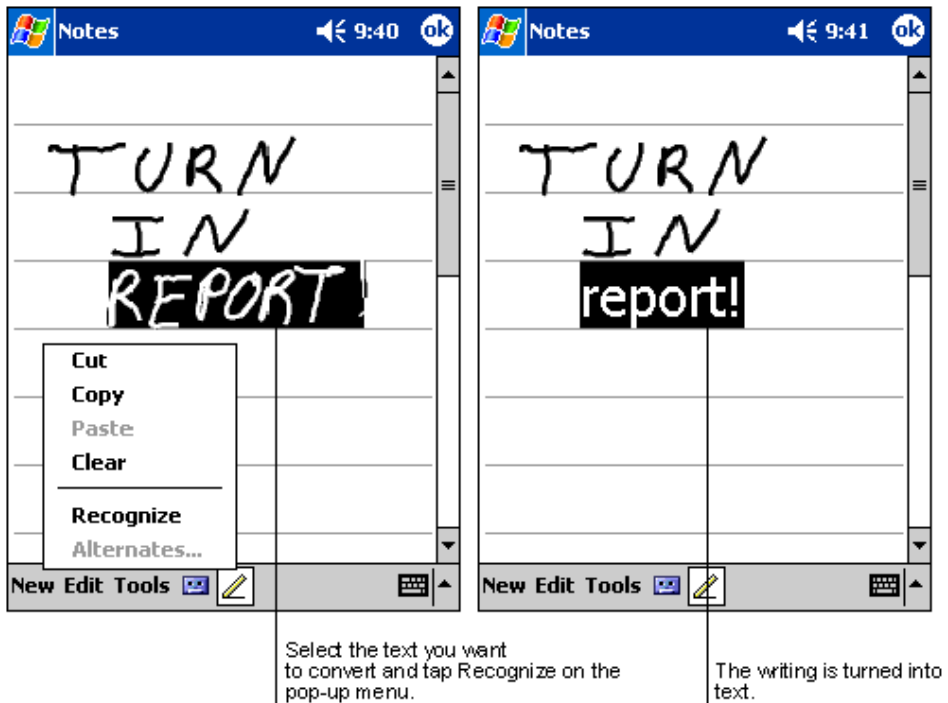
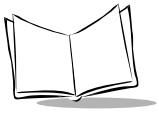

Figure 2-12. Writing on the Screen

If the conversion is incorrect, select different words from a list of alternates or return to the original writing. Tap and hold the incorrect word only. On the pop-up menu, tap *Alternates*.



A list of alternate words appears. Tap the word you want to use, or tap the writing at the top of the menu to return to the original writing.

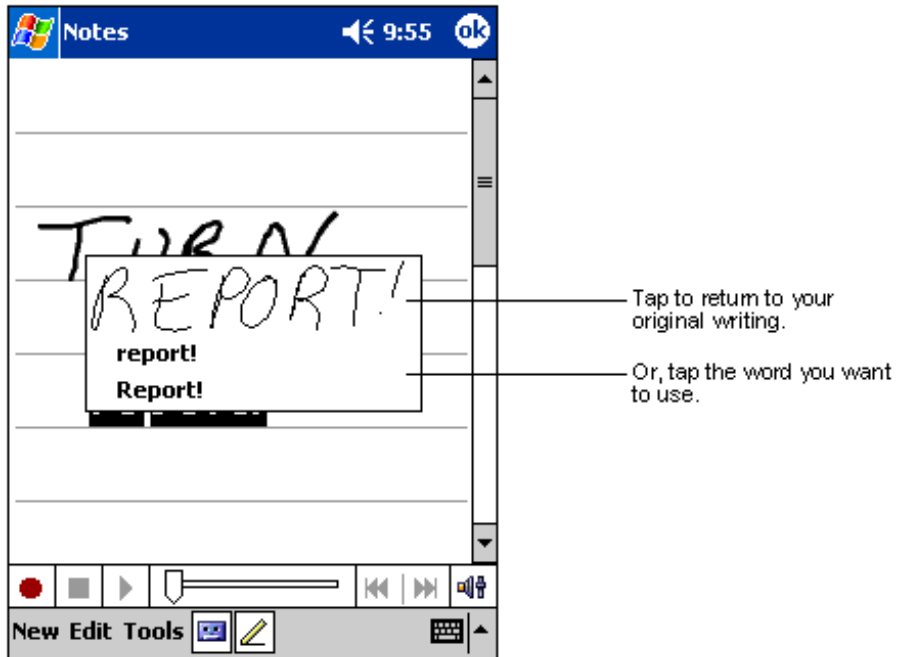

Figure 2-13. Alternate List

Writing Tips

- Write neatly.
- Write on the lines and draw descenders below the line. Cross of the "t" and write apostrophes below the top line so they are not confused with the word above. Write periods and commas above the line.
- For better recognition, try increasing the zoom level to 300% using the *Tools* menu.
- Leave large gaps between words so your terminal can easily tell where words begin and end.
- Hyphenated words, foreign words that use special characters such as accents, and some punctuation cannot be converted.

- If you add writing to a word to change it (such as changing a "3" to an "8") after you attempt to recognize the word, the writing you add is not included if you try to recognize the writing again.

Drawing on the Screen

Drawing on the screen is similar to writing on the screen. To create a drawing, cross three ruled lines on your first stroke. A drawing box appears. Subsequent strokes in or touching the drawing box become part of the drawing. Drawings that do not cross three ruled lines are treated as writing.

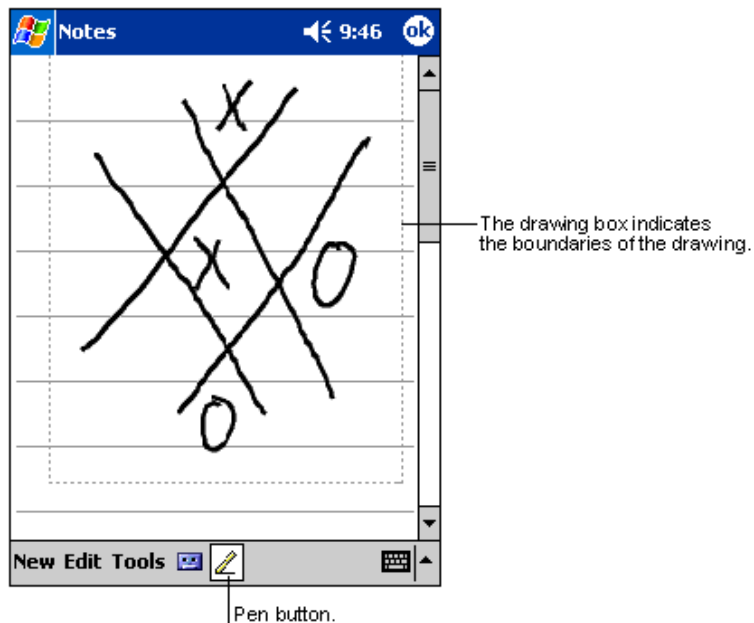
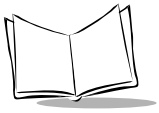

Figure 2-14. Drawing on the Screen

Note: To change the zoom level, tap Tools, then a zoom level.

Selecting a Drawing

To select a drawing to edit or format, tap and hold the stylus on the drawing until the selection handle appears.



To select multiple drawings, deselect the `Pen` button, then drag to select the drawings you want.

To cut, copy, and paste drawings, tap and hold the selected drawing, then tap an editing command on the pop-up menu, or tap the command on the *Edit* menu. To resize a drawing, deselect the `Pen` button and drag a selection handle.

Recording a Message

You may record a message to capture thoughts, reminders, and phone numbers. In Calendar, Tasks, and Contacts, you can include a recording in the *Notes* tab. In the Notes program, you can either create a stand-alone recording or include a recording in a written note. To include the recording in a note, open the note first.

To create a recording:

1. Hold the terminal's microphone near your mouth or other source of sound.
2. Tap the `Record` button. A beep sounds, instructing you to begin recording.
3. While holding down the `Record` button, make your recording.
4. When you are finished, tap the `Stop` button. Two beeps sound. The new recording appears in the note list or as an embedded icon.

Entering Data via the Bar Code Scanner (Scan Wedge)

Using the Scan Wedge program, the integrated bar code scanner on your terminal can scan data into data fields in the same way data is entered via the keyboard. See [HTML Scan Demo](#) on page B-5 for more information.

To play a recording, tap it in the list or tap its icon in the note.

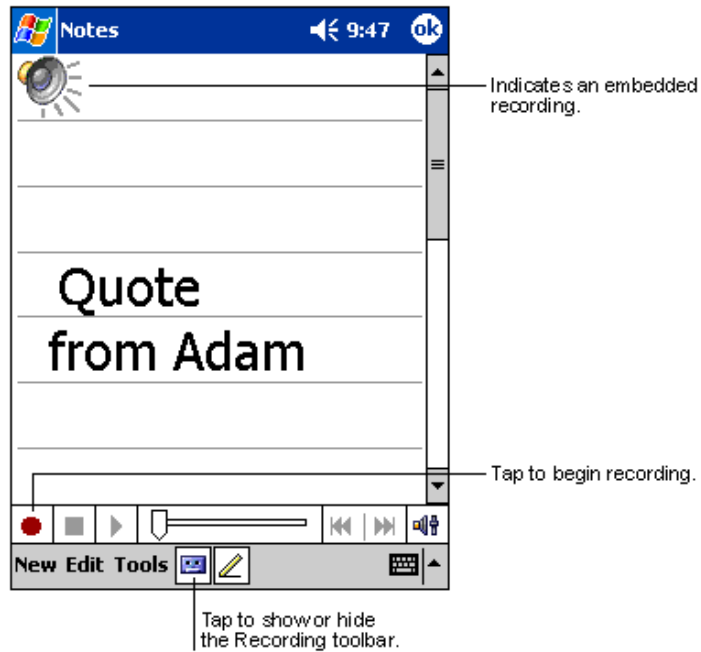
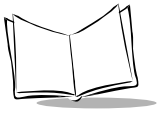

Figure 2-15. Recording Screen



Using My Text

When using Inbox or MSN Messenger, use My Text to quickly insert preset or frequently used messages into the text entry area. To insert a message, tap *My Text* and tap a message.

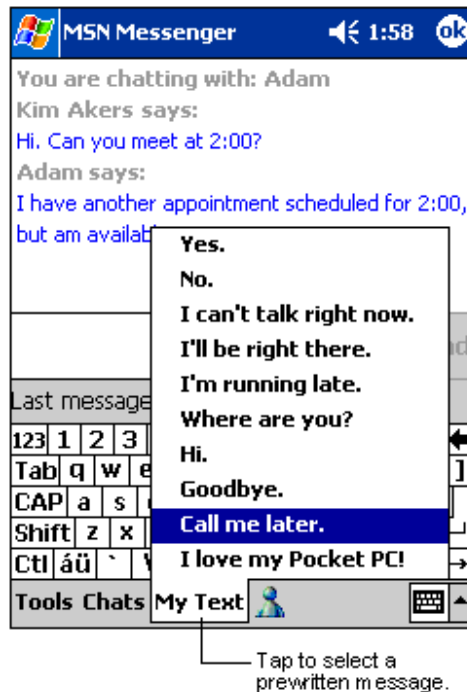

Figure 2-16. Using My Text

Note: You can add text after inserting a My Text message before sending it.

To edit a My Text message, in the *Tools* menu, tap *Edit*, then *My Text Messages*. Select the message you wish to edit and make the changes.

Finding Information

The Find feature locates information. On the *Start* menu, tap *Find*. Enter the text you want to find, select a data type, then tap *Go*.

To find information taking up storage space on your terminal, select *Larger than 64 KB* in *Type*.

You can also use the File Explorer to find files and organize them into folders. On the *Start* menu, tap *Programs*, then *File Explorer*.

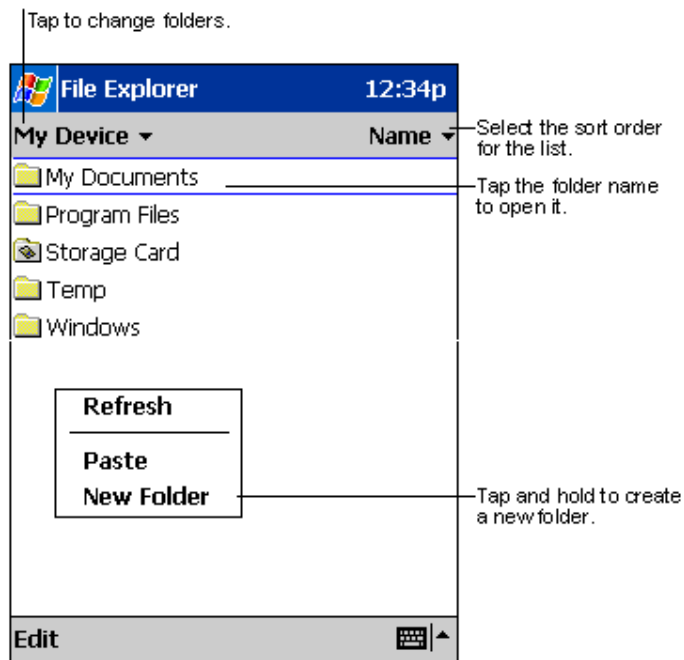
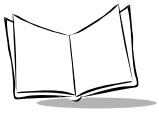

Figure 2-17. File Explorer

Note: To move files in File Explorer, tap and hold the item, then tap *Cut* or *Copy* and *Paste* on the pop-up menu.



Scanning

The PPT 2800 has an integrated scanner which allows you to collect data by scanning one or two-dimensional bar codes. See [Appendix B, Demo Program](#) for a sample scanning application.

To scan bar codes with the PPT 2800, first start your scanning application. Then:

1. Aim the scan window at the bar code.
2. Press either the right, left, or center scan trigger. Make sure the red scan beam covers the entire bar code. The green scan LED lights and a beep sounds to indicate a successful decode.

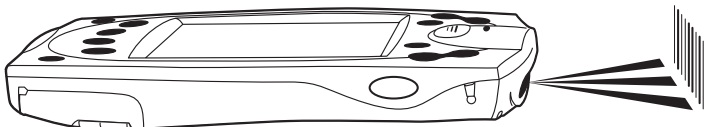

Figure 2-18. Scanning

Scanning PDF417 Bar Codes

The 2D scanning PPT 2800 terminal supports PDF417 bar code scanning. The raster pattern has multiple scanning rows to accommodate the PDF417 symbol's multiple rows.

1. Point the scanner at the bar code and press the trigger.
2. Center the aiming pattern on the bar code.
3. As the raster pattern spreads, keep the pattern horizontal to the bar code.

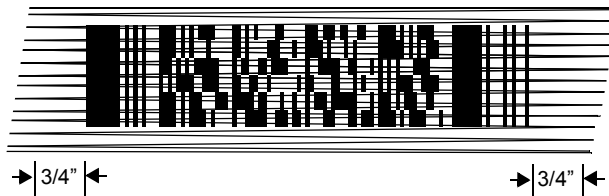

Figure 2-19. Raster Pattern

4. The terminal indicates a successful scan by changing the LED from red to green, beeping one or more times, and/or displaying the bar code data on the screen.

“Tall” PDF Bar Codes

If the PDF417 symbol is “tall,” the vertical scan pattern may not be high enough to cover it. Move the scan pattern slowly down toward the bottom of the symbol, keeping the beam horizontal to the rows, then slowly back up toward the top.

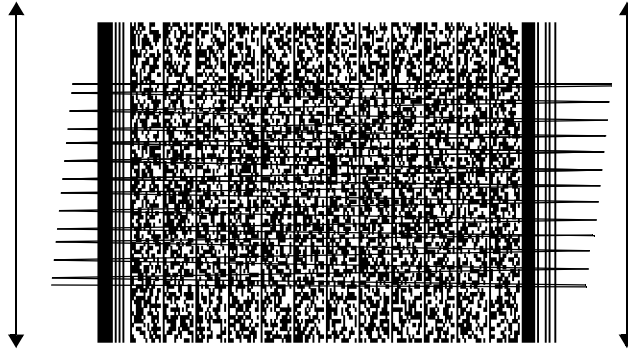

Figure 2-20. Scanning Tall PDF Bar Code

The scan beam does not have to be *perfectly* parallel with the top and bottom of the symbol (up to a 4° tilt will work).

Resetting Your PPT 2800 Terminal

If your PPT 2800 terminal stops responding to input from buttons or the screen, reset it by performing a warm or cold boot.

Performing a Warm Boot

A warm boot restarts the terminal and saves all stored records and entries.

Caution

Files that remain open during a warm boot may not be retained.

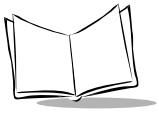

To perform a warm boot, hold down both the up and down scroll buttons, then press the App 4 button.

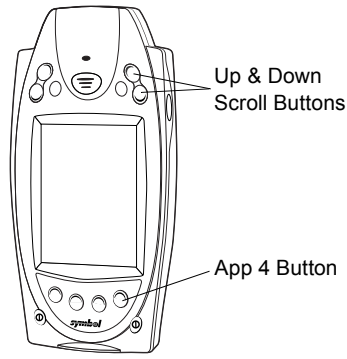

Figure 2-21. Warm Boot Buttons

Performing a Cold Boot

A cold boot also restarts your PPT 2800 terminal, but erases all stored records and entries not saved in the Flash File system. *Therefore, never perform a cold boot unless a warm boot does not solve your problem.*

Caution

With a cold boot, the current date and time, formats, preferences, and other settings are restored to their factory default settings, unless they are restored using .reg files located in the Flash File system.

Note: *You can restore any data previously synchronized with your computer during the next ActiveSync operation.*

To perform a cold boot:

1. Remove the battery cover.
2. While holding down the Function button, use the tip of the stylus (or similar object *without* a sharp tip) to gently press the reset button.

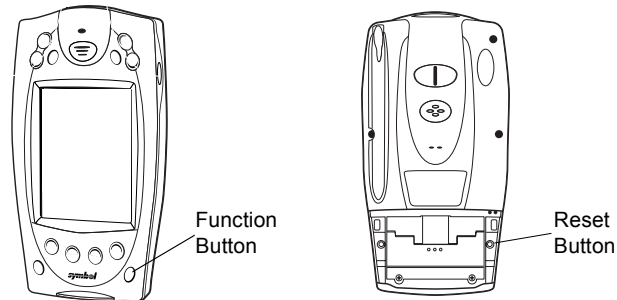
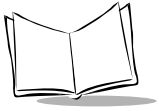

Figure 2-22. Cold Boot Buttons

3. Replace the battery cover and press the Power button.
4. As the terminal initializes its unique Flash File system, the Symbol splash screen displays for about a minute.
5. See [Aligning the Screen](#) on page 1-15 to perform an initial setup of the terminal.



PPT 2800 Series Product Reference Guide for Pocket PC 2002



Chapter 3

Customizing Your PPT 2800

Chapter Contents

Introduction	3-3
Adjusting Settings	3-3
Flash Storage	3-3
FFS Partitions	3-3
Working with FFS Partitions	3-4
Non-FFS Partitions	3-6
Downloading Partitions to the Terminal	3-6
Assigning Applications to Application Buttons	3-6
Assigning User-Written Applications to Buttons	3-7
Adding Programs	3-8
Adding a Program from the Internet	3-8
Adding a Program to the Start Menu	3-9
Removing Programs	3-10

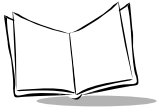

PPT 2800 Series Product Reference Guide for Pocket PC 2002

Introduction

This chapter provides basic instructions for customizing your terminal by adjusting settings and installing additional software.

Adjusting Settings

To view available options for your terminal settings, tap *Start*, *Settings*, then the *Personal* or *System* tab at the bottom of the screen.

You may want to adjust the following:

- Clock: change the time or set alarms
- Buttons: assign programs to the application hardware buttons
- Menus: customize what appears on the *Start* menu and enable a pop-up menu from the *New* button
- Owner Information: enter your contact information
- Password: limit access to your terminal
- Power: maximize battery life
- Today: customize the information displayed on the Today screen.

Flash Storage

Programs pre-installed on your terminal are stored in ROM (read-only memory). You cannot remove, modify, or accidentally lose this software. You may add programs and data files to RAM (random access memory).

In addition to the RAM-based storage standard on Pocket PC terminals, the PPT 2800 is also equipped with a non-volatile Flash-based storage area which can store data (partitions) that can not be corrupted by a cold boot. This Flash area is divided into two categories: Flash File System (FFS) Partitions and Non-FFS Partitions.

FFS Partitions

The PPT 2800 terminal includes three FFS partitions. These partitions appear to the terminal as a hard drive that the OS file system can write files to and read files from. Data is retained even if power is removed.

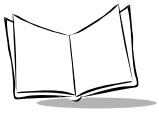

The three FFS Partitions appear as three separate folders in the Windows CE file system and are as follows:

- **Platform:** The Platform FFS Partition contains Symbol-supplied programs and Dynamic Link Libraries (DLLs). This FFS is configured to include DLLs that control system operation. Since these drivers are required for basic terminal operation, only experienced users should modify the content of this partition.
- **Application:** The Application FFS Partition is used to store application programs needed to operate the terminal. This partition includes the Symbol demo program, which can be overwritten with your own program.
- **Data:** The Data FFS Partition is optional and if present contains user data files generated by your custom programs. The default PPT 2800 image does not contain a Data FFS partition.

Working with FFS Partitions

Because the FFS partitions appear as folders under the Windows CE file system, they can be written to and read like any other folder. For example, an application program can write data to a file located in the Application folder just as it would to the Windows folder. However, the file in the Application folder is in non-volatile storage and is not lost on a cold boot (e.g., when power is removed for a long period of time).

Standard tools such as ActiveSync can be used to copy files to and from the FFS partitions. They appear as the “Application,” “Platform,” and “Data” folders to the ActiveSync explorer. This is useful when installing applications on the PPT 2800. Applications stored in the Application folder are retained even when the terminal is cold booted, just as the PPT 2800 Demo program is retained in memory.

Windows CE expects certain files to be in the Windows folder, residing in volatile storage. Windows CE maintains the System Registry in volatile storage. There are two device drivers included in the Windows CE image to assist developers in configuring the terminal following a cold boot: **Regmerge.dll** and **CopyFile.dll**.

RegMerge.dll

Regmerge.dll is a built-in driver that allows registry edits to be made to the Windows CE Registry. Regmerge.dll runs very early in the boot process and looks for registry files (.reg files) in certain Flash File System folders during a cold boot. It then merges the registry changes that are in these files into the system registry located in RAM.

Since the registry is re-created on every cold boot from the default ROM image, the Regmerge.dll driver is necessary to make registry modifications persistent over cold boots.

Regmerge.dll is configured to look in two specific folders for .reg files in the following order:

\Platform

\Application

Regmerge.dll continues to look for .reg files in these folders until all folders are checked. This allows folders later in the list to override folders earlier in the list. This way, it is possible to override Registry changes made by the Platforms partitions folders. Take care when using Regmerge.dll to make Registry changes. The SDK contains examples of .reg files.

Note: *Regmerge.dll only merges the .reg files on cold boots. The merge process is skipped during a warm boot.*

Typically, you should not need to make modifications to registry values for drivers loaded before Regmerge.dll. However, sometimes during software development, you may need to modify these values. Since these early loading drivers read these keys before Regmerge.dll gets a chance to change them, you must warm boot the terminal after a cold boot. The warm boot does not re-initialize the registry, and the early loading driver reads the new registry values.

Do not use Regmerge.dll to modify built-in driver registry values, or merge the same Registry value to two files in the same folder, as the results are undefined.

CopyFile.dll

CopyFile.dll copies files from one folder to another on a cold boot. Files can be copied from a non-volatile partition (Application or Platform) to the Windows or other volatile partition during a cold re-boot. During a cold boot **CopyFile.dll** looks for files with a .CPY extension on the FFS partition. These files are text files containing the source and destination for the desired files to be copied separated by ">". The following example from the file **application.cpy** is contained on the default application partition shipped with the PPT 2800.

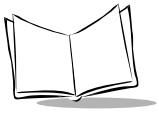

Non-FFS Partitions

Non-FFS Partitions include additional software and data pre-loaded on your terminal that can be upgraded. Unlike FFS Partitions, these partitions are not visible when the operating system is running. They also contain system information. Non-FFS Partitions include the following:

- **Windows CE:** the complete Windows CE operating system is stored on Flash devices. If necessary, the entire OS image may be downloaded to the terminal using files provided by Symbol. The current OS partition on the terminal is included as part of the TCM installation package. Any upgrades must be obtained from Symbol. This partition is mandatory for the PPT 2800.
- **Splash Screen:** a bitmap smaller than 16 Kb, displayed as the terminal cold-boots. You may download a customized screen to display (see [Chapter 12, Configuring the Terminal](#)).
- **IPL (Initial Program Loader):** This program interfaces with the host computer and allows you to download via serial cable or cradle any or all of the partitions listed above, as well as updated versions of IPL. Use caution downloading updated IPL versions; incorrect downloading of an IPL causes permanent damage to your terminal. IPL is mandatory for the PPT 2800.
- **Partition Table:** Identifies where each partition is loaded in the terminal.

Downloading Partitions to the Terminal

TCM is used to specify a hex destination file for each partition and download each file to the terminal. This download requires a program loader stored on the terminal. The terminal comes with a program loading utility, Initial Program Loader (IPL), stored in the terminal's write-protected flash. See [Chapter 12, Configuring the Terminal](#) for details on using IPL and TCM to download partitions to the PPT 2800.

Assigning Applications to Application Buttons

The physical application buttons on the front of your terminal access, by default, Calendar, Contacts, Tasks and Notes. To re-assign a different application to a button:

1. Tap *Start*, then *Settings*.

2. On the *Personal* tab, tap *Buttons*.

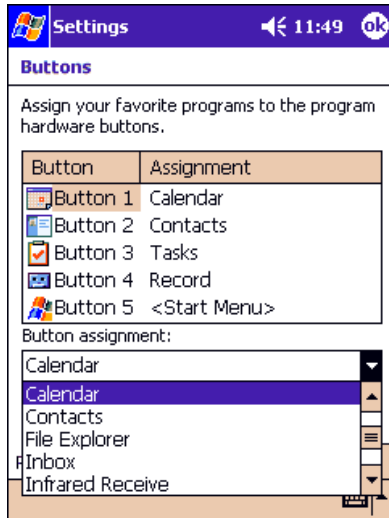

Figure 3-1. Buttons Screen

3. Tap the button on the list that you want to change, then use the *Button assignment* drop-down menu to select a new application for that button.
4. Tap OK.

Assigning User-Written Applications to Buttons

Use **Regmerge.dll** to modify the registry during a cold boot to assign user-written applications to the application buttons. These buttons remain assigned after a cold boot. See the Help file on the SDK for more information.

Note: *Although located in the Flash File System, we recommend copying user applications to the Windows directory (using CopyFile.dll) and running them from there. See the Help file for more information.*

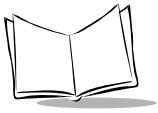

Adding Programs

Install the appropriate software on your desktop computer before installing it on your terminal.

1. Tap *Start*, then *Settings*. On the *System* tab, tap *About*. In the *Version* tab, note the information in *Processor*.
2. Download the program to your desktop computer (or insert the CD or disk that contains the program into your desktop computer). You may see a single *.xip file, *.exe file, a *.zip file, or a Setup.exe file.
3. Read any installation instructions, Read Me files, or documentation that comes with the program. Many programs provide special installation instructions.
4. Connect your terminal and desktop computer.
5. Double-click the *.exe file.

If the file is an installer, the installation wizard begins. Follow the directions on the screen. Once the software is installed on your desktop computer, the installer transfers the software to your terminal.

If the file is not an installer, an error message states that the program is valid but is designed for a different type of computer. Move this file to your terminal. If you cannot find installation instructions for the program in the Read Me file or documentation, use ActiveSync Explore to copy the program file to the Program Files folder on your terminal. For more information on copying files using ActiveSync, see ActiveSync Help.

When installation is complete, tap *Start*, *Programs*, then the program icon to select it.

Adding a Program from the Internet

1. Tap *Start*, then *Settings*. On the *System* tab, tap *About*. In the *Version* tab, note the information in *Processor*.
2. Download the program to your terminal from the Internet using Pocket Internet Explorer. You may see a single *.xip, *.exe, *.zip file, or a Setup.exe file.
3. Read any installation instructions, Read Me files, or documentation that comes with the program. Many programs provide special installation instructions.
4. Tap the file, such as a *.xip or *.exe file, to launch the installation wizard. Follow the directions on the screen.

Adding a Program to the Start Menu

Tap *Start*, *Settings*, *Menus*, the *Start Menu* tab, then the check box for the program.

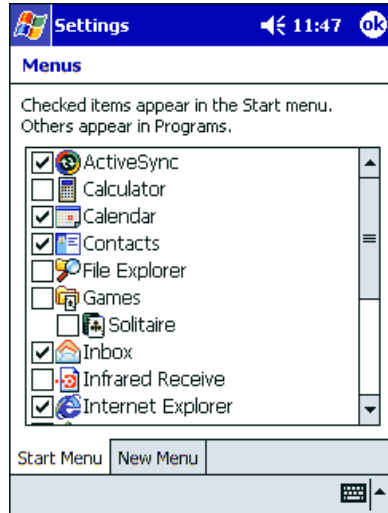

Figure 3-2. Menu Screen

If you do not see the program listed, either use File Explorer to move the program to the Start Menu folder or use ActiveSync on the desktop computer to create a shortcut to the program and place the shortcut in the Start Menu folder.

Using File Explorer to Add to the Start Menu

1. Tap *Start*, *Programs*, *File Explorer*, and locate the program (tap the folder list, labeled *My Documents* by default, then *My Device* to list all folders on the terminal).
2. Tap and hold the program and tap *Cut* on the pop-up menu.
3. Open the *Start Menu* folder in the *Windows* folder, tap and hold a blank area of the window, and tap *Paste* on the pop-up menu. The program appears on the *Start* menu.

For more information on using File Explorer, see [Finding Information](#) on page 2-21.

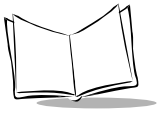

Note: Avoid placing direct links in the Start Menu to programs located in flash memory (Application or Platform). Copy these programs to the Windows folder first.

Using ActiveSync to Add to the Start Menu

1. Use the Explorer in ActiveSync on your desktop computer to explore your terminal's files and locate the program.
2. Right-click the program, then click *Create Shortcut*.
3. Move the shortcut to the Start Menu folder in the Windows folder. The shortcut appears on the *Start* menu.

For more information, see ActiveSync Help.

Removing Programs

To remove a program, tap *Start*, then *Settings*. On the *System* tab, tap *Remove Programs*.



Figure 3-3. Remove Programs Screen

If the program does not appear in the list of installed programs, use File Explorer on your terminal to locate the program, tap and hold the program, then tap *Delete* on the pop-up menu.

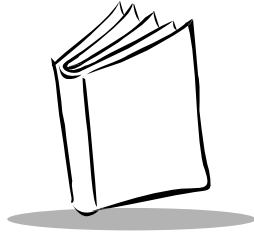

Chapter 4

Communications

Chapter Contents

Introduction	4-3
Installing ActiveSync Software	4-3
Performing an ActiveSync for the First Time	4-3
Performing ActiveSync using the Synchronization Cable	4-5
Performing ActiveSync using the Cradle	4-6
Performing Subsequent ActiveSync Operations	4-8
Performing a Remote ActiveSync	4-8

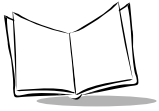

PPT 2800 Series Product Reference Guide for Pocket PC 2002

Introduction

The CRD 2700 Cradle serves as an essential data communications device, enabling you to synchronize the information on your PPT 2800 terminal with the information on your desktop computer using ActiveSync® software. With customized or third party software, it can also be used to synchronize your PPT 2800 terminal with corporate databases and other host computers. Setting up the CRD 2700 cradle involves installing the ActiveSync software to enable synchronization, and connecting your cradle to your computer.

Installing ActiveSync Software

Using ActiveSync, you can synchronize the information on your PPT 2800 terminal with the information on your desktop computer. Changes you make on your terminal or desktop computer appear in both places after you synchronize.

With ActiveSync software you can:

- Work with terminal-compatible desktop applications on your desktop computer. ActiveSync replicates data from your PPT 2800 terminal (such as Calendar and Contacts) so you can view, enter and modify any data stored on your PPT 2800 terminal with the desktop application.
- Synchronize Microsoft Word and Microsoft Excel files between your terminal and desktop computer. Your files are automatically converted to the correct format.
- Back up the data stored on your PPT 2800 terminal. Synchronization is a one-step procedure that ensures your data is always safe and up-to-date.
- Copy (rather than synchronize) files between your terminal and desktop computer.
- Control when synchronization occurs by selecting a synchronization mode, e.g., you may synchronize continually while the terminal is in the cradle, or only when you select the synchronize command.
- Select the types of information to synchronize, and control how much data is synchronized.

Performing an ActiveSync for the First Time

Before synchronization, install ActiveSync 3.5 on your desktop computer. You may download ActiveSync from the Microsoft Website. ActiveSync components are already installed on your terminal.

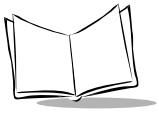

After installation is complete, the ActiveSync Setup Wizard helps you connect your PPT 2800 to your desktop computer, set up a partnership so you can synchronize information between your terminal and desktop computer, and customize synchronization settings. Your first synchronization occurs automatically when you finish using the wizard (see [Performing ActiveSync using the Synchronization Cable](#) on page 4-5 and [Performing ActiveSync using the Cradle](#) on page 4-6).

During the first synchronization, information stored in Microsoft Outlook (Calendar, Contacts, and Tasks) on your desktop computer is copied to your terminal. You can now disconnect your terminal from your computer.

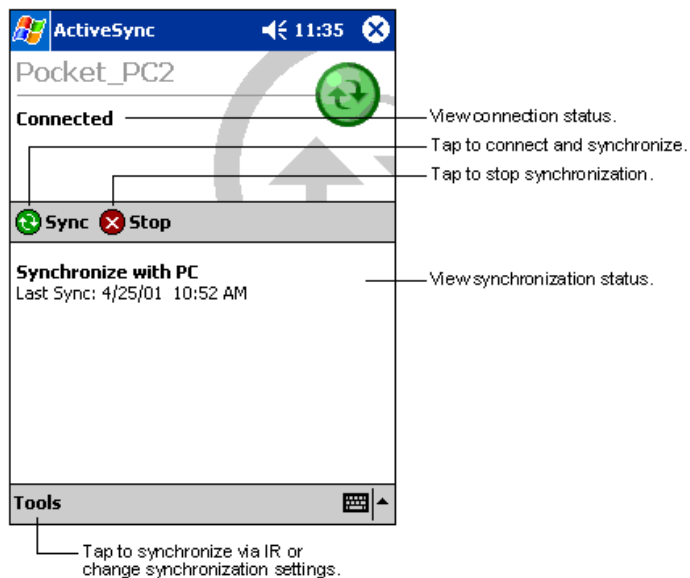

Figure 4-1. ActiveSync

See [Performing Subsequent ActiveSync Operations](#) on page 4-8 to synchronize again.

Note: You must perform your first ActiveSync operation with a local, direct connection.

To retain partnerships after a cold boot, capture partnership registry information in a .reg file and save it in the Flash File System. See the Help file for details.

For more information about using ActiveSync, start ActiveSync on your desktop computer, then see ActiveSync Help.

Performing ActiveSync using the Synchronization Cable

To perform an ActiveSync operation for the first time using the synchronization cable:

1. After installing the ActiveSync software, restart your desktop computer.
2. Insert the cable into the bottom of the terminal.

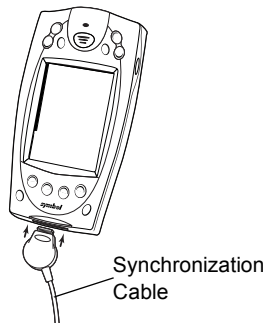

Figure 4-2. Inserting the Cable in the Terminal

3. Connect the other end of the cable to the serial communications port on your desktop computer.

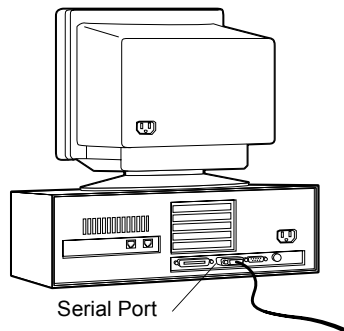
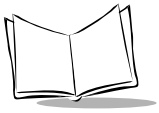

Figure 4-3. Connecting the Synchronization Cable to the Computer

Note: *The synchronization cable requires a dedicated port. It cannot share a port with an internal modem or other device. If you are unsure*



about the location of the serial port on your computer, refer to the user's manual supplied with the computer.

4. On the desktop computer, enter a name for your PPT 2800 terminal and click the **Next** button. Follow the instructions on the screen to set up a partnership that allows synchronization of information between the two devices. Items to be synchronized may be customized, and you may select to synchronize continuously as information changes, upon connection, or manually by clicking the **Sync** button on the toolbar of your desktop computer.
-

Note: *Every PPT 2800 terminal should have a unique name. Never try to synchronize more than one PPT 2800 terminal to the same user name.*

Performing ActiveSync using the Cradle

To perform an ActiveSync operation for the first time using the cradle:

1. After installing the ActiveSync software, restart your desktop computer.
2. Connect your CRD 2700 cradle to your computer by plugging the cable from the cradle into the serial communications port on your desktop computer.

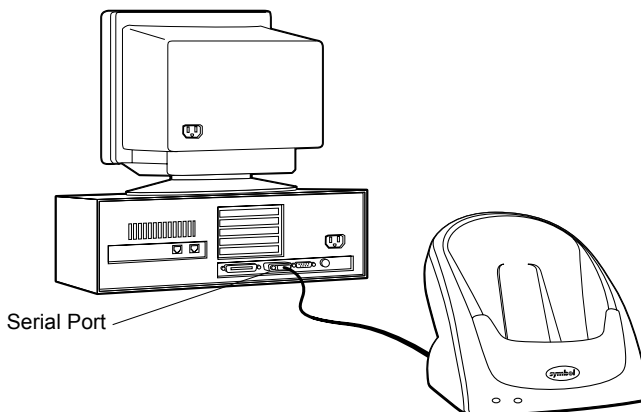

Figure 4-4. Connecting the Cradle to the Computer

Note: The CRD 2700 cable requires a dedicated port. It cannot share a port with an internal modem or other device. If you are unsure about the location of the serial port on your computer, refer to the user's manual supplied with the computer.

3. Turn on the PPT 2800 terminal and slide it into the cradle.

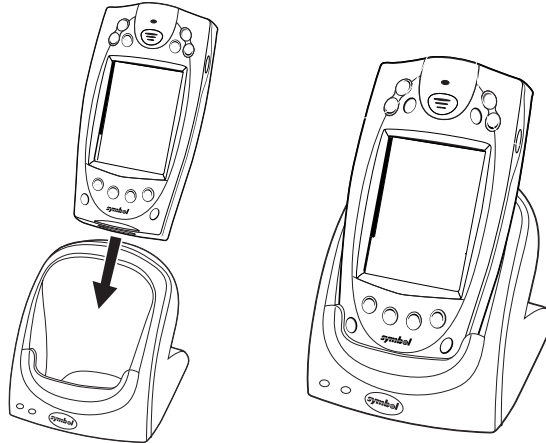
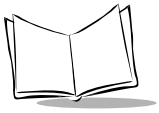

Figure 4-5. Inserting the Terminal in the Cradle

The curved edge on the bottom of the PPT 2800 terminal should align smoothly with the cradle when it is inserted properly.

4. On the desktop computer, enter a name for your PPT 2800 terminal and click the **Next** button. Follow the instructions on the screen to set up a partnership that allows synchronization of information between the two computers. Items to be synchronized may be customized, and you may select to synchronize continuously as information changes, upon connection, or manually by clicking the **Sync** button on the toolbar of your desktop computer.

Note: Every PPT 2800 terminal should have a unique name. Never try to synchronize more than one PPT 2800 terminal to the same user name.



Performing Subsequent ActiveSync Operations

After you complete the first ActiveSync operation, you just need to place the terminal in the connected cradle or connect the synchronization cable and synchronization occurs automatically.

Performing a Remote ActiveSync

You can also sync your PPT 2800 remotely using a modem. See [Creating a Modem Connection to a Network](#) on page 8-7 to set up your terminal for a modem ActiveSync.

Before leaving your desktop computer, prepare the computer for a remote ActiveSync:

1. Start ActiveSync on your desktop computer.
2. On the *File* menu, select *Connection Settings*.
3. Select *Allow network (Ethernet) and Remote Access Service (RAS) server connection with this desktop computer*.
4. Leave your computer on and logged on.

To remotely sync your PPT 2800 terminal with your desktop computer:

1. Insert the terminal in the modem cradle, or attach the snap-on modem. If using the cradle, set the Sync Select switch on the back of the cradle to the Modem position.
2. On the PPT 2800, select *Start, ActiveSync*.
3. Tap the Sync icon.

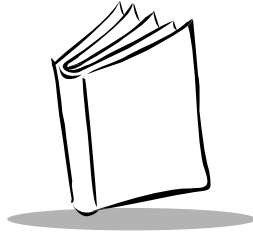

Chapter 5

Applications

Chapter Contents

Introduction	5-3
Calendar	5-3
Creating Appointments	5-4
Using the Summary Screen	5-5
Creating Meeting Requests	5-5
Contacts	5-6
Using the Summary Screen	5-8
Tasks	5-9
Using the Summary Screen	5-11
Notes	5-12
Inbox	5-14
Synchronizing E-mail Messages	5-14
Connecting Directly to an E-mail Server	5-14
Using the Message List	5-16
Creating E-mail Messages	5-18
Managing E-mail Messages and Folders	5-19

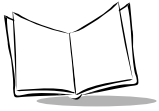

PPT 2800 Series Product Reference Guide for Pocket PC 2002

Introduction

Your PPT 2800 terminal includes Calendar, Contacts, Tasks, Inbox, and Notes applications. You can use these programs individually or together. For example, e-mail addresses stored in Contacts can be used to address e-mail messages in Inbox.

Using ActiveSync, you can synchronize information in these applications between your desktop computer and your terminal. Each time you synchronize, ActiveSync compares the changes you made on your terminal and desktop computer and updates both with the latest information. For information on using ActiveSync, see [Chapter 4, Communications](#), and ActiveSync Help on the desktop computer.

You can switch to any of these programs by tapping them on the *Start* menu.

Calendar

Use Calendar to schedule appointments such as meetings. You can view your appointments in different ways (Agenda, Day, Week, Month, and Year) and easily change views using the *View* menu.

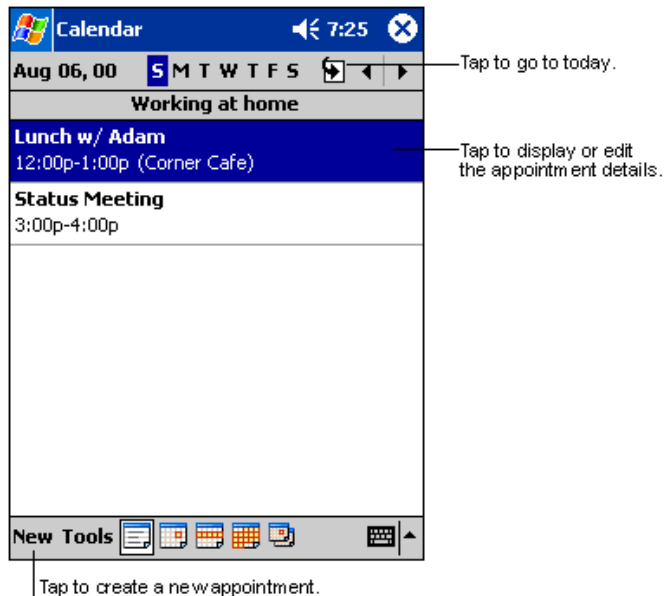
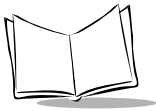



Figure 5-1. Calendar Application



Note: You can customize the Calendar display, such as changing the first day of the week, by tapping Options on the Tools menu.

Creating Appointments

To create an appointment:

1. To select Calendar, press the App1 button or select *Calendar* from the  menu.
2. If you are in Day or Week view, tap the desired date and time for the appointment.
3. Tap *New*.

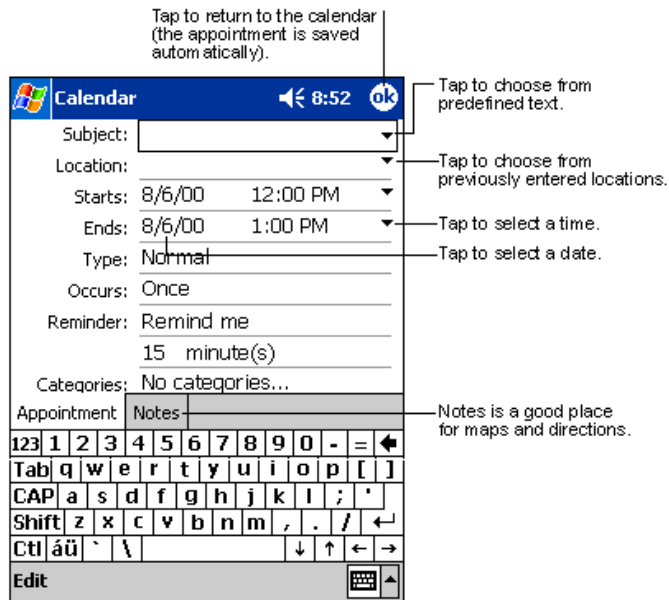



Figure 5-2. Entering an Appointment

4. Using the input panel, enter the subject and a location. Tap first to select the field.
5. If needed, tap the date and time to change them.
6. Enter other desired information. Hide the input panel to see all available fields.
7. To add notes, tap the *Notes* tab. You can enter text, draw, or create a recording. For more information on creating notes, see [Notes](#) on page 5-12.
8. When finished, tap OK to return to the calendar.

Note: If you select *Remind me in an appointment*, your terminal notifies you according to the options set in , Settings, Personal tab, Sounds & Reminders.

Using the Summary Screen

When you tap an appointment in Calendar, a summary screen displays. Tap *Edit* to change the appointment.

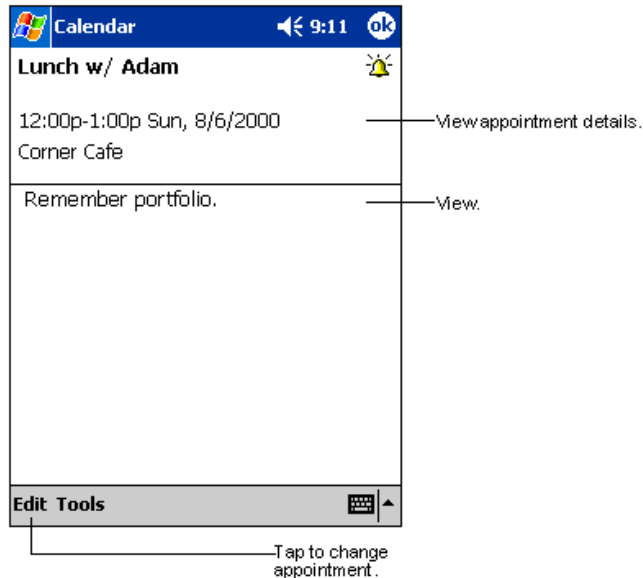

Figure 5-3. Appointment Summary Screen

Creating Meeting Requests

You can use Calendar to set up meetings with users of Outlook or Pocket Outlook. The meeting notice is created automatically and sent either when you synchronize Inbox or when you connect to your e-mail server. Indicate how you want meeting requests sent by tapping *Tools*, then *Options*. If you send and receive e-mail messages through ActiveSync, select *ActiveSync*.

To schedule a meeting:

1. Create an appointment.

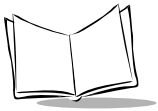

2. In the appointment details, hide the input panel, then tap *Attendees*.
3. From the list of e-mail addresses you've entered in Contacts, select the meeting attendees.

The meeting notice is created and placed in the Outbox folder. For more information on sending and receiving meeting requests, see Calendar Help and Inbox Help on your terminal.

Contacts

Contacts maintains a list of associates and friends so you can easily locate information at home or on the road. Using the infrared (IR) port, you can share Contacts information with other terminal users.

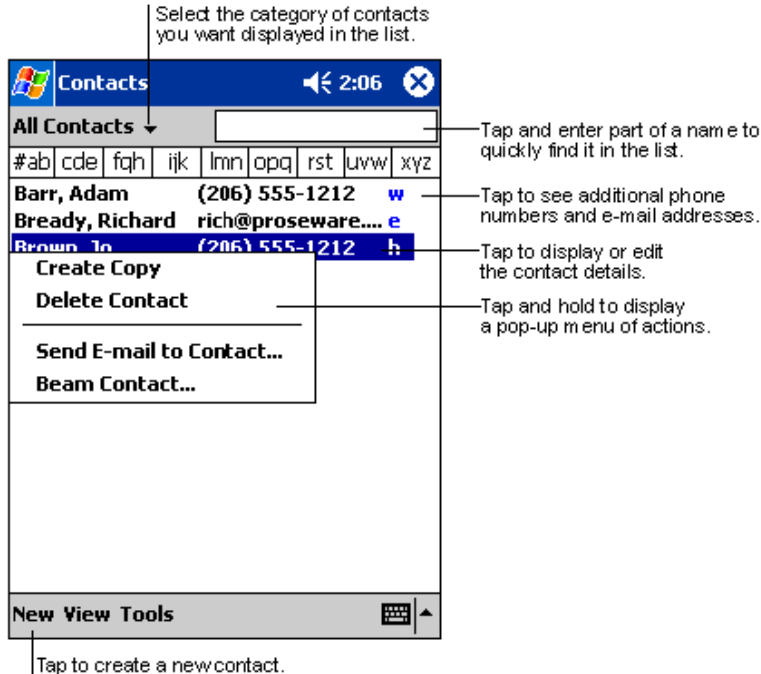

Figure 5-4. Contact Application

Note: To change the way information is listed, tap Tools, then Options.

To create a contact:

1. Tap **New**.

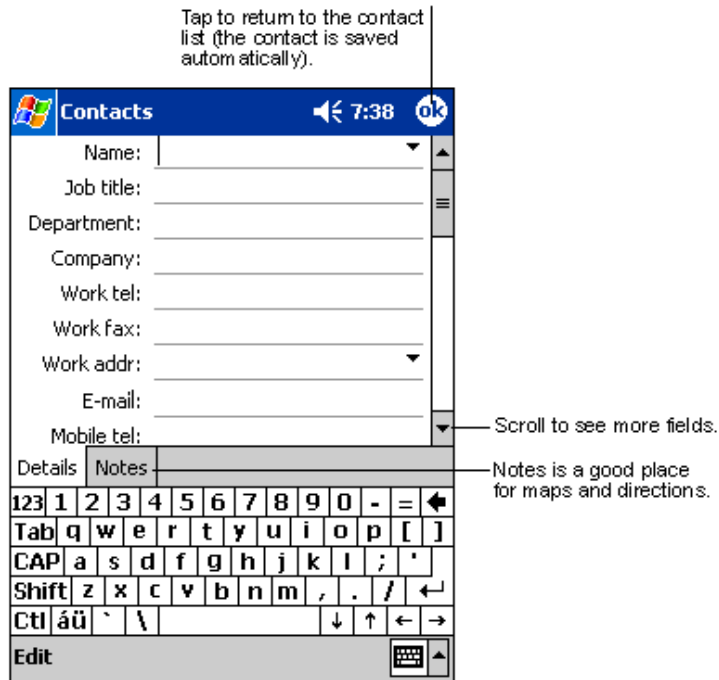
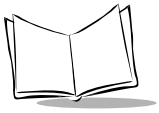

Figure 5-5. Creating a Contact

2. Using the input panel, enter a name and other contact information. Scroll down to see all fields.
3. To assign the contact to a category, scroll to and tap *Categories*. Select a category from the list. In the contact list, you can display contacts by category.
4. To add notes, tap the *Notes* tab. You can enter text, draw, or create a recording. For more information on creating notes, see [Notes](#) on page 5-12.
5. When finished, tap **OK** to return to the contact list.



You may find a contact in one of four ways:

- In the contact list, enter a contact name in the box under the navigation bar. To show all contacts again, clear text from the box or tap the button to the right of the box.
- In the contact list, tap the category list (labeled All Contacts by default) and select the type of contact to display. To show all contacts again, select *All Contacts*. To view a contact not assigned to a category, select *None*.
- To view the names of companies your contacts work for, in the contact list, tap *View > By Company*. The number of contacts that work for that company appears to the right of the company name.
- Tap *Start, Find*, enter the contact name, select *Contacts* for the type, then tap *Go*.

Using the Summary Screen

When you tap a contact in the contact list, a summary screen displays.

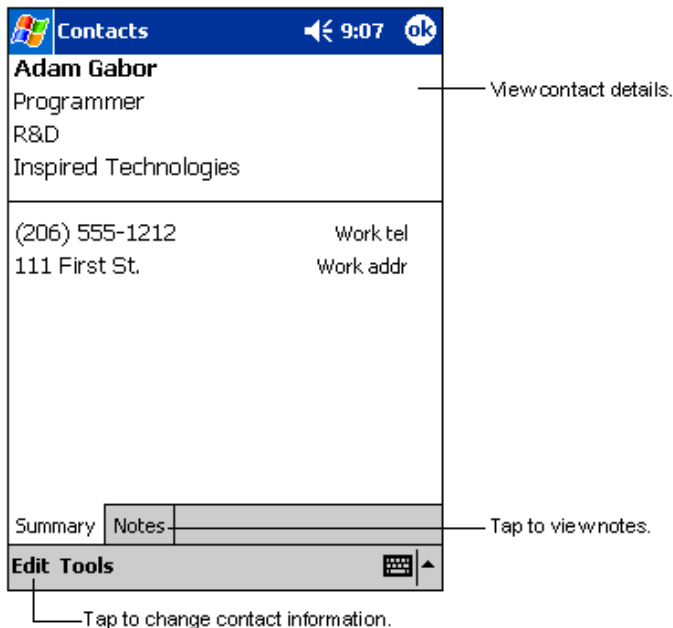

Figure 5-6. Contacts Summary Screen

Tasks

Use Tasks to keep a “to do” list.

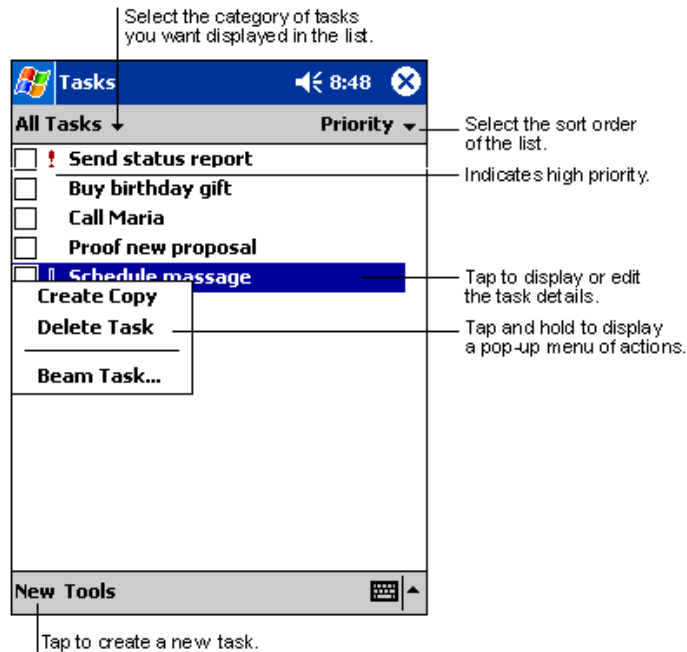
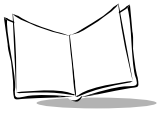

Figure 5-7. Task Application

Note: To change the way information displays in the list, tap Tools, then Options.



To create a task:

1. Tap *New*.

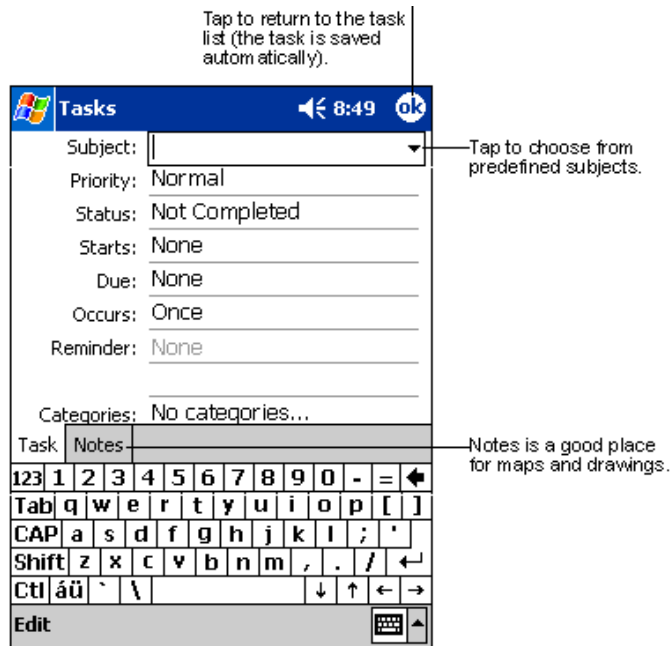

Figure 5-8. Creating a Task

2. Using the input panel, enter a description.
3. You can enter a start date and due date or enter other information by first tapping the field. If the input panel is open, hide it to see all available fields.
4. To assign the task to a category, tap *Categories* and select a category from the list. In the task list, you can display tasks by category.
5. To add notes, tap the *Notes* tab. You can enter text, draw, or create a recording. For more information on creating notes, see [Notes](#) on page 5-12.
6. Tap **OK** to return to the task list.

Note: To create a task with only a subject, tap *Entry Bar* on the *Tools* menu. Then tap *Tap* here to add a new task and enter your task information.

Using the Summary Screen

When you tap a task in the task list, a summary screen displays. To change the task, tap *Edit*.

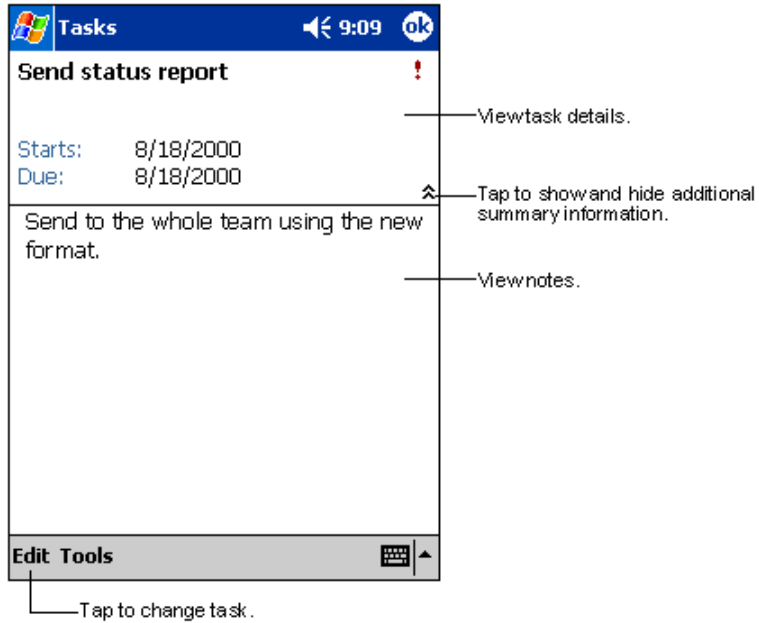
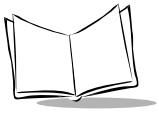

Figure 5-9. Task Summary Screen



Notes

Capture thoughts, reminders, ideas, drawings, and phone numbers with Notes. You can create a written note or a recording. You can also include a recording in a note. If a note is open when you create the recording, it is included in the note as an icon. If the note list is displayed, it is created as a stand-alone recording.

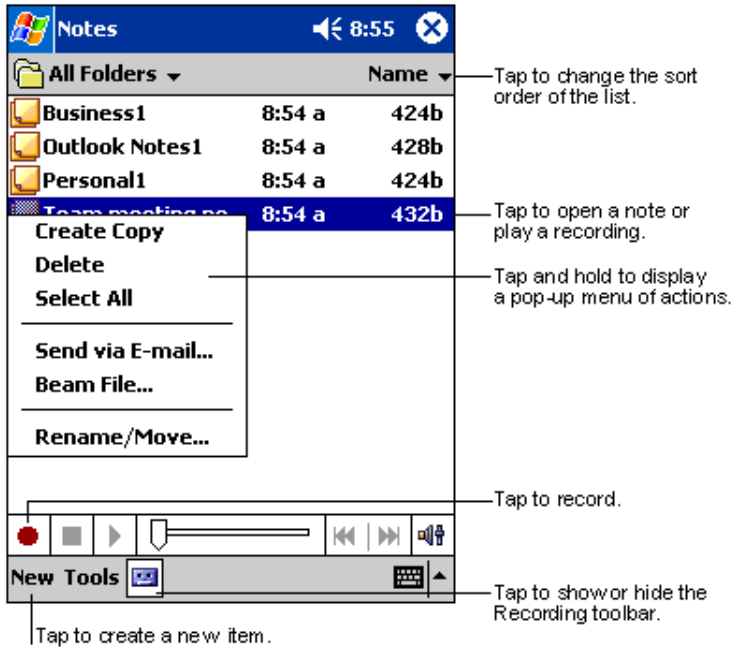
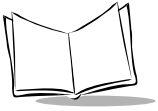

Figure 5-10. Notes Application



Inbox

Use Inbox to send and receive e-mail messages in the following ways:

- Synchronize e-mail messages with Microsoft Exchange or Outlook on your desktop computer.
- Send and receive e-mail messages by connecting directly to an e-mail server through an Internet service provider (ISP) or a network.

Synchronizing E-mail Messages

To synchronize e-mail messages, first enable Inbox synchronization in ActiveSync options. For information on enabling Inbox synchronization, see ActiveSync Help on the desktop computer.

During synchronization:

- E-mail messages are copied from the Inbox folder of Exchange or Outlook on your desktop computer to the ActiveSync folder on your terminal. By default, you receive messages from the last 3 days only, the first 100 lines of each message, and file attachments of less than 100 KB in size.
- E-mail messages in the Outbox folder on your terminal are transferred to Exchange or Outlook, then sent from those programs.
- E-mail messages in subfolders must be selected in ActiveSync on your desktop computer to be transferred.

Note: *You can also synchronize e-mail messages with your desktop computer from a remote location. For more information, see [Chapter 8, Connections](#).*

Connecting Directly to an E-mail Server

You can also send and receive e-mail messages by connecting to an e-mail server using a modem or network card connected to your terminal. You'll need to set up a remote connection to a network or an ISP, and a connection to your e-mail server. For more information, see [Chapter 8, Connections](#).

When you connect to the e-mail server, new messages are downloaded to the terminal Inbox folder, messages in the terminal Outbox folder are sent, and messages that were deleted on the e-mail server are removed from the terminal Inbox.

Messages that you receive directly from an e-mail server are linked to your e-mail server rather than your desktop computer. When you delete a message on your terminal, it's also deleted from the e-mail server the next time you connect.

You can work online or offline. When working online, you read and respond to messages while connected to the e-mail server. Messages are sent as soon as you tap *Send*, which saves space on your terminal.

When working offline, once you've downloaded new message headers or partial messages, you can disconnect from the e-mail server, then decide which messages to download completely. The next time you connect, Inbox downloads the complete messages you've marked for retrieval and sends the messages you've created.

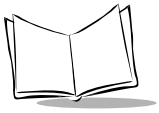

Using the Message List

Messages you receive display in the message list. By default, the most recently received messages are listed first.

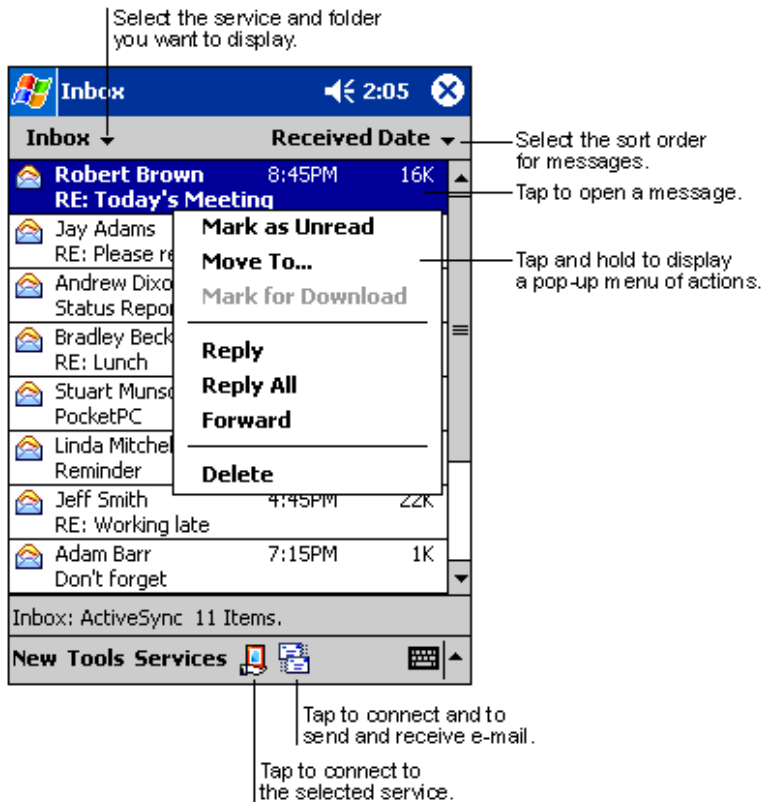

Figure 5-12. Inbox Application

When you receive a message, tap it in the list to open it. Unread messages display in bold.

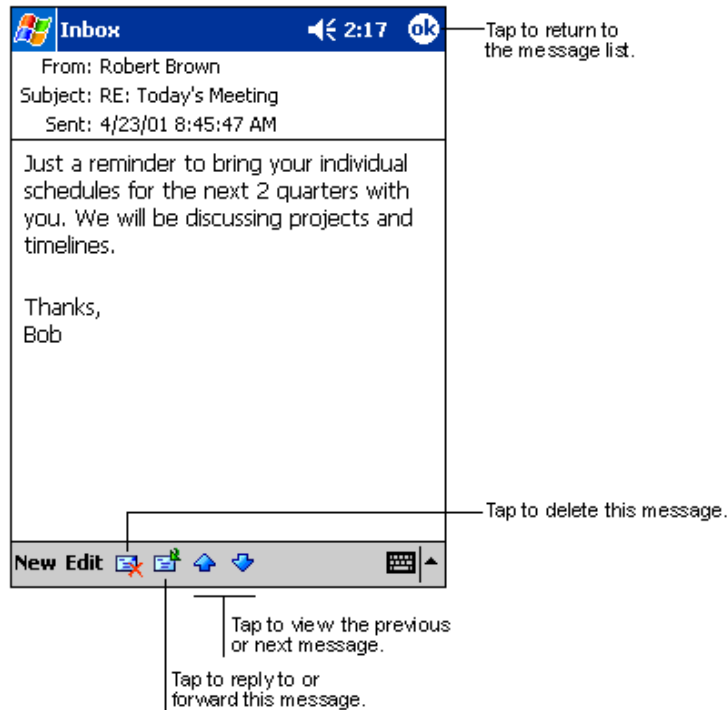
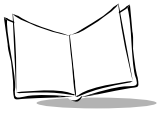

Figure 5-13. Viewing a Message

When you connect to your e-mail server or synchronize with your desktop computer, Inbox downloads by default only messages from the last 5 days, the first 100 lines of each new message, and file attachments of less than 100 KB in size. The original messages remain on the e-mail server or your desktop computer.

You can mark the messages that you want to retrieve completely the next time you synchronize or connect to your e-mail server. In the message list, tap and hold the message you want to retrieve. On the pop-up menu, tap *Mark for Download*. The icons in the Inbox message list indicates message status.

You specify your downloading preferences when you set up the service or select your synchronization options. You can change them at any time:



- Change options for Inbox synchronization using ActiveSync options. For more information, see ActiveSync Help.
- Change options for direct e-mail server connections in Inbox on your terminal. Tap *Tools*, then *Options*. On the *Service* tab, tap the service you want to change. Tap and hold the service and select *Delete* to remove it.

Creating E-mail Messages

To create an e-mail message:

1. Tap *New*.
2. In the *To* field, enter an e-mail or SMS address of one or more recipients, separating each with a semicolon, or select a name from the contact list by tapping the *Address Book* button. All e-mail addresses entered in the e-mail fields in *Contacts* appear in the *Address Book*.

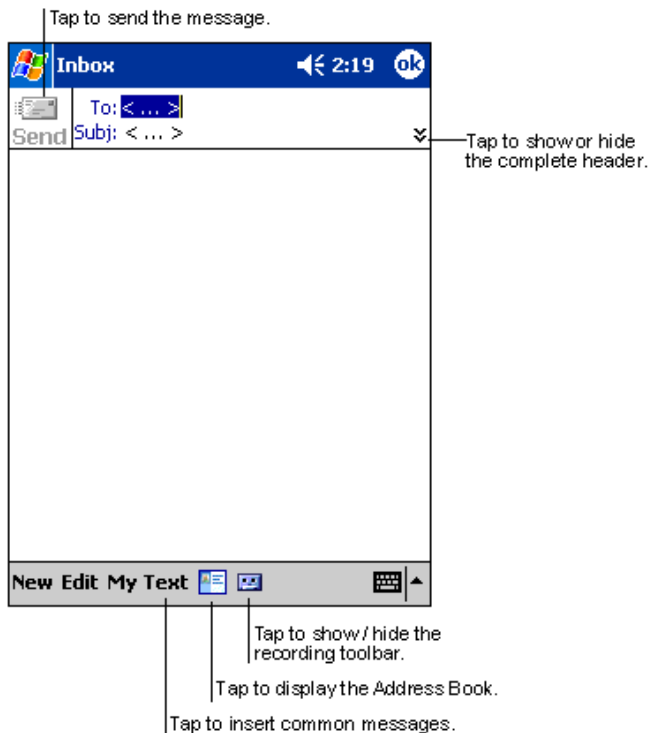

Figure 5-14. Creating a Message

3. Enter your message. To enter preset or frequently used messages, tap *My Text* and select a message.
4. Tap *Send* when you're finished. If you're working offline, the message is transferred to the Outbox folder and sent the next time you synchronize.

If you are sending an SMS message and want to know if it was received, tap *Edit, Options*, and select *Request SMS text message delivery notification* before sending the message.

Managing E-mail Messages and Folders

By default, messages are displayed in one of five folders for each service you've created: Inbox, Deleted Items, Drafts, Outbox, and Sent Items. The Deleted Items folder contains messages that have been deleted on the terminal. The behavior of the Deleted and Sent Items folders depends on the options you selected. In the message list, tap *Tools*, then *Options*. On the *Message* tab, select your options.

To organize messages into additional folders, tap *Tools*, then *Manage Folders* to create new folders. To move a message to another folder, in the message list, tap and hold the message, then tap *Move to* on the pop-up menu.

Folder Behavior with ActiveSync and Direct Connection to Server

The behavior of the folders you create depends on whether you are using ActiveSync, SMS, POP3, or IMAP4.

- If you use ActiveSync, e-mail messages in the Inbox folder in Outlook are automatically synchronized with your terminal. You can select to synchronize additional folders by designating them for ActiveSync. The folders you create and the messages you move are mirrored on the server. For example, if you move two messages from the Inbox folder to a folder named Family, and you have designated Family for synchronization, the server creates a copy of the Family folder and copies the messages into that folder. You can then read the messages while away from your desktop computer.
- If you use SMS, messages are stored in the Inbox folder.
- If you use POP3 and you move e-mail messages to a folder you created, the link is broken between the messages on your terminal and their copies on the mail server. The next time you connect, the mail server notes the messages missing from the terminal Inbox and deletes them from the server. This prevents you from having duplicate copies of a message, but it also means that you no longer have access to messages moved to folders created from anywhere except the terminal.
- If you use IMAP4, the folders you create and the e-mail messages you move are mirrored on the server. Therefore, messages are available to you anytime you

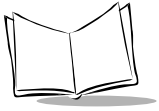

connect to your mail server, whether it is from your terminal or desktop computer. This synchronization of folders occurs whenever you connect to your mail server, create new folders, or rename/delete folders when connected.

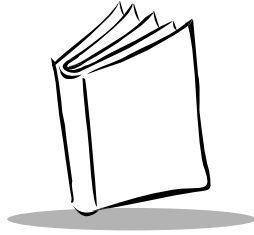

Chapter 6

Companion Programs

Chapter Contents

Introduction	6-3
Pocket Word	6-3
Typing Mode	6-5
Writing Mode	6-6
Drawing Mode	6-7
Recording Mode	6-7
Pocket Excel	6-8
Tips for Working in Pocket Excel	6-9
MSN® Messenger	6-10
Setting Up Your Account	6-10
Working with Contacts	6-11
Chatting with Contacts	6-12

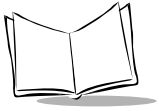

PPT 2800 Series Product Reference Guide for Pocket PC 2002

Introduction

The PPT 2800 contains the companion programs Microsoft Pocket Word, Microsoft Pocket Excel, Microsoft Money, and MSN[®] Messenger. To select a companion program, tap *Programs* on the  menu, then the program name.

Note: *Microsoft Reader is not included in this implementation of Pocket PC 2002.*

Pocket Word

Pocket Word works with Microsoft Word on your desktop computer to give you access to copies of your documents. You can create new documents on your PPT 2800, or copy documents from your desktop computer to your terminal. Synchronize documents between your desktop computer and your PPT 2800 so that you have the most up-to-date information in both locations.

To create a new document in Pocket Word, such as a letter, meeting minutes, or a trip report, tap *Start, Programs, Pocket Word*, then *New*. A blank document appears. Or, if you've selected a template for new documents in the *Options* dialog box, that template appears with appropriate formatting applied. You can open only one document at a time; when you open a second document, you'll be asked to save the first. You can save a document in a variety of formats, including Word (.doc), Pocket Word (.psw), Rich Text Format (.rtf), and Plain Text (.txt).

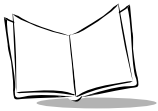

Pocket Word contains a list of the files stored on your device. Tap a file in the list to open it. To delete, make copies of, or send a file, tap and hold a file in the list. Then, select the appropriate action on the pop-up menu.

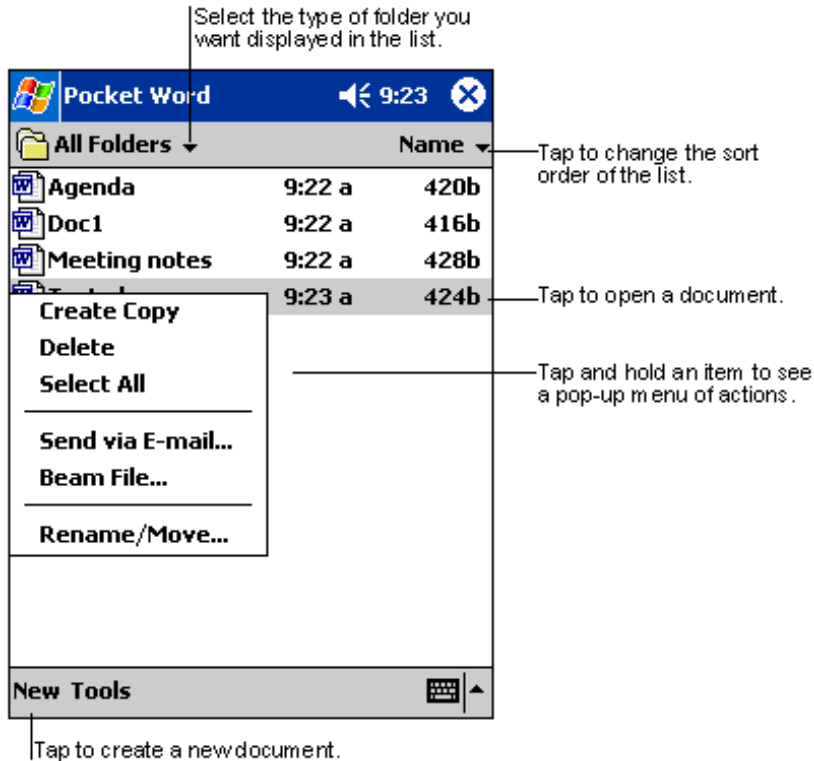

Figure 6-1. Using Pocket Word

You can enter information in Pocket Word in one of four modes (writing, drawing, typing, and recording) displayed on the *View* menu. Tap the *Show/Hide Toolbar* button on the command bar to show or hide each mode's toolbar.

To change the zoom magnification, tap *View*, then *Zoom*. Select the percentage. Select a higher percentage to enter text and a lower one to see more of your document.

If you're opening a Word document created on a desktop computer, select *Wrap to Window* on the *View* menu to see the entire document.

Typing Mode

Use the input panel to enter typed text into a document. See [Entering Information](#) on page 2-10 for more information.

To format or edit text, select the text using your stylus instead of the mouse to drag across the text. To search a document for the text you want, tap *Edit*, then *Find/Replace*.

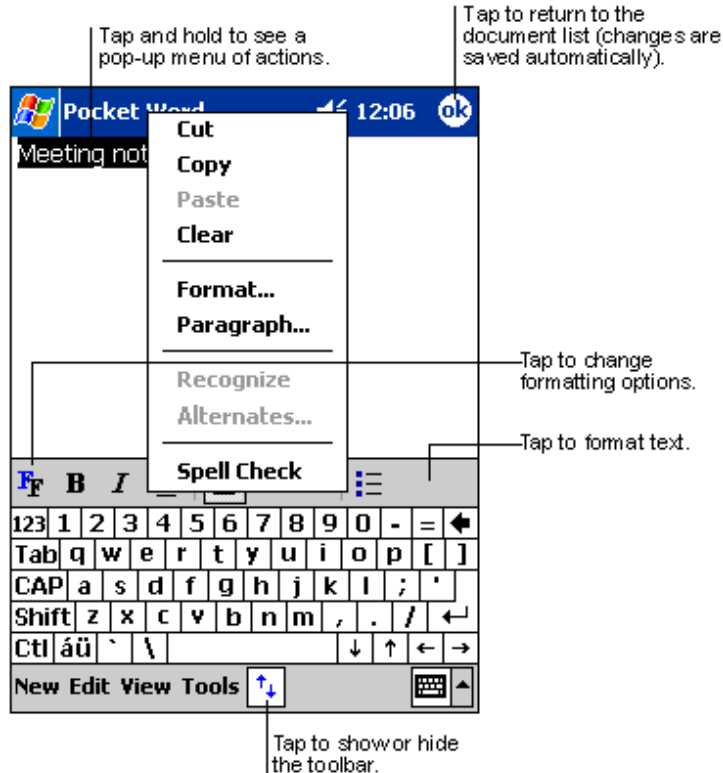
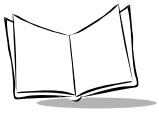

Figure 6-2. Formatting Text



Writing Mode

In writing mode, use your stylus to write directly on the screen. Ruled lines are displayed as a guide, and the zoom magnification increases to allow you to write more easily. For more information, see [Writing on the Screen](#) on page 2-13.

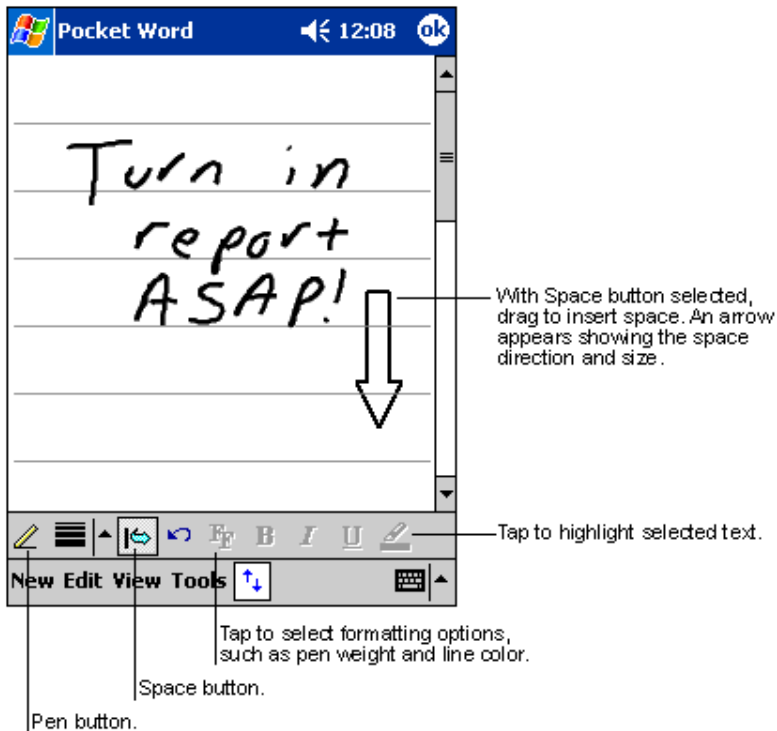

Figure 6-3. Writing on the Screen in Pocket Word

If you cross three ruled lines in a single stylus stroke, the writing becomes a drawing, and can be edited and manipulated as described in the following section.

Written words are converted to graphics (metafiles) when a Pocket Word document is converted to a Word document on your desktop computer.

Drawing Mode

In drawing mode, use your stylus to draw on the screen. Gridlines appear as a guide. When you lift your stylus after the first stroke, a drawing box indicates the boundaries of the drawing. Every subsequent stroke within or touching the drawing box becomes part of the drawing. For more information, see [Drawing on the Screen](#) on page 2-17.

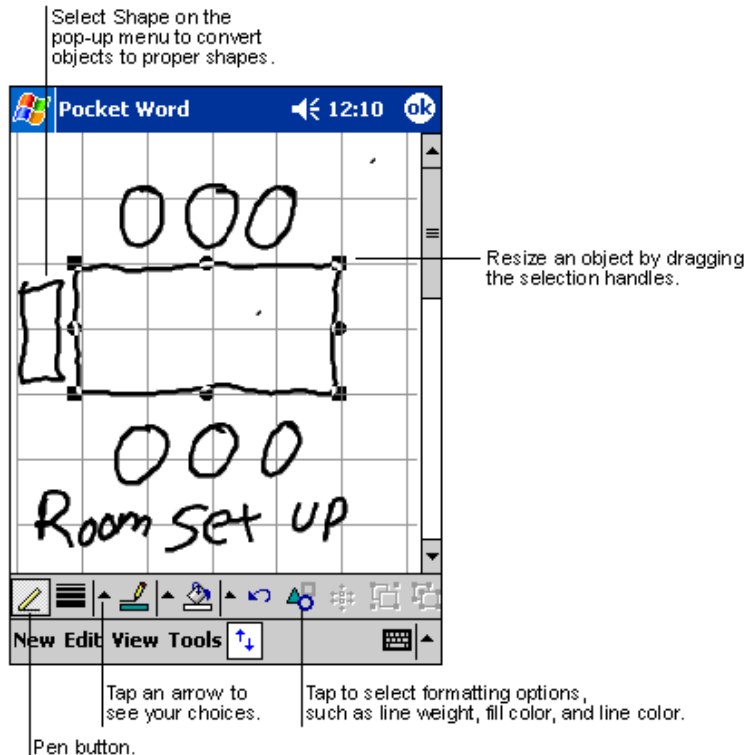
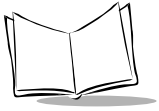

Figure 6-4. Drawing on the Screen in Pocket Word

Recording Mode

In recording mode, you may embed a recording into your document. Recordings are saved as .wav files. For more information, see [Recording a Message](#) on page 2-18.

For more information on using Pocket Word, tap *Start*, then *Help*.



Pocket Excel

Pocket Excel works with Microsoft Excel on your desktop computer to provide easy access to copies of your workbooks. You can create new workbooks on your PPT 2800, or copy workbooks from your desktop computer to your PPT 2800. Synchronize workbooks between your desktop computer and your PPT 2800 so you have up-to-date content in both locations.

To create a new workbook in Pocket Excel, such as an expense report or mileage log, tap *Start, Programs, Pocket Excel*, then *New*. A blank workbook appears. Or, if you've selected a template for new workbooks in the *Options* dialog box, that template appears with appropriate text and formatting already provided. You can open only one workbook at a time; when you open a second workbook, you'll be asked to save the first. You can save a workbook in a variety of formats, including Pocket Excel (.pxl) and Excel (.xls).

Pocket Excel lists the files stored on your PPT 2800. Tap a file in the list to open it. To delete, make copies of, or send a file, tap and hold a file in the list, then select the appropriate action from the pop-up menu.

Pocket Excel provides fundamental spreadsheet tools, such as formulas, functions, sorting, and filtering. To display the toolbar, tap *View*, then *Toolbar*.

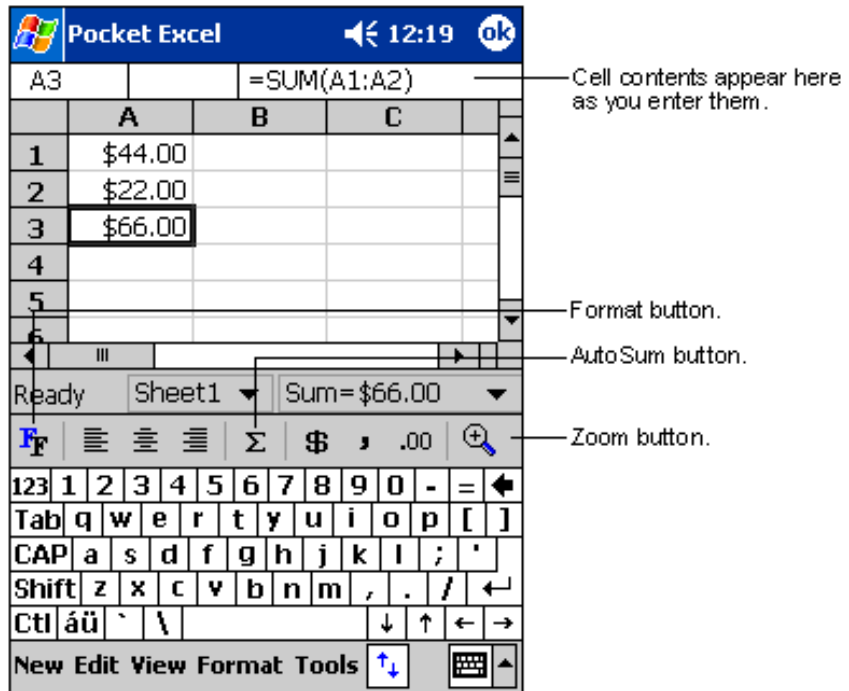

Figure 6-5. Using Pocket Excel

If your workbook contains sensitive information, you can protect it with a password. Open the workbook, tap *Edit*, then *Password*. Every time you open the workbook, you must enter the password, so choose one easy for you to remember but hard for others to guess.

Tips for Working in Pocket Excel

When working in large worksheets in Pocket Excel:

- View in full-screen mode to see as much of your worksheet as possible. Tap *View*, then *Full Screen*. To exit full-screen mode, tap *Restore*.
- Show and hide window elements. Tap *View*, then the elements you want to show or hide.

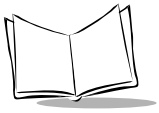

- Freeze panes on a worksheet. First select the cell where you want to freeze panes. Tap *View*, then *Freeze Panes*. You may want to freeze the top and leftmost panes in a worksheet to keep row and column labels visible as you scroll through a sheet.
- Split panes to view different areas of a large worksheet. Tap *View*, then *Split*. Drag the split bar to where you want it. To remove the split, tap *View*, then *Remove Split*.
- Show and hide rows and columns. To hide a row or column, select a cell in that row or column. Tap *Format*, then *Row* or *Column*, then *Hide*. To show a hidden row or column, tap *Tools*, then *Go To*, then type a reference that is in the hidden row or column. Tap *Format*, then *Row* or *Column*, then *Unhide*.

For more information on using Pocket Excel, tap *Start*, then *Help*.

MSN[®] Messenger

With the MSN Messenger instant messaging program on your PPT 2800 you can:

- see who is online
- send and receive instant messages
- have instant message conversations with groups of contacts.

To use MSN Messenger, you need a Microsoft Passport™ account or a Microsoft Exchange e-mail account. You need a Passport to use MSN Messenger Service. If you have a Hotmail® or MSN account, you already have a Passport. Once you have either a Microsoft Passport or a Microsoft Exchange account, you can set up your account.

To switch to MSN Messenger, tap *Start*, *Programs*, then tap *MSN Messenger*.

Setting Up Your Account

Before you can connect, set up the Passport or Exchange account and sign in:

1. In the *Tools* menu, tap *Options*.
2. In the *Accounts* tab, enter your Passport or Exchange account information.
3. Tap the sign-in screen and enter your e-mail address and password.

If you use MSN Messenger on your desktop computer, your contacts automatically appear on your terminal.

Working with Contacts

The MSN Messenger window is divided into Online and Not Online categories. From this view, while connected, you can chat, send e-mail, block the contact from chatting with you, or delete contacts from your list using the pop-up menu.

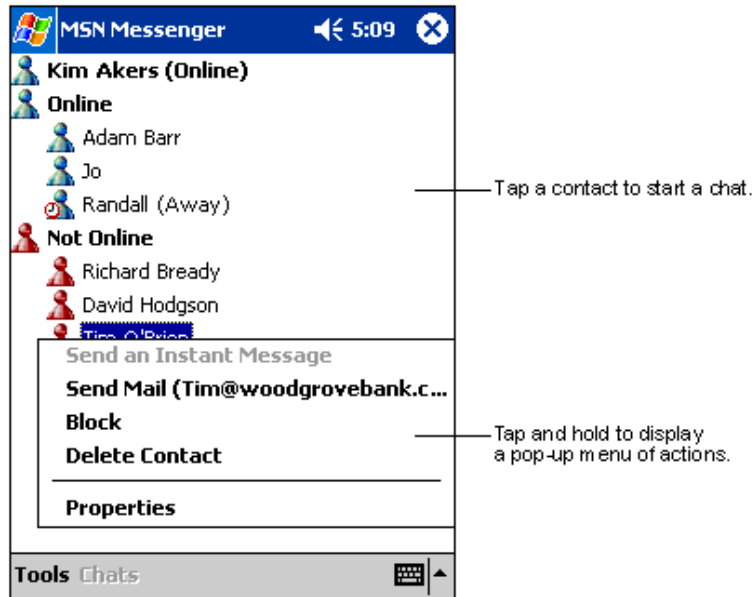
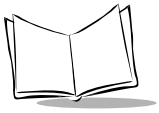

Figure 6-6. MSN Messenger Contacts

Note: To see others online without being seen, in the Tools menu, tap My Status and select Appear Offline. You appear offline but remain on the blocked contact's list.

To unblock a contact, tap and hold the contact, then tap Unblock on the pop-up menu.



Chatting with Contacts

Tap a contact name to open a chat window. Enter your message in the text entry area at the bottom of the screen, or tap *My Text* to enter a preset message, and tap *Send*. To invite another contact to a multi-user chat, in the *Tools* menu, tap *Invite* and tap the contact you want to invite.

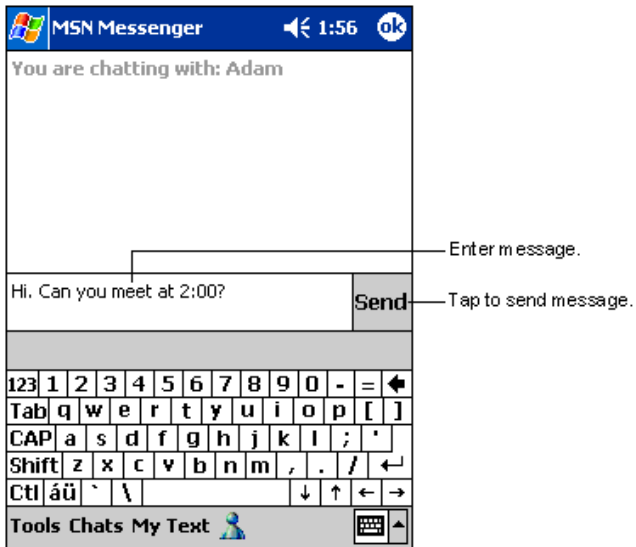

Figure 6-7. Sending a Message

To switch back to the main window without closing a chat, tap the *Contacts* button. To revert back to your chat window, tap *Chats* and select the person you were chatting with.

To know if the contact you are chatting with is responding, look for the message under the text entry area.

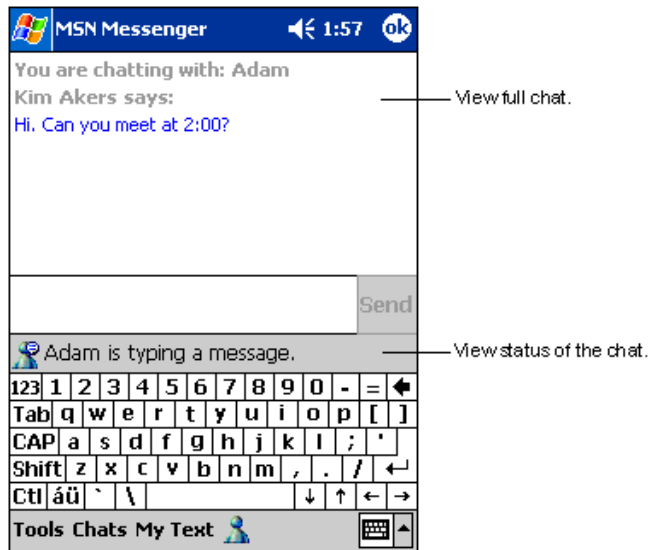
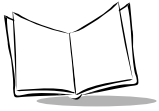
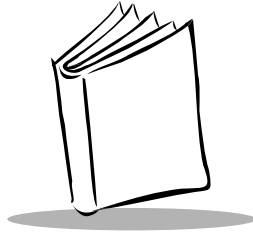

Figure 6-8. Receiving a Message

For more information on using MSN Messenger, tap *Start*, then *Help*.



PPT 2800 Series Product Reference Guide for Pocket PC 2002



Chapter 7

Pocket Internet Explorer

Chapter Contents

Introduction	7-3
Mobile Favorites	7-3
Favorite Links	7-3
Creating Mobile Favorites	7-3
Saving Memory on your Terminal	7-4
Using AvantGo Channels	7-5
Using Pocket Internet Explorer	7-6
Browsing the Web	7-8

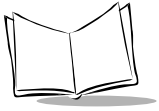

PPT 2800 Series Product Reference Guide for Pocket PC 2002

Introduction

With Microsoft Pocket Internet Explorer, you can view Web or WAP pages in the following ways:

- During synchronization with your desktop computer, download your favorite links and mobile favorites stored in the Mobile Favorites subfolder in Internet Explorer on the desktop computer.
- Connect to an Internet service provider (ISP) or network and browse the Web. First create the connection (see [Chapter 8, Connections](#)).

To select Pocket Internet Explorer, tap , then *Internet Explorer*.

Mobile Favorites

Items stored in the Mobile Favorites subfolder in the Favorites folder in Internet Explorer on your desktop computer are synchronized with your terminal. This folder was created automatically when you installed ActiveSync.

Favorite Links

Synchronization updates the list of favorite links both in the Mobile Favorites folder on your desktop computer and in Pocket Internet Explorer on your terminal. Unless you mark the favorite link as a mobile favorite, only the link is downloaded to your terminal; you must connect to your ISP or network to view the content. For more information on synchronization, see ActiveSync Help on the desktop computer.

Creating Mobile Favorites

If you are using Microsoft Internet Explorer 5 or later on your desktop computer, you can download mobile favorites. Synchronizing mobile favorites downloads Web content to your terminal so you can view Web pages while disconnected from your ISP and desktop computer.

Use the Internet Explorer plug-in installed with ActiveSync to create mobile favorites:

1. In Internet Explorer on your desktop computer, click *Tools*, then *Create Mobile Favorite*.
2. To change the link name, enter a new name in the *Name* box.
3. If desired, select a desired update schedule in *Update*.

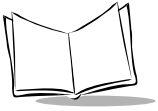

4. Click **OK**. Internet Explorer downloads the latest version of the Web page to your desktop computer.
5. To download the pages linked to the mobile favorite you just created, in Internet Explorer on the desktop computer, right-click the mobile favorite, then click *Properties*. On the *Download* tab, specify the number of links deep you want to download. To conserve terminal memory, only go one level deep.
6. Synchronize your terminal and desktop computer. Mobile favorites stored in the Mobile Favorites folder in Internet Explorer are downloaded to your terminal.

If you did not specify an update schedule in step 3, you must manually download content to keep the information updated on your desktop computer and terminal. Before synchronizing, in Internet Explorer on your desktop computer, click *Tools*, then *Synchronize*. Note the last time content was downloaded to the desktop computer; if necessary, manually download content.

You can add a button to the Internet Explorer toolbar for creating mobile favorites. In Internet Explorer on your desktop computer, click *View, Toolbars*, then *Customize*.

Saving Memory on your Terminal

Mobile favorites take up storage memory on your terminal. To minimize the amount of memory used:

- In the settings for the Favorites information type in ActiveSync options, turn off pictures and sounds or stop some mobile favorites from downloading. For more information, see ActiveSync Help.
- Limit the number of downloaded linked pages. In Internet Explorer on the desktop computer, right-click the mobile favorite you want to change, then select *Properties*. On the *Download* tab, specify 0 or 1 for the number of linked pages to download.

Using AvantGo Channels

AvantGo is a free interactive service that gives you access to personalized content and thousands of popular Web sites. Subscribe to AvantGo channels directly from your terminal, then synchronize with your desktop computer, or connect to the Internet to download the content. For more information, visit the AvantGo Web site.

To sign up for AvantGo:

1. In ActiveSync options on the desktop computer, turn on synchronization for the AvantGo information type.
2. In Pocket Internet Explorer on your terminal, tap the `Favorites` button to display your list of favorites.
3. Tap the *AvantGo Channels* link.
4. Tap the `Activate` button.
5. Follow the directions on the screen. You must synchronize your terminal with your desktop computer, then tap the `My Channels` button to complete setup.

When synchronization is complete, tap the *AvantGo Channels* link in your list of favorites to see a few of the most popular channels. To add or remove channels, tap the *Add* or *Remove* link.

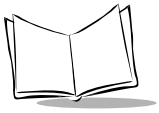

Using Pocket Internet Explorer

With Pocket Internet Explorer, you can browse mobile favorites and channels downloaded to your terminal without connecting to the Internet. You can also connect to the Internet through an ISP or a network connection and browse the Web.

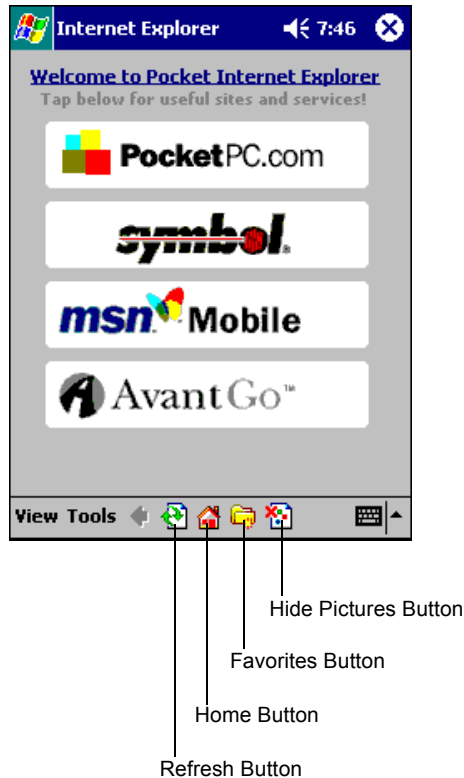

Figure 7-1. Pocket Internet Explorer

To view mobile favorites and channels, tap the **Favorites** button to display your list of favorites, then tap the page you want to view.

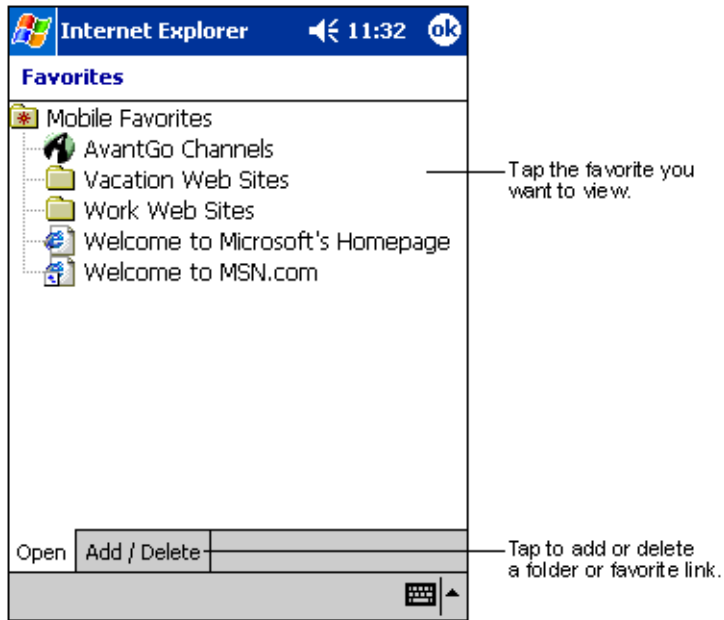
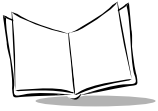

Figure 7-2. Mobile Favorites

You'll see the page that was downloaded the last time you synchronized with your desktop computer. If the page is not on your terminal, the favorite is dimmed. Synchronize with your desktop computer again to download the page to your terminal, or connect to the Internet to view the page.



Browsing the Web

1. Connect to your ISP or network using Connections; see [Chapter 8, Connections](#).
2. Once connected, go to a specific Web page in one of the following ways:
 - Tap the **Favorites** button, then tap the favorite you want to view.
 - Tap **View**, then **Address Bar**. In the address bar at the top of the screen, enter the Web address and tap **Go**. Tap the arrow to choose from previously entered addresses.
3. To end the connection, tap **Tools**, then **Disconnect**.

Note: *If you select Pocket Internet Explorer before setting up the network connections, a screen may appear allowing you to proceed to the connection settings screen. After you select your settings, you return to Pocket Internet Explorer.*

To add a favorite link while using the terminal, go to the Web page you want to add, tap and hold on the page, and tap Add to Favorites.

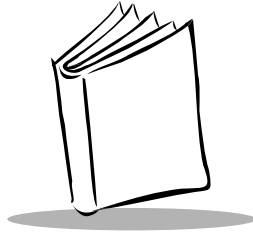

Chapter 8

Connections

Chapter Contents

Introduction	8-3
Transferring Items Using Infrared	8-4
Connecting to an ISP	8-4
Connecting to Your Network	8-7
Creating a Modem Connection to a Network	8-7
Disconnecting	8-9
Connecting Directly to an E-mail Server	8-9
Setting Up an E-mail Service	8-9
Getting Help Connecting	8-9

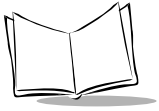

PPT 2800 Series Product Reference Guide for Pocket PC 2002

Introduction

Your terminal can exchange information with other Windows-powered devices via the cradle or cable, or through the following connection options:

- Use the infrared (IR) port to send and receive files between two terminals. See [Transferring Items Using Infrared](#) on page 8-4.
- Connect to your Internet service provider (ISP) to send and receive e-mail messages using Inbox and view Web or WAP pages using Pocket Internet Explorer. See [Connecting to an ISP](#) on page 8-4. The communication software for creating an ISP connection is already installed on your terminal. Your service provider provides software needed to install other services, such as paging and fax services.
- Connect to a network to send and receive e-mail messages using Inbox, view Web or WAP pages using Pocket Internet Explorer, and synchronize with your desktop computer. See [Connecting to Your Network](#) on page 8-7.
- Wirelessly via Spectrum24 LAN. See [Chapter 9, Spectrum24 Network Configuration](#).
- Connect to your desktop computer to synchronize remotely. See ActiveSync Help on your desktop computer or Connections Help on your terminal.

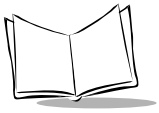

Transferring Items Using Infrared

Using infrared (IR), you can send and receive information, such as contacts and appointments, between two Windows-powered devices.

To send information:

1. Open the program where you created the item you want to send and locate the item in the list.
2. Align the IR ports so that they are unobstructed and within close range.
3. Tap and hold the item, and tap *Beam [item]* on the pop-up menu.

Note: *You can also send items, but not folders, from File Explorer. Tap and hold the item, then tap Beam File on the pop-up menu.*

To receive information, align the IR ports so that they are unobstructed and within close range. When information is sent from the other device, your terminal receives it automatically.

Note: *In order for IR receive to work automatically, you must first check the Receive all incoming beams and select discoverable mode checkbox in Start/Settings/Connections/Beam. If this box is not checked, select Start Programs Infrared Receive before receiving data from another device.*

Connecting to an ISP

You may use a modem to connect to your Internet Service Provider (ISP). Once connected, you can send and receive e-mail messages and view Web or WAP pages.

To create a modem connection to an ISP, use the modem cradle or snap-on modem. See the *Quick Reference Guide* for each device for connection information.

1. Get the ISP dial-up access telephone number, user name, password, and TCP/IP settings from your ISP. Some ISPs require information in front of the user name, such as MSN/username.

2. Tap *Start*, then *Settings*. On the *Connections* tab, tap *Connections*. Select *Internet Settings* from the drop-down menu and tap *Modify*.

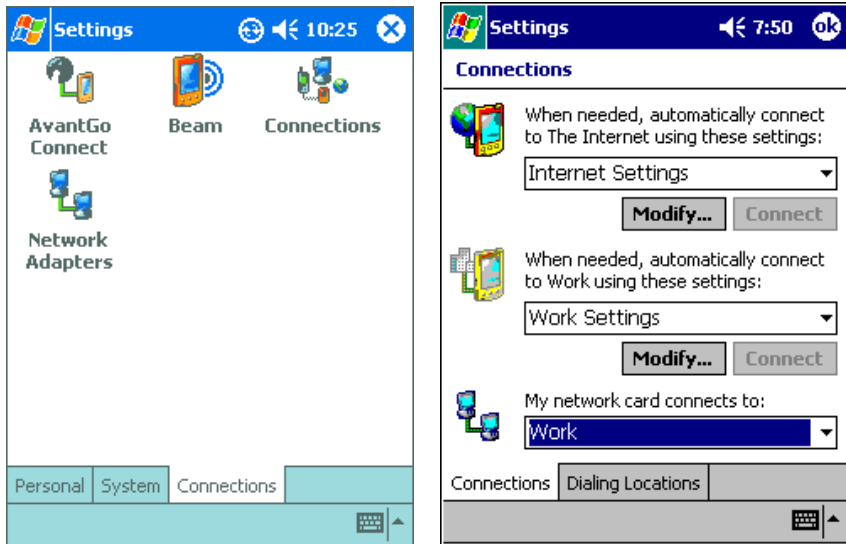
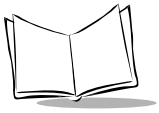

Figure 8-1. Creating a Modem Connection to an ISP

3. In the *Modem* tab, tap *New*.
4. Enter a name for the connection.
5. In the *Select a modem* list, select *Hayes Compatible on COM7*.
6. In *Baud Rate* select *57600*.
7. You should not need to change any settings in *Advanced*. Most ISPs now use a server-assigned address. If the ISP you are connecting to does not use a server-assigned address, tap *Advanced*, then review the *TCP/IP* and *Name Servers* tabs and enter the addresses per their instructions. When finished, tap *OK*.
8. On the *Make New Connection* screen, tap *Next*.
9. Enter the access phone number and tap *Next*.
10. Select other desired options, and tap *Finish* to return to the *Internet Settings Modem* tab.
11. Tap *OK* to return to the *Connections* screen above.



12. On the *Dialing Locations* tab, specify your current location and phone settings (most phone lines are tone). These settings apply to all connections you create.

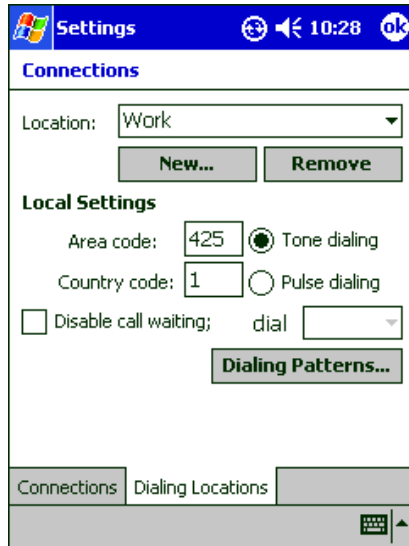

Figure 8-2. Dialing Locations Tab

13. Tap *Dialing Patterns...* and enter the dial patterns appropriate for your phone system. For example, if you dial 9 before calling a local number, the pattern is: 9,G
14. Tap *OK* until you exit *Connection Settings*.

To start the connection, use one of the following programs and the terminal will connect automatically:

- Send and receive e-mail messages using *Inbox*. You first must provide the information it needs to communicate with the e-mail server. For instructions, see [Connecting Directly to an E-mail Server](#) on page 8-9.
- Visit Web and WAP pages using *Pocket Internet Explorer*. For more information, see [Chapter 7, Pocket Internet Explorer](#).

Connecting to Your Network

If you have access to a network, you can send e-mail messages, view intranet pages, synchronize your terminal, and possibly access the Internet. You can connect to your network in one of the following ways:

- Create a modem connection using an RAS account. Your network administrator must first set up an RAS account for you.
- Wirelessly via Spectrum24 LAN. See [Chapter 9, Spectrum24 Network Configuration](#).

Creating a Modem Connection to a Network

To create a modem connection, use the modem cradle or snap-on modem. See the *Quick Reference Guide* for each device for connection information.

1. Obtain the dial-up access telephone number, user name, password, domain name, and TCP/IP settings from your network administrator.
2. Tap *Start*, then *Settings*. On the *Connections* tab, tap *Connections*. In the center drop-down menu, select *Work Settings* and tap *Modify*.

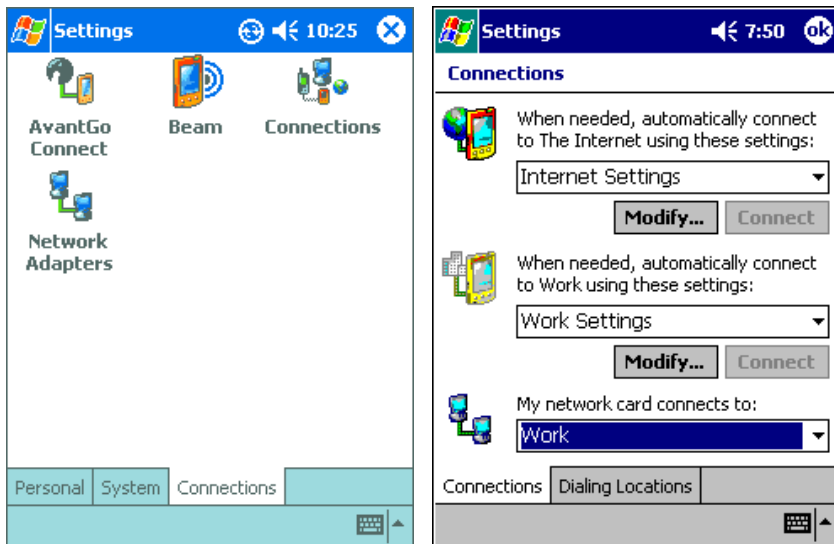
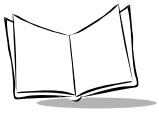

Figure 8-3. Creating a Modem Connection to a Network



3. In the *Modem* tab, tap *New*.
4. Enter a name for the connection.
5. In the *Select a modem* list, select *Hayes Compatible on COM7*.
6. In *Baud Rate* select *57600*.
7. You should not need to change any settings in *Advanced*. Most ISPs now use a server-assigned address. If the ISP you are connecting to does not use a server-assigned address, tap *Advanced*, then review the *TCP/IP* and *Name Servers* tabs and enter the addresses per their instructions. When finished, tap *OK*.
8. On the *Make New Connection* screen, tap *Next*.
9. Enter the access phone number and tap *Next*.
10. Select other desired options, and tap *Finish* to return to the *Internet Settings Modem* tab.
11. Tap *OK* to return to the *Connections* screen above.
12. In the bottom drop-down menu (*My network card connects to:*), select *The Internet*.
13. On the *Dialing Locations* tab, specify your current location and phone settings (most phone lines are tone). These settings apply to all connections you create.

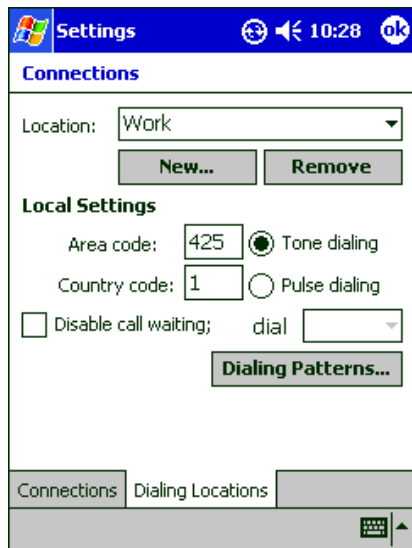

Figure 8-4. Dialing Locations Tab

14. Tap *Dialing Patterns...* and enter the dial patterns appropriate for your phone system. For example, if you dial 9 before calling a local number, the pattern is: 9,G
15. Tap *OK* until you exit *Connection Settings*.

To start the connection, use one of the following programs and the terminal will connect automatically:

- Send and receive e-mail messages using *Inbox*. Before you can use *Inbox*, provide the information it needs to communicate with the e-mail server. See [Connecting Directly to an E-mail Server](#).
- Synchronize. For more information, see *ActiveSync Help* on the desktop computer.

Disconnecting

Choose one of the following ways to disconnect:

- When connected via dial-up or VPN, tap the *Connection* icon on your navigation bar, then tap *End*.
- When connected via cable or serial cradle, detach your terminal from the cable or cradle.
- When connected via Infrared, move the terminal away from the desktop computer.

Connecting Directly to an E-mail Server

You can set up a connection to an e-mail server to send and receive e-mail messages using a modem or network connection and *Inbox* on your terminal.

Note: *The ISP or network must use a POP3 e-mail server and an SMTP gateway.*

You can use multiple e-mail services to receive your messages. For each e-mail service you intend to use, first set up and name the e-mail service. If you use the same service to connect to different mailboxes, set up and name each mailbox connection.

Setting Up an E-mail Service

In *Inbox* on your terminal, tap *Services*, then *New Service*. Follow the instructions in the *New Service* wizard on the screen. For an explanation of a screen, tap *Start*, then *Help*.

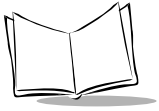

When finished, tap *Services*, then *Connect* to connect to your e-mail server. For more information on using the Inbox program, see [Inbox](#) on page 5-14.

Getting Help Connecting

See the following for more connection information:

- [Inbox on page 5-14](#)
- Online Help on the terminal. Tap *Start*, then *Help*. Tap *View, All Installed Help*, then *Inbox* or *Connections*.
- ActiveSync Help on the desktop computer. In ActiveSync, click *Microsoft ActiveSync Help* on the *Help* menu.
- [Maintenance and Troubleshooting](#) on page 13-1.

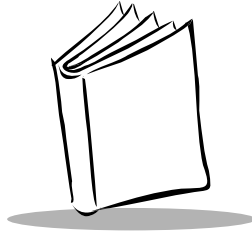

Chapter 9

Spectrum24 Network Configuration

Chapter Contents

Introduction	9-3
Configuring the PPT 2842 (2 MB Radio)	9-4
Network Adapters Properties	9-4
Using PPT 2842 Spectrum24 Settings	9-6
Using NICTT with the PPT 2842	9-13
Configuring the PPT 2846 (11 MB Radio)	9-19
Network Adapters Properties	9-19
Using NICTT with the PPT 2846	9-21

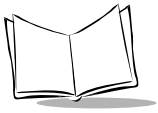

PPT 2800 Series Product Reference Guide for Pocket PC 2002

Introduction

Wireless LANs allow PPT 2800 series terminals to communicate wirelessly, and to send captured data “real time” to a host device. Before a terminal can be used on a Spectrum24 LAN your facility must be set up with the equipment required to run the wireless LAN and the terminal must be properly configured. Refer to the documentation which came with your access points for instructions on setting up the required hardware.

The PPT 284x terminal Spectrum24 settings and NICTT settings configure and monitor the Spectrum24 connection.

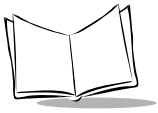

Configuring the PPT 2842 (2 MB Radio)

Before the PPT 2842 can be used, it must be properly configured for the Spectrum24 Wireless LAN.

1. Select *Settings* from the *Start* menu.
2. Select *Network Adapters* from the *Connections* tab.
3. Select *Spectrum24 WLAN Driver*.

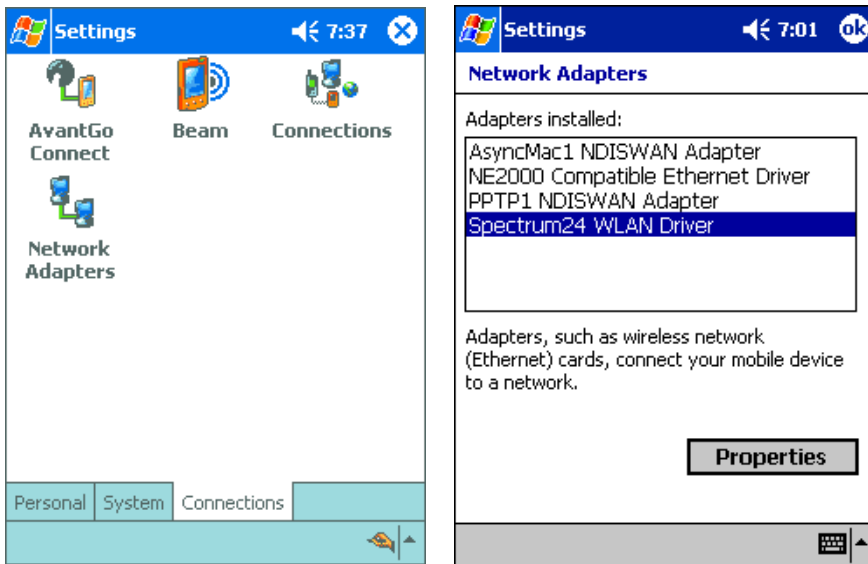

Figure 9-1. Network Adapters

Network Adapters Properties

Tap *Properties* to view the current adapter IP configuration settings. **DHCP** (Dynamic Host Configuration Protocol) obtains a leased IP address and network configuration information from a remote server. An access point sends out a DHCP request searching for a DHCP server to acquire the network configuration and firmware filenames.

Use the property screens to view and adjust the IP address, subnet, gateway, DNS, and WINS.

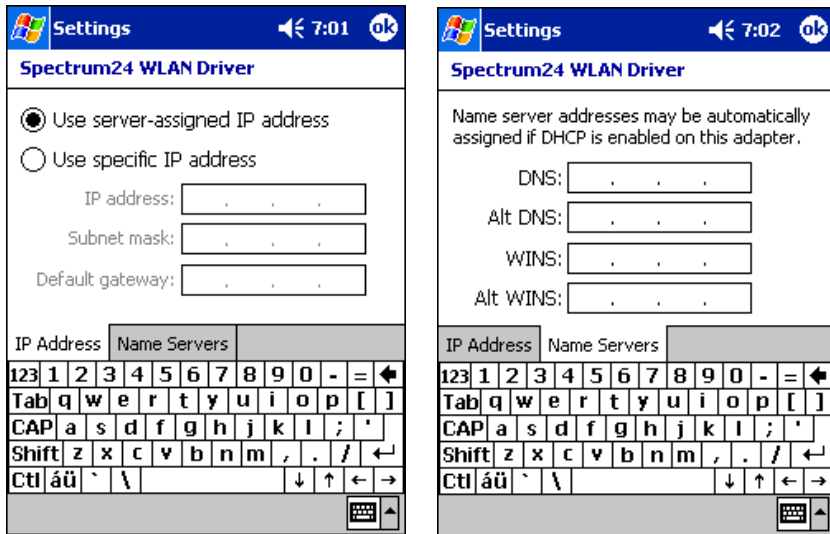
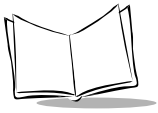

Figure 9-2. IP Network Adapter Property Screens

- **IP Address:** A 32-bit (max) value expressed as four decimal numbers from 0 to 255, separated by periods (e.g., 157.235.90.24) that the terminal uses to transmit and receive data. The IP address of the adapter is required to be in the same subnet as that of the access point for the devices to interoperate in Infrastructure mode.
- **Subnet Mask:** A 32-bit value expressed as four decimal numbers from 0 to 255, separated by periods (e.g., 255.255.0.0) which allows TCP/IP to determine the network ID portion of an IP address. Required in order for the subnet to exist. Its purpose is to *mask out* IP addresses that are not part of the subnet. The network administrator usually has the required subnet mask.
- **Gateway:** Used to connect to the corporate network. The network administrator usually has the IP address required for the default gateway.
- **DNS (Domain Name System):** The IP address of a server containing a database of host names and their associated IP addresses so that when a host name is used, it can be resolved into its IP address.
- **WINS (Windows Internet Name Service):** A NetBIOS Name Server that registers your NetBIOS names and resolves into IP addresses, similar to DNS.



Using PPT 2842 Spectrum24 Settings

On the *Start* menu, select *Settings*, the *System* tab, then *Spectrum24 FH Settings*.

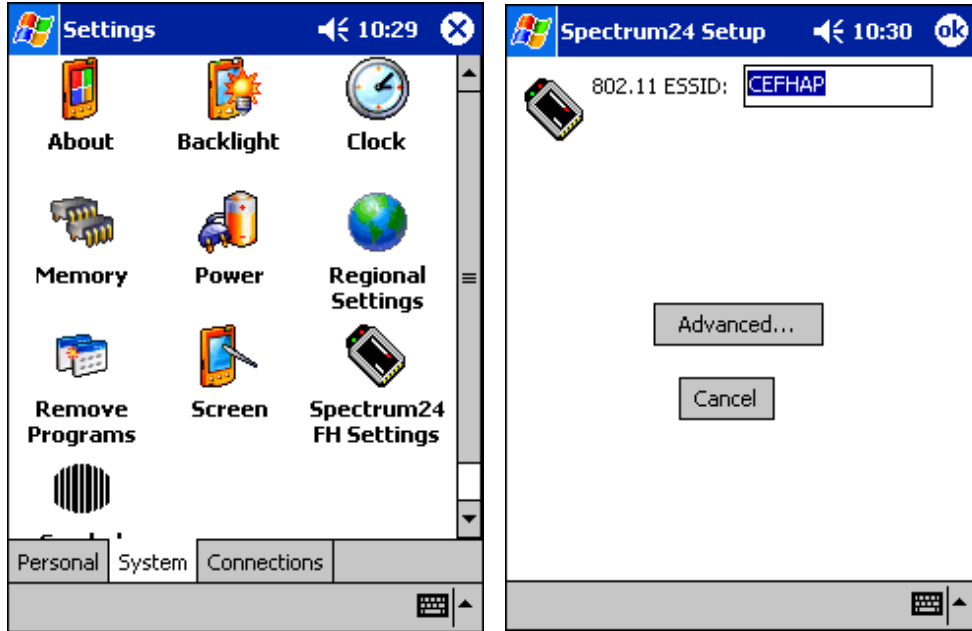

Figure 9-3. Spectrum24 Setup

The ESS ID identifies the radio network and is used to differentiate between different radio networks. All PPT 2842 terminals on the same network must be set up with the same ESS ID Code. The ESS ID on the terminal is the same as that of the access points in your facility.

Enter an ESSID (802.11 Extended Service Set Identifier) matching the access point ESSID to enable the terminal to communicate with the access point. This value is a unique 32-character (maximum) string that identifies the wireless local area network. If the ESSID is unknown, ask the IS department for assistance.

Advanced Settings

Only system administrators should modify the advanced settings. Select the *Advanced* button to view and edit the advanced property screens and create a password for these screens. The advanced property screens control all aspects of the terminal, including Mobile Unit, Encryption, and WLAN Adapter settings.

Mobile Unit Properties

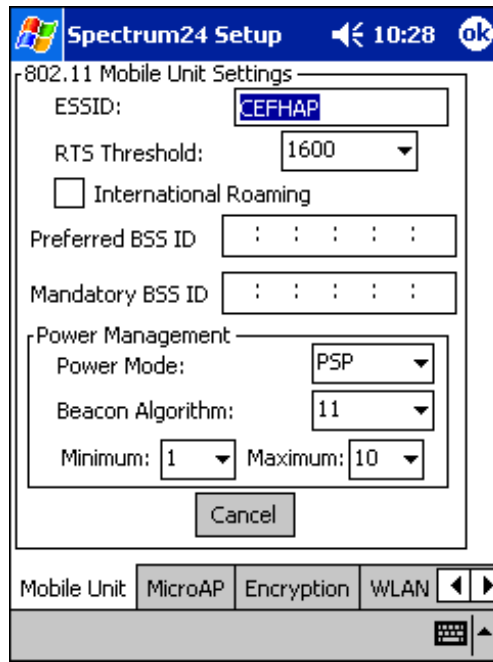
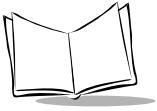

Figure 9-4. Mobile Unit Property Screen

The *Mobile Unit* tab in Advanced Properties configures the adapter's ESSID, Preferred and Mandatory BSSIDs, and Power Management.

- Enter a 32-character (maximum) case-sensitive ESS ID (802.11 Extended Service Set Identifier) in the *ESSID* field to identify the wireless local area network. This identifier must match the ESSID in the 802.11 access point(s) on your network in order for your WLAN adapter to communicate with the access point(s). If you don't know your ESSID, ask your IS department personnel for assistance.
- The *Preferred BSS ID* is the IEEE MAC address of the access point (AP) where the adapter prefers to associate. The adapter gives higher priority to this AP when communicating on the network.
- The *Mandatory BSS ID* address is the IEEE MAC address of the access point (AP) where the adapter must associate. The adapter only associates to this access point when communicating on the network.



- In the Power Management section of the screen, select one of the two power modes, Continuous Access Mode (CAM) and Power Save Poll (PSP) mode. CAM yields the best performance but uses the most power, and is the preferred mode for systems running on AC power. PSP saves significant amounts of power over CAM, so is preferred for systems running on battery power.
- If you select PSP mode, also select a Beacon Algorithms to allow more control over the PSP process. Beacon Algorithms 1 through 10 control the number of ticks the adapter sleeps before waking up to check for data. Each tick is 1/10th of a second. For example, PSP Beacon Algorithm 1 wakes the adapter every 1/10th of a second to look for data. This is the fastest PSP mode of operation. PSP Beacon Algorithm 10 sleeps 10/10ths of a second (or 1 second) before waking up to look for data.

Beacon Algorithm 11 automatically varies the PSP algorithm between the minimum and maximum values, depending on the amount of data being sent or received by the adapter. To control these values, set the Beacon Minimum and Beacon Maximum values.

Micro AP Properties

MicroAP properties are not supported by the PPT 2842.

Encryption Properties

Use the *Encryption* tab in Advanced Properties to control encryption options.

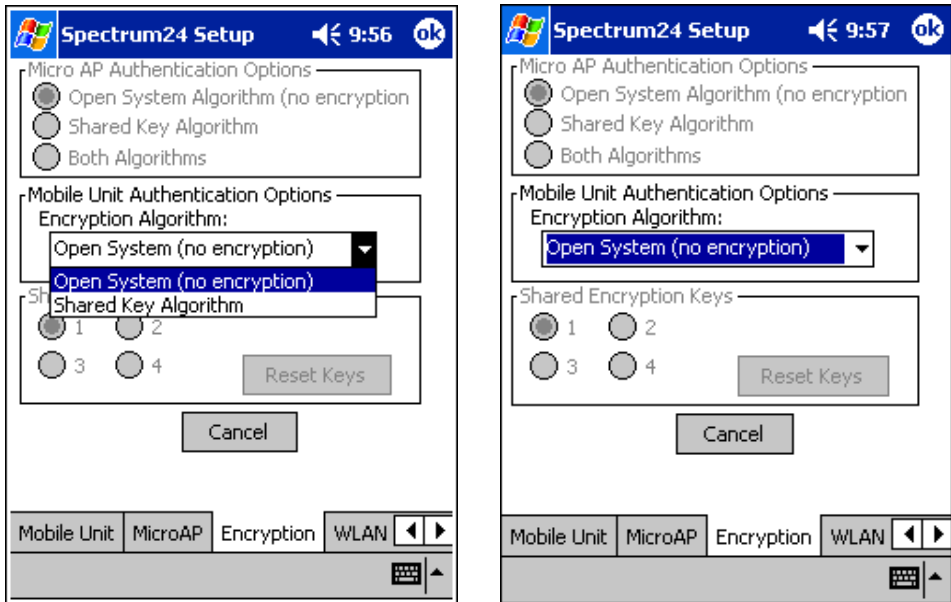
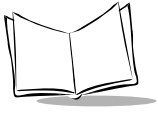

Figure 9-5. Encryption Properties Screen

The Encryption tab allows you to encrypt WLAN data packets to protect your data from inspection by systems that may intercept wireless data over the network.

- In the *Mobile Unit Authentication Options* section, select either the *Open System* or the *Shared Key* algorithm from the drop-down menu:
 - If you select *Open System*, the terminal can associate with APs that have *Open System* or *Open System and Shared Key* enabled. The data packets transmitted by terminals or APs over the WLAN are not encrypted.
 - If you select *Shared Key*, the terminal can associate and communicate with access points that use the *Shared Key* or *Open System and Shared Key* algorithms. *Shared Key* uses a 40-bit encryption key known by both the terminal and the AP to encrypt the data over the network. The terminal must provide this shared key in order to associate with the AP.



- *Shared Encryption Keys* are the 40-bit values used by the terminal and the AP to encrypt the wireless data packets. To change the default values, enter 10 hexadecimal digits for each of the four keys. Click on the key to use, or press the `Reset Keys` button to reset the keys back to the default values.

The Shared Encryption Key must match that of the access point in order for the terminal to associate.

WLAN Adapter Properties

Select the *WLAN Adapter* tab to configure hardware and radio settings and set an optional password for user access to the Advanced Properties screens.

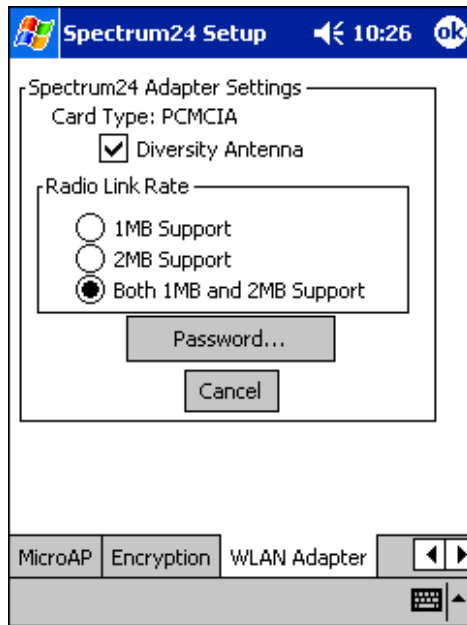
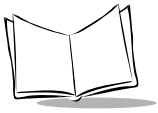

Figure 9-6. WLAN Adapter Screen

Caution

Modifying the contents of the hardware settings may cause your adapter card to stop working properly. These options are recommended for advanced users only.

- Check *Diversity Antenna* if you have a dual antenna on your WLAN adapter card. Diversity can improve communication in highly reflective environments. Do not check this if you do not have a dual antenna WLAN adapter card or a secondary antenna, as this can cause poor wireless network performance.
- In the *Radio Link Rate* section, select *1MB Support* to communicate only at 1MB per second. Select *2MB Support* to communicate at only 2MB per second. Select *Both 1MB and 2MB Support* to communicate at the best available data rate.



If you select 2MB and have only a 1MB WLAN adapter, the adapter only communicates at 1MB. On Spring adapter cards, this option is disabled, and defaults to 1MB.

- To create a password, tap *Password*.

The screenshot shows a mobile device screen titled "Spectrum24 Setup". The header bar is blue and contains the Windows logo on the left, the text "Spectrum24 Setup" in the center, a back arrow on the right, the time "10:31", and an "ok" button. The main area of the screen is white and contains three text input fields. The first field is labeled "Current Password:", the second is labeled "New Password:", and the third is labeled "Confirm New Password:". Below these fields are two buttons: "OK" and "Cancel". At the bottom right of the screen, there is a keyboard icon and a small upward-pointing arrow.







Figure 9-7. Password Screen

Enter a case-sensitive password (10 characters maximum) in the *New Password* field and the *Confirm New Password* field, and select *OK*. This enables a password screen to appear when *Advanced* is selected from the *Spectrum24 Setup* screen.

To disable the password, enter the current password in the *Current Password* field, and leave the *New Password* and *Confirm New* fields blank.

Using NICTT with the PPT 2842

The NICTT (wireless LAN) icon located on the bottom of the terminal screen indicates terminal signal strength as shown below. Tap the NICTT icon to make changes to the network configuration, or view the status of your network connection.

Icon	Status
	Excellent signal strength
	Very good signal strength
	Good signal strength
	Fair signal strength
	Poor signal strength
	Out-of-network range (not associated)
	Adapter not found

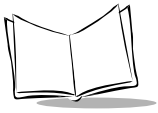

General Tab

Use the *General* tab in NICTT to configure the PPT 2842 with the correct ESS ID. The ESS ID identifies the radio network and is used to differentiate between different radio networks. All PPT 2842 terminals on the same network must be set up with the same ESS ID Code. The ESS ID on the terminal is the same as that of the access points in your facility.

The *General* tab displays driver firmware and revision information, and allows you to change the ESSID on the NIC 802.11.

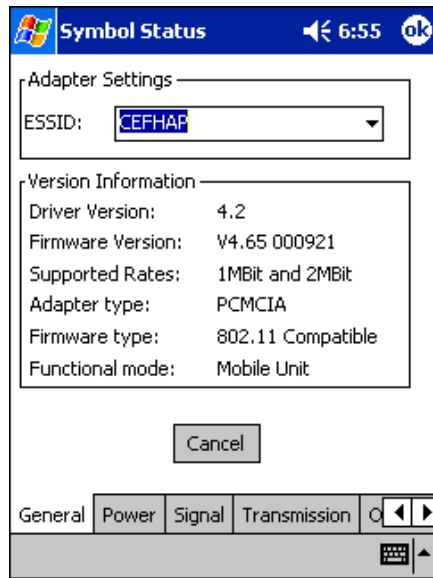

Figure 9-8. PPT 2842 NICTT Properties - General Tab

Note: A PC Card adapter installation displays PCMCIA as the Adapter Type.

Power Tab

The *Power* tab allows automatic or manual setting of the adapter power management mode.

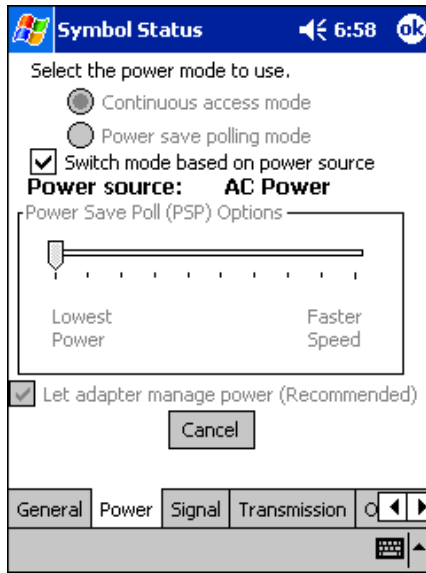
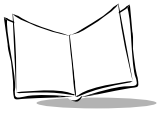

Figure 9-9. PPT 2842 NICTT Properties - Power Tab

- Select either Continuous Access Mode (**CAM**) or Power Save Polling (**PSP**) mode. CAM yields the best performance but uses the most power, so is preferred for systems running on AC power. PSP saves significant amounts of power over CAM, ideal for systems running on battery power.
- If you select PSP mode, set a *Power Save Poll (PSP) Option*, which specifies the number of ticks the adapter sleeps before waking up to check for data. Each tick is 0.1 second.
- Select *Let adapter manage power* to automatically vary the PSP options depending on the amount of data that is being sent or received by the adapter.



Signal Tab

Use the *Signal* tab to display a real-time graph of the signal quality of the adapter to the associated access point, including the number of times the adapter has roamed to and from APs, and the network status. Signal quality indicates how well the adapter receives the transmitted signal of the associated access point.

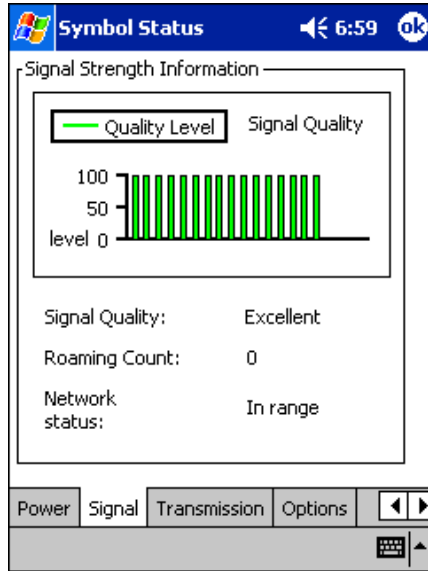

Figure 9-10. PPT 2842 NICTT Properties - *Signal* Tab

Transmission Tab

The *Transmission* tab displays a real-time graph as a series of ICMP ping tests initiated by the user. The transmission quality test does not run all the time because it consumes network bandwidth.

The transmission quality test also displays a description of the transmission quality.

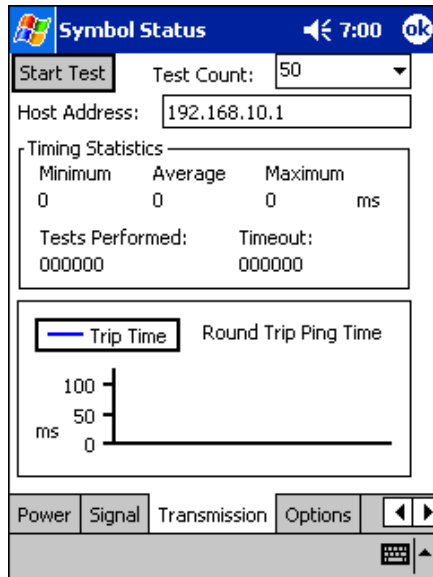
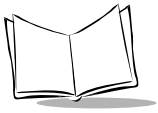

Figure 9-11. PPT 2842 NICTT Properties - Transmission Tab

Note: You must obtain a DHCP lease before running the Transmission Quality test.



Options Tab

The *Options* tab controls system sounds, and whether specified settings are temporary.

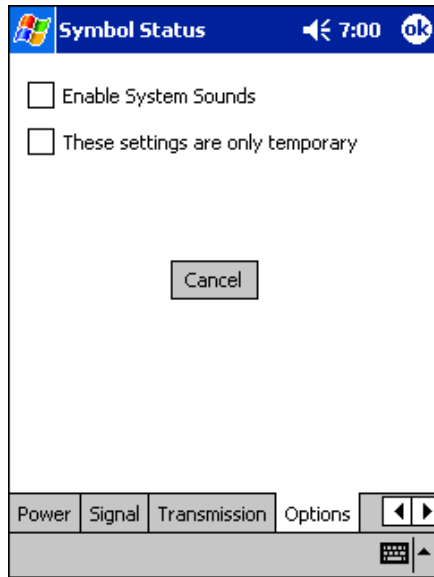

Figure 9-12. PPT 2842 NICTT Properties - *Options* Tab

Enable System Sounds: You can enable or disable NICTT system sounds. NICTT uses standard wav-table sounds supplied by the Windows operating system. NICTT plays a wav file when it detects the PPT 2842 roaming between Spectrum24 APs, and also during a transmission test.

Temporary Settings: Check *These settings are only temporary* to use temporary values only until the next reboot. When not checked, any value entered in NICTT is saved and used even after a warm boot (a cold boot clears these values).

Configuring the PPT 2846 (11 MB Radio)

Before the PPT 2846 can be used, it must be properly configured for the Spectrum24 Wireless LAN.

1. Select *Settings* from the *Start* menu.
2. Select *Network Adapters* from the *Connections* tab.
3. Select *Spectrum 24 802.11b*.

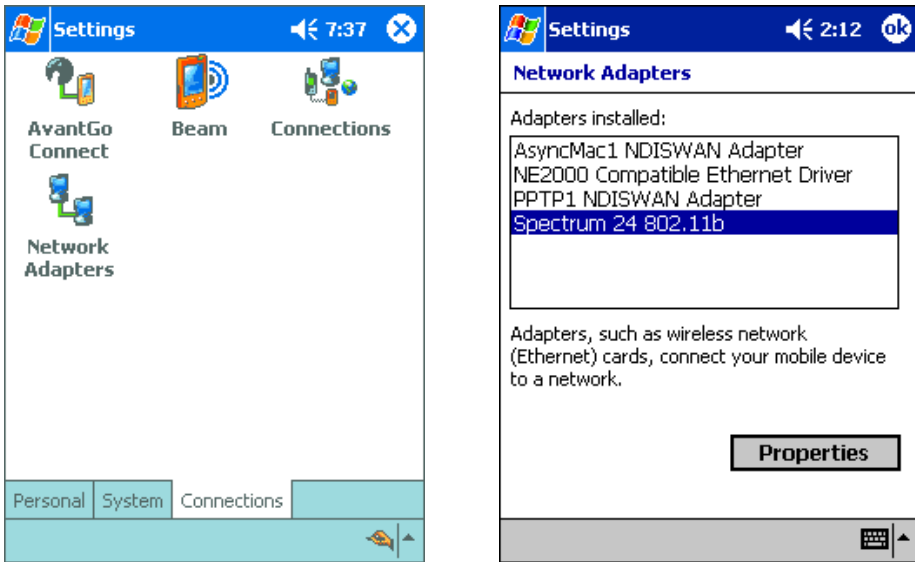
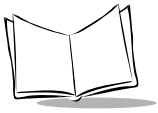

Figure 9-13. Network Adapters

Network Adapters Properties

Tap *Properties* to view the current adapter IP configuration settings. **DHCP** (Dynamic Host Configuration Protocol) obtains a leased IP address and network configuration information from a remote server. An access point sends out a DHCP request searching for a DHCP server to acquire the network configuration and firmware filenames.



Use the property screens to view and adjust the IP address, subnet, gateway, DNS, and WINS.

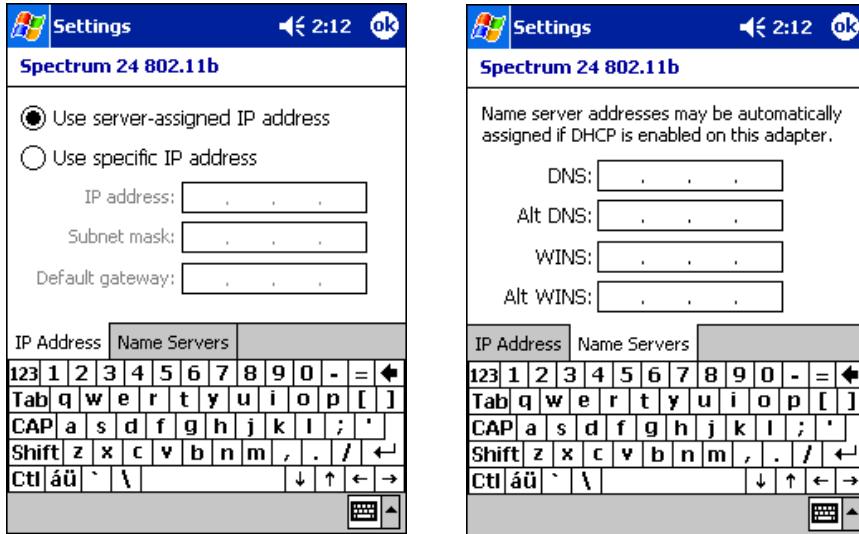









Figure 9-14. IP Network Adapter Property Screens

- **IP Address:** A 32-bit (max) value expressed as four decimal numbers from 0 to 255, separated by periods (e.g., 157.235.90.24) that the terminal uses to transmit and receive data. The IP address of the adapter is required to be in the same subnet as that of the access point for the devices to interoperate in Infrastructure mode.
- **Subnet Mask:** A 32-bit value expressed as four decimal numbers from 0 to 255, separated by periods (e.g., 255.255.0.0) which allows TCP/IP to determine the network ID portion of an IP address. Required in order for the subnet to exist. Its purpose is to *mask out* IP addresses that are not part of the subnet. The network administrator usually has the required subnet mask.
- **Gateway:** Used to connect to the corporate network. The network administrator usually has the IP address required for the default gateway.
- **DNS (Domain Name System):** The IP address of a server containing a database of host names and their associated IP addresses so that when a host name is used, it can be resolved into its IP address.
- **WINS (Windows Internet Name Service):** A NetBIOS Name Server that registers your NetBIOS names and resolves into IP addresses, similar to DNS.

Using NICTT with the PPT 2846

The NICTT (wireless LAN) icon located on the bottom of the terminal screen indicates terminal signal strength as shown below. Tap the NICTT icon to make changes to the network configuration, or view the status of your network connection.

Icon	Status
	Excellent signal strength
	Very good signal strength
	Good signal strength
	Fair signal strength
	Poor signal strength
	Out-of-network range (not associated)
	Adapter not found

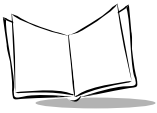

Mode Tab

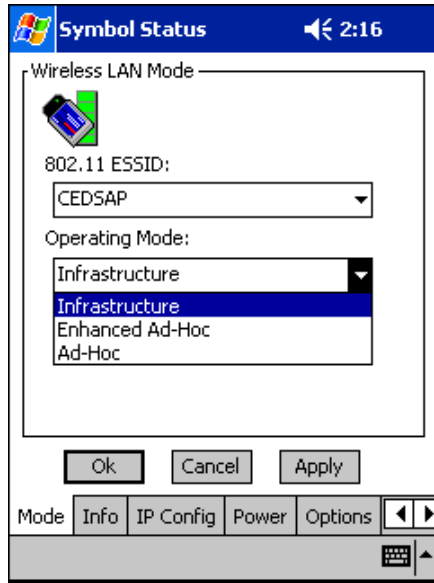

Figure 9-15. PPT 2846 NICTT Properties - Mode Tab

The *Mode* tab in NICTT configures the adapter's ESSID and operating mode.

- Use the *Operating Mode* drop-down menu to select one of the following operating modes for the terminal:

Note: *The PPT 2846 does not support Ad Hoc mode.*

- If you select *Infrastructure*, enter a 32-character maximum ESSID (802.11 Extended Service Set Identifier) in the *802.11 ESSID* field to identify the wireless local area network. This ESSID must match the access point ESSID for the adapter to communicate with the access point.
- If you select *Enhanced Ad Hoc*, enter the channel number in the *Channel* field. The first adapter configured in the Ad Hoc network defines the channel number used in the Ad Hoc network. Each adapter is required to use the same channel to transmit and receive data to its peers.

Check the `Send long preamble headers` checkbox if the other devices in your network are using a long preamble. Devices using Ad Hoc mode must use the same preamble setting to interoperate. The adapter uses a long preamble heading by default.

Note that this is a Symbol Technologies operating mode and only works with other Symbol adapters enabled in the same mode.

- If you select *Ad Hoc*, enter a 32-character maximum ESSID (802.11 Extended Service Set Identifier) in the *802.11 ESSID* field to identify the wireless local area network. This ESSID must match the ESSID of other devices using the Ad Hoc mode.

Enter the channel number in the *Channel* field. The first adapter configured in the Ad Hoc network defines the channel number used in the Ad Hoc network. Each adapter is required to use the same channel to transmit and receive data to its peers.

Check the `Send long preamble headers` checkbox if the other devices in your network are using a long preamble. Devices using Ad Hoc mode must use the same preamble setting to interoperate. The adapter uses a long preamble heading by default.

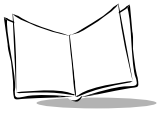

Info Tab

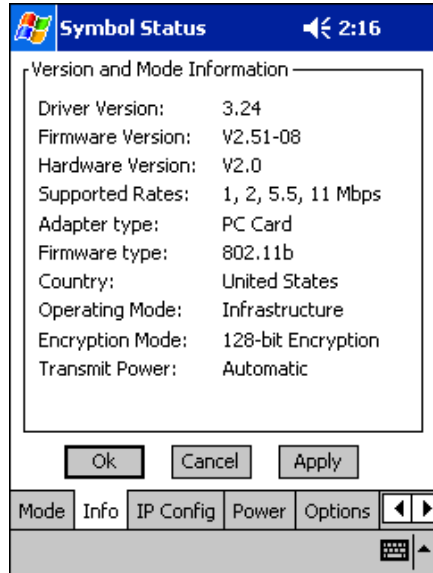

Figure 9-16. PPT 2846 NICTT Properties - Info Tab

The *Info* tab in NICTT provides information about the terminal, such as firmware and hardware versions, adapter type, and operating mode.

IP Config Tab

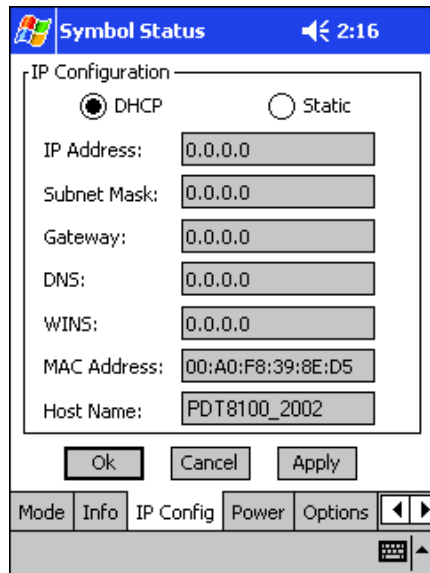
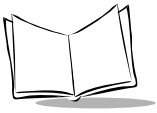

Figure 9-17. PPT 2846 NICTT Properties - IP Config Tab

The *IP Config* tab allows you to adjust IP configuration settings.

- Select *DHCP* (Dynamic Host Configuration Protocol) to obtain a leased IP address and network configuration information from a remote server. DHCP is the default setting, and when selected, IP address fields are read only.
- Select *Static* to manually enter the following fields:
 - **IP Address:** A 32-bit (max) value expressed as four decimal numbers from 0 to 255, separated by periods (e.g., 157.235.90.24) that the terminal uses to transmit and receive data. The IP address of the adapter is required to be in the same subnet as that of the access point for the devices to interoperate in Infrastructure mode.
 - **Subnet Mask:** A 32-bit value expressed as four decimal numbers from 0 to 255, separated by periods (e.g., 255.255.0.0) which allows TCP/IP to determine the network ID portion of an IP address. Required in order for the subnet to exist. Its purpose is to *mask out* IP addresses that are not part of the subnet. The network administrator usually has the required subnet mask.
 - **Gateway:** Used to forward IP packets to and from a remote destination. See



your network administrator for the IP address required for the default gateway.

- **DNS (Domain Name System):** The IP address of a server containing a database of host names and their associated IP addresses so that when a host name is used, it can be resolved into its IP address.
- **WINS (Windows Internet Name Service):** A NetBIOS Name Server that registers your NetBIOS names and resolves into IP addresses, similar to DNS.
- **MAC Address:** An IEEE 48-bit address the adapter is given at the factory which uniquely identifies the adapter at the physical layer level.
- **Host Name:** User-assigned host name.

Power Tab

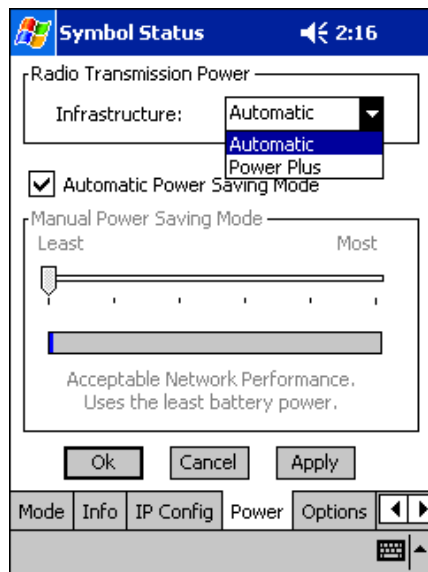

Figure 9-18. PPT 2846 NICTT Properties - Power Tab

Select the *Power* tab to set Radio Transmission Power and a Power Saving Mode.

Adjusting the *Radio Transmission Power* level enables you to expand or confine the transmission area with respect to other wireless devices that may be operating nearby. Reducing a coverage area in high traffic areas improves transmission quality by reducing the noise in that coverage area.

- In Infrastructure mode, there are two transmission power options in the *Infrastructure* drop-down menu:
 - Select *Automatic* to use the power level defined by the access point. Automatic mode is the default mode for adapters operating in Infrastructure mode.
 - Select *Power Plus* to set the adapter transmission power one level higher than the level set for the access point.
- In Enhanced Ad Hoc or Ad Hoc mode, there are five transmission power options available in the drop-down menu:
 - Select *Maximum* power to set the adapter to the highest transmission power level. This is best suited for operation in highly reflective environments and areas where other devices could be operating nearby. Also use maximum power when attempting to communicate with devices at the outer edge of a coverage area.
 - Choose *50%*, *25%* or *10%* to set the transmit power level to that percentage of the maximum power level.
 - Choose *Minimum* power to set the adapter to the lowest transmission power level. Use this level when communicating with other devices in very close proximity, or when little or no radio interference from other devices is expected.
- Check *Automatic Power Saving Mode* to switch to the Best Network Performance when the AC power supply is used.

When using the battery, select an appropriate setting between Best Network Performance and Acceptable Network Performance based on real-time analysis of the network usage. *Automatic Power Saving Mode* is the default setting and extends the operating time before the battery must be recharged.

- Uncheck *Automatic Power Saving Mode* to select *Manual Power Saving Mode*, which allows you to set the slider to a performance level suited to the intended operation. There are 6 settings ranging from the best network performance, which uses the most battery power, to acceptable network performance, which uses the least battery power.

Note: *Power savings modes are not available in Enhanced Ad Hoc operating mode.*

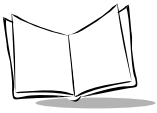

Options Tab

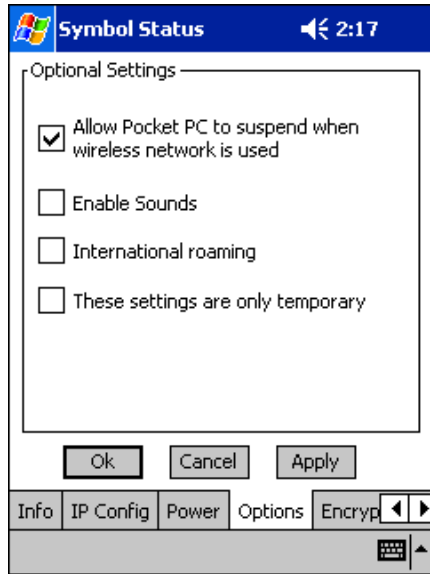

Figure 9-19. PPT 2846 NICTT Properties - Options Tab

Use the *Options* tab to enable or disable the suspend wireless network option and system sounds, and set temporary settings.

- Check the `Allow Pocket PC to suspend when wireless network is used` to allow the terminal to automatically turn off (suspend) operation based on user inactivity. This prevents battery drain. The terminal does not suspend when idle if you disable this option.
- Check `Enable Sounds` to issue a sound when performing a ping test and associating with an access point. This notifies you when a ping is completed and when a roam to an access point occurs.
- Check `International Roaming` to enable this setting, used in countries outside of the United States.
- Changes to settings you make using the Symbol Status are usually saved to the registry and used to initialize the adapter when it is inserted. Check `These settings are only temporary` to prevent your changes from being saved to the registry. If not checked, any value entered is saved in the registry.

Encryption Tab

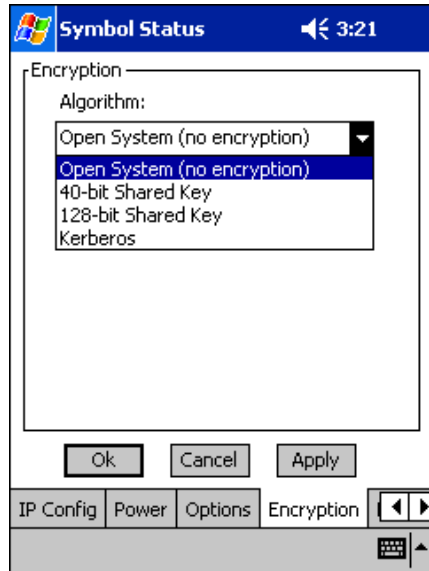
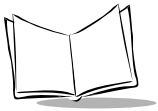

Figure 9-20. PPT 2846 NICTT Properties - Encryption Tab, Open System Selected

Use the *Encryption* tab in NICTT to control encryption options. This allows you to encrypt WLAN data packets to protect your data from inspection by systems that may intercept wireless data over the network.

- Select an *Encryption Algorithm* matching the security established in your network. The AP and the terminal's adapter must use the same encryption algorithm:
 - The *Open System* does not encrypt any of the data packets that travel over the WLAN, meaning the data packets transmitted by terminals or APs are not encrypted. Select this if no security is needed on the network.



- The *40-bit Shared Key* Algorithm uses a 40-bit encryption key known by both the terminal and the AP to encrypt the data over the network.

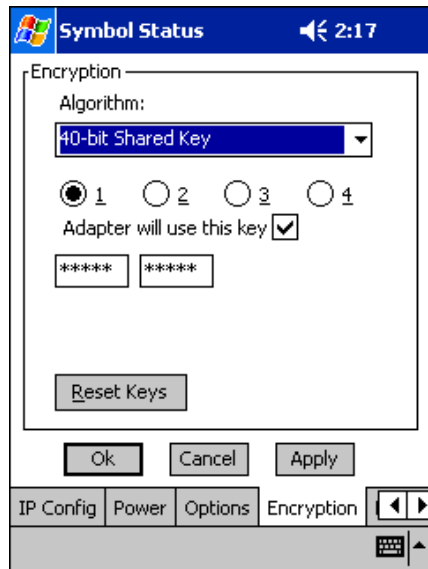

Figure 9-21. PPT 2846 NICTT Properties - Encryption Tab, 40-bit Shared Key Selected

- The *128-bit Shared Key Algorithm* uses a 128-bit encryption key known by both the terminal and the AP to encrypt the data over the network. This option provides a higher level of security than the 40-bit encryption while maintaining an 11 Mbps data rate.

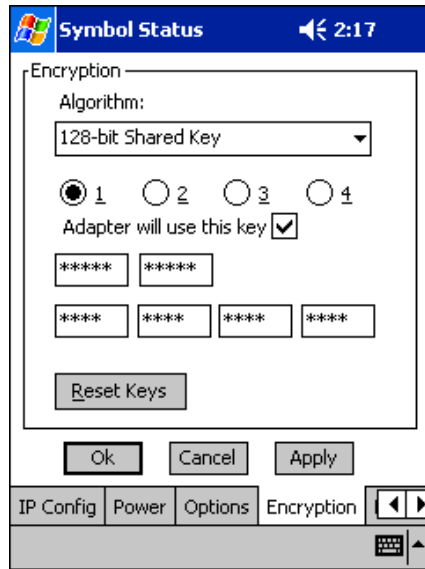
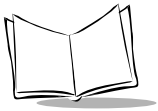

Figure 9-22. PPT 2846 NICTT Properties - Encryption Tab, 128-bit Shared Key Selected



- Select *Kerberos* if your network employs the Kerberos system. Enter the Key Distribution Center (KDC) and Realm values. The KDC is located on a server and maintains information about the access points and users it supports, and also permits the transmission and receipt of data once the credentials of the user are verified. Enter the name of the realm that hosts the Kerberos KDC in the Realm field.

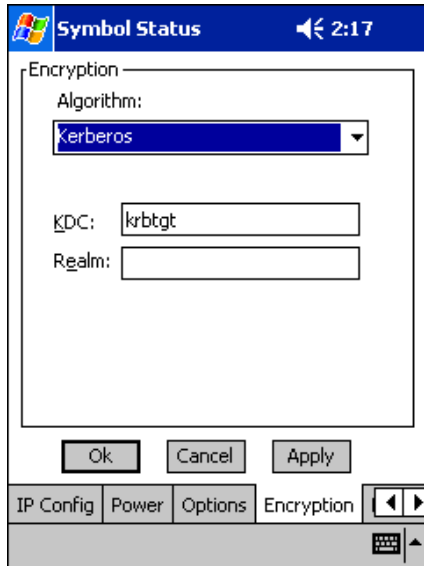

Figure 9-23. PPT 2846 NICTT Properties - Encryption Tab, Kerberos Selected

Ping Tab

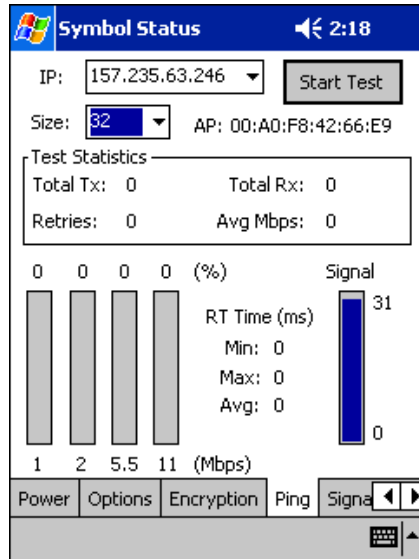
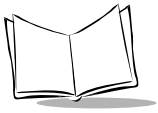

Figure 9-24. PPT 2846 NICTT Properties - Ping Tab

Use the *Ping* tab to send and receive ICMP ping packets across the network to the specified IP address.

- Enter an IP address as a dotted string (e.g., 122.78.3.141).
- Select the size of packets sent from the *Size* drop-down menu.
- Select *Start Test* to begin the continuous ping test. Select *Stop Test* to terminate the ping test.
- The average mega-bits per second, signal strength, data rate currently in use, test statistics and round trip times are displayed for each test.
- The associated access point's MAC address is also displayed.
- The signal strength level and the data transmission rate are displayed in real-time bar graphs.



Signal Tab

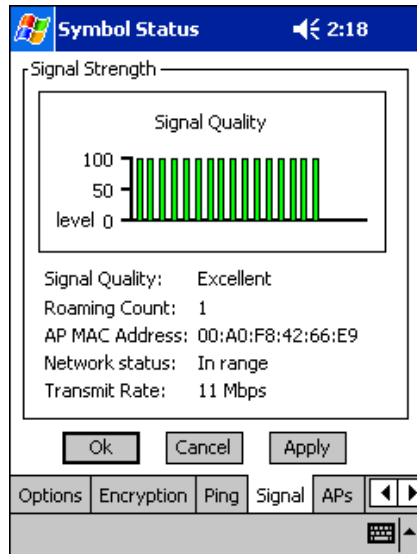

Figure 9-25. PPT 2846 NICTT Properties - Signal Tab

The *Signal* tab is only available in Infrastructure mode (selected on the *Mode* tab).

Use the *Signal* tab to display a real-time graph of the signal quality of the adapter to the associated access point, including the number of times the adapter has roamed to and from APs, the current data rate, and the network status. Signal quality indicates how well the adapter receives the transmitted signal of the associated access point.

APs Tab

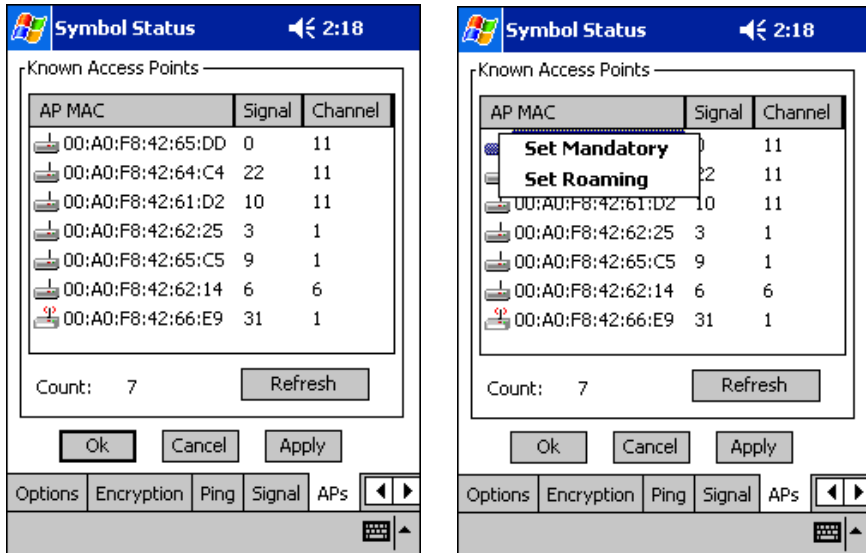

Figure 9-26. PPT 2846 NICTT Properties - APs Tab

The APs tab is only available in Infrastructure mode (selected on the *Mode* tab).

Use the APs tab with the Infrastructure operating mode to view access points with the same ESSID as the adapter. View the AP MAC address, signal level and channel of known access points.

- The currently associated access point's icon includes a radio wave radiating from the antennae to indicate the associate status. Tap on an icon to display a menu:
 - Select *Set Mandatory* to prohibit the adapter from associating with the specified access point. The letter "m" displays on top of the access point's icon when this option is selected.
 - Select *Set Roaming* to allow the adapter to roam to this access point if it has a better signal quality.

These settings are temporary and are not saved to the registry.

- Tap the *Refresh* button to update the list of the known APs.

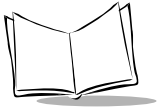

PPT 2800 Series Product Reference Guide for Pocket PC 2002



Chapter 10

Wireless Wide Area Network Configuration

Chapter Contents

Introduction	10-3
Multi-Network Support for IP Data over GPRS	10-3
Creating a GPRS DUN Connection	10-4
Sample Network Parameter Registry File	10-5
Configuring a CDPD WAN Connection (PPT 2833)	10-8
Configuration Wizard	10-8
Maintenance Screens and Menus	10-13
Modem Menu	10-19
Advanced Menu	10-20
Help	10-22
Configuring a GPRS WAN Connection (PPT 2837)	10-23
Connecting via GPRS	10-26
Configuring a GSM WAN Connection (PPT 2837)	10-28
Connecting via GSM	10-32

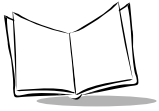

PPT 2800 Series Product Reference Guide for Pocket PC 2002

Introduction

Before a terminal can be used on a CDPD/GSM wireless network, you must select a provider and establish a service plan, and the terminal must be properly configured.

Multi-Network Support for IP Data over GPRS

Before transferring IP data on a GPRS network, you must establish a Packet Data Protocol (PDP) context. The GPRS network parameters consist of the following items:

- Access Point Name (APN)
- PDP Address (if not provided dynamically by the network)
- Header Compression
- Data Compression
- Quality of Service Requested
 - Precedence
 - Delay
 - Peak Throughput
 - Mean Throughput
 - Reliability
- Quality of Service Minimum
 - Precedence
 - Delay
 - Peak Throughput
 - Mean Throughput
 - Reliability

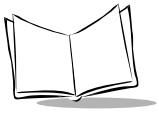

Creating a GPRS Dial Up Networking (DUN) Connection

The software platform includes a virtual GPRS driver designated COM9. In the software architecture, this driver is positioned between an application or operating system service above, and the physical modem port below.

Use the connection manager to create a GPRS DUN connection (see [Configuring a GPRS WAN Connection \(PPT 2837\)](#) on page 10-23 for detailed instructions):

1. Specify the GPRS virtual COM9 port.
2. Enter *99# and the number.
3. If your network does not assign IP or DNS addresses, enter the values.
4. Enter any required login ID and password information.

When connecting, the DUN service calls into the COM9 virtual GPRS driver. The virtual driver powers up and registers the modem on the network, attaches to the GPRS service, and sets up the GPRS PDP context using the network parameters. The GPRS context is activated when the DUN service dials the *99# number.

The GPRS network parameters are different for each service provider, and the APN or DNS address may change from time to time.

Use the registry file, the GUI utility, and the registry-aware virtual GPRS driver to remedy this. [Figure 10-1](#) illustrates the relationship between the registry entries, the registry file, the virtual driver and the GUI utility.

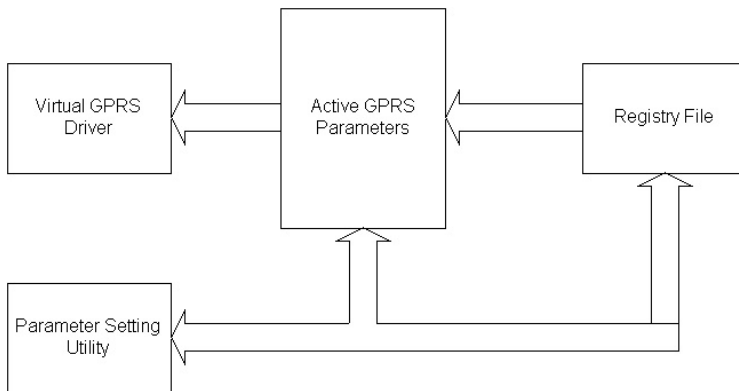

Figure 10-1. GPRS Connection Relationship

- The registry file contains the GPRS parameters for a particular network provider. The entries in this file are read during cold boot and placed with the active registry settings.
- When PDP context is established, the virtual GPRS driver reads the Active registry entries.
- The parameter setting utility allows you to view and modify the GPRS network parameter settings. When modifying the settings you may apply the new settings to the active parameters settings only, or also to the registry file. If you choose to affect the active parameters only, the new parameters are used for all subsequent PDP contexts until a cold boot occurs.

A default registry file is included on the terminal in the platform directory. You may create and install a registry file for your specific network, or edit the existing registry settings using the GIU utility. The GUI utility is included in the GsmDemo.

Sample Network Parameter Registry File

The following sample provides 3 contexts, with one of them the active context.

```

; -----
; GPRS Network Specific Parameters
[HKEY_LOCAL_MACHINE\Drivers\BuiltIn\Seriald3]
"CurrentContext"=dword:1
"Version"="1.0"

[HKEY_LOCAL_MACHINE\Drivers\BuiltIn\Seriald3\Context1]
;
; 1st of 3 selectable Contexts
;
"ContextID"=dword:1
"ContextName"="VoiceStream"
"PDPTType"="IP"
"APN"="internet3.voicestream.com"
"PDPAAddress"=""

"DataCompression"=dword:0
"HDRCompression"=dword:0

"QosMinPrecedence"=dword:0
"QosMinDelay"=dword:0
"QosMinReliability"=dword:3

```

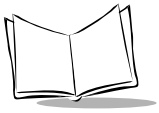

PPT 2800 Series Product Reference Guide for Pocket PC 2002

"QosMinPeak"=dword:0

"QosMinMean"=dword:0

"QosReqPrecedence"=dword:0

"QosReqDelay"=dword:0

"QosReqReliability"=dword:3

"QosReqPeak"=dword:0

"QosReqMean"=dword:0

[HKEY_LOCAL_MACHINE\Drivers\BuiltIn\Seriald3\Context2]

;

; 2nd of 3 selectable Contexts

;

"ContextID"=dword:2

"ContextName"="Telstra"

"PDPTType"="IP"

"APN"="telstra.internet"

"PDPAddress"=""

"DataCompression"=dword:0

"HDRCompression"=dword:0

"QosMinPrecedence"=dword:0

"QosMinReliability"=dword:0

"QosMinDelay"=dword:0

"QosMinPeak"=dword:0

"QosMinMean"=dword:0

"QosReqPrecedence"=dword:0

"QosReqDelay"=dword:0

"QosReqReliability"=dword:0

"QosReqPeak"=dword:0

"QosReqMean"=dword:0

[HKEY_LOCAL_MACHINE\Drivers\BuiltIn\Seriald3\Context3]

;

; Last of 3 selectable Contexts

;

```
"ContextID"=dword:3
"ContextName"="OmniTel"
"PDPTType"="IP"
"APN"="web.omnitel.it"
"PDPAddress"=""

"DataCompression"=dword:0
"HDRCompression"=dword:0

"QosMinPrecedence"=dword:0
"QosMinDelay"=dword:0
"QosMinReliability"=dword:0
"QosMinPeak"=dword:0
"QosMinMean"=dword:0

"QosReqPrecedence"=dword:2
"QosReqDelay"=dword:4
"QosReqReliability"=dword:3
"QosReqPeak"=dword:6
"QosReqMean"=dword:1f
```

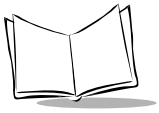

Configuring a CDPD WAN Connection (PPT 2833)

Before the PPT 2833 terminal can be used, you must get an account with an internet service provider.

All CDPD identification and address information is entered through the Preferences application on the PPT 2833 terminal.

To configure your PPT 2833 terminal for use on a CDPD network, tap Configuration Wizard on the Modem menu in Modem Manager.

Configuration Wizard

The first time the Modem Manager software is started, or when Configuration Wizard is selected from the Modem menu within Modem Manager, the Configuration Wizard prompts you through the steps to configure and set up the terminal for operation.

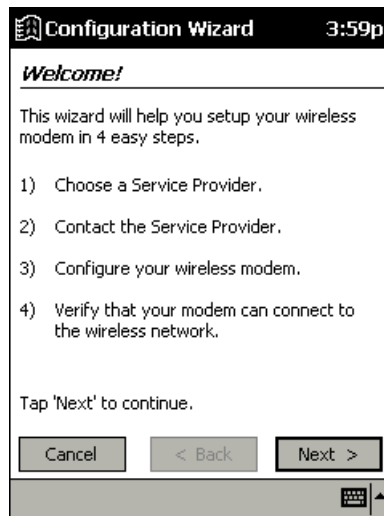

Figure 10-2. Configuration Wizard Welcome Screen

At any time, you can choose to cancel the Configuration Wizard by tapping `Cancel`. If you do choose to cancel, the Configuration Wizard appears the next time the Modem Manager is selected. It is recommended that once you begin the setup process you continue until it is completed.

1. To begin configuration, tap **Next**. The *Choose Service Provider* screen displays.

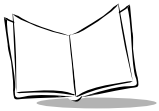

Figure 10-3. Choose Service Provider Screen

2. Select a Wireless Provider from the drop-down menu, and tap **Next**. The *Contact Service Provider* screen displays:



Figure 10-4. Contact Service Provider Screen



This screen tells you to note the modem Equipment ID number shown. Tap **Next** to continue.

3. The *Enter Modem Settings* screen displays:

The screenshot shows a mobile device screen with a black header bar containing a book icon, the text "Configuration Wizard", and the time "4:00p". Below the header, the title "Enter Modem Settings" is displayed in a bold, italicized font. The main content area contains the instruction "Please enter the information given to you by your service provider." followed by four input fields: "IP Address:" with the value "192 . 0 0 . 1", "Primary DNS:" with "0 . 0 0 . 0", "Secondary DNS:" with "0 . 0 0 . 0", and "SPI:" with "0". Below these fields is the instruction "Tap 'Next' once you have entered this information." At the bottom of the screen are three buttons: "Cancel", "< Back", and "Next >". A small keyboard icon and an upward-pointing arrow are visible in the bottom right corner of the screen.

Figure 10-5. Enter Modem Settings Screen

4. Enter the required information and tap **Next** to continue. You are prompted to confirm the settings. Verify the information you entered is accurate and tap **Next**. The *Modem Configured* screen displays.

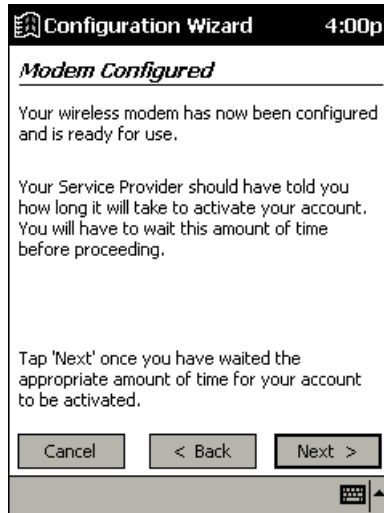

Figure 10-6. Modem Configured Screen

5. After you have waited the appropriate amount of time indicated by your service provider, tap `Next`. The *Checking Network* screen tells you to wait for your modem to register with the network.

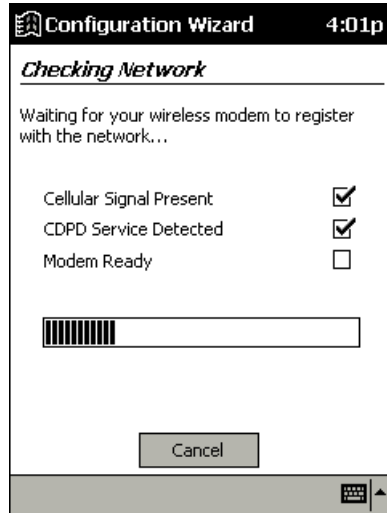
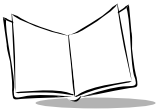

Figure 10-7. Checking Network Screen

6. A screen displays indicating that the modem successfully connected.

Note: *The Configuration Wizard does not proceed until a CDPD carrier selection is made.*

Maintenance Screens and Menus

The PPT 2833 terminal includes menu commands to make it fast and easy to configure and check the status of your modem. This section explains the menu commands specific to the Modem Manager.

Status Screen

The *Status* tab of the Modem Manager displays modem parameters. The modem's status is updated every 3 seconds.

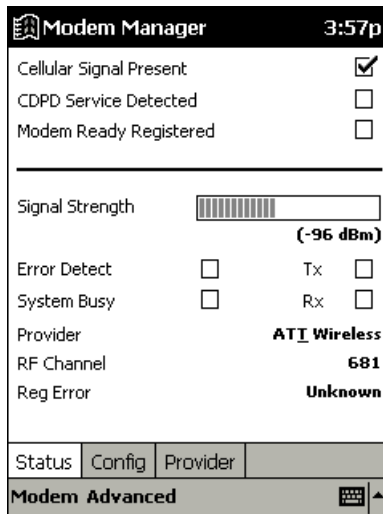
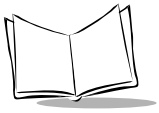

Figure 10-8. Modem Manager Status Screen



The following information is available from this screen:

Setting	Description
Cellular Signal Present	When checked, it indicates that the modem has identified a cellular signal.
CDPD Service Detected	When checked, it indicates that the modem has identified and is synchronized to a CDPD signal in the area.
Modem Ready Registered	When checked, it indicates that the modem has successfully registered with a CDPD service provider in the coverage area. A working data connection exists and can be used by other applications to transmit and receive data. Until this checkbox is selected, the modem can neither transmit nor receive data.
Signal Strength	Measures Received Signal Strength from the wireless base station. These values range from one to ten bars. The greater the number of bars, the better the performance of the modem.
Error Detect	When checked, it indicates that a large number of errors have been detected by the modem. The modem may continue to operate but with a severely reduced performance, caused by the increased likelihood of connection retries and data errors when communicating with the wireless base station.
System Busy	When checked, it indicates that the currently detected CDPD system is busy. The modem may continue to operate but at a decreased level of performance.
Provider	Displays the CDPD channel's System Provider's Identifier.
RF Channel	Shows the CDPD channel currently active. If the terminal is not registered or is searching for a channel, the value displayed is either "Searching A" or "Searching B", depending on the state of the modem. Once a channel is detected, a numeric value for the channel displays.
Reg Error	This shows either "None" or a numeric value between 1 and 7. "None" indicates a successful registration without any errors. If a numeric error code is displayed, an error has occurred. Tap the button to display details about the error.

Configuration Screen

The screenshot shows the Modem Manager configuration screen. At the top, there is a status bar with the text 'Modem Manager' on the left and '3:58p' on the right. Below this, there are several configuration fields:

- IP Address:** A text input field containing '192 . 0 . 0 . 1'.
- Primary DNS:** A text input field containing '0 . 0 . 0 . 0'.
- Secondary DNS:** A text input field containing '0 . 0 . 0 . 0'.
- Side Preference:** A dropdown menu with 'B Preferred' selected.
- Sleep Mode:** A dropdown menu with 'Enabled' selected.
- Auto Power-Off:** A dropdown menu with 'Disabled' selected.

At the bottom of the screen, there is a navigation bar with three tabs: 'Status', 'Config', and 'Provider'. The 'Config' tab is currently selected. Below the navigation bar, there is a section titled 'Modem Advanced' with a keyboard icon and a right-pointing arrow.

Figure 10-9. Modem Manager Configuration Screen

On the *Config* tab, you can edit configuration settings. The following settings are available:

Setting	Description
IP Address	This is the current IP address of the modem. Tap to enter a new IP address.
Primary DNS	This is the current Primary DNS address of the modem. Tap to enter a new DNS address.
Secondary DNS	This is the current Secondary DNS address of the modem. Tap to enter a new DNS address.
Side Preference	Configure the side preferences for the modem. All CDPD systems are categorized into "A" systems or "B" systems. This setting determines how the modem searches for a CDPD system among the two system category choices. See Side Preference Drop-Down on page 10-16.
Sleep Mode	Allows or disallows the modem to enter the low-power mode. This feature only functions on Wireless IP networks that support it. See Sleep Mode Drop-Down on page 10-16 for detailed information.

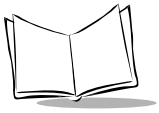

Setting	Description
Auto Power-Off	When enabled, this shuts off the modem when the session is disconnected.

Side Preference Drop-Down

Setting	Description
A only	The modem searches for a CDPD system on the "A" side only. For users who do not roam, this selection can sometimes speed the registration process, as the modem does not have to look on the "B" side as well before it can register.
B only	Same as "A only" except on the "B" side.
A Preferred	The modem searches for a CDPD system on the "A" side first and attempt registration on any system it finds. However, if the modem cannot register on the "A" side, it then attempts to find service on the "B" side. For users who roam, this setting would be appropriate if the home system was on the "A" side.
B Preferred	The modem searches for a CDPD system on the "B" side first and attempt registration on any system it finds. However, if the modem cannot register on the "B" side, it attempts to find service on the "A" side. For users who roam, this setting would be appropriate if the home system was on the "B" side.

Sleep Mode Drop-Down

Setting	Description
Enabled	The modem attempts to enter a low-power mode if it is not required to carry out any communications with a Network. The modem may respond sluggishly to the first communication request when it is required again.
Disabled	The modem is not allowed to enter sleep mode.

Provider Screen

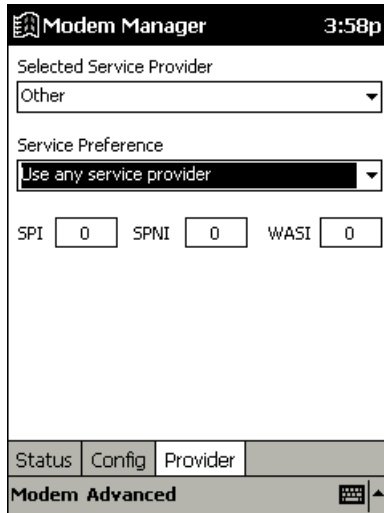
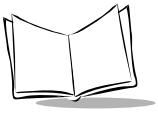

Figure 10-10. Modem Manager Provider Screen

On the *Provider* tab, you can modify provider settings. The following settings are available.

Setting	Description
Selected Service Provider	Selects the CDPD channel's System Provider's Identifier.
Service Preference	Configures the preferences for the service ID parameters. Refer to Service ID Preferences on page 10-18 for detailed information.
Service ID Parameters	Configures all identification values for a particular system or Wireless IP network: SPI is the current CDPD Base Station Service Provider Identifier. SPNI is the current CDPD Base Station Service Provider Network Identifier. WASI is the current CDPD Base Station Wide Area Service Identifier.



Service ID Preferences

Setting	Description
Only use selected service provider	The modem attempts to detect <i>only</i> the system in the Service ID parameters for registration. This is useful when you want to prevent roaming to any other system but your home system.
Prefer to use selected service provider	The modem first attempts to register on the system described by the SPI/WASI/SPNI entries. If no system is found, the modem attempts to register on the remaining available systems in the area. This is useful when you spend most time in one area and occasionally roam, or in cases where you have two systems but prefer service on one due to, for example, rate advantages. In these cases, enter the Network ID parameters that reflect the system you most often will register on.
Don't use selected service provider	The modem attempts to register on any system but that reflected in the Network ID entries. This is useful if you want to block registration on systems in your area that you do not have an agreement with. This may speed up the registration process in some areas.
Use any service provider	The SPI/WASI/SPNI entries are ignored. This is the default configuration and ensures that the modem attempts to register on any valid system that it can find.

Modem Menu

Tap *Modem* to display the *Modem Menu*. Options are described below.

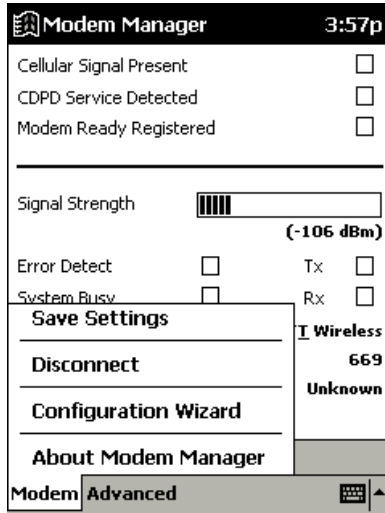
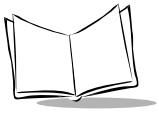

Figure 10-11. Modem Menu

Setting	Description
Save Settings	Saves any settings made in the Modem Manager Configuration and Provider screens.
Disconnect	Terminates the active Network session with the modem. If you have configured the AutoOff preference to turn the modem off when the session is disconnected, the modem may also power down. If disconnected, the Modem Manager can no longer perform 3-second updates.
Configuration Wizard	Launches the Configuration Wizard to configure your modem.



Advanced Menu

Tap *Advanced* to display the *Advanced Menu*. Options are described below

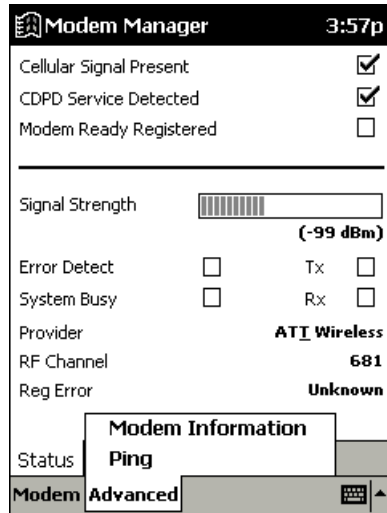

Figure 10-12. Advanced Menu

Modem Information

Tap *Modem Information* to view the modem manufacturer, equipment ID and model, and firmware version.

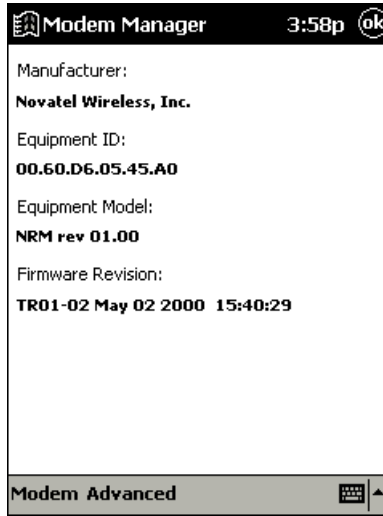
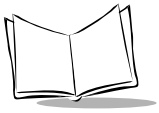

Figure 10-13. Modem Information Screen



Ping Screen

Tap *Ping* to send a packet to a particular IP address to determine if it is online. From this screen you can send a PING request to another network device whose network address you already know. This is useful to verify network connectivity.

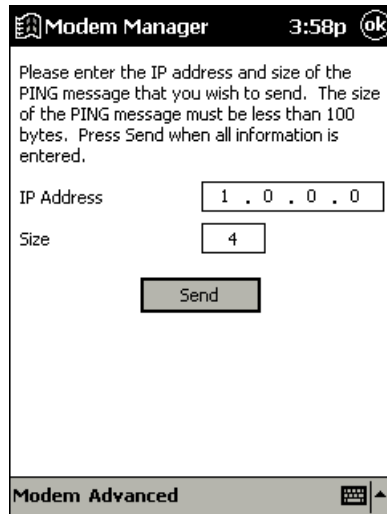

Figure 10-14. Ping Screen

As with other PING applications, enter the IP address of the other network device in the IP field, then select the desired payload size. Tapping *Send* sends the PING. A status line displays a "Success" or "Fail" message to indicate whether or not the PING was successful. There is a 20 second timeout for a response before a "Success" or "Fail" message may display.

There are some limitations on this PING implementation:

- The size of PING payload is limited to 99 bytes. If a payload of greater than that is entered, a data error message will be displayed.
- The delay to wait for response is fixed at 20 seconds.

Tap *OK* to return to the Modem Manager screen.

Help

Select *Help* from the *Start* menu for more information on Modem Manager.

Configuring a GPRS WAN Connection (PPT 2837)

To set up a new connection configuration:

1. Tap *Settings* from the *Start* menu.
2. Tap the *Connections* tab, and select *Connections*.
3. On the *Connections* screen, tap the *Modify* button under the *Internet Settings* drop-down.

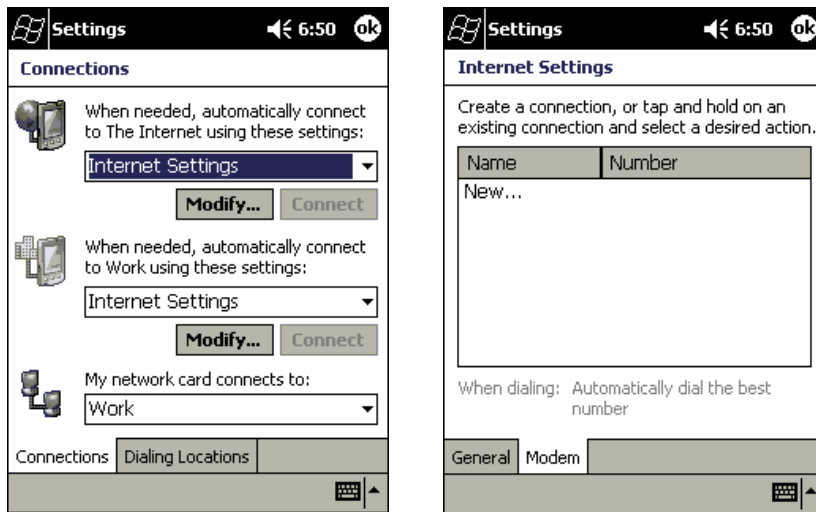

Figure 10-15. Connections & Internet Settings Screens

4. On the *Internet Settings* screen, tap *New . . .*. The *Make New Connection* screen displays.

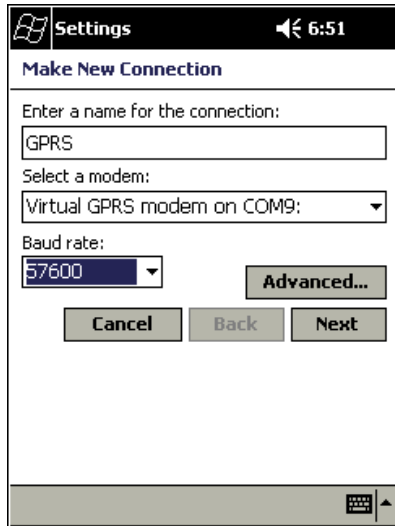
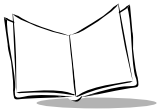

Figure 10-16. Make New Connection Screen

5. Enter GPRS as the name for your connection, then select *Virtual GPRS modem on COM9* from the drop-down menu. Set the Baud Rate to 57600.
6. Tap Next.

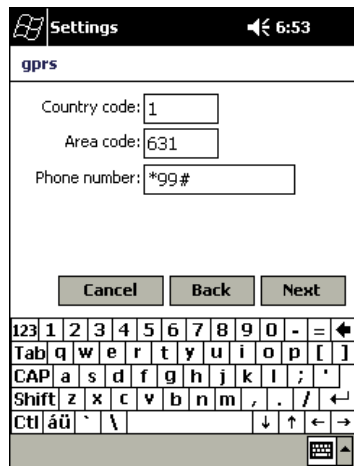

Figure 10-17. Entering Phone Number

7. Enter your area code and set the phone number to *99#. The area code must match the area code in the dialing locations screen. Tap **Next**.



Figure 10-18. Dialing Settings

8. Uncheck **Wait for dial tone before dialing**, and tap **Finish**. Your new connection is created.

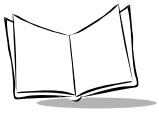

Connecting via GPRS

To connect using the GPRS WAN connection you created:

1. Select *Settings* from the *Start* menu.
2. Tap the *Connections* icon on the *Connections* tab.
3. Tap the *Dialing Locations* tab.

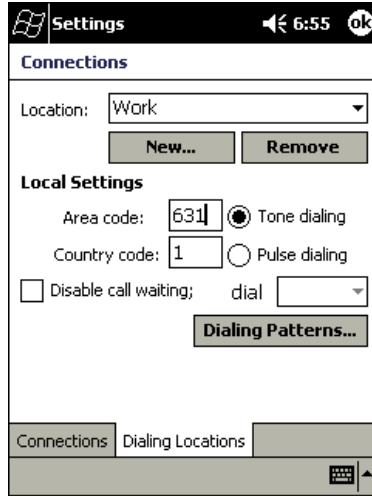

Figure 10-19. Dialing Locations Tab

4. Set the area code to match the area code entered earlier. Tap **Dialing Patterns**.

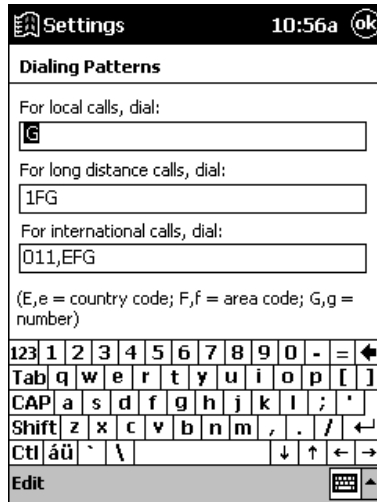
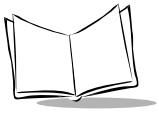

Figure 10-20. Dialing Patterns Screen

5. On the Dialing Patterns screen, edit the patterns as shown above, deleting the “9,” from each location.
6. Tap **OK** until you return to the *Connections* screen, and select the *Connections* tab. Tap *Connect*.
7. On the username/password screen that appears, just tap **OK**. There is no username or password for a GPRS connection. The terminal attempts connection.

Note: For the GPRS connection to work, first set up the network-specific PDP Context and Quality of Service parameters using the GSM Demo. See [Appendix C, GSM Demo Program](#). You can obtain the network-specific parameter values from your network provider.



Configuring a GSM WAN Connection (PPT 2837)

To set up a new connection configuration:

1. Tap *Settings* from the *Start* menu.
2. Tap the *Connections* tab, and select *Connections*.
3. On the *Connections* screen, tap the *Modify* button under the *Internet Settings* drop-down.

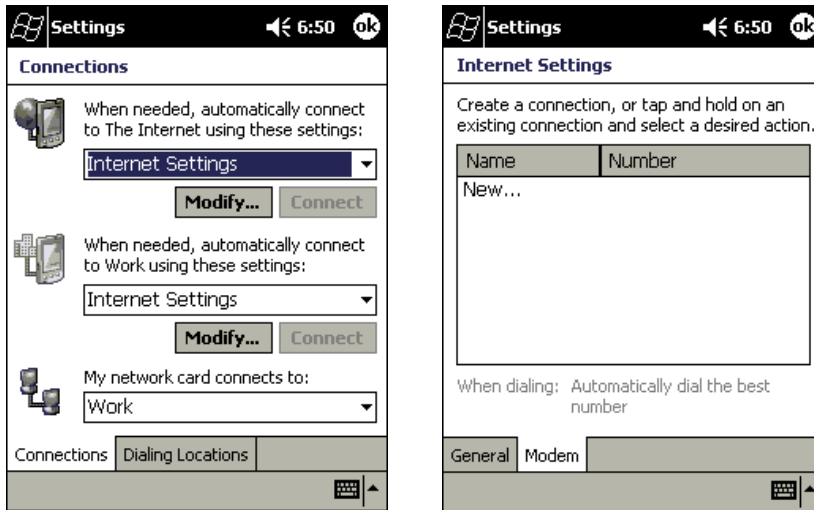

Figure 10-21. *Connections & Internet Settings Screens*

- On the *Internet Settings* screen, tap *New . . .*. The *Make New Connection* screen displays.

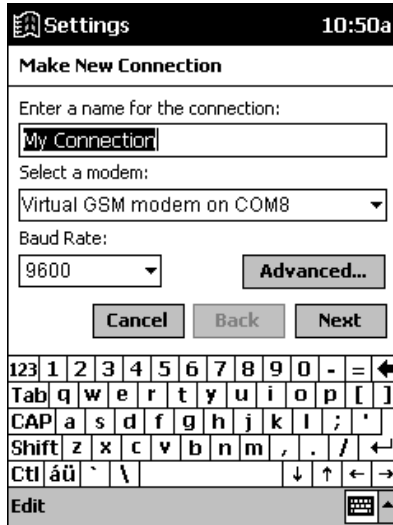
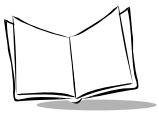

Figure 10-22. Make New Connection Screen

- Enter a name for your connection, then select *Virtual GSM modem on COM8* from the drop-down menu. Set the Baud Rate to *9600*.



- Your modem settings and TCP/IP address should be set automatically, but if you need to set them manually, tap the **Advanced** button and enter the information in the **Port Settings**, **TCP/IP**, and **Name Servers** tabs.

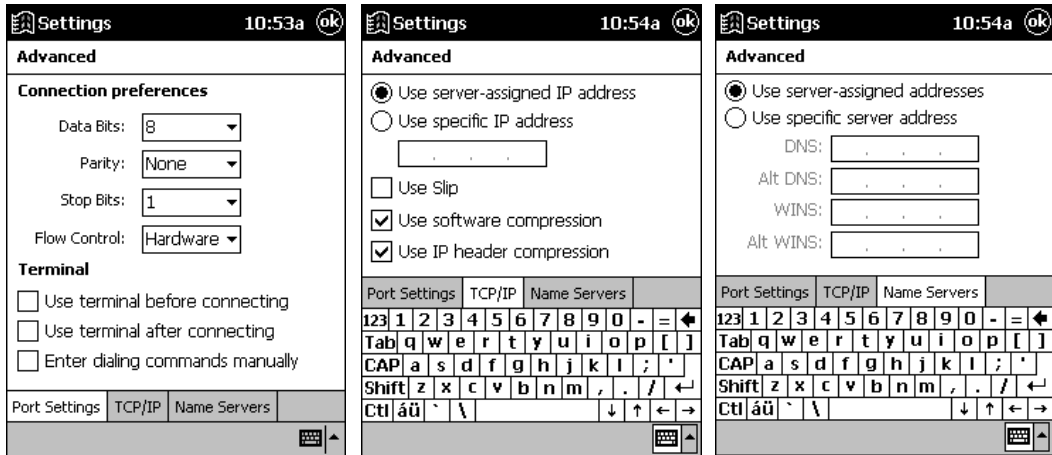

Figure 10-23. Advanced Settings

- When you have completed entering your settings, tap **OK**, then select **Next** from the **Make New Connection** screen.

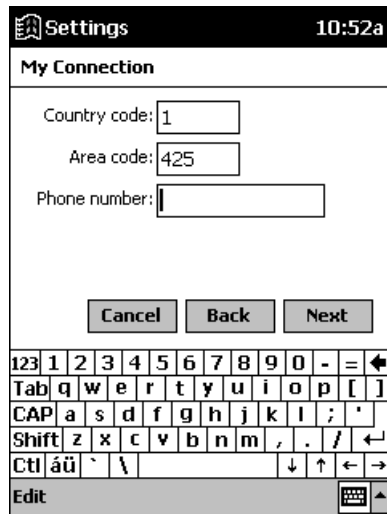

Figure 10-24. Entering Phone Number

8. Enter a phone number that connects to a Remote Access Server (RAS) to browse the Internet. The area code should be that of the RAS server modem. Tap **Next**.

Connections 6:28a

My Connection

Cancel call if not connected within
 seconds

Wait for dial tone before dialing

Wait for credit card tone seconds

Extra dial-string modem commands:

Cancel **Back** **Finish**

123	1	2	3	4	5	6	7	8	9	0	- =	↵
Tab	q	w	e	r	t	y	u	i	o	p	[]	
CAP	a	s	d	f	g	h	j	k	l	;	'	
Shift	z	x	c	v	b	n	m	,	.	/	↵	
Ctl	â	ü	` \					↓	↑	←	→	
Edit	✕											⌨

Figure 10-25. Connection Settings

9. Uncheck **wait for dial tone before dialing**, and tap **Finish**. Your new connection is created.

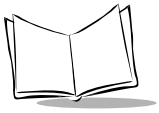

Connecting via GSM

To connect using the GSM WAN connection you created:

1. Select *Settings* from the *Start* menu.
2. Tap the *Connections* icon on the *Connections* tab.
3. Tap the *Dialing Locations* tab, then tap *Dialing Patterns*.

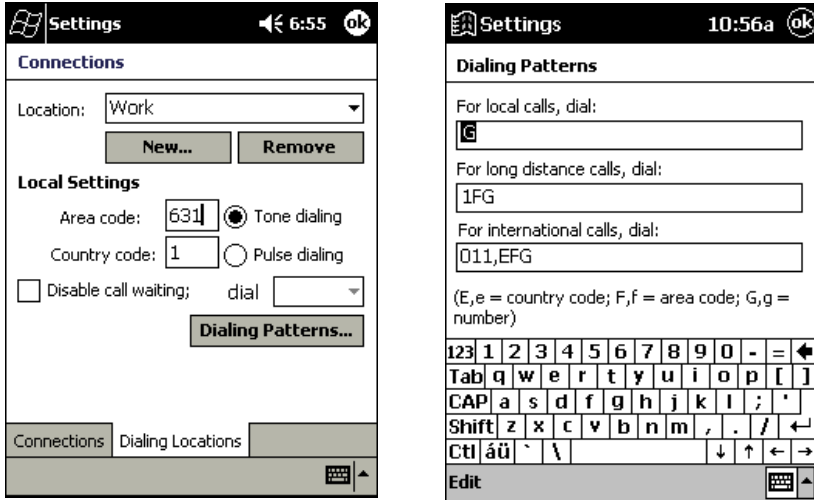
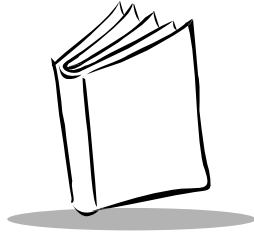

Figure 10-26. Dialing Screens

4. On the *Dialing Patterns* screen, edit the patterns as shown above, deleting the “9,” from each location.
5. Tap **OK** until you return to the *Connections* screen, and select the *Connections* tab. Tap *Connect*.
6. Enter a valid username and password on the screen that appears. The terminal attempts connection.



Chapter 11

Software Installation on Development PC

Chapter Contents

Introduction	11-3
Before You Install the SDK	11-3
Symbol Windows CE SDK	11-3
Installing the SDK on the Development PC	11-4
Installing the SDK	11-4
Installing Other Development Software	11-4

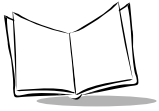

PPT 2800 Series Product Reference Guide for Pocket PC 2002

Introduction

To develop applications to run on the PPT 2800, the *Symbol Windows CE Software Developer's Kit (SDK)* is available. This SDK contains PPT 2800-specific software not available in the standard Microsoft Windows CE Platform SDK.

The minimum system configuration required to install the SDK is:

- IBM-compatible PC with Pentium 150 MHz processor or higher
- Windows®98 second edition, or Windows® NT operating system version 4.0 with Service Pack 5 or later, or Microsoft Windows 2000 operating system
- 24MB RAM for Windows 98, 32 MB RAM for Windows NT
- 100MB available hard disk space
- CD-ROM drive
- One available serial port
- Mouse.

Also, be sure the drive you are installing to accepts long filenames (larger than the 8.3 filename convention).

Before You Install the SDK

Before you install the Symbol Windows CE SDK, install the following tools:

- Microsoft eMbedded Visual Tools 3.0
- Windows CE Platform SDK for Pocket PC
- Microsoft ActiveSync version 3.5.

Symbol Windows CE SDK

The SDK installation program loads the required Windows CE components on the development PC used to create the image files (via Terminal Configuration Manager) for download to the terminal.

The Symbol SDK includes:

- Symbol-provided files
- Printer drivers
- TCM scripts
- Sample code

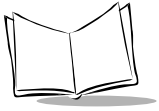

- This Product Reference Guide.

Installing the SDK on the Development PC

The Symbol SDK installs through Windows in the directory C:\SYMBOL WINDOWS CE SDK, and also installs files in the Windows CE Tools directory (generated by the CE Tool Kit).

Installing the SDK

Install the SDK from the Symbol website www.symbol.com. Follow the installation prompts.

Once installation of the SDK is complete, use eMbedded Visual C++ or eMbedded Visual Basic to view the active Windows CE configuration, Microsoft Pocket PC, and display the directory in which the SDK is installed.

Installing Other Development Software

Developing applications for the PPT 2800 may require installing other development software such as application development environments on the development PC. Follow the installation instructions provided with this software.

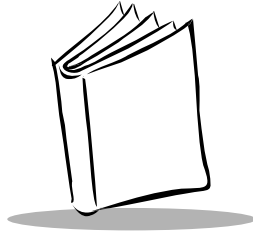

Chapter 12

Configuring the Terminal

Chapter Contents

Introduction	12-3
Starting Terminal Configuration Manager	12-3
Defining Script Properties	12-6
Creating the Script for the Hex Image	12-8
Open a New or Existing Script	12-8
Copy Components to the Script	12-9
Save the Script	12-9
Building the Image	12-10
Sending the Hex Image	12-12
Saving the Script	12-12
Connect The Terminal and Development PC	12-12
Begin the Send in TCM	12-12
Setting Up IPL to Receive the File	12-13
Error Messages	12-18
IPL Error Detection	12-18
TCM Error Messages	12-19
Creating a Splash Screen	12-20
Creating a Splash Screen on Color Terminals	12-20
Creating a Splash Screen on Monochrome Terminals	12-20
Loading the Splash Screen via TCM	12-21

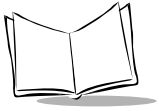

PPT 2800 Series Product Reference Guide for Pocket PC 2002

Introduction

This chapter describes the Terminal Configuration Manager (TCM), and how it is used to specify and load files into the flash memory of the PPT 2800 using the terminal's Initial Program Loader (IPL).

In TCM, you create a *script* that contains the information (commands to copy files) for building the image. TCM works with directory windows which display the directory structure of your script and the source directories, files, and scripts from which you pull components. You can open multiple scripts, drag and drop items from a drive/directory to the script, rename and delete files in the script, etc. Upon building the image, TCM adds all the files, directories, and scripts referenced in the script to the image.

The SDK includes a number of standard scripts and demos/samples for you to use as a base for creating your own scripts. These scripts can be found in the SYMSDK\SCRIPTS directory.

Note: *Before you create a script to build a hex image, identify the files required (system files, drivers, applications, etc.) and locate the files' source directories to make the script building process easier.*

The required processes for building a hex image in TCM include:

- Starting TCM
- Creating or modifying a script
- Building the hex image
- Sending the hex image.

Starting Terminal Configuration Manager

To start TCM, double click on the TCM icon in the SYMSDK group. The following screen appears, displaying two directory windows; Script1 and File Explorer. Each directory

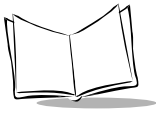

window is split; the left half (or *pane*) of the window displays the directory tree for the current drive, and the right half displays the directory contents for the current drive.

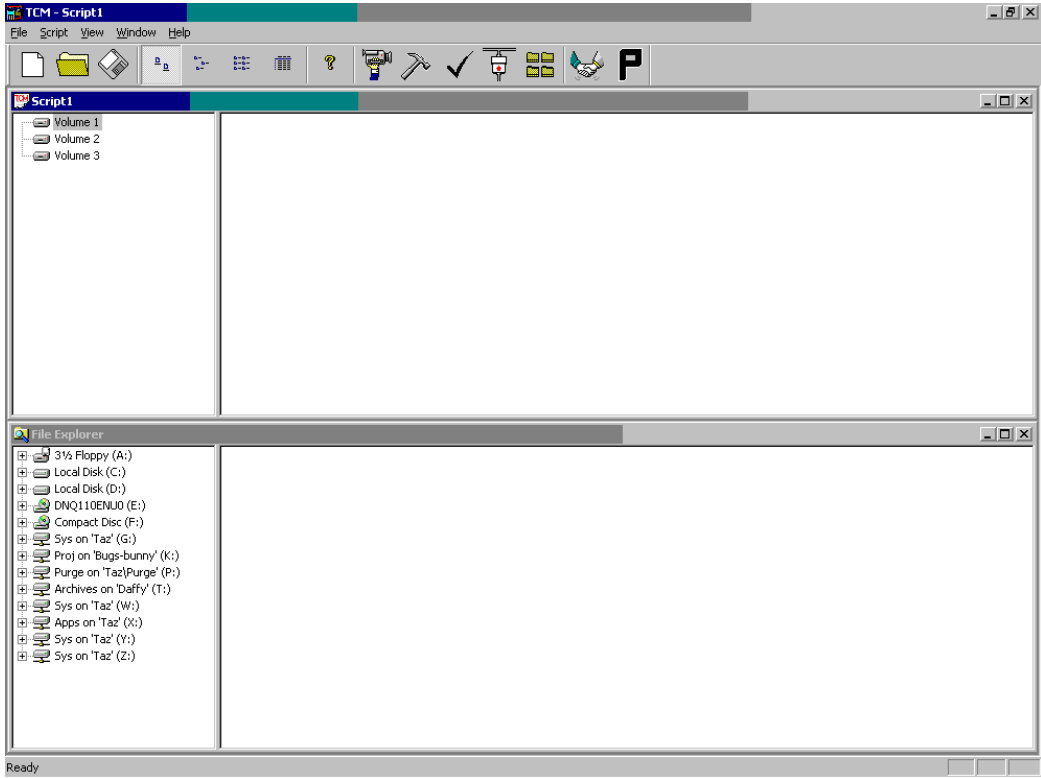















The following table lists the components of the TCM start-up screen.

Table 12-1. TCM Screen Components

Component	Description
Script Window	<p>Associated with a script file containing the information to create a Flash Disk image. This window is the <i>target</i> window, or the primary TCM window in which you can create a script or change a script file's contents by copying, deleting, and renaming files and directories. More than one script window can be open at a time.</p> <p>The Script Window consists of two panes, the Directory Tree Pane on the left and the Directory Contents Pane on the right. Subordinate directories and files of each volume are listed in the Directory Contents Pane.</p>

Table 12-1. TCM Screen Components (continued)

Component	Description			
File Explorer	A <i>read-only source</i> window for files and/or directories to include in the script being built.			
Tool Bar	Contains the tools, illustrated below, for taking action on a script.			
		Create a new script file.		Check script for existing files.
		Open a script file.		Select the hex image to load.
		Save a script file.		Tile windows.
		View script properties.		Build and send the hex image to the terminal.
		Build a script.		Preferences.
		View large icons.		About TCM.
		View small icons.		View list.

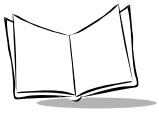

Defining Script Properties

Before a script is created, the script properties must be defined. This defines the type of terminal, flash type, number of disks being created, and the memory configuration of each disk volume.

To define the script properties:

1. With TCM open, click on the Script Window to make it the active window.
2. Under the *Script* menu, select the *Properties* option.

OR

Click on  from the tool bar. The *Script Properties* window displays.

Terminal	Flash Type	Disks	Script File Path	Cushion
2800CPPC	2818C	2	D:\Symbol\Windows CE SDK (PPT 2800 2002)\	15

Partition Table Properties			
	Volume Label	Size	Access
Disk 1:	Platform	2048	Read/Write
Disk 2:	Application	10240	Read/Write

3. Under the *Terminal* drop-down menu, select 2800CPPC.
4. In the *Flash Type* field, select 2818C Flash Type.
5. Under the *Disks* drop-down menu, select the number of disk volumes to be created.

Note: *The options available under the disks drop-down menu changes depending on the flash type. Some flash types only have one option for the number of disk volumes, others have two options.*

6. If you have selected three volumes under the *Disk* drop-down menu, you have the option to change the memory configuration of the second and third volumes. To do so, click on the up or down arrow for either of the volumes, until the memory configuration of each is set to the desired value. You will notice that as you change the values for one of the volumes, the other volume is automatically changed accordingly.
7. For each disk volume, determine the Read/Write access option.
8. The Script File Path displays the path of the selected script file.
9. Select a Cushion percentage from the *Cushion* drop-down menu to specify the percent of flash reserved for cushion. Choosing a higher number reduces disk storage space, but also increases write performance on fragmented disks or disks becoming full. To speed the writing process, select as high a number as your storage needs permit (up to 25%).

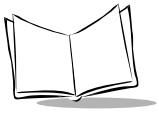

Creating the Script for the Hex Image

On start-up, TCM displays the screen shown on page 12-3, with the Script1 window and File Explorer window pointing to the following directory:

Symbol Windows CE SDK(\\xxx)\SymbolPlatforms\IPTxxx\TCMScripts

The Script1 Window directory pane displays three volumes: Volume1, Volume2, and Volume3. Depending on the type of flash chip you have, the number of volumes may change. Files can be added to each of the volumes. With TCM, you can:

- Create a new script file or open an existing script
- Drag and drop existing files and directories to that script
- Set the script parameters
- Save the script
- Review and modify the script.

Each process is described in the sections that follow.

Open a New or Existing Script

Scripts are created in the Script Window. To open a new script:

- Choose *New* from the *File* menu, OR
- Click on  from the tool bar.

To open an existing script (e.g., a standard script provided in the SDK):

- Choose *Open* from the *File* menu and select the script file name, OR
- Click on  from the toolbar and select the script file name, OR
- Double click on an existing script in the Script Browser window.

Note: *If you open and make changes to an existing script, saving the changes writes over the existing script. If you wish to use an original or Symbol-supplied standard script as a base and save the changes in a new script, use Save As instead of Save after making the changes, and save to a different filename.*

Copy Components to the Script

Copy *files or directories* to the script being generated:

1. Click on the File Explorer Window to make it the active window.
2. Click on the source directory in the Directory Tree Pane. TCM displays the directory contents in the Contents Pane.
3. Click on the file(s) and/or directory in File Explorer.

Note: *Optionally, use the standard Windows Shift+Left-click and Control+Left-click features to select multiple files and directories.*

4. Drag and drop the selected file(s) and/or directory from File Explorer to the target directory in the Script Window,
OR

Click on the target directory and select the File Explorer Copy icon from the toolbar.

Save the Script

To save the changes to a new script:

1. From the *File* menu, choose *Save As*,
OR

On the toolbar, click on  .

2. Enter the path and filename. TCM appends a .TCM extension to the script.
3. Choose the OK button.

Note: *If you save an untitled script, TCM by default saves the script to the directory that the Script Browser is pointing to.*

To save changes to an existing script:

- From the *File* menu, choose *Save*, OR

- On the toolbar, click  .

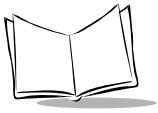

Note: *If you open and make changes to an existing script, saving the changes writes over the existing script.*

If you wish to use an original or Symbol-supplied standard script as a base and save the changes in a new script, use Save As instead of Save after making the changes, and save to a different filename.

Building the Image

As part of the build, TCM performs a check on the script which verifies that all files referenced in the script exist. If the image is bootable, TCM verifies that the boot files are available.

Note: *Performing a check is more important for previously existing scripts to ensure that files referenced in the script are still in the designated locations.*

To check a script:

1. In the Script Window, select the script.
2. Save the script, if not already saved.
3. From the *Script* menu, choose *Check*,
OR

On the toolbar, choose  .

4. TCM verifies that files referenced in the script exist on available drives and lists an error message in the Errors found box for any missing files.
5. Choose the OK button to exit.

To build a script:

1. In the Script Window, select the script to be built.
2. From the *Script* menu, select *Build*,
OR

On the toolbar, choose  . The Configure Build window appears.

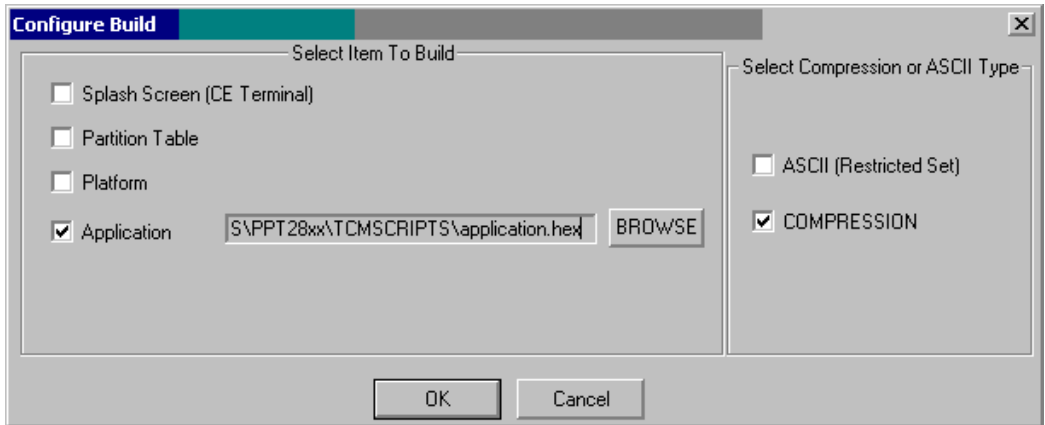

3. Select the item to build. If you select to build an application, specify the application.
4. Select ASCII format for your hex image, or Compression, which reduces the size of most hex images in order to speed downloading. Click **OK**.
5. TCM performs a check. If the script is has no errors, TCM proceeds with the build.

If the Build Fails

If the build fails, TCM displays a message indicating which file(s) are missing.

If the total amount of flash required by the script exceeds the image size, a TCM error results. To correct this, reduce the number of files in the volume, or make the disk non-bootable. Refer to [Defining Script Properties](#) on page 12-6 for more information on setting the image size appropriately.

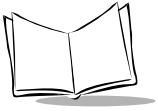

Sending the Hex Image

Once the hex file is built, you are ready to download it to the terminal. A Hex image download requires both TCM and a program loader stored on the terminal. The terminal comes with a program loading utility, Initial Program Loader (IPL), stored in the terminal's write-protected flash. To run IPL, the terminal must be inserted in a cradle or connected to a development PC by direct serial connection.

Saving the Script

If you made changes to the script since last saving it, save the script again.

Connect The Terminal and Development PC

To send the hex file to the terminal, first link the terminal and development PC by one of the following devices:

- Direct serial link
- Cradle (refer to [Chapter 1, Getting Started](#) for more information on setting up the cradle).

Begin the Send in TCM

In TCM on the PC:

1. Select the script.
2. From the *File* menu, choose *Load Terminal*,
OR

On the toolbar, choose . The *Load Terminal* screen displays.

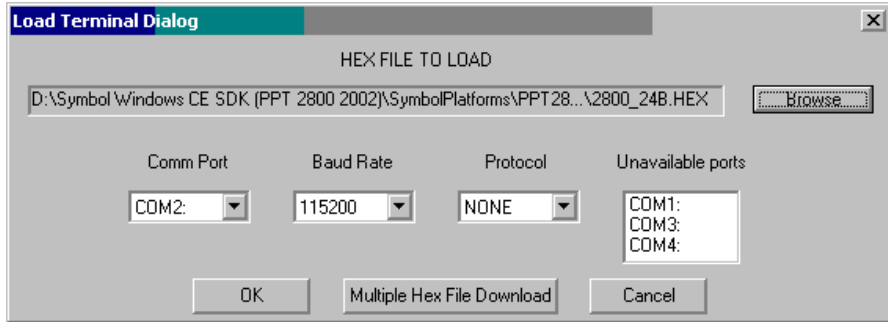

3. If the correct hex file is not displayed in the *Hex File to Load* field, click on the *Browse* button and navigate to the correct hex file to be downloaded.
4. Click on the *Comm Port* drop-down menu and select the COM port being used. Ports already in use display in the *Unavailable Ports* field.
5. Click on the *Baud Rate* drop-down menu and select the appropriate baud rate. Your options are 2400, 4800, 9600, 19200, 38400, 57600, 115200.
6. On the *Protocol* drop-down menu, select *None*.
7. Click *OK* to load the file, or *Multiple Hex File Download* if more than one file is being loaded.

Setting Up IPL to Receive the File

To set up IPL on the terminal to receive the files being downloaded via TCM:

1. Cold boot the terminal by pressing the reset button inside the battery compartment while holding down the Function button.
2. Press and hold the App1 and App4 buttons. While holding down these buttons, press and hold the battery door switch inside the battery compartment (on the left). This all must occur within 3 seconds after resetting the terminal.

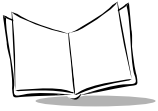

3. Continue to hold these buttons, including the battery door switch, until the *IPL Baud Rate* menu displays:

```
IPL VER X.XX
IPL Key Sequence

-> 115,200
   57,600
   38,400
   19,200
   9600
   Auto Baud

Press Up/Down to
select Baud Rate

Action to Continue
```

If necessary, adjust the contrast by holding down the Function button and pressing the up scroll button to darken the screen, or the down scroll button to lighten the screen.

4. The version number on the top of the screen identifies the version of IPL you are using. After the version number one of the following messages appears, indicating why IPL was invoked:
 - IPL Key Sequence: IPL key sequence was pressed.
 - Partition Table not found: indicates no partition table was found.
 - Partition Table Checksum Error: indicates a checksum error was detected in the partition table.

Use the up and down scroll buttons on the terminal to scroll to the appropriate baud rate, then press the Action button to accept the selected baud rate. If no selection is made within 10 seconds, the baud rate 115,200 is automatically selected.

5. IPL displays the Main Menu which lists the partitions/applications that can be downloaded.

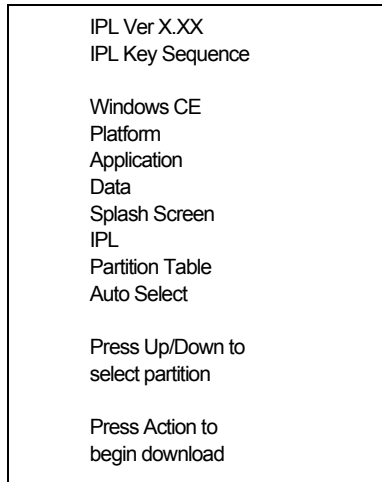

6. Use the up and down scroll buttons to select the partition to be received, then press the Action button, or select Auto Select to download several partitions in sequence.

Note: *Auto Select is the default, and will be selected if no other selection is made within 10 seconds.*

If updating the IPL hex image or partition table hex image, you MUST reboot the terminal into IPL after downloading the image before other images can be downloaded.

If the platform application or data partition sizes are changed, you must download a new partition table first.

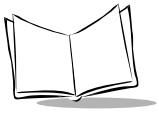

7. The following screen displays:

```
IPL VER X.XX

Partition Name

Waiting for Data
at Baud Rate XXX,XXX

Press Action to
return to Main Menu
```

Partition Name reflects the selection made on the Main Menu, and “Baud Rate XXX,XXX” displays the selection chosen from the baud rate menu.

This screen continues to display until the first character of the image to be downloaded is received from the host. While this screen is displayed, pressing the Action button returns IPL to the Main Menu screen.

8. Insert the terminal in a cradle, or connect it to a host PC with a serial cable.
9. Return to the host PC, and select the OK button on the *Load Terminal* dialog box.
10. As soon as the first character of data is received, IPL displays the receiving screen:

```
IPL VER X.XX

Partition Name
Downloading Data

Processing XXXXX KB
of YYYYYY KB image
```

Note: *If the Pre-erase Attribute bit is set on the partition being downloaded, the message “Pre-Erasing Flash” also appears.*

This screen indicates that the area selected in the Main Menu screen is currently downloading, and displays until an entire image is received, or until an error is detected. As more data is received, the Receiving Screen is updated to reflect the current status.

To process the data, IPL must receive, erase, and write the entire image. With the exception of the disk images, IPL receives the entire image before starting the

erase, and completes the erase before starting to write. With disk images, IPL multiplexes all three operations as data is received.

11. When the entire image is received, IPL indicates that the download is complete.

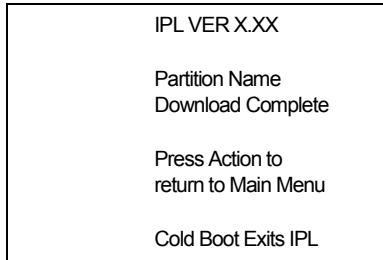

If Auto Select was selected on the Main Menu, the text “Auto Select Enabled” appears in place of “Cold Boot Exits IPL.”

12. If Auto Select was selected on the Main Menu, IPL immediately returns to the Waiting for Data Screen to wait for the next image. If any other selection was made on the Main Menu, IPL stays at the success screen until you press Action. Once the screen is acknowledged, IPL returns to the Main Menu to wait for a new selection.
13. When all partitions are downloaded successfully, cold boot the terminal by pressing the reset button inside the battery compartment while holding down the Function button.
14. Close TCM on the host PC by selecting *Exit* from the *File* menu.

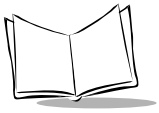

Error Messages

IPL Error Detection

While receiving data, IPL performs many checks on the data to ensure that the data is received correctly. If an error is detected, IPL immediately aborts the download, and reports the error on an error screen:

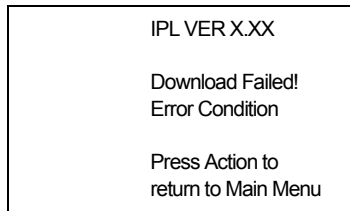

This screen displays until you press Action. Once the screen is acknowledged, IPL returns to the Main Menu screen to wait for a new selection.

The cause of the error displays under the Download Failed! indication. The errors that can be reported, and the probable cause of the error, are as follows:

Error	Description
Invalid Image	This error occurs if another record is received before the Header Record. Ensure the Header Record is the first record downloaded.
Partition Not Defined	The destination code is part of the Header record and is used as an index into the partition table. The partition table entry located at this index contains partition information for the data downloaded. If the AutoSelect option is selected, a check is made to ensure that valid partition information exists in the partition table at this index. The check verifies that the Area Name and Sector Size are both non-zero. If not, this error occurs.
Wrong Partition	If a specific partition is selected from the partition list, and the destination code of the Header record downloaded does not match the index of that partition, this error occurs.
Image Too Big	The size of the image is also part of the Header record. If the data to be written exceeds the size of the partition as indicated in the partition table, this error occurs.

Error	Description
Incorrect Byte Count	Image data is processed until the End Of File (EOF - Record Type 01) record is received. This error occurs if IPL detects that the number of bytes received does not equal the number of bytes sent.
Unable to Verify Partition Data	If the Receive and Verify bit is set for that partition, the data is verified, the flash sector erased, and the data written to the flash part. If this data can not be verified, this error occurs.
Transmission Errors	<p>The following error messages may appear if an error occurs during transmission:</p> <p>Checksum Error occurs if an invalid checksum is detected in the record.</p> <p>Invalid Record occurs if a record is not defined in the Symbol Hex File Format.</p> <p>Connection Lost occurs if one of the handshaking lines is de-asserted during download.</p> <p>Address Out of Sequence occurs if the address of the data received is not sequential.</p>

TCM Error Messages

TCM validates the cells in your partition table when you select the `Execute` button. Cells highlighted in red contain an error. Partition loading is disabled until all errors are corrected. Following are errors that TCM may encounter, and possible solutions.

Error	Description
Error - Partition Size	The size of a partition must be an integral multiple of the <code>FFSSectorSizeInBytes</code> specified by the <code>.ini</code> file. When the user enters a partition size, TCM rounds up to the next highest integral multiple of the sector size and displays this value in the partition table grid. This error check is made upon value entry, independent of the <code>Execute</code> button.
Error - Image Larger than Partition	If the required size of the binary image file is larger than the associated partition size, the Partition Size cell in the partition grid turns red to highlight the error. The Required Size cell indicates the actual size required.
Error - Total size of all FFS Partition	If the total memory allocated to the 3 FFS partitions is greater than the total Flash Memory on the terminal, the Used FFS Memory display box turns red. Decrease the size of one or more of the partitions, then recheck the configuration using the <code>Execute</code> button.

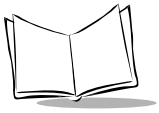

Error	Description
Error - Source/ Destination Path Verification	If the directory paths specified by the Source and Destination cells do not exist, the cell containing the non-existent path turns red to highlight the error.

Creating a Splash Screen

To generate a custom splash screen, use a bitmap editor, such as Paintbrush.

Creating a Splash Screen on Color Terminals

1. Create a color bitmap with dimensions of BX x BY where:
 - BX is less than or equal to 240 pixels
 - BY is less than or equal to 320 pixels
2. For best quality, use a relatively high resolution color image (for example, 16-bit color). Lower resolution images will also work.
3. Save the file as a 24-bit .bmp bitmap.

Creating a Splash Screen on Monochrome Terminals

1. Create a 16-color bitmap with dimensions of BX x BY where:
 - BX is less than or equal to 240 pixels
 - BY is less than or equal to 320 pixels
2. Be sure to create the file with 16 colors where 4 bits are used for each pixel of data in the file. IPL will not load if the number of bits of data for each pixel (bpp) is not correct.
3. Save the file as a 4-bit, 16-color .bmp bitmap.

Loading the Splash Screen via TCM

To load the bitmap:

1. Click **TCM.exe** in the TCM directory.
2. Connect the PPT 2800 to the development PC and invoke IPL to prepare the terminal to receive the splash screen download.
3. Select *Load Terminal* from the *File* menu on the development PC.
4. Select your splash screen hex file to begin downloading to the PPT 2800.
5. Close TCM.

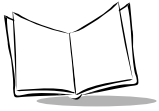

PPT 2800 Series Product Reference Guide for Pocket PC 2002

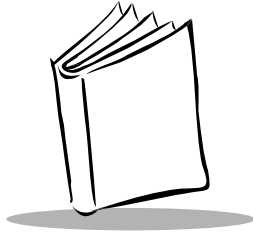

Chapter 13

Maintenance and Troubleshooting

Chapter Contents

Introduction	13-3
Maintaining the PPT 2800	13-3
Troubleshooting	13-3

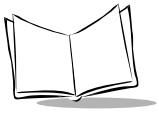

PPT 2800 Series Product Reference Guide for Pocket PC 2002

Introduction

This chapter includes instructions on cleaning and storing your terminal, and provides troubleshooting solutions for potential problems during terminal operating.

Maintaining the PPT 2800

For trouble-free service, observe the following tips when using your PPT 2800:

- Take care not to scratch the screen of your PPT 2800. When working with your PPT 2800, use the supplied stylus or plastic-tipped pens intended for use with a touch-sensitive screen. Never use an actual pen or pencil or other sharp object on the surface of the PPT 2800 screen.
- Although your PPT 2800 is water and dust resistant, do not expose it to rain or moisture for an extended period of time. In general, treat your PPT 2800 as you would a pocket calculator or other small electronic instrument.
- The touch-sensitive screen of your PPT 2800 contains glass. Take care not to drop your PPT 2800 or subject it to strong impact.
- Protect your PPT 2800 from temperature extremes. Do not leave it on the dashboard of a car on a hot day, and keep it away from heat sources.
- Do not store or use your PPT 2800 in any location that is extremely dusty, damp or wet.
- Use a soft lens cloth to clean your PPT 2800. If the surface of the PPT 2800 screen becomes soiled, clean it with a soft cloth moistened with a diluted window-cleaning solution.

Troubleshooting

Table 13-1. Troubleshooting

Problem	Possible Solution
PPT 2800 terminal does not turn on.	Adjust the contrast/backlight. Make sure batteries are installed properly. Replace the batteries. If your PPT 2800 terminal still does not operate, try a soft reset; see Resetting Your PPT 2800 Terminal on page 2-23.

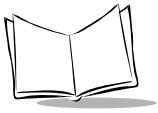

Table 13-1. Troubleshooting (continued)

Problem	Possible Solution
PPT 2800 does not emit sound.	Check the System Volume slider in the <i>Sounds & Notifications</i> properties screen (under <i>Start/Settings</i>) to make sure the volume is not turned down.
PPT 2800 turns itself off.	Your PPT 2800 terminal is designed to turn itself off after a period of inactivity. This period can be set from one to five minutes, in one-minute intervals. Check the <i>Power</i> screen (in the <i>System</i> tab under <i>Start/Settings</i>), and change the setting if you need a longer delay before the automatic shutoff feature activates.
PPT 2800 stops responding to screen input.	Perform a soft reset. See Resetting Your PPT 2800 Terminal on page 2-23.
PPT 2800 responds inaccurately to stylus taps.	Align the screen. Choose <i>Align Screen</i> from the <i>System</i> tab under <i>Start/Settings</i> , or hold down the Function button and press the Action button.
PPT 2800 doesn't recognize my handwriting.	<p>If you're using the Block Recognizer input method, characters must be written a certain way. See Appendix A, Block Recognizer Characters for information about how to write character strokes.</p> <p>Make the character strokes in the lower character entry area on the screen — not on the display part of the screen.</p> <p>Make sure you are writing lower-case letters, upper-case letters, and numbers in the appropriate sections of the writing area. See Entering Information Using the Input Panel on page 2-10.</p>
Tapping the screen buttons or icons does not activate the corresponding feature.	Align the screen. Choose <i>Screen</i> from the <i>System</i> tab under <i>Start/Settings</i> , or hold down the Function button and press the Action button.
A message appears stating that your PPT 2800 terminal memory is full.	<p>Delete unused memos and records. If necessary, you can save these records on your computer.</p> <p>If you are copying files to your terminal, adjust the memory allocation. Select <i>Start</i>, then <i>Settings</i>, and select the <i>System</i> tab. Tap <i>Memory</i> and adjust the slider.</p> <p>Remove programs you no longer use. Select <i>Start</i>, then <i>Settings</i>, and select the <i>System</i> tab. Tap <i>Remove Programs</i>, select the unused program and tap <i>Remove</i>.</p>

Table 13-1. Troubleshooting (continued)

Problem	Possible Solution
PPT 2800 is not communicating with the desktop PC.	<p>Ensure the PPT 2800 is connected to the desktop PC via serial cable, or is placed in a cradle connected to the desktop PC.</p> <p>Confirm that the PPT 2800 and desktop PC are communicating at the same baud rate.</p> <p>Consult ActiveSync Help on your desktop PC.</p>
Beamed data does not transmit.	<p>Confirm that the terminals are 5' apart, and that the path between the two devices is clear of obstacles.</p> <p>Adjust the room lighting or move to a different location.</p>
When receiving beamed data an out of memory message appears.	<p>Your PPT 2800 terminal requires at least twice the amount of memory available as the data you are receiving. For example, if you are receiving a 30K application, you must have at least 60K free.</p>
Your PPT 2800 does not accept scan input.	<p>Verify that the terminal is loaded with a scanning application. See your System Administrator.</p> <p>Check to be sure the bar code symbol is not defaced.</p> <p>Be sure you are within proper scanning range.</p> <p>Be sure the terminal is programmed to accept the type of bar code you are scanning.</p> <p>If you are expecting a beep on a good decode and don't hear one, check that the application is set to generate a beep on good decode.</p> <p>If the PPT 2800 stops emitting a laser beam when you press the trigger, check your battery level. When the battery is low, the scanner shuts off before the terminal notifies you of the very low battery condition.</p>
Your PPT 2800 is not dialing out.	<p>Ensure the modem is connected to the terminal and the telephone jack.</p> <p>Verify the phone jack is connected to a working outside line.</p> <p>Ensure you have set the modem up properly (see Chapter 8, Connections).</p>

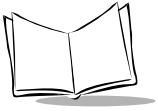
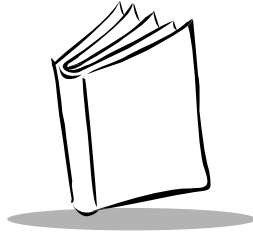

Table 13-1. Troubleshooting (continued)

Problem	Possible Solution
Your PPT 2800 is dialing but not connecting.	<p>Ensure the network you are calling supports Point-to-Point Protocol (PPP) Ask your networking administrator.</p> <p>Ensure the location is correct. Select <i>Start</i>, then <i>Settings</i>, and select the <i>Connections</i> tab. Tap the <i>Connections</i> icon. Tap <i>Dialing Locations</i> and verify the settings are correct for your current location. Tap <i>Dialing Patterns</i> to make sure the correct patterns are being dialed.</p> <p>Verify you are dialing the right number. Check the Connecting dial-out screen.</p> <p>Confirm the host modem is receiving a call when you dial out.</p> <p>Ensure you have set the modem up properly (see Chapter 8, Connections).</p>

Note: *If, after performing these checks, the terminal is still not reading symbols, contact your distributor or Symbol Technologies.*



Appendix A

Block Recognizer Characters

Using the Block Recognizer, you can write characters directly on your terminal screen with your stylus. These characters are translated into typed text. Use Block Recognizer to enter text, for example, to write a note or to fill in fields in a dialog box.

Figure A-2 provides examples of how to write characters in lowercase. The Block Recognizer input panel is divided into two writing areas. Letters written in the left area (labeled abc) create lowercase letters. Use the right area (labeled 123) for writing numbers, symbols, special characters, and punctuation.

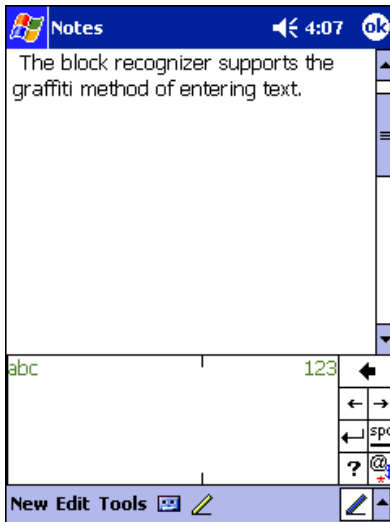
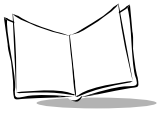

Figure A-1. Using Block Recognizer



The following chart illustrates some of the characters you can write (the dot on each character is the starting point for writing).

Letter Area					Number/Punctuation Area														
A	aa				N	h				0	0))			
B	bb				O	oo				1	1				+	+			
C	c				P	pp				2	2 2				*	* x ∞			
D	d				Q	q q				3	3				/	/			
E	e				R	r r				4	4 4 4 4 L				\	\			
F	f				S	s				5	5 5 5				?	? ? ?			
G	g				T	t 7 7 7 †				6	6				!	!			
H	h				U	u u				7	7				@	@			
I	i l				V	v				8	8				&	& 4			
J	j j				W	w w				9	9				‘	‘			
K	k k k k α				X	x x x				>	>				“	“			
L	l L l				Y	y y y				·	·				-	-			
M	m				Z	z				((

space	←
back space	→

enter	↵
back space	→

Figure A-2. Character Chart

For specific instructions on using Block Recognizer, with Block Recognizer open, tap the question mark next to the writing area.

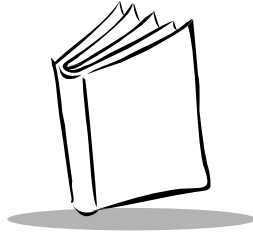

Appendix B

Demo Program

Introduction

The PPT 2800's demo program illustrates how to use some of the terminal's many applications. If the demo program is not already on your PPT 2800 (check the *Start* menu), you may download the program from the *Symbol Windows CE Software Developer's Kit (SDK)*. See [Chapter 3, Customizing Your PPT 2800](#) for instructions on adding programs to your terminal.

The following options are available via the demo program, and are described in this chapter.

- Utilities accesses the Control Panel and Diagnostics.
- Sample scanning applications for Visual C/C++, Visual Basic, and Pocket Internet Explorer.
- File Explorer file management utility.
- Sample MagStripe reader application.
- CE Apps accesses standard Microsoft Windows CE applications.
- Audio sample application demonstrates how to record, play back, and save audio files.
- ImageViewer application illustrates how to manipulate displayed image files.

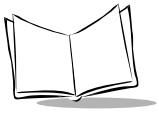

To initiate the demo program, select *PPT 2800 Demo* from the *Start* menu. The initial demo program screen appears.

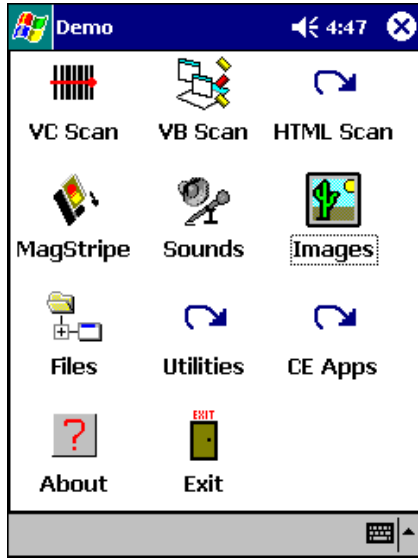

Figure B-1. Main Demo Screen

Scan Demo (VC Scan)

The Visual C/C++ sample scanning application enables the terminal's scanner, allows the user to change scan parameters, and displays scanned data. To access the demo, tap VC Scan on the main demo screen.

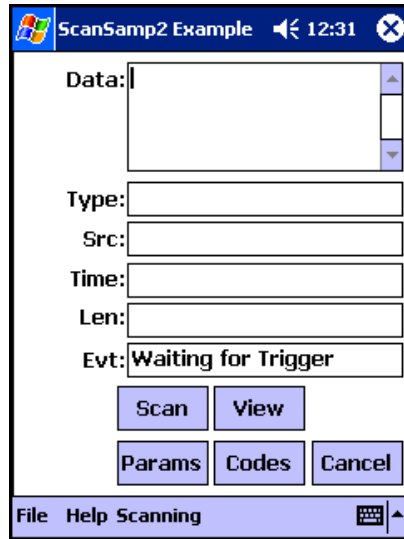
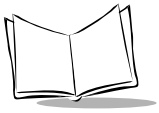

Figure B-2. Scan Sample Screen

Scanning Data Fields

After a bar code is scanned, the following data appears in the screen:

- *Data* displays the data encoded in the scanned bar code.
- *Type* indicates the hex type scanned.
- *SRC* indicates the scanner being used, and the bar code type scanned (e.g., Code 128).
- *Time* displays the time the bar code was scanned.
- *Len* indicates the number of digits in the bar code.
- *Evt* indicates the status of the scan demo.



Scanning Options

The following options are available in the *Scan* screen:

- *Scan* provides an alternative to the trigger buttons on the terminal.
- *View* displays the bar code content in a separate screen.
- *Params* is used to change scanning parameter options, such as:
 - beep time (length of decode beep)
 - beeper frequency (tone)
 - LED-on time (length of time LED remains on upon decode)
 - Code ID (AIM, Symbol)
 - Wav File (sound of decode beep).
- *Codes* selects the code types the terminal is able to decode, and sets the options for each code type.
- *Cancel* closes the *Scan* screen.

ActiveX Demo (VB Scan)

The ActiveX scan test uses the ActiveX Scan Control to perform bar code scanning. Upon a successful decode, the decoded data and bar code type are displayed.

To access the demo, tap *VB Scan* on the main demo screen.

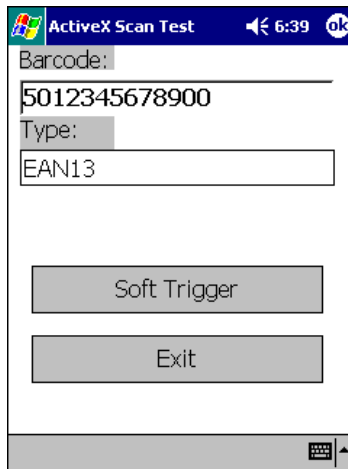

Figure B-3. ActiveX Scan Test Sample Screen

HTML Scan Demo

The HTML Scan demo provides the HTML application ScanBrowse. You may also use this application to turn the Scan Wedge in ScanBrowse on and off.

To access the demo, tap `HTML Scan` on the main demo screen.

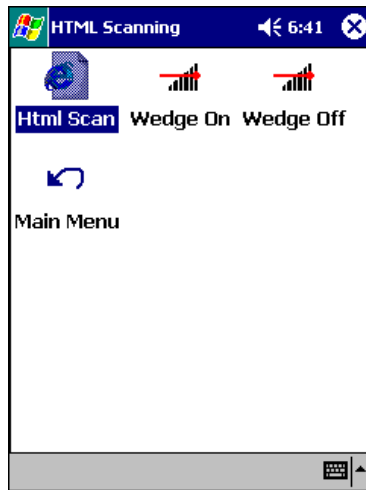
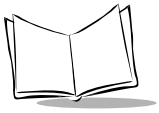

Figure B-4. HTML Scan Demo Screen

Wedge On/Off

These icons enable and disable the Scan Wedge. When enabled, the taskbar icon for the Scan Wedge appears in the task tray, and allows data to be scanned into edit fields.

Note: *The Pocket PC Task Tray is only visible on the Today screen.*



ScanBrowse

ScanBrowse uses Pocket Internet Explorer to render the HTML code and the Scan Wedge to scan data into scan enabled fields.

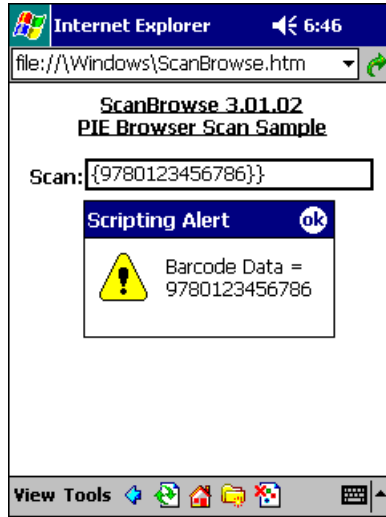

Figure B-5. Scan Browse Screen

In this sample HTML application, the scan wedge is configured (via ScanWedge.reg) to bracket all scanned data with “{{” and “}}” to allow the HTML application to differentiate scanned data from keyboard-entered data.

Files

Tap **Files** on the main demo screen for a file browser utility, File Explorer, that provides similar Windows Explorer-like functionality on Pocket PC terminals. File Explorer allows the user to browse, cut, copy, paste, and delete files as well as execute the program. It also provides file transfer capability via the IrDA port.

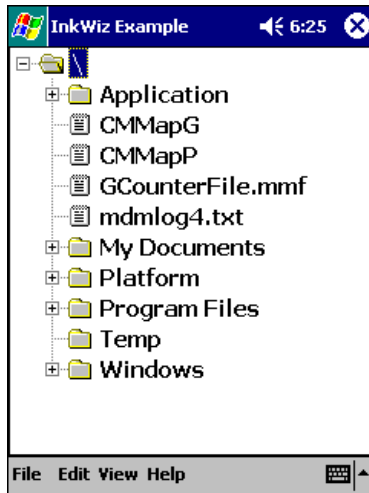
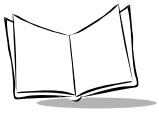

Figure B-6. File Explorer Screen

You can also access Microsoft File Explorer by selecting *Programs* under the *Start* menu.



MagStripe Reader

Select MagStripe on the demo's main menu for a sample MagStripe application.



Figure B-7. MagStripe Screen

Sounds (Audio Sample)

Tap **Sounds** on the main demo screen for an audio sample, which demonstrates how to record, play back, and save sounds.

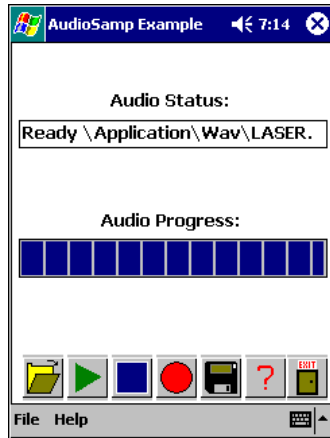
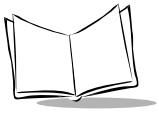

Figure B-8. Audio Sample Screen

Audio Files are opened from and saved to **\Application\wav** by default, and are configured by the following registry key:

HLCU\software\Symbol\settings

"WavDirectory" = "\\Application\wav"



Images (ImageViewer Sample)

Tap **Images** on the main demo screen for an ImageViewer application, which demonstrates how to manipulate picture images programmatically.

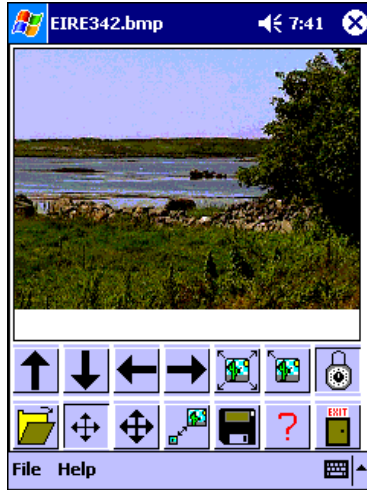















Figure B-9. ImageViewer Screen

ImageViewer supports color .bmp files, and both color and mono .jpg files.

The application uses screen swiping and buttons to control images. Following is a description of each button:

Button	Description	Button	Description
	Pan Up (panning mode), increase vertical size of image.		Pan Down (panning mode), decrease vertical size of image.
	Pan left (panning mode), decrease horizontal size of image.		Pan right (panning mode), increase horizontal size of image.
	Restore the image to its original size.		Locate the image in the upper left corner of screen.
	Lock the aspect ratio of the image when resizing.		Set mode to "resize."

Button	Description	Button	Description
	Set mode to "fine panning."		Set mode to "rough panning."
	Open an image file.		Exit the Image Viewer application.
	Save the current image.		About screen.

CE Apps

Tap **CE Apps** on the main menu to access the following standard Windows CE applications:

- Note Taker
- Calculator
- Tasks
- Calendar
- Solitaire.

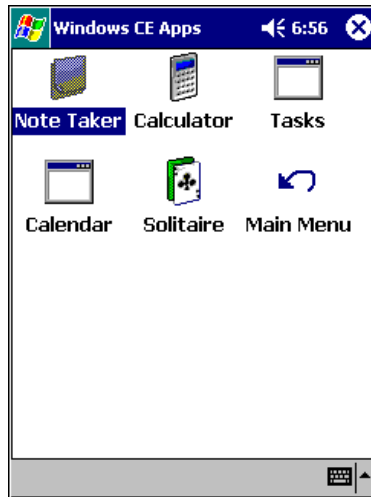
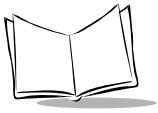

Figure B-10. CE Apps Screen



About

Select the **About** button on the demo's main screen to view information about the demo program.

Utilities

Tap **Utilities** on the main demo screen for diagnostic options that ensure various aspects of the terminal are functioning correctly.

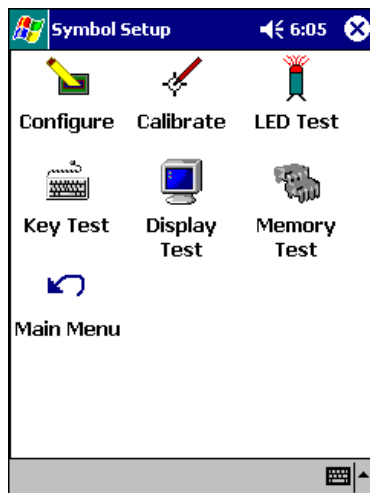

Figure B-11. Utilities Screen

- *Configure* accesses the Control Panel screen. See the [Control Panel](#) section.
- *Calibrate* allows you to re-calibrate the screen.
- *LED Test* tests the green decode LED-on and LED cycle to ensure it is functioning properly. This option also allows you to view the state of the LED (on or off).
- *Key Test* identifies each button on the terminal (except the Scan buttons) when each button is pressed.
- *Display Test* tests the pixels on the screen.
- *Memory Test* demonstrates how to query available memory, calculate memory load (%), and how to write code that properly handles system hibernate messages.
- *Main Menu* returns to the demo's main screen.

Control Panel

Tap *Configure* on the Utilities screen to access the Control Panel, where you can specify settings for your terminal.

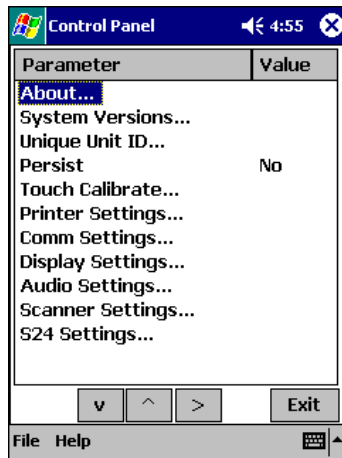

Figure B-12. Control Panel Screen

About and System Versions

Tap *About* on the Control Panel to view the version of the Control Panel. Tap *System Versions* to view version information for the applications on your terminal.

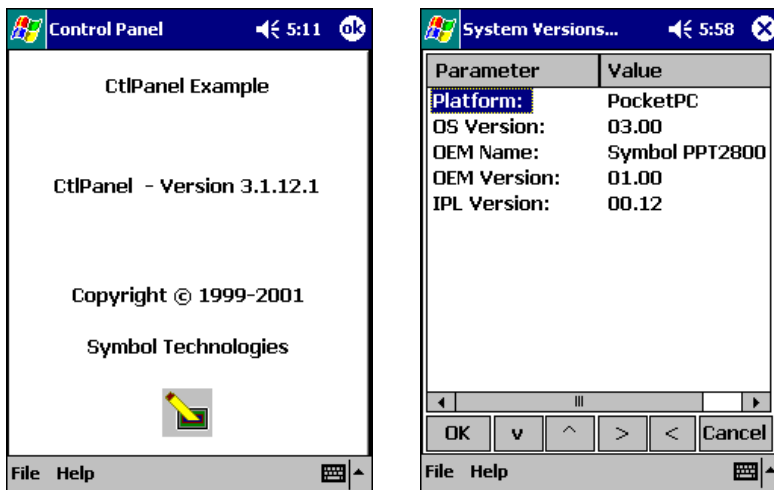
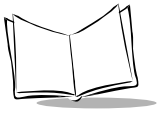

Figure B-13. About and System Versions Screen



On the System Versions screen:

- *Platform* indicates the operating system running on your PPT 2800 (Pocket PC).
- *OS Version* specifies the version of the operating system.
- *OEM Name* is the OEM name of the terminal.
- *OEM Version* indicates the build version of the operating system.
- *IPL Version* identifies the build version of the system loader.

Unique Unit ID

Tap *Unique Unit ID* on the Control Panel to view the terminal's unique unit ID (a 16-byte hex number identifier), and the version numbers for RCM (Resource Coordinator Manager) API, Rescoord (Resource Coordinator) DLL, UUID DLL, and Temperature DLL.

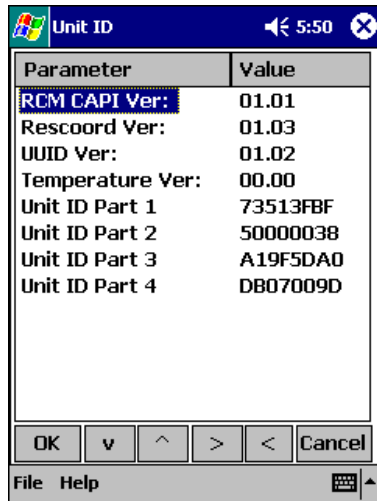

Figure B-14. Unique Unit ID Screen

Note: PPT 2800 Series Terminals do not support the Temperature DLL.

Persist

Persist allows changes made by the Control Panel to remain in effect after a cold boot. When enabled, Persist creates .reg files which save specific settings that are made and restore the settings to the registry after a cold boot.

Toggle *Persist* to Yes to retain these changes made after a cold boot.

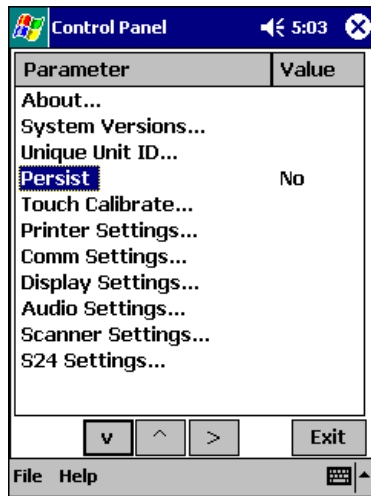
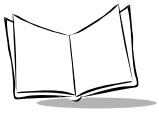

Figure B-15. Persist

Note: *Not all options support Permanent Persistence.*



Touch Calibrate

Select *Touch Calibrate* to re-align the screen.

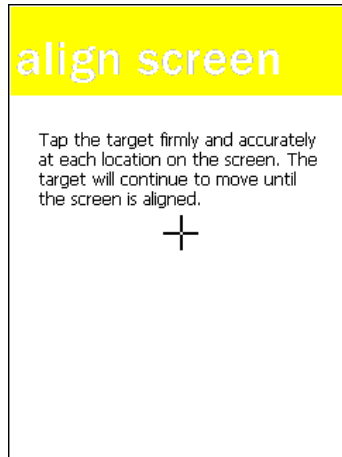

Figure B-16. Align Screen

Printer Settings

Select *Printer Settings* on the Control Panel to select the printer you'll use with the terminal, and specify printer settings.



Figure B-17. Printer Settings Screen

- *Selected Printer* allows you to select the printer to use. To change the printer, tap the *Selected Printer* field to scroll through the available printers.
- *Printer Parameter* allows you to set the communication parameter associated with the selected printer. To change this setting, tap the *Printer Parameter* field, then select the communication parameter for your printer.
- *Version Info* displays the Printer API version number.

Communication Settings

Select *Comm Settings* on the Control Panel to specify the settings to use when communicating with other devices.

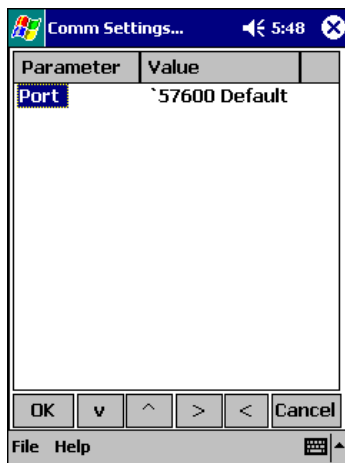
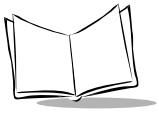

Figure B-18. Communication Settings Screen

Tap *Port* to select the appropriate communication settings to be used by ActiveSync. Scroll through the communication settings to select the appropriate value.



Display Settings

Select *Display Settings* on the Control Panel to customize the display contrast and backlight.

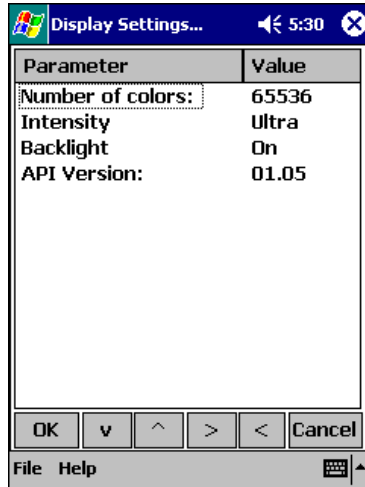

Figure B-19. Display Settings Screen (Color Terminal Shown)

- Tap *Display Contrast* (monochrome terminals only) to increment the contrast value. The terminal's display changes along with the value.
- Tap *Intensity* (color terminals only) to increment the intensity value. The terminal's display changes along with the value.
- Tap *Backlight* to toggle the backlight on or off.
- *API Version* displays the current version of the Display API.

Audio Settings

Select *Audio Settings* on the Control Panel to specify the beeper volume and view the version numbers for the Audio and Notify APIs.

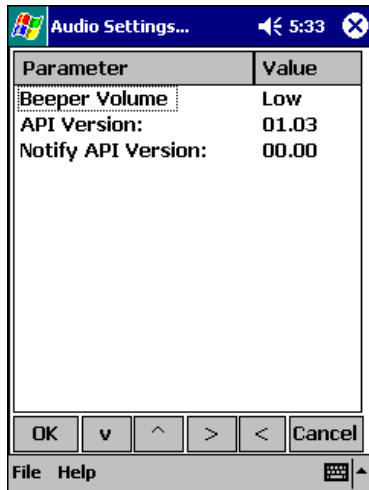
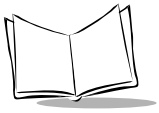

Figure B-20. Audio Settings Screen

- Tap *Beeper Volume* to toggle the beeper volume between low, medium, and high. As you change the value, the beeper sounds to demonstrate the level.
- *API Version* displays the version number of the Audio API.
- *Notify API Version* displays the version number of the Notify API.



Scanner Settings

Select *Scanner Settings* on the Control Panel to specify scanner-related parameters.

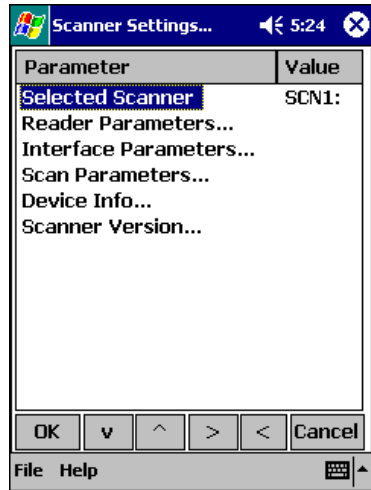
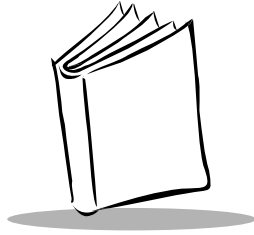

Figure B-21. Scanner Settings Screen

Tap *Scanner Version* to view the version numbers for the hardware, decoder, PPD, MDD, and API.

Refer to the Help file on the SDK for details on the available parameter options.



Appendix C

GSM Demo Program

Introduction

GsmDemo allows you to explore what features GSM and the PPT 2837 terminal offer you, including sending and receiving SMS messages, and setting up GPRS parameters.

GsmDemo Screens

To start GsmDemo:

1. Select *Programs* from the *Start* menu.
2. Tap the *File Explorer*.
3. Navigate to the *Application* folder and select *GsmDemo*.

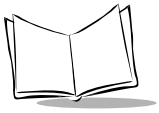

Main Screen

When GsmDemo opens, it opens the internal serial port to the GSM modem and attempts to register with a network. The following screen displays. The *Network Status* field displays the following messages as the modem attempts to connect: *Opening GSM COM Port*, *Checking SIM Card*, *Configuring Modem*, *Searching*, then *Registered Home* if the search is successful (*Registered Roam* if out of network).

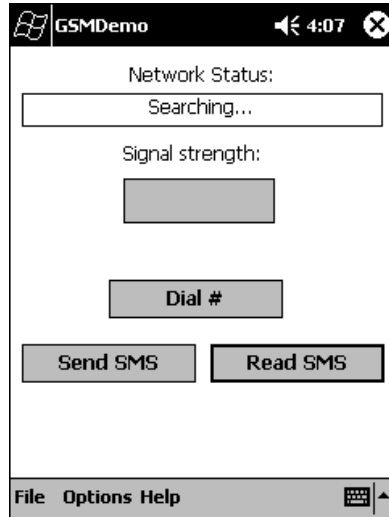

Figure C-1. GsmDemo Main Screen

If the PIN is enabled on the SIM, the Enter PIN screen appears, and the demo will not register until you enter the PIN.

Network Status	Displays Not Registered, Initializing Modem, Registered, or Registration Failed.
Signal strength	Displays signal strength.
Dial #	Sets dial properties and places call (see Dial # on page C-6).
Send SMS	Sends a message to another terminal or modem (see Send SMS on page C-5).
Read SMS	Displays a message from another terminal or modem (see Read SMS on page C-3).

Read SMS

To read your SMS messages:

1. Tap **Read SMS** on the main screen. The following screen displays, listing the messages available for viewing:

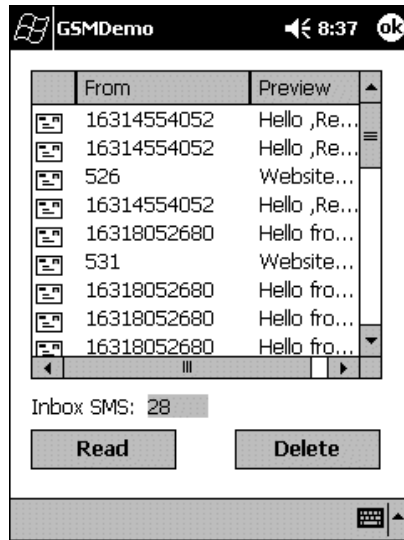

Figure C-2. Read SMS Screen

2. Tap a message you'd like to read, then tap **Read** to open the message.
3. To delete a message, tap the message, then tap **Delete** to delete the message.

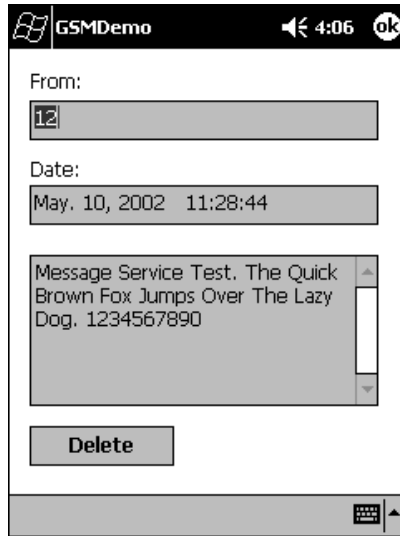
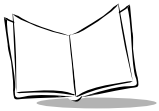

Figure C-3. Read SMS Screen

4. Tap **Delete** to delete the message and return to the Read SMS screen.

Send SMS

To send an SMS message:

1. Tap `Send SMS` on the main screen.

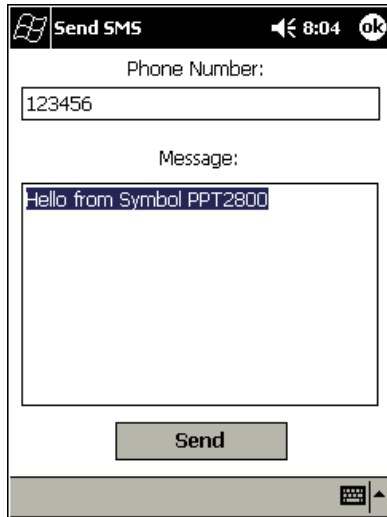
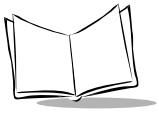

Figure C-4. Send SMS Screen

2. Enter the phone number of the message recipient and the message.
3. Tap `Send` to send the message. A successful message screen displays.



Dial

The Dial # feature controls the dial properties of the modem. Select Dial # on the main menu:

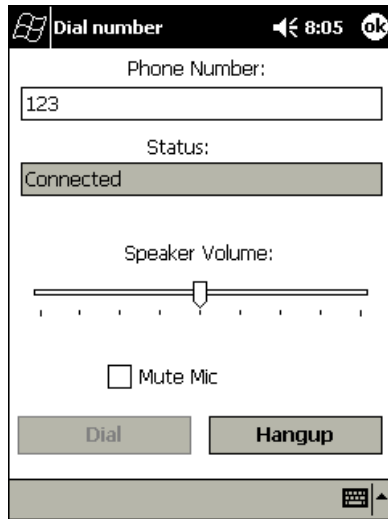

Figure C-5. Dial Screen

Phone Number	Phone number to dial.
Status	Indicates if modem is connected to the specified number.
Mute Mic	Turns microphone off.
Speaker Volume	Slide bar controls volume of speaker.
Dial	Dials the number specified.
Hangup	Disconnects the session.

GsmDemo Menu Commands

This section explains the menu commands specific to GsmDemo, accessed from the bottom of the screen.

Options Menu/Settings Screen

Select *Settings* from the *Options* menu to view or change the status of the SIM card.

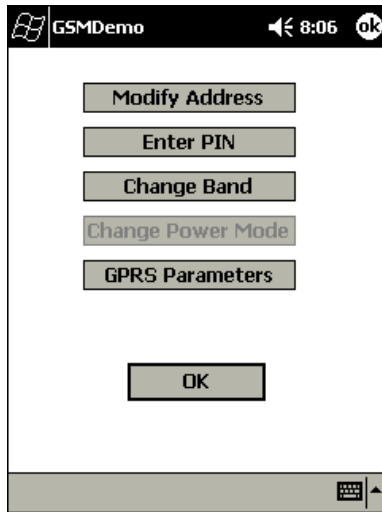
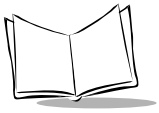

Figure C-6. Settings Screen

Tap `Modify Address` if you need to change the service center phone number if the number is missing, its phone number has changed, or you wish to choose an alternate service center.



On the *Service center address* screen, enter the new service center number in the *New address* field and tap *Enter Address*.



Figure C-7. Service Center Address Screen

Tap `Enter PIN` on the *Settings* screen to enter a new PIN number. Enter the PIN # in the *Enter PIN number:* field and tap `Enter Pin`.

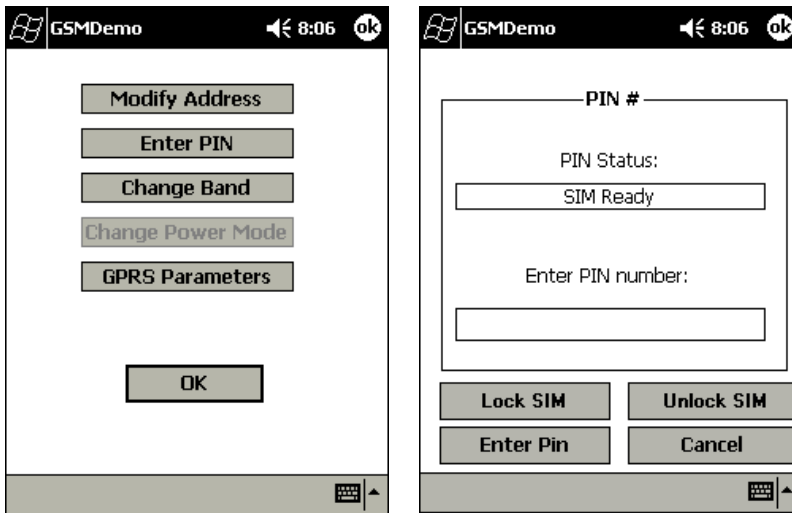
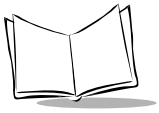

Figure C-8. PIN # Screen



Tap **Change Band** on the *Settings* screen to make any changes. Tap **Change** to register the change.

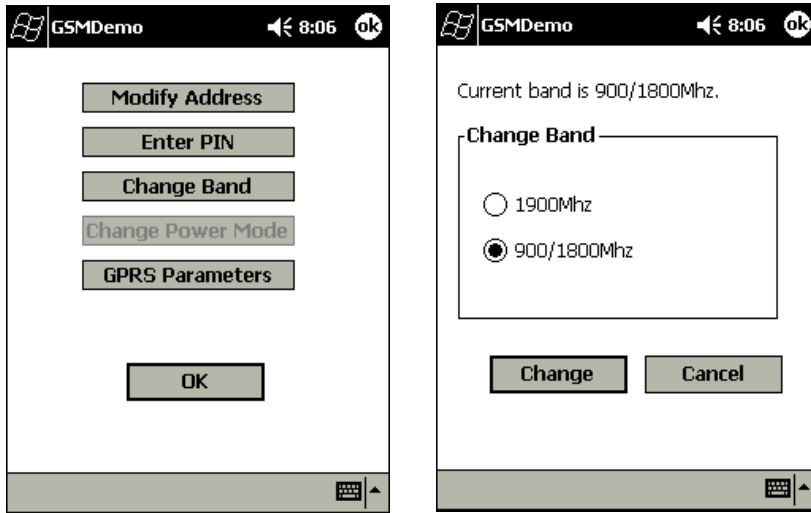

Figure C-9. Change Band Screen

Note: *The modem resets (powercycles) when you change the band, indicated in the Network Status screen.*

Tap GPRS Parameters on the *Settings* screen to alter GPRS parameters. Tap the PDP Context, Minimum Quality of Service, and Required Quality of Service tabs to move between screens.

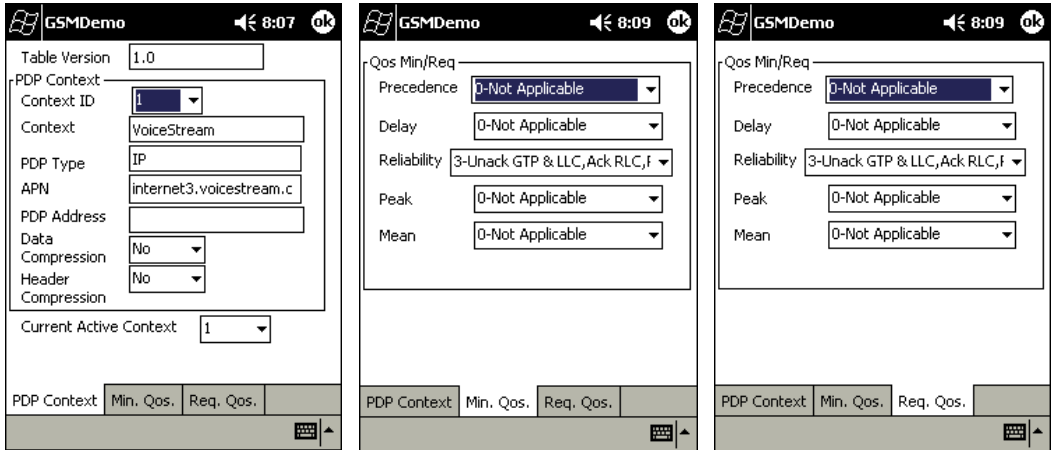
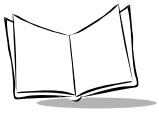

Figure C-10. GPRS Parameters Screens

Make the required changes (supplied by the service provider) using the drop-down menus, and tap **OK** to return to the *Settings* screen.



Help Menu

The *Help* menu provides information about your GSM modem.

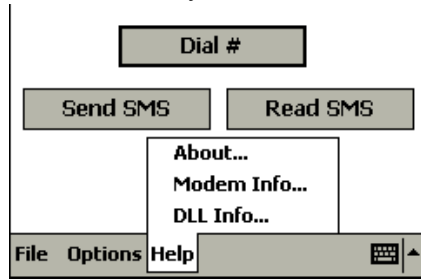

Figure C-11. GsmDemo Help Menu

Select *About* on the *Help* menu for version information regarding the GsmDemo. Select *Modem Info* for model information regarding your GSM modem, and select *DLL Info* for DLL version information.



Figure C-12. Help Screens

File Menu

Use the *File* menu to exit the GsmDemo applicaiton. Tap *File*, then *Exit*.

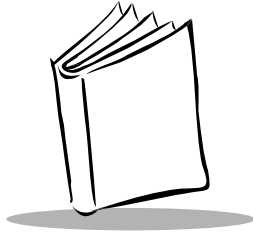

Appendix D

Technical Specifications

Environment

Table D-1 summarizes the PPT 2800's intended operating environment.

Table D-1. PPT 2800 Operating Environment

Operating Temperature	-20° C to 50° C (-4° F to 122° F)
Storage Temperature	-25° C to 50° C (-13° F to 122° F)
Humidity	5% to 90% non-condensing
Electrostatic Discharge (ESD)	8 kVdc air; 4 kVdc contact
Drop to Concrete	1.2 meters (4 feet)
Sealing	IP54 (windblown rain and dust)
Decode Distance	3" - 10.5" (7.6 cm - 26.7 cm)
Size	1-D Scanning Terminal: 7"L x 3.625"W x 1"H (177.8mm x 92mm x 25.4mm) 2-D Scanning Terminal: 7.625"L x 3.625"W x 1"D (grip area) x 1.5"D (scanner bay) (193.7mm x 92mm x 25.4mm x 38.1mm)
Weight (including battery)	1-D Scanning Terminal: 10.3 oz / 288 gm (batch); 11.8 oz / 330 gm (wireless) 2-D Scanning Terminal: 13.8 oz / 391 gm (batch); 15.3 oz / 434 gm (wireless)

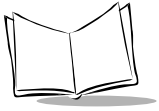

COM Port Definitions

Table D-2. PPT 2800 COM Port Definitions

COM Port	Definition
COM1	Serial/Cradle
COM2	Raw IrDA
COM3	IRComm
COM4	Scanning
COM5	Reserved
COM6	WAN
COM7	VCOM Ext Power
COM8	V2COM Ext Power

Pin-Outs

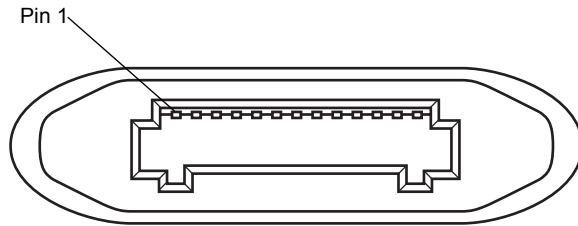
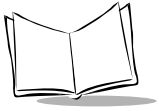

Figure D-1. ActiveSync Port (COM1)

Table D-3. PPT 2800 ActiveSync Port (COM1) Pin-Outs

Pin	Description
1	ext ±5 volts
2	DSR
3	RXD
4	RTS
5	TXD
6	CTS
7	DCD
8	RI
9	DTR
10	RS232_gnd
11	Power_GND
12	9 Volts_In
13	NC
14	NC



PPT 2800 Series Product Reference Guide for Pocket PC 2002

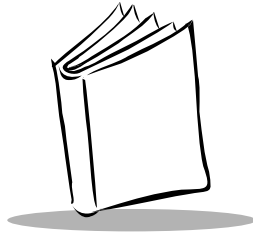

Index

Numerics

11 Mbps

advanced properties	9-21
APs	9-35
encryption	9-29
info	9-24
IP config	9-25
mode	9-23
options	9-28
ping	9-33
power	9-26
signal	9-34

2 Mbps

advanced properties	9-13
general	9-14
options	9-18
power	9-15
signal	9-16
transmission	9-17

A

accessories	1-6
cables	1-6
cradles	1-6
ActiveSync	4-3
adding programs to Start menu	3-10
installing	4-3
local operation	4-8
remote	4-8
using cable	4-5
using cradle	4-6
via modem	4-8
adding programs	3-8

to Start menu	3-9
adjusting backlight	2-3
adjusting terminal settings	3-3
aligning screen	1-15, B-16
applications	5-1
button assignment	3-6, 3-7
calendar	5-3
meeting requests	5-5
summary screen	5-5
contacts	5-6
summary screen	5-8
GsmDemo	C-1
dial properties	C-6
file menu	C-12
help menu	C-12
main screen	C-2
menu commands	C-7
options menu	C-7
read SMS	C-3
screens	C-1
send SMS	C-5
settings	C-7
text messages	C-3
inbox	5-14
connecting to e-mail server	5-14
creating messages	5-18
managing	5-19
message list	5-16
synchronizing e-mail	5-14
notes	5-12
tasks	5-9
summary screen	5-11
appointments	5-4
attaching handstrap	1-13

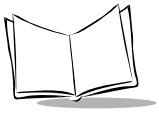

audio sample B-9
audio settings B-19
AvantGo channels 7-5

B

batteries
 charging 1-8
 charging spare batteries 1-10
 charging using cable 1-11
 checking power 1-12
 installing 1-6
 removing battery cover 1-7
block recognizer 2-12
booting
 cold 2-24
 warm 2-23
buttons
 assigning applications 3-6, 3-7
 function 2-3
 power 1-15, 2-3

C

cable
 pinouts D-3
cables 1-6
 connecting power cable 1-11
 inserting in terminal 1-11, 4-5
 performing ActiveSync 4-5
 synchronization 1-11
calendar application 5-3
 creating appointments 5-4
 meeting requests 5-5
 summary screen 5-5
calibrating screen B-16
CE applications B-11
channels 7-5
chapter descriptions xi
character chart A-2
character recognizer A-1
charging batteries 1-8
 spare battery 1-10
 using cable 1-11
 using cradle 1-8

cleaning terminal 13-3
command bar 2-8
 icons 2-5
communication settings B-17
communications 4-1
 ActiveSync 4-3
companion programs
 Pocket Excel 6-8
 Pocket Word 6-3
connecting 8-3
 disconnecting 8-9
 infrared 8-4
 to development PC 12-12
 to e-mail server 8-9
 to ISP 8-4
 to network 8-7
 via modem 8-7
contacting Symbol xiii
contacts application 5-6
 summary screen 5-8
control panel B-13
cradle
 charging batteries 1-8
 charging spare batteries 1-10
 connecting 4-6
 connecting power supply 1-8
 connecting to host 1-9
 inserting terminal 1-9, 4-7
 performing ActiveSync 4-3, 4-6
 performing modem ActiveSync 4-8
cradles 1-6
creating messages 5-18
creating splash screen 12-20
customizing the PPT 2800 3-1

D

demo program B-1
 about B-12
 ActiveX B-4
 audio B-9
 audio settings B-19
 CE applications B-11
 communications B-17

control panel B-13
display B-18
file explorer B-7
GSM C-1
HTML scan B-5
images B-10
ImageViewer B-10
magstripe B-8
MSR sample B-8
printer B-16
Scan Wedge B-5
ScanBrowse B-5, B-6
scanner B-3
scanner settings B-20
sounds B-9
utilities B-12
disconnecting 8-9
display settings B-18
drawing on screen 2-17

E

e-mail connection 8-9
 creating messages 5-18
 inbox 5-14
entering characters 2-12
entering information 2-10
 drawing on screen 2-17
 recording message 2-18
 scanning 2-18
 writing on screen 2-13
entering text 2-10
error messages 12-18, 12-19
Excel
 pocket 6-8

F

favorite links 7-3
file explorer 2-21, B-7
finding information 2-21
flash file system 3-3
 downloading partitions 3-6
 non-FFS partitions 3-6
 IPL 3-6

 splash screen 3-6
partitions 3-3
 copyfile 3-5
 regmerge 3-4
flash storage 3-3
function button 2-3

G

GsmDemo C-1
 dial properties C-6
 file menu C-12
 help menu C-12
 main screen C-2
 menu commands C-7
 options menu C-7
 read SMS C-3
 screens C-1
 send SMS C-5
 settings C-7
 text messages C-3

H

handstrap
 attaching 1-13

I

icons
 status 2-5
images
 demo B-10
ImageViewer B-10
inbox application 5-14, 5-18
 connecting to e-mail server 5-14
 managing 5-19
 message list 5-16
 synchronizing e-mail 5-14
infrared connection 8-4
Initial Program Loader 3-6, 12-12
input panel 2-10
 block recognizer 2-12
 letter recognizer 2-12
installing SDK 11-3

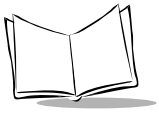

IPL 3-6, 12-12
 error messages 12-18
 setup 12-13
ISP connection 8-4

L

letter recognizer 2-12
loading applications 12-12
loading software 12-12
loading splash screen 12-21

M

magstripe B-8
maintaining terminal 13-3
mobile channels 7-5
mobile favorites 7-3, 7-7
 creating 7-3
modem connection 8-7
MSR B-8

N

navigation bar 2-8
network
 configuring CDPD WAN 10-8
 configuring GPRS WAN 10-23
 configuring GSM WAN 10-28
network adapter
 properties 9-4, 9-19
network connection 8-7
 via modem 8-7

NICTT

11 Mbps 9-21
2 Mbps 9-13
APs 9-35
encryption 9-29
 general 9-14
 info 9-24
IP config 9-25
mode 9-22
options 9-18, 9-28
ping 9-33

power 9-15, 9-26
signal 9-16
transmission 9-17
notational conventions xii
notes application 5-12

O

operating environment D-1

P

partitions
 downloading 3-6
 FFS 3-3
 non-FFS 3-6
 IPL 3-6
 splash screen 3-6
parts of PPT 2800 1-4
PDF417
 raster 2-22
 scanning 2-22
pin-outs D-3
Pocket Excel 6-8
Pocket Internet Explorer 7-1
 browsing web 7-8
 channels 7-5
 favorite links 7-3
 mobile favorites 7-3, 7-7
 using 7-6
Pocket Word 6-3
pop-up menus 2-8
power button 1-15, 2-3
power cable
 connecting 1-11
printer settings B-16
programs
 adding 3-8
 adding to Start menu 3-9
 button assignment 3-6, 3-7
 flash file system 3-3
 removing 3-10
 selecting 2-6

R

recording	2-18
removing programs	3-10
resetting	2-23
cold boot	2-24
warm boot	2-23

S

scanner	
settings	B-20
scanning	2-18, 2-22
2D bar codes	2-22
raster	2-22
scripts	
building	12-10
checking	12-10
creating	12-8
demo,samples	12-3
opening in TCM	12-8
saving	12-9
standard	12-3
SDK	11-3
installing	11-4
installing on development PC	11-4
system requirements	11-3
selecting a drawing	2-17
selecting programs	2-6
selecting text	2-13
selecting writing	2-14
service information	.xiii
setting date	1-17
setting time	1-17
setting time zone	1-16
settings	
adjusting	3-3
sound	
settings	B-19
sounds demo	B-9
specifications	D-1
Spectrum24	
APs	9-35
configuring	9-1
configuring 11 Mbps	9-21

configuring 2 Mbps	9-13
configuring PPT 2842	9-4, 9-19
encryption	9-29
general	9-14
info	9-24
IP config	9-25
mode	9-22
options	9-18, 9-28
ping	9-33
power	9-15, 9-26
signal	9-16, 9-34
transmission	9-17
Spectrum24 settings	9-6
advanced	9-6
encryption properties	9-9, 9-11
Micro AP properties	9-8
mobile unit properties	9-7
splash screen	3-6
creating	12-20
loading	12-21
Start menu	
adding programs	3-9
selecting programs	2-6
starting the PPT 2800	1-15
status icons	2-5
stylus	2-3
symbol support center	xiv
synchronization cable	1-11
connecting	1-11, 4-5

T

tasks application	5-9
summary screen	5-11
TCM	12-1
building hex image	12-3, 12-10, 12-11
components	12-4
creating script	12-8
defining properties	12-6
error messages	12-19
file browser window	12-5
hex image download	12-12
loading splash screen	12-21
saving script	12-9

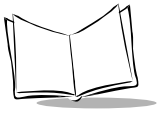

script window	12-4
starting	12-3
tool bar	12-5
technical specifications	D-1
Terminal Configuration Manager	12-1
Today screen	2-4
tools and utilities	
Spectrum24 settings	9-6
troubleshooting	13-3

U

unpacking	1-3
using stylus	2-3
using the PPT 2800	2-1, 5-1

scanning	2-22
utilities	B-12

W

web browser	7-8
Word	
Pocket	6-3
writing on screen	2-13
WWAN	
configuring	10-1
configuring CDPD	10-8
configuring GPRS	10-23
configuring GSM	10-28

Tell Us What You Think...

We'd like to know what you think about this Manual. Please take a moment to fill out this questionnaire and fax this form to: (631) 738-3318, or mail to:

Symbol Technologies, Inc.
One Symbol Plaza M/S B-4
Holtsville, NY 11742-1300
Attention: Technical Publications Manager

IMPORTANT: If you need product support, please call the appropriate customer support number provided. Unfortunately, we cannot provide customer support at the fax number above.

User's Manual Title: _____
(please include revision level)

How familiar were you with this product before using this manual?

Very familiar Slightly familiar Not at all familiar

Did this manual meet your needs? If not, please explain.

What topics need to be added to the index, if applicable?

What topics do you feel need to be better discussed? Please be specific.

What can we do to further improve our manuals?

PPT 2800 Series Product Reference Guide for Pocket PC 2002

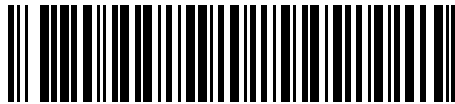

72-54894-03
Revision A — August 2002