



# PDT 8000 Series



## Product Reference Guide





***PDT 8000 Series  
Product Reference Guide***

*72-58169-05  
Revision A  
September 2003*



© 2003 by Symbol Technologies, Inc. All rights reserved.

No part of this publication may be reproduced or used in any form, or by any electrical or mechanical means, without permission in writing from Symbol. This includes electronic or mechanical means, such as photocopying, recording, or information storage and retrieval systems. The material in this manual is subject to change without notice.

The software is provided strictly on an “as is” basis. All software, including firmware, furnished to the user is on a licensed basis. Symbol grants to the user a non-transferable and non-exclusive license to use each software or firmware program delivered hereunder (licensed program). Except as noted below, such license may not be assigned, sublicensed, or otherwise transferred by the user without prior written consent of Symbol. No right to copy a licensed program in whole or in part is granted, except as permitted under copyright law. The user shall not modify, merge, or incorporate any form or portion of a licensed program with other program material, create a derivative work from a licensed program, or use a licensed program in a network without written permission from Symbol. The user agrees to maintain Symbol’s copyright notice on the licensed programs delivered hereunder, and to include the same on any authorized copies it makes, in whole or in part. The user agrees not to decompile, disassemble, decode, or reverse engineer any licensed program delivered to the user or any portion thereof.

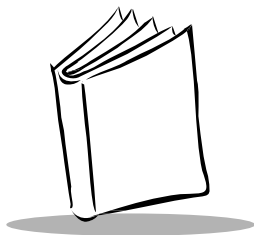
Symbol reserves the right to make changes to any software or product to improve reliability, function, or design.

Symbol does not assume any product liability arising out of, or in connection with, the application or use of any product, circuit, or application described herein.

No license is granted, either expressly or by implication, estoppel, or otherwise under any Symbol Technologies, Inc., intellectual property rights. An implied license only exists for equipment, circuits, and subsystems contained in Symbol products.

Symbol, Spectrum One, and Spectrum24 are registered trademarks of Symbol Technologies, Inc. Other product names mentioned in this manual may be trademarks or registered trademarks of their respective companies and are hereby acknowledged.

Symbol Technologies, Inc.  
One Symbol Plaza  
Holtsville, New York 11742-1300  
<http://www.symbol.com>



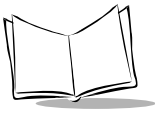
# Contents

## About This Guide

Introduction . . . . .	xiii
Chapter Descriptions . . . . .	xiii
Notational Conventions . . . . .	xv
Related Documents . . . . .	xv
Service Information . . . . .	xvi
Symbol Support Center . . . . .	xvi

## Chapter 1. Getting Started

Chapter Contents . . . . .	1-1
Introduction . . . . .	1-3
Unpacking the Terminal . . . . .	1-3
Parts of the Terminal . . . . .	1-4
Accessories . . . . .	1-6
Installing Batteries . . . . .	1-8
Charging the Terminal Battery . . . . .	1-9
Using the Serial Charging Cable . . . . .	1-10
Using the Snap-On Modem Module . . . . .	1-11
Using the Snap-On Autocharger . . . . .	1-12
Using the Magnetic Stripe Reader . . . . .	1-13
Using the Single-Slot Cradle . . . . .	1-14
Using the Four-Slot Cradle . . . . .	1-15
Using the Vehicle Cradle . . . . .	1-17
Charging Spare Batteries . . . . .	1-18
Using the Single-Slot Cradles . . . . .	1-18
Using the Four-Slot Cradles . . . . .	1-19
Using the Vehicle Cradle . . . . .	1-20
Using the UBC Battery Adapter . . . . .	1-21
Charge LED Indicator . . . . .	1-22
Installing a SIM Card . . . . .	1-24



Inserting a Compact Flash Storage Card . . . . .	1-24
Inserting an MMC/SD Storage Card . . . . .	1-26
Replacing the S24 Wireless Networker Card . . . . .	1-27
Replacing the Handstrap . . . . .	1-29
Starting the Terminal . . . . .	1-31
Aligning the Screen . . . . .	1-31
Setting Time and Date . . . . .	1-33
Configuring Wake-ups . . . . .	1-34
Checking Battery Power . . . . .	1-35
Power Management . . . . .	1-35
Low Battery Capacity . . . . .	1-35
Critical Low Battery During Suspend . . . . .	1-36
Battery Pull . . . . .	1-36
Setting Up Your Terminal . . . . .	1-37

## Chapter 2. Operating the Terminal

Chapter Contents . . . . .	2-1
Introduction . . . . .	2-3
Using the Power Button . . . . .	2-3
Adjusting the Backlight . . . . .	2-3
Using the Stylus . . . . .	2-3
Using a Headset . . . . .	2-4
Using the Keyboard . . . . .	2-5
Terminal Keyboard . . . . .	2-5
Today Screen . . . . .	2-7
Using the Navigation Bar and Command Bar . . . . .	2-8
Status Icons . . . . .	2-9
Selecting Programs . . . . .	2-10
Using Pop-up Menus . . . . .	2-11
Notifications . . . . .	2-12
Entering Information . . . . .	2-12
Entering Information Using the Input Panel . . . . .	2-12
Using the Soft Keyboard . . . . .	2-14
Using the Block Recognizer . . . . .	2-14
Using the Letter Recognizer . . . . .	2-15
Using the Transcriber . . . . .	2-15
Writing on the Screen . . . . .	2-16
Converting Writing to Text . . . . .	2-17
Writing Tips . . . . .	2-18
Selecting Text . . . . .	2-19
Selecting Writing . . . . .	2-19
Drawing on the Screen . . . . .	2-20
Selecting a Drawing . . . . .	2-20

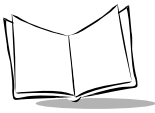
Recording a Message . . . . .	2-21
Entering Data via the Bar Code Scanner (Scan Wedge) . . . . .	2-21
Using My Text . . . . .	2-22
Finding Information . . . . .	2-22
Making a Phone Call (PDT 8037/8056 only) . . . . .	2-24
GSM Demo Installation . . . . .	2-24
GSM Demo Configuration . . . . .	2-24
Phone Call . . . . .	2-27
Sending and Receiving SMS Messages (PDT 8037/8056 only) . . . . .	2-29
GSM Demo Installation . . . . .	2-29
GSM Demo Configuration . . . . .	2-30
SMS Messaging . . . . .	2-32
Scanning . . . . .	2-33
Scan LED Indicator . . . . .	2-34
Resetting Your Terminal . . . . .	2-34
Performing a Soft Reset . . . . .	2-34
Performing a Hard Reset . . . . .	2-35

## Chapter 3. Customizing the Terminal

Chapter Contents . . . . .	3-1
Introduction . . . . .	3-3
Adjusting Settings . . . . .	3-3
Flash Storage . . . . .	3-4
FFS Partitions . . . . .	3-4
Working with FFS Partitions . . . . .	3-5
RegMerge.dll . . . . .	3-5
CopyFile . . . . .	3-6
Non-FFS Partitions . . . . .	3-6
Assigning Applications to Application Buttons . . . . .	3-7
Assigning User-Written Applications to Buttons . . . . .	3-7
Adding Programs . . . . .	3-8
Adding a Program from the Internet . . . . .	3-8
Adding a Program to the Start Menu . . . . .	3-9
Using File Explorer to Add to the Start Menu . . . . .	3-9
Using ActiveSync to Add to the Start Menu . . . . .	3-10
Removing Programs . . . . .	3-10

## Chapter 4. Communications

Chapter Contents . . . . .	4-1
Introduction . . . . .	4-3
Communication Software Installation . . . . .	4-3



Installing ActiveSync . . . . .	4-3
Setting up a Partnership . . . . .	4-4
Installing eConnect . . . . .	4-9
Installing MobileDox Cradle Manager . . . . .	4-9
Communication Setup . . . . .	4-10
Using the Serial Charging Cable . . . . .	4-11
Using the USB Cable . . . . .	4-13
Using the Single-Slot Serial Cradle . . . . .	4-15
Using the Single-Slot Modem Cradle or the Snap-On Modem . . . . .	4-18
Using ActiveSync . . . . .	4-21
Launching the Internet . . . . .	4-22
Country Setup . . . . .	4-23
Using a Four-Slot USB-to-Ethernet Cradle . . . . .	4-25
Using ActiveSync . . . . .	4-30
Launching the Internet . . . . .	4-32
Updating Cradle Firmware . . . . .	4-32
Communication LED Indicator . . . . .	4-33
Using the Vehicle Cradle . . . . .	4-34
Using ActiveSync . . . . .	4-34
Using the Magnetic Stripe Reader . . . . .	4-36
Using ActiveSync . . . . .	4-36
Using Printers . . . . .	4-38
Connecting to the Internet on a Wireless Network . . . . .	4-39

## Chapter 5. Applications

Chapter Contents . . . . .	5-1
Introduction . . . . .	5-3
Calendar . . . . .	5-3
Creating Appointments . . . . .	5-4
Using the Summary Screen . . . . .	5-5
Creating Meeting Requests . . . . .	5-5
Contacts . . . . .	5-6
Creating Contacts . . . . .	5-7
Using the Summary Screen . . . . .	5-8
Tasks . . . . .	5-9
Creating Tasks . . . . .	5-10
Using the Summary Screen . . . . .	5-11
Notes . . . . .	5-12
Creating Notes . . . . .	5-13
Inbox . . . . .	5-14
Synchronizing E-mail Messages . . . . .	5-14
Connecting Directly to an E-mail Server . . . . .	5-14
Setting Up an E-mail Service . . . . .	5-15



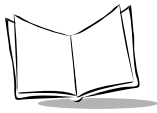
Using the Message List .....	5-16
Creating E-mail Messages .....	5-18
Managing E-mail Messages and Folders .....	5-19
Folder Behavior with ActiveSync and Direct Connection to Server .....	5-19

## Chapter 6. Companion Programs

Chapter Contents .....	6-1
Introduction .....	6-3
Pocket Word .....	6-3
Typing Mode .....	6-4
Writing Mode .....	6-6
Drawing Mode .....	6-6
Recording Mode .....	6-7
Pocket Excel .....	6-8
Tips for Working in Pocket Excel .....	6-9
MSN® Messenger .....	6-9
Setting Up Your Account .....	6-10
Working with Contacts .....	6-10
Chatting with Contacts .....	6-11
Windows Media Player .....	6-13
Microsoft Reader .....	6-13
Getting Books on Your Device .....	6-14
Using the Library .....	6-14
Reading a Book .....	6-15
Using Reader Features .....	6-15
Removing a Book .....	6-16
Infrared Receive .....	6-16

## Chapter 7. Pocket Internet Explorer

Chapter Contents .....	7-1
Introduction .....	7-3
Connect to an ISP .....	7-3
Browsing the Web .....	7-3
Mobile Favorites .....	7-4
Favorite Links .....	7-4
Creating Mobile Favorites .....	7-4
Saving Memory on your Terminal .....	7-5
Using AvantGo Channels .....	7-5
Using Pocket Internet Explorer .....	7-6



## Chapter 8. AirBEAM

Chapter Contents	8-1
Introduction	8-3
AirBEAM Package Builder	8-3
AirBEAM Client	8-4
AirBEAM License	8-4
Configuring the AirBEAM Client	8-4
Packages(1) Tab	8-5
Packages(2) Tab	8-5
Server Tab	8-6
Misc(1) Tab	8-7
Misc(2) Tab	8-9
Misc(3) Tab	8-10
Synchronizing with the Server	8-10
Manual Synchronization	8-11
Automatic Synchronization	8-11
AirBEAM Staging	8-12

## Chapter 9. Spectrum24 Network Configuration

Chapter Contents	9-1
Introduction	9-3
Configuring the Terminal (11 MB Radio)	9-4
Network Adapters Properties	9-4
Using Spectrum24 Settings	9-6
Advanced Settings	9-6
Mode Tab	9-7
Info Tab	9-8
IP Config Tab	9-9
Power Tab	9-10
Options Tab	9-11
Encryption Tab	9-12
Ping Tab	9-14
Signal Tab	9-15
APs Tab	9-16
Using LEAP for Authentication and Encryption	9-17
Downloading the Patch	9-17
Installing the Patch	9-17
Configuration	9-18

## Chapter 10. Wireless Wide Area Network Configuration

Chapter Contents	10-1
------------------	------

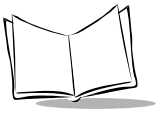
Introduction .....	10-3
Establish a GPRS Connection .....	10-3
GPRS Parameters Configuration .....	10-3
Using GSM Demo .....	10-3
Using the Registry File .....	10-11
Configuring a GPRS WAN Connection .....	10-15
Connecting via GPRS .....	10-18
Establish a GSM CSD Connection .....	10-21
GSM Demo Installation .....	10-21
Verify the functionality of your SIM Card .....	10-21
Configuring a GSM WAN Connection .....	10-23
Connecting via GSM .....	10-27

## Chapter 11. Software Installation on Development PC

Chapter Contents .....	11-1
Introduction .....	11-3
Before You Install the SDK .....	11-3
Symbol Windows CE SDK .....	11-3
Installing the SDK on the Development PC .....	11-4
Installing the SDK .....	11-4
Installing Other Development Software .....	11-4

## Chapter 12. Configuring the Terminal

Chapter Contents .....	12-1
Introduction .....	12-3
Starting Terminal Configuration Manager .....	12-4
Defining Script Properties .....	12-6
Creating the Script for the Hex Image .....	12-8
Open a New or Existing Script .....	12-8
Copy Components to the Script .....	12-8
Save the Script .....	12-9
Building the Image .....	12-10
If the Build Fails .....	12-11
Sending the Hex Image .....	12-12
Connect the Terminal and Development PC .....	12-12
Set Up IPL to Receive the File .....	12-12
64MB RAM Configuration .....	12-12
128MB RAM configuration .....	12-16
Begin the Send in TCM .....	12-20
Error Messages .....	12-21
IPL Error Detection .....	12-21
TCM Error Messages .....	12-23



Creating and Loading a Splash Screen ..... 12-23  
 Loading the Splash Screen via TCM ..... 12-24

## Chapter 13. Maintenance and Troubleshooting

Chapter Contents ..... 13-1  
 Introduction ..... 13-3  
 Maintaining the Terminal ..... 13-3  
 Troubleshooting ..... 13-4

## Appendix A. Block Recognizer Characters

## Appendix B. Additional Programs

Introduction ..... B-1  
 CF Shutdown ..... B-1  
 Installing CF Shutdown ..... B-1  
 Running CF Shutdown ..... B-2  
 PDT 8000 Demo ..... B-3  
 VC Scan Demo ..... B-4  
 Scanning Data Fields ..... B-4  
 Scanning Options ..... B-4  
 VB Scan Demo ..... B-5  
 Scanning Data Fields ..... B-5  
 Scanning Options ..... B-6  
 HTML Scan Demo ..... B-6  
 Html Scan ..... B-7  
 Wedge On/Off ..... B-7  
 Main Menu ..... B-7  
 Sounds (Audio Sample) ..... B-8  
 Images (ImageViewer Sample) ..... B-9  
 Files ..... B-9  
 Utilities ..... B-11  
 Configure ..... B-12  
 CE Apps ..... B-22  
 About ..... B-22  
 Exit ..... B-22

## Appendix C. GSM Demo Program

Introduction ..... C-1  
 GSM Demo Installation ..... C-1  
 GSM Demo Screens ..... C-2  
 Main Screen ..... C-2

Dial # Screen .....	C-3
Send SMS Screen .....	C-4
Read SMS Screen .....	C-4
GSM Demo Menu Commands .....	C-6
File Menu .....	C-6
Options Menu .....	C-6
Settings Screen .....	C-6
Modify Address Screen .....	C-6
Enter Pin Address .....	C-7
Change Band Screen .....	C-8
Change Power Mode Screen .....	C-9
GPRS Parameters Screen .....	C-10
Help Menu .....	C-13
About Screen .....	C-13
Modem Info Screen .....	C-14
DLL Info .....	C-14

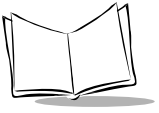
## Appendix D. Technical Specifications

Environment .....	D-1
COM Port Definitions .....	D-2
Pin-Outs .....	D-3

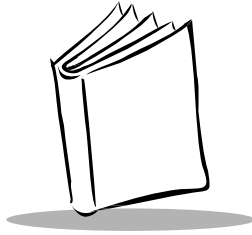
## Appendix E. Keyboard Maps

Introduction .....	E-1
Keyboard .....	E-2

## Index



*PDT 8000 Series Product Reference Guide*



## About This Guide

### Introduction

---

The *PDT 8000 Series Product Reference Guide* provides information about the PDT 8000 Series terminal using the Pocket PC 2002 Operating System, and its accessories. The PDT 8000 Series includes the following variations of the terminal:

- PDT 8000: batch
- PDT 8037: Wireless WAN radio
- PDT 8046: Spectrum24 LAN radio
- PDT 8056: LAN/WAN radio.

---

**Note:** *This guide provides instructions for both the 64MB RAM configuration (p/n PDT80XX-TSX6XXX) and the 128MB RAM configuration (p/n PDT80XX-TSX8XXX).*

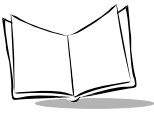
---

### Chapter Descriptions

---

Topics covered in this guide are as follows:

- [Chapter 1, Getting Started](#) explains the physical buttons and controls on your terminal, how to install and charge the batteries, install the SIM card, insert and remove a compact flash card, insert and remove the MMC/SD card, replace the S24 wireless network card, replace the handstrap and start your terminal for the first time.



- [Chapter 2, Operating the Terminal](#) explains how to use your terminal, including instructions for powering on and resetting the terminal, using the stylus and a headset, entering information and scanning.
- [Chapter 3, Customizing the Terminal](#) explains how to adjust settings on the terminal, and add and delete programs.
- [Chapter 4, Communications](#) explains how to use Microsoft® ActiveSync™ for communications between the terminal and host computer.
- [Chapter 5, Applications](#) describes how to use the Calendar, Contacts, Tasks, Notes and Inbox applications.
- [Chapter 6, Companion Programs](#) describes how to use Pocket Word, Pocket Excel, MSN Messenger, MS Media Player, Microsoft Reader and Infrared Received.
- [Chapter 7, Pocket Internet Explorer](#) explains how to set up favorite links and channels, and browse the web on your terminal.
- [Chapter 8, AirBEAM](#) explains how to set up you terminal to synchronize with a server using the AirBEAM product.
- [Chapter 9, Spectrum24 Network Configuration](#) describes how to configure the Spectrum24 wireless connection.
- [Chapter 10, Wireless Wide Area Network Configuration](#) describes how to configure the terminal for GPRS or GSM connection.
- [Chapter 11, Software Installation on Development PC](#) provides instructions for installing the Software Developer's Kit on your host computer.
- [Chapter 12, Configuring the Terminal](#) describes how to install and use the Terminal Configuration Manager (TCM) and Initial Program Loader (IPL).
- [Chapter 13, Maintenance and Troubleshooting](#) provides information to help you take proper care of the terminal and solve problems that may come up.
- [Appendix A, Block Recognizer Characters](#) details how to write letters on your terminal using the Block Recognizer so they are correctly translated into text.
- [Appendix B, Additional Programs](#) provides an overview of the PDT 8000 demo program applications, such as scanning, setup, diagnostic utilities and file management.
- [Appendix C, GSM Demo Program](#) describes how to use the GSM Demo program, which allows you to explore GSM features on WAN-enabled terminals.
- [Appendix D, Technical Specifications](#) includes a table listing the technical specifications for the terminal.



- [Appendix E, Keyboard Maps](#) includes tables listing key functionality for the keyboard.

## Notational Conventions

---

This document uses these conventions:

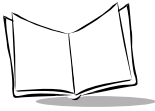
- “terminal” or “PDT 8000” refers to any model of the terminal.
- “User” refers to anyone using an application on the terminal.
- “You” refers to the End User, System Administrator or Technical Support person using this manual as a reference to install, configure, operate, maintain and troubleshoot the terminal.
- *Italics* are used to highlight specific items in the general text, and to identify chapters and sections in this and related documents. It also identifies names of screens, menus, menu items and fields within screens.
- Courier text identifies buttons to be tapped or clicked on screens.
- Bullets (•) indicate:
  - lists of alternatives or action items.
  - lists of required steps that are not necessarily sequential.
- Numbered lists indicate a set of sequential steps, i.e., those that describe step-by-step procedures.

## Related Documents

---

The following documents provide more information on the terminal.

- *PDT 8000 WAN Quick Reference Guide*, p/n 72-61492-xx
- *MDM 8000 Snap-on-Modem Quick Reference Guide*, p/n 72-55730-xx
- *VCA 8000-01 Snap-on-Autocharger Quick Reference Guide*, p/n 72-57868-xx
- *MSR 8000 Magnetic Stripe Reader Quick Reference Guide*, p/n 72-61513-xx
- *CRD 8000-1000S Serial Cradle Quick Reference Guide*, p/n 72-58170-xx
- *CRD 8000-1000M Modem Cradle Quick Reference Guide*, p/n 72-58171-xx
- *CRD 8000-4000C/B Charging Cradle Quick Reference Guide*, p/n 72-58172-xx
- *CRD 8000-4000E Ethernet/USB Cradle Quick Reference Guide*, p/n 72-58173-xx
- *VCD 8000-R000 Vehicle Cradle Quick Reference Guide*, p/n 72-58174-xx
- *UBC 2000 Universal Battery Charger Product Guide*, p/n 70-33188-xx



- *AirBEAM Package Builder Product Reference Guide*, p/n 72-55769-xx.
- *Windows CE Help File for Symbol Terminals*, p/n 72E-38880-xx.
- *Symbol Software Developer's Kit (SDK) for the Pocket PC*, available at <http://Software.Symbol.com/DevZone>.

## Service Information

---

If you have a problem with your equipment, contact the [Symbol Support Center](#) for your region. See [page xvi](#) for contact information. Before calling, have the model number, serial number and several of your bar code symbols at hand.

Call the Support Center from a phone near the scanning equipment so that the service person can try to talk you through your problem. If the equipment is found to be working properly and the problem is symbol readability, the Support Center will request samples of your bar codes for analysis at our plant.

If your problem cannot be solved over the phone, you may need to return your equipment for servicing. If that is necessary, you will be given specific directions.

---

**Note:** *Symbol Technologies is not responsible for any damages incurred during shipment if the approved shipping container is not used. Shipping the units improperly can possibly void the warranty. If the original shipping container was not kept, contact Symbol to have another sent to you.*

---

## Symbol Support Center

For service information, warranty information or technical assistance contact or call the Symbol Support Center in:

### United States <sup>1</sup>

Symbol Technologies, Inc.  
One Symbol Plaza  
Holtsville, New York 11742-1300  
1-800-653-5350

### Canada

Symbol Technologies Canada, Inc.  
2540 Matheson Boulevard East  
Mississauga, Ontario, Canada L4W 4Z2  
905-629-7226

**United Kingdom**

Symbol Technologies  
Symbol Place  
Winnersh Triangle, Berkshire RG41 5TP  
United Kingdom  
0800 328 2424 (Inside UK)  
+44 118 945 7529 (Outside UK)

**Australia**

Symbol Technologies Pty. Ltd.  
432 St. Kilda Road  
Melbourne, Victoria 3004  
1-800-672-906 (Inside Australia)  
+61-3-9866-6044 (Outside Australia)

**Denmark/Danmark**

Symbol Technologies AS  
Dr. Neergaardsvej 3  
2970 Hørsholm  
7020-1718 (Inside Denmark)  
+45-7020-1718 (Outside Denmark)

**Finland/Suomi**

Oy Symbol Technologies  
Kaupintie 8 A 6  
FIN-00440 Helsinki, Finland  
9 5407 580 (Inside Finland)  
+358 9 5407 580 (Outside Finland)

**Asia/Pacific**

Symbol Technologies Asia, Inc (Singapore Branch)  
230 Victoria Street #05-07/09  
Bugis Junction Office Tower  
Singapore 188024  
Tel: +65-6796-9600  
Fax: +65-6337-6488

**Austria/Österreich**

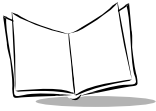
Symbol Technologies Austria GmbH  
Prinz-Eugen Strasse 70 / 2.Haus  
1040 Vienna, Austria  
01-5055794-0 (Inside Austria)  
+43-1-5055794-0 (Outside Austria)

**Europe/Mid-East Distributor Operations**

Contact your local distributor or call  
+44 118 945 7360

**France**

Symbol Technologies France  
Centre d'Affaire d'Antony  
3 Rue de la Renaissance  
92184 Antony Cedex, France  
01-40-96-52-21 (Inside France)  
+33-1-40-96-52-50 (Outside France)



**Germany/Deutschland**

Symbol Technologies GmbH  
Waldstrasse 66  
D-63128 Dietzenbach, Germany  
6074-49020 (Inside Germany)  
+49-6074-49020 (Outside Germany)

**Latin America Sales Support**

2730 University Dr.  
Coral Springs, FL 33065 USA  
1-800-347-0178 (Inside United States)  
+1-954-255-2610 (Outside United States)  
954-340-9454 (Fax)

**Netherlands/Nederland**

Symbol Technologies  
Kerkplein 2, 7051 CX  
Postbus 24 7050 AA  
Varsseveld, Netherlands  
315-271700 (Inside Netherlands)  
+31-315-271700 (Outside Netherlands)

**South Africa**

Symbol Technologies Africa Inc.  
Block B2  
Rutherford Estate  
1 Scott Street  
Waverly 2090 Johannesburg  
Republic of South Africa  
11-809 5311 (Inside South Africa)  
+27-11-809 5311 (Outside South Africa)

**Italy/Italia**

Symbol Technologies Italia S.R.L.  
Via Cristoforo Colombo, 49  
20090 Trezzano S/N Navigilo  
Milano, Italy  
2-484441 (Inside Italy)  
+39-02-484441 (Outside Italy)

**Mexico/México**

Symbol Technologies Mexico Ltd.  
Torre Picasso  
Boulevard Manuel Avila Camacho No 88  
Lomas de Chapultepec CP 11000  
Mexico City, DF, Mexico  
5-520-1835 (Inside Mexico)  
+52-5-520-1835 (Outside Mexico)

**Norway/Norge**

Symbol's registered and mailing address:  
Symbol Technologies Norway  
Hoybratenveien 35 C  
N-1055 OSLO, Norway

Symbol's repair depot and shipping address:  
Symbol Technologies Norway  
Enebakkveien 123  
N-0680 OSLO, Norway

+47 2232 4375

**Spain/España**

Symbol Technologies S.L.  
C/ Peonias, 2  
Edificio Piovera Azul  
28042 Madrid, Spain  
91 324 40 00 (Inside Spain)  
+34 91 324 40 00 (Outside Spain)

**Sweden/Sverige**

“Letter” address:

Symbol Technologies AB

Box 1354

S-171 26 SOLNA

Sweden

Visit/shipping address:

Symbol Technologies AB

Solna Strandväg 78

S-171 54 SOLNA

Sweden

Switchboard: 08 445 29 00 (domestic)

Call Center: +46 8 445 29 29 (international)

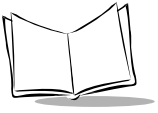
Support E-Mail:

Sweden.Support@se.symbol.com

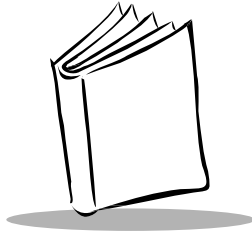
<sup>1</sup>Customer support is available 24 hours a day, 7 days a week.

If you purchased your Symbol product from a Symbol Business Partner, contact that Business Partner for service.

For the latest version of this guide go to:<http://www.symbol.com/manuals>.



*PDT 8000 Series Product Reference Guide*



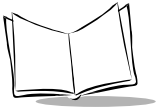
# Chapter 1

## Getting Started

### Chapter Contents

---

Introduction . . . . .	1-3
Unpacking the Terminal . . . . .	1-3
Parts of the Terminal . . . . .	1-4
Accessories . . . . .	1-6
Installing Batteries . . . . .	1-8
Charging the Terminal Battery . . . . .	1-9
Using the Serial Charging Cable . . . . .	1-10
Using the Snap-On Modem Module . . . . .	1-11
Using the Snap-On Autocharger . . . . .	1-12
Using the Magnetic Stripe Reader . . . . .	1-13
Using the Single-Slot Cradle . . . . .	1-14
Using the Four-Slot Cradle . . . . .	1-15
Using the Vehicle Cradle . . . . .	1-17
Charging Spare Batteries . . . . .	1-18
Using the Single-Slot Cradles . . . . .	1-18
Using the Four-Slot Cradles . . . . .	1-19
Using the Vehicle Cradle . . . . .	1-20
Using the UBC Battery Adapter . . . . .	1-21
Charge LED Indicator . . . . .	1-22
Installing a SIM Card . . . . .	1-24
Inserting a Compact Flash Storage Card . . . . .	1-24
Inserting an MMC/SD Storage Card . . . . .	1-26
Replacing the S24 Wireless Networker Card . . . . .	1-27
Replacing the Handstrap . . . . .	1-29
Starting the Terminal . . . . .	1-31
Aligning the Screen . . . . .	1-31



*PDT 8000 Series Product Reference Guide*

Setting Time and Date . . . . .	1-33
Configuring Wake-ups . . . . .	1-34
Checking Battery Power . . . . .	1-35
Power Management . . . . .	1-35
Low Battery Capacity . . . . .	1-35
Critical Low Battery During Suspend . . . . .	1-36
Battery Pull . . . . .	1-36
Setting Up Your Terminal . . . . .	1-37



## Introduction

---

This chapter explains the physical buttons and controls on your terminal, how to install and charge the batteries, install the SIM card, insert and remove a compact flash card, insert and remove the MMC/SD card, replace the S24 wireless network card, replace the handstrap and start your terminal for the first time.

## Unpacking the Terminal

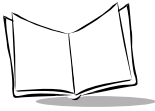
---

Carefully remove all protective material from around the terminal and save the shipping container for later storage and shipping.

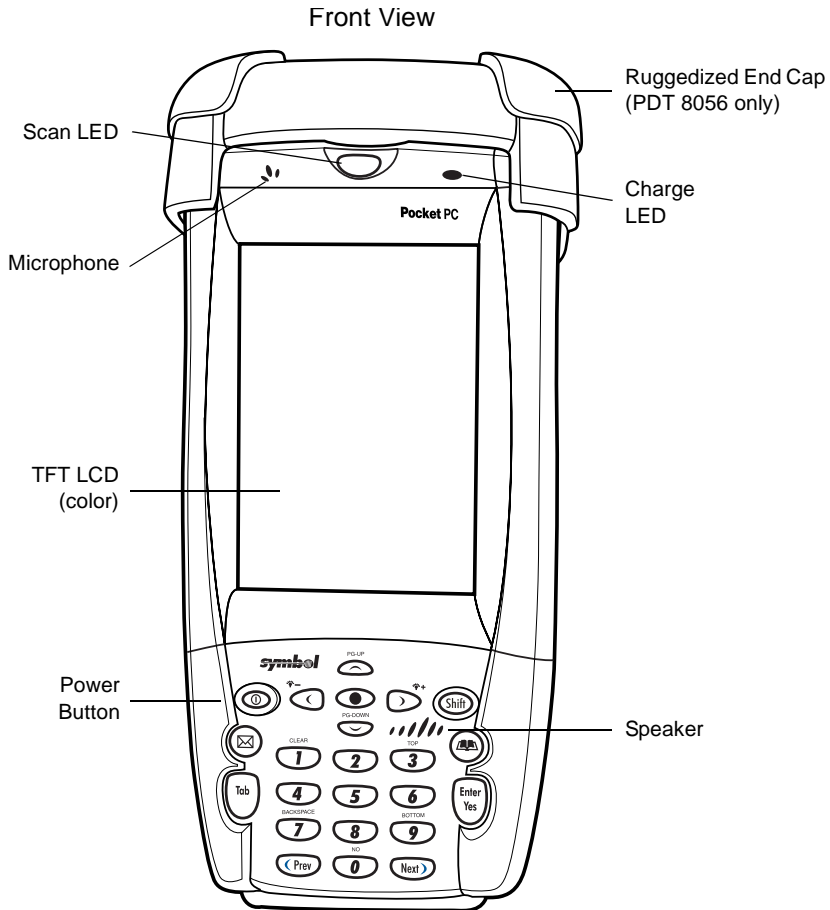
Verify that you received all equipment listed below:

- a terminal
- a lithium-ion battery
- a handstrap, attached to the terminal
- a stylus
- a *Quick Reference Guide* for the terminal.

Inspect the equipment for damage. If you are missing any equipment or if you find any damaged equipment, contact the Symbol Technologies Support Center immediately. See [page xvi](#) for contact information.



## Parts of the Terminal



**Figure 1-1. Front View**

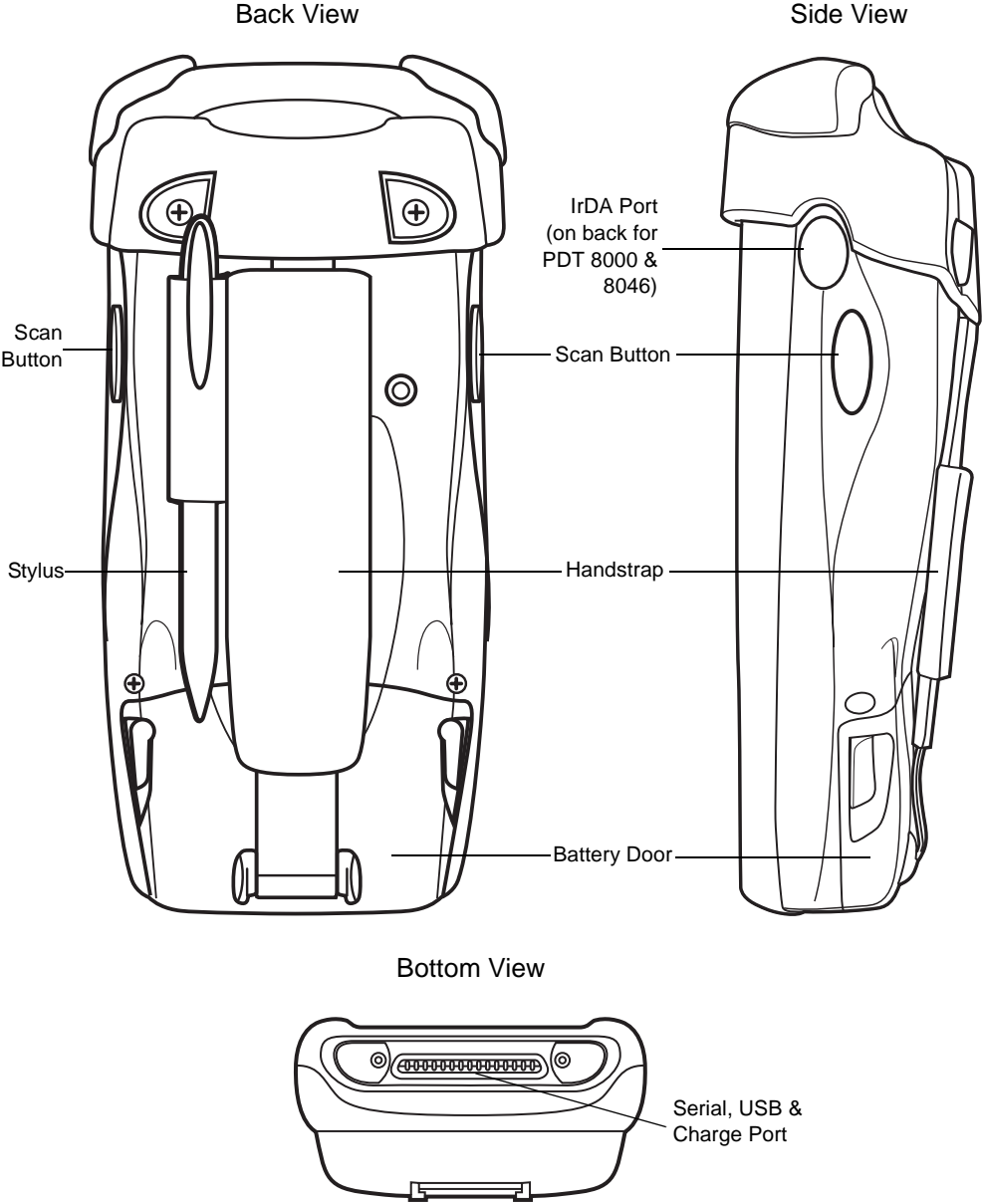


Figure 1-2. Back, Side & Bottom Views

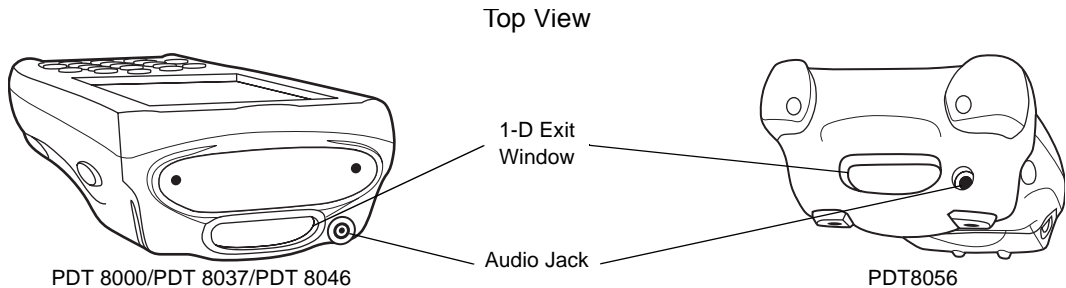
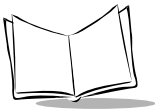


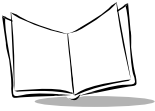
Figure 1-3. Top View

## Accessories

---

- **Additional lithium-ion Battery** (p/n 21-54882-01)
- **Stylus** (p/n 11-55475-05): for performing pen functions
- **Cables:**
  - **Serial Charging Cable** (p/n 25-55853-01): allows serial connection of the terminal to a host computer.
  - **USB Cable** (p/n 25-59272-01): allows USB connection of the terminal to a host computer.
  - **Snap-On DEX Cable** (p/n CBL-8000-100-DEX): connects the terminal to a vending machine.
  - **Snap-On Autocharger** (p/n VCA8000-01): connects to the cigarette lighter in a vehicle to charge the terminal.
  - **Snap-On Printer Cable** (p/n CBL-8000-100-INT1, CBL-8000-100-CTC, CBL-8000-100-PAX, CBL-8000-100-ON1): adds printing capabilities to the terminal.
  - **AC Wall Adapter:** (p/n CBL8000-100U): charges the terminal.
- **Snap-On Modem Module** (p/n MDM8000-xxx): allows dial-up connections of the terminal to a remote host computer, while maintaining the portability of the terminal.
- **Magstripe Reader** (MSR8000-100): snaps on to the terminal to add magstripe capabilities.
- **Single-Slot Serial Cradle** (p/n CRD8000-1000S): charges the terminal and synchronizes the terminal with a host computer through a serial connection.
- **Single-Slot Modem Cradle** (p/n CRD8000-1000M): charges the terminal and synchronizes the terminal with a host computer through a modem connection.

- **Four-Slot Charging Cradle** (p/n CHS8000-4000C): charges the terminal.
- **Four-Slot Charging Cradle with Spare Battery** (p/n CHS8000-4000B): charges the terminal and a spare battery.
- **Four-Slot USB-to-Ethernet Charging Cradle with Spare Battery** (p/n CRD8000-4000E): charges the terminal and synchronizes the terminal with a host computer through an ethernet connection.
- **Vehicle Cradle** (VCD8000-R000): powers and charges the terminal, and can be used to communicate with other devices such as printers.
- **UBC Adapter and Base** (p/n 21-32665-33 and UBC2000-xxxxx): charges up to four spare batteries.
- **Holster** (p/n 11-57530-02): stores the terminal when not in use.
- **Symbol Software Developer's Kit (SDK)** for the PDT 8000 Pocket PC 2002.

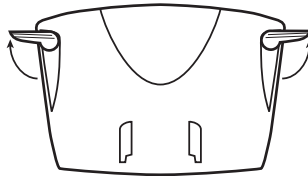


## Installing Batteries

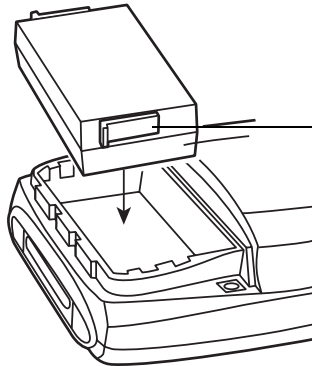
Before using your terminal, install the lithium-ion battery. The battery fits behind the battery door on the back of the terminal.

To install the battery:

1. Rotate the latches on the battery door up and lift the battery door away from the terminal.

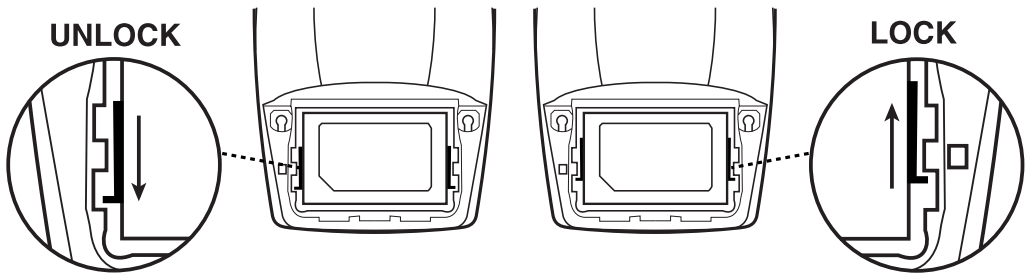


2. Insert the lithium-ion battery into the battery compartment.



Slide the latches on both sides of the battery down, to ensure they are in the unlock position.

3. Lock the battery in place by sliding the latches on the battery up.



4. Replace the battery door, hooking it onto the bottom of the compartment and then pressing down firmly along the top edge while rotating the latches on the battery door down into the locked position.

---

**Note:** *Ensure that the latches on the battery door are in the up position while securing the battery door on the terminal.*

---

### **Caution**

Do not expose the battery to temperatures in excess of 140°F (60°C). Do not disassemble, incinerate, or short circuit the battery.

## **Charging the Terminal Battery**

---

Before using your terminal for the first time, charge the lithium-ion battery in the terminal for approximately four hours, using the Serial Charging Cable or any other appropriate accessory.

---

**Note:** *To ensure the quickest charge time, turn the terminal off while charging.*

---

### **WARNING**

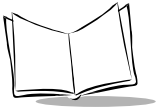
Do not place your terminal into a charging device without a main battery installed. See [Installing Batteries](#) on page 1-8.

Your terminal is equipped with a memory backup battery which automatically charges from the fully-charged lithium-ion battery. This backup battery retains data in memory when the terminal's battery is removed, and can take up to 20 hours to charge when you first use your terminal.

---

**Note:** *If you remove your lithium-ion battery before the backup battery is fully charged, data may be lost. For this reason, DO NOT remove the battery before the backup battery is fully charged, which can take up to 20 hours.*

---

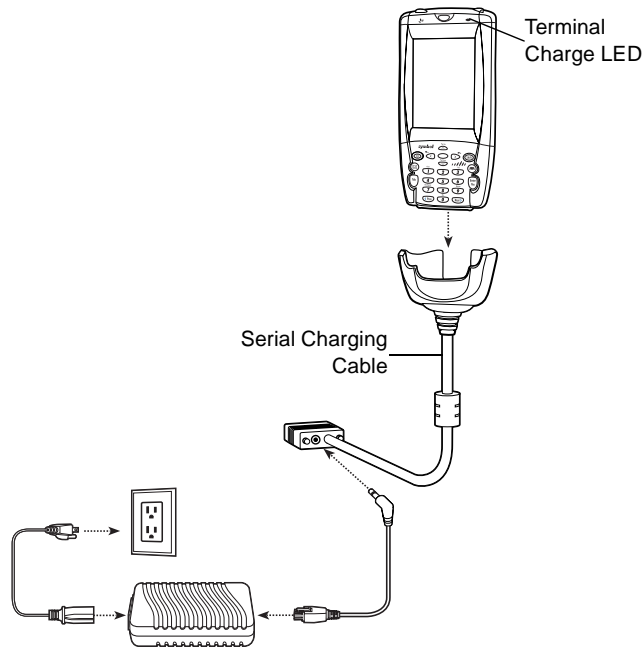


### Caution

It is not recommended to use RF communication when the battery is charging. For communication setup, see [Chapter 9, Spectrum24 Network Configuration](#).

### Using the Serial Charging Cable

To charge the terminal's battery using the Serial Charging Cable, setup as shown below:



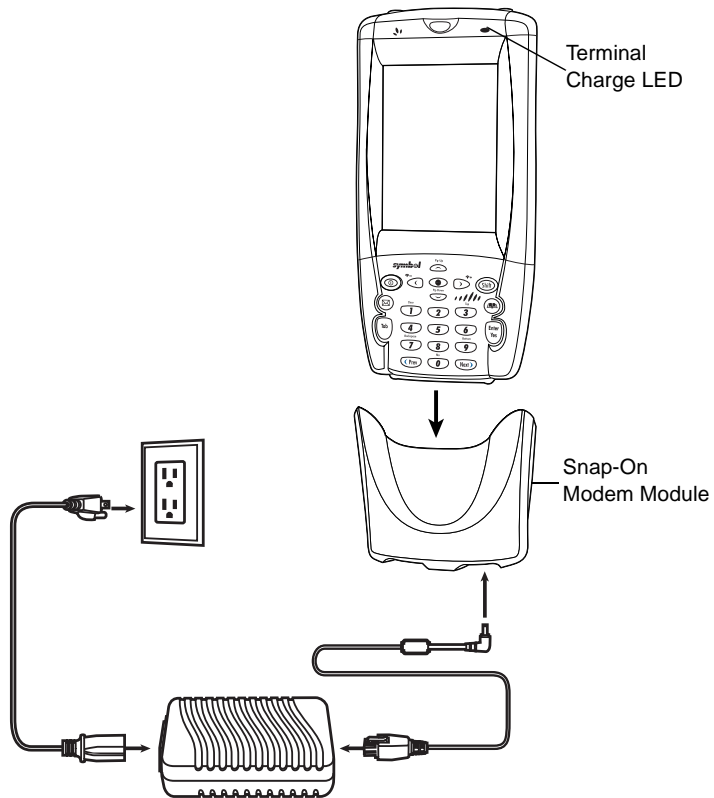
**Figure 1-4. Attaching the Serial Charging Cable to the Terminal**

The terminal charge LED blinks amber to indicate that the terminal battery is charging and turns solid amber when charging is complete. The battery fully charges in less than four hours, if the terminal is not in use. See [Charge LED Indicator](#) on page 1-22 for other indications.



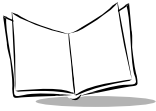
## Using the Snap-On Modem Module

To charge the terminal's battery using the Snap-On Modem Module, setup as shown below:



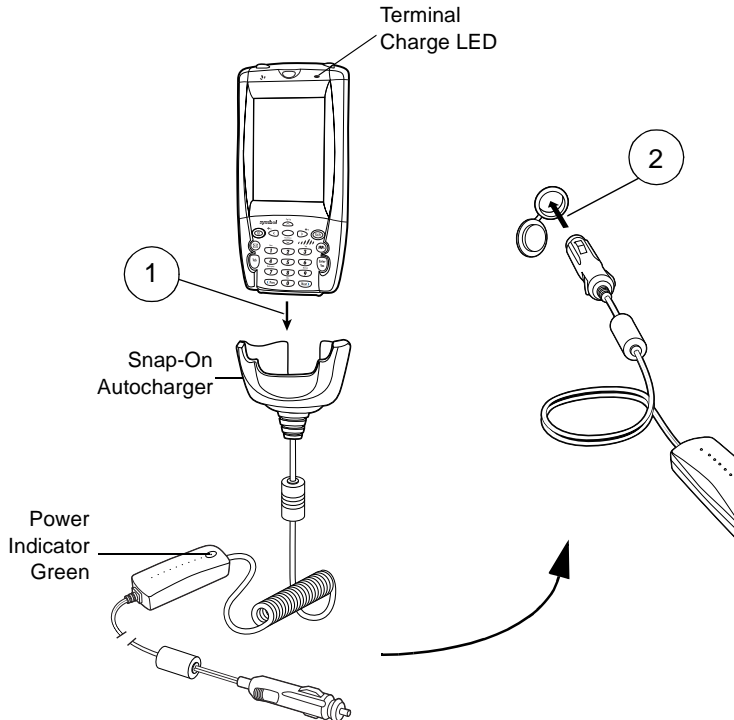
**Figure 1-5. Attaching the Snap-On Modem Module to the Terminal**

The terminal charge LED blinks amber to indicate that the terminal battery is charging and turns solid amber when charging is complete. The battery fully charges in less than four hours, if the terminal is not in use. See [Charge LED Indicator](#) on page 1-22 for other indications.



## Using the Snap-On Autocharger

To charge the terminal's battery using the Snap-On Autocharger, setup as shown below:

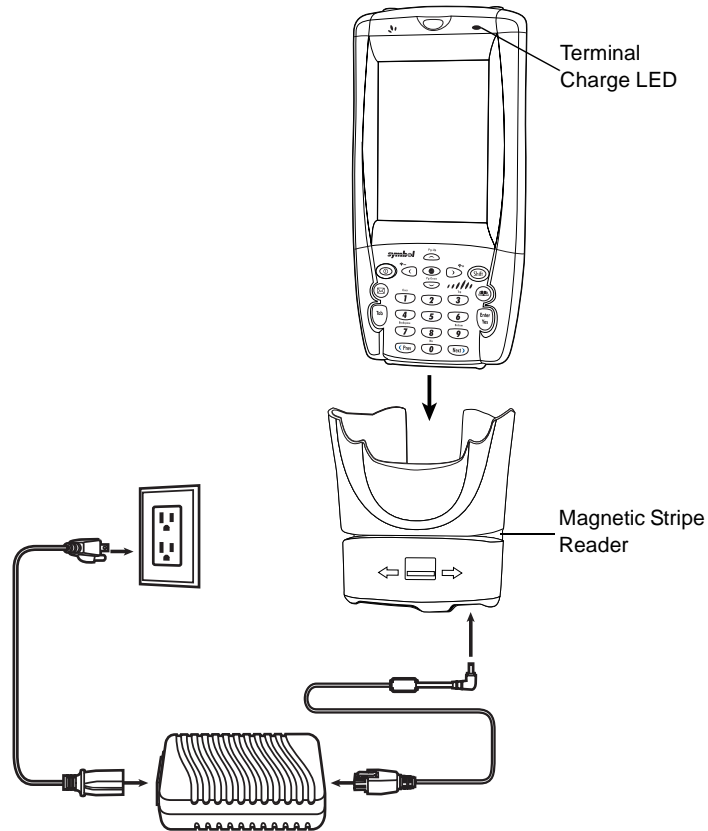


**Figure 1-6. Attaching the Snap-On Autocharger to the Terminal**

The terminal charge LED blinks amber to indicate that the terminal battery is charging and turns solid amber when charging is complete. The battery fully charges in less than four hours, if the terminal is not in use. See [Charge LED Indicator](#) on page 1-22 for other indications.

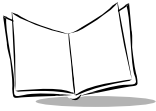
## Using the Magnetic Stripe Reader

To charge the terminal's battery using the Magnetic Stripe Reader, setup as shown below:



**Figure 1-7. Attaching the Magnetic Stripe Reader to the Terminal**

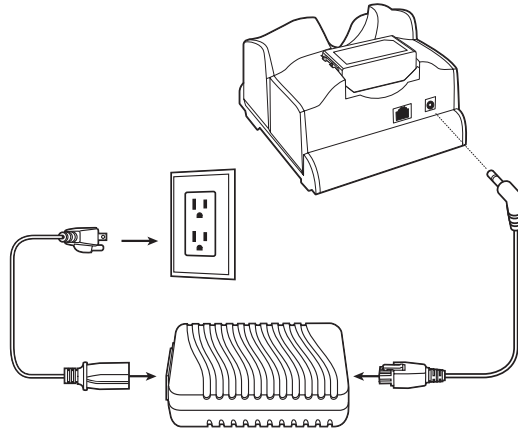
The terminal charge LED blinks amber to indicate that the terminal battery is charging and turns solid amber when charging is complete. The battery fully charges in less than four hours, if the terminal is not in use. See [Charge LED Indicator](#) on page 1-22 for other indications.



## Using the Single-Slot Cradle

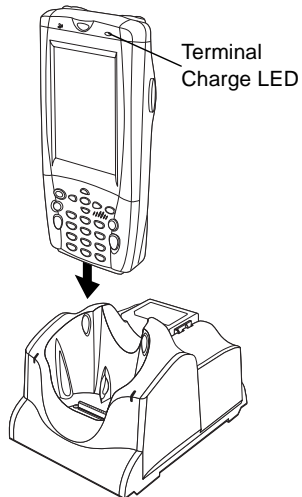
To charge the terminal's battery using the CRD8000-1000S or the CRD8000-1000M:

1. Connect the cradle to a power source.



**Figure 1-8. Single-Slot Power Connection**

2. Insert the terminal into the cradle. The terminal starts to charge automatically.



**Figure 1-9. Inserting the Terminal into the Single-Slot Cradle**

The terminal charge LED blinks amber to indicate that the terminal battery is charging and turns solid amber when charging is complete. The battery fully charges in less than four hours, if the terminal is not in use. See [Charge LED Indicator](#) on page 1-22 for other indications.

## Using the Four-Slot Cradle

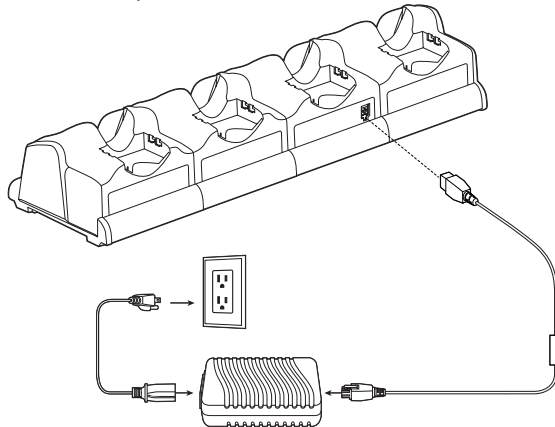
To charge the terminal's battery using the CHS8000-4000C, the CHS8000-4000B or the CRD8000-4000E:

---

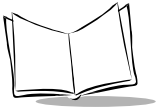
**Note:** *The CRD8000-4000E can only be used with the 128MB RAM configurations.*

---

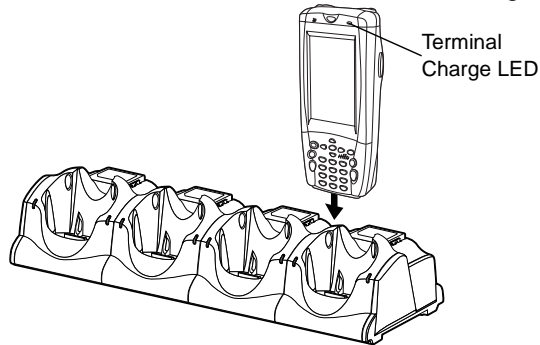
1. Connect the cradle to a power source.



**Figure 1-10. Four-Slot Power Connection**



2. Insert the terminal into the cradle. The terminal starts to charge automatically.



**Figure 1-11. Inserting the Terminal into the Four-Slot Cradle**

The terminal charge LED blinks amber to indicate that the terminal battery is charging and turns solid amber when charging is complete. The battery fully charges in less than four hours, if the terminal is not in use. See [Charge LED Indicator](#) on page 1-22 for other indications.

## Using the Vehicle Cradle

To charge the terminal's battery using the Vehicle Cradle:

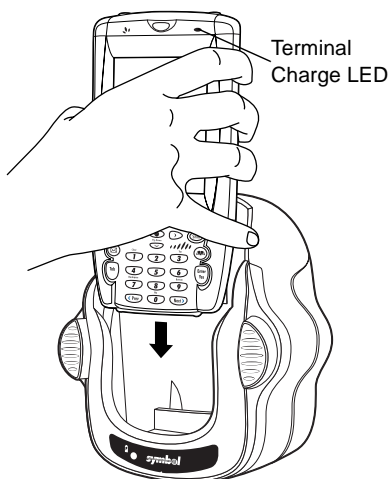
1. Connect the cradle to a power source.

---

**Note:** For detailed instructions on power connection, refer to the VCD8000-R000 Quick Reference Guide.

---

2. Insert the terminal into the cradle. The terminal starts to charge automatically.



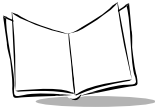
**Figure 1-12. Inserting the Terminal into the Vehicle Cradle**

The terminal charge LED blinks amber to indicate that the terminal battery is charging and turns solid amber when charging is complete. The battery fully charges in less than four hours, if the terminal is not in use. See [Charge LED Indicator](#) on page 1-22 for other indications.

---

**Note:** If the cradle is connected to unswitched power, leaving the terminal in the cradle for an extended period of time will eventually deplete the vehicle battery.

---



## Charging Spare Batteries

---

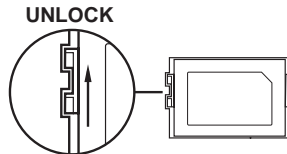
A spare battery can be charged using either of the single-slot cradles (CRD8000-1000S or CRD8000-1000M), the four-slot cradles (CHS8000-4000B or CRD8000-4000E), the vehicle cradle (VCD8000-R000) or the UBC Adaptor (p/n 21-32665-33).

### **Caution**

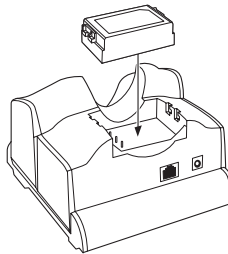
Do not charge a battery that is below 0° C (32° F) or above 45° C (113° F).  
Allow the battery to warm up to room temperature before charging.

### **Using the Single-Slot Cradles**

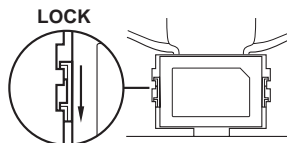
1. Connect the cradle to a power source.
2. Slide the latches on both sides of the battery up, to ensure they are in the unlock position.



3. Insert the battery into the Spare Battery Charging slot on the back of the cradle. Position it with the charging contacts facing down (over charging pins) and gently press down on the battery to ensure proper contact.



4. Lock the battery into place by sliding the latches on the battery down.





The spare battery charging LED on the cradle blinks amber to indicate that the battery is charging and turns solid amber when battery is completely charged. The battery fully charges in less than four hours, if the terminal is not in use. See [Charge LED Indicator](#) on page 1-22 for other indications.

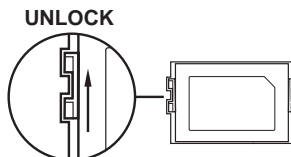
## Using the Four-Slot Cradles

---

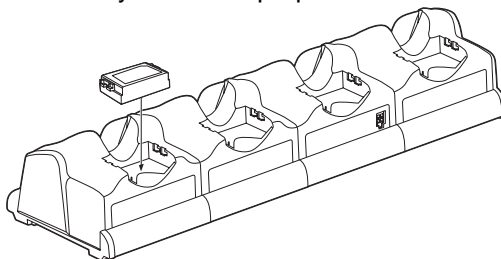
**Note:** *The CRD8000-4000E can only be used with the 128MB RAM configurations.*

---

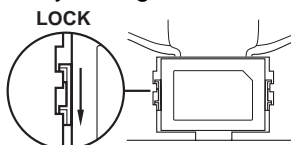
1. Connect the cradle to a power source.
2. Slide the latches on both sides of the battery up, to ensure they are in the unlock position.



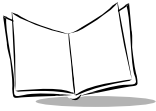
3. Insert the battery into the Spare Battery Charging slot on the back of the cradle. Position it with the charging contacts facing down (over charging pins) and gently press down on the battery to ensure proper contact.



4. Lock the battery into place by sliding the latches on the battery down.

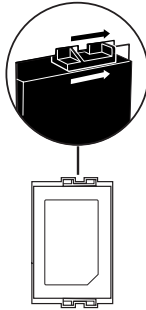


The spare battery charging LED blinks amber to indicate that the battery is charging and turns solid amber when battery is completely charged. The battery fully charges in less than four hours, if the terminal is not in use. See [Charge LED Indicator](#) on page 1-22 for other indications.

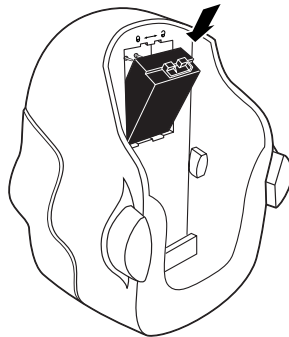


## Using the Vehicle Cradle

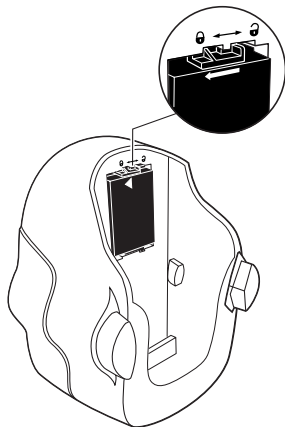
1. Connect the cradle to a power source.
2. Slide the latch on top of the battery to the right, to ensure it is in the unlock position.



3. Insert the battery into the Spare Battery Charging slot on the cradle, as shown below, aligning the charging contacts on the battery with the over charging pins in the slot.



4. Gently press against the battery to ensure proper contact and lock the battery into place, as shown below:



The spare battery charging LED on the cradle blinks amber to indicate that the spare battery is charging and turns solid amber when the battery is completely charged. The battery fully charges in less than four hours, if the terminal is not in use. See [Charge LED Indicator](#) on page 1-22 for other indications.

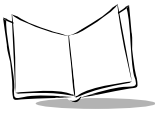
## ***Using the UBC Battery Adapter***

1. Insert the appropriate battery adapter into the charger base.

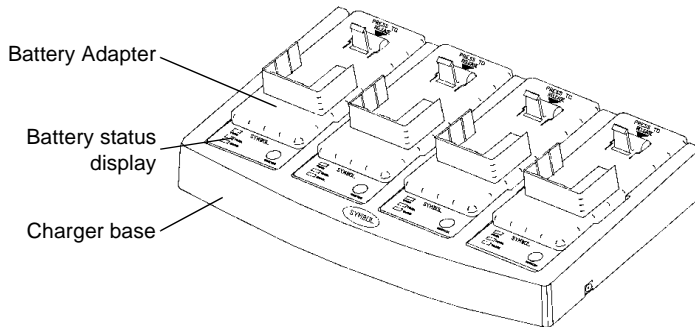
---

**Note:** Refer to the UBC 2000 Universal Battery Charger Product Guide for additional information regarding the charger base.

---



2. Insert the battery into its appropriate adapter. Ensure the polarity markings on the battery (+, -) match with those of the adapter.



**Figure 1-13. Inserting the Spare Battery**

When the battery is inserted, the charging system begins the rapid charge cycle. When this cycle is completed, the "READY" indicator on the battery status display turns solid green, and the battery is charged to approximately 95% of its rated capacity. To attain 100% of its capacity the battery should remain in the charger for 3 hours. A charged battery may be stored in the charger indefinitely. Upon completion of the charging cycle, the charger switches to "Maintenance Mode" where it maintains the battery at 100% of its rated capacity.

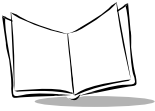
## **Charge LED Indicator**

**Table 1-1. Charge LED Indicator**

LED	Indication
<b>Terminal Charging (LED is on terminal)</b>	
Off	Terminal not in cradle; terminal not placed correctly; cradle is not powered.
Slow blinking amber	Terminal is charging.
Fast blinking amber	Error in charging; check placement of terminal.
Solid amber	Charging is complete.
<b>Spare Battery Charging (LED is on Cradle)</b>	
Off	No spare battery in slot; spare battery not placed correctly; cradle is not powered.

**Table 1-1. Charge LED Indicator**

<b>LED</b>	<b>Indication</b>
Slow blinking amber	Spare battery is charging.
Fast blinking amber	Error in charging; check placement of spare battery.
Solid amber	Charging is complete.



## Installing a SIM Card

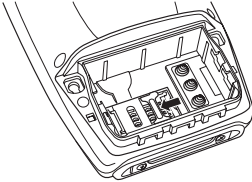
---

**Note:** A SIM card can only be installed in the WAN-enabled terminals, i.e. PDT 8037 and PDT 8056.

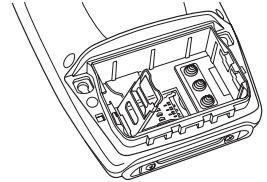
---

1. Slide the latches on the battery door up and lift the battery door away from the terminal. If the battery is installed, remove it (see [Installing Batteries](#) on page 1-8).

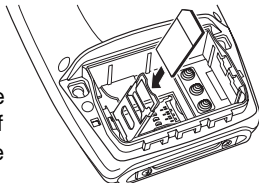
2. Slide the metal clip on the SIM cardholder door to the left to release the SIM cardholder.



3. Lift the cardholder door to an upright position.

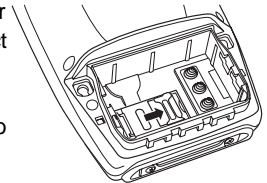


4. Insert the card between the cardholder body and the metal clip; be sure the beveled corner of the SIM card is on the top left.



SIM Card  
Contact Area

5. Close the cardholder door (with the contact area of the card facing down).



6. Slide the metal clip to the right to lock it in place.

7. Reinsert the battery and replace battery door (see [Installing Batteries](#) on page 1-8).

## Inserting a Compact Flash Storage Card

---

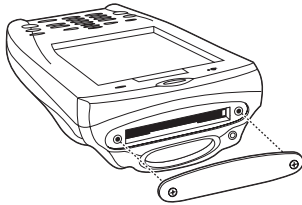
**Note:** A compact flash storage card can be installed in the PDT 8000, PDT 8037 and PDT 8046 only.

---

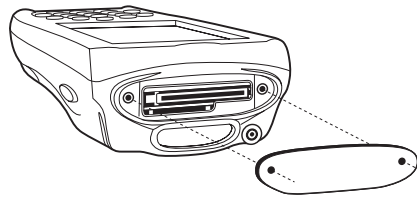
The terminal has a slot for a compact flash storage card which includes a compartment door that prevents the card from coming out if the terminal is dropped.

To insert a compact flash storage card:

1. Unscrew and remove the card compartment door on the top of the terminal.

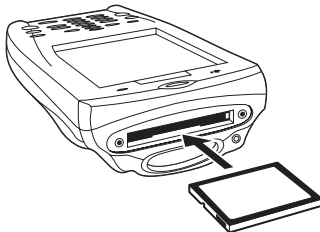


PDT8000, PDT8046

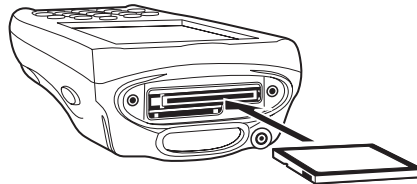


PDT8037

2. Insert a compact flash storage card into the compartment. Ensure the card is pushed in all the way for proper use.



PDT8000, PDT8046

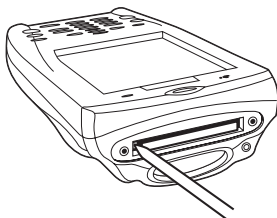


PDT8037

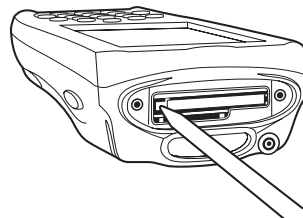
3. Screw the compartment door back on.

To remove a compact flash card:

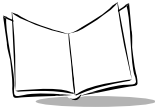
1. Unscrew and remove the card compartment door on the top of the terminal.
2. Use the stylus to press the card release button inside the card compartment. The card pops out.



PDT8000, PDT8046



PDT8037



## Inserting an MMC/SD Storage Card

---

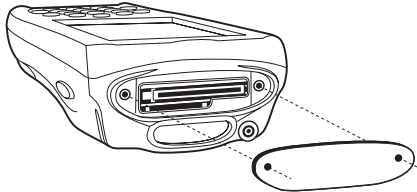
**Note:** A Multi Media Card/Secure Digital (MMC/SD) storage card can only be installed in the WAN-enabled terminals, i.e. PDT 8037 and PDT 8056.

---

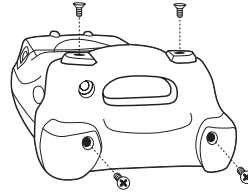
The terminal has a slot for an MMC/SD storage card which includes a compartment door that prevents the card from coming out if the terminal is dropped.

To insert an MMC/SD storage card:

1. Unscrew and remove the card compartment door on the top of the terminal.

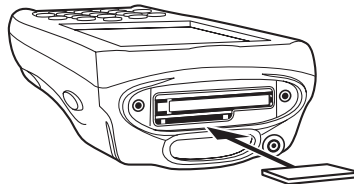


PDT8037



PDT8056

2. Insert a new MMC/SD storage card, with the contacts on the card facing up, into the compartment. Ensure it is fully inserted and locks into place for proper operation.

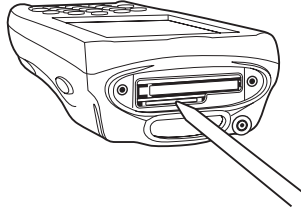


3. Screw the compartment door back on.



To remove an MMC/SD storage card:

1. Unscrew and remove the card compartment door on the top of the terminal.
2. Using the stylus, push against the MMC/SD storage card to activate its spring release mechanism. The card pops out.



## Replacing the S24 Wireless Networker Card

---

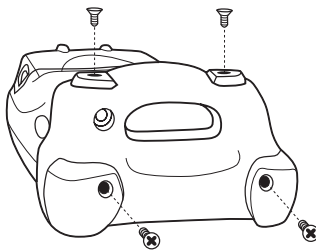
**Note:** A Spectrum 24 (S24) Wireless Networker card can be installed in the PDT 8046 only.

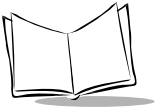
---

The terminal has a factory-installed S24 wireless network card which is used for wireless LAN connectivity. The card may be removed or replaced, if damaged.

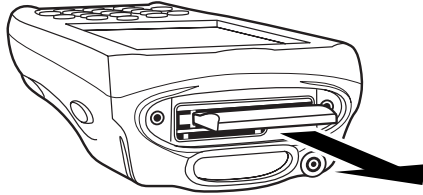
To replace the S24 card:

1. Unscrew and remove the S24 Card cover from the terminal.

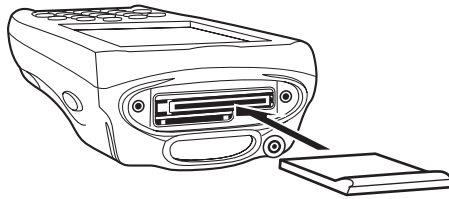




2. Gently pull out the S24 card.



3. Insert the new card.



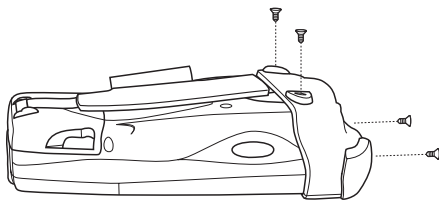
4. Screw the cover back on.
5. Soft reset the terminal, for the card to be functional. See [Performing a Soft Reset](#) on page 2-34.

## Replacing the Handstrap

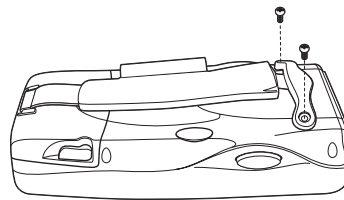
The terminal has a factory-installed handstrap which increases comfort when holding the terminal for extended periods of time. The handstrap may be removed or replaced, if damaged.

To remove the handstrap:

1. Unscrew the end cap/handstrap bar off the terminal.

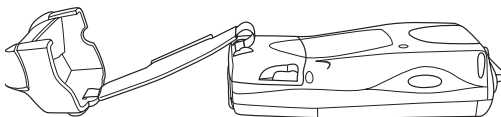


PDT8056

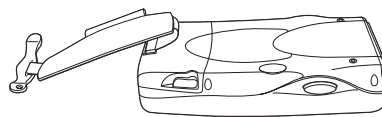


PDT8000, PDT8037, PDT8046

2. Remove the pin that connects the handstrap to the end cap/handstrap bar.

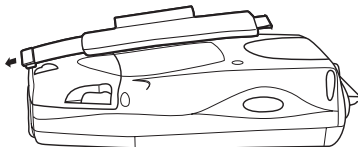


PDT8056

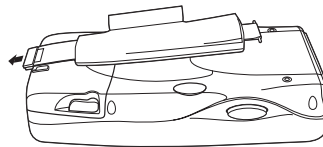


PDT8000, PDT8037, PDT8046

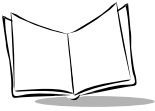
3. Unhook the bottom of the handstrap from it's slot on the battery cover.



PDT8056

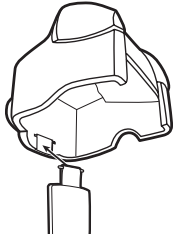


PDT8000, PDT8037, PDT8046



To attach the handstrap:

1. Insert the pin of the handstrap into the end cap/handstrap bar.

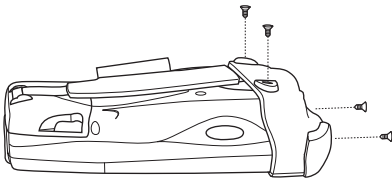


PDT8056

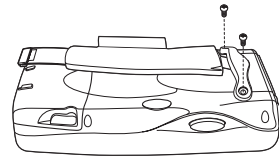


PDT8000, PDT8037, PDT8046

2. Screw the end cap/handstrap bar onto the terminal.

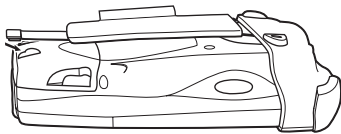


PDT8056

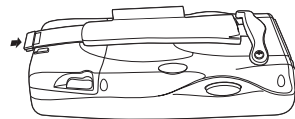


PDT8000, PDT8037, PDT8046

3. Hook the bottom of the handstrap onto the battery cover.



PDT8056

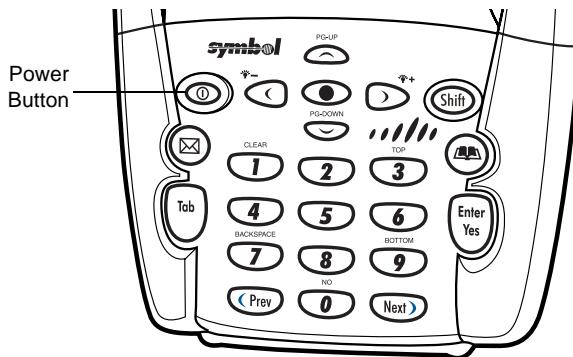


PDT8000, PDT8037, PDT8046

## Starting the Terminal

---

After installing and charging the battery, start the terminal by pressing the red power button (see [Figure 1-14](#)). If the terminal does not power on, reset it. See [Resetting Your Terminal](#) on page 2-34.



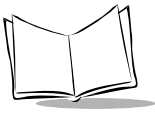
**Figure 1-14. Power Button**

As the terminal initializes its unique Flash File System, the Symbol splash screen displays for about 60 seconds. When the Welcome screen appears, tap anywhere on the screen to continue to the Align screen. Note that these screens also appear every time you perform a hard reset.

### ***Aligning the Screen***

To align your terminal so the cursor on the touch screen aligns with the tip of your stylus:

1. If necessary, adjust the backlight on the terminal so the screen is readable. See [Adjusting the Backlight](#) on page 2-3.
2. Remove the stylus from its storage silo on the handstrap.



3. Tap the center of each target that appears on the screen with the tip of the stylus.

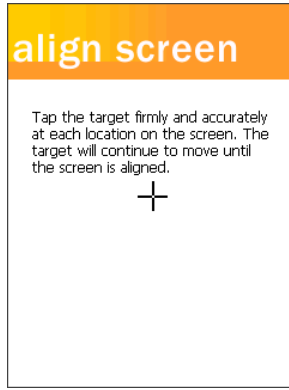


Figure 1-15. Tapping the Target

---

**Note:** To align the screen at anytime, press **Shift + 2** to launch the calibration screen.

---

4. Follow the directions on the screen which lead you through a simple exercise illustrating how to use the stylus and pop-up menus.

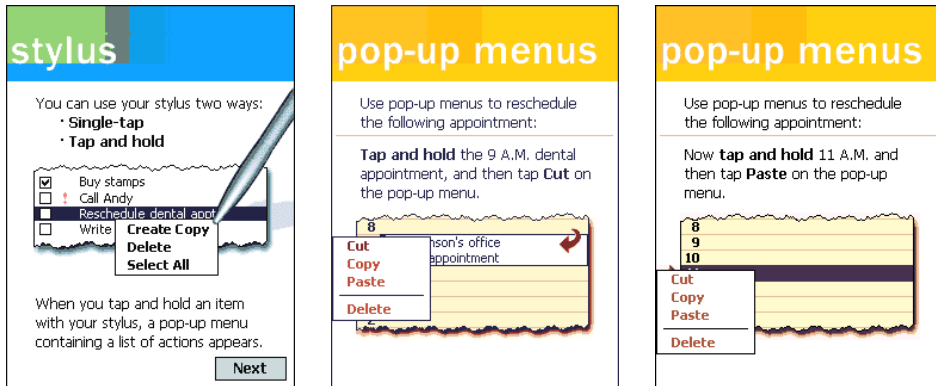
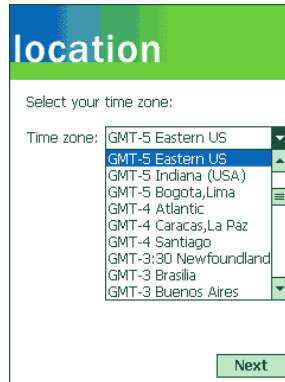


Figure 1-16. Using Pop-up Menus

- Use the drop-down menu to set your time zone, and tap *Next*.



**Figure 1-17. Setting Time Zone on the Terminal**

---

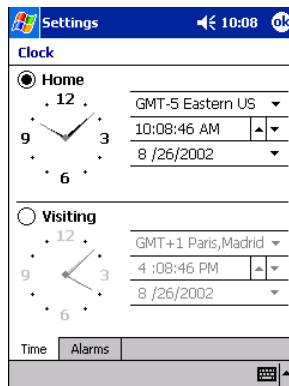
**Note:** *These initial setup screens appear each time you perform a hard reset.*

---

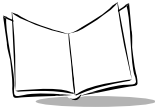
## Setting Time and Date

The Time and Date screen does not appear after setting the time zone.

Tap *Start - Settings - System - Clock* to use the clock control panel applet to set the time and date after a hard reset.



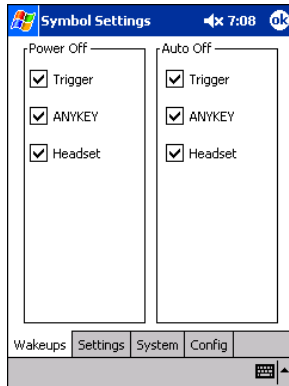
**Figure 1-18. Setting Time and Date**



## Configuring Wake-ups

The terminal can be configured to wake-up by pressing the Trigger key, any key on the keypad, the key on the headset (if available) or by plugging in the headset. To set up this configuration:

1. Tap *Start - Settings - System tab - Symbol Settings*.



**Figure 1-19. Setting Wake-ups**

2. Use the Wakeups tab to configure the wake-up source for the terminal.
  - a. Under Power Off select the items to configure wake-ups when the terminal is powered off.
  - b. Under Auto Off select the items to configure wake-ups when the terminal goes into suspension mode after a set period of time (this time can be set in *Start - Settings - System tab - Power*).

---

**Note:** *The Power button is the only wake-up source for the terminal after the battery door is reinstalled, after a battery fault condition or when the terminal suspends due to very low battery. Once the terminal is resumed with the Power button, all selected wake-up sources can be used, as configured.*

---



## Checking Battery Power

To check whether the main battery or backup battery in the terminal is charged, tap *Start - Settings - System - Power* to display the following Battery Status screen.

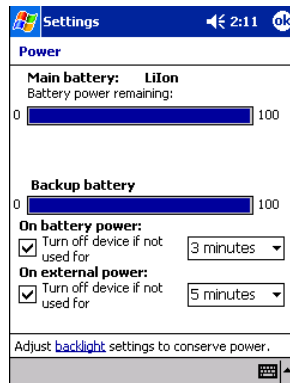


Figure 1-20. Battery Status Screen

To save battery power, set your terminal to turn off after a specified number of minutes on battery power.

### Power Management

When using the GPRS/GSM modem to establish a GPRS/GSM connection (see [Chapter 10, \*Wireless Wide Area Network Configuration\*](#)), there are three power conditions that result in the system or serial driver removing power from the modem asynchronously from the application.

#### Low Battery Capacity

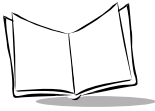
After the modem has been powered up, power will be removed from the modem when the battery reaches a low capacity threshold, before the critical low battery event.

The minimal operating battery capacity values will be kept in a registry key. This value will be expressed in battery capacity percent.

```

;
; Minimal Battery Capacity to Allow G18 Operation Expressed in % of capacity
; G18 is shut off when battery capacity falls below this value
;
"MinG18OperationalCapacity"=dword:14 ;0x14 = 20%

```



The control of the function to display a message box on low battery capacity shutdown and the text for the message are kept in a registry keys.

```
;
; Display message when radio shut off due to low battery capacity
;
; 0 = disable low capacity shut off message
; 1 = enable low capacity shut off message
;
"DisplayLowCapacityShutOffMsg"=dword:1
"LowCapacityShutOffText"="The modem has been shut down due to low battery capacity"
```

After the serial driver has turned off the modem, due to low battery capacity, all subsequent serial port calls, except for the port close, will return an error and set last error to LH1\_WAN\_BATTERY\_LOW 0xA0000100.

## Critical Low Battery During Suspend

When a critical low battery condition occurs while the terminal is suspended with the modem powered the Power Micro/Battery Driver will remove power from the modem.

Upon resume the serial driver checks if power has been removed from the modem. If power has been removed from the modem, all subsequent serial port calls, except for a port close, will return an error and set last error to LH1\_WAN\_BATTERY\_LOW 0xA0000100.

## Battery Pull

After the modem has been powered up, a battery removal or battery door open will cause power to be removed from the modem. The serial driver monitors the battery removal/battery door message event from the Battery Driver and remove the power from the modem.

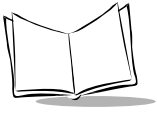
After the battery and/or battery door has been replaced and the terminal resumes, all subsequent serial port calls, except for a port close, will return an error and set last error to LH1\_WAN\_BATTERY\_PULL 0xA0000101.

## Setting Up Your Terminal

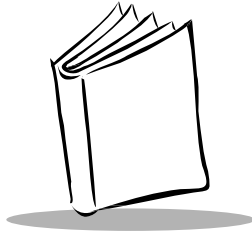
---

Refer to the following chapters for setting up your terminal:

- For customizing the settings on your terminal, see [Chapter 3, \*Customizing the Terminal\*](#).
- To set up ActiveSync to synchronize your terminal with your host computer, see [Chapter 4, \*Communications\*](#).
- To set up AirBEAM to synchronize your terminal with your host server, see [Chapter 8, \*AirBEAM\*](#).
- To configure your terminal for Spectrum24, see [Chapter 9, \*Spectrum24 Network Configuration\*](#).
- To configure your terminal for GSM/GPRS, see [Chapter 10, \*Wireless Wide Area Network Configuration\*](#).
- To install development software on your development PC, see [Chapter 11, \*Software Installation on Development PC\*](#).
- To configure your terminal using the Terminal Configuration Manager, see [Chapter 12, \*Configuring the Terminal\*](#).



*PDT 8000 Series Product Reference Guide*



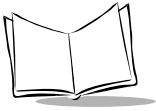
## Chapter 2

# Operating the Terminal

### Chapter Contents

---

Introduction . . . . .	2-3
Using the Power Button . . . . .	2-3
Adjusting the Backlight . . . . .	2-3
Using the Stylus . . . . .	2-3
Using a Headset . . . . .	2-4
Using the Keyboard . . . . .	2-5
Terminal Keyboard . . . . .	2-5
Today Screen . . . . .	2-7
Using the Navigation Bar and Command Bar . . . . .	2-8
Status Icons . . . . .	2-9
Selecting Programs . . . . .	2-10
Using Pop-up Menus . . . . .	2-11
Notifications . . . . .	2-12
Entering Information . . . . .	2-12
Entering Information Using the Input Panel . . . . .	2-12
Using the Soft Keyboard . . . . .	2-14
Using the Block Recognizer . . . . .	2-14
Using the Letter Recognizer . . . . .	2-15
Using the Transcriber . . . . .	2-15
Writing on the Screen . . . . .	2-16
Converting Writing to Text . . . . .	2-17
Writing Tips . . . . .	2-18
Selecting Text . . . . .	2-19
Selecting Writing . . . . .	2-19
Drawing on the Screen . . . . .	2-20
Selecting a Drawing . . . . .	2-20



Recording a Message .....	2-21
Entering Data via the Bar Code Scanner (Scan Wedge) .....	2-21
Using My Text .....	2-22
Finding Information .....	2-22
Making a Phone Call (PDT 8037/8056 only) .....	2-24
GSM Demo Installation .....	2-24
GSM Demo Configuration .....	2-24
Phone Call .....	2-27
Sending and Receiving SMS Messages (PDT 8037/8056 only) .....	2-29
GSM Demo Installation .....	2-29
GSM Demo Configuration .....	2-30
SMS Messaging .....	2-32
Scanning .....	2-33
Scan LED Indicator .....	2-34
Resetting Your Terminal .....	2-34
Performing a Soft Reset .....	2-34
Performing a Hard Reset .....	2-35

## Introduction

---

This chapter provides basic instructions for using and navigating the terminal.

## Using the Power Button

---

Press the power button on the top left-hand side of the terminal to turn the terminal on and off. See [Starting the Terminal](#) on page 1-31.

## Adjusting the Backlight

---

Use the key combinations below to decrease and increase the backlight.

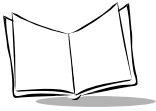
Keys	Description
Shift + App Key 2 or 3	Turn backlight on or off.
Shift + Left Arrow	Decrease backlight (decrease brightness)
Shift + Right Arrow	Increase backlight (increase brightness)

## Using the Stylus

---

The terminal has a stylus for selecting items and entering information. The stylus functions as a mouse.

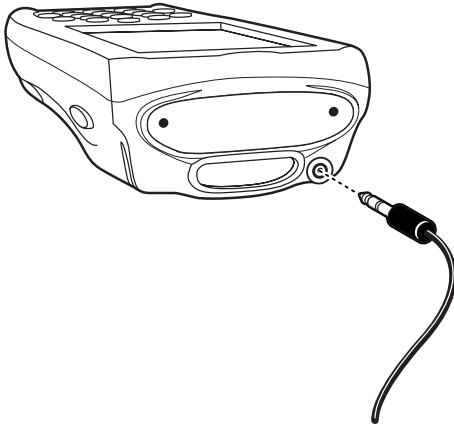
- **Tap:** Touch the screen once with the stylus to open items and select options.
- **Drag:** Hold the stylus on the screen and drag across the screen to select text and images. Drag in a list to select multiple items.
- **Tap-and-hold:** Tap and hold the stylus on an item to see a list of actions available for that item. On the pop-up menu that appears, tap the action you want to perform.



## Using a Headset

---

Your terminal is equipped with an audio connector which can be connected to a headset. To use the headset, plug the headset jack into the audio connector on the top of the terminal.



PDT8000, PDT8037, PDT8046



PDT8056

**Figure 2-1. Using a Headset**

For the 64MB RAM configuration, use only a stereo headset. For the 128MB RAM configuration, use only an earphone and microphone headset.

---

**Note:** For WAN-enabled terminals, GSM voice communication is only available through the headset. For these terminals, Symbol recommends a 2.5mm jack headset, p/n 50-11300-050.

---



## Using the Keyboard

Refer to [Table 2-1](#) on page 2-6, for key functionality. Note that key functions can be changed by an application. Your keyboard may not function exactly as described in these tables.

**Note:** For detailed keyboard configurations including ASCII values and VK codes, see [Appendix E, Keyboard Maps](#).

For information about using the *soft* keyboard from the input panel, see [Using the Soft Keyboard](#) on page 2-14.

### Terminal Keyboard

The keyboard uses a numeric keypad that produces the numbers (0-9) and assorted functions. The keyboard is color-coded to indicate particular actions that are produced when the modifier (**Shift**) key is pressed. The keyboard default is numeric, producing numbers.

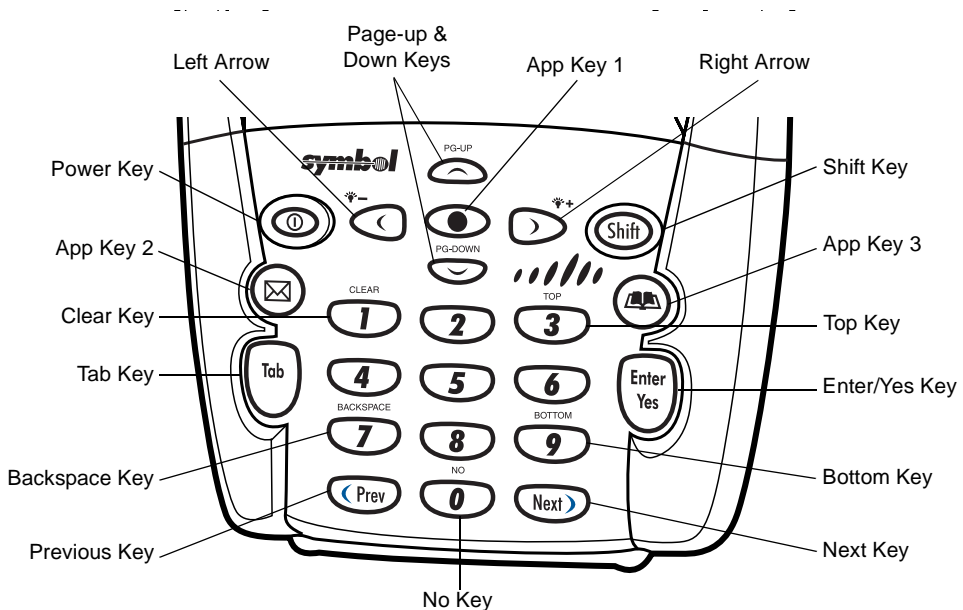
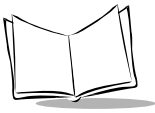


Figure 2-2. Terminal Keyboard



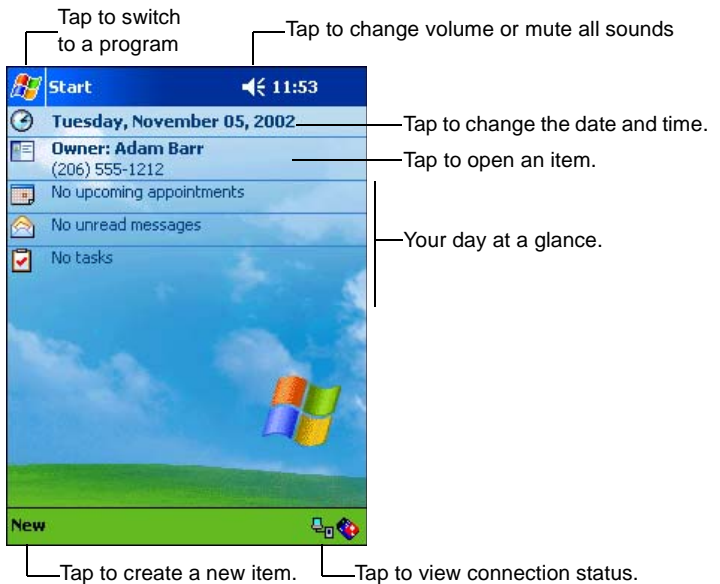
**Table 2-1. Keyboard Actions**

<b>Key</b>	<b>Action</b>
Backspace	Press <b>Shift + 7</b> to erase information entered on the display, one character at a time.
Bottom	Press <b>Shift + 9</b> . Action is application dependent.
Clear	Press <b>Shift + 1</b> . Action is application dependent.
Enter/Yes	Press <b>Enter</b> after entering data or a command.
Left Arrow	See <a href="#">Adjusting the Backlight</a> on page 2-3.
Next	Action is application dependent.
No	Press <b>Shift + 0</b> . Action is application dependent.
Page-up and Down	Press <b>Shift + Up Arrow</b> . Action is application dependent. Press <b>Shift + Down Arrow</b> . Action is application dependent.
App Key 1	Key can be assigned to an application program. See <a href="#">Assigning Applications to Application Buttons</a> on page 3-7 for default settings.
App Key 2	Key can be assigned to an application program. See <a href="#">Assigning Applications to Application Buttons</a> on page 3-7 for default settings.
App Key 3	Key can be assigned to an application program. See <a href="#">Assigning Applications to Application Buttons</a> on page 3-7 for default settings.
Power	Press <b>Power</b> to suspend/resume the terminal. See <a href="#">Starting the Terminal</a> on page 1-31.
Previous	Action is application dependent.
Right Arrow	See <a href="#">Adjusting the Backlight</a> on page 2-3.
Shift	Press the <b>Shift</b> key, then another key to produce the function above that key. See individual key descriptions in this table for additional <b>Shift</b> key usage.
Tab	Press <b>Tab</b> to move from field to field.
Top	Press <b>Shift + 3</b> . Action is application dependent.

## Today Screen

---

When you turn on your terminal for the first time each day (or after 4 hours of inactivity), the Today screen appears. You can also display it by tapping *Start - Today*. On the Today screen, you can see important information for the day.



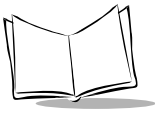
**Figure 2-3. Today Screen**

---

**Note:** *The Today Screen may vary depending on your terminal configuration.*

---

The Today Screen is customizable. Tap *Start - Settings - Today*. Use the Appearance tab to customize the background and the Items tab to change the list and order of items that appear on the screen.



## Using the Navigation Bar and Command Bar

The navigation bar at the top of the screen displays the active program and current time, and allows you to select programs and close screens.

Use the command bar at the bottom of the screen to perform tasks in programs. The command bar includes menu names, buttons and the input panel button. To create a new item in the current program, tap *New*. To see the name of a button, hold the stylus on the button. Drag the stylus off the button so the command is not carried out.

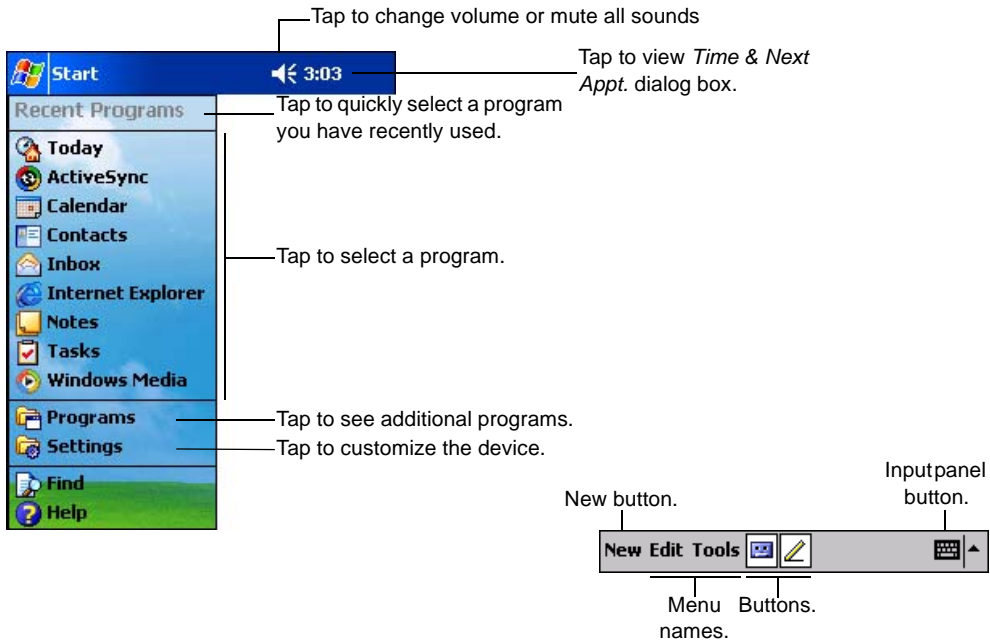













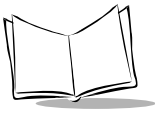
Figure 2-4. Screen Navigation

## Status Icons

You may see the following status icons on the navigation or command bar:

**Table 2-2. Status Icons**

Icon	Meaning
	Turns all sounds on and off.
	Backup battery is low.
	Main batteries are charging (appears on the <i>Time &amp; Next Appt.</i> dialog box).
	Main batteries are low.
	Main batteries are very low.
	Main batteries are full (appears on the <i>Time &amp; Next Appt.</i> dialog box).
	Connection is active.
	Synchronization is beginning or ending.
	Notification that one or more instant messages were received.
	Notification that one or more e-mail messages were received.
	There are more notification icons than can be displayed. Tap to display remaining icons.



## Selecting Programs

---

To select a program, tap *Start - Programs*, then the program name. (To select which programs appear on the *Program* menu, see [Chapter 3, Customizing the Terminal.](#))

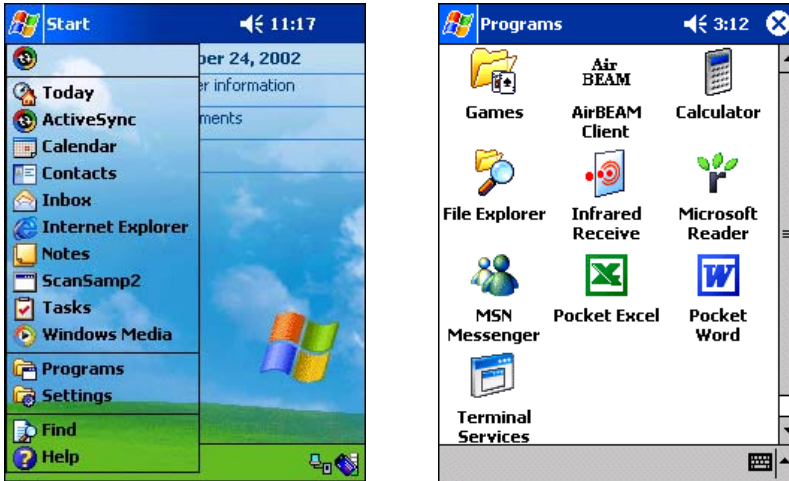


Figure 2-5. Start Menu

---

**Note:** Some programs have abbreviated labels for check boxes and drop-down menus. To see the full label, hold the stylus on the label. Drag the stylus off the label so that the command is not carried out.

---

## Using Pop-up Menus

With pop-up menus, you can quickly choose an action for an item. For example, use the pop-up menu in the contact list to delete a contact, make a copy of a contact, or send an e-mail message to a contact. The actions in the pop-up menus vary from program to program.

To access a pop-up menu, hold the stylus on the item you want to perform the action on. When the menu appears, lift the stylus, and tap the action to perform, or tap outside the menu to close it without performing an action.

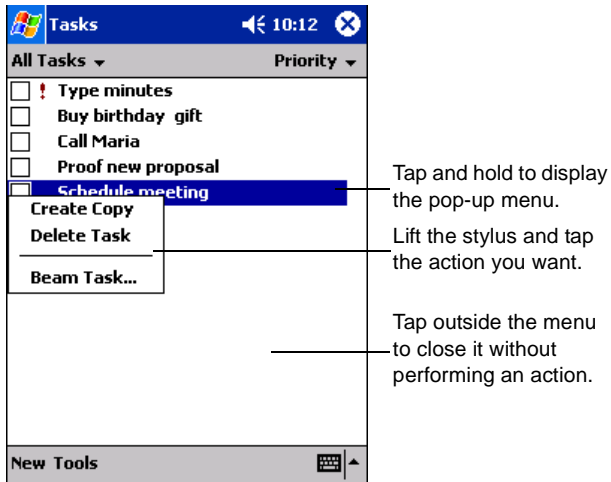
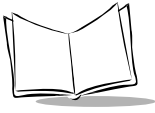


Figure 2-6. Pop-up Menu



## Notifications

---

The terminal notifies you when you have something to do. For example, if you've set up an appointment in Calendar, a task with a due date in Tasks, or an alarm in Clock, you'll be notified in any of the following ways:

- a message box appears on the screen
- a sound, which you can set, is played
- a light flashes on your terminal.

To choose reminder types and sounds for your terminal, tap *Start - Settings - Personal* tab - *Sounds & Notifications*. Select the desired options.

## Entering Information

---

To enter information, you may:

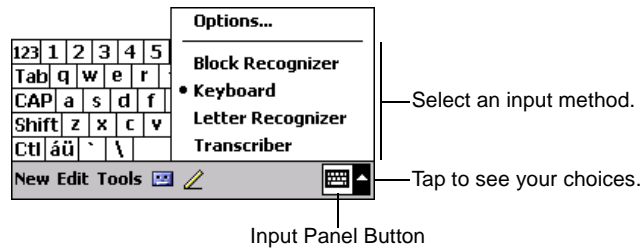
- Use the keyboard. (See [Using the Keyboard](#) on page 2-5 and [Appendix E, Keyboard Maps](#) for keyboard functions.)
- Use the input panel to enter typed text, either using the soft keyboard or writing characters.
- Write directly on the screen.
- Draw pictures on the screen.
- Speak into the microphone to record a message.
- Scan bar code data into data fields.
- Use Microsoft® ActiveSync® to synchronize or copy information from your host computer to your terminal. For more information on ActiveSync, see [Chapter 4, Communications](#) or ActiveSync Help on your host computer.

### ***Entering Information Using the Input Panel***

Use the input panel to enter information in any program. You can either type using the soft keyboard or write using Block Recognizer, Letter Recognizer, or Transcriber. In any case, the characters appear as typed text on the screen.



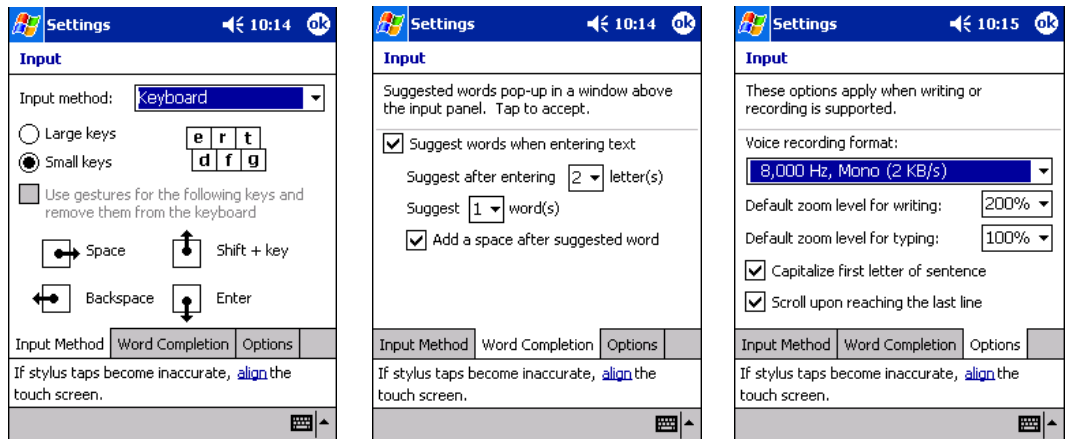
To show or hide the input panel, tap the Input Panel button. Tap the arrow next to this button to view input methods.



**Figure 2-7. Input Panel Button**

When you use the input panel, your terminal anticipates the word you are typing or writing and displays it above the input panel. When you tap the displayed word, it is inserted into your text at the insertion point. The more you use your terminal, the more words it learns to anticipate.

To change input settings, such as the number of words suggested at one time, tap *Options* from the Input Panel menu, and tap the tabs to see each setting screen.

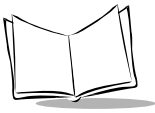


**Figure 2-8. Input Panel Options**

---

**Note:** *Input panel options may vary depending on the input method that is selected in the Input Method tab.*

---



## Using the Soft Keyboard

To type with the soft keyboard:

1. Tap the arrow next to the Input Panel button, then *Keyboard*.
2. On the soft keyboard, tap the keys with your stylus.

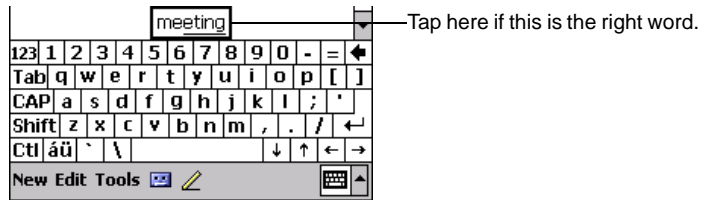


Figure 2-9. Soft Keyboard

## Using the Block Recognizer

To use Block Recognizer:

1. Tap the arrow next to the Input Panel button, then *Block Recognizer*.
2. Write a letter in the left side of the box, or a number in the right side, using special character strokes.

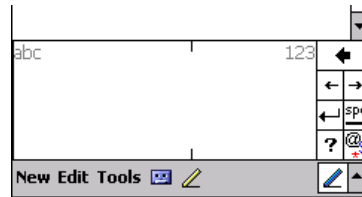


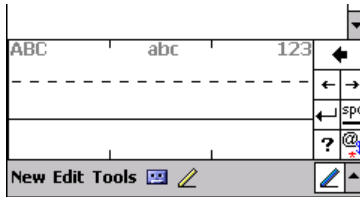
Figure 2-10. Block Recognizer

When you write a letter, it is converted to typed text on the screen. For specific instructions on using Block Recognizer, with Block Recognizer open, tap the question mark next to the writing area, or see [Appendix A, Block Recognizer Characters](#).

## Using the Letter Recognizer

To use Letter Recognizer:

1. Tap the arrow next to the Input Panel button, then *Letter Recognizer*.
2. Write letters or numbers in the writing area, just as you would on paper. Write capital letters in the left side of the box, numbers in the right side and lower case letters in the center.



**Figure 2-11. Letter Recognizer**

When you write a letter, it is converted to typed text on the screen. For instructions on using Letter Recognizer, with Letter Recognizer open, tap the question mark next to the writing area.

## Using the Transcriber

To use Transcriber:

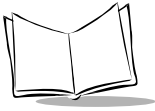
1. Tap the arrow next to the Input Panel button, then *Transcriber*.



**Figure 2-12. Transcriber**

2. Write anywhere on the screen.

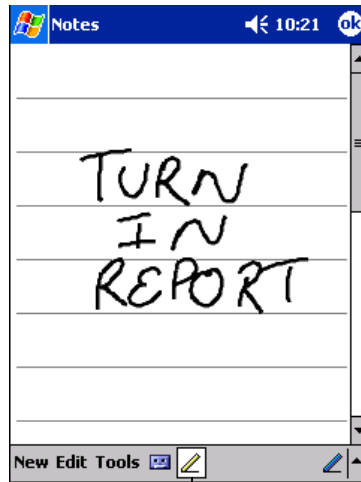
When you write anywhere on the screen, Transcriber changes the written characters to typed characters. For instructions on using Transcriber, with Transcriber open, tap the question mark next to the writing area.



## Writing on the Screen

In any program that accepts writing, such as the Notes program and the *Notes* tab in Calendar, Contacts and Tasks, you can use your stylus to write directly on the screen.

To write on the screen, tap the Pen button to switch to writing mode. Lines appear on the screen to guide you.



Tap the Pen button and use your stylus like a pen.

**Figure 2-13. Writing on the Screen**

---

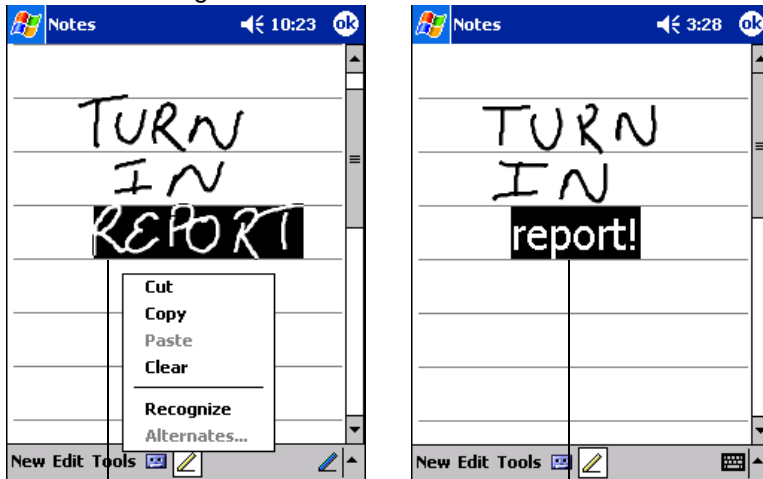
**Note:** Some programs that accept writing do not have the Pen button. See the documentation for that program to find out how to switch to writing mode.

---

## Converting Writing to Text

To convert your writing to text, tap *Tools - Recognize*.

To convert certain words, select them before tapping *Recognize* on the *Tools* menu (or tap and hold the selected words, then tap *Recognize* on the pop-up menu). If a word is not recognized, it is left as writing.

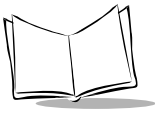


Select the text you want to convert and tap *Recognize* on the pop-up menu.

The writing is turned into text.

**Figure 2-14. Writing on the Screen**

If the conversion is incorrect, select different words from a list of alternates or return to the original writing. Tap and hold the incorrect word only. On the pop-up menu, tap *Alternates*.



A list of alternate words appears. Tap the word you want to use, or tap the writing at the top of the menu to return to the original writing.

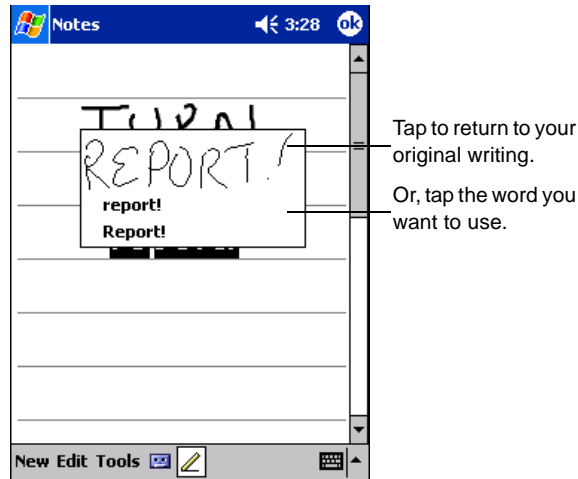


Figure 2-15. Alternate List

## Writing Tips

- Write neatly.
- Write on the lines and draw descenders below the line. Cross of the "t" and write apostrophes below the top line so they are not confused with the word above. Write periods and commas above the line.
- For better recognition, try increasing the zoom level to 300% using the *Tools* menu.
- Leave large gaps between words so your terminal can easily tell where words begin and end.
- Hyphenated words, foreign words that use special characters such as accents, and some punctuation cannot be converted.
- If you add writing to a word to change it (such as changing a "3" to an "8") after you attempt to recognize the word, the writing you add is not included if you try to recognize the writing again.

## Selecting Text

To edit or format typed text, select it by dragging the stylus across the text. Cut, copy and/or paste text by holding the selected words then tapping an editing command on the pop-up menu, or by tapping the command on the *Edit* menu.

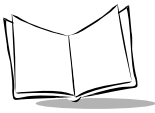
## Selecting Writing

To select writing to edit or format:

1. Tap and hold the stylus next to the text you want to select until the insertion point appears.
2. Drag the stylus across the text.

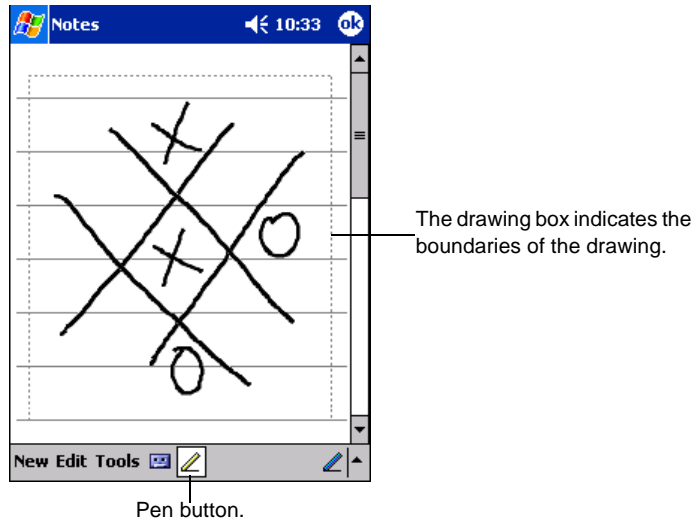
If you accidentally write on the screen, tap *Tools - Undo* and try again. You can also select text by tapping the *Pen* button to deselect it, then dragging the stylus across the screen.

You can cut, copy and paste written text in the same way you work with typed text: tap and hold the selected words, then tap the command from the pop-up menu, or select the command from the *Edit* menu.



## Drawing on the Screen

Drawing on the screen is similar to writing on the screen. To create a drawing, cross three ruled lines on your first stroke. A drawing box appears. Subsequent strokes in or touching the drawing box become part of the drawing. Drawings that do not cross three ruled lines are treated as writing.



**Figure 2-16. Drawing on the Screen**

---

**Note:** To change the zoom level, tap *Tools*, then a zoom level.

---

## Selecting a Drawing

To select a drawing to edit or format, tap and hold the stylus on the drawing until the selection handle appears.

To select multiple drawings, deselect the **Pen** button, then drag to select the drawings you want.

To cut, copy and paste drawings, tap and hold the selected drawing, then tap an editing command on the pop-up menu, or tap the command on the *Edit* menu. To resize a drawing, deselect the **Pen** button and drag a selection handle.

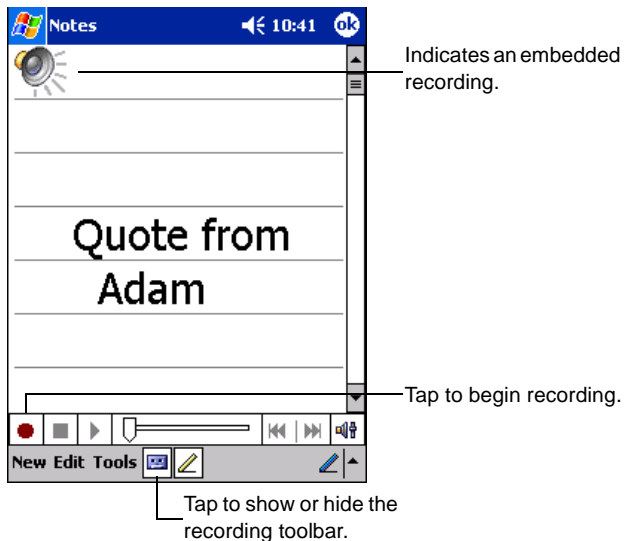


## Recording a Message

You may record a message to capture thoughts, reminders and phone numbers. In Calendar, Tasks and Contacts, you can include a recording in the *Notes* tab. In the Notes program, you can either create a stand-alone recording or include a recording in a written note. To include the recording in a note, open the note first.

To create a recording:

1. Hold the terminal's microphone near your mouth or other source of sound.
2. Start the Notes Application.
3. Tap the Record icon to begin recording.

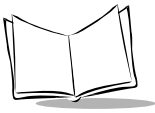


**Figure 2-17. Recording Screen**

4. When you are finished, tap the `STOP` button. The new recording appears in the note list or as an embedded icon.
5. To play a recording, tap it in the list or tap its icon in the note.

## Entering Data via the Bar Code Scanner (Scan Wedge)

Using the Scan Wedge program, the integrated bar code scanner on your terminal can scan data into data fields in the same way data is entered via the keyboard. See [HTML Scan Demo](#) on page B-6 for more information.



## Using My Text

When using Inbox or MSN Messenger, use My Text to quickly insert preset or frequently used messages into the text entry area. To insert a message, tap *My Text* and tap a message.

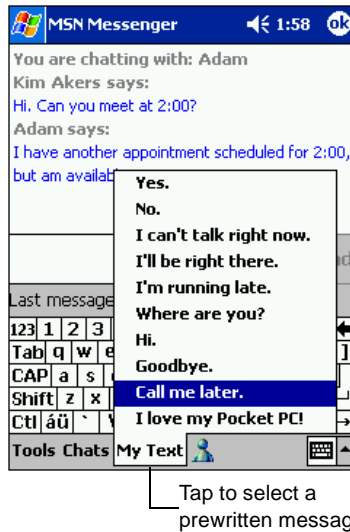


Figure 2-18. Using My Text

---

**Note:** You can add text after inserting a My Text message before sending it.

---

To edit a My Text message, tap *Tools - Edit - My Text Messages*. Select the message you wish to edit and make the changes.

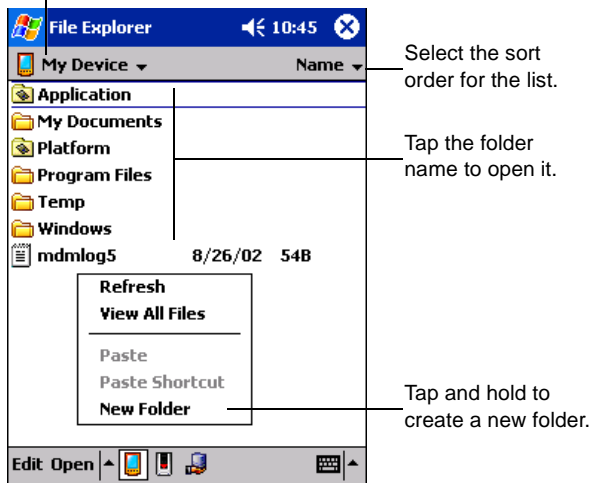
## Finding Information

The Find feature locates information. Tap *Start - Find* to launch this feature. Enter the text you want to find, select a data type, then tap *Go*.

To find information taking up storage space on your terminal, select *Larger than 64 KB* in *Type*.

You can also use the File Explorer to find files and organize them into folders. Tap *Start - Programs - File Explorer* to launch Explorer.

Tap to change folders.

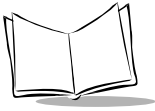


**Figure 2-19. File Explorer**

---

**Note:** To move files in File Explorer, tap and hold the item, then tap Cut or Copy and Paste on the pop-up menu.

---



---

## Making a Phone Call (PDT 8037/8056 only)

---

The PDT 8037 and PDT 8056 terminals have the technology to make and receive phone calls using the GSM Demo application (available at <http://devzone.symbol.com>). To make a phone call you must install and configure the application.

---

**Note:** Before using the terminal as a phone, ensure that a SIM card has been installed. See [Installing a SIM Card](#) on page 1-24 for detailed instructions.

---

### **GSM Demo Installation**

The GSM Demo application allows you to:

- monitor network status (see [Appendix C, GSM Demo Program](#))
- dial and answer voice calls
- send and receive Short Message Service (SMS) text messages (see [Sending and Receiving SMS Messages \(PDT 8037/8056 only\)](#) on page 2-29)
- edit network specific GPRS parameters (see [GPRS Parameters Configuration](#) on page 10-3).

Check the terminal to see if the GSMDemo application is installed. Tap *Start - Programs - File Explorer* and navigate to the Applications folder. If GSMDemo is not listed, see [GSM Demo Installation](#) on page C-1 for installation instructions. After you successfully install the application, configure it so the terminal can be used to make and receive phone calls.

---

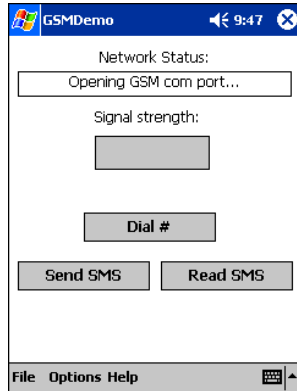
**Note:** For detailed information on the GSM Demo application, see [Appendix C, GSM Demo Program](#).

---

### **GSM Demo Configuration**

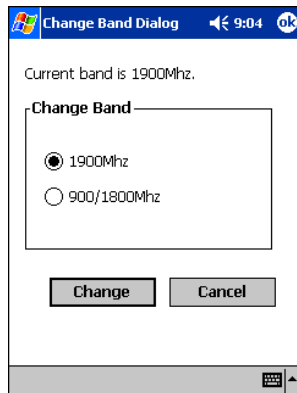
1. Ensure that a SIM card is installed in the terminal. See [Installing a SIM Card](#) on page 1-24.
2. Ensure that the GSMDemo Application is installed on your terminal. Tap *Start - Programs - File Explorer* on your terminal and navigate to the *Applications* folder. If GSMDemo is not listed, see [GSM Demo Installation](#) on page C-1.

3. If GSMDemo is listed, select *GSM Demo*.  
As GSM Demo launches, it opens the internal serial port to the GSM modem and attempts to register with a network. The terminal displays the main GSM Demo screen:

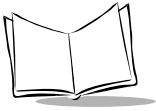


The *Network Status* field displays the following messages as the modem attempts to connect: *Opening GSM com port*, *Initializing modem*, *Checking SIM Card* and *Configuring modem*. Once a successful connection is made, the field displays *Registered Home* or *Registered Roam* (if out of network).

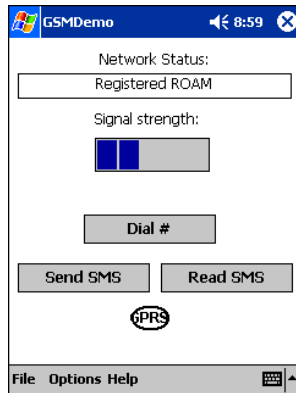
4. If the *Network Status* field displays *Searching...* and a connection is not made:
  - a. Tap *Options - Settings*.
  - b. Select *Change Band*.



1900Mhz is used for North America  
900/1800Mhz is used for Europe, Asia, Australia and Africa.



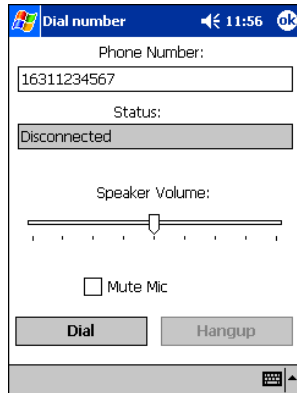
- c. Make the appropriate selection, depending on your location. If necessary, contact your service provider to confirm the band information.
  - d. Tap Change.
  - e. On the pop-up Confirm dialog box, tap Yes. The terminal displays the main GSM Demo screen, and the *Network Status* field displays *Cycling Power Restarting*.
5. A successful registration, indicated by signal strength (as shown below), ensures the functionality of your SIM card.



## Phone Call

To make a phone call:

1. Connect the appropriate headset to the terminal. See [Using a Headset](#) on page 2-4
2. Tap the *Dial #* button on the main GSM Demo screen.



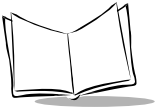
3. Enter the number you want to call in the *Phone Number* field.

---

**Note:** *Emergency phone calls can be made without a SIM card.*

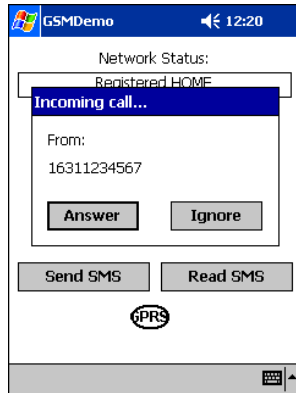
---

4. Tap the *Dial* button. The *Status* field will change to *Connected*, once a connection is established.
5. To disconnect, tap *Hangup*.



To receive a phone call:

When you receive a phone call an *Incoming call...* dialog box pops up on the terminal screen. The notification dialog box shows the number of the caller.



- If you want to answer the incoming call, tap *Answer*.
- If you want to ignore the incoming call, tap *Ignore*.



## Sending and Receiving SMS Messages (PDT 8037/8056 only)

---

The Short Message Service (SMS) is the ability to send and receive text messages to and from mobile devices. The text can comprise of words or numbers or an alphanumeric combination.

The PDT 8037 and PDT 8056 terminals have the technology to send and receive SMS messages using the GSM Demo application (available at <http://devzone.symbol.com>). To send or receive an SMS message you must install and configure the application.

---

**Note:** *Before using the terminal to send a message, ensure that a SIM card has been installed. See [Installing a SIM Card](#) on page 1-24 for detailed instructions.*

---

### ***GSM Demo Installation***

The GSM Demo application allows you to:

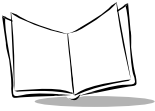
- monitor network status
- dial and answer voice calls
- send and receive SMS
- edit network specific GPRS parameters.

Check the terminal to see if the GSMDemo application is installed. Tap *Start - Programs - File Explorer* and navigate to the Applications folder. If GSMDemo is not listed, see [GSM Demo Installation](#) on page C-1 for installation instructions. After you successfully install the application, configure it so the terminal can be used to send and receive SMS messages.

---

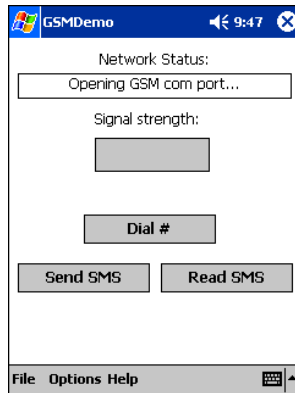
**Note:** *For detailed information on the GSM Demo application, see [Appendix C, GSM Demo Program](#).*

---



## GSM Demo Configuration

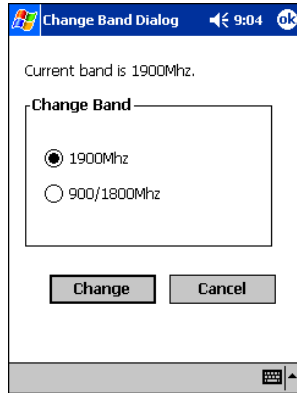
1. Ensure that a SIM card is installed in the terminal. See [Installing a SIM Card](#) on page 1-24.
2. Ensure that the GSMDemo Application is installed on your terminal. Tap *Start - Programs - File Explorer* on your terminal and navigate to the *Applications* folder. If GSMDemo is not listed, see [GSM Demo Installation](#) on page C-1.
3. If GSMDemo is listed, select *GSM Demo*.  
As GSM Demo launches, it opens the internal serial port to the GSM modem and attempts to register with a network. The terminal displays the main GSM Demo screen:



The *Network Status* field displays the following messages as the modem attempts to connect: *Opening GSM com port*, *Initializing modem*, *Checking SIM Card* and *Configuring modem*. Once a successful connection is made, the field displays *Registered Home* or *Registered Roam* (if out of network).

4. If the *Network Status* field displays *Searching...* and a connection is not made:
  - a. Tap *Options - Settings*.

- b. Select Change Band.

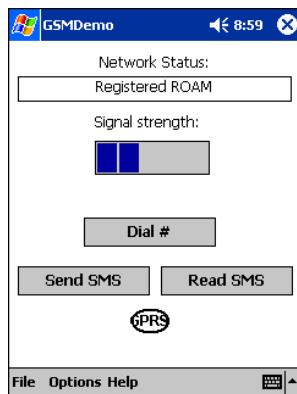


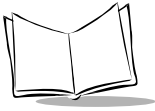
1900Mhz is used for North America

900/1800Mhz is used for Europe, Asia, Australia and Africa.

- c. Make the appropriate selection, depending on your location. If necessary, contact your service provider to confirm the band information.
- d. Tap *Change*.
- e. On the pop-up Confirm dialog box, tap *Yes*. The terminal displays the main GSM Demo screen, and the *Network Status* field displays *Cycling Power. Restarting*.

Once a successful connection is made and you have signal (as shown below), your terminal is ready to make a phone call.

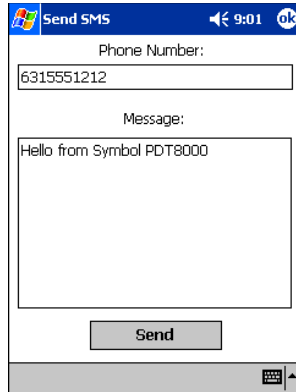




## SMS Messaging

To send an SMS:

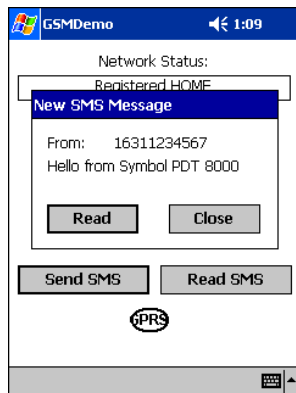
1. Tap the Send SMS button on the main GSM Demo screen.



2. Enter the number you want to send an SMS to in the *Phone Number* field.
3. Type your message in the *Message* field.
4. Tap the Send button. A “Transmission successful” message appears on the screen.

To receive an SMS message:

When you receive an SMS message, a *New SMS Message...* dialog box pops up on the terminal screen. The notification dialog box shows the number of the sender.

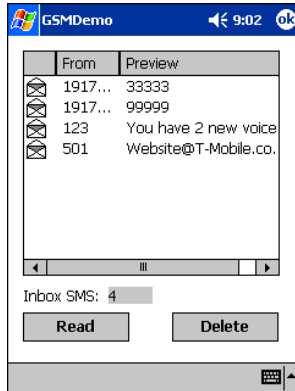


- If you want to read the message now, tap *Read*.

- If you want to close the dialog box and read the message at another time, tap *Close*.

To read an SMS message:

1. Tap the Read SMS button on the main GSM Demo screen.



2. Select the envelope icon next to the message you want to read.
3. Tap the Read button to see the details of the message.
4. To delete a message, select it and tap the Delete button.

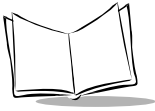
## Scanning

---

The terminal has an integrated scanner which allows you to collect data by scanning one or two-dimensional bar codes. See [Appendix B, Additional Programs](#) for a sample scanning application.

To scan bar codes with the terminal:

1. Ensure that your terminal is loaded with a scanning application.
2. Aim the scan exit window at the bar code.



3. Press either the right or left scan trigger. Make sure the red scan beam covers the entire bar code. The green scan LED lights and a beep sounds to indicate a successful decode.

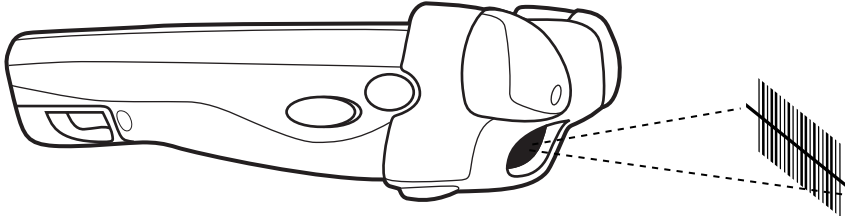


Figure 2-20. Scanning with PDT 8056

## Scan LED Indicator

See [Parts of the Terminal](#) on page 1-4 for the location of the Scan LED on the terminal.

Table 2-3. Scan LED Indicator

LED Status	Indication
Off	Not scanning.
Solid Red	Laser enabled. Scanning in process.
Solid Green	Successful decode.

## Resetting Your Terminal

---

If the terminal stops responding to input from buttons or the screen, reset it by performing a soft or hard reset.

### Performing a Soft Reset

A soft reset restarts the terminal and saves all stored records and entries. Ensure that your terminal is awake before performing a soft reset. If necessary, press the Power key to wake up your terminal.

### Caution

Files that remain open during a soft reset may not be retained.

To perform a soft reset press and hold the power key (for approximately 10 seconds) and release it as soon as the screen changes and the terminal begins to reboot.

## ***Performing a Hard Reset***

A hard reset also restarts your terminal, but erases all stored records and entries that are not saved in the Flash File System. *Therefore, never perform a hard reset unless a soft reset does not solve your problem.*

---

**Note:** *You can restore any data previously synchronized with your host computer during the next ActiveSync operation.*

---

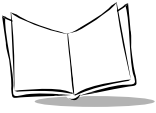
To perform a hard reset:

1. Remove the battery door.
2. Press Power key + Scan button, and release.
3. Replace the battery door.
4. As the terminal reboots, the Symbol splash screen displays for about 60 seconds.
5. Realign the screen. as described in [Aligning the Screen](#) on page 1-31.

---

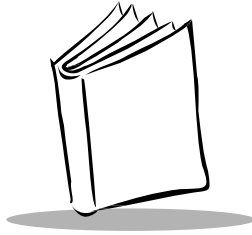
**Note:** *With a hard reset, the current date and time, formats, preferences and other settings are restored to their factory default settings unless they are restored by use of .reg files located in the Flash File System.*

---



*PDT 8000 Series Product Reference Guide*





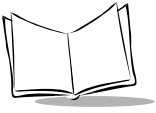
## Chapter 3

# Customizing the Terminal

### Chapter Contents

---

Introduction .....	3-3
Adjusting Settings .....	3-3
Flash Storage .....	3-4
FFS Partitions .....	3-4
Working with FFS Partitions .....	3-5
RegMerge.dll .....	3-5
CopyFile .....	3-6
Non-FFS Partitions .....	3-6
Assigning Applications to Application Buttons .....	3-7
Assigning User-Written Applications to Buttons .....	3-7
Adding Programs .....	3-8
Adding a Program from the Internet .....	3-8
Adding a Program to the Start Menu .....	3-9
Using File Explorer to Add to the Start Menu .....	3-9
Using ActiveSync to Add to the Start Menu .....	3-10
Removing Programs .....	3-10



*PDT 8000 Series Product Reference Guide*

# Introduction

---

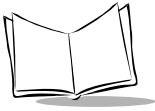
This chapter provides basic instructions for customizing your terminal by adjusting settings and installing additional software.

## Adjusting Settings

---

To view available options for your terminal settings, tap *Start - Settings*. You can adjust settings in either the *Personal* tab, the *System* tab or the *Connections* tab at the bottom of the screen.

- Personal Tab
  - Buttons: assign programs to the application hardware buttons
  - Input: select an input method and change desired options
  - Menu: customize what appears on the *Start* menu and enable a pop-up menu from the *New* button
  - Owner Information: enter your contact information
  - Password: limit access to your terminal
  - Sounds & Notifications: select the type of actions you want to hear sounds for and customize how you are notified about different events
  - Today: customize the information displayed on the Today screen.
- System Tab
  - About: view the software version, device ID and copyright information for the terminal
  - Backlight: customize when and for how long the backlight should stay on
  - Clock: change the time or set alarms
  - Memory: view information about the main and storage memory and see a list of all running programs
  - Power: set the terminal to turn off after a period of time to conserve battery
  - Regional Settings: view and customize region, number, currency, time and date settings.
  - Remove Programs: remove programs installed in the storage memory
  - Screen: align the screen
  - Symbol Settings: configure terminal wake-up (see [Configuring Wake-ups](#) on page 1-34).



- Connections Tab
  - AvantGo Connect: configure server settings for an AvantGo connection
  - Beam: configure settings to receive an incoming beam
  - Connections: configure settings for connections made to the host/internet
  - Network Adapters: configure properties for the installed adapters.

## Flash Storage

---

Programs pre-installed on the terminal are stored in ROM (read-only memory). You cannot remove, modify, or accidentally lose this software. You may add programs and data files to RAM (random access memory).

In addition to the RAM-based storage standard on Pocket PC terminals, the terminal is also equipped with a non-volatile Flash-based storage area which can store data (partitions) that can not be corrupted by a hard reset. This Flash area is divided into two categories: Flash File System (FFS) Partitions and Non-FFS Partitions.

### ***FFS Partitions***

The terminal includes three FFS partitions. These partitions appear to the terminal as a hard drive that the OS file system can write files to and read files from. Data is retained even if power is removed.

The three FFS partitions appear as three separate folders in the Windows CE file system and are as follows:

- **Platform:** The Platform FFS partition contains Symbol-supplied programs and Dynamic Link Libraries (DLLs). This FFS is configured to include DLLs that control system operation. Since these drivers are required for basic terminal operation, only experienced users should modify the content of this partition.
- **Application:** The Application FFS partition is used to store application programs needed to operate the terminal.
- **Data:** The Data FSS partition contains user data files generated by your custom programs.

---

**Note:** *The 64MB RAM Configuration only has two of the three partitions, the Platform FSS partition and the Application FSS partition.*

---

## Working with FFS Partitions

Because the FFS partitions appear as folders under the Windows CE file system, they can be written to and read like any other folder. For example, an application program can write data to a file located in the Application folder just as it would to the Windows folder. However, the file in the Application folder is in non-volatile storage and is not lost on a hard reset (e.g., when power is removed for a long period of time).

Standard tools such as ActiveSync can be used to copy files to and from the FFS partitions. They appear as the “Application,” “Platform,” and “Data” folders to the ActiveSync explorer. This is useful when installing applications on the terminal. Applications stored in the Application folder are retained even when the terminal is hard reset, just as the PDT 8000 Demo program is retained in memory.

Windows CE expects certain files to be in the Windows folder, residing in volatile storage. Windows CE maintains the System Registry in volatile storage. There are two device drivers included in the Windows CE image to assist developers in configuring the terminal following a hard reset: **RegMerge** and **CopyFile**.

### RegMerge.dll

**Regmerge.dll** is a built-in driver that allows registry edits to be made to the Windows CE Registry. Regmerge.dll runs very early in the boot process and looks for registry files (.reg files) in certain Flash File System folders during a hard reset. It then merges the registry changes that are in these files into the system registry located in RAM.

Since the registry is re-created on every hard reset from the default ROM image, the RegMerge driver is necessary to make registry modifications persistent over hard resets.

Regmerge is configured to look in three specific folders for .reg files in the following order:

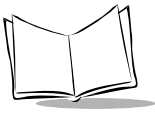
- \Platform
- \Application
- \Data

Regmerge continues to look for .reg files in these folders until all folders are checked. This allows folders later in the list to override folders earlier in the list. This way, it is possible to override Registry changes made by the Platforms partitions folders. Take care when using Regmerge to make Registry changes. The SDK contains examples of .reg files.

---

**Note:** *Regmerge only merges the .reg files on hard resets. The merge process is skipped during a soft reset.*

---



Typically, you should not need to make modifications to registry values for drivers loaded before Regmerge. However, sometimes during software development, you may need to modify these values. Since these early loading drivers read these keys before Regmerge gets a chance to change them, you must soft reset the terminal after a hard reset. The soft reset does not re-initialize the registry, and the early loading driver reads the new registry values.

Do not use Regmerge to modify built-in driver registry values, or merge the same Registry value to two files in the same folder, as the results are undefined.

## CopyFile

**CopyFile** copies files from one folder to another on a hard reset. Files can be copied from a non-volatile partition (Application, Platform or Data) to the Windows or other volatile partition during a hard reset. During a hard reset **CopyFile** looks for files with a .CPY extension on the FFS partition. These files are text files containing the source and destination for the desired files to be copied separated by ">".

## Non-FFS Partitions

Non-FFS Partitions include additional software and data pre-loaded on your terminal that can be upgraded. Unlike FFS Partitions, these partitions are not visible when the operating system is running. They also contain system information. Non-FFS Partitions include the following:

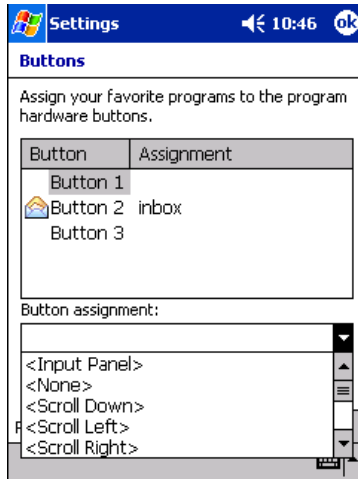
- **Windows CE:** the complete Windows CE operating system is stored on Flash devices. If necessary, the entire OS image may be downloaded to the terminal using files provided by Symbol. The current OS partition on the terminal is included as part of the TCM installation package. Any upgrades must be obtained from Symbol. This partition is mandatory for the terminal.
- **Splash Screen:** a bitmap smaller than 16 Kb, displayed as the terminal cold-boots. You may download a customized screen to display (see [Configuring the Terminal](#) on page 12-1).
- **IPL (Initial Program Loader):** This program interfaces with the host computer and allows you to download via cradle any or all of the partitions listed above, as well as updated versions of IPL. Use caution downloading updated IPL versions; incorrect downloading of an IPL causes permanent damage to your terminal. IPL is mandatory for the terminal.
- **Partition Table:** Identifies where each partition is loaded in the terminal.

## Assigning Applications to Application Buttons

---

The key combinations that represent application buttons access, by default, Calendar, Contacts, Tasks and Notes. To re-assign a different application to a button:

1. Tap *Start - Settings*.
2. On the *Personal* tab, tap *Buttons*.



**Figure 3-1. Buttons Screen**

3. Tap the button on the list that you want to change, then use the *Button assignment* drop-down menu to select a new application for that button.
4. Tap OK.

## Assigning User-Written Applications to Buttons

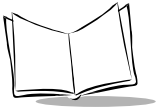
---

Use **Regmerge** to modify the registry during a hard reset to assign user-written applications to the application buttons. These buttons remain assigned after a hard reset.

---

**Note:** *Although located in the Flash File System, we recommend copying user applications to the Windows directory (using CopyFile) and running them from there. See the WinCE Help file for more information.*

---



## Adding Programs

---

Install the appropriate software on your host computer before installing it on your terminal.

1. On the terminal, tap *Start - Settings - System tab - About*. In the *Version* tab, note the information in *Processor*.
2. Download the program to your host computer (or insert the CD or disk that contains the program into your host computer). You may see a single \*.xip file, \*.exe file, a \*.zip file, or a Setup.exe file.
3. Read any installation instructions, Read Me files, or documentation that comes with the program. Many programs provide special installation instructions.
4. Connect your terminal and host computer.
5. Double-click the \*.exe file.

If the file is an installer, the installation wizard begins. Follow the directions on the screen. Once the software is installed on your host computer, the installer transfers the software to your terminal.

If the file is not an installer, an error message states that the program is valid but is designed for a different type of computer. Move this file to your terminal. If you cannot find installation instructions for the program in the Read Me file or documentation, use ActiveSync Explore to copy the program file to the Program Files folder on your terminal. For more information on copying files using ActiveSync, see ActiveSync Help.

When installation is complete, tap *Start - Programs*, then the program icon to select it.

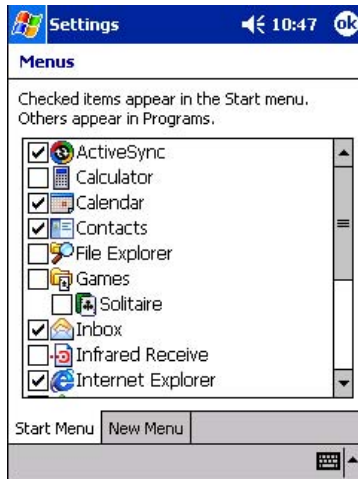
### **Adding a Program from the Internet**

1. On the terminal, tap *Start - Settings - System tab - About*. In the *Version* tab, note the information in *Processor*.
2. Download the program to your terminal from the Internet using Pocket Internet Explorer. You may see a single \*.xip, \*.exe, \*.zip file, or a Setup.exe file.
3. Read any installation instructions, Read Me files, or documentation that comes with the program. Many programs provide special installation instructions.
4. Tap the file, such as a \*.xip or \*.exe file, to launch the installation wizard. Follow the directions on the screen.



## Adding a Program to the Start Menu

Tap *Start - Settings - Menus - Start Menu* tab, then the check box for the program.



**Figure 3-2. Menu Screen**

If you do not see the program listed, either use File Explorer to move the program to the Start Menu folder or use ActiveSync on the host computer to create a shortcut to the program and place the shortcut in the Start Menu folder.

### Using File Explorer to Add to the Start Menu

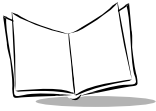
1. Tap *Start - Programs - File Explorer*, and locate the program (tap the folder list, labeled *My Documents* by default, then *My Device* to list all folders on the terminal).
2. Tap and hold the program and tap *Cut* on the pop-up menu.
3. Open the *Start Menu* folder in the *Windows* folder, tap and hold a blank area of the window, and tap *Paste* on the pop-up menu. The program appears on the *Start* menu.

For more information on using File Explorer, see [Finding Information](#) on page 2-22.

---

**Note:** Avoid placing direct links in the Start Menu to programs located in flash memory (*Application* or *Platform*). Copy these programs to the *Windows* folder first.

---



## Using ActiveSync to Add to the Start Menu

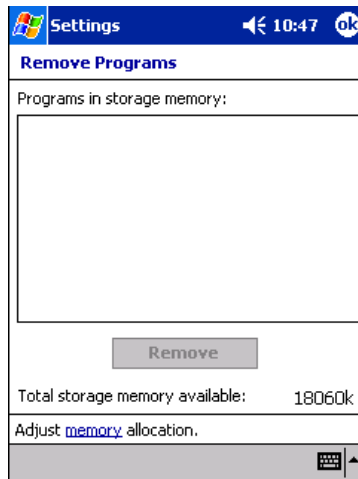
1. Use the Explorer in ActiveSync on your host computer to explore your terminal's files and locate the program.
2. Right-click the program, then click *Create Shortcut*.
3. Move the shortcut to the Start Menu folder in the Windows folder. The shortcut appears on the *Start* menu.

For more information, see ActiveSync Help.

## Removing Programs

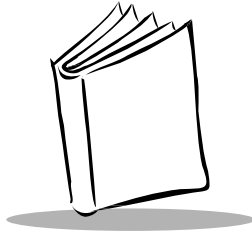
---

To remove a program, tap *Start - Settings*. On the *System* tab, tap *Remove Programs*.



**Figure 3-3. Remove Programs Screen**

If the program does not appear in the list of installed programs, use File Explorer on your terminal to locate the program, tap and hold the program, then tap *Delete* on the pop-up menu.



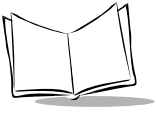
# Chapter 4

## Communications

### Chapter Contents

---

Introduction .....	4-3
Communication Software Installation.....	4-3
Installing ActiveSync.....	4-3
Setting up a Partnership .....	4-4
Installing eConnect.....	4-9
Installing MobileDox Cradle Manager.....	4-9
Communication Setup .....	4-10
Using the Serial Charging Cable .....	4-11
Using the USB Cable .....	4-13
Using the Single-Slot Serial Cradle .....	4-15
Using the Single-Slot Modem Cradle or the Snap-On Modem.....	4-18
Using ActiveSync .....	4-21
Launching the Internet.....	4-22
Country Setup .....	4-23
Using a Four-Slot USB-to-Ethernet Cradle.....	4-25
Using ActiveSync .....	4-30
Launching the Internet.....	4-32
Updating Cradle Firmware.....	4-32
Communication LED Indicator.....	4-33
Using the Vehicle Cradle .....	4-34
Using ActiveSync .....	4-34
Using the Magnetic Stripe Reader .....	4-36
Using ActiveSync .....	4-36
Using Printers .....	4-38
Connecting to the Internet on a Wireless Network.....	4-39



*PDT 8000 Series Product Reference Guide*

## Introduction

---

The PDT 8000 Series terminal is capable of communicating with a number of hosts, including development PCs, serial devices, printers, etc. The available accessories serve as essential data communication devices, enabling you to synchronize the information on your terminal with the information on your host device using ActiveSync. With the appropriate accessory and software, the terminal can establish a number of connection types, such as a serial connection and a modem connection.

This chapter provides information on installing the appropriate communication software and setting up the appropriate accessory to enable communication between the terminal and the host device.

## Communication Software Installation

---

Below is a list of software applications you will need to successfully communicate with the various host devices:

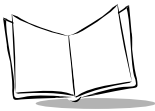
- Microsoft ActiveSync
- eConnect
- MobileDox Cradle Manager

### *Installing ActiveSync*

Using ActiveSync, you can synchronize the information on your terminal with the information on your host computer. Changes you make on your terminal or host computer appear in both places after you synchronize.

With ActiveSync software you can:

- Work with terminal-compatible host applications on your host computer. ActiveSync replicates data from your terminal (such as Calendar and Contacts) so you can view, enter and modify any data stored on your terminal with the host application.
- Synchronize Microsoft Word and Microsoft Excel files between your terminal and host computer. Your files are automatically converted to the correct format.
- Back up the data stored on your terminal. Synchronization is a one-step procedure that ensures your data is always safe and up-to-date.
- Copy (rather than synchronize) files between your terminal and host computer.



- Control when synchronization occurs by selecting a synchronization mode, e.g., you may synchronize continually while the terminal is connected to the host computer, or only when you select the synchronize command.
- Select the types of information to synchronize, and control how much data is synchronized.

To install ActiveSync download the latest version of the software from <http://www.microsoft.com>. Refer to the installation and RAS instructions included with the ActiveSync software you download.

## Setting up a Partnership

After installation is complete, the ActiveSync Setup Wizard helps you connect your terminal to your host computer, set up a partnership so you can synchronize information between your terminal and host computer, and customize synchronization settings. Your first synchronization occurs automatically when you finish using the wizard.

1. If the Get Connected window does not appear, select *Start - Programs - Microsoft ActiveSync*.



Figure 4-1. Get Connected Window

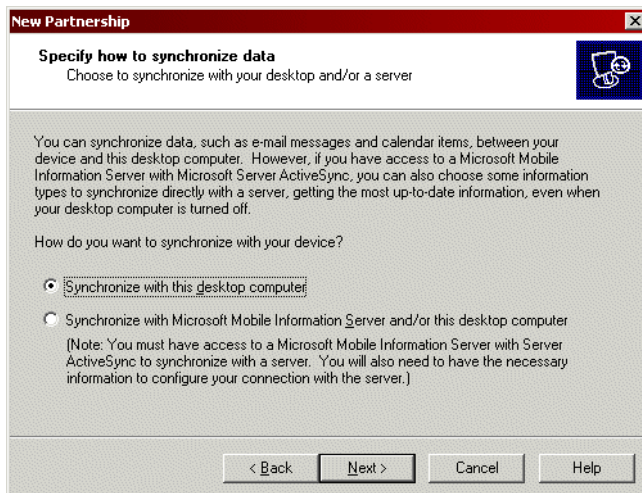
2. Establish a serial connection between your terminal and host computer, using a serial device (for example, see [Using the Serial Charging Cable](#) on page 4-11).
3. On the host computer, select **Next** in the *Getting Connected* window.

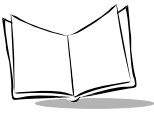
- The host computer and the terminal will attempt to synchronize. The *New Partnership* window appears.



**Figure 4-2. New Partnership Window**

- Click the **Yes** radio button and then select **Next**. The *New Partnership/Specify how to synchronize data* window appears.





6. Click the **Synchronize with this desktop computer** radio button and then select **Next**. The *New Partnership/Select Number of Partnerships* window appears.

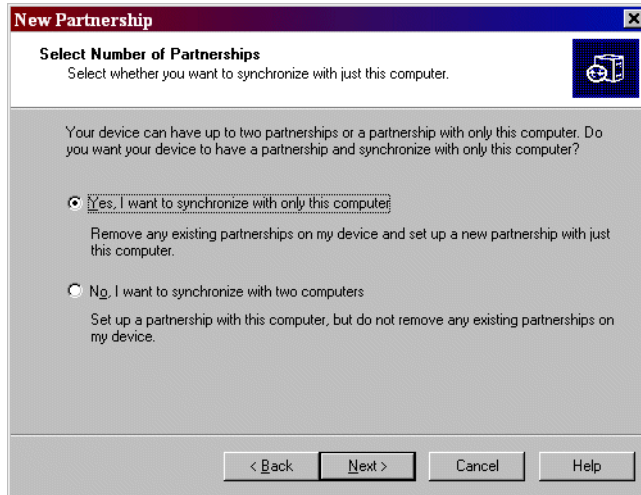


Figure 4-3. Select Number of Partnerships

7. Select **Next**. The *New Partnership/Select Synchronization Settings* window appears.

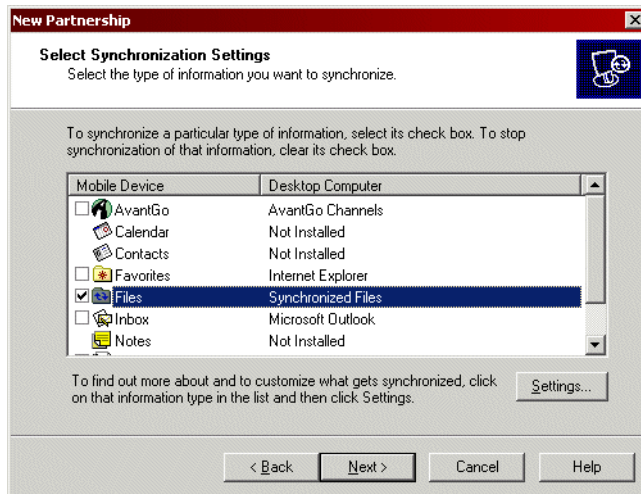
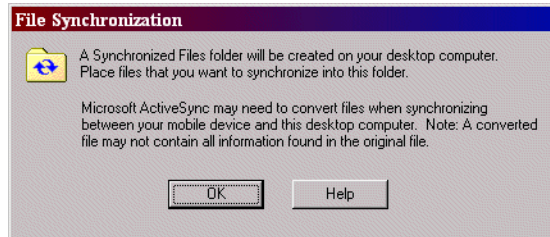


Figure 4-4. Select Synchronization Settings Window

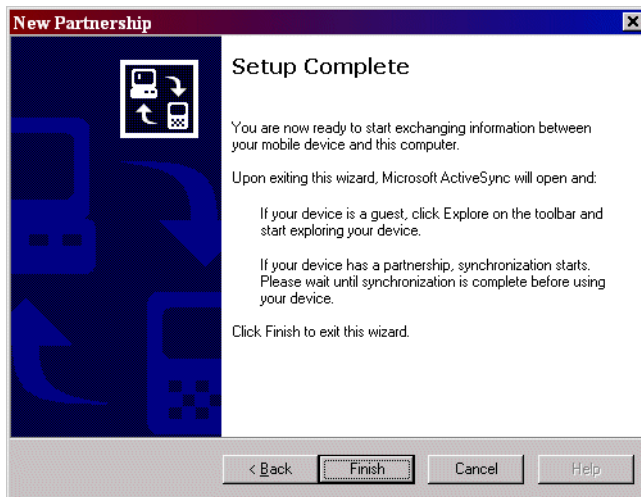


- To synchronize files, click on Files check box. The *File Synchronization* window appears.

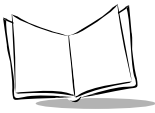


**Figure 4-5. File Synchronization Folder Confirmation**

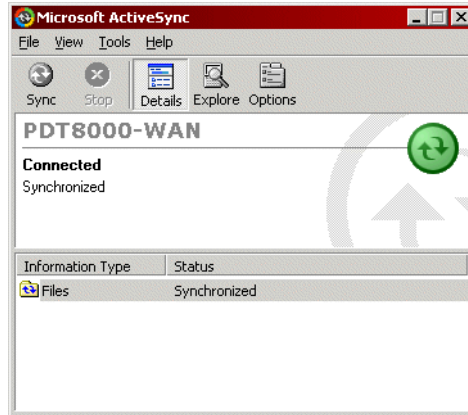
- Select **OK** to display the *Setup Complete* window.
- Select **Next**.



**Figure 4-6. Setup Complete Window**

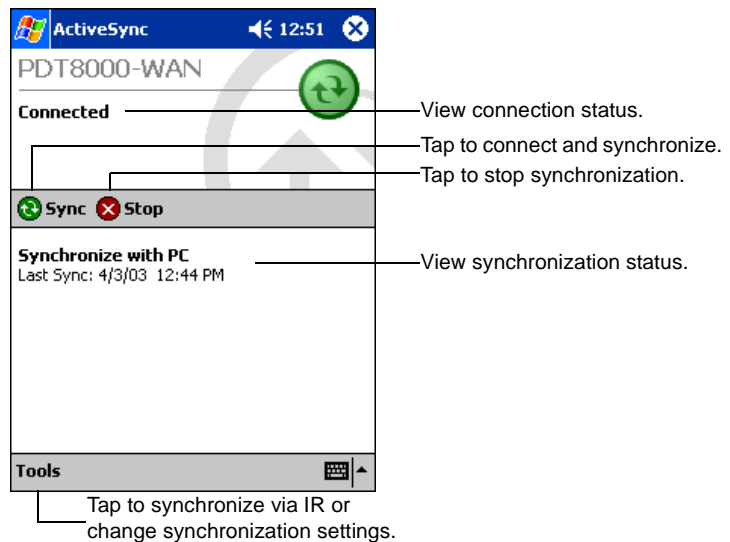


11. Select **Finish**.



**Figure 4-7. ActiveSync Connected Window**

During the first synchronization, information stored in Microsoft Outlook (Calendar, Contacts, and Tasks) on your host computer is copied to your terminal. You can now disconnect your terminal from your host computer.



**Figure 4-8. ActiveSync**

---

**Note:** *You must perform your first ActiveSync operation with a local, direct connection.*

*To retain partnerships after a hard reset, capture partnership registry information in a .reg file and save it in the Flash File System. See the Help file for details.*

---

For more information about using ActiveSync, start ActiveSync on your host computer, then see ActiveSync Help.

## ***Installing eConnect***

eConnect is a control panel applet you may install on a terminal; it automates the launch of a modem connection and applications, such as ActiveSync or Internet Explorer.

---

**Note:** *eConnect is used only when establishing a connection using the Single-Slot Modem Cradle, the Snap-On Modem and the Four-Slot USB-to-Ethernet cradle.*

---

To install eConnect:

1. Download eConnect (for PDT 8000) from <http://devzone.symbol.com>.
2. Establish a serial connection between your terminal and host computer, using a serial device (for example, see [Using the Serial Charging Cable](#) on page 4-11).
3. Copy the eConnect file you downloaded in step 1 into the Applications folder of the terminal.
4. On the terminal, tap *Start - Programs - File Explorer*.
5. Go to your Applications folder and tap the eConnect file you copied in step 3. eConnect will install on your terminal.

## ***Installing MobileDox Cradle Manager***

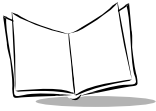
---

**Note:** *MobileDox Cradle Manager is used only when establishing a connection using the Four-Slot USB-to-Ethernet Cradle.*

---

The Cradle Management software allows you to:

- View cradles that are attached to the network via MobileDox Net



- View cradle status
- Modify cradle settings including:
  - IP address settings
  - DNS and WINS settings
  - Identification settings
  - USB port specific settings
- Restart cradles connected to the network via MobileDox Net
- Update the firmware of MobileDox Net.

To install the Cradle Management Software on your host computer, download the latest version of the software from <http://devzone.symbol.com>. Refer to the instructions included with the software you download.

## Communication Setup

---

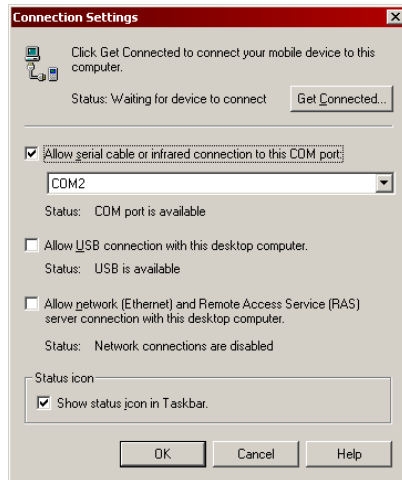
The terminal can communicate with the host computer using the following accessories:

- Serial Charging Cable (see [page 11](#))
- USB Cable (see [page 13](#))
- Single-Slot Serial Cradle (see [page 15](#))
- Single-Slot Modem Cradle (see [page 18](#))
- Snap-On Modem (see [page 18](#))
- Four-Slot USB-to-Ethernet Cradle (see [page 25](#))
- Vehicle Cradle (see [page 34](#))
- Magnetic Stripe Reader (see [page 36](#)).

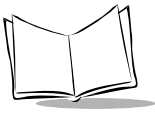
For each accessory, you will need to follow instructions on configuring your host computer, setting up the connection between the terminal and the host computer, and configuring the terminal.

## Using the Serial Charging Cable

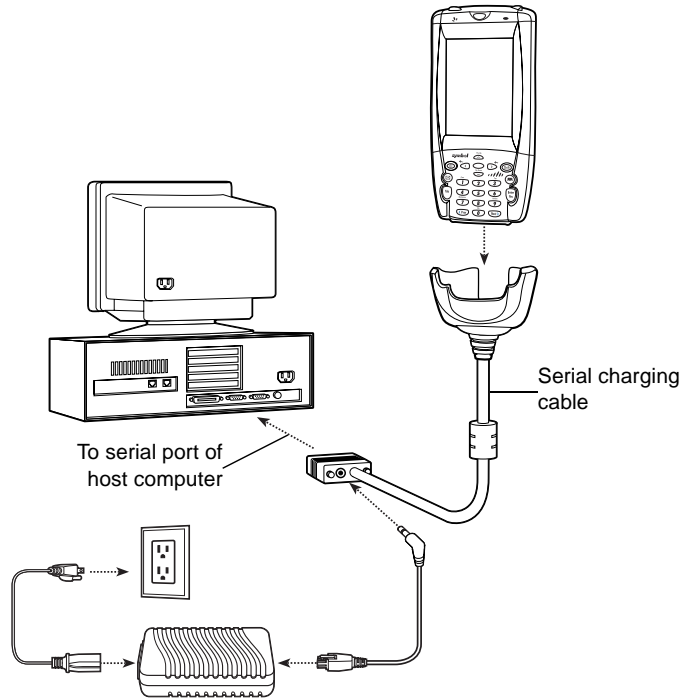
1. Install ActiveSync on your host computer. See [Installing ActiveSync](#) on page 4-3.
2. Start ActiveSync on your host computer (*Start - Programs - Microsoft ActiveSync*). Click *File - Connection Settings* and ensure the following selections are made (select the appropriate COM port for your host PC):



3. On the terminal, tap *Start - ActiveSync - Tools - Options... - PC* tab and ensure **57600 Default** is selected from the *Enable synchronization when cradled using:* drop-down menu.



4. Connect the serial charging cable to your terminal and host PC as shown below:



**Figure 4-9. Serial Charging Cable Connection to Host PC**

---

**Note:** *The serial charging cable requires a dedicated port. It cannot share a port with an internal modem or other device. If you are unsure about the location of the serial port on your computer, refer to the user's manual supplied with the computer.*

---

5. If this is your first synchronization, follow the instructions on the host computer screen to setup the partnership. Items to be synchronized may be customized, and you may select to synchronize continuously as information changes, upon connection, or manually by clicking the Sync button on the toolbar of your host computer.

---

**Note:** Every PDT 8000 terminal should have a unique name. Never try to synchronize more than one PDT 8000 terminal to the same user name.

---

- If you already created a partnership between your host computer and terminal, synchronization will occur automatically, immediately following step 4.

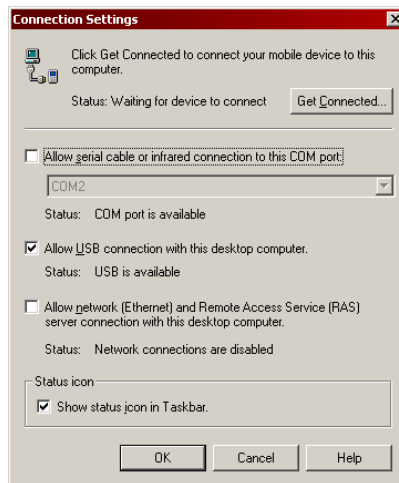
## Using the USB Cable

---

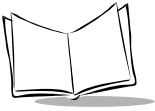
**Note:** A Symbol USB ActiveSync Driver Update must be download in order to use the USB Cable for communication. This update is available at <http://devzone.symbol.com>.  
The USB Cable can only be used with the 128MB RAM configuration.

---

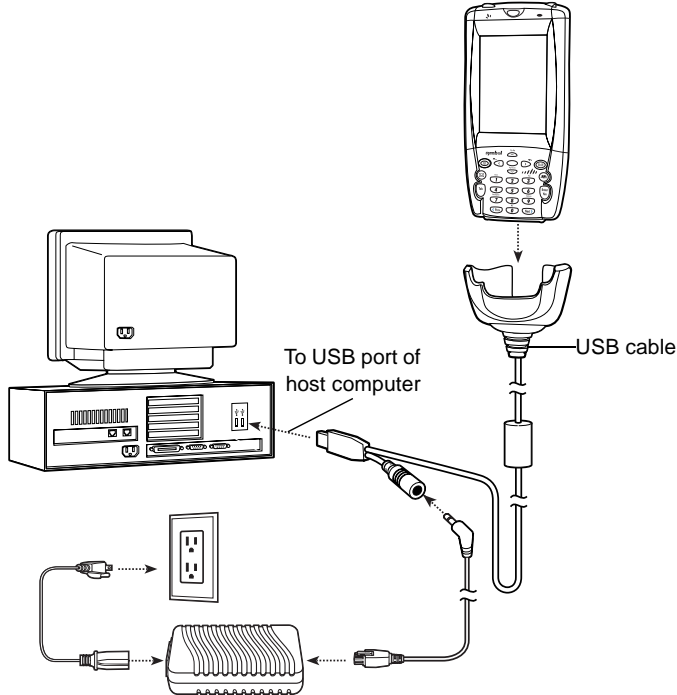
- Install ActiveSync on your host computer. See [Installing ActiveSync](#) on page 4-3.
- Start ActiveSync on your host computer (*Start - Programs - Microsoft ActiveSync*). Click *File - Connection Settings* and ensure the following selections are made (select the appropriate COM port for your host PC):



- Tap *Start - ActiveSync - Tools - Options - PC* tab on your terminal and ensure **USB** is selected from the *Enable synchronization when cradled using:* drop-down menu to temporarily disable serial cable detect before using ActiveSync.



4. Connect the USB cable to your terminal and host PC as shown below:



**Figure 4-10. USB Cable Connection to Host PC**

5. If this is your first synchronization, follow the instructions on the host computer screen to setup the partnership. Items to be synchronized may be customized, and you may select to synchronize continuously as information changes, upon connection, or manually by clicking the Sync button on the toolbar of your host computer.

---

**Note:** Every PDT 8000 terminal should have a unique name. Never try to synchronize more than one PDT 8000 terminal to the same user name.

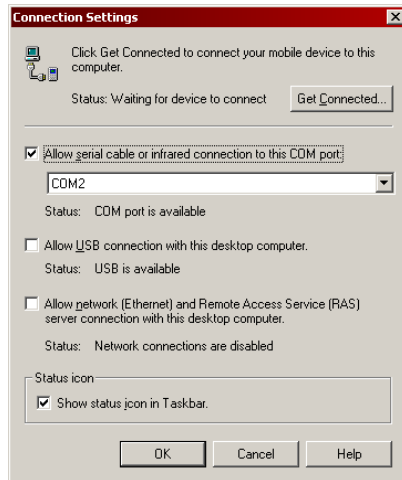
---

6. If you already created a partnership between your host computer and terminal, synchronization will occur automatically, immediately following step 4.

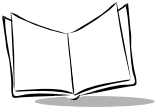


## Using the Single-Slot Serial Cradle

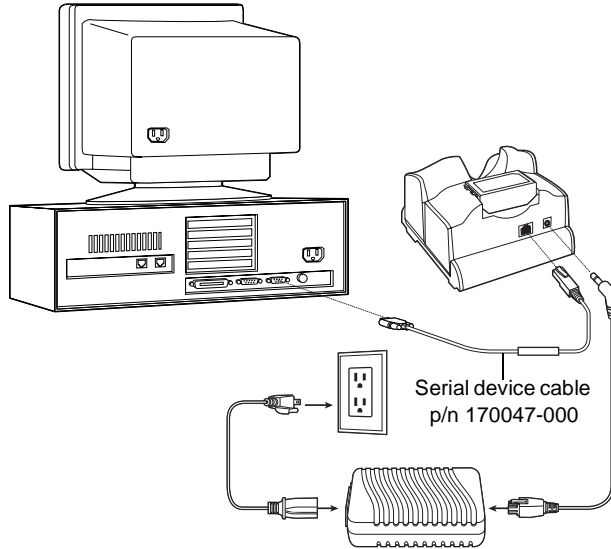
1. Install ActiveSync on your host computer. See [Installing ActiveSync](#) on page 4-3.
2. Start ActiveSync on your host computer (*Start - Programs - Microsoft ActiveSync*). Click *File - Connection Settings* and ensure the following selections are made (select the appropriate COM port for your host PC):



3. Tap *Start - ActiveSync - Tools - Options - PC* tab on your terminal and ensure **57600 Default** is selected from the *Enable synchronization when cradled using:* drop-down menu to temporarily disable serial cable detect before using ActiveSync.



4. Connect the single-slot serial cradle to your host computer as shown below:



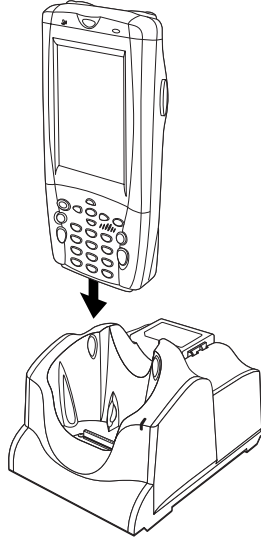
**Figure 4-11. Single-Slot Serial Cradle Connection to Host PC**

---

**Note:** *The cradle requires a dedicated port. It cannot share a port with an internal modem or other device. If you are unsure about the location of the serial port on your host computer, refer to the user's manual supplied with the computer.*

---

5. Turn on the terminal and slide it into the cradle.



**Figure 4-12. Inserting the Terminal in the Single-Slot Serial Cradle**

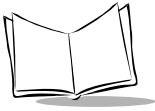
6. If this is your first synchronization, follow the instructions on the host computer screen to setup the partnership. Items to be synchronized may be customized, and you may select to synchronize continuously as information changes, upon connection, or manually by clicking the Sync button on the toolbar of your host computer.

---

**Note:** *Every PDT 8000 terminal should have a unique name. Never try to synchronize more than one PDT 8000 terminal to the same user name.*

---

7. If you already created a partnership between your host computer and terminal, synchronization will occur automatically, immediately following step 5.



## Using the Single-Slot Modem Cradle or the Snap-On Modem

1. Install ActiveSync on your host computer. See [Installing ActiveSync](#) on page 4-3.

---

**Note:** Before communicating through a modem connection, you must create a partnership between your terminal and your host computer. See [Setting up a Partnership](#) on page 4-4 for detailed instructions.

---

2. Install eConnect on your terminal. See [Installing eConnect](#) on page 4-9.
3. On your terminal, tap *Start - ActiveSync - Tools - Options - PC* and:
  - a. deselect the *Enable synchronization when cradled using*: check box to temporarily disable serial cable detect before using ActiveSync.
  - b. select the *Include PC when synchronizing remotely and connect to*: check box to ensure the host computer you wish to synchronize with is identified.
4. On your terminal:
  - a. Tap *Start - Settings - Connections* tab - *Connections* icon.
  - b. Select **Work** from the *My network card connects to*: drop-down menu.
  - c. Tap the **Modify** button under the *When needed, automatically connect to the Internet using these settings*: drop-down menu.
  - d. Tap **New...** in the Modem tab.
  - e. Enter 'SnapOnModem' for the connection in the *Enter a name for the connection*: text box.
  - f. If you are using the single-slot modem cradle, select **Hayes Compatible on COM1** from the *Select a modem*: drop-down menu.  
If you are using the snap-on modem, select **Powered Serial on COM7** from the *Select a modem*: drop-down menu.
  - g. Select **57600** from the *Baud-rate*: drop-down menu.
  - h. Tap the **Advanced...** button.
  - i. Select **8, None, 1,** and **Hardware** in the *Port Settings* tab.
  - j. Select the appropriate times for terminal use, if your dial-in server requires manual input for each connection.
  - k. Tap the *TCP/IP* tab.
  - l. Enter parameters supported by your server.
  - m. Tap the *Name Servers* tab.
  - n. Enter parameters supported by your server.

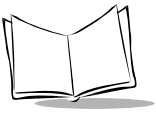
- o. Tap the **OK** button. The Make New Connection screen appears.
- p. Tap the **Next** button.
- q. Enter the appropriate country code, if necessary, in the *Extra dial-string modem commands*: textbox.
- r. Tap the **Next** button.
- s. Select other options.
- t. If necessary, edit *Extra dial-string modem commands*: text to set country parameters.

---

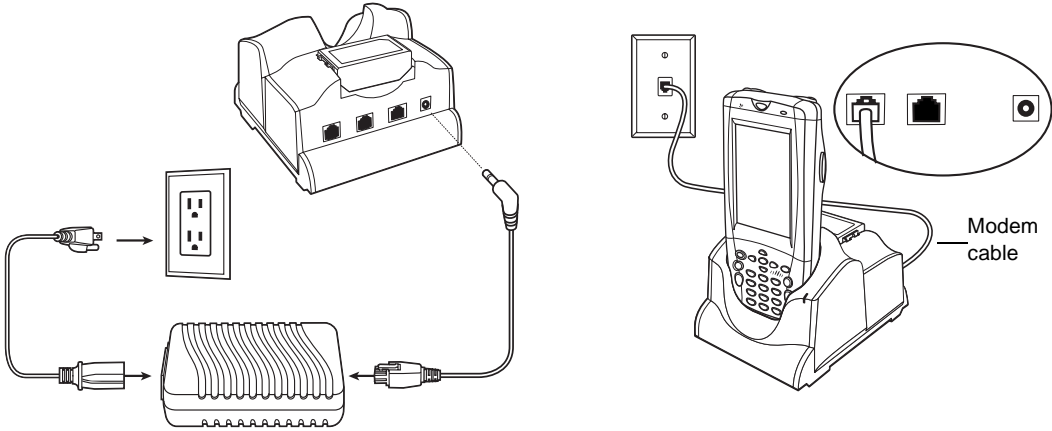
**Note:** *The modem defaults to operation with US telephone networks. To operate the modem with other country telephone networks, you must change the modem Country Code. See [Country Setup](#) on page 4-23 for the appropriate syntax and list of codes.*

---

- u. Tap the **Finish** button. The name you gave the modem in step 4e appears in the Modem tab.
- v. Tap the **OK** button.
- w. Tap the Dialing Locations tab and setup the location you are calling from.
- x. Tap the **Dialing Patterns...** button and enter the appropriate dialing patterns.
- y. Tap the **OK** button until you exit the Connections screen.



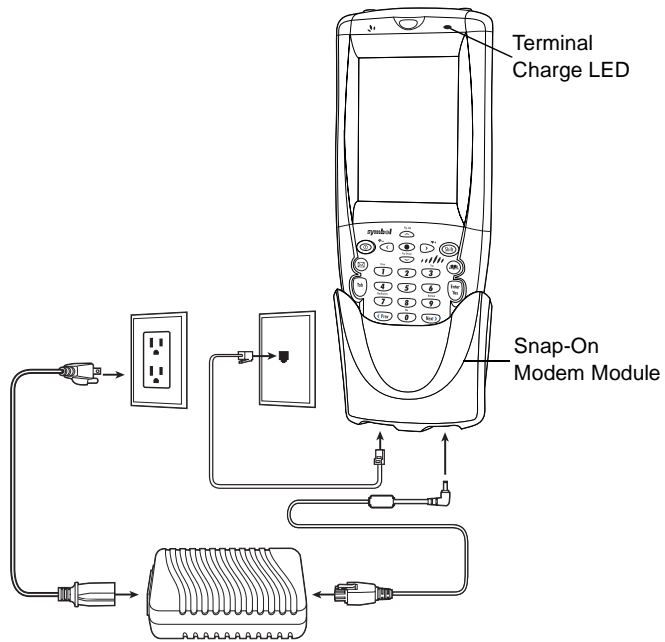
5. Setup the single-slot modem cradle as shown below:



**Figure 4-13. Setting up the Single-Slot Modem Cradle**

OR

Setup the snap-on modem as shown below:

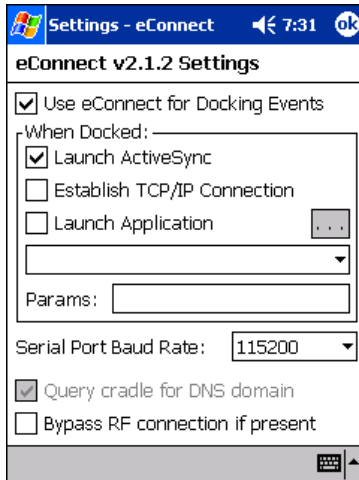


**Figure 4-14. Setting up the Snap-On Modem Module**

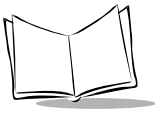
With a modem connection, you can use ActiveSync to synchronize data between your terminal and host computer (see [Using ActiveSync](#) on page 4-21) or you can connect to the Internet (see [Launching the Internet](#) on page 4-22).

## Using ActiveSync

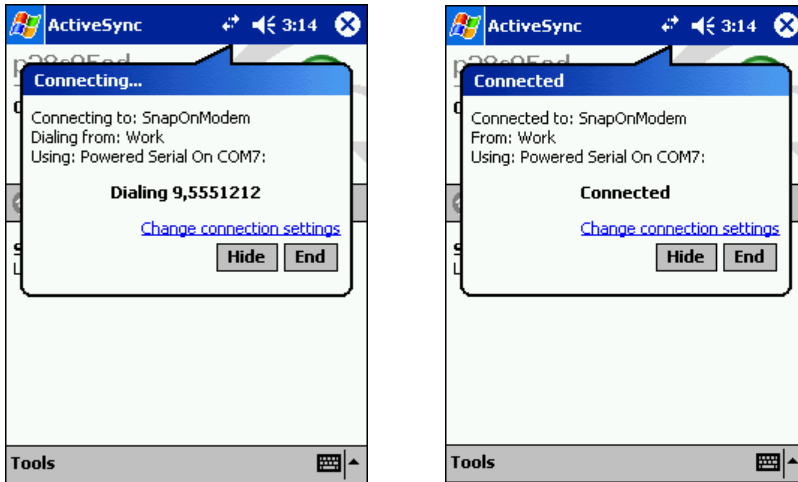
1. Tap *Start - Settings - System - eConnect* and ensure the following settings are made:



2. Tap the OK button.



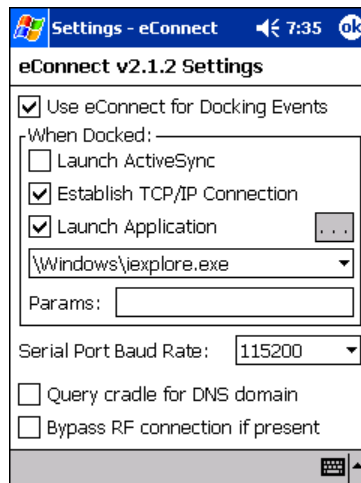
3. Tap *Start - ModemSync*. The modem dial-out commences and, if successful, a series of dialog boxes pop-up in succession, as shown below:



4. After connecting, ActiveSync starts and synchronizes with the host computer.
5. To disconnect, tap the *Stop* button on the *ActiveSync* screen.

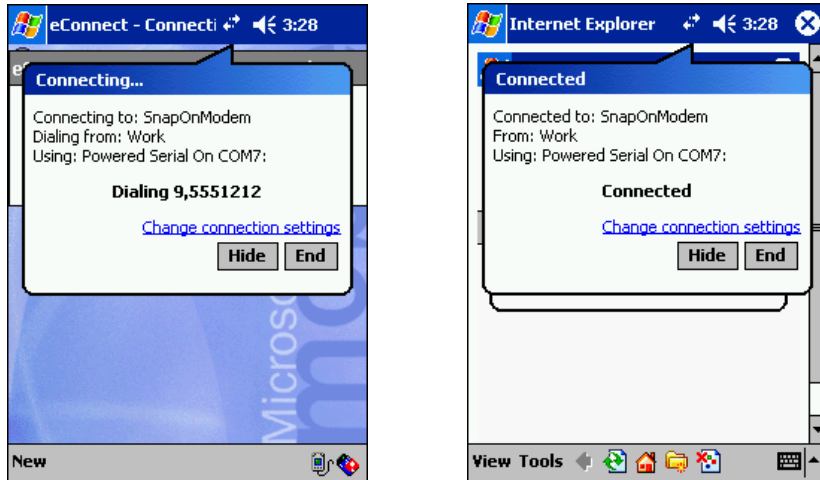
## Launching the Internet

1. Tap *Start - Settings - System - eConnect* and ensure the following settings are made:





2. Tap the **OK** button.
3. Tap **Start - ModemSync**. The modem dial-out commences and, if successful, a series of dialog boxes pop-up in succession, as shown below:



4. When connected, Internet Explorer starts. You can now surf the Internet, if permitted by your server.
5. To disconnect, tap the two arrows on the navigation bar to expose the *Connected* dialog box.
6. Tap the **End** button.

## Country Setup

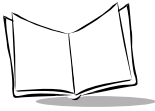
The modem defaults to operation with US telephone networks (country code: B5). To operate the modem with other country telephone networks, you must set the Country Code by entering the Country of Installation command. The modem will adjust it's operating parameters to comply with the telephone network in the country specified.

Edit *Extra dial-string modem commands*: text box to set country parameters.

The syntax used is: `+GCI=<country_code>`;

The supported countries and there codes are:

Country	Code	Country	Code	Country	Code
Austria	FD or 0A	Greece	46	Norway	FD or 82
Belgium	FD or 0F	Iceland	FD	Portugal	8B
Brazil	16	Ireland	FD or 57	Spain	FD or A0



<b>Country</b>	<b>Code</b>	<b>Country</b>	<b>Code</b>	<b>Country</b>	<b>Code</b>
Canada	20	Italy	FD or 59	Sweden	FD or A5
Denmark	FD or 31	Liechtenstein	FD	Switzerland	FD or A6
Finland	FD or 3C	Luxembourg	FD	TBR-21 (Europe)	FD
France	FD or 3D	Mexico	73	United Kingdom	FD or B4
Germany	FD or 42	Netherlands	FD or 7B	United States	B5 (Default)
<b>Note:</b> It is highly recommended that you use FD where possible. If you have trouble connecting, use the alternate code where provided.					

## Using a Four-Slot USB-to-Ethernet Cradle

---

**Note:** *The four-slot USB-to-Ethernet cradle can only be used with the 128MB RAM configuration.*

---

In order to establish a connection between the terminal and the host computer to communicate over an Ethernet network, the following must be done:

- configuration of the terminal
- configuration of the host computer
- configuration of the DHCP server
- configuration of the cradle.

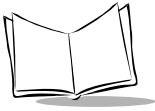
### **Configuration of the Terminal**

When you insert a terminal into the cradle, the cradle provides a direct-connect RAS service. You need to configure each terminal for use with the cradle, just as you would configure any remote client to connect to an Internet Service Provider (ISP). To configure the terminal install eConnect. See [Installing eConnect](#) on page 4-9.

### **Configuration of the Host Computer**

The host computer that you intend to synchronize with the terminal must be setup with the appropriate communication software and connection settings. This guide assumes that you are using Microsoft® ActiveSync software on both the terminal and the host computer. To configure the host computer:

1. Download and install ActiveSync. See [Installing ActiveSync](#) on page 4-3.
2. Configure the connection settings. The host computer must be configured for TCP/IP network communications.
  - a. Click on the ActiveSync icon from the system tray
  - b. Tap *File - Connection settings*.
  - c. In the *Connection settings* dialog box, select the *Allow Network (Ethernet) and Remote Access Service (RAS) server connection with this desktop computer* option.  
You may have other options selected, for example, *Allow serial cable or infrared connection to this COM port*.
  - d. Click the OK button.



---

**Note:** Before communicating through an ethernet connection, you must create a partnership between your terminal and your host computer. See [Setting up a Partnership](#) on page 4-4 for detailed instructions.

---

### **Configuration of the DHCP Server**

If you use a DHCP server to distribute IP addresses and other network parameters, setup the server as following:

- IP address pool (1 or 5 IP address per cradle)
- router/gateway address
- one or more DNS server addresses
- one or more WINS server addresses
- the subnet mask.

---

**Note:** To assign the initial cradle IP address, you can either use a DHCP server, as shown above, or use the MobileDox Cradle Manager, as illustrated in [Configuration of the Cradle](#) on page 4-26. DHCP server is the preferred method.

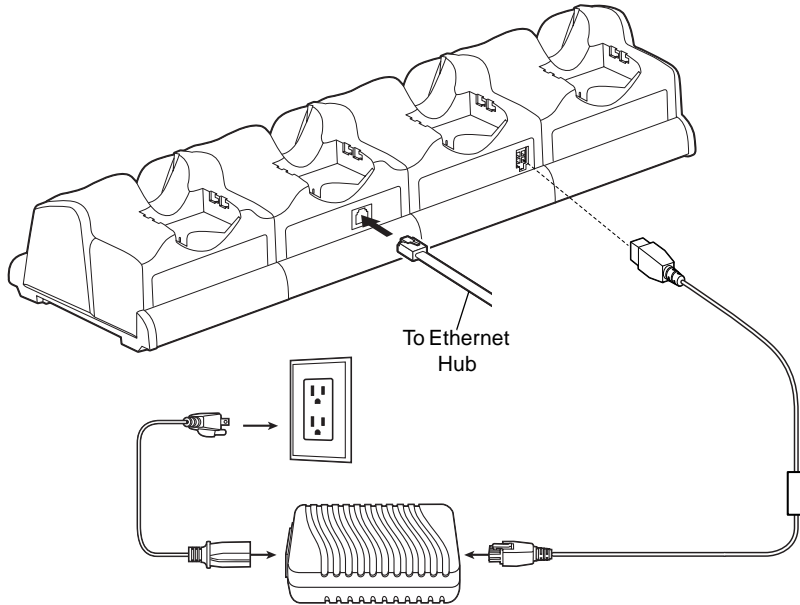
---

### **Configuration of the Cradle**

The MobileDox Cradle Manager allows you to setup the Device IP Address and modify cradle settings. See [Installing MobileDox Cradle Manager](#) on page 4-9 for instructions to download and install the software.

## Connecting the Cradle

Setup the four-slot USB-to-Ethernet cradle as shown below:



**Figure 4-15. Setting up the Four-Slot USB-to-Ethernet Cradle**

## Setting the Device IP Address

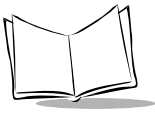
By default, the cradle will use DHCP to obtain its IP address. However, if DHCP fails, the Cradle Manager can assign an IP address.

---

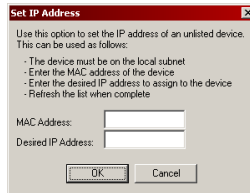
**Note:** *This is used if your cradle is connected to the network, however fails to appear in MobileDox. Enter the hardware device (MAC) address to locate the cradle and assign it a new IP address.*

---

1. Launch the MobileDox Cradle Manager on your host computer.



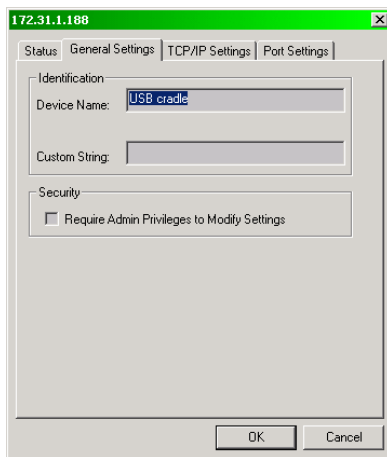
2. Click *File - Set IP Address of Unlisted Device*. The following screen appears:



3. Enter the appropriate MAC Address and IP address.
4. Click the OK button.

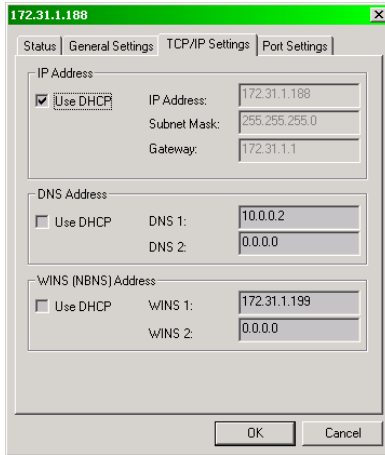
## Modifying Cradle Settings

1. Launch the MobileDox Cradle Manager on your host computer.
2. Select the name of the cradle you want to configure from the list.
3. Click *Device - Modify Settings*.
4. Use the General Settings tab to modify the identification settings of the cradle.

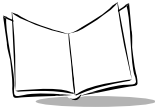


Field	Description
Device Name	A text string used to describe the MobileDox device. Any 15-character string may be entered.
Custom String	A text string for any desired usage (examples are: location, asset ID, etc.). Any 15-character string may be entered.
<i>Require Admin Privileges to Modify Settings</i> checkbox	Selecting this checkbox will require users to have administrative privileges in order to modify MobileDox settings. Administrative privileges are validated using standard Windows authentication.

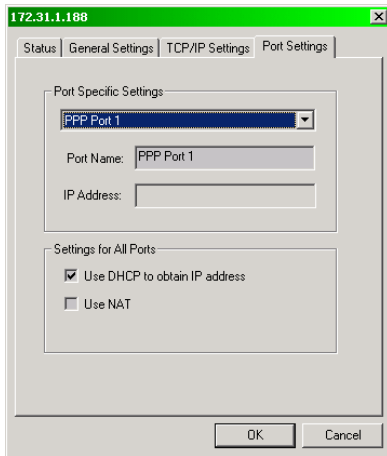
- Use the TCP/IP Settings tab to modify the DNS and WINS identification settings of the cradle.



Field	Description
Use DHCP	If checkbox is selected, necessary information will be retrieved from the DHCP server. If checkbox is not selected, static configuration will be used (information needs to be entered).
IP Address	The IP address that the MobileDox will use when communicating on the network.
Subnet Mask	The subnet mask that the MobileDox will use when communicating on the network.
Gateway Address	The IP address that the MobileDox will use to send non-local IP network data.
DNS Address	The IP address of a server(s) that can resolve Internet names into IP addresses.
WINS Address	The IP address of a server(s) that can resolve Windows network names into IP addresses. This field must be populated correctly when using ActiveSync.



6. Use the Port Settings tab to modify the USB port settings of the cradle.



Field	Description
Port Name	A text string used to describe the device attached to the port. Any 15-character string can be entered. You can specify up to four port names, one for each of the cradle's slots.
IP Address	The IP address assigned to the cradled device. There should be one IP address per cradle slot. This box will be disabled for all devices if DHCP is used to obtain the IP address.
<i>Use DHCP to obtain IP Address</i> checkbox	The cradle will use DHCP to obtain an IP address for the handheld. Unchecking this selection allows the cradle to use Static IP address for the handheld.
<i>Use NAT</i> checkbox	The cradle will use Network Address Translation (NAT) when forwarding handheld traffic onto the network. No IP addresses are necessary for the handhelds. This must be disabled when using ActiveSync.

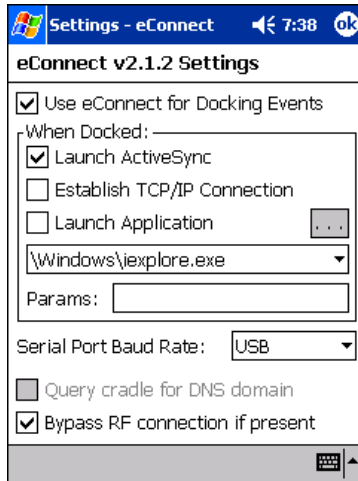
7. Click the OK button.

## Using ActiveSync

1. Review the configuration of the cradle using the MobileDox Cradle Manager.
  - a. A WIN server must be present on your network. Ensure that the WINS Address provided in the TCP/IP Settings tab matches the IP address of the WIN server on your network.
  - b. Ensure that the *Use NAT* checkbox is not selected in the Port Settings tab.



2. On your terminal, tap *Start - Settings - System - eConnect* and ensure the following settings are made:

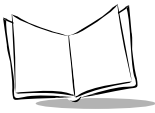


3. Tap the **OK** button.
4. Insert the terminal into the cradle. The cradle's communication LED turns red, then flashes green, indicating that the host computer and terminal are communicating. See [Communication LED Indicator](#) on page 4-33 for other indications.
5. On the terminal, a succession of dialog boxes appear, indicating the status of the connection. When successfully connected and synchronized, the status of the host computer is *Connected/Synchronized*.

---

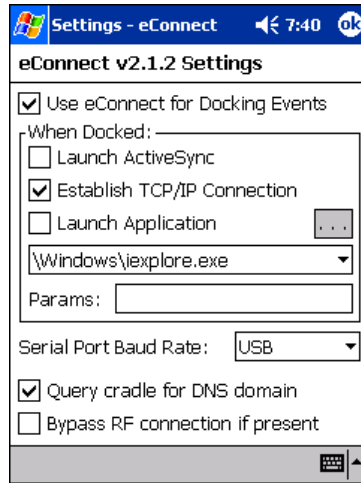
**Note:** *If you remove the terminal from the cradle while the LED is flashing green, you disrupt communication and data may be lost. When the terminal finishes communicating, the slot's LED turns solid green until the terminal is removed from the slot.*

---



## Launching the Internet

1. Review the configuration of the cradle using the MobileDox Cradle Manager.
2. On your terminal, tap *Start - Settings - System - eConnect* and ensure the following settings are made:



3. Tap the OK button.
4. Insert the terminal into the cradle. The cradle's communication LED turns red, then flashes green, indicating that the host computer and terminal are communicating. See [Communication LED Indicator](#) on page 4-33 for other indications.
5. On the terminal, a succession of dialog boxes appear, indicating the status of the connection.
6. Once connected, tap *Start - Internet Explorer* to launch the browser.

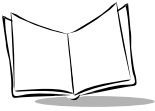
## Updating Cradle Firmware

1. Ensure that your .bin update file is located in Program Files\Symbol\MobileDox\FW on your host computer.
2. In the MobileDox Cradle Manager screen, select the cradle whose firmware you want to update.
3. From the *Device* menu, select **Update Firmware**.
4. Click the Go button. A progress dialog box appears.
5. When update is complete, click the Close button. The cradle will reboot.

## Communication LED Indicator

**Table 4-1. Communication LED Indicator**

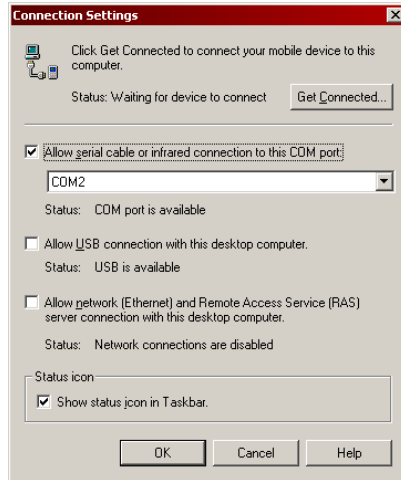
LED	Indication
Off	Terminal not in cradle; terminal not placed correctly; cradle is not powered.
Solid Red	Terminal is present, but communication has not started.
Flashing Green	Terminal is in the cradle, and communicating with the host computer.
Slow Flashing Red	Error, communication did not start.
Fast Flashing Red	Warning: Terminal inactivity timeout. The terminal did not finish data synchronization or had an open connection for more than 15 minutes. This time is programmable in the cradle flash parameters.
Solid Green	Terminal is present in the slot and communication is complete.
All LEDs Flashing Red	Failed automatic cradle configuration via local DHCP Service.



## Using the Vehicle Cradle

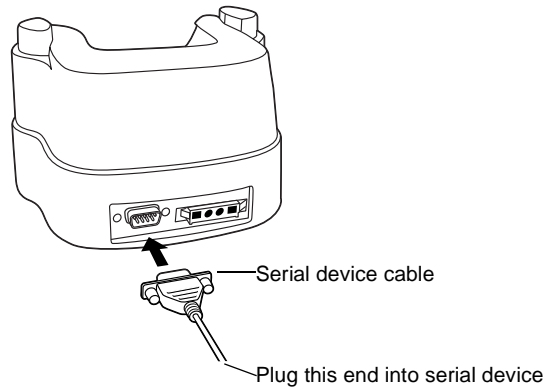
### Using ActiveSync

1. Install ActiveSync on your host computer. [Installing ActiveSync](#) on page 4-3.
2. Start ActiveSync on your host computer (*Start - Programs - Microsoft ActiveSync*). Click *File - Connection Settings* and ensure the following selections are made (select the appropriate COM port for your host PC):



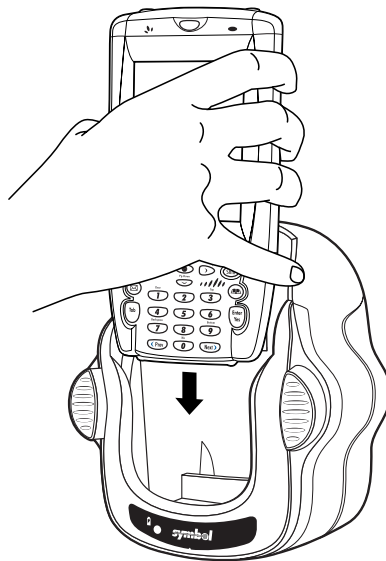
3. Tap *Start - ActiveSync - Tools - Options - PC* on your terminal and ensure **57600 Default** is selected from the *Enable synchronization when cradled using:* dropdown menu to temporarily disable serial cable detect before using ActiveSync.

4. Connect your cradle to a serial device, such as a printer as shown below:



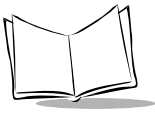
**Figure 4-16. Vehicle Cradle Connection to Serial Device**

5. Turn on the terminal and slide it into the cradle.



**Figure 4-17. Inserting the Terminal in the Vehicle Cradle**

6. If this is your first synchronization, follow the instructions on the host computer screen to setup the partnership. Items to be synchronized may be customized, and you may select to synchronize continuously as information changes, upon



connection, or manually by clicking the Sync button on the toolbar of your host computer.

---

**Note:** Every PDT 8000 terminal should have a unique name. Never try to synchronize more than one PDT 8000 terminal to the same user name.

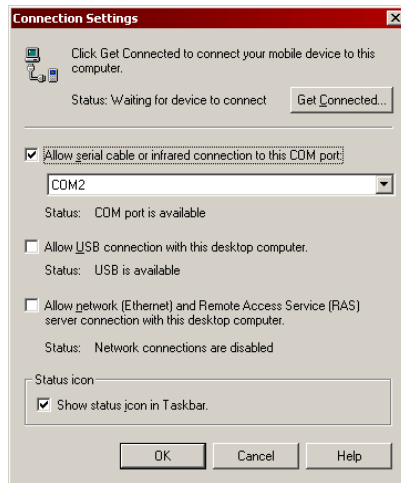
---

7. If you already created a partnership between your host computer and terminal, synchronization will occur automatically, immediately following step 5.

## Using the Magnetic Stripe Reader

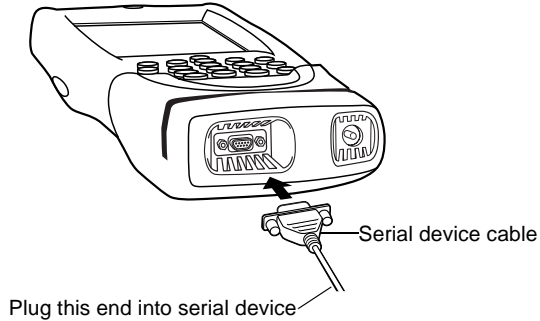
### Using ActiveSync

1. Install ActiveSync on your host computer.
2. Start ActiveSync on your host computer (*Start - Programs - Microsoft ActiveSync*). Click *File - Connection Settings* and ensure the following selections are made (select the appropriate COM port for your host PC):



3. Tap *Start - ActiveSync - Tools - Options - PC* on your terminal and ensure **57600 Default** is selected from the *Enable synchronization when cradled using:* drop-down menu to temporarily disable serial cable detect before using ActiveSync.
4. Tap *Start - Settings - System tab - Symbol Settings - Settings tab*. Select **Always On** from the *External 5 Volt Power* drop down menu to apply power to the COM port.

5. Connect your cradle to a serial device, as shown below:



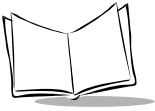
**Figure 4-18. Magnetic Stripe Reader Connection to Serial Device**

6. Turn on the terminal and slide it into the cradle.



**Figure 4-19. Attaching the Terminal to the Magnetic Stripe Reader**

7. If this is your first synchronization, follow the instructions on the host computer screen to setup the partnership. Items to be synchronized may be customized, and you may select to synchronize continuously as information changes, upon



connection, or manually by clicking the Sync button on the toolbar of your host computer.

---

**Note:** *Every PDT 8000 terminal should have a unique name. Never try to synchronize more than one PDT 8000 terminal to the same user name.*

---

8. If you already created a partnership between your host computer and terminal, synchronization will occur automatically, immediately following step 6.

## Using Printers

When using a printer attached to the serial port on the magnetic stripe reader, certain registry settings need to be changed allowing the printer to work correctly. Specifically:

HKEY\_LOCAL\_MACHINE\Drivers\Builtin\SymPrint\{Printer Type}\PrintPort

should be changed from “COM1: 9600” to “COM7: 9600” for any printer, for example, Zebra Series, Monarch, Oneil and Comtec. You may also need to edit “\Platform\printers.reg” so the settings are retained after a cold boot.

---

**Note:** *The serial port cannot be used while the magnetic stripe reader application has the COM port open, and the magnetic stripe reader application cannot read cards while the printer driver has the COM port open.*

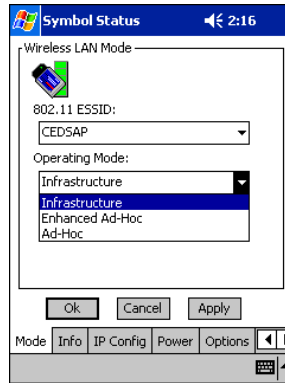
---



## Connecting to the Internet on a Wireless Network

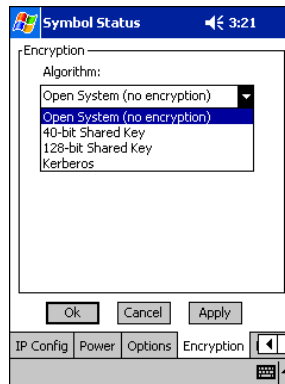
With a PDT 8046 terminal, you can connect to the Internet across a wireless network. To set up a wireless connection:

1. Tap the NICTT icon on the bottom right of the Today Screen.
2. In the Mode tab:

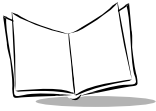


**Figure 4-20. NICTT - Mode Tab**

- a. Enter the 802.11 ESSID name.
- b. Make the appropriate selection from the *Operating Mode* drop-down menu.
3. Tap the Encryption tab.



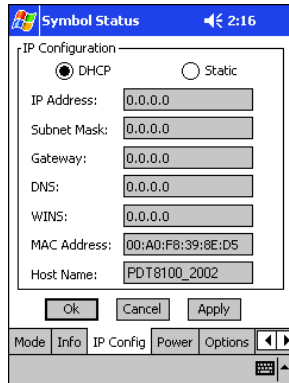
**Figure 4-21. NICTT - Encryption Tab**



4. Select the encryption algorithm used on the wireless network (*Open System, 40-bit Shared Key, 128-bit Shared Key or Kerberos*).

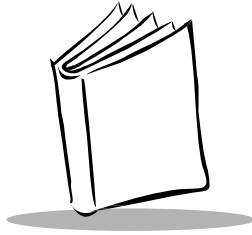
If you select 40-bit Shared Key, 128-bit Shared Key or Kerberos, enter the required data in the fields that appear in the window. See your network administrator for this information.

5. Tap the IP Config tab.



**Figure 4-22. NICTT - IP Config Tab (DHCP)**

6. Select either the *DHCP* or the *Static* button.  
If you select static IP, enter the required data in the fields that appear in the window. See your network administrator for this information.
7. Tap *OK*.
8. The NICTT status icon should indicate that the terminal is connected to the AP. If the status icon does not indicate that the terminal is connected to the AP, see your system administrator.
9. Select *Start - Programs - Internet Explorer*.
10. In the address bar, enter the URL.

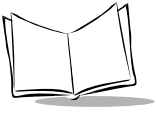


# Chapter 5 Applications

## Chapter Contents

---

Introduction .....	5-3
Calendar .....	5-3
Creating Appointments .....	5-4
Using the Summary Screen .....	5-5
Creating Meeting Requests .....	5-5
Contacts .....	5-6
Creating Contacts .....	5-7
Using the Summary Screen .....	5-8
Tasks .....	5-9
Creating Tasks .....	5-10
Using the Summary Screen .....	5-11
Notes .....	5-12
Creating Notes .....	5-13
Inbox .....	5-14
Synchronizing E-mail Messages .....	5-14
Connecting Directly to an E-mail Server .....	5-14
Setting Up an E-mail Service .....	5-15
Using the Message List .....	5-16
Creating E-mail Messages .....	5-18
Managing E-mail Messages and Folders .....	5-19
Folder Behavior with ActiveSync and Direct Connection to Server .....	5-19



*PDT 8000 Series Product Reference Guide*

## Introduction

---

The PDT 8000 Series terminal includes Calendar, Contacts, Tasks, Inbox, and Notes applications. You can use these programs individually or together. For example, e-mail addresses stored in Contacts can be used to address e-mail messages in Inbox.

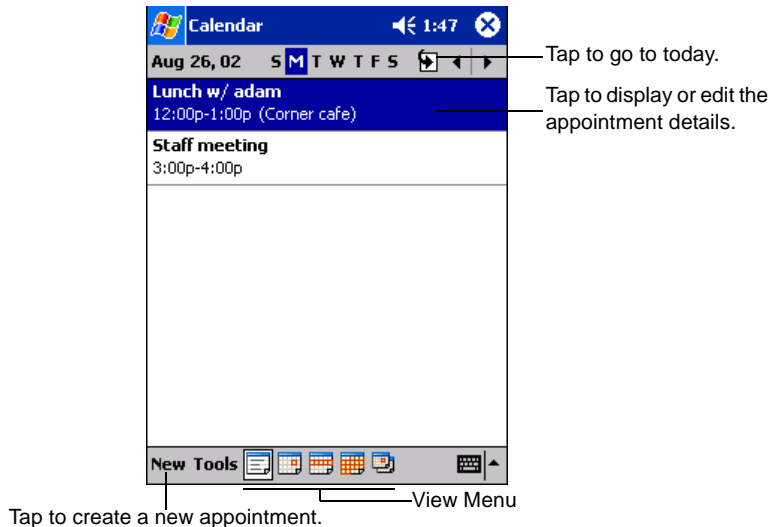
Using ActiveSync, you can synchronize information in these applications between your host computer and your terminal. Each time you synchronize, ActiveSync compares the changes you made on your terminal and host computer and updates both with the latest information. For information on using ActiveSync, see [Chapter 4, Communications](#), and ActiveSync Help on the host computer.

You can switch to any of these programs by tapping them on the *Start* menu.

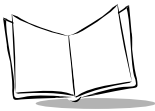
## Calendar

---

Use Calendar to schedule appointments, such as meetings. You can view your appointments in different ways (Agenda, Day, Week, Month, and Year) and easily change views using the *View* menu.



**Figure 5-1. Calendar Application**



---

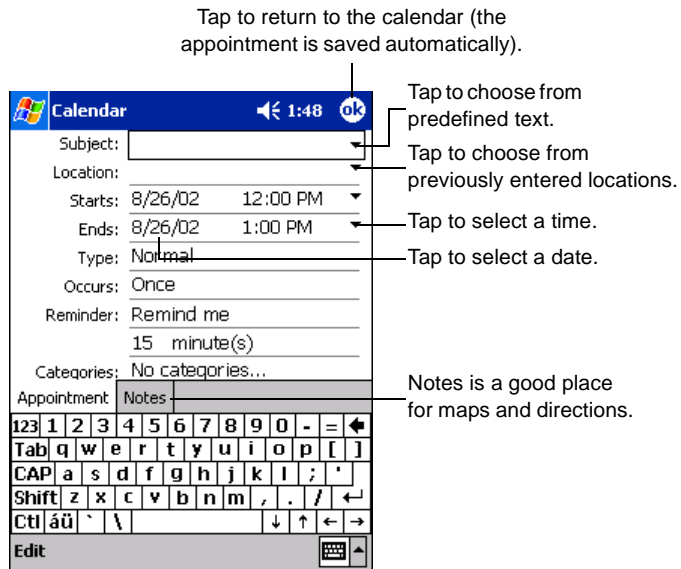
**Note:** You can customize the Calendar display, such as changing the first day of the week, by tapping Options on the Tools menu.

---

## Creating Appointments

To create an appointment:

1. To open Calendar, Tap *Start - Calendar*.
2. If you are in Day or Week view, tap the desired date and time for the appointment.
3. Tap *New*.



**Figure 5-2. Entering an Appointment**

4. Using the input panel, enter the subject and a location. Tap first to select the field.
5. If needed, tap the date and time to change them.
6. Enter other desired information. Hide the input panel to see all available fields.
7. To add notes, tap the *Notes* tab. You can enter text, draw, or create a recording. For more information on creating notes, see [Notes](#) on page 5-12.
8. When finished, tap *OK* to return to the calendar.

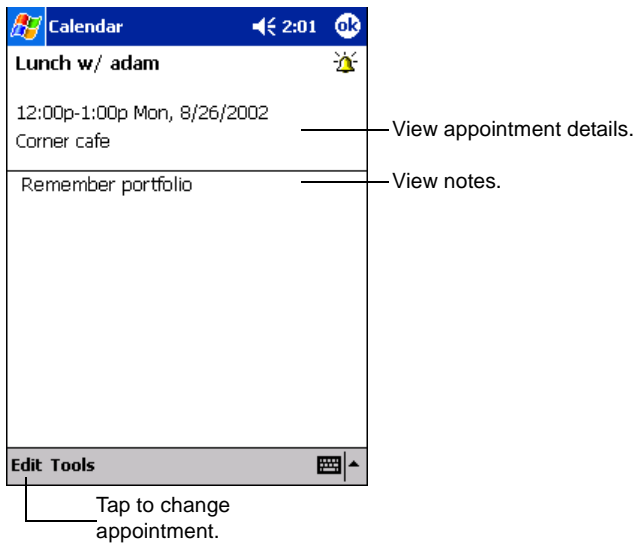
---

**Note:** If you select *Remind me* in an appointment, your terminal notifies you according to the options set in *Start - Settings - Personal tab - Sounds & Reminders*.

---

## Using the Summary Screen

When you tap an appointment in Calendar, a summary screen displays. Tap *Edit* to change the appointment.



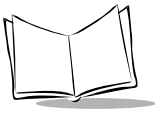
**Figure 5-3. Appointment Summary Screen**

## Creating Meeting Requests

You can use Calendar to set up meetings with users of Outlook or Pocket Outlook. The meeting notice is created automatically and sent either when you synchronize Inbox or when you connect to your e-mail server. Indicate how you want meeting requests sent by tapping *Tools - Options*. If you send and receive e-mail messages through ActiveSync, select *ActiveSync*.

To schedule a meeting:

1. Create an appointment.
2. In the appointment details, hide the input panel, then tap *Attendees*.



- From the list of e-mail addresses you've entered in Contacts, select the meeting attendees.

The meeting notice is created and placed in the Outbox folder. For more information on sending and receiving meeting requests, see Calendar Help and Inbox Help on your terminal.

## Contacts

Contacts maintains a list of associates and friends so you can easily locate information at home or on the road. Using the infrared (IR) port, you can share Contacts information with other terminal users.

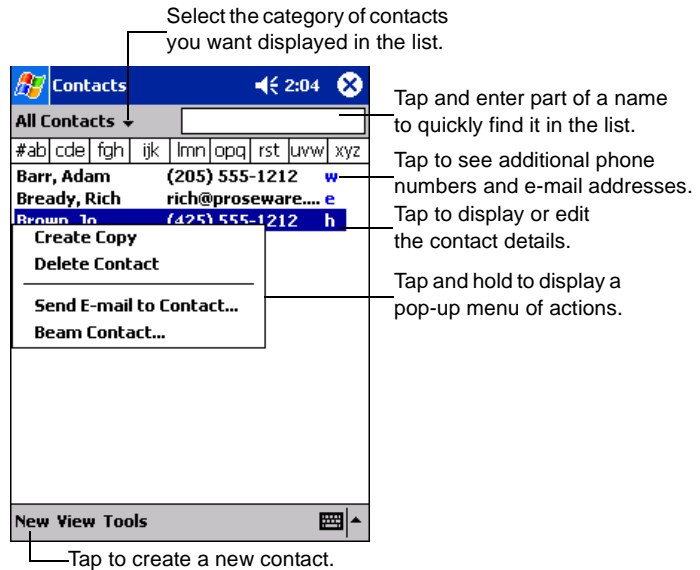


Figure 5-4. Contact Application

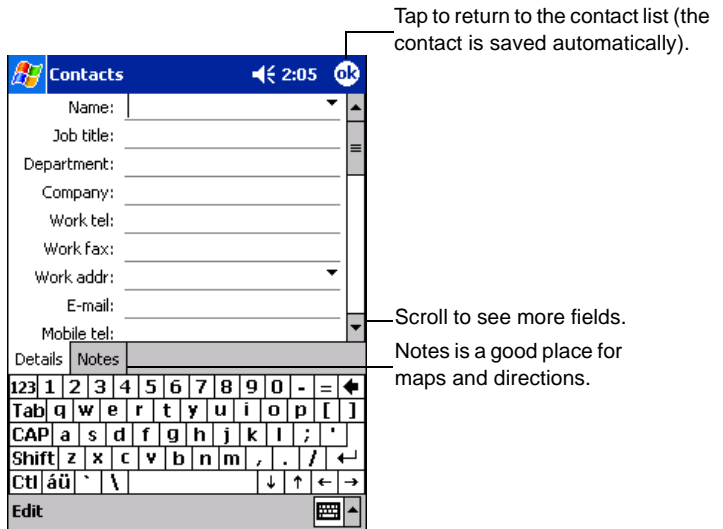
**Note:** To change the way information is listed, tap Tools - Options.



## Creating Contacts

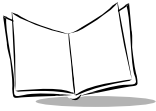
To create a contact:

1. Tap **New**.



**Figure 5-5. Creating a Contact**

2. Using the input panel, enter a name and other contact information. Scroll down to see all fields.
3. To assign the contact to a category, scroll to and tap *Categories*. Select a category from the list. In the contact list, you can display contacts by category.
4. To add notes, tap the *Notes* tab. You can enter text, draw, or create a recording. For more information on creating notes, see [Notes](#) on page 5-12.
5. When finished, tap **OK** to return to the contact list.

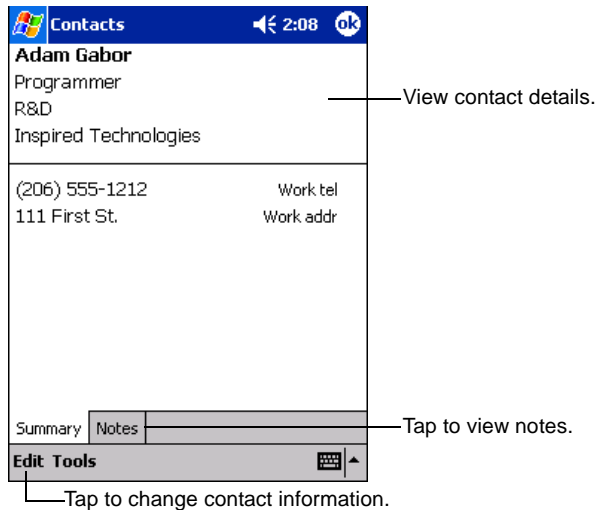


You may find a contact in one of four ways:

- In the contact list, enter a contact name in the box under the navigation bar. To show all contacts again, clear text from the box or tap the button to the right of the box.
- In the contact list, tap the category list (labeled All Contacts by default) and select the type of contact to display. To show all contacts again, select *All Contacts*. To view a contact not assigned to a category, select *None*.
- To view the names of companies your contacts work for, in the contact list, tap *View > By Company*. The number of contacts that work for that company appears to the right of the company name.
- Tap *Start - Find*, enter the contact name, select *Contacts* for the type, then tap *Go*.

## Using the Summary Screen

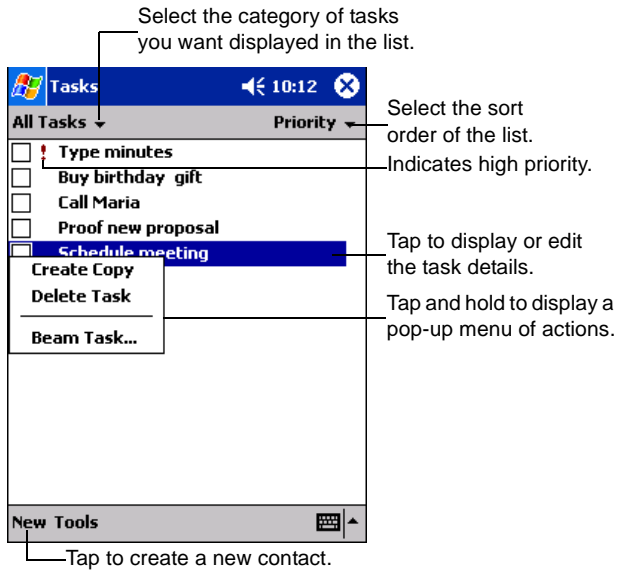
When you tap a contact in the contact list, a summary screen displays.



**Figure 5-6. Contacts Summary Screen**

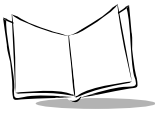
# Tasks

Use Tasks to keep a “to do” list.



**Figure 5-7. Task Application**

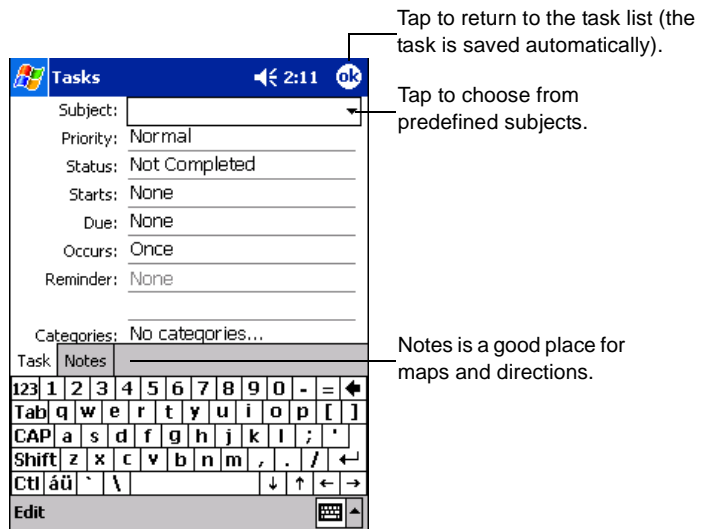
**Note:** To change the way information displays in the list, tap Tools - Options.



## Creating Tasks

To create a task:

1. Tap **New**.



**Figure 5-8. Creating a Task**

2. Using the input panel, enter a description.
3. You can enter a start date and due date or enter other information by first tapping the field. If the input panel is open, hide it to see all available fields.
4. To assign the task to a category, tap *Categories* and select a category from the list. In the task list, you can display tasks by category.
5. To add notes, tap the *Notes* tab. You can enter text, draw, or create a recording. For more information on creating notes, see [Notes](#) on page 5-12.
6. Tap **OK** to return to the task list.

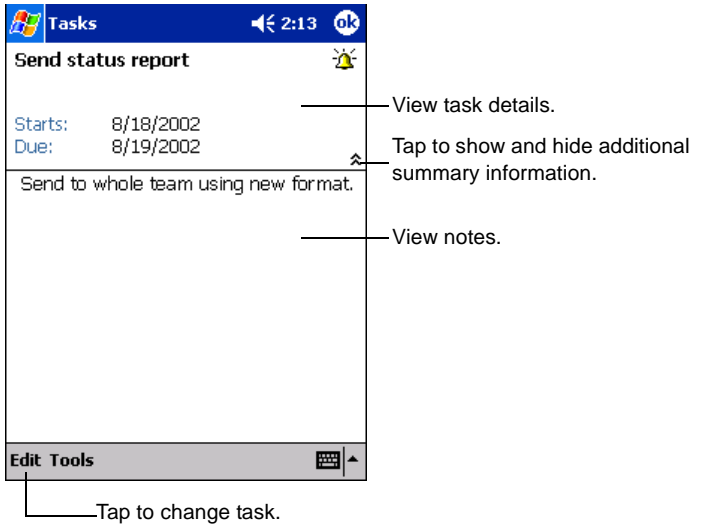
---

**Note:** To create a task with only a subject, tap *Entry Bar* on the *Tools* menu. Then tap *Tap* here to add a new task and enter your task information.

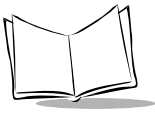
---

## Using the Summary Screen

When you tap a task in the task list, a summary screen displays. To change the task, tap *Edit*.

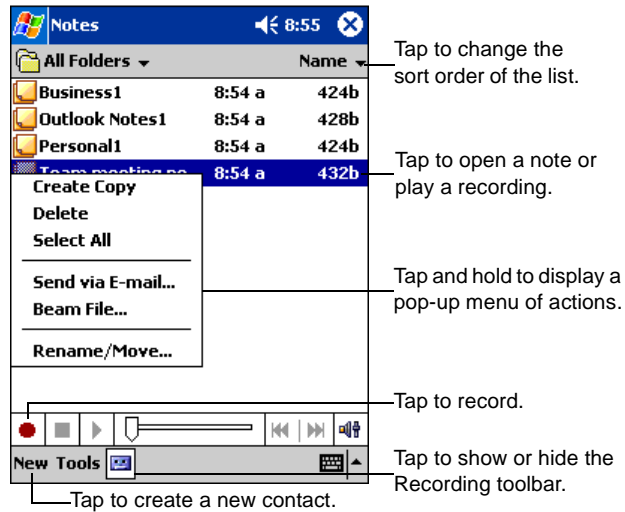


**Figure 5-9. Task Summary Screen**



## Notes

Capture thoughts, reminders, ideas, drawings and phone numbers with Notes. You can create a written note or a recording. You can also include a recording in a note. If a note is open when you create the recording, it is included in the note as an icon. If the note list is displayed, it is created as a stand-alone recording.

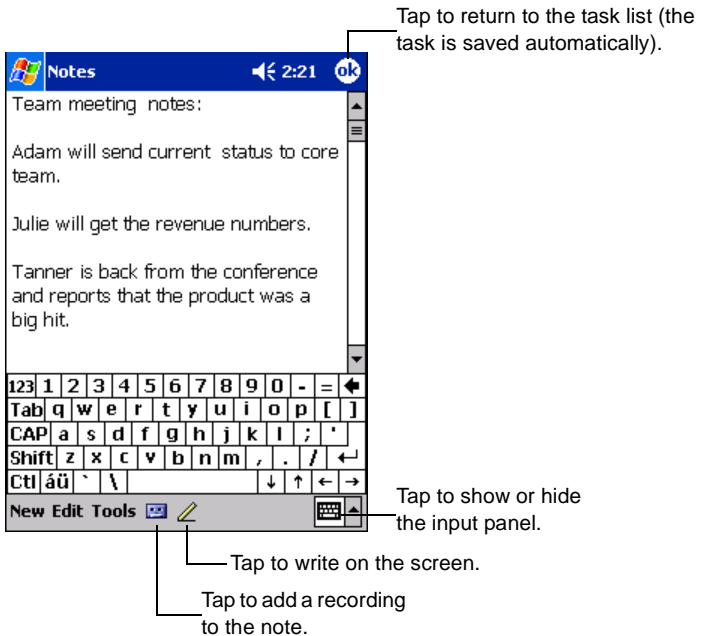


**Figure 5-10. Notes Application**

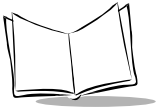
## Creating Notes

To create a note:

1. Tap **New**.
2. Create your note by writing, drawing, typing and recording. For more information about using the input panel, writing and drawing on the screen, and creating recordings, see [Chapter 2, Operating the Terminal](#).



**Figure 5-11. Creating a Note**



## Inbox

---

Use Inbox to send and receive e-mail messages in the following ways:

- Synchronize e-mail messages with Microsoft Exchange or Outlook on your host computer.
- Send and receive e-mail messages by connecting directly to an e-mail server through an Internet service provider (ISP) or a network.

### ***Synchronizing E-mail Messages***

To synchronize e-mail messages, first enable Inbox synchronization in ActiveSync options. For information on enabling Inbox synchronization, see ActiveSync Help on the host computer.

During synchronization:

- E-mail messages are copied from the Inbox folder of Exchange or Outlook on your host computer to the ActiveSync folder on your terminal. By default, you receive messages from the last 3 days only, the first 100 lines of each message, and file attachments of less than 100 KB in size.
- E-mail messages in the Outbox folder on your terminal are transferred to Exchange or Outlook, then sent from those programs.
- E-mail messages in subfolders must be selected in ActiveSync on your host computer to be transferred.

---

**Note:** *You can also synchronize e-mail messages with your host computer from a remote location through a modem connection. For more information, see [Using the Single-Slot Modem Cradle or the Snap-On Modem](#) on page 4-18.*

---

### ***Connecting Directly to an E-mail Server***

You can set up a connection to an e-mail server to send and receive e-mail messages using a modem or network connection and Inbox on your terminal.

---

**Note:** *The ISP or network must use a POP3 e-mail server and an SMTP gateway.*

---



When you connect to the e-mail server, new messages are downloaded to the terminal Inbox folder, messages in the terminal Outbox folder are sent, and messages that were deleted on the e-mail server are removed from the terminal Inbox.

Messages that you receive directly from an e-mail server are linked to your e-mail server rather than your host computer. When you delete a message on your terminal, it's also deleted from the e-mail server the next time you connect.

You can work online or offline. When working online, you read and respond to messages while connected to the e-mail server. Messages are sent as soon as you tap *Send*, which saves space on your terminal.

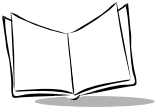
When working offline, once you've downloaded new message headers or partial messages, you can disconnect from the e-mail server, then decide which messages to download completely. The next time you connect, Inbox downloads the complete messages you've marked for retrieval and sends the messages you've created.

You can use multiple e-mail services to receive your messages. For each e-mail service you intend to use, first set up and name the e-mail service. If you use the same service to connect to different mailboxes, set up and name each mailbox connection.

## **Setting Up an E-mail Service**

In Inbox on your terminal, tap *Services - New Service*. Follow the instructions in the New Service wizard on the screen. For an explanation of a screen, tap *Start - Help*.

When finished, tap *Services - Connect* to connect to your e-mail server. For more information on using the Inbox program, see [Inbox](#) on page 5-14.



## Using the Message List

Messages you receive display in the message list. By default, the most recently received messages are listed first.

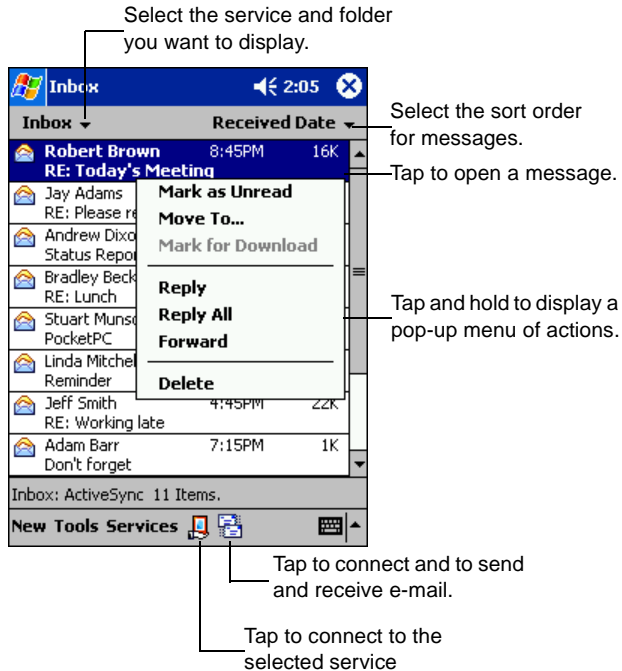
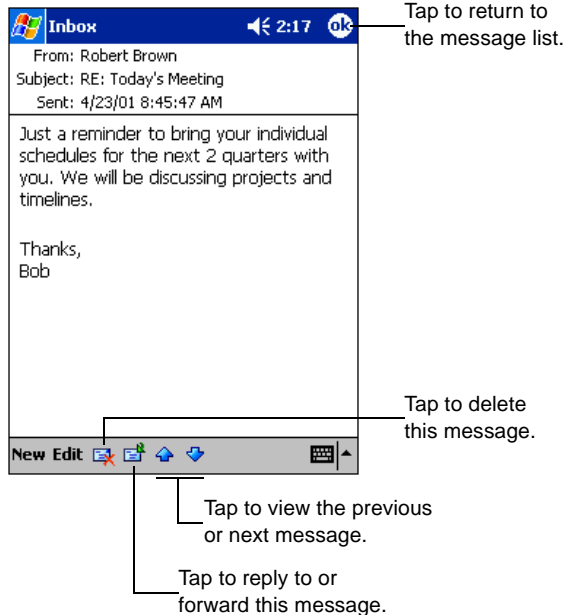


Figure 5-12. Inbox Application

When you receive a message, tap it in the list to open it. Unread messages display in bold.



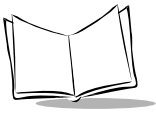
**Figure 5-13. Viewing a Message**

When you connect to your e-mail server or synchronize with your host computer, Inbox downloads by default only messages from the last 3 days, the first 100 lines of each new message, and file attachments of less than 100 KB in size. The original messages remain on the e-mail server or your host computer.

You can mark the messages that you want to retrieve completely the next time you synchronize or connect to your e-mail server. In the message list, tap and hold the message you want to retrieve. On the pop-up menu, tap *Mark for Download*. The icons in the Inbox message list indicates message status.

You specify your downloading preferences when you set up the service or select your synchronization options. You can change them at any time:

- Change options for Inbox synchronization using ActiveSync options. For more information, see ActiveSync Help.

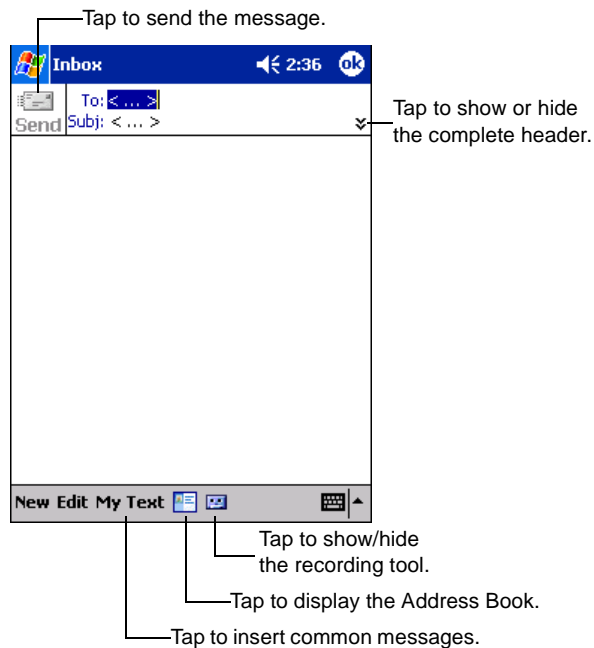


- Change options for direct e-mail server connections in Inbox on your terminal. Tap *Tools - Options*. On the *Service* tab, tap the service you want to change. Tap and hold the service and select *Delete* to remove it.

## Creating E-mail Messages

To create an e-mail message:

1. Tap *New*.
2. In the *To* field, enter an e-mail or SMS address of one or more recipients, separating each with a semicolon, or select a name from the contact list by tapping the *Address Book* button. All e-mail addresses entered in the e-mail fields in *Contacts* appear in the *Address Book*.



**Figure 5-14. Creating a Message**

3. Enter your message. To enter preset or frequently used messages, tap *My Text* and select a message.
4. Tap *Send* when you're finished. If you're working offline, the message is transferred to the *Outbox* folder and sent the next time you synchronize.

If you are sending an SMS message and want to know if it was received, tap *Edit - Options*, and select *Request SMS text message delivery notification* before sending the message.

## ***Managing E-mail Messages and Folders***

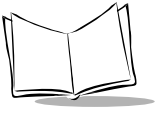
By default, messages are displayed in one of five folders for each service you've created: Inbox, Deleted Items, Drafts, Outbox, and Sent Items. The Deleted Items folder contains messages that have been deleted on the terminal. The behavior of the Deleted and Sent Items folders depends on the options you selected. In the message list, tap *Tools - Options*. On the *Message* tab, select your options.

To organize messages into additional folders, tap *Tools - Manage Folders* to create new folders. To move a message to another folder, in the message list, tap and hold the message, then tap *Move to* on the pop-up menu.

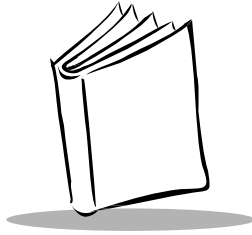
## **Folder Behavior with ActiveSync and Direct Connection to Server**

The behavior of the folders you create depends on whether you are using ActiveSync, SMS, POP3, or IMAP4.

- If you use ActiveSync, e-mail messages in the Inbox folder in Outlook are automatically synchronized with your terminal. You can select to synchronize additional folders by designating them for ActiveSync. The folders you create and the messages you move are mirrored on the server. For example, if you move two messages from the Inbox folder to a folder named Family, and you have designated Family for synchronization, the server creates a copy of the Family folder and copies the messages into that folder. You can then read the messages while away from your host computer.
- If you use SMS, messages are stored in the Inbox folder.
- If you use POP3 and you move e-mail messages to a folder you created, the link is broken between the messages on your terminal and their copies on the mail server. The next time you connect, the mail server notes the messages missing from the terminal Inbox and deletes them from the server. This prevents you from having duplicate copies of a message, but it also means that you no longer have access to messages moved to folders created from anywhere except the terminal.
- If you use IMAP4, the folders you create and the e-mail messages you move are mirrored on the server. Therefore, messages are available to you anytime you connect to your mail server, whether it is from your terminal or host computer. This synchronization of folders occurs whenever you connect to your mail server, create new folders, or rename/delete folders when connected.



*PDT 8000 Series Product Reference Guide*



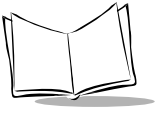
## Chapter 6

# Companion Programs

### Chapter Contents

---

Introduction .....	6-3
Pocket Word .....	6-3
Typing Mode .....	6-4
Writing Mode .....	6-6
Drawing Mode .....	6-6
Recording Mode .....	6-7
Pocket Excel .....	6-8
Tips for Working in Pocket Excel .....	6-9
MSN® Messenger .....	6-9
Setting Up Your Account .....	6-10
Working with Contacts .....	6-10
Chatting with Contacts .....	6-11
Windows Media Player .....	6-13
Microsoft Reader .....	6-13
Getting Books on Your Device .....	6-14
Using the Library .....	6-14
Reading a Book .....	6-15
Using Reader Features .....	6-15
Removing a Book .....	6-16
Infrared Receive .....	6-16



*PDT 8000 Series Product Reference Guide*



## Introduction

---

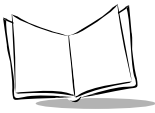
The PDT 8000 Series terminal contains the companion programs Microsoft Pocket Word, Microsoft Pocket Excel, MSN<sup>®</sup> Messenger, Windows Media Player, Microsoft Reader and Infrared Receive. To select a companion program, tap *Start - Programs*, then the program name.

## Pocket Word

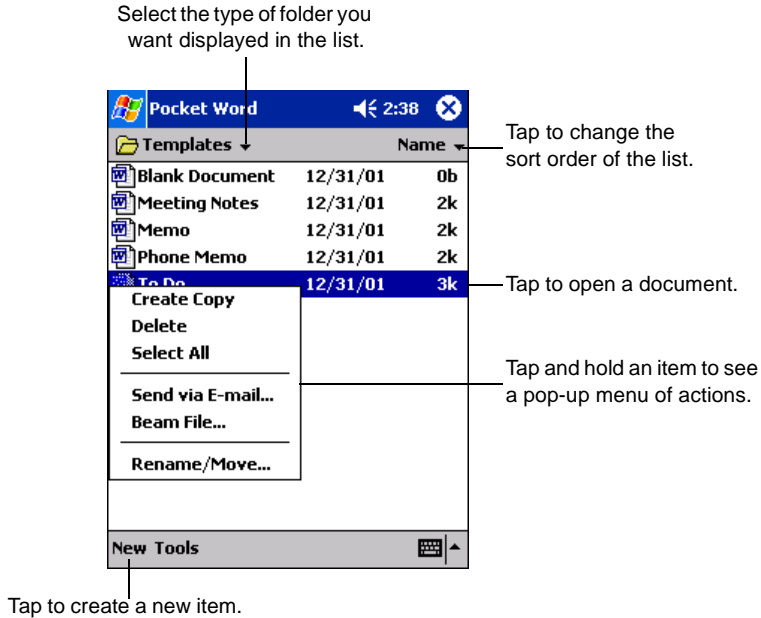
---

Pocket Word works with Microsoft Word on your host computer to give you access to copies of your documents. You can create new documents on the terminal, or copy documents from your host computer to your terminal. Synchronize documents between your host computer and the terminal so that you have the most up-to-date information in both locations.

To create a new document in Pocket Word, such as a letter, meeting minutes, or a trip report, tap *Start - Programs - Pocket Word - New*. A blank document appears. Or, if you've selected a template for new documents in the *Options* dialog box, that template appears with appropriate formatting applied. You can open only one document at a time; when you open a second document, you'll be asked to save the first. You can save a document in a variety of formats, including Word (.doc), Pocket Word (.psw), Rich Text Format (.rtf) and Plain Text (.txt).



Pocket Word contains a list of the files stored on your device. Tap a file in the list to open it. To delete, make copies of, or send a file, tap and hold a file in the list. Then, select the appropriate action on the pop-up menu.



**Figure 6-1. Using Pocket Word**

You can enter information in Pocket Word in one of four modes (writing, drawing, typing, and recording) displayed on the *View* menu. Tap the Show/Hide *Toolbar* button on the command bar to show or hide each mode's toolbar.

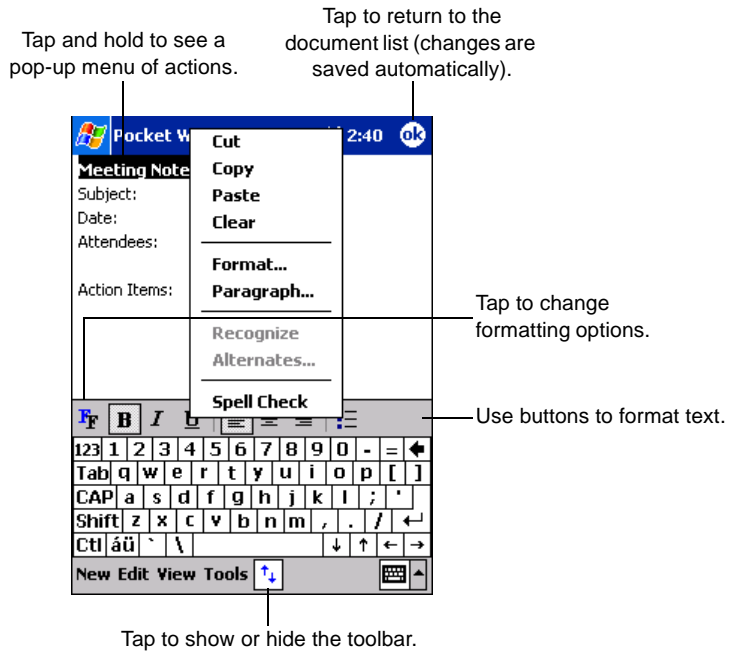
To change the zoom magnification, tap *View - Zoom*. Select the percentage. Select a higher percentage to enter text and a lower one to see more of your document.

If you're opening a Word document created on a host computer, select *Wrap to Window* on the *View* menu to see the entire document.

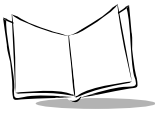
## Typing Mode

Use the input panel to enter typed text into a document. See [Entering Information](#) on page 2-12 for more information.

To format or edit text, select the text using your stylus instead of the mouse to drag across the text. To search a document for the text you want, tap *Edit - Find/Replace*.

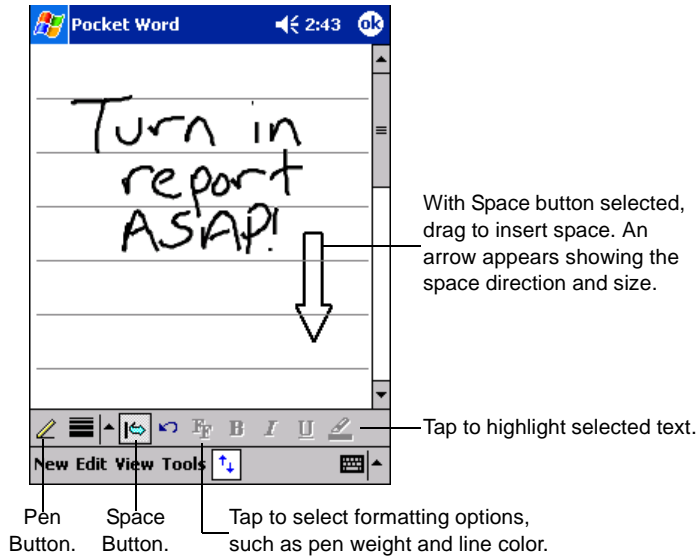


**Figure 6-2. Formatting Text**



## Writing Mode

In writing mode, use your stylus to write directly on the screen. Ruled lines are displayed as a guide, and the zoom magnification increases to allow you to write more easily. For more information, see [Writing on the Screen](#) on page 2-16.



**Figure 6-3. Writing on the Screen in Pocket Word**

If you cross three ruled lines in a single stylus stroke, the writing becomes a drawing, and can be edited and manipulated as described in the following section.

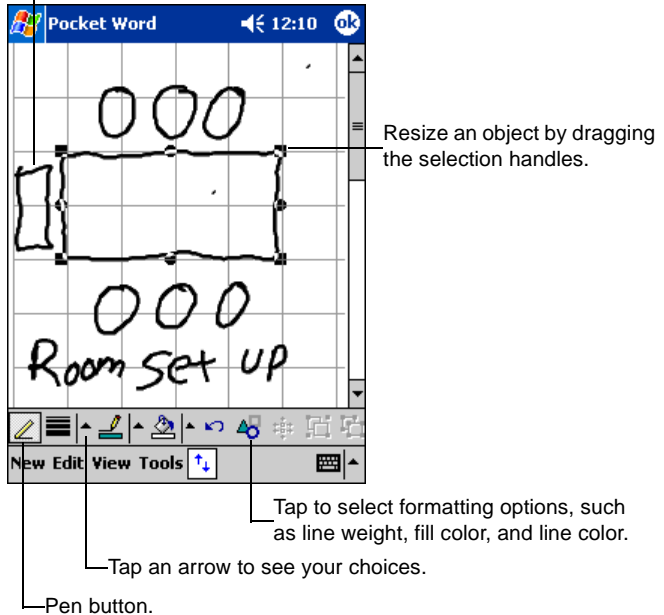
Written words are converted to graphics (metafiles) when a Pocket Word document is converted to a Word document on your host computer.

## Drawing Mode

In drawing mode, use your stylus to draw on the screen. Gridlines appear as a guide. When you lift your stylus after the first stroke, a drawing box indicates the boundaries of the

drawing. Every subsequent stroke within or touching the drawing box becomes part of the drawing. For more information, see [Drawing on the Screen](#) on page 2-20.

Select Shape on the pop-up menu to convert objects to proper shapes.

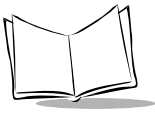


**Figure 6-4. Drawing on the Screen in Pocket Word**

## ***Recording Mode***

In recording mode, you may embed a recording into your document. Recordings are saved as .wav files. For more information, see [Recording a Message](#) on page 2-21.

For more information on using Pocket Word, tap *Start - Help*.



## Pocket Excel

Pocket Excel works with Microsoft Excel on your host computer to provide easy access to copies of your workbooks. You can create new workbooks on the terminal, or copy workbooks from your host computer to the terminal. Synchronize workbooks between your host computer and the terminal so you have up-to-date content in both locations.

To create a new workbook in Pocket Excel, such as an expense report or mileage log, tap *Start - Programs - Pocket Excel - New*. A blank workbook appears. Or, if you've selected a template for new workbooks in the *Options* dialog box, that template appears with appropriate text and formatting already provided. You can open only one workbook at a time; when you open a second workbook, you'll be asked to save the first. You can save a workbook in a variety of formats, including Pocket Excel (.pxl) and Excel (.xls).

Pocket Excel lists the files stored on the terminal. Tap a file in the list to open it. To delete, make copies of, or send a file, tap and hold a file in the list, then select the appropriate action from the pop-up menu.

Pocket Excel provides fundamental spreadsheet tools, such as formulas, functions, sorting, and filtering. To display the toolbar, tap *View - Toolbar*.

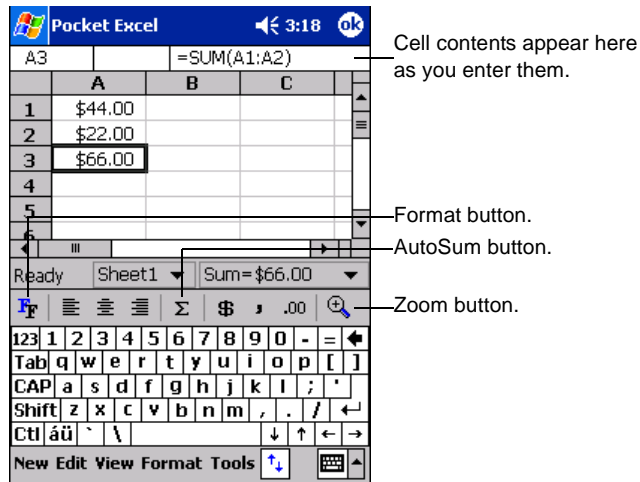


Figure 6-5. Using Pocket Excel

If your workbook contains sensitive information, you can protect it with a password. Open the workbook, tap *Edit - Password*. Every time you open the workbook, you must enter the password, so choose one easy for you to remember but hard for others to guess.

## ***Tips for Working in Pocket Excel***

When working in large worksheets in Pocket Excel:

- View in full-screen mode to see as much of your worksheet as possible. Tap *View - Full Screen*. To exit full-screen mode, tap *Restore*.
- Show and hide window elements. Tap *View*, then the elements you want to show or hide.
- Freeze panes on a worksheet. First select the cell where you want to freeze panes. Tap *View - Freeze Panes*. You may want to freeze the top and leftmost panes in a worksheet to keep row and column labels visible as you scroll through a sheet.
- Split panes to view different areas of a large worksheet. Tap *View - Split*. Drag the split bar to where you want it. To remove the split, tap *View - Remove Split*.
- Show and hide rows and columns. To hide a row or column, select a cell in that row or column. Tap *Format - Row or Column - Hide*. To show a hidden row or column, tap *Tools - Go To*, then type a reference that is in the hidden row or column. Tap *Format - Row or Column - Unhide*.

For more information on using Pocket Excel, tap *Start - Help*.

## **MSN<sup>®</sup> Messenger**

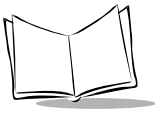
---

With the MSN Messenger instant messaging program on the terminal you can:

- see who is online
- send and receive instant messages
- have instant message conversations with groups of contacts.

To use MSN Messenger, you need a Microsoft Passport™ account or a Microsoft Exchange e-mail account. You need a Passport to use MSN Messenger Service. If you have a Hotmail® or MSN account, you already have a Passport. Once you have either a Microsoft Passport or a Microsoft Exchange account, you can set up your account.

To switch to MSN Messenger, tap *Start - Programs - MSN Messenger*.



## Setting Up Your Account

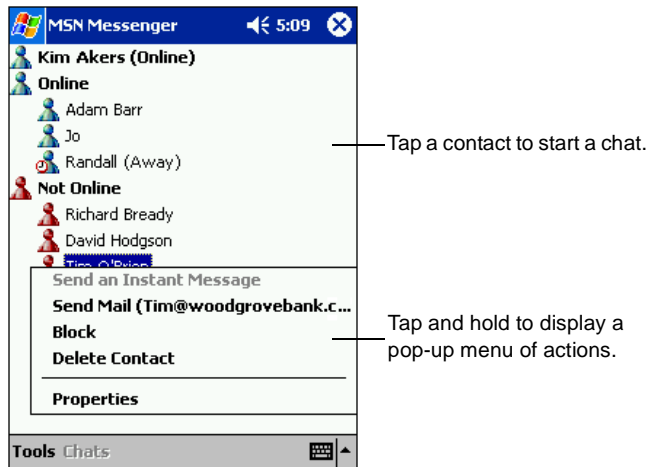
Before you can connect, set up the Passport or Exchange account and sign in:

1. Tap *Tools - Options*.
2. In the *Accounts* tab, enter your Passport or Exchange account information.
3. Tap the sign-in screen and enter your e-mail address and password.

If you use MSN Messenger on your host computer, your contacts automatically appear on your terminal.

## Working with Contacts

The MSN Messenger window is divided into Online and Not Online categories. From this view, while connected, you can chat, send e-mail, block the contact from chatting with you, or delete contacts from your list using the pop-up menu.



**Figure 6-6. MSN Messenger Contacts**

---

**Note:** *To see others online without being seen, tap Tools - My Status - Appear Offline. You appear offline but remain on the blocked contact's list.*

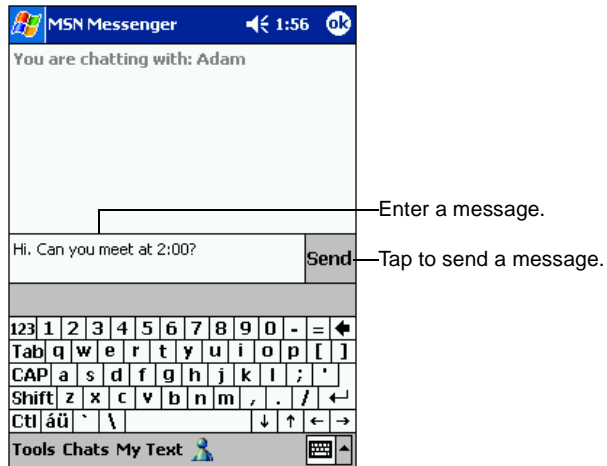
*To unblock a contact, tap and hold the contact, then tap Unblock on the pop-up menu.*

---



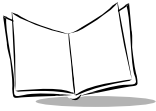
## Chatting with Contacts

Tap a contact name to open a chat window. Enter your message in the text entry area at the bottom of the screen, or tap *My Text* to enter a preset message, and tap *Send*. To invite another contact to a multi-user chat, tap *Tools - Invite* and tap the contact you want to invite.

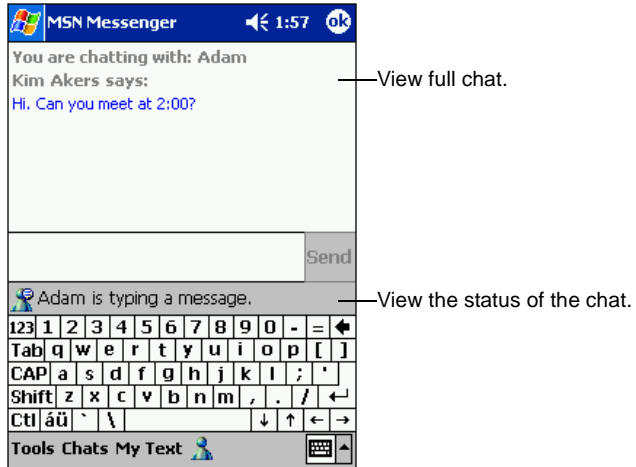


**Figure 6-7. Sending a Message**

To switch back to the main window without closing a chat, tap the *Contacts* button. To revert back to your chat window, tap *Chats* and select the person you were chatting with.



To know if the contact you are chatting with is responding, look for the message under the text entry area.



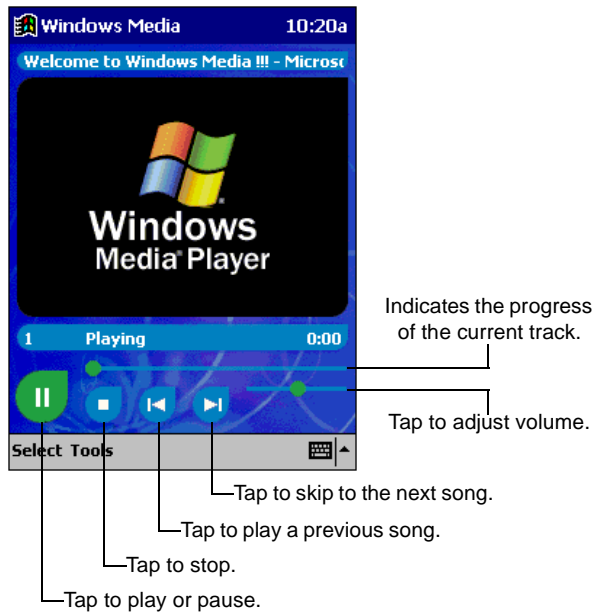
**Figure 6-8. Receiving a Message**

For more information on using MSN Messenger, tap *Start - Help*.

## Windows Media Player

---

With Windows Media Player on the terminal you can play digital audio and video files that are stored on your terminal. To switch to Windows Media Player, tap *Start - Programs - Windows Media*.



**Figure 6-9. Using Windows Media Player**

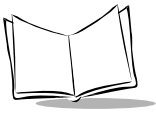
Use your host computer to copy digital audio and video files to your terminal. Your terminal can play Windows Media and MP3 files.

For more information on using Windows Media Player, tap *Start - Help*.

## Microsoft Reader

---

Use Microsoft Reader to read eBooks on your terminal. Download books to your host computer from your favorite eBook Web site. Then, use ActiveSync to copy the book files to the terminal. The books appear in the Reader Library, where you can tap them in the list to open them.



Each book consists of a cover page, an optional table of contents, and the pages of the book. You can:

- Page through the book by using the Up/Down control on your device or by tapping the page number on each page.
- Annotate the book with highlighting, bookmarks, notes and drawings.
- Search for text and look up definitions for words.

To switch to Microsoft Reader, tap *Start - Programs - Microsoft Reader*.

## Getting Books on Your Device

You can download book files from the Web. Just visit your favorite eBook retailer and follow the instructions to download the book files. Use ActiveSync to download the files from your host computer to the terminal as described in the Read Me file in the MSReader folder.

## Using the Library

The Library is your Reader home page; it displays a list of all books stored on the terminal. To open the Library:

1. On the Reader command bar, tap *Library*.
2. On a book page, tap the book title, and then tap *Library* on the pop-up menu.
3. To open a book, tap its title in the Library list.

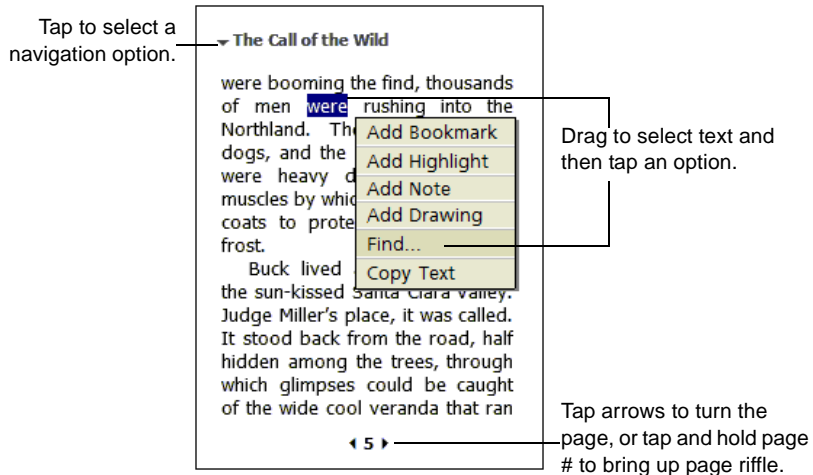


## Reading a Book

Each book consists of a cover page, an optional table of contents and the pages of the book. Navigation options are listed in the bottom portion of the cover page.

The first time you open a book, you'll probably want to go to the first page or to the table of contents, if there is one. Subsequently, whenever you open the book, you'll be automatically taken to the last page read.

In addition to the text, each book page includes a page number and book title.

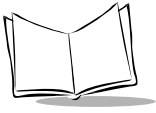


You can also page through a book using the Up/Down arrow keys on the keyboard of the terminal.

## Using Reader Features

Reading a book electronically gives you several options not available with paper books. These options are available from any book page.

- Select text by dragging across the text on the page. Then, tap an option on the pop-up menu, as described here:
  - Search for Text. Find text in a book by tapping *Find* on the pop-up menu. Enter the word you want to search for, and tap the desired Find option. Reader highlights found text on the page. To close Find, tap outside the box. To return to your original page, tap the title and then tap *Return* on the pop-up menu.
  - Copy Text. You can copy text from books that support this feature into any



program that accepts text. On a book page, select the text you want to copy and tap *Copy Text* on the pop-up menu. The text can be pasted into the program of your choice.

- **Bookmarks.** When you add a bookmark to a book, a color-coded bookmark icon appears in the right margin. You can add multiple bookmarks to a book. Then, from anywhere in the book, tap the bookmark icon to go to the bookmarked page.
- **Highlights.** When you highlight text, it appears with a colored background.
- **Notes.** When you attach a note to text, you enter the text in a note pad that appears on top of the book page. A Note icon will display in the left margin. To show or hide the note, tap the icon.
- **Drawings.** When you add a drawing, a Drawing icon appears in the bottom-left corner of the page, and drawing tools appear across the bottom of the page. Draw by dragging your stylus.
- To see a list of a book's annotations, including bookmarks, highlights, text notes and drawings, tap *Annotations Index* on the book's cover page. You can tap an entry in the list to go to the annotated page.

## ***Removing a Book***

When you finish reading a book, you can delete it to conserve space on the terminal. If a copy of the book is stored on your host computer, you can download it again at any time.

To remove a book from your device, tap and hold the title in the Library list, and then tap *Delete* on the pop-up menu.

For more information on using Microsoft Reader, tap *Start - Help*.

## **Infrared Receive**

---

Using Infrared Receive (IR), you can send and receive information, such as contacts and appointments, between two Windows-powered devices.

To send information:

1. Open the program where you created the item you want to send and locate the item in the list.
2. Align the IR ports so that they are unobstructed and within close range.
3. Tap and hold the item, and tap *Beam [item]* on the pop-up menu.

---

**Note:** *You can also send items, but not folders, from File Explorer. Tap and hold the item, then tap Beam File on the pop-up menu.*

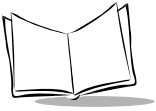
---

To receive information, align the IR ports so that they are unobstructed and within close range. When information is sent from the other device, your terminal receives it automatically.

---

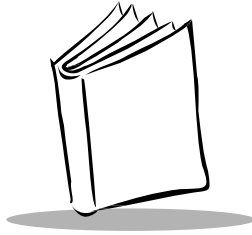
**Note:** *In order for IR receive to work automatically, you must first select the Receive all incoming beams and select discoverable mode checkbox in Start - Settings - Connections - Beam. If this box is not selected, tap Start - Programs - Infrared Receive before receiving data from another device.*

---



*PDT 8000 Series Product Reference Guide*





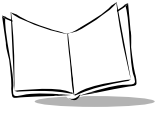
# Chapter 7

## *Pocket Internet Explorer*

### **Chapter Contents**

---

Introduction .....	7-3
Connect to an ISP .....	7-3
Browsing the Web .....	7-3
Mobile Favorites .....	7-4
Favorite Links .....	7-4
Creating Mobile Favorites .....	7-4
Saving Memory on your Terminal .....	7-5
Using AvantGo Channels .....	7-5
Using Pocket Internet Explorer .....	7-6



*PDT 8000 Series Product Reference Guide*

## Introduction

---

With Microsoft Pocket Internet Explorer, you can view Web or WAP pages in the following ways:

- Connect to an Internet service provider (ISP) or network and browse the Web.
- During synchronization with your host computer, download your favorite links and mobile favorites stored in the Mobile Favorites subfolder in Internet Explorer on the host computer.

To select Pocket Internet Explorer, tap *Start - Internet Explorer*.

## Connect to an ISP

---

There are several ways to create a connection to an ISP and browse the web. See detailed instructions for one of the options below:

- modem connection, see [Using the Single-Slot Modem Cradle or the Snap-On Modem](#) on page 4-18
- ethernet connection, see [Using a Four-Slot USB-to-Ethernet Cradle](#) on page 4-25
- Spectrum 24 connection, see [Connecting to the Internet on a Wireless Network](#) on page 4-39
- GPRS connection, see [Establish a GPRS Connection](#) on page 10-3
- GSM connection, see [Establish a GSM CSD Connection](#) on page 10-21.

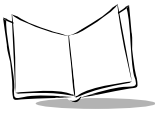
## Browsing the Web

Once connected, go to a specific Web page in one of the following ways:

- Tap the **Favorites** button, then tap the favorite you want to view.
- Tap *View - Address Bar*. In the address bar at the top of the screen, enter the Web address and tap **Go**.

---

**Note:** *If you select Pocket Internet Explorer before setting up the network connections, a screen may appear allowing you to proceed to the connection settings screen. After you select your settings, you return to Pocket Internet Explorer.*



To add a favorite link while using the terminal, go to the Web page you want to add, tap and hold on the page, and tap Add to Favorites.

---

## Mobile Favorites

---

Items stored in the Mobile Favorites subfolder in the Favorites folder in Internet Explorer on the host computer are synchronized with the terminal. This folder is created automatically when ActiveSync is installed.

### Favorite Links

Synchronization updates the list of favorite links both in the Mobile Favorites folder on your host computer and in Pocket Internet Explorer on your terminal. Unless you mark the favorite link as a mobile favorite, only the link is downloaded to your terminal; you must connect to your ISP or network to view the content. For more information on synchronization, see [Chapter 4, Communications](#) or the ActiveSync Help on the host computer.

### Creating Mobile Favorites

If you are using Microsoft Internet Explorer 5 or later on your host computer, you can download mobile favorites. Synchronizing mobile favorites downloads Web content to your terminal so you can view Web pages while disconnected from your ISP and host computer.

Use the Internet Explorer plug-in installed with ActiveSync to create mobile favorites:

1. In Internet Explorer on your host computer, click *Tools - Create Mobile Favorite*.
2. To change the link name, enter a new name in the *Name* box.
3. If desired, select a desired update schedule in *Update*.
4. Click *OK*. Internet Explorer downloads the latest version of the Web page to your host computer.
5. To download the pages linked to the mobile favorite you just created, in Internet Explorer on the host computer, right-click the mobile favorite, then click *Properties*. On the *Download* tab, specify the number of links deep you want to download. To conserve terminal memory, only go one level deep.
6. Synchronize your terminal and host computer. Mobile favorites stored in the Mobile Favorites folder in Internet Explorer are downloaded to your terminal. If you did not specify an update schedule in step 3, you must manually download content to keep the information updated on your host computer and terminal.

Before synchronizing, in Internet Explorer on your host computer, click *Tools - Synchronize*. Note the last time content was downloaded to the host computer; if necessary, manually download content.

You can add a button to the Internet Explorer toolbar for creating mobile favorites. In Internet Explorer on your host computer, click *View - Toolbars - Customize*.

## ***Saving Memory on your Terminal***

Mobile favorites take up storage memory on your terminal. To minimize the amount of memory used:

- In the settings for the Favorites information type in ActiveSync options, turn off pictures and sounds or stop some mobile favorites from downloading. For more information, see ActiveSync Help.
- Limit the number of downloaded linked pages. In Internet Explorer on the host computer, right-click the mobile favorite you want to change, then select *Properties*. On the *Download* tab, specify 0 or 1 for the number of linked pages to download.

## **Using AvantGo Channels**

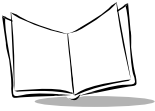
---

AvantGo is a free interactive service that gives you access to personalized content and thousands of popular Web sites. Subscribe to AvantGo channels directly from your terminal, then synchronize with your host computer, or connect to the Internet to download the content. For more information, visit the AvantGo Web site.

To sign up for AvantGo:

1. In ActiveSync options on the host computer, turn on synchronization for the AvantGo information type.
2. In Pocket Internet Explorer on your terminal, tap the *Favorites* button to display your list of favorites.
3. Tap the *AvantGo Channels* link.
4. Tap the *Activate* button.
5. Follow the directions on the screen. You must synchronize your terminal with your host computer, then tap the *My Channels* button to complete setup.

When synchronization is complete, tap the *AvantGo Channels* link in your list of favorites to see a few of the most popular channels. To add or remove channels, tap the *Add* or *Remove* link.



## Using Pocket Internet Explorer

With Pocket Internet Explorer, you can browse mobile favorites and channels downloaded to your terminal without connecting to the Internet. You can also connect to the Internet through an ISP or a network connection and browse the Web.

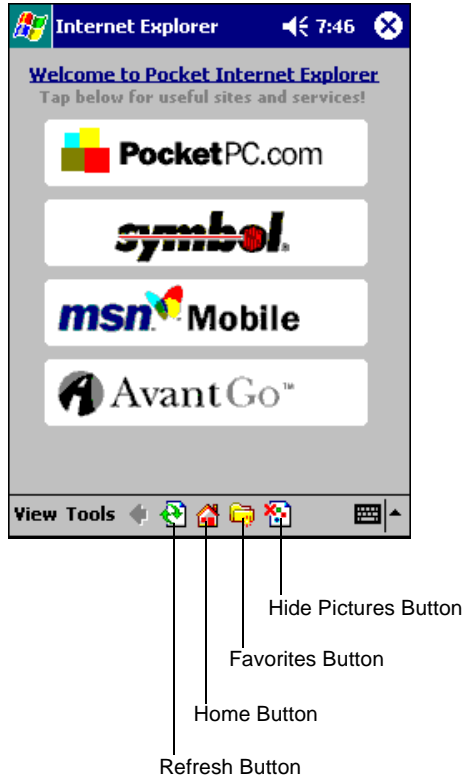
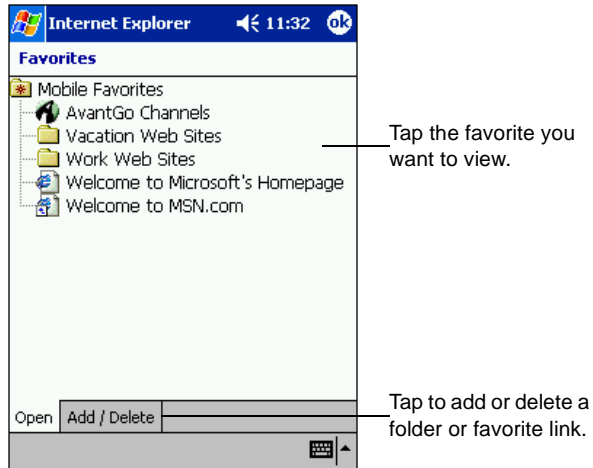


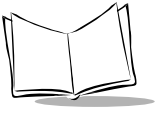
Figure 7-1. Pocket Internet Explorer

To view mobile favorites and channels, tap the **Favorites** button to display your list of favorites, then tap the page you want to view.



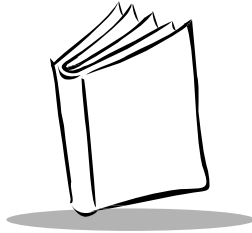
**Figure 7-2. Mobile Favorites**

You'll see the page that was downloaded the last time you synchronized with your host computer. If the page is not on your terminal, the favorite is dimmed. Synchronize with your host computer again to download the page to your terminal, or connect to the Internet to view the page.



*PDT 8000 Series Product Reference Guide*





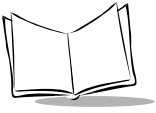
# *Chapter 8*

## *AirBEAM*

### **Chapter Contents**

---

Introduction .....	8-3
AirBEAM Package Builder .....	8-3
AirBEAM Client .....	8-4
AirBEAM License .....	8-4
Configuring the AirBEAM Client .....	8-4
Packages(1) Tab .....	8-5
Packages(2) Tab .....	8-5
Server Tab .....	8-6
Misc(1) Tab .....	8-7
Misc(2) Tab .....	8-9
Misc(3) Tab .....	8-10
Synchronizing with the Server .....	8-10
Manual Synchronization .....	8-11
Automatic Synchronization .....	8-11
AirBEAM Staging .....	8-12



*PDT 8000 Series Product Reference Guide*

## Introduction

---

The AirBEAM product allows specially designed software packages to be transferred between a host server and Symbol wireless handheld devices. Before transfer, AirBEAM checks and compares package version, so that only updated packages are loaded.

AirBEAM resides on radio-equipped client devices, and allows them to request, download and install software, as well as to upload files and status data. Both download and upload of files can be accomplished in a single communications session. The ability to transfer software over a radio network can greatly reduce the logistical efforts of client software management.

In an AirBEAM system, a network-accessible host server acts as the storage point for the software transfer. The AirBEAM client uses the industry standard FTP or TFTP file transfer protocols to check the host system for updates, and if necessary, to transfer updated software.

## AirBEAM Package Builder

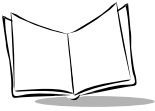
---

In a typical distributed AirBEAM system, software to be transferred is organized into packages. In general, an AirBEAM package is simply a set of files that are assigned attributes both as an entire package and as individual component files. The package is assigned a version number, and the transfer occurs when an updated version is available.

An AirBEAM package can optionally contain developer-specified logic to be used to install the package. Installation logic is typically used to update client device FLASH images or radio firmware. Examples of common AirBEAM packages would include packages for custom client application software, radio firmware and AirBEAM client software.

Once these packages are built, they are installed on the host server for retrieval by the handheld device. The AirBEAM Package Builder is a utility used to define, generate and install AirBEAM packages to a server. The packages are then loaded from the server onto a client device equipped with an AirBEAM client executable.

For detailed instructions on how to define, generate and install AirBEAM packages to the server, refer to the *AirBEAM Package Builder Product Reference Guide*, p/n 72-55769-xx.



## AirBEAM Client

---

The AirBEAM Client is installed on the terminal. It is configured with the server access information, the names of the packages to be downloaded and other controlling parameters. When the Client is launched, the device connects to the specified FTP server and checks the packages it is configured to look for. If the package version has been updated, the client requests the transfer.

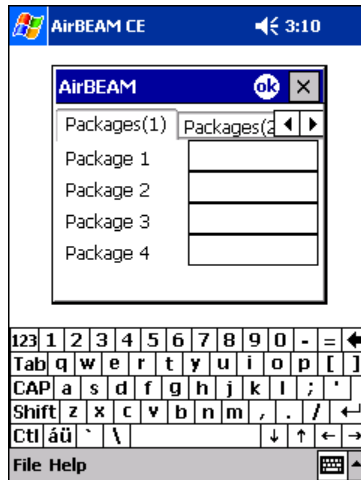
### ***AirBEAM License***

The AirBEAM client is a licensed software product. The AirBEAM client's version synchronization functionality is enabled through a license key file that is stored on the client device. The license key file can be built into AirBEAM client's image, or downloaded in a special AirBEAM package.

The AirBEAM license key file contains a unique key and a customer specific banner that is displayed when the AirBEAM client version synchronization logic is invoked.

### ***Configuring the AirBEAM Client***

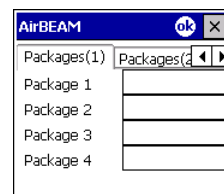
1. Tap *Start - Programs*.
2. Select the AirBEAM Client icon.
3. Tap *File - Configure*. The AirBEAM Configuration Dialog box appears.



The Configuration Dialog box is used to view and edit AirBEAM client configurations. This dialog box has six tabs that you can modify - Packages(1), Packages(2), Server, Misc(1), Misc(2) and Misc(3).

## Packages(1) Tab

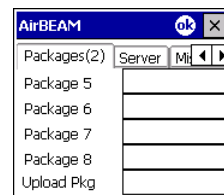
This tab is used to specify the package name of the first four of eight packages that are to be loaded during the AirBEAM synchronization process. The specified package name must correspond to a package that is available on the specified package server.



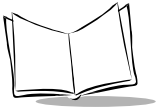
Field	Description
Package 1	Package name of the first of eight packages. This is an optional field.
Package 2	Package name of the second of eight packages. This is an optional field.
Package 3	Package name of the third of eight packages. This is an optional field.
Package 4	Package name of the fourth of eight packages. This is an optional field.

## Packages(2) Tab

This tab is used to specify the package name of the last four of eight packages that are to be loaded during the AirBEAM synchronization process. The specified package name must correspond to a package that is available on the specified package server.



Field	Description
Package 5	Package name of the fifth of eight packages. This is an optional field.
Package 6	Package name of the sixth of eight packages. This is an optional field.
Package 7	Package name of the seventh of eight packages. This is an optional field.
Package 8	Package name of the eighth of eight packages. This is an optional field.
Upload Pkg	Package name of a package that is to be processed for "upload files" during the AirBEAM synchronization process. The specified package name must correspond to a package that is available on the specified package server. This is an optional field.



## Server Tab

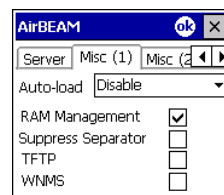
This tab is used to specify the configurations of the server to which the client will connect during the package synchronization process.

AirBEAM Server configuration dialog box showing fields for IP Address, Directory, User, and Password.

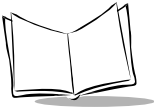
Field	Description
IP Address	The IP Address of the server. It may be a host name or a dot notation format.
Directory	The directory on the server that contains the AirBEAM package definition files. All AirBEAM package definition files are retrieved from this directory during the package synchronization process.
User	The FTP user name that will be used during the login phase of the package synchronization process.
Password	The FTP password that corresponds to the FTP user specified in the <b>User</b> field. The specified password will be used during the login phase of the package synchronization process.

## Misc(1) Tab

This screen is used to configure various miscellaneous features.



Field	Description
Auto-load	<p>This drop-down menu is used to specify how the AirBEAM client is to be invoked automatically when the client device is rebooted. The selections are:</p> <p><b>Disable:</b> the AirBEAM client is not invoked automatically during the boot sequence.</p> <p><b>Interactive:</b> the AirBEAM client is invoked automatically during the boot sequence. The package synchronization process is started automatically. The <i>Synchronization Dialog</i> box is displayed, and the user is required to press the <b>OK</b> button when the process is complete.</p> <p><b>Non-interactive:</b> the AirBEAM client is invoked automatically during the boot sequence. The package synchronization process is started automatically. The <i>Synchronization Dialog</i> box is displayed, but the user is not required to press the <b>OK</b> button when the process is complete. The Synchronization Dialog box terminates automatically.</p> <p><b>Background:</b> the AirBEAM client is invoked automatically during the boot sequence. The package synchronization process is started automatically. Nothing is displayed while the synchronization process is occurring.</p>
RAM Management	<p>This checkbox specifies whether the automatic RAM management will be enabled during the package synchronization process.</p> <p>If enabled, RAM management logic will be invoked when there is not enough free disk space to download a package. The RAM management logic will attempt to remove any discardable AirBEAM packages resident on the client.</p>



Field	Description
Suppress Separator	<p>This checkbox specifies whether the automatic insertion of a file path separator character should be suppressed when the client generated server package definition file names.</p> <p>When enabled, the parameter also disables the appending of .apd to the package. This feature is useful for AS/400 systems, in which the file path separator character is a period. When this feature is enabled, the server directory (Directory) and package name (Package 1, Package 2, Package 3, and Package 4) are appended "as is" when building the name for the server package definition file.</p> <p>When this feature is disabled, a standard file path separator is used to separate the server directory (Directory) and package name (Package 1, Package 2, Package 3, and Package 4) when building the name for the server package definition file. In addition, an .apd extension is appended automatically.</p>
TFTP	<p>This checkbox specifies whether the TFTP protocol is to be used to download files. By default, the AirBEAM client will use the FTP protocol.</p>
WNMS	<p>This checkbox specifies whether the AirBEAM client will upload a WNMS information file at the end of each version synchronization.</p>

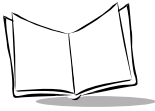


## Misc(2) Tab

This screen is used to configure various miscellaneous features.

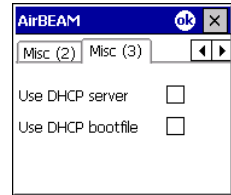


Field	Description
Auto-retry	<p>This field is used to specify whether the AirBEAM client will automatically retry if there is a failure during the synchronization process.</p> <p>If this feature is enabled, the AirBEAM Client will display a popup dialog indicating that a retry will be attempted. The popup dialog is displayed for the number of seconds specified in the Retry delay field.</p> <p>The valid values for this field are:</p> <ul style="list-style-type: none"> <li><u>-1</u>: the AirBEAM client will automatically retry indefinitely.</li> <li><u>0</u>: the AirBEAM client will not automatically retry.</li> <li><u>&gt;0</u>: the AirBEAM client will automatically retry up to the number of times specified.</li> </ul>
Retry Delay	<p>This field specifies the amount of time, in seconds, that the AirBEAM client will delay before automatically retrying after a synchronization failure.</p>
In-use Test	<p>This checkbox specifies whether the AirBEAM client will test to determine if a file is in-use before downloading. If the In-use Test feature is enabled the AirBEAM client will download a temporary copy of any files that are in-use. If any temporary in-use files are downloaded the AirBEAM client will automatically reset the client to complete the copy of the in-use files. If the In-use Test feature is disabled the synchronization process will fail (-813) if any download files are in-use.</p>
Wait Welcome	<p>This checkbox specifies whether the AirBEAM client will wait for the WELCOME screens to be completed before automatically launching the synchronization process after a reset.</p>
Close Apps	<p>This checkbox specifies whether the AirBEAM client automatically attempts to close non-system application prior to resetting the mobile unit. If enabled the AirBEAM client will send a WM_CLOSE message to all non-system applications before resetting the mobile unit. This feature offers applications the opportunity to prepare (i.e. close open files) for the pending reset.</p>



## Misc(3) Tab

This screen is used to configure various miscellaneous features.



Field	Description
Use DHCP server	This check box control specifies whether the AirBEAM client will use the DHCP response option 66 to specify the <i>IP address</i> of the FTP/TFTP server. If enabled, special RF network registry settings are required to force the DHCP server to return the "TFTP server name" field (option 66). The special RF network registry settings are included, but commented out, in the radio network registry initialization files (essid_xxxx_yy.reg).
Use DHCP bootfile	This check box control specifies whether the AirBEAM client will use the DHCP response option 67 to specify the <i>Package</i> and <i>Package 1</i> parameters. If enabled, special RF network registry settings are required to force the DHCP server to return the "Bootfile name" field (option 67). The special RF network registry settings are included, but commented out, in the radio network registry initialization files (essid_xxxx_yy.reg).

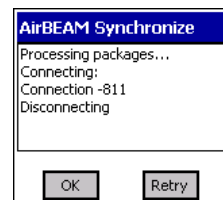
## Synchronizing with the Server

When the synchronization process is initiated, the AirBEAM client attempts to open an FTP session using the AirBEAM Client configuration. Once connected, the client processes the specified packages. Packages are loaded only if the server version of a given package is different from the version loaded on the client. Once the upload process is complete, the AirBEAM client closes the FTP session with the server.

The AirBEAM client can launch an FTP session with the server either manually, when initiated by the user or automatically.

## Manual Synchronization

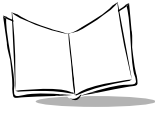
1. Configure the AirBEAM Client. See [Configuring the AirBEAM Client](#) on page 8-4.
2. From the main AirBEAM screen, tap *File - Synchronize*.
3. Once connected, the AirBEAM Synchronize screen appears.
  - a. The Status List displays status messages that indicate the progress of the synchronization process.
  - b. The OK button returns to the Main Menu. This button remains inactive until the synchronization process is complete.
  - c. The Retry button restarts the synchronization process. This button is activated only if there is an error during the synchronization process.



## Automatic Synchronization

The AirBEAM client can be configured to launch automatically using the Misc(1) Preference screen (see [Misc\(1\) Tab](#) on page 8-7). When setting this screen, use the Auto-load drop-down menu to specify how the AirBEAM client should be invoked automatically when the client device is rebooted. The selections are:

- **Disable:** the AirBEAM client is not invoked automatically during the boot sequence.
- **Interactive:** the AirBEAM client is invoked automatically during the boot sequence. The package synchronization process is started automatically. The *Synchronization Dialog* box is displayed, and the user is required to press the **OK** button when the process is complete.
- **Non-interactive:** the AirBEAM client is invoked automatically during the boot sequence. The package synchronization process is started automatically. The *Synchronization Dialog* box is displayed, but the user is not required to press the **OK** button when the process is complete. The Synchronization Dialog box terminates automatically.
- **Background:** the AirBEAM client is invoked automatically during the boot sequence. The package synchronization process is started automatically. Nothing is displayed while the synchronization process is occurring.



## AirBEAM Staging

---

The AirBEAM Smart staging support is intended to speedup and simplify the process of staging custom or updated operating software onto mobile devices directly from manufacturing. The staging support is part of the AirBEAM Smart CE client that is integrated into the terminal.

The AirBEAM Smart support works by defaulting the AirBEAM client configuration to a known set of values and launching the AirBEAM Smart package download logic. A staging environment, including an RF network, FTP server and AirBEAM packages must be setup. Ideally a staging network and server should be setup that matches the default AirBEAM Staging client configuration.

The AirBEAM Smart staging utility is invoked from the AirBEAM platform folder by tapping *Start - Programs - File Explorer - Platform folder - AirBEAM folder - ABSTAGE*.

The AirBEAM Staging support provides several benefits:

- Many devices can be simultaneously loaded over the RF network.
- The AirBEAM staging utility provides a simple single dialog user interface that is used to quickly start the software installation process.



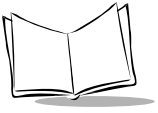
# Chapter 9

## *Spectrum24 Network Configuration*

### **Chapter Contents**

---

Introduction .....	9-3
Configuring the Terminal (11 MB Radio) .....	9-4
Network Adapters Properties .....	9-4
Using Spectrum24 Settings .....	9-6
Advanced Settings .....	9-6
Mode Tab .....	9-7
Info Tab .....	9-8
IP Config Tab .....	9-9
Power Tab .....	9-10
Options Tab .....	9-11
Encryption Tab .....	9-12
Ping Tab .....	9-14
Signal Tab .....	9-15
APs Tab .....	9-16
Using LEAP for Authentication and Encryption .....	9-17
Downloading the Patch .....	9-17
Installing the Patch .....	9-17
Configuration .....	9-18









*PDT 8000 Series Product Reference Guide*

## Introduction

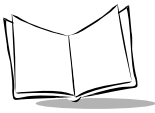
---

Wireless LANs allow PDT 8000 terminals to communicate wirelessly, and to send captured data “real time” to a host device. Before a terminal can be used on a Spectrum24 LAN your facility must be set up with the equipment required to run the wireless LAN and the terminal must be properly configured. Refer to the documentation which came with the access points for instructions on setting up the required hardware.

The terminal Network Adapter settings and Spectrum24 settings configure and monitor the Spectrum24 connection. The wireless LAN icon appears at the bottom right corner of the Today screen, and indicates terminal signal strength as follows.

Icon	Status
	Excellent signal strength
	Very good signal strength
	Good signal strength
	Fair signal strength
	Poor signal strength
	Out-of-network range (not associated)

Tap the icon to display LAN properties.



## Configuring the Terminal (11 MB Radio)

Before the terminal can be used, it must be properly configured for the Spectrum24 Wireless LAN.

1. Tap *Start - Settings*.
2. Select *Network Adapters* from the *Connections* tab.
3. Select *Spectrum 24 802.11b*.

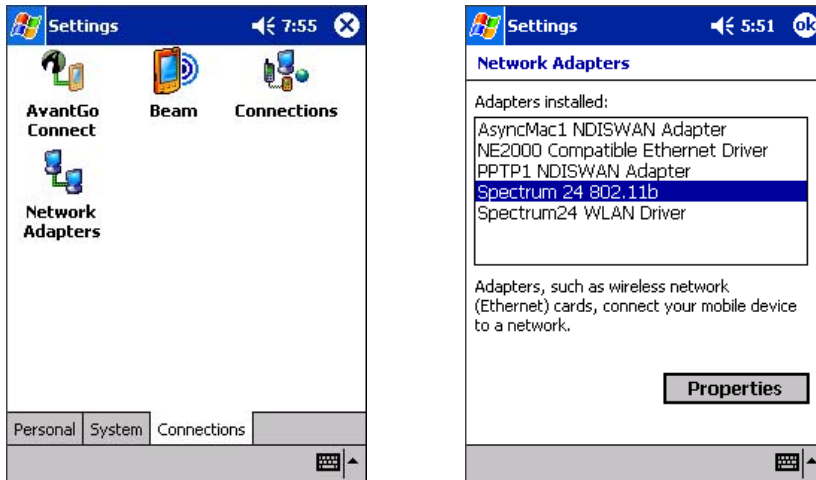


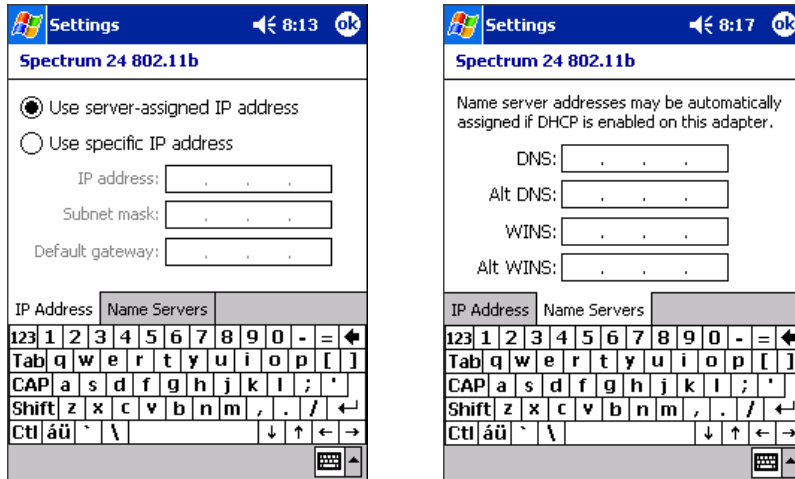
Figure 9-1. Network Adapters

### Network Adapters Properties

Tap *Properties* to view the current adapter IP configuration settings. **DHCP** (Dynamic Host Configuration Protocol) obtains a leased IP address and network configuration information from a remote server. An access point sends out a DHCP request searching for a DHCP server to acquire the network configuration and firmware filenames.

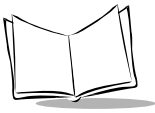


Use the property pages to view and adjust the IP address, subnet, gateway, DNS and WINS.



**Figure 9-2. IP Network Adapter Property Pages**

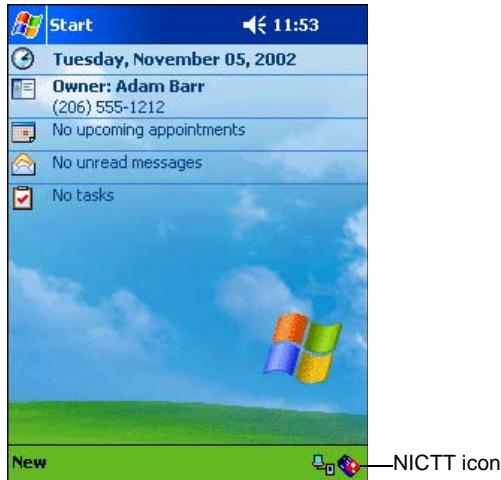
- **IP Address:** A 32-bit (max) number (expressed in dotted-decimal notation 157.235.90.24) that the Domain server uses to transmit and receive data. The IP address of the adapter is required to be in the same subnet as that of the access point for the devices to interoperate in Infrastructure mode.
- **Subnet Mask:** Required in order for the subnet to exist. Its purpose is to *mask out* IP addresses that are not part of the subnet. The network administrator usually has the required subnet mask.
- **Gateway:** Used to connect to the corporate network. The network administrator usually has the IP address required for the default gateway.
- **DNS (Domain Name System):** The IP address of a server containing a database of host names and their associated IP addresses so that when a host name is used, it can be resolved into its IP address.
- **WINS (Windows Internet Name Service):** A NetBIOS Name Server that registers your NetBIOS names and resolves into IP addresses, similar to DNS.



## Using Spectrum24 Settings

---

Tap the NICTT icon at the bottom right of the Today screen.



**Figure 9-3. NICTT Icon**

---

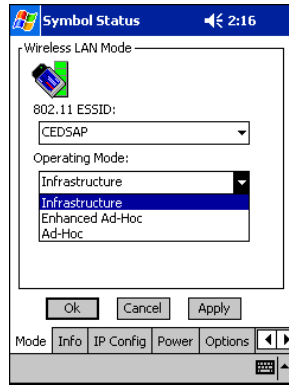
**Note:** On the PDT 8056, the NICTT icon displays only if the S24 radio card is inserted into the card slot. See [Replacing the S24 Wireless Networker Card](#) on page 1-27 if the card is not inserted.

---

## Advanced Settings

Only system administrators should modify the advanced settings. Select the *Advanced* button to view and edit the Advanced property pages and create a password for these pages. The Advanced property pages control all aspects of the terminal, including Mobile Unit settings, Power settings and Transmission Power settings.

## Mode Tab



**Figure 9-4. NICTT Properties - Mode Tab**

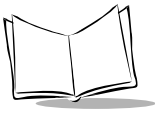
The *Mode* tab in NICTT configures the adapter's ESSID and operating mode.

- Use the *Operating Mode* drop-down menu to select one of the following operating modes for the terminal:
  - If you select *Infrastructure*, enter a 32-character maximum ESSID (802.11 Extended Service Set Identifier) in the *802.11 ESSID* field to identify the wireless local area network. This ESSID must match the access point ESSID for the adapter to communicate with the access point.
  - If you select *Enhanced Ad Hoc*, enter the channel number in the *Channel* field. The first adapter configured in the Ad Hoc network defines the channel number used in the Ad Hoc network. Each adapter is required to use the same channel to transmit and receive data to its peers.

Check the *Send long preamble headers* checkbox if the other devices in your network are using a long preamble. Devices using Ad Hoc mode must use the same preamble setting to interoperate. The adapter uses a long preamble heading by default.

Note that this is a Symbol Technologies operating mode and only works with other Symbol adapters enabled in the same mode.

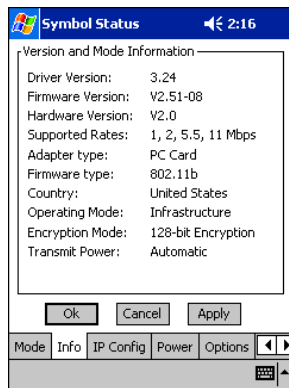
- If you select *Ad Hoc*, enter a 32-character maximum ESSID (802.11 Extended Service Set Identifier) in the *802.11 ESSID* field to identify the wireless local area network. This ESSID must match the ESSID of other devices using the Ad Hoc mode.



Enter the channel number in the *Channel* field. The first adapter configured in the Ad Hoc network defines the channel number used in the Ad Hoc network. Each adapter is required to use the same channel to transmit and receive data to its peers.

Check the *Send long preamble headers* checkbox if the other devices in your network are using a long preamble. Devices using Ad Hoc mode must use the same preamble setting to interoperate. The adapter uses a long preamble heading by default.

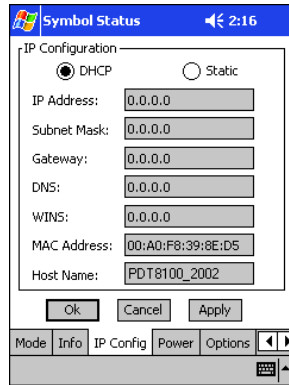
## Info Tab



**Figure 9-5. NICTT Properties - Info Tab**

The *Info* tab in NICTT provides information about the terminal, such as the version of the driver, adaptive firmware, and hardware. It also lists the current active settings for operating, encryption and transmit power modes. All the fields in the *Info* tab are read-only and cannot be configured.

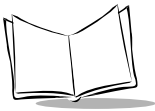
## IP Config Tab



**Figure 9-6. NICTT Properties - IP Config Tab**

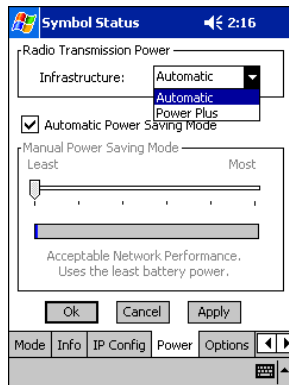
The *IP Config* tab allows you to adjust IP configuration settings.

- Select *DHCP* (Dynamic Host Configuration Protocol) to obtain a leased IP address and network configuration information from a remote server. DHCP is the default setting, and when selected, IP address fields are read only.
- Select *Static* to manually enter the following fields:
  - **IP Address:** A 32-bit (max) value expressed as four decimal numbers from 0 to 255, separated by periods (e.g., 157.235.90.24) that the terminal uses to transmit and receive data. The IP address of the adapter is required to be in the same subnet as that of the access point for the devices to interoperate in Infrastructure mode.
  - **Subnet Mask:** A 32-bit value expressed as four decimal numbers from 0 to 255, separated by periods (e.g., 255.255.0.0) which allows TCP/IP to determine the network ID portion of an IP address. Required in order for the subnet to exist. Its purpose is to *mask out* IP addresses that are not part of the subnet. The network administrator usually has the required subnet mask.
  - **Gateway:** Used to forward IP packets to and from a remote destination. See your network administrator for the IP address required for the default gateway.
  - **DNS (Domain Name System):** The IP address of a server containing a database of host names and their associated IP addresses so that when a host name is used, it can be resolved into its IP address.
  - **WINS (Windows Internet Name Service):** A NetBIOS Name Server that registers your NetBIOS names and resolves into IP addresses, similar to DNS.



- **MAC Address:** An IEEE 48-bit address the adapter is given at the factory which uniquely identifies the adapter at the physical layer level.
- **Host Name:** User-assigned host name.

## Power Tab



**Figure 9-7. NICTT Properties - Power Tab**

Select the *Power* tab to set Radio Transmission Power and a Power Saving Mode.

Adjusting the *Radio Transmission Power* level enables you to expand or confine the transmission area with respect to other wireless devices that may be operating nearby. Reducing a coverage area in high traffic areas improves transmission quality by reducing the noise in that coverage area.

- In Infrastructure mode, there are two transmission power options in the *Infrastructure* drop-down menu:
  - Select *Automatic* to use the power level defined by the access point. Automatic mode is the default mode for adapters operating in Infrastructure mode.
  - Select *Power Plus* to set the adapter transmission power one level higher than the level set for the access point.
- In Enhanced Ad Hoc or Ad Hoc mode, there are five transmission power options available in the drop-down menu:
  - Select *Maximum* power to set the adapter to the highest transmission power level. This is best suited for operation in highly reflective environments and areas where other devices could be operating nearby. Also use maximum power when attempting to communicate with devices at the outer edge of a coverage area.

- Choose *50%*, *25%* or *10%* to set the transmit power level to that percentage of the maximum power level.
- Choose *Minimum* power to set the adapter to the lowest transmission power level. Use this level when communicating with other devices in very close proximity, or when little or no radio interference from other devices is expected.
- Check *Automatic Power Saving Mode* to switch to the *Best Network Performance* when the AC power supply is used.

When using the battery, select an appropriate setting between *Best Network Performance* and *Acceptable Network Performance* based on real-time analysis of the network usage. *Automatic Power Saving Mode* is the default setting and extends the operating time before the battery must be recharged.

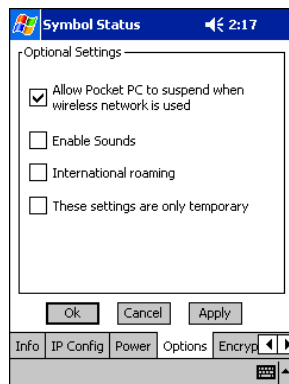
- Uncheck *Automatic Power Saving Mode* to select *Manual Power Saving Mode*, which allows you to set the slider to a performance level suited to the intended operation. There are 6 settings ranging from the best network performance, which uses the most battery power, to acceptable network performance, which uses the least battery power.

---

**Note:** *Power savings modes are not available in Enhanced Ad Hoc operating mode.*

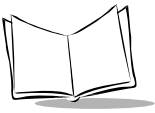
---

## Options Tab



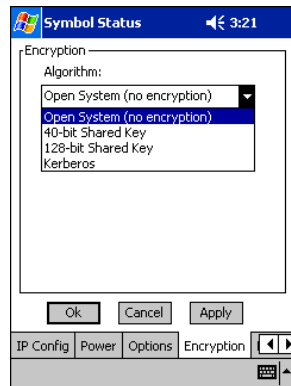
**Figure 9-8. NICTT Properties - Options Tab**

Use the *Options* tab to enable or disable the suspend wireless network option and system sounds, and set temporary settings.



- Check the `Allow Pocket PC to suspend when wireless network is used` to allow the terminal to automatically turn off (suspend) operation based on user inactivity. This prevents battery drain. The terminal does not suspend when idle if you disable this option.
- Check `Enable Sounds` to issue a sound when performing a ping test and associating with an access point. This notifies you when a ping is completed and when a roam to an access point occurs.
- Check `International Roaming` to enable this setting, used in countries outside of the United States.
- Changes to settings you make using the `Symbol Status` are usually saved to the registry and used to initialize the adapter when it is inserted. Check `These settings are only temporary` to prevent your changes from being saved to the registry. If not checked, any value entered is saved in the registry.

## Encryption Tab



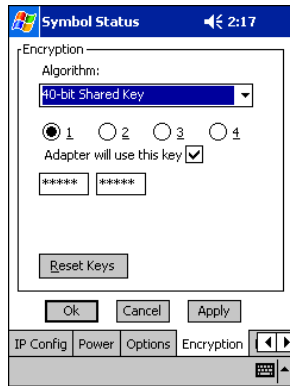
**Figure 9-9. NICTT Properties - Encryption Tab, Open System Selected**

Use the *Encryption* tab in NICTT to control encryption options. This allows you to encrypt WLAN data packets to protect your data from inspection by systems that may intercept wireless data over the network.

- Select an *Encryption Algorithm* matching the security established in your network. The AP and the terminal's adapter must use the same encryption algorithm:
  - The *Open System* does not encrypt any of the data packets that travel over the WLAN, meaning the data packets transmitted by terminals or APs are not encrypted. Select this if no security is needed on the network.

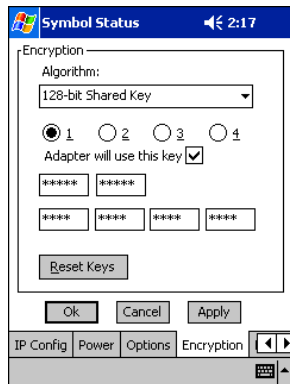


- The *40-bit Shared Key Algorithm* uses a 40-bit encryption key known by both the terminal and the AP to encrypt the data over the network.



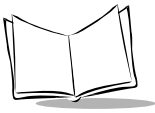
**Figure 9-10. NICTT Properties - Encryption Tab, 40-bit Shared Key Selected**

- The *128-bit Shared Key Algorithm* uses a 128-bit encryption key known by both the terminal and the AP to encrypt the data over the network. This option provides a higher level of security than the 40-bit encryption while maintaining an 11 Mbps data rate.



**Figure 9-11. NICTT Properties - Encryption Tab, 128-bit Shared Key Selected**

- Select *Kerberos* if your network employs the Kerberos system. Enter the Key Distribution Center (KDC) and Realm values. The KDC is located on a server and maintains information about the access points and users it supports, and



also permits the transmission and receipt of data once the credentials of the user are verified. Enter the name of the realm that hosts the Kerberos KDC in the Realm field.

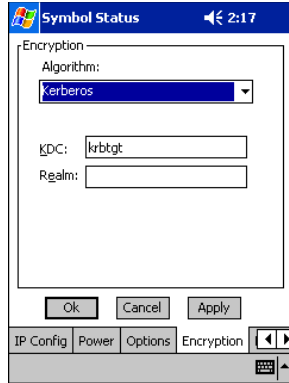


Figure 9-12. NICTT Properties - Encryption Tab, Kerberos Selected

---

**Note:** Another security method, LEAP, is available for the PDT 8046. See [Using LEAP for Authentication and Encryption](#) on page 9-17 for detailed instructions.

---

## Ping Tab

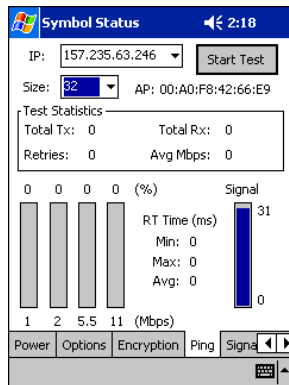
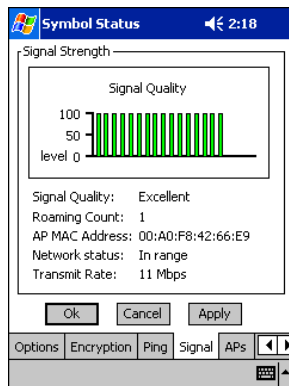


Figure 9-13. NICTT Properties - Ping Tab

Use the *Ping* tab to send and receive ICMP ping packets across the network to the specified IP address.

- Enter an IP address as a dotted string (e.g., 122.78.3.141).
- Select the size of packets sent from the *Size* drop-down menu.
- Select *Start Test* to begin the continuous ping test. Select *Stop Test* to terminate the ping test.
- The average mega-bits per second, signal strength, data rate currently in use, test statistics and round trip times are displayed for each test.
- The associated access point's MAC address is also displayed.
- The signal strength level and the data transmission rate are displayed in real-time bar graphs.

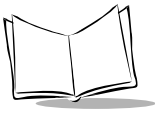
## Signal Tab



**Figure 9-14. NICTT Properties - Signal Tab**

The *Signal* tab is only available in Infrastructure mode (selected on the *Mode* tab).

Use the *Signal* tab to display a real-time graph of the signal quality of the adapter to the associated access point, including the number of times the adapter has roamed to and from APs, the current data rate, and the network status. Signal quality indicates how well the adapter receives the transmitted signal of the associated access point.



## APs Tab

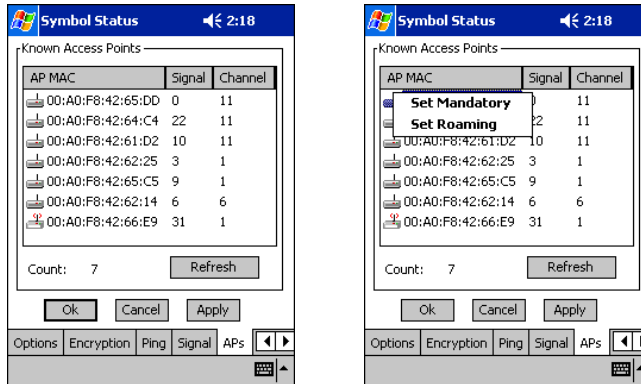


Figure 9-15. NICTT Properties - APs Tab

The APs tab is only available in Infrastructure mode (selected on the *Mode* tab).

Use the APs tab with the Infrastructure operating mode to view access points with the same ESSID as the adapter. View the AP MAC address, signal level and channel of known access points.

- The currently associated access point's icon includes a radio wave radiating from the antennae to indicate the associate status. Tap on an icon to display a menu:
  - Select *Set Mandatory* to prohibit the adapter from associating with the specified access point. The letter "m" displays on top of the access point's icon when this option is selected.
  - Select *Set Roaming* to allow the adapter to roam to this access point if it has a better signal quality.

These settings are temporary and are not saved to the registry.

- Tap the *Refresh* button to update the list of the known APs.

## Using LEAP for Authentication and Encryption

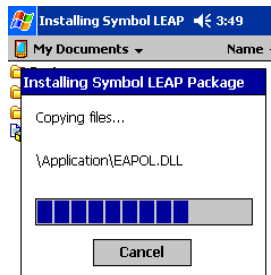
LEAP is a Cisco proprietary protocol to enable user authentication and data encryption for wireless networks. Symbol provides a patch for the PDT 8046 to support LEAP. The patch can only be used to connect to Access Points and servers that support LEAP. The update has been qualified for use with Cisco Aironet 350 Access Points and Cisco Secure Access Control Server (ACS) version 3.1.

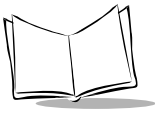
### Downloading the Patch

1. Go to <http://devzone.symbol.com>.
2. Click on *Developer Downloads* under Developer Zone Menu.
3. Enter your registered email address and password to login into Developer Zone.
4. Click on *Download* under the Microsoft Windows Powered logo.
5. Select LEAP Update for Pocket PC 2002 from the PDT 8000 (Pocket PC) drop-down list.
6. Click on *Go* and follow the instructions on your screen to complete the download. A .zip file is downloaded to the host computer.

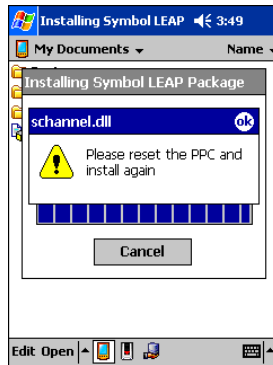
### Installing the Patch

1. Unzip the file downloaded in the previous step.
2. Copy the extracted CAB file onto the terminal using ActiveSync. The file can be placed anywhere on the terminal.
3. On the terminal, tap *Start - File Explorer*.
4. Locate the CAB file you copied in step 2 and tap it to run it. An *Installing Symbol LEAP Package* dialog box appears and the installation process begins.

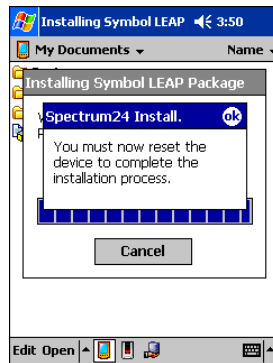




5. A *schannel.dll* dialog box may appear. Disregard the message and tap **OK**. Wait for installation to complete.



6. After installation is complete, a *Spectrum24 Install* dialog box appears. Tap **OK**.



7. Hard reset your terminal. See [Performing a Hard Reset](#) on page 2-35.

## Configuration

The purpose of the patch is to provide the capability to use LEAP by installing necessary software and firmware. The configuration of the Spectrum 24 radio card using LEAP must be done through a registry file in the Platform folder, since NICTT does not allow for this configuration. During the installation of the patch, NICTT is removed from the terminal.

### To copy the file from your terminal

1. Establish an ActiveSync connection between the host computer and the terminal. Depending on the accessory used for the connection, see the appropriate section in [Chapter 4, Communications](#).

2. In ActiveSync, click *Explore*. Windows Explorer will open the Mobile Device window for your terminal.
3. Navigate to the Platform folder and find the Spectrum24DS.reg file.
4. Right-click the file and click *Copy*. Place the cursor in the desired folder on your host computer, right-click, and click *Paste*.

### To make changes to the file

1. Open the Spectrum24DS.reg file you download above in any text editor application, such as Microsoft Notepad. You cannot double-click to open the file. You must open it through the application.
2. Locate the following section of the registry file

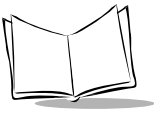
```
[HKEY_LOCAL_MACHINE\Comm\NETWLAN1\Parms]
  "AdapterModel"="Spectrum 24 802.11b"
  "Version"="3.7.11.4"
  "CardType"=dword:0
  "IoBaseAddress"=dword:300
  "IoLength"=dword:46
  "PowerIndex"=dword:1; PSP1
  ; "SerialKey"="3FBA67E6FAAE76AA001A5CB9D1639D128F3DF39FA1FA9FD999798AEFA92683036C0334
C35EE211F50912CB"
  "Password"="3745A4CA1FD2D1CFC10041C7576C0E6423A815E6D4D094C8D87441C26A6C021153
DDE9C851085"
  "RogueAPDetection"=dword:1
;   "Kerberoskdc" = "krbtgt"

;
;*****
;* The following lines are for Open System
;*
;*-----
;* When using LEAP, comment the following keys by
;* putting semicolons (;) in front of these lines
;* If OPEN system is being used, make sure the LEAP
;* keys are commented out below.
;*****
;

  "MUEncryptionAlgorithm"=dword:00000001
  "ProtocolsToBindTo"=multi_sz:"NOT","NDISUIO","EAPWLAN"
  "ESS_ID"="CEDSAP"

;*****
;* End Open System Settings Section
;*****
;

;*****
;* The following lines are for LEAP
;*
;*-----
;* When using LEAP:
;* 1) Comment out the OPEN System lines (above) by
;* putting semicolons (;) in front of those lines.
;* 2) Uncomment the following lines by removing the
;* semicolons.
;* 3) Change myLEAPSSID, myLEAPUserName, and
;* myLEAPPassword to your ESSID, Username, and
```



```

;* Password.
*****
;
; "MUEncryptionAlgorithm"=dword:00000005
; "ProtocolsToBindTo"=multi_sz:"NOT","NDISUIO"
; "ESS_ID"="myLEAPESSID"
; "UNAME"="myLEAPUserName"
; "UPwd"="myLEAPPASSWORD"
*****
;* End LEAP Settings
*****

```

3. Edit the registry file with the following changes:

a. Comment out the Open System section using semicolons, as shown below:

```

; "MUEncryptionAlgorithm"=dword:00000001
; "ProtocolsToBindTo"=multi_sz:"NOT","NDISUIO","EAPWLAN"
; "ESS_ID"="CEDSA"

```

b. Uncomment the LEAP section by deleting the semicolons, as shown below:

```

"MUEncryptionAlgorithm"=dword:00000005
"ProtocolsToBindTo"=multi_sz:"NOT","NDISUIO"
"ESS_ID"="myLEAPESSID"
"UNAME"="myLEAPUserName"
"UPwd"="myLEAPPASSWORD"

```

c. Change the value of the ESS\_ID parameter, currently "myLEAPESSID", to your ESSID. Ensure that the new value entered is kept in quotes.

d. If you want to save the LEAP username and password in the terminal, change the value of the UNAME and UPwd parameters to the correct username and password, respectively. Ensure that the new values entered are kept in quotes.

**Note:** *If you do not save the LEAP username and password in the registry, a dialog box appears asking for this information after a hard reset is performed on the terminal. After this information is entered, you must suspend and resume the terminal before utilizing the network.*

4. After all changes have been made, save the registry file. If you are using Microsoft Notepad, click *File - Save* to save it under that current name.

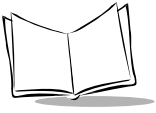
**Note:** *When saving the file, ensure that you do not change the file type, i.e. ensure you are saving the file as a .reg file.*

5. Close your text editor. The registry file must now be loaded back on the terminal and a hard reset must be performed on the terminal for the changes to take affect.

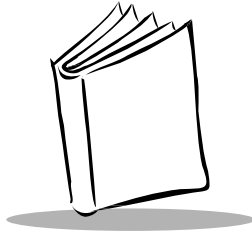


To load the file back on the terminal

1. Establish an ActiveSync connection between the host computer and the terminal. Depending on the accessory used for the connection, see the appropriate section in [Chapter 4, Communications](#).
2. In ActiveSync, click *Explore*. Windows Explorer will open the Mobile Device window for your device.
3. Open another Windows Explorer window and browse to the update Spectrum24DS.reg file.
4. Right-click the file and click *Copy*. Place the cursor in the Application folder on your Mobile Device window (step 2), right-click, and click *Paste*.
5. Hard reset the terminal, so new registry settings can be merged. See [Performing a Hard Reset](#) on page 2-35.



*PDT 8000 Series Product Reference Guide*



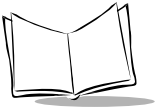
# Chapter 10

## *Wireless Wide Area Network Configuration*

### **Chapter Contents**

---

Introduction .....	10-3
Establish a GPRS Connection .....	10-3
GPRS Parameters Configuration .....	10-3
Using GSM Demo .....	10-3
Using the Registry File .....	10-11
Configuring a GPRS WAN Connection .....	10-15
Connecting via GPRS .....	10-18
Establish a GSM CSD Connection .....	10-21
GSM Demo Installation .....	10-21
Verify the functionality of your SIM Card .....	10-21
Configuring a GSM WAN Connection .....	10-23
Connecting via GSM .....	10-27



*PDT 8000 Series Product Reference Guide*

## Introduction

---

The PDT 8037 and PDT 8056 can be used on a GSM/GPRS wireless network.

Global System for Mobile Communication (GSM) networks deliver mobile voice and data services (such as SMS/Text Messaging) with full roaming capabilities across the world.

General Packet Radio Service (GPRS) enabled networks offer Internet-based content and packet-based data services. This enables services such as internet browsing, e-mail on the move, powerful visual communications, multimedia messages and location-based services.

---

**Note:** *Before a terminal can be used on a GSM/GPRS wireless network, you must select a provider and establish a voice and data-enabled service plan, and the terminal must be properly configured.*

---

## Establish a GPRS Connection

---

To establish a GPRS connection, you must:

1. Configure the GPRS parameters
2. Configure a GPRS WAN connection (see [page 10-15](#)).

### ***GPRS Parameters Configuration***

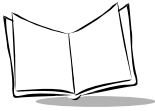
Two options are available to configure the GPRS parameters:

- Using GSM Demo, a GUI interface that allows you to edit network specific GPRS parameters.
- Using the registry file, a text file that is uploaded to the terminal, to configure the network specific GPRS parameters.

### **Using GSM Demo**

The GSM Demo utility is a GUI interface that simplifies the process of configuring the GPRS parameters. To configure the GPRS parameters, you must:

1. Install the application
2. Verify the functionality of the SIM card
3. Edit the GPRS parameters.



### **Install the application:**

Check the terminal to see if the GSMDemo application is installed. Tap *Start - Programs - File Explorer* and navigate to the Applications folder. If GSMDemo is not listed, see [GSM Demo Installation](#) on page C-1 for installation instructions.

### **Verify the functionality of your SIM Card:**

Before you configure the GPRS parameters, it is important to ensure the functionality of your SIM card.

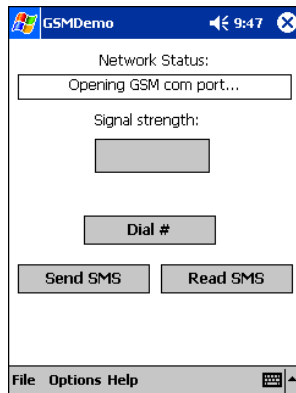
1. Ensure that a SIM card is installed in the terminal. See [Installing a SIM Card](#) on page 1-24.

---

**Note:** *In order to connect to a GPRS WAN connection, your SIM card needs to be GPRS enabled. Contact you service provider for information.*

---

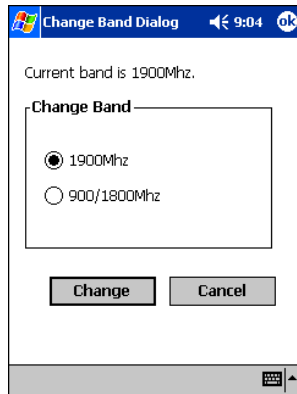
2. Ensure that the GSMDemo Application is installed on your terminal. Tap *Start - Programs - File Explorer* on your terminal and navigate to the *Applications* folder. If GSMDemo is not listed, see [GSM Demo Installation](#) on page C-1.
3. If GSMDemo is listed, select *GSM Demo*.  
As GSM Demo launches, it opens the internal serial port to the GSM modem and attempts to register with a network. The terminal displays the main GSM Demo screen:



The *Network Status* field displays the following messages as the modem attempts to connect: *Opening GSM com port*, *Initializing modem*, *Checking SIM Card* and

*Configuring modem.* Once a successful connection is made, the field displays *Registered Home* or *Registered Roam* (if out of network).

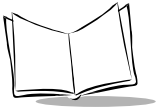
4. If the *Network Status* field displays *Searching...* and a connection is not made:
  - a. Tap *Options - Settings*.
  - b. Select *Change Band*.



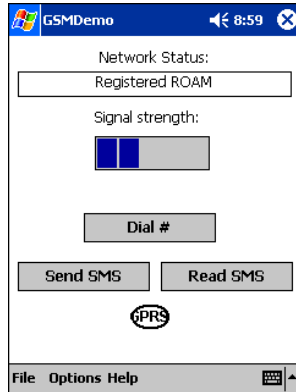
1900Mhz is used for North America

900/1800Mhz is used for Europe, Asia, Australia and Africa.

- c. Make the appropriate selection, depending on your location. If necessary, contact your service provider to confirm the band information.
- d. Tap *Change*.
- e. On the pop-up *Confirm* dialog box, tap *Yes*. The terminal displays the main *GSM Demo* screen, and the *Network Status* field displays *Cycling Power. Restarting*.



5. A successful registration, indicated by signal strength (as shown below), ensures the functionality of your SIM card.



GPRS availability, through the network, is indicated by the GPRS icon.

***Edit the GPRS parameters:***

1. Tap *Options - Settings*.
2. Select GPRS Parameters.



3. Make the appropriate changes, as per [Table 10-1](#), on the PDP Context tab.

The screenshot shows the 'Option Select Dialog' with the following fields and values:

- Table Version: 1.0
- PDP Context ID: 1
- Context: (empty)
- PDP Type: (empty)
- APN: (empty)
- PDP Address: (empty)
- Data Compression: No
- Header Compression: No
- Current Active Context: 1

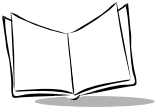
At the bottom, there is a table with the following structure:

PDP Context	Min. Qos.	Req. Qos.

**Figure 10-1. GPRS Parameters - PDP Context Tab**

**Table 10-1. PDP Context Tab Fields**

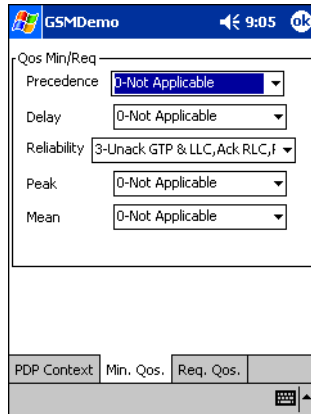
Field Name	Description
<b>Table Version</b>	System generated. Contains internal version number representing the structure of the registry file.
<b>Context ID</b>	Each set of parameters is collectively called a context. User is allowed to store three contexts. Select the number representing the particular set of context.
<b>Context</b>	Each set of parameters is collectively called a context. Enter a name for the context.
<b>PDP Type</b>	Information obtained from service provider. This represents the protocol type.
<b>APN</b>	Information obtained from service provider. This represents the access point name.
<b>PDP Address</b>	Information obtained from service provider. <ul style="list-style-type: none"> <li>If provider supports DHCP, this field is blank.</li> <li>If provider does not support DHCP, obtain address from provider.</li> </ul>



**Table 10-1. PDP Context Tab Fields**

Field Name	Description
<b>Data Compression</b>	Information obtained from service provider. <ul style="list-style-type: none"><li>• If provider supports data compression, select <i>No</i>.</li><li>• If provider supports data compression, select <i>Yes</i>.</li></ul>
<b>Header Compression</b>	Information obtained from service provider. <ul style="list-style-type: none"><li>• If provider supports header compression, select <i>No</i>.</li><li>• If provider supports header compression, select <i>Yes</i>.</li></ul>
<b>Current Active Context</b>	Select the number representing the context you want to use for your connection.

4. Tap the Min. Qos. tab and make the appropriate changes, as per [Table 10-2](#). This tab configures the quality of minimum service that will be accepted from the provider.



**Figure 10-2. GPRS Parameters - Min. Qos. Tab**

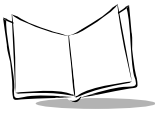
---

**Note:** *If the value of the fields is set to high, it is possible that no connection is made.*

---

**Table 10-2. Min. Qos. Tab Fields**

<b>Field Name</b>	<b>Description</b>
<b>Precedence</b>	Information obtained from service provider. A parameter describing the relative priority of maintaining the service.
<b>Delay</b>	Information obtained from service provider. A parameter describing service speed.
<b>Reliability</b>	Information obtained from service provider. A parameter indicates the transmission characteristics that are required by an application. The reliability class defines the probability of loss, duplication, missequencing or corruption of SDU (Service Data Unit).
<b>Peak</b>	Information obtained from service provider. A parameter indicating the peak throughput octet rate per second.
<b>Mean</b>	Information obtained from service provider. A parameter indicating the mean throughput octet rate per minute.



5. Tap the Req. Qos. tab and make the appropriate changes, as per [Table 10-3](#). This tab configures the quality of service requested.

GSMDemo 9:05 ok

Qos Min/Req

Precedence 0-Not Applicable

Delay 0-Not Applicable

Reliability 3-Unack GTP & LLC, Ack RLC, f

Peak 0-Not Applicable

Mean 0-Not Applicable

PDP Context Min. Qos. Req. Qos. [Icon]

**Figure 10-3. GPRS Parameters - Req. Qos. Tab**

**Table 10-3. Req. Qos. Tab Fields**

Field Name	Description
<b>Precedence</b>	Information obtained from service provider. A parameter describing the relative priority of maintaining the service.
<b>Delay</b>	Information obtained from service provider. A parameter describing service speed.
<b>Reliability</b>	Information obtained from service provider. A parameter indicates the transmission characteristics that are required by an application. The reliability class defines the probability of loss, duplication, missequencing or corruption of SDU (Service Data Unit).
<b>Peak</b>	Information obtained from service provider. A parameter indicating the peak throughput octet rate per second.
<b>Mean</b>	Information obtained from service provider. A parameter indicating the mean throughput octet rate per minute.

6. Tap *OK* when all options are selected.
7. You will be asked to confirm the change. Tap *Yes*.
8. You will be asked if you want to overwrite the default GPRS settings permanently
  - a. Tap *No* to apply the new settings to the active parameters settings only. In this case the new parameters are used for all subsequent PDP contexts until a cold boot occurs.
  - b. Tap *Yes* to overwrite the default settings permanently. In this case a cold boot will retain the new settings.
9. Tap *OK* on the *Option Select* dialog box.

Before you set up a GPRS connection, you must exit from GSM Demo. To exit, tap *File - Exit* from the main GSM Demo screen. This closes the internal serial port and allows it to be available for your GPRS connection.

## Using the Registry File

The registry file contains the GPRS parameters for a particular network provider. The entries in this file are read during cold boot and placed with the active registry settings. A default registry file, *GPRS.reg*, is included on the terminal in the platform directory. You can either create a brand new registry file with your GPRS parameters or edit the existing file.

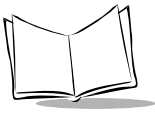
### **Caution**

Before working with registry files, it is very important to understand how they are merged. All registry files in the Platform directory are merged before the registry files in the Application directory. In addition to this, when you have two or more registry files in the same directory on your terminal, they are merged in alphabetical order (by file name) after a hard reset. If a customized registry file is executed before the original registry file, the customized changes are overwritten. To ensure that customized registry files are not overwritten at merge time, name them appropriately so that they fall alphabetically after the original registry file and are executed after the original file.

For example, if you make changes to the original registry file *GPRS.reg* and save it as *AGPRS.reg*, the original *GPRS.reg* merges after *AGPRS.reg* and overwrites your customized registry file.

To configure parameters using the registry file, you can:

- create a new registry file



- manually update the existing registry file.

### **Creating a new registry file**

1. Open any text editing application, such as Microsoft Notepad.
2. Create the content of the registry file. You may use the sample registry file included on the terminal as a base for your new file (also included below, see [Sample Network Parameter Registry File](#) on page 10-13).  
To access the file, see [To copy the file from your terminal](#) on page 10-12.
3. Once you have created the file, save it. If you are using Microsoft Notepad, click *File - Save As*. You can give it any name you want.

---

**Note:** *When saving the file, ensure that you do not change the file type, i.e. ensure you are saving the file as a .reg file.*

---

4. Load the new file back on to the terminal. See [To load the file back on the terminal](#) on page 10-13.
5. Hard reset the terminal, so new registry settings can be merged. See [Performing a Hard Reset](#) on page 2-35.

### **Manually updating the existing registry file**

A default registry file is included on the terminal in the Platform directory. To update this file you must copy the file from your terminal onto the host computer, make the necessary changes and load the new file back onto the terminal.

#### To copy the file from your terminal

1. Establish an ActiveSync connection between the host computer and the terminal. See [Chapter 4, Communications](#) for detailed instructions.
2. In ActiveSync, click *Explore*. Windows Explorer will open the Mobile Device window for your device.
3. Navigate to the Platform folder and find the GPRS.reg file.
4. Right-click the file and click *Copy*. Place the cursor in the desired folder on your host computer, right-click, and click *Paste*.

#### To make changes to the file

1. Open the GPRS.reg file you download above in any text editor application, such as Microsoft Notepad. You cannot double-click to open the file. You must open it through the application.

2. Change the values for the parameters, as necessary. Parameter names appear in quotes followed by an = sign (for example, "CurrentContext"=). Only change the text followed by the = sign.  
A sample registry file is included below. See [Sample Network Parameter Registry File](#) on page 10-13.
3. Once all changes have been made, save the file. If you are using Microsoft Notepad, click *File - Save* to save it under the current name or click *File - Save As* to save it under a different name.

---

**Note:** *When saving the file, ensure that you do not change the file type, i.e. ensure you are saving the file as a .reg file.*

---

#### To load the file back on the terminal

1. Establish an ActiveSync connection between the host computer and the terminal. See [Chapter 4, Communications](#) for detailed instructions.
2. In ActiveSync, click *Explore*. Windows Explorer will open the Mobile Device window for your device.
3. Open another Windows Explorer window and browse to the file that you want to copy on your device, i.e. the updated or new registry file you created.
4. Right-click the file and click *Copy*. Place the cursor in the Application folder on your Mobile Device, right-click, and click *Paste*.
5. Hard reset the terminal, so new registry settings can be merged. See [Performing a Hard Reset](#) on page 2-35.

### **Sample Network Parameter Registry File**

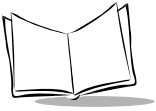
The following sample provides 3 contexts, with one of them the active context. Parameter names appear in quotes followed by an = sign (for example, "CurrentContext"=). Only change the text followed by the = sign.

```

; -----
; GPRS Network Specific Parameters
[HKEY_LOCAL_MACHINE\Drivers\BuiltIn\Seriald3]
"CurrentContext"=dword:1
"Version"="1.0"

[HKEY_LOCAL_MACHINE\Drivers\BuiltIn\Seriald3\Context1]
;
; 1st of 3 selectable Contexts

```



```
;
"ContextID"=dword:1
"ContextName"="VoiceStream"
"PDPType"="IP"
"APN"="internet3.voicestream.com"
"PDPAddress"=" "

"DataCompression"=dword:0
"HDRCompression"=dword:0

"QosMinPrecedence"=dword:0
"QosMinDelay"=dword:0
"QosMinReliability"=dword:3
"QosMinPeak"=dword:0
"QosMinMean"=dword:0

"QosReqPrecedence"=dword:0
"QosReqDelay"=dword:0
"QosReqReliability"=dword:3
"QosReqPeak"=dword:0
"QosReqMean"=dword:0

[HKEY_LOCAL_MACHINE\Drivers\BuiltIn\Seriald3\Context2]
;
; 2nd of 3 selectable Contexts
;
"ContextID"=dword:2
"ContextName"="Telstra"
"PDPType"="IP"
"APN"="telstra.internet"
"PDPAddress"=" "

"DataCompression"=dword:0
"HDRCompression"=dword:0

"QosMinPrecedence"=dword:0
"QosMinReliability"=dword:0
"QosMinDelay"=dword:0
"QosMinPeak"=dword:0
```



```
"QosMinMean"=dword:0

"QosReqPrecedence"=dword:0
"QosReqDelay"=dword:0
"QosReqReliability"=dword:0
"QosReqPeak"=dword:0
"QosReqMean"=dword:0

[HKEY_LOCAL_MACHINE\Drivers\BuiltIn\Seriald3\Context3]
;
; Last of 3 selectable Contexts
;
"ContextID"=dword:3
"ContextName"="OmniTel"
"PDPTType"="IP"
"APN"="web.omnitel.it"
"PDPAddress"=""

"DataCompression"=dword:0
"HDRCompression"=dword:0

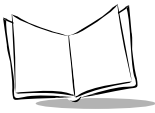
"QosMinPrecedence"=dword:0
"QosMinDelay"=dword:0
"QosMinReliability"=dword:0
"QosMinPeak"=dword:0
"QosMinMean"=dword:0

"QosReqPrecedence"=dword:2
"QosReqDelay"=dword:4
"QosReqReliability"=dword:3
"QosReqPeak"=dword:6
"QosReqMean"=dword:1f
```

## **Configuring a GPRS WAN Connection**

To set up a new connection configuration:

1. Tap *Start - Settings*.
2. Tap the *Connections* tab, and select *Connections* icon.



3. On the *Connections* screen,
  - a. if you are using a PDT 8056, ensure *Work* is selected from the *My network card connects to:* drop-down menu.
  - b. tap the *Modify* button under the *When needed, automatically connect to The Internet using these settings:* drop-down.

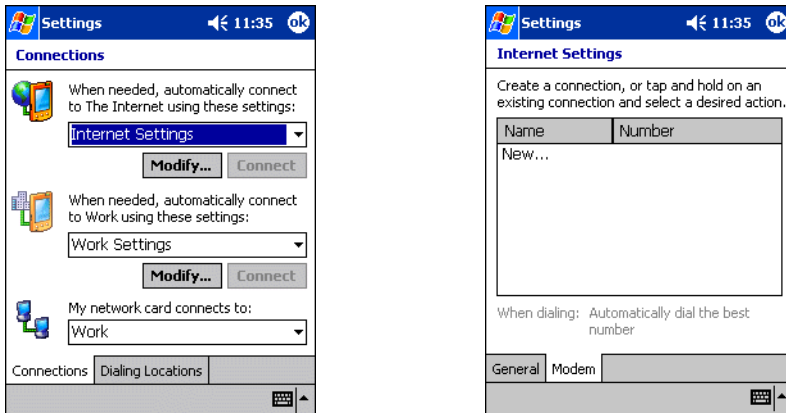


Figure 10-4. Connections & Internet Settings Screens

4. On the *Internet Settings* screen, tap *New . . .* The *Make New Connection* screen displays.

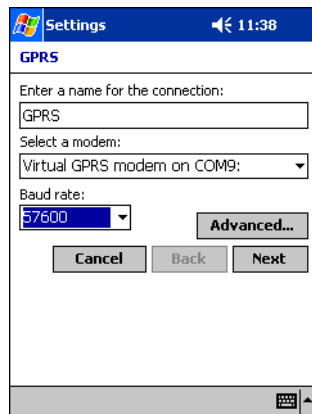


Figure 10-5. Make New Connection Screen

5. Enter *GPRS* as the name for your connection

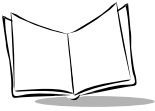
6. Select *Virtual GPRS modem on COM9* from the *Select a modem:* drop-down menu.
7. Select *57600* from the *Baud rate:* drop down menu.
8. Tap *Next*.

**Figure 10-6. Entering Phone Number**

9. Enter your area code and set the phone number to \*99#. The area code must match the area code in the dialing locations screen. Tap *Next*.

**Figure 10-7. Dialing Settings**

10. Uncheck *wait for dial tone before dialing*, and tap *Finish*. Your new connection is created.



## Connecting via GPRS

1. Ensure a SIM card is installed in the terminal. See [Installing a SIM Card](#) on page 1-24.
2. Ensure GPRS parameters are configured appropriately. See [GPRS Parameters Configuration](#) on page 10-3.
3. Ensure a GSM WAN connection is properly configured. See [Configuring a GPRS WAN Connection](#) on page 10-15.
4. Tap *Start - Settings*.
5. Tap the *Connections* tab, and select *Connections* icon.
6. Tap the *Dialing Locations* tab.

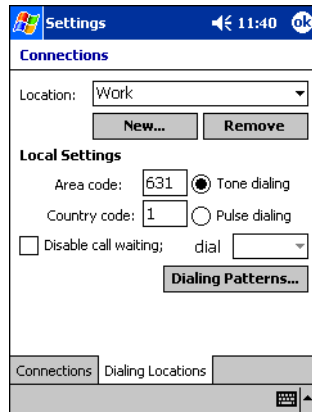
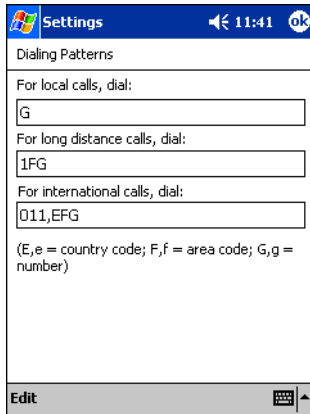


Figure 10-8. *Dialing Locations* Tab

- Set the area code to match the area code entered earlier, in the Entering Phone Number screen (see [Figure 10-6](#)). Tap **Dialing Patterns**.



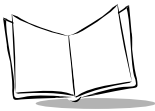
**Figure 10-9. Dialing Patterns Screen**

- On the Dialing Patterns screen, edit the patterns as shown above, deleting the “9,” from each location.
- Tap **OK** until you return to the *Connections* screen, and select the *Connections* tab. Tap **Connect**. The Network Log On screen displays.
- Tap **OK**. There is no username or password for a GPRS connection.

---

**Note:** *If the SIM card is protected with a PIN number, a dialog box will pop up requesting the appropriate PIN number to unlock the SIM card. In this case, enter the PIN number and tap **OK**.*

---



The *Connecting* dialog box displays.



**Figure 10-10. Connection Dialog Box**

---

**Note:** *If the Connection dialog box does not display “Dialing \*99#” the connection will fail to establish. Please ensure that all the appropriate settings were made in the steps above.*

---

11. Once a connection is establish, you can launch Internet Explorer by tapping *Start - Internet Explorer*.
12. To end a connection, tap the double arrows on the Navigation bar and tap *End*.

## Establish a GSM CSD Connection

---

To establish a GSM circuit switched data (CSD) connection, you must:

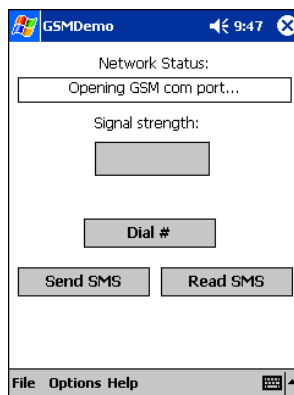
- Install GSM Demo
- Verify the functionality of your SIM Card
- Configure a GSM WAN connection

### ***GSM Demo Installation***

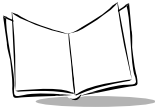
Check the terminal to see if the GSMDemo application is installed. Tap *Start - Programs - File Explorer* and navigate to the Applications folder. If GSMDemo is not listed, see [GSM Demo Installation](#) on page C-1 for installation instructions.

### ***Verify the functionality of your SIM Card***

1. Ensure that a SIM card is installed in the terminal. See [Installing a SIM Card](#) on page 1-24.
2. Ensure that the GSMDemo Application is installed on your terminal. Tap *Start - Programs - File Explorer* on your terminal and navigate to the *Applications* folder. If GSMDemo is not listed, see [GSM Demo Installation](#) on page C-1.
3. If GSMDemo is listed, select *GSM Demo*.  
As GSM Demo launches, it opens the internal serial port to the GSM modem and attempts to register with a network. The terminal displays the main GSM Demo screen:

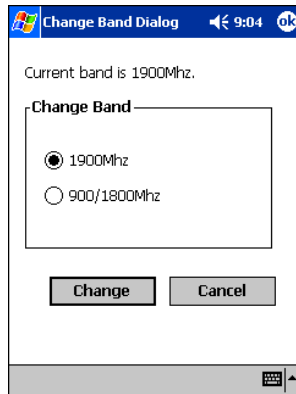


**Figure 10-11. GSM Demo Main Screen**



The *Network Status* field displays the following messages as the modem attempts to connect: *Opening GSM com port*, *Initializing modem*, *Checking SIM Card* and *Configuring modem*. Once a successful connection is made, the field displays *Registered Home* or *Registered Roam* (if out of network).

4. If the *Network Status* field displays *Searching...* and a connection is not made:
  - a. Tap *Options - Settings*.
  - b. Select *Change Band*.



**Figure 10-12. GSM Demo Change Band Screen**

1900Mhz is used for North America

900/1800Mhz is used for Europe, Asia, Australia and Africa.

- c. Make the appropriate selection, depending on your location. If necessary, contact your service provider to confirm the band information.
- d. Tap *Change*.
- e. On the pop-up *Confirm* dialog box, tap *Yes*. The terminal displays the main *GSM Demo* screen, and the *Network Status* field displays *Cycling Power. Restarting*.



5. A successful registration, indicated by signal strength (as shown below), ensures the functionality of your SIM card.

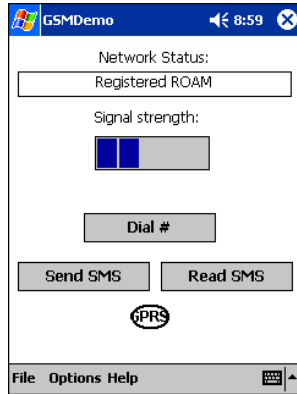
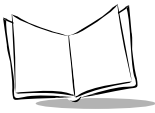


Figure 10-13. GSM Demo Main Screen

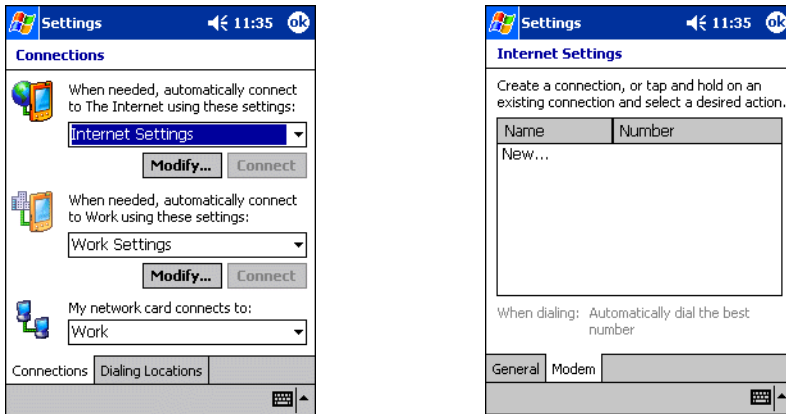
## Configuring a GSM WAN Connection

To set up a new connection configuration:

1. Tap *Start - Settings*.
2. Tap the *Connections* tab, and select *Connections* icon.
3. On the *Connections* screen,
  - a. if you are using a PDT 8056, ensure *Work* is selected from the *My network card connects to*: drop-down menu.

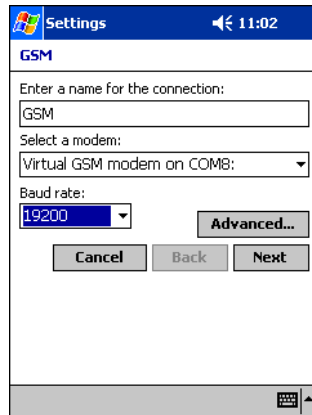


- b. tap the **Modify** button under the *When needed, automatically connect to The Internet using these settings:* drop-down.



**Figure 10-14. Connections & Internet Settings Screens**

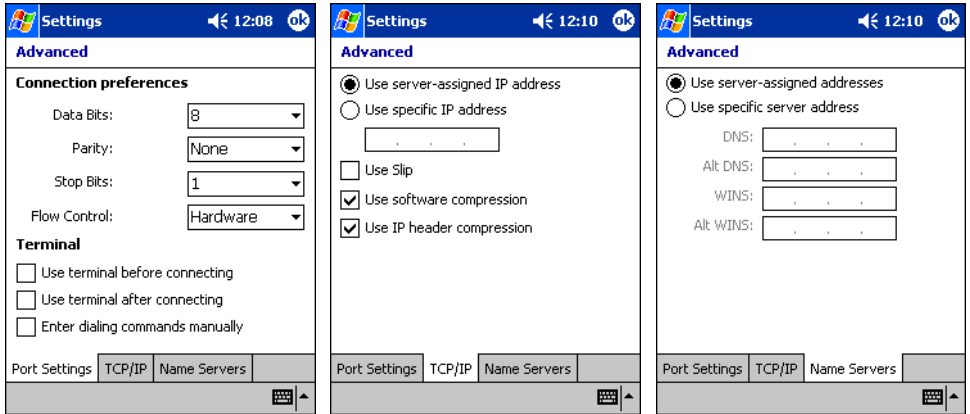
4. On the *Internet Settings* screen, tap **New . . .** The *Make New Connection* screen displays.



**Figure 10-15. Make New Connection Screen**

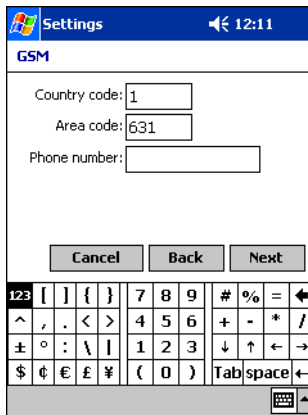
5. Enter *GSM* as the name for your connection
6. Select *Virtual GSM modem on COM8* from the *Select a modem:* drop-down menu.
7. Select *19200* from the *Baud rate:* drop down menu.

- Your modem settings and TCP/IP address should be set automatically, but if you need to set them manually, tap the **Advanced** button and enter the information in the **Port Settings**, **TCP/IP**, and **Name Servers** tabs.

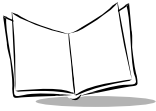


**Figure 10-16. Advanced Settings**

- When you have completed entering your settings, tap **OK**, then select **Next** from the **Make New Connection** screen.



**Figure 10-17. Entering Phone Number**



10. Enter a phone number that connects to a Remote Access Server (RAS) to browse the Internet. The area code should be that of the RAS server modem. Tap **Next**.

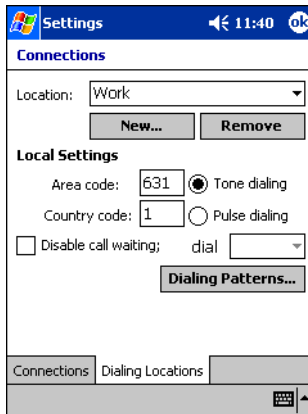


**Figure 10-18. Connection Settings**

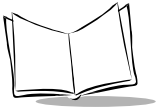
11. Uncheck **wait for dial tone before dialing**, and tap **Finish**. Your new connection is created.

## Connecting via GSM

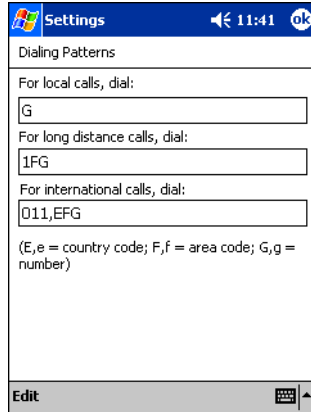
1. Ensure a SIM card is installed in the terminal. See [Installing a SIM Card](#) on page 1-24.
2. Ensure a GSM WAN connection is properly configured. See [Configuring a GSM WAN Connection](#) on page 10-23.
3. Tap *Start - Settings*.
4. Tap the *Connections* tab, and select *Connections* icon.
5. Tap the *Dialing Locations* tab.



**Figure 10-19. Dialing Locations Tab**



- Set the area code to match the area code entered earlier, in the Entering Phone Number screen (see [Figure 10-6](#)). Tap **Dialing Patterns**.



**Figure 10-20. Dialing Patterns Screen**

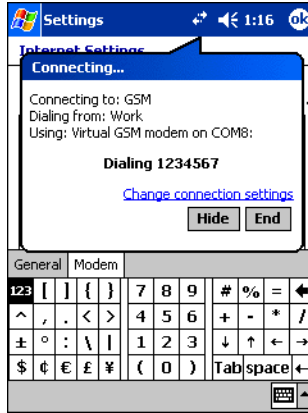
- On the Dialing Patterns screen, edit the patterns as shown above, deleting the “9,” from each location.
- Tap **OK** until you return to the *Connections* screen, and select the *Connections* tab. Tap *Connect*. The Network Log On screen displays.
- Enter the appropriate username or password for a GSM connection.
- Tap **OK**.

---

**Note:** *If the SIM card is protected with a PIN number, a dialog box will pop up requesting the appropriate PIN number to unlock the SIM card.*

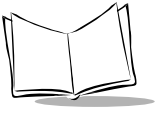
---

The *Connecting* dialog box displays.



**Figure 10-21. Connection Dialog Box**

11. Once a connection is establish, you can launch Internet Explorer by tapping *Start - Internet Explorer*.
12. To end a connection, tap the double arrows on the Navigation bar and tap *End*.



*PDT 8000 Series Product Reference Guide*





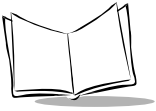
# Chapter 11

## *Software Installation on Development PC*

### **Chapter Contents**

---

Introduction .....	11-3
Before You Install the SDK .....	11-3
Symbol Windows CE SDK .....	11-3
Installing the SDK on the Development PC .....	11-4
Installing the SDK .....	11-4
Installing Other Development Software .....	11-4



*PDT 8000 Series Product Reference Guide*

## Introduction

---

To develop applications to run on the terminal, the *Symbol Windows CE Software Developer's Kit (SDK)* is available. This SDK contains PDT 8000-specific software not available in the standard Microsoft Windows CE Platform SDK.

The minimum system configuration required to install the SDK is:

- IBM-compatible host computer with Pentium 150 MHz processor or higher
- Windows® 98 second edition, or Windows® NT operating system version 4.0 with Service Pack 5 or later, or Microsoft Windows 2000 operating system
- 24MB RAM for Windows 98, 32 MB RAM for Windows NT
- 100MB available hard disk space
- CD-ROM drive
- One available serial port
- Mouse.

Also, be sure the drive you are installing accepts long filenames (larger than the 8.3 filename convention).

### ***Before You Install the SDK***

Before you install the Symbol Windows CE SDK, install the following tools:

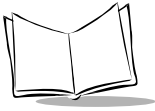
- Microsoft eMbedded Visual Tools 3.0 (ensure that both eMbedded Visual C++ and eMbedded Visual Basic are installed)
- Windows CE Platform SDK for Pocket PC
- Microsoft ActiveSync version 3.5 or greater.

## Symbol Windows CE SDK

---

The SDK installation program loads the required Windows CE components on the development PC used to create the image files (via Terminal Configuration Manager) for download to the terminal. The Symbol SDK includes:

- Symbol-provided files
- Printer drivers
- TCM scripts
- Sample code.



## Installing the SDK on the Development PC

---

The Symbol SDK installs through Windows in the directory C:\SYMBOL WINDOWS CE SDK, and also installs files in the Windows CE Tools directory (generated by the CE Tool Kit).

### ***Installing the SDK***

Install the SDK from the Symbol Developer Zone Web site <http://devzone.symbol.com>. Follow the installation prompts.

Once installation of the SDK is complete, use eMbedded Visual C++ or eMbedded Visual Basic to view the active Windows CE configuration, Microsoft Pocket PC, and display the directory in which the SDK is installed.

## Installing Other Development Software

---

Developing applications for the terminal may require installing other development software such as application development environments on the development PC. Follow the installation instructions provided with this software.



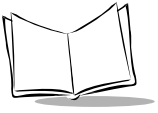
# Chapter 12

## Configuring the Terminal

### Chapter Contents

---

Introduction . . . . .	12-3
Starting Terminal Configuration Manager . . . . .	12-4
Defining Script Properties . . . . .	12-6
Creating the Script for the Hex Image . . . . .	12-8
Open a New or Existing Script . . . . .	12-8
Copy Components to the Script . . . . .	12-8
Save the Script . . . . .	12-9
Building the Image . . . . .	12-10
If the Build Fails . . . . .	12-11
Sending the Hex Image . . . . .	12-12
Connect the Terminal and Development PC . . . . .	12-12
Set Up IPL to Receive the File . . . . .	12-12
64MB RAM Configuration . . . . .	12-12
128MB RAM configuration . . . . .	12-16
Begin the Send in TCM . . . . .	12-20
Error Messages . . . . .	12-21
IPL Error Detection . . . . .	12-21
TCM Error Messages . . . . .	12-23
Creating and Loading a Splash Screen . . . . .	12-23
Loading the Splash Screen via TCM . . . . .	12-24



*PDT 8000 Series Product Reference Guide*

## Introduction

---

This chapter describes the Terminal Configuration Manager (TCM), and how it is used to specify and load files into the flash memory of the terminal using the terminal's Initial Program Loader (IPL).

In TCM, you create a *script* that contains the information (commands to copy files) for building the image. TCM works with directory windows which display the directory structure of your script and the source directories, files, and scripts from which you pull components. You can open multiple scripts, drag and drop items from a drive/directory to the script, rename and delete files in the script, etc. Upon building the image, TCM adds all the files, directories, and scripts referenced in the script to the image.

The SDK includes a number of standard scripts and demos/samples for you to use as a base for creating your own scripts. These scripts can be found in the Symbol Windows CE SDK(PDT8000)\PDT80xx\TCMScripts directory.

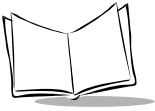
---

**Note:** *Before you create a script to build a hex image, identify the files required (system files, drivers, applications, etc.) and locate the files' source directories to make the script building process easier.*

---

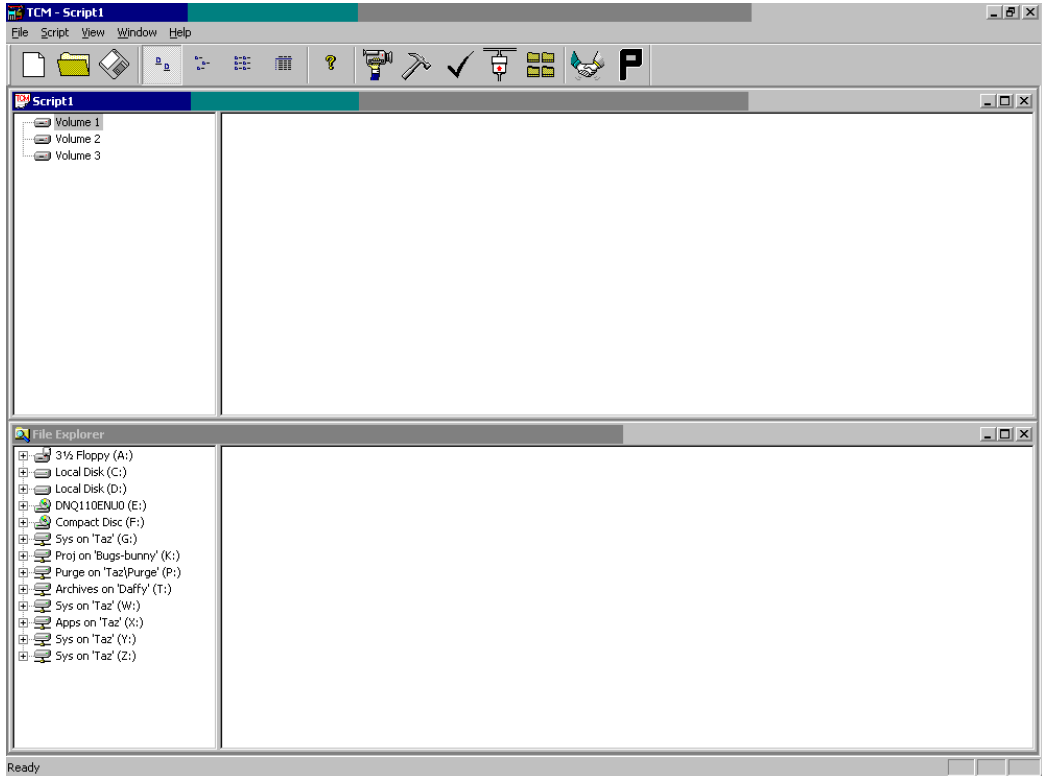
The required processes for building a hex image in TCM include:

- Starting TCM
- Defining script properties
- Creating or modifying a script
- Building the hex image
- Sending the hex image.



## Starting Terminal Configuration Manager















To start TCM, double click on the TCM icon in the SYMSDK group. The following screen appears, displaying two directory windows; Script1 and File Explorer. Each directory window is split; the left half (or *pane*) of the window displays the directory tree for the current drive, and the right half displays the directory contents for the current drive.

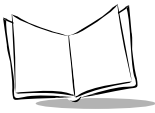




The following table lists the components of the TCM start-up screen.

**Table 12-1. TCM Screen Components**

Component	Description			
Script Window	<p>Associated with a script file containing the information to create a Flash Disk image. This window is the <i>target</i> window, or the primary TCM window in which you can create a script or change a script file's contents by copying, deleting, and renaming files and directories. More than one script window can be open at a time.</p> <p>The Script Window consists of two panes, the Directory Tree Pane on the left and the Directory Contents Pane on the right. Subordinate directories and files of each volume are listed in the Directory Contents Pane.</p>			
File Explorer	A <i>read-only source</i> window for files and/or directories to include in the script being built.			
Tool Bar	Contains the tools, illustrated below, for taking action on a script.			
		Create a new script file.		Check script for existing files.
		Open a script file.		Select the hex image to load.
		Save a script file.		Tile windows.
		View script properties.		Build and send the hex image to the terminal.
		Build a script.		Preferences.
		View large icons.		About TCM.
		View small icons.		View list.



## Defining Script Properties

Before a script is created, the script properties must be defined. This defines the type of terminal, flash type, number of disks being created, and the memory configuration of each disk volume.

To define the script properties:

1. With TCM open, click on the Script Window to make it the active window.
2. Under the *Script* menu, select the *Properties* option.

OR

Click on  from the tool bar. The *Script Properties* window displays.

Partition Table Properties			
	Volume Label	Size	Access
Disk 1:	Platform	15616	Read/Write
Disk 2:	Application	15616	Read/Write

3. From the *Terminal* drop-down menu, select:
  - a. 8000-64M for terminals with 64MB Flash
  - b. 8000-128M for terminals with 128MB Flash
4. From the *Flash Type* drop-down menu, ensure
  - a. 40A-1F400Z is selected for terminals with 64MB Flash
  - b. 40A-3E800Z is selected for terminals with 64MB Flash

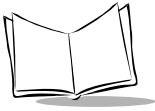
5. From the *Disks* drop-down menu, select the number of disk volumes to be created.

---

**Note:** *The options available under the disks drop-down menu changes depending on the flash type. Some flash types only have one option for the number of disk volumes, others have two options.*

---

6. If you have selected three volumes under the *Disk* drop-down menu, you have the option to change the memory configuration of the second and third volumes. To do so, click on the up or down arrow for either of the volumes, until the memory configuration of each is set to the desired value. You will notice that as you change the values for one of the volumes, the other volume is automatically changed accordingly.
7. For each disk volume, determine the Read/Write access option.
8. The Script File Path displays the path of the selected script file.



## Creating the Script for the Hex Image

---

On start-up, TCM displays the screen shown on page 12-4, with the Script1 window and File Explorer window.


The Script1 Window directory pane displays three volumes: Volume1, Volume2, and Volume3. Depending on the type of flash chip you have, the number of volumes may change. Files can be added to each of the volumes. With TCM, you can:

- Create a new script file or open an existing script
- Drag and drop existing files and directories to that script
- Save the script.


Each process is described in the sections that follow.

### ***Open a New or Existing Script***

Scripts are created in the Script Window. To open a new script:

- From the *File* menu, choose *New*, OR
- Click on  from the tool bar.

To open an existing script (e.g., a standard script provided in the SDK):

- From the *File* menu, choose *Open*. Navigate to the Symbol Windows CE SDK(*PDT8000*)\SymbolPlatforms\PDT80xx\TCMScripts directory and select the script file name, OR
- Click on  from the toolbar. Navigate to the Symbol Windows CE SDK(*PDT8000*)\SymbolPlatforms\PDT80xx\TCMScripts directory and select the script file name, OR
- Double click on an existing script in the Script Browser window.

### ***Copy Components to the Script***

To copy files or directories to the script being generated:

1. Click on the File Explorer Window to make it the active window.
2. Click on the source directory in the Directory Tree Pane. TCM displays the directory contents in the Contents Pane.

3. Click on the file(s) and/or directory in File Explorer.

---

**Note:** *Optionally, use the standard Windows Shift+Left-click and Control+Left-click features to select multiple files and directories.*

---


4. Drag and drop the selected file(s) and/or directory from File Explorer to the target directory in the Script Window,  
OR

Click on the target directory and select the File Explorer Copy icon from the toolbar and paste into the target directory in the Script Window.

## **Save the Script**

To save the changes to a new script:

1. From the *File* menu, choose *Save As*,  
OR

On the toolbar, click on  .


2. Enter the path and filename. TCM appends a .TCM extension to the script.
3. Choose the **OK** button.

---

**Note:** *If you save an untitled script, TCM by default saves the script to the directory that the Script Browser is pointing to.*

---

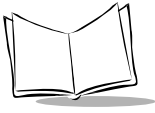
To save changes to an existing script:

- From the *File* menu, choose *Save*, OR
- On the toolbar, click on  .

---

**Note:** *If you open and make changes to an existing script, saving the changes writes over the existing script. If you wish to use an original or Symbol-supplied standard script as a base and save the changes in a new script, use *Save As* instead of *Save* after making the changes, and save to a different filename.*

---



## Building the Image

---

As part of the build, TCM performs a check on the script which verifies that all files referenced in the script exist. If the image is bootable, TCM verifies that the boot files are available.


---

**Note:** *Performing a check is more important for previously existing scripts to ensure that files referenced in the script are still in the designated locations.*

---

To check a script:

1. In the Script Window, select the script.
2. Save the script, if not already saved.
3. From the *Script* menu, choose *Check*,  
OR

On the toolbar, click  .

4. TCM verifies that files referenced in the script exist on available drives and lists an error message in the Errors found box for any missing files.
5. Choose the OK button to exit.

To build a script:

1. In the Script Window, select the script to be built.
2. From the *Script* menu, choose *Build*,  
OR

On the toolbar, click  . The Configure Build window appears.

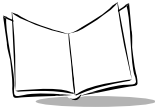


3. Select the item to build. If you select to build an application, specify the application.
4. Select ASCII format for your hex image, or Compression, which reduces the size of most hex images in order to speed downloading.
5. Click OK.
6. TCM performs a check. If the script has no errors, TCM proceeds with the build.

## If the Build Fails

If the build fails, TCM displays a message indicating which file(s) are missing.

If the total amount of flash required by the script exceeds the image size, a TCM error results. To correct this, reduce the number of files in the volume, or make the disk non-bootable. Refer to [Defining Script Properties](#) on page 12-6 for more information on setting the image size appropriately.



## Sending the Hex Image

---

Once the hex file is built, you are ready to download it to the terminal. A Hex image download requires both TCM and a program loader stored on the terminal. The terminal comes with a program loading utility, Initial Program Loader (IPL), stored in the terminal's write-protected flash. To run IPL, the terminal must be connected to a development PC by direct serial connection.

### ***Connect the Terminal and Development PC***

To send the hex file to the terminal, first connect the terminal and development PC by one of the following devices:

- Serial Charging Cable (p/n 25-55853-01)
- Single-Slot Serial Cradle (p/n CRD8000-1000S).

### ***Set Up IPL to Receive the File***

---

**Note:** *IPL only recognizes files in the 8.3 format (file names can have up to eight characters, followed by a period and an extension of up to three characters). It does not support long file names.*

---

### **64MB RAM Configuration**

To set up IPL on the terminal to receive the files being downloaded via TCM:

---

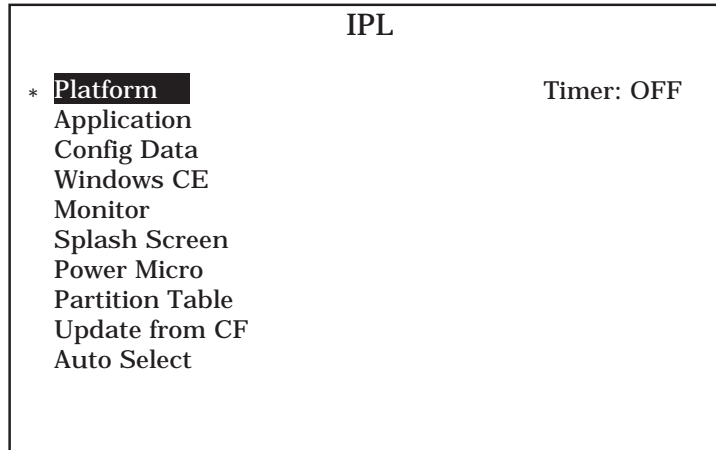
**Note:** *Terminal display is in landscape mode in IPL. Therefore, rotate your terminal 90 degrees to the right to read the display correctly.*

---

1. Hard reset the terminal by removing the battery door and pressing the Power key and a Scan button, simultaneously.
2. Press the 5 key when three } appear on the bottom left of the screen.



3. IPL displays the Main Menu which lists the partitions/applications that can be downloaded.

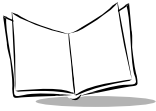


4. Use the up and down scroll buttons to select the partition to be received, then press the Enter button.
  - a. *Auto Select* is the default, and will be selected if no other selection is made within 10 seconds.
  - b. If you select *Update from CF*, skip to step 9b.

---

**Note:** *If the platform application or data partition sizes are changed, you must download a new partition table first.*

---



- IPL displays the *Select Transport* screen which lists the available methods of downloading the file.

### Select Transport

\* **Serial - No Flow** Timer: OFF  
Serial - RTS/CTS  
Serial - Xon/Xoff  
Previous  
Top

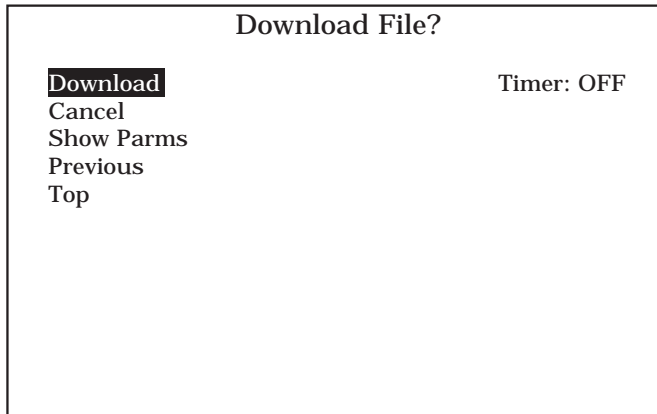
- Use the up and down scroll buttons to select the method of transport, then press the Enter button.
- IPL displays the *Select Baud Rate* screen which lists the available baud rates for the serial connection.

### Select Baud Rate

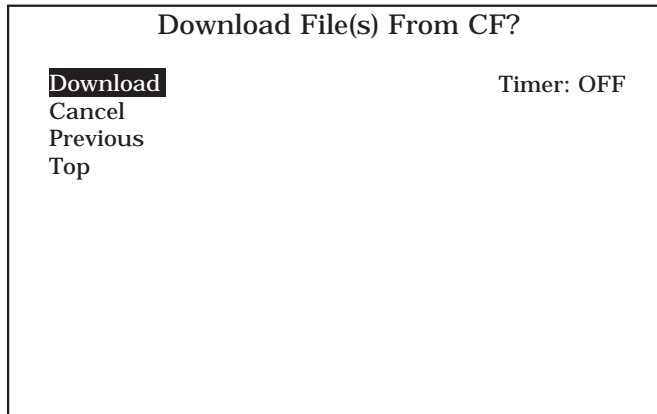
\* **115200** Timer: OFF  
57600  
38400  
19200  
9600  
Previous  
Top

- Use the up and down scroll buttons to select the appropriate baud rate, then press the Enter button.

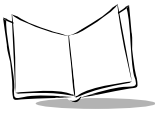
9. The following screen allows you to confirm your download. Use the up and down scroll buttons to make the appropriate selection, then press the Enter button.



- a. You can select *Show ParmS* to view a summary of all the selections you have made in the previous steps.
- b. If you selected *Update from CF* in step 4, the following confirmation screen displays. Use the up and down scroll buttons to make the appropriate selection, then press the Enter button.



10. When the entire image is received, IPL indicates that the download is complete.
- a. If you selected *Serial* in step 5, the terminal will indicate a "waiting for input" message. In TCM, select the desired file and press download. The download



- status screen will then appear. When complete, press the Enter button to return to the main menu.
- b. If you selected *Auto Select* in step 4, the terminal will automatically return to the main menu once download is complete.
  - c. If you selected *Monitor* in step 4, the terminal will reboot once download is complete.
11. When all partitions are downloaded successfully, hard reset the terminal by removing the battery door and pressing the Power key and a Scan button, simultaneously.

## 128MB RAM configuration

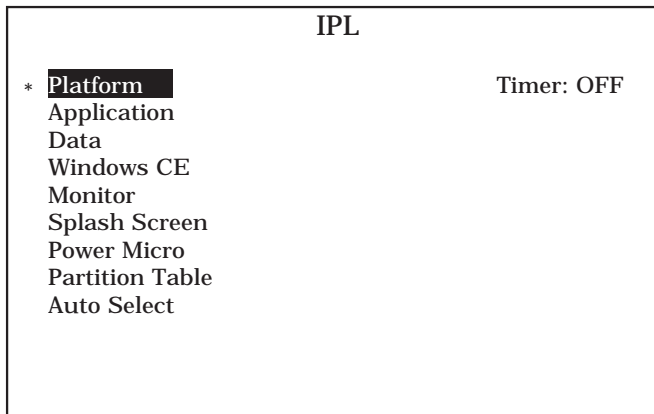
To set up IPL on the terminal to receive the files being downloaded via TCM:

---

**Note:** *Terminal display is in landscape mode in IPL. Therefore, rotate your terminal 90 degrees to the right to read the display correctly.*

---

1. Hard reset the terminal by removing the battery door and pressing the Power key and a Scan button, simultaneously.
2. Press the 5 key when three } appear on the bottom left of the screen.
3. IPL displays the Main Menu which lists the partitions/applications that can be downloaded.



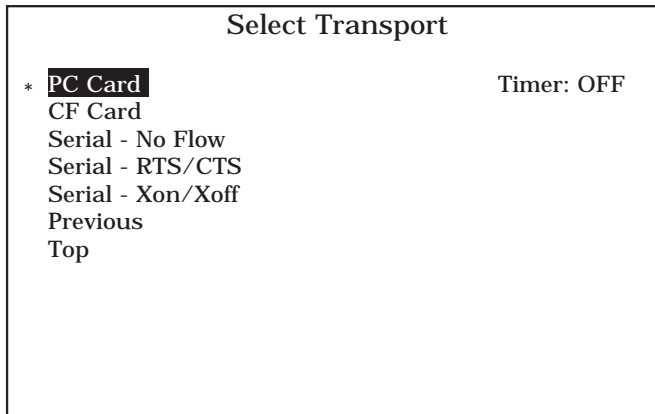
4. Use the up and down scroll buttons to select the partition to be received, then press the Enter button. *Auto Select* is the default, and will be selected if no other selection is made within 10 seconds.

---

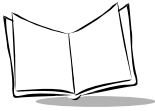
**Note:** *If the platform application or data partition sizes are changed, you must download a new partition table first.*

---

5. IPL displays the *Select Transport* screen which lists the available methods of downloading the file.



6. Use the up and down scroll buttons to select the method of transport, then press the Enter button.
7. This screen varies depending on the selection you make in step 6.



- a. If you selected *PC Card* or *CF Card*, the *Select File Name* screen displays. Use the up and down scroll buttons to select the file you want to download, then press the Enter button.

**Select File Name**

Timer: OFF

This screen displays the files that can be downloaded from the PC Card or CF Card.

- If you select Platform, Application, Data, Splash Screen, or Partition Table in step 3, this screen displays available .HEX files.
- If you select Windows CE, Monitor, or Power Micro in step 3, this screen displays available .BIN files.
- If you select Auto Select in step 3, this screen displays available .IPL files.

---

**Note:** A .IPL file is a Symbol provided file used for updating all the images in the terminal.

---

If the file name you select does not match the partition/application you want to download, you will get an error.

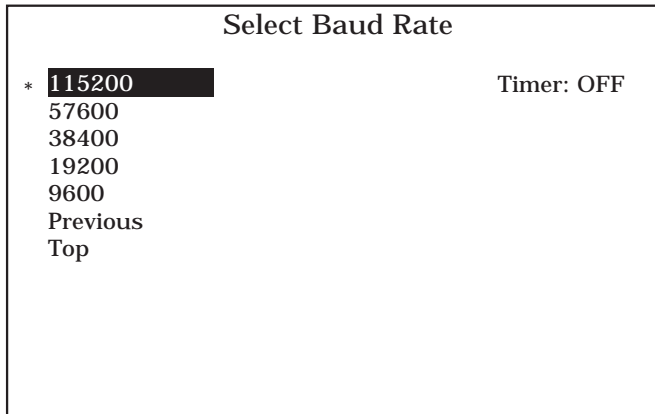
If your PC or CF Card is empty or not inserted in the terminal, you will get the following screen:

**Select File Name**

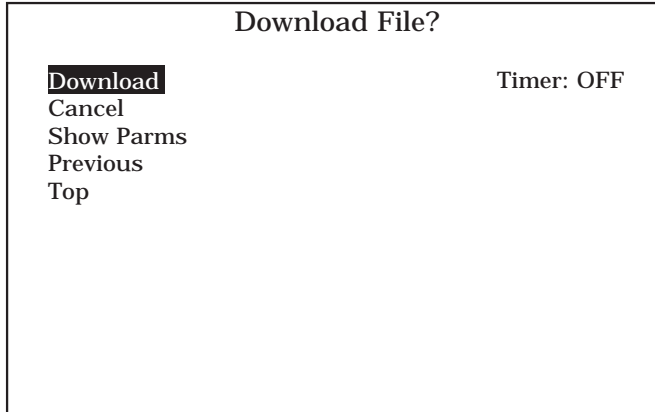
Timer: OFF

\* **Prev**  
Top

- b. If you selected *Serial*, the *Select Baud Rate* screen displays. Use the up and down scroll buttons to select the appropriate address configuration, then press the Enter button.

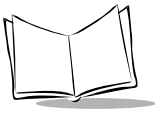


8. The following screen allows you to confirm your download. Use the up and down scroll buttons to make the appropriate selection, then press the Enter button.



You can select *Show ParmS* to view a summary of all the selections you have made in the previous steps.

9. When the entire image is received, IPL indicates that the download is complete.
- a. If you selected *Serial* in step 5, the terminal will indicate a “waiting for input” message. In TCM, select the desired file and press download. The download




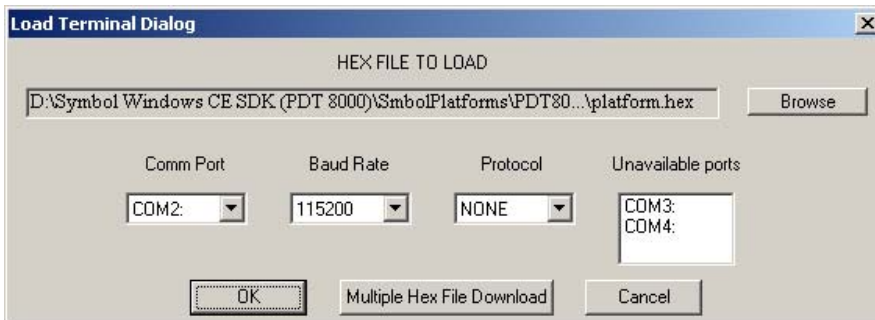
- status screen will then appear. When complete, press the Enter button to return to the main menu.
- b. If you selected *Auto Select* in step 4, the terminal will automatically return to the main menu once download is complete.
  - c. If you selected *Monitor* in step 4, the terminal will reboot once download is complete.
10. When all partitions are downloaded successfully, hard reset the terminal by removing the battery door and pressing the Power key and a Scan button, simultaneously.

## Begin the Send in TCM

In TCM on the host computer:

1. Select the script.
2. From the *File* menu, choose *Load Terminal*,  
OR

On the toolbar, choose  . The *Load Terminal* screen displays.



3. If the correct hex file is not displayed in the *Hex File to Load* field, click on the *Browse* button and navigate to the correct hex file to be downloaded.
4. From the *Comm Port* drop-down menu, select the COM port being used. Ports already in use display in the *Unavailable Ports* field.
5. From the *Baud Rate* drop-down menu, select the appropriate baud rate. Your options are 2400, 4800, 9600, 19200, 38400, 57600, 115200.
6. From the *Protocol* drop-down menu, select *None*.



- Click **OK** to load the file, or **Multiple Hex File Download** if more than one file is being loaded.

## Error Messages

---

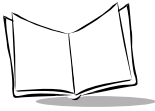
### ***IPL Error Detection***

While receiving data, IPL performs many checks on the data to ensure that the data is received correctly. If an error is detected, IPL immediately aborts the download, and reports the error on the terminal.

This screen displays until you press **Enter**. Once the screen is acknowledged, IPL returns to the Main Menu screen to wait for a new selection.

The cause of the error displays under the **Download Failed!** indication. The errors that can be reported, and the probable cause of the error, are as follows:

<b>Error</b>	<b>Description</b>
<b>Download Cancelled</b>	This error occurs when the user cancels the download.
<b>Bad Checksum</b>	This error occurs when the file is invalid or there is a communication error.
<b>Bad Storage Checksum</b>	This error occurs when the file is invalid or there is a communication error.
<b>Not BIN File</b>	This error occurs when the file is invalid.
<b>Not SREC File</b>	This error occurs when the file is invalid.
<b>Record Short</b>	This error occurs when the file is corrupt or invalid.
<b>Not SYMHEX File</b>	This error occurs when the file is invalid.
<b>Bad HEX Record</b>	This error occurs when the file is invalid.
<b>Invalid HEX Data</b>	This error occurs when the file is invalid.
<b>Exceed Max Size</b>	The size of the image is also part of the Header record. If the data to be written exceeds the size of the partition as indicated in the partition table, this error occurs.
<b>Invalid/Wrong Partition</b>	If a specific partition is selected from the partition list, and the destination code of the Header record downloaded does not match the index of that partition, this error occurs.



<b>Error</b>	<b>Description</b>
<b>Invalid Image</b>	This error occurs if another record is received before the Header Record. Ensure the Header Record is the first record downloaded.
<b>Partition Not Defined</b>	The destination code is part of the Header record and is used as an index into the partition table. The partition table entry located at this index contains partition information for the data downloaded. If the AutoSelect option is selected, a check is made to ensure that valid partition information exists in the partition table at this index. The check verifies that the Area Name and Sector Size are both non-zero. If not, this error occurs.
<b>Incorrect Byte Count</b>	Image data is processed until the End Of File (EOF - Record Type 01) record is received. This error occurs if IPL detects that the number of bytes received does not equal the number of bytes sent.
<b>Unable to Verify Partition Data</b>	If the Receive and Verify bit is set for that partition, the data is verified, the flash sector erased, and the data written to the flash part. If this data can not be verified, this error occurs.
<b>Transmission Errors</b>	The following error messages may appear if an error occurs during transmission: <ul style="list-style-type: none"><li>• Checksum Error occurs if an invalid checksum is detected in the record.</li><li>• Invalid Record occurs if a record is not defined in the Symbol Hex File Format.</li><li>• Connection Lost occurs if one of the handshaking lines is de-asserted during download.</li><li>• Address Out of Sequence occurs if the address of the data received is not sequential.</li></ul>

## TCM Error Messages

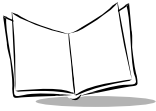
TCM validates the cells in your partition table when you select the `Execute` button. Cells highlighted in red contain an error. Partition loading is disabled until all errors are corrected. Following are errors that TCM may encounter, and possible solutions.

Error	Description
<b>Error - Partition Size</b>	The size of a partition must be an integral multiple of the <code>FFSSectorSizeInBytes</code> specified by the <code>.ini</code> file. When the user enters a partition size, TCM rounds up to the next highest integral multiple of the sector size and displays this value in the partition table grid. This error check is made upon value entry, independent of the <code>Execute</code> button.
<b>Error - Image Larger than Partition</b>	If the required size of the binary image file is larger than the associated partition size, the Partition Size cell in the partition grid turns red to highlight the error. The Required Size cell indicates the actual size required.
<b>Error - Total size of all FFS Partition</b>	If the total memory allocated to the 3 FFS partitions is greater than the total Flash Memory on the terminal, the Used FFS Memory display box turns red. Decrease the size of one or more of the partitions, then recheck the configuration using the <code>Execute</code> button.
<b>Error - Source/ Destination Path Verification</b>	If the directory paths specified by the Source and Destination cells do not exist, the cell containing the non-existent path turns red to highlight the error.

## Creating and Loading a Splash Screen

To generate a custom splash screen, use a bitmap editor, such as Paintbrush.

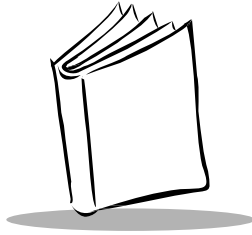
1. Create a 256-color bitmap with dimensions of BX x BY where:
  - BX is less than or equal to 240 pixels
  - BY is less than or equal to 320 pixels
2. Be sure to create the file with 256 colors. IPL will not load if the file is not created correctly.
3. After designing the splash screen, rotate the bitmap 90 degrees clockwise.
4. Save the file as a 256-color bitmap.
5. Use TCM to convert the bitmap image file to a hex file (see [Building the Image](#) on page 12-10).



## ***Loading the Splash Screen via TCM***

To load the bitmap:

1. Click **TCM.exe** in the TCM directory.
2. Connect the terminal to the development PC and invoke IPL to prepare the terminal to receive the splash screen download.
3. Select *Load Terminal* from the *File* menu on the development PC.
4. Select your splash screen hex file to begin downloading to the terminal.
5. Close TCM.



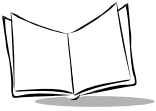
# Chapter 13

## *Maintenance and Troubleshooting*

### **Chapter Contents**

---

Introduction .....	13-3
Maintaining the Terminal .....	13-3
Troubleshooting .....	13-4



*PDT 8000 Series Product Reference Guide*

## **Introduction**

---

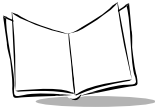
This chapter includes instructions on cleaning and storing your terminal, and provides troubleshooting solutions for potential problems during terminal operation.

## **Maintaining the Terminal**

---

For trouble-free service, observe the following tips when using the terminal:

- Take care not to scratch the screen of the terminal. When working with the terminal, use the supplied stylus or plastic-tipped pens intended for use with a touch-sensitive screen. Never use an actual pen or pencil or other sharp object on the surface of the terminal screen.
- Although the terminal is water and dust resistant, do not expose it to rain or moisture for an extended period of time. In general, treat the terminal as you would a pocket calculator or other small electronic instrument.
- The touch-sensitive screen of the terminal contains glass. Take care not to drop the terminal or subject it to strong impact.
- Protect the terminal from temperature extremes. Do not leave it on the dashboard of a car on a hot day, and keep it away from heat sources.
- Do not store or use the terminal in any location that is extremely dusty, damp or wet.
- Use a soft lens cloth to clean the terminal. If the surface of the terminal screen becomes soiled, clean it with a soft cloth moistened with a diluted window-cleaning solution.



# Troubleshooting

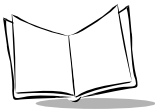
**Table 13-1. Troubleshooting Your Terminal**

<b>Problem</b>	<b>Cause</b>	<b>Solution</b>
Terminal does not turn on.	Lithium-ion battery not charged.	Charge or replace the lithium-ion battery in the terminal.
	Lithium-ion battery not installed properly.	Ensure battery is installed properly.
	System crash.	Perform a soft reset. If the terminal still does not turn on, perform a hard reset. See <a href="#">Resetting Your Terminal</a> on page 2-34.
Terminal does not respond to wake-up source.	Terminal is not configured to respond to any wake-up source.	Check wake-up configuration. See <a href="#">Configuring Wake-ups</a> on page 1-34.
	Terminal battery door was reinstalled.	Press the Power button to turn on the terminal. The terminal only responds to the Power button after the battery door is reinstalled.
	Battery fault condition.	Press the Power button to turn on the terminal. The terminal only responds to the Power button after a battery fault condition.
	Terminal suspended due to very low battery.	Press the Power button to turn on the terminal. The terminal only responds to the Power button after it goes into suspension mode due to very low battery. <b>Note:</b> Ensure battery is charged or replaced with a charged battery before powering on terminal again.



**Table 13-1. Troubleshooting Your Terminal (continued)**

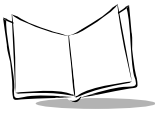
Problem	Cause	Solution
Rechargeable lithium-ion battery did not charge.	Battery failed.	Replace battery. If your terminal still does not operate, try a soft reset, then a hard reset; see <a href="#">Resetting Your Terminal</a> on page 2-34.
	Terminal removed from cradle while battery was charging.	Insert terminal in cradle and begin charging. The lithium-ion battery requires up to 4 hours to recharge fully.
	Battery is not within charging temperature range.	Ensure the battery is within the charging temperature range. See <a href="#">Appendix D, Technical Specifications</a> for specified range. <b>Note:</b> The terminal contains circuitry that monitors the battery temperature. This circuitry will disable battery charging if the battery temperature is not within the specified range.
Cannot see characters on display.	Terminal not powered on.	Press the Power button.
Fail to communicate with IrDA printer.	Distance from printer is not between 5 inches and 39 inches.	Bring the terminal closer to the printer and attempt communications again.
	Obstruction interfered with communication.	Check the path to ensure no objects were in the way.
	Application is not enabled to run IrDA printing.	Printer support must be included with the application to run IrDA printing on the terminal. See your System Administrator.
During data communication, no data was transmitted, or transmitted data was incomplete.	Terminal removed from cradle or unplugged from host PC during communications.	Replace the terminal in the cradle, or reattach the terminal to the host PC, and retransmit.
	Incorrect cable configuration.	See your System Administrator.
	Communication software was incorrectly installed or configured.	Perform setup as described in the <a href="#">Chapter 4, Communications</a> .

**Table 13-1. Troubleshooting Your Terminal (continued)**

<b>Problem</b>	<b>Cause</b>	<b>Solution</b>
GPRS/GSM connection cannot be established.	SIM card is not installed.	See <a href="#">Installing a SIM Card</a> on page 1-24 for detailed instructions.
	Network is busy.	Try again after 5 minutes.
	Poor signal/out of coverage.	Ensure that the area you are in is covered by your network provider. If you are receiving a poor signal, relocate to an area that provides better signal.
	GPRS parameters are entered incorrectly.	See <a href="#">GPRS Parameters Configuration</a> on page 10-3 for detailed parameter information.
	Band is set incorrectly.	See <a href="#">Change Band Screen</a> on page C-8 for correct band information.
No sound is audible.	Volume setting is low or turned off.	Check the System Volume slider in the <b>Sounds &amp; Reminders</b> properties dialog box (under <i>Start - Settings</i> ) to ensure the volume is not turned down or off.
Terminal turns itself off.	Terminal is inactive.	Your terminal turns off after a period of inactivity. If the terminal is running on battery power, this period can be set from 1 to 5 minutes, in one-minute intervals. If the terminal is running on external power, this period can be set to 1, 2, 5, 10, 15, and 30 minutes.  Check the <b>Power</b> dialog box (in the <b>System</b> tab under <i>Start - Settings</i> ), and change the setting if you need a longer delay before the automatic shutoff feature activates.
	Battery is depleted.	Replace the battery.
	Battery cover is removed.	Replace the battery door.

**Table 13-1. Troubleshooting Your Terminal (continued)**

<b>Problem</b>	<b>Cause</b>	<b>Solution</b>
Terminal doesn't recognize my handwriting.	Character strokes written incorrectly with the stylus.	If you're using the Block Recognizer input method, characters must be written a certain way. See <a href="#">Appendix A, Block Recognizer Characters</a> for information about how to write character strokes.
	Character strokes written on the wrong part of the LCD screen.	If you're using the Block Recognizer or Letter Recognizer input method, make the character strokes in the lower character entry area on the screen — not on the display part of the screen.
	Lowercase and uppercase letters, and numbers written on the wrong parts of the LCD screen.	Ensure you are writing letters and numbers in the appropriate section of the writing area.
Tapping the screen buttons or icons does not activate the corresponding feature.	LCD screen not aligned correctly.	Align the screen. Tap <i>Start - Settings - System</i> tab - Screen icon, or hold down the <b>Shift</b> key and press the <b>2</b> key.
	The system is hung.	Soft reset the system. To perform a soft reset, see <a href="#">Resetting Your Terminal</a> on page 2-34.
A message appears stating that your terminal memory is full.	Too many files stored on the terminal.	Delete unused memos and records. You can save these records on your computer.
	Too many applications installed on the terminal.	If you have installed additional applications on your terminal, remove them to recover memory. Tap <i>Start - Settings - System</i> tab - Remove Programs icon and select the unused program. Tap <i>Remove</i> .
Beamed data does not transmit.	Terminals too close together or too far apart.	Confirm that the terminals are at least 5 inches and at most 39 inches apart. Also ensure that there is a clear path between the two devices.
	Insufficient room lighting.	Adjust the room lighting or move to a different location.



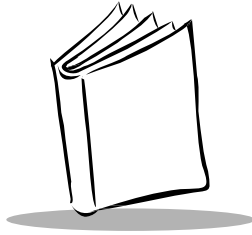
**Table 13-1. Troubleshooting Your Terminal (continued)**

<b>Problem</b>	<b>Cause</b>	<b>Solution</b>
When receiving beamed data an out of memory message appears.	Not enough free memory available for receiving data.	Your terminal requires at least twice the amount of memory available as the data you are receiving. For example, if you are receiving a 30K application, you must have at least 60K free.
Your terminal does not accept scan input.	Scanning application is not loaded.	Verify that the unit is loaded with a scanning application. See your System Administrator.
	Unreadable bar code.	Ensure the symbol is not defaced.
	Distance between exit window and bar code is incorrect.	Ensure you are within proper scanning range.
	Terminal is not programmed for the bar code.	Ensure the terminal is programmed to accept the type of bar code you are scanning.
	Terminal is not programmed to generate a beep.	If you are expecting a beep on a good decode and don't hear one, check that the application is set to generate a beep on good decode.
	Battery is low.	If the scanner stops emitting a laser beam when you press the trigger, check your battery level. When the battery is low, the scanner shuts off before the terminal notifies you of the low battery condition. <b>Note:</b> If the scanner is still not reading symbols, contact your distributor or Symbol Technologies.

---

**Note:** *If, after performing these checks, the terminal is still not reading symbols, contact your distributor or Symbol Technologies.*

---



## Appendix A

# Block Recognizer Characters

Using the Block Recognizer, you can write characters directly on your terminal screen with your stylus. These characters are translated into typed text. Use Block Recognizer to enter text, for example, to write a note or to fill in fields in a dialog box.

Figure A-2 provides examples of how to write characters in lowercase. The Block Recognizer input panel is divided into two writing areas. Letters written in the left area (labeled abc) create lowercase letters. Use the right area (labeled 123) for writing numbers, symbols, special characters, and punctuation.

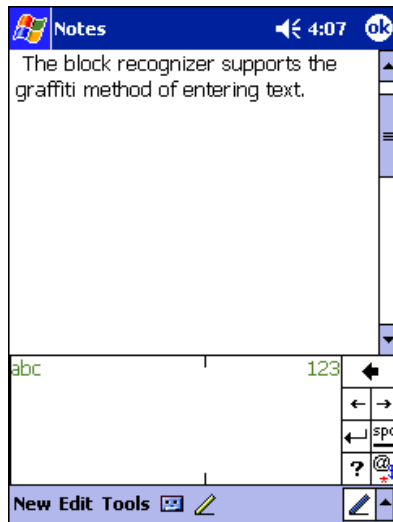
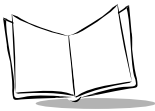


Figure A-1. Using Block Recognizer



The following chart illustrates some of the characters you can write (the dot on each character is the starting point for writing).

Letter Area					Number/Punctuation Area														
A	aa				N	h				0	0				)	)			
B	bb				O	oo				1	1				+	+			
C	c				P	pp				2	22				*	*x∞			
D	dd				Q	qq				3	3				/	/			
E	e				R	rr				4	4444L				\	\			
F	ff				S	s				5	555				?	? ? ?			
G	gg				T	t 7 7 7 7 †				6	6				!	!			
H	hh				U	uu				7	7				@	@			
I	ii				V	v				8	8				&	&			
J	JJ				W	ww				9	9				‘	‘			
K	k K K K α				X	x x x				>	>				“	“			
L	l L l				Y	y y y				·	·				-	-			
M	m				Z	z				(	(								

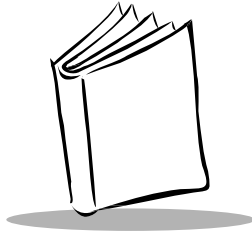
space	←
back space	→

enter	↵
back space	→

Figure A-2. Character Chart

For specific instructions on using Block Recognizer, with Block Recognizer open, tap the question mark next to the writing area.



## Appendix B

# Additional Programs

### Introduction

---

The PDT 8000 Series terminal can be loaded with additional programs that help with the functionality of the terminal and illustrate how some of the terminal's applications run.

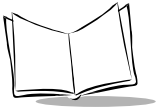
### CF Shutdown

---

The CF Shutdown utility can be used to shut off the S24 radio card in the compact flash card slot in order to preserve battery capacity and to minimize operational conflicts between the two radios that might be encountered by the applications developer.

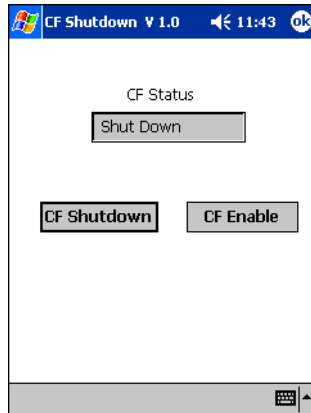
### Installing CF Shutdown

1. Download the CF Shutdown application to your host computer from <http://devzone.symbol.com>.
2. Establish an ActiveSync connection between the host computer and the terminal. See [Chapter 4, Communications](#) for detailed instructions.
3. Copy the CF Shutdown executable file, downloaded in step 1, to the application directory on your terminal.
  - a. In ActiveSync, click *Explore*. Windows Explorer will open the Mobile Device window for your device.
  - b. Open another Windows Explorer window and browse to the file that you want to copy on your device, i.e. the CF Shutdown executable file download in step 1.
  - c. Right-click the file and click *Copy*. Place the cursor in the desired folder on your Mobile Device, i.e. the Applications folder, right-click, and click *Paste*.

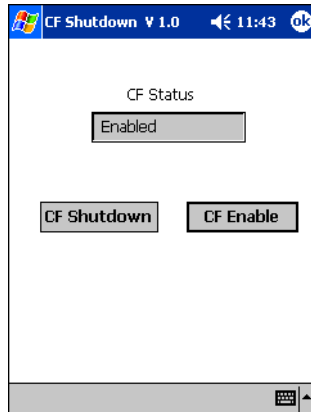


## Running CF Shutdown

1. Tap *Start - Programs - File Explorer*.
2. Navigate to the Application folder and select *CF Shutdown*.
3. To disable to compact flash card slot, tap *CF Shutdown*. The CF Status field displays “Shut Down.”



4. To enable to compact flash card slot, tap *CF Enable*.The CF Status field displays “Enabled.”



5. Tap OK for the setting to take affect.



## PDT 8000 Demo

---

The PDT 8000 Demo program illustrates how to use some of the terminal's many applications. If the demo program is not already on the terminal (check the *Start* menu), you may download the program from the *Symbol Windows CE Software Developer's Kit (SDK)*. See [Chapter 3, Customizing the Terminal](#) for instructions on adding programs to your terminal.

The following options are available via the demo program.

- VC Scan - sample scanning application for Visual C/C++
- VB Scan - sample scanning application for Visual Basic
- HTML Scan - sample scanning application for Pocket Internet Explorer
- Sounds - sample application demonstrates how to record, play back and save audio files
- Images - sample application illustrates how to manipulate displayed image files
- Files- sample file management utility
- Utilities accesses the Control Panel and Diagnostics
- CE Apps - accesses standard Microsoft Windows CE applications
- About - provides version number, and other information, for the Demo program
- Exit - exits the Demo program.

To initiate the demo program, tap *Start - PDT 8000 Demo*. The initial demo program screen appears.

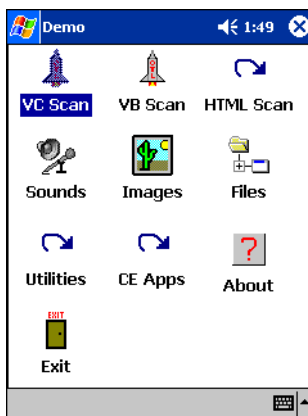
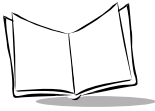


Figure B-1. Main Demo Screen



## VC Scan Demo

The Visual C/C++ sample scanning application enables the terminal's scanner, allows the user to change scan parameters, and displays scanned data. To access the VC Scan demo, tap *VC Scan* on the main demo screen.

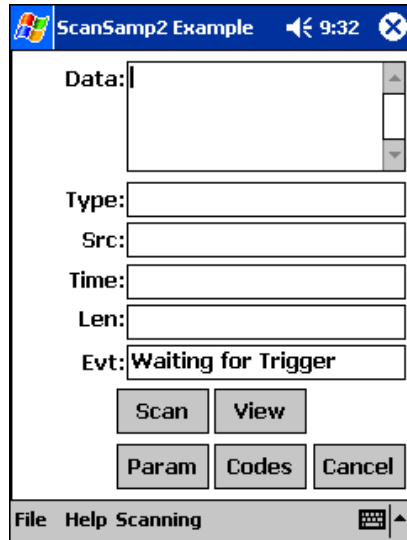


Figure B-2. Scan Sample Screen

## Scanning Data Fields

After a bar code is scanned, the following data appears in the screen:

- *Data* displays the data encoded in the scanned bar code.
- *Type* indicates the hex type scanned.
- *SRC* indicates the scanner being used, and the bar code type scanned (e.g., Code 128).
- *Time* displays the time the bar code was scanned.
- *Len* indicates the number of digits in the bar code
- *Evt.* indicates the status of the application, "Waiting for Trigger" or "Scanning."

## Scanning Options

The following options are available in the *Scan* screen:

- *Scan* provides an alternative to the trigger buttons on the terminal.
- *View* displays the bar code content in a separate screen.
- *Params* is used to change scanning parameter options, such as:
  - beep time (length of decode beep)
  - beeper frequency (tone)
  - LED-on time (length of time LED remains on upon decode)
  - Code ID (AIM, Symbol)
  - Wav File (sound of decode beep).
- *Codes* selects the code types the terminal is able to decode, and sets the options for each code type.
- *Cancel* closes the *Scan* screen.

## VB Scan Demo

The Visual Basic sample scanning application uses the ActiveX Scan Control to perform bar code scanning. To access the demo, tap *VB Scan* on the main demo screen.

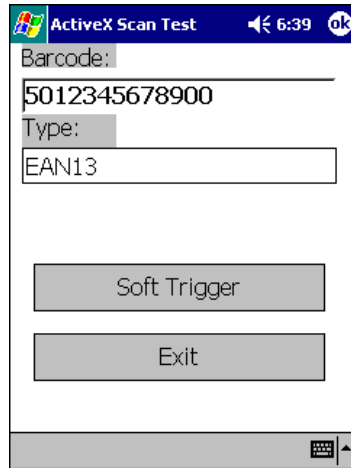
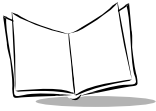


Figure B-3. ActiveX Scan Test Sample Screen

## Scanning Data Fields

After a bar code is scanned, the following data appears in the screen:

- *Barcode* displays the data encoded in the scanned bar code.



- *Type* indicates the bar code type scanned (e.g., Code 128).

## Scanning Options

The following options are available in the *Scan* screen:

- *Soft Trigger* provides an alternative to the trigger buttons on the terminal.
- *Exit* closes the *Scan* screen.

## HTML Scan Demo

The HTML Scan demo provides the HTML application ScanBrowse. You may also use this application to turn the Scan Wedge in ScanBrowse on and off. To access the demo, tap *HTML Scan* on the main demo screen.

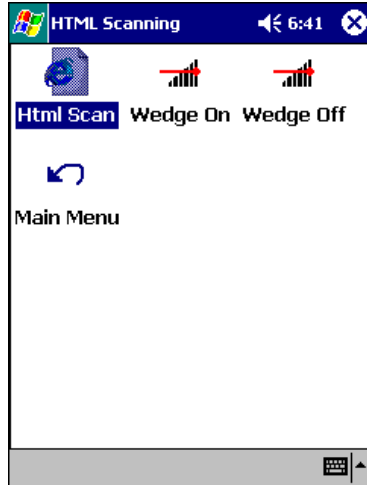
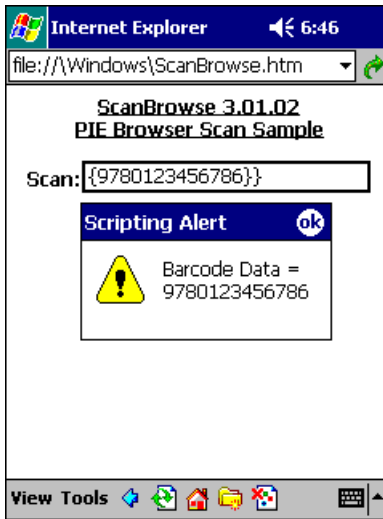


Figure B-4. HTML Scan Demo Screen

## Html Scan

Html Scan uses Pocket Internet Explorer to render the HTML code and the Scan Wedge to scan data into scan enabled fields.



**Figure B-5. Scan Browse Screen**

In this sample HTML application, the scan wedge is configured (via ScanWedge.reg) to bracket all scanned data with “{” and “}” to allow the HTML application to differentiate scanned data from keyboard-entered data.

## Wedge On/Off

These icons enable and disable the Scan Wedge. When enabled, the taskbar icon for the Scan Wedge appears in the task tray, and allows data to be scanned into edit fields.

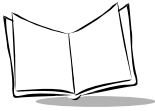
---

**Note:** *The Pocket PC Task Tray is only visible on the Today screen.*

---

## Main Menu

This icon takes you back to the Main Demo screen shown in [Figure B-1 on page -3](#).



## Sounds (Audio Sample)

Tap *Sounds* on the main demo screen for an audio sample, which demonstrates how to record, play back and save sounds.

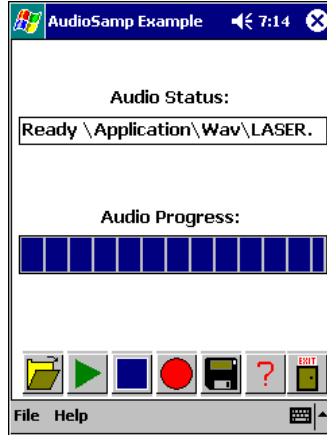


Figure B-6. Audio Sample Screen

Audio Files are opened from and saved to **\Application\wav\** by default, and are configured by the following registry key:

**HLCU\software\Symbol\settings**

**“WavDirectory” = “\Application\wav”**

## ***Images (ImageViewer Sample)***

Tap *Images* on the main demo screen for an ImageViewer sample, which demonstrates how to manipulate displayed image files.

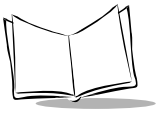


**Figure B-7. ImageViewer Screen**

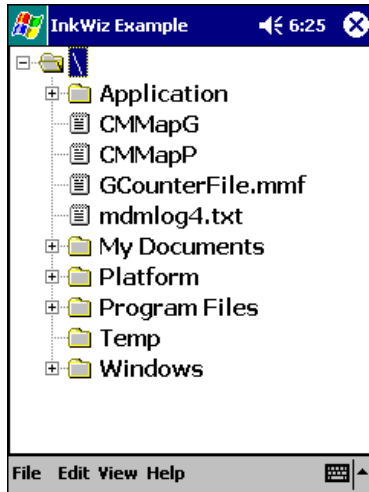
ImageViewer uses the SymDjpeg.dll (supplied with source code in the SDK) to convert the images between file formats. ImageViewer supports .bmp and .jpg formats.

## ***Files***

Tap *Files* on the main demo screen for a file browser utility, File Explorer, that provides similar Windows Explorer-like functionality on Pocket PC terminals. File Explorer allows the



user to browse, cut, copy, paste and delete files as well as execute the program. It also provides file transfer capability via the IrDA port.



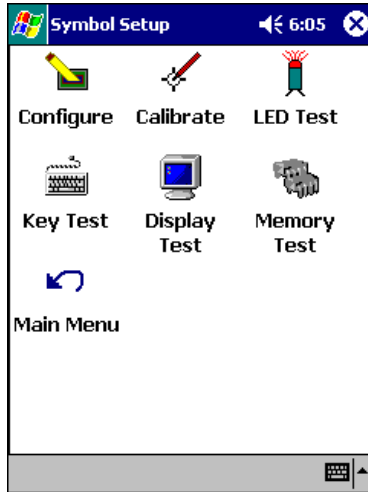
**Figure B-8. File Explorer Screen**

You can also access Microsoft File Explorer by tapping *Start - Programs*, and then selecting *File Explorer*.



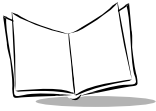
## Utilities

Tap *Utilities* on the main demo screen for diagnostic options that ensure various aspects of the terminal are functioning correctly.



**Figure B-9. Utilities Screen**

- *Configure* accesses the Control Panel screen.
- *Calibrate* allows you to re-calibrate the screen.
- *LED Test* tests the green decode LED-on and LED cycle to ensure it is functioning properly. This option also allows you to view the state of the LED (on or off).
- *Key Test* identifies each button on the terminal (except the Scan buttons) when each button is pressed.
- *Display Test* tests the pixels on the screen.
- *Memory Test* demonstrates how to query available memory, calculate memory load (%), and how to write code that properly handles system hibernate messages.
- *Main Menu* returns to the demo's main screen.



## Configure

Tap *Configure* on the Utilities screen to access the Control Panel, where you can specify settings for your terminal.



Figure B-10. Control Panel Screen

## About

Tap *About* on the Control Panel to view the version of the Control Panel.

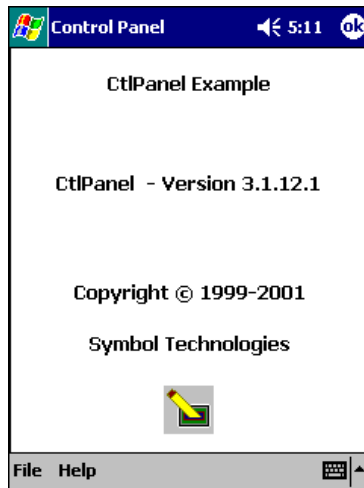
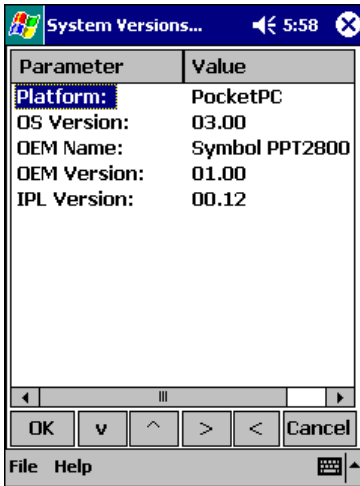


Figure B-11. About Screen

## System Versions

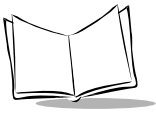
Tap *System Versions* to view version information for the applications on your terminal.



**Figure B-12. System Versions Screen**

On the System Versions screen:

- *Platform* indicates the operating system running on the terminal (Pocket PC).
- *OS Version* specifies the version of the operating system.
- *OEM Name* is the OEM name of the terminal.
- *OEM Version* indicates the build version of the operating system.
- *IPL Version* identifies the build version of the system loader.



## Unique Unit ID

Tap *Unique Unit ID* on the Control Panel to view the terminal's unique unit ID (a 16-byte hex number identifier), and the version numbers for RCM (Resource Coordinator Manager) API, Rescoord (Resource Coordinator) DLL, UUID DLL, and Temperature DLL.

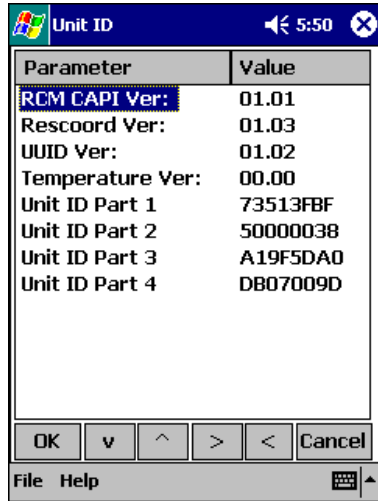


Figure B-13. Unique Unit ID Screen

---

**Note:** PDT 8000 terminals do not support the Temperature DLL.

---

## Persist

Persist allows changes made by the Control Panel to remain in effect after a hard reset. When enabled, Persist creates .reg files which save specific settings that are made and restore the settings to the registry after a hard reset.

Toggle *Persist* to Yes to retain these changes made after a hard reset.

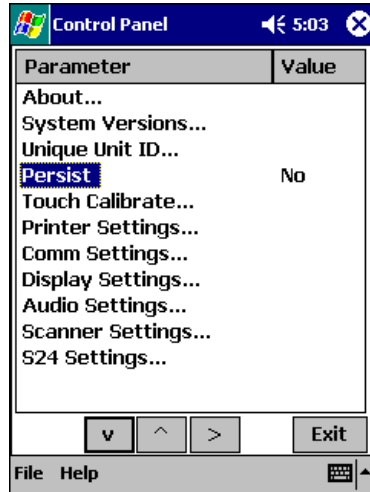


Figure B-14. Persist

---

**Note:** *Not all options support Permanent Persistence.*

---

### ***Touch Calibrate***

Select *Touch Calibrate* to re-align the screen.

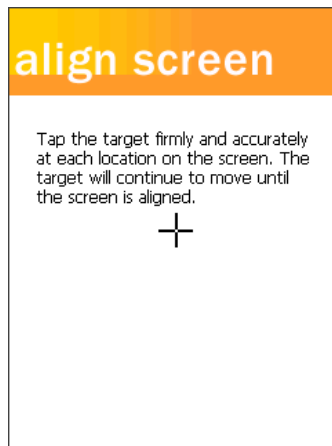
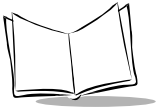


Figure B-15. Align Screen



## Printer Settings

Select *Printer Settings* on the Control Panel to select the printer you'll use with the terminal, and specify printer settings.

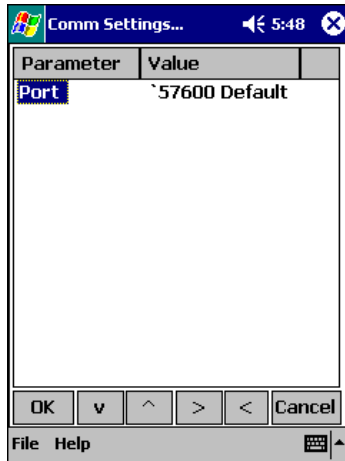


Figure B-16. Printer Settings Screen

- *Selected Printer* allows you to select the printer to use. To change the printer, tap the *Selected Printer* field to scroll through the available printers.
- *Printer Parameter* allows you to set the communication parameter associated with the selected printer. To change this setting, tap the *Printer Parameter* field, then select the communication parameter for your printer.
- *Version Info* displays the Printer API version number.

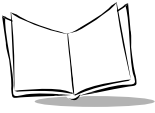
## Communication Settings

Select *Comm Settings* on the Control Panel to specify the settings to use when communicating with other devices.



**Figure B-17. Communication Settings Screen**

Tap *Port* to select the appropriate communication settings to be used by ActiveSync. Scroll through the communication settings to select the appropriate value.



## Display Settings

Select *Display Settings* on the Control Panel to customize the display contrast and backlight.

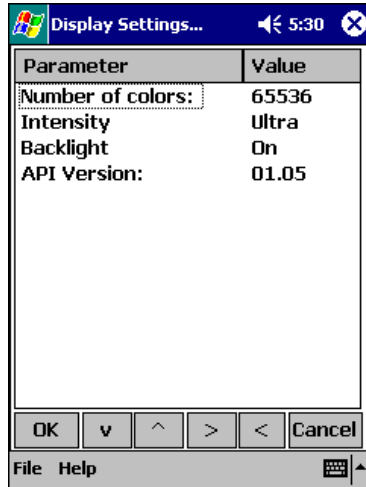


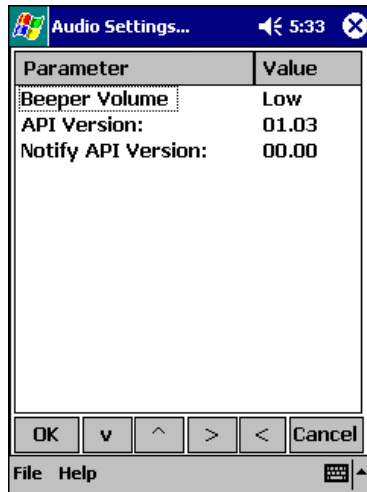
Figure B-18. Display Settings Screen

- Tap *Intensity* to increment the intensity value. The terminal's display changes along with the value.
- Tap *Backlight* to toggle the backlight on or off.
- *API Version* displays the current version of the Display API.



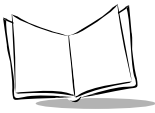
## Audio Settings

Select *Audio Settings* on the Control Panel to specify the beeper volume and view the version numbers for the Audio and Notify APIs.



**Figure B-19. Audio Settings Screen**

- Tap *Beeper Volume* to toggle the beeper volume between low, medium, and high. As you change the value, the beeper sounds to demonstrate the level.
- *API Version* displays the version number of the Audio API.
- *Notify API Version* displays the version number of the Notify API.



## Scanner Settings

Select *Scanner Settings* on the Control Panel to specify scanner-related parameters.

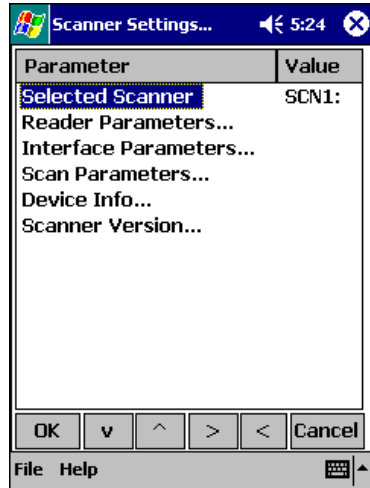


Figure B-20. Scanner Settings Screen

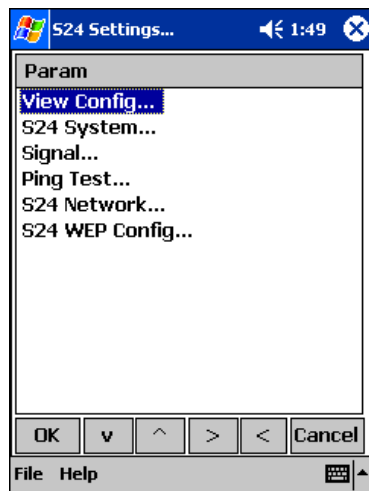
- *Selected Scanner* displays the value of the selected scanner.
- Tap *Reader Parameters* to view and modify the values of various reader parameters.
- Tap *Interface Parameters* to view and modify the values of the following interface parameters:
  - Interface Type
  - Enable Settle Time
  - Inverse Label
  - White Level
  - Clock Resolution
  - Power Settle Time
- Tap *Scan Parameters* to view and modify the values of various scanner parameters.
- Tap *Device Info* to see the values of the following parameters:
  - Beam Width
  - Aim Mode

- Scan Direction
- Feedback
- Supported Fmts
- Max Image Rect
- Tap *Scanner Version* to view the version numbers for the hardware, decoder, PPD, MDD, and API.

Refer to the Help file on the SDK for details on the available parameter options.

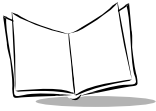
### **S24 Settings**

Select *S24 Settings* on the Control Panel to specify S24-related parameters.



**Figure B-21. S24 Settings Screen**

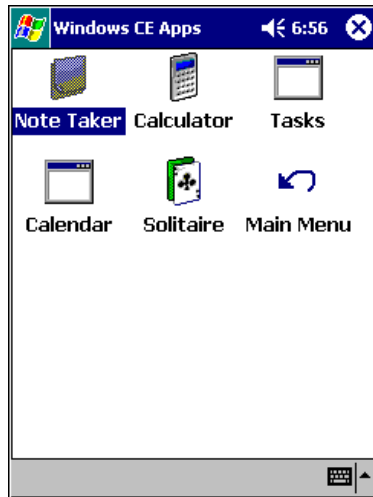
- Tap *View Config* to view the current S24 settings.
- Tap *S24 System* to view and modify the system parameters.
- Tap *Signal* to view the signal strength in your current location.
- Tap *Ping Test* to view and modify settings for a ping test and perform a ping test.
- Tap *S24 Network* to view and modify the network parameters.
- Tap *S24 WEP Config* to view and modify the WEP configuration.



## ***CE Apps***

Tap *CE Apps* on the main menu to access the following standard Windows CE applications:

- Note Taker
- Calculator
- Tasks
- Calendar
- Solitaire.



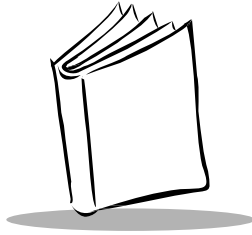
**Figure B-22. CE Apps Screen**

## ***About***

Select the *About* button on the demo's main screen to view information about the demo program.

## ***Exit***

Select the *Exit* button to exit the PDT 8000 Demo application.



## Appendix C

# GSM Demo Program

### Introduction

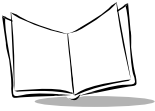
---

GSM Demo allows you to explore what features GSM and the PDT 8037/8056 terminal offer you, including making and receiving phone calls, sending and receiving SMS messages and setting up GPRS parameters.

### GSM Demo Installation

---

1. Download GSM Demo Application to your host computer from <http://devzone.symbol.com>.
2. Establish an ActiveSync connection between the host computer and the terminal. Depending on the accessory used for the connection, see the appropriate section in [Chapter 4, Communications](#).
3. Copy the GSM Demo executable file, downloaded in step 1, to the application directory on your terminal.
  - a. In ActiveSync on the host computer, click *Explore*. Windows Explorer opens the Mobile Device window for your device.
  - b. Open another Windows Explorer window and browse to the GSM Demo executable file download in step 1.
  - c. Right-click the file and click *Copy*. Place the cursor in the Application folder on your Mobile Device window (step 3a), right-click, and click *Paste*.



## GSM Demo Screens

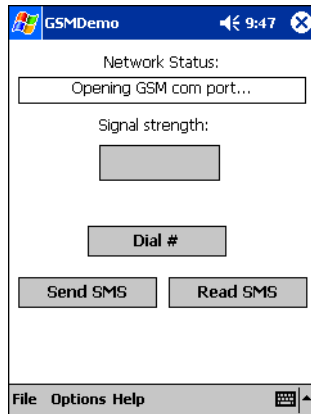
---

To start GSM Demo:

1. Tap *Start - Programs - File Explorer* on your terminal.
2. Navigate to the *Applications* folder, and select *GSM Demo*.

### Main Screen

When GSM Demo opens, it opens the internal serial port to the GSM modem and attempts to register with a network. The following screen displays:



**Figure C-1. GSM Demo Main Screen**

---

**Note:** *If the PIN is enabled on the SIM, the Enter PIN screen appears, and the demo will not register until you enter the PIN. See [Enter Pin Address](#) on page C-7 for details.*

---

#### Network Status

The *Network Status* field displays the following messages as the modem attempts to connect: *Opening GSM COM Port*, *Checking SIM Card*, *Configuring Modem*, *Searching*, then *Registered Home* if the search is successful (*Registered Roam* if out of network).

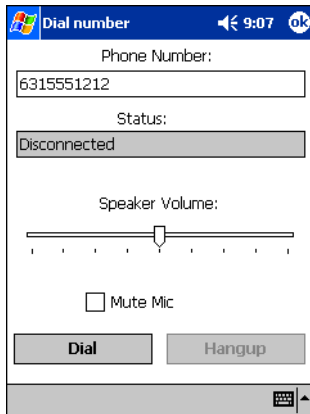
#### Signal strength

Displays signal strength.

- Dial #** Sets dial properties and places call (see [Dial # Screen](#) on page C-3).
- Send SMS** Launches the *Send SMS* screen so you can send a message to another terminal or modem (see [Send SMS Screen](#) on page C-4).
- Read SMS** Displays a message from another terminal or modem (see [Read SMS Screen](#) on page C-4).

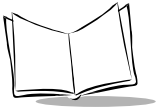
## Dial # Screen

The Dial # feature controls the dial properties of the modem. Select `Dial #` on the main menu:



**Figure C-2. Dial Screen**

- Phone Number** Phone number to dial.
- Status** Indicates if modem is connected to the specified number.
- Speaker Volume** Slide bar controls volume of speaker.
- Mute Mic** Turns microphone off.
- Dial** Dials the number specified.
- Hangup** Disconnects the session.



## Send SMS Screen

To send an SMS message:

1. Tap **Send SMS** on the main screen.



**Figure C-3. Send SMS Screen**

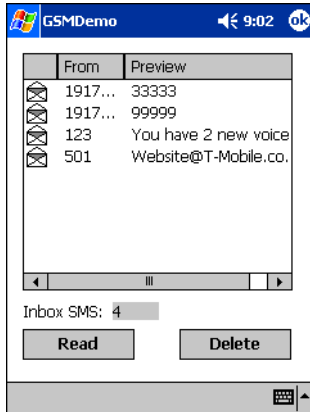
2. Enter the phone number of the message recipient and the message.
3. Tap **Send** to send the message. A successful message screen displays.

## Read SMS Screen

To read your SMS messages:

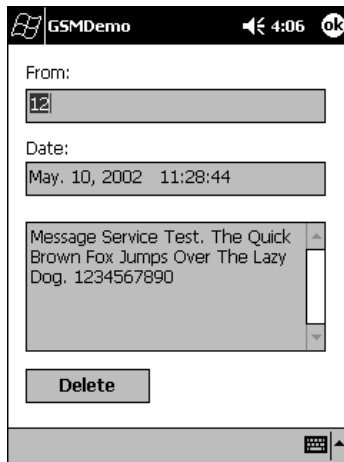


1. Tap **Read SMS** on the main screen. The following screen displays, listing the messages available for viewing:



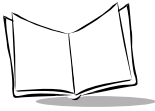
**Figure C-4. SMS Inbox Screen**

2. Tap a message you'd like to read, then tap **Read** to open the message.



**Figure C-5. Read SMS Screen**

3. Tap **Delete** to delete the message and return to the Read SMS screen.



## GSM Demo Menu Commands

---

This section explains the menu commands specific to GSM Demo, accessed from the bottom of the screen.

### ***File Menu***

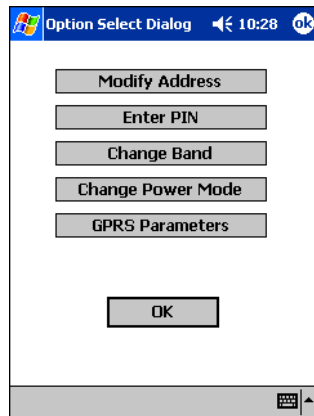
Use the *File* menu to exit the GSM Demo application. Tap *File - Exit*.

Note that tapping **X** in the top corner of the main screen causes the demo application to run in the background, and does not shut off the modem or close the application.

### ***Options Menu***

#### **Settings Screen**

Tap *Options - Settings* to view or change the status of the SIM card.



**Figure C-6. Settings Screen**

#### **Modify Address Screen**

Tap *Modify Address* if you need to change the service center phone number if the number is missing, its phone number has changed, or you wish to choose an alternate service center.

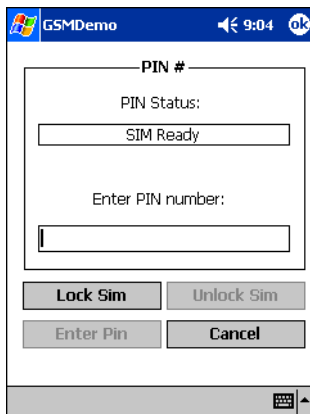
On the *Service center address* screen, enter the new service center number in the *New address* field and tap *Enter Address*.



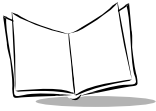
**Figure C-7. Service Center Address Screen**

## Enter Pin Address

Tap *Enter PIN* on the *Settings* screen to enter a new PIN number. Enter the PIN # in the *Enter PIN number:* field and tap *Enter Pin*.

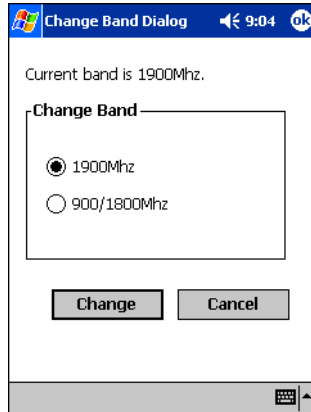


**Figure C-8. PIN # Screen**



## Change Band Screen

Tap **Change Band** on the *Settings* screen to make any changes. Tap **Change** to register the change.



**Figure C-9. Change Band Screen**

---

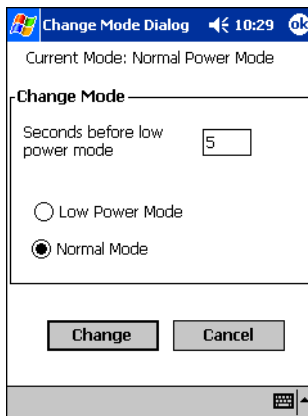
**Note:** *The modem resets (power cycles) when you change the band, indicated in the Network Status screen.*

---

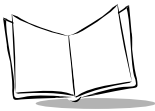
## Change Power Mode Screen

Tap **Change Power Mode** if you want to enable the low power mode on the modem.

On the *Change Mode Dialog* screen, select the desired power mode and tap **Change**. If *Low Power Mode* is selected, enter the desired number of seconds in the *Seconds before low power mode* field.



**Figure C-10. Change Mode Dialog Screen**



## GPRS Parameters Screen

### PDP Context Tab

Figure 3-11. GPRS Parameters - PDP Context Tab

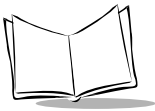
Field Name	Description
<b>Table Version</b>	System generated. Contains internal version number representing the structure of the registry file.
<b>Context ID</b>	Each set of parameters is collectively called a context. User is allowed to store three contexts. Select the number representing the particular set of context.
<b>Context</b>	Each set of parameters is collectively called a context. Enter a name for the context.
<b>PDP Type</b>	Information obtained from service provider. This represents the protocol type.
<b>APN</b>	Information obtained from service provider. This represents the access point name.
<b>PDP Address</b>	Information obtained from service provider. <ul style="list-style-type: none"> <li>If provider supports DHCP, this field is blank.</li> <li>If provider does not support DHCP, obtain address from provider.</li> </ul>
<b>Data Compression</b>	Information obtained from service provider. <ul style="list-style-type: none"> <li>If provider supports data compression, select <i>No</i>.</li> <li>If provider supports data compression, select <i>Yes</i>.</li> </ul>

Field Name	Description
<b>Header Compression</b>	Information obtained from service provider. <ul style="list-style-type: none"> <li>If provider supports header compression, select <i>No</i>.</li> <li>If provider supports header compression, select <i>Yes</i>.</li> </ul>
<b>Current Active Context</b>	Select the number representing the context you want to use for your connection.

### Min. Qos. Tab

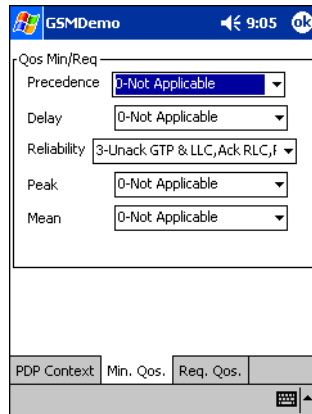
**Figure 3-12. GPRS Parameters - Min. Qos. Tab**

Field Name	Description
<b>Precedence</b>	Information obtained from service provider. A parameter describing the relative priority of maintaining the service.
<b>Delay</b>	Information obtained from service provider. A parameter describing service speed.
<b>Reliability</b>	Information obtained from service provider. A parameter indicates the transmission characteristics that are required by an application. The reliability class defines the probability of loss, duplication, missequencing or corruption of SDU (Service Data Unit).
<b>Peak</b>	Information obtained from service provider. A parameter indicating the peak throughput octet rate per second.



Field Name	Description
<b>Mean</b>	Information obtained from service provider. A parameter indicating the mean throughput octet rate per minute.

**Req. Qos. Tab**



**Figure 3-13. GPRS Parameters - Req. Qos. Tab**

Field Name	Description
<b>Precedence</b>	Information obtained from service provider. A parameter describing the relative priority of maintaining the service.
<b>Delay</b>	Information obtained from service provider. A parameter describing service speed.
<b>Reliability</b>	Information obtained from service provider. A parameter indicates the transmission characteristics that are required by an application. The reliability class defines the probability of loss, duplication, missequencing or corruption of SDU (Service Data Unit).
<b>Peak</b>	Information obtained from service provider. A parameter indicating the peak throughput octet rate per second.
<b>Mean</b>	Information obtained from service provider. A parameter indicating the mean throughput octet rate per minute.



## Help Menu

The *Help* menu provides information about your GSM modem.

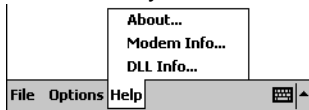


Figure C-14. GSM Demo Help Menu

## About Screen

Select *About* on the *Help* menu for version information regarding the GSM Demo.

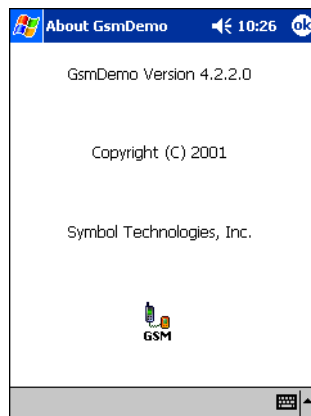
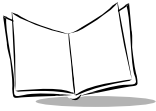


Figure C-15. GSM Demo About Screen



## Modem Info Screen

Select *Modem Info* on the *Help* menu for specific modem information.

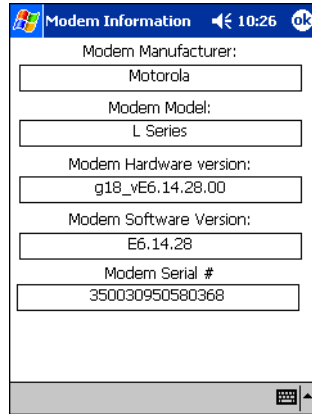


Figure C-16. GSM Demo Modem Info Screen

## DLL Info

Select *DLL Info* on the *Help* menu for specific DLL information.

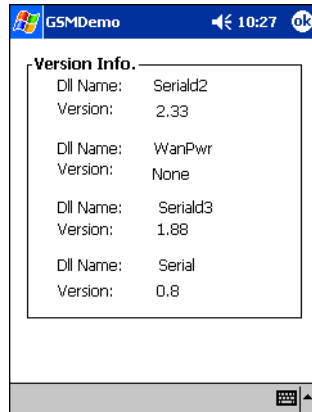
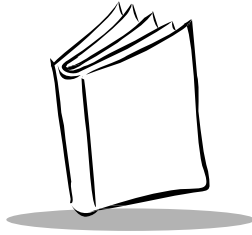


Figure C-17. GSM Demo DLL Info Screen



# *Appendix D*

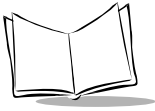
## *Technical Specifications*

### **Environment**

---

The following table summarizes the terminal's intended operating environment.

	<b>PDT 8000, 8046</b>	<b>PDT 8037</b>	<b>PDT 8056</b>
<b>Operating Temperature</b>	-10° C to 50° C (14° F to 122° F)		
<b>Storage Temperature</b>	-25° C to 70° C (-13° F to 158° F)		
<b>Charging Temperature</b>	0° C to 40° C (32° F to 104° F)		
<b>Humidity</b>	5% to 95% non-condensing		
<b>Electrostatic Discharge (ESD)</b>	15 kVdc air; 8 kVdc contact		
<b>Drop to Concrete (at room temperature)</b>	1.5 meters (5 feet)		
<b>Sealing</b>	IP54 (dust category 2)		
<b>Size</b>	184mm x 91mm x 50mm (7.26"L x 3.57"W x 1.97"H)	184mm x 91mm x 55mm (7.25"L x 3.60"W x 2.15"H)	203mm x 101mm x 59mm (7.98"L x 3.96"W x 2.32"H)
<b>Weight (including battery)</b>	595.0gm (21.0 oz)	601.4gm (21.2 oz)	670.6gmm (23.7 oz)



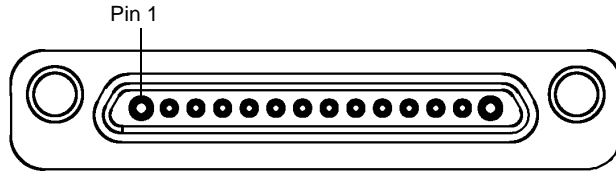
## COM Port Definitions

---

COM Port	Definition
COM1	Serial Cable
COM2	PCMCIA/CF Serial
COM3	IRCOMM
COM4	IRDA
COM5	Reserved (64MB RAM configuration) USB Cable (128MB RAM configuration)
COM6	Reserved
COM7	Powered Serial Cable
COM8	Reserved
COM9	Reserved

## Pin-Outs

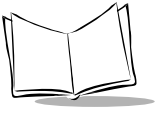
The ActiveSync Port shown below represents the port on the bottom of the terminal.



**Figure D-1. ActiveSync Port (COM1)**

**Table D-1. ActiveSync Port (COM1) Pin-Outs**

Pin	Description
1	GND
2	+5V DC
3	DSR
4	RXD
5	RTS
6	TXD
7	CTS
8	DCD
9	RI
10	DTR
11	NC (64MB RAM configuration) VBUS (128MB RAM configuration)
12	NC (64MB RAM configuration) D+ (128MB RAM configuration)
13	NC (64MB RAM configuration) D- (128MB RAM configuration)
14	VCHG



*PDT 8000 Series Product Reference Guide*



# Appendix E

## Keyboard Maps

### Introduction

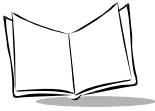
---

This appendix contains the keyboard map for the keyboard configuration of the terminal. Each key is listed in the table with its value, depending on the state of the keyboard.

As shown below, when the **1** key is pressed on the keyboard, the default state displays the number '1'. After pressing the Shift key, the press of the '1' key acts as a Clear button.

Key	Default State	Shift State	VK Code (Decimal)	ASCII Value (Decimal)
<b>1</b>	1		49	49
		Clear	46	

In addition to key values, VK codes and ASCII values are listed for each key, where applicable.



# Keyboard

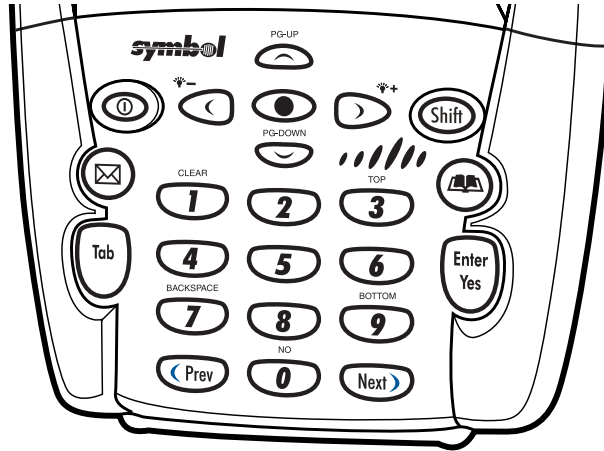











Figure E-1. Terminal Keyboard

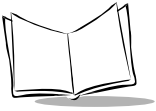
Table E-1. Keyboard Functionality

Key	Default State	Shift State	VK Code (Decimal)	ASCII Value (Decimal)
	Up arrow		38	
		Page up	33	
	Power			
	Left Arrow		37	



**Table E-1. Keyboard Functionality (Continued)**







Key	Default State	Shift State	VK Code (Decimal)	ASCII Value (Decimal)
		Decrease Backlight		
	App Key 1		App 1	
		VK_F13	124	
	Right Arrow		39	
		Increase Backlight		
	To Shift			
	Down Arrow		40	
		Page down	34	
	App Key 2		App2	
		toggle backlight		
	App Key 3		App3	

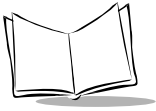


**Table E-1. Keyboard Functionality (Continued)**



Key	Default State	Shift State	VK Code (Decimal)	ASCII Value (Decimal)
		toggle backlight		
<b>1</b>	1		49	49
		Clear	46	
<b>2</b>	2		50	50
		Calibration Screen		
<b>3</b>	3		51	51
		Top	36	
<b>4</b>	4		52	52
		VK_F4	115	
<b>5</b>	5		53	53
		VK_F5	116	
<b>6</b>	6		54	54

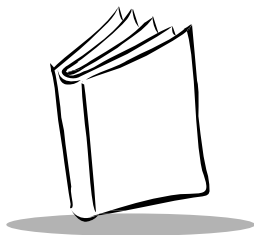
**Table E-1. Keyboard Functionality (Continued)**

Key	Default State	Shift State	VK Code (Decimal)	ASCII Value (Decimal)
		VK_F6	117	
	7		55	55
		Backspace	08	08
	8		56	56
		VK_F8	119	
	9		57	57
		Bottom	35	
	VK_F14		125	
		VK_F11	122	
	0		48	48
		No	27	27
	VK_F15		126	
		VK_F12	123	



**Table E-1. Keyboard Functionality (Continued)**

Key	Default State	Shift State	VK Code (Decimal)	ASCII Value (Decimal)
	Tab		09	09
		VK_F10	121	
	Enter		13	13



# Index

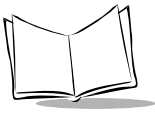
## Numerics

11 Mbps	
APs	9-16
encryption	9-12
info	9-8
IP config	9-9
mode	9-7
options	9-11
ping	9-14
power	9-10
signal	9-15
128-bit shared key	4-40
40-bit shared key	4-40

## A

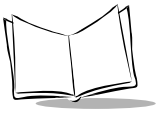
AC Wall Adapter	1-6
accessories	1-6
AC Wall Adapter	1-6
additional battery	1-6
cables	1-6
charging cradle	1-7
holster	1-7
magnetic stripe reader	1-6
modem cradle	1-6
SDK	1-7
serial charging cable	1-6
serial cradle	1-6
snap-on Autocharger	1-6
snap-on DEX cable	1-6
snap-on modem	1-6
snap-on printer cable	1-6
stylus	1-6
UBC adapter	1-7

USB cable	1-6
USB-to-ethernet cradle	1-7
vehicle cradle	1-7
ActiveSync	
adding programs to Start menu	3-10
using magnetic stripe reader	4-36
using modem cradle	4-18
using serial cable	4-11
using serial cradle	4-15
using USB cable	4-13
using USB-to-ethernet cradle	4-25
using vehicle cradle	4-34
adding programs	3-8
to Start menu	3-9
additional programs	B-1
adjusting terminal settings	3-3
AirBEAM	8-1
Client	8-4
Configuring	8-4
Package Builder	8-3
Staging	8-12
Synchronization with Server	8-10
AirBEAM configuration	
Misc(1) tab	8-7
Misc(2) tab	8-9
Packages(1) tab	8-5
Packages(2) tab	8-5
Server tab	8-6
aligning screen	1-31, B-15
applications	
button assignment	3-7
calendar	5-3
meeting requests	5-5
summary screen	5-5



contacts	5-6	performing ActiveSync	4-11, 4-13
summary screen	5-8	pinouts	D-3
GSM Demo	C-1	cables	1-6
GSMDemo		AC Wall Adapter	1-6
file menu	C-6	serial charging cable	1-6
help menu	C-13	snap-on Autocharger	1-6
main screen	C-2	snap-on DEX cable	1-6
menu commands	C-6	snap-on printer cable	1-6
options menu	C-6	USB cable	1-6
screens	C-2	calendar application	5-3
settings	C-6	creating appointments	5-4
inbox	5-14	meeting requests	5-5
connecting to e-mail server	5-14	summary screen	5-5
creating messages	5-18	calibrating screen	B-15
managing	5-19	CE applications	B-22
message list	5-16	channels	7-5
synchronizing e-mail	5-14	chapter descriptions	xiii
notes	5-12	Charge LED Indicator	1-22
tasks	5-9	charging batteries	1-9
summary screen	5-11	charging cradle	1-7
appointments	5-4	charging spare batteries	1-18
attaching handstrap	1-29	Chart	A-2
audio sample	B-8	cleaning terminal	13-3
audio settings	B-19	command bar	2-8
AvantGo channels	7-5	icons	2-9
<b>B</b>		communication	
batteries		LED indicator	4-33
charging	1-9	magnetic stripe reader	4-36
checking power	1-35	serial charging cable	4-11
installing	1-8	single-slot modem cradle	4-18
Beam Data	13-7	single-slot serial cradle	4-15
block recognizer	2-14	USB cable	4-13
booting		USB-to-ethernet cradle	4-25
hard	2-35	vehicle cradle	4-34
soft	2-34	Communication LED Indicator	4-33
buttons		communication software	4-3
assigning applications	3-7	compact flash card	
keyboard	2-5	inserting	1-24
power	1-31, 2-3	removing	1-25
<b>C</b>		companion programs	
cable		Infrared Receive	6-16
		Media Player	6-13
		Microsoft Reader	6-13
		MSN Messenger	6-9

- Pocket Excel ..... 6-8
  - Pocket Word ..... 6-3
  - configuration
    - S24 Wireless LAN ..... 9-4
  - connecting
    - to development PC ..... 12-12
  - contacting Symbol ..... xvi
  - contacts application ..... 5-6
    - summary screen ..... 5-8
  - cradle
    - inserting terminal ..... 4-17, 4-35
    - performing ActiveSync 4-15, 4-18, 4-25, 4-34
  - cradles
    - charging cradle ..... 1-7
    - modem cradle ..... 1-6
    - serial cradle ..... 1-6
    - USB-to-ethernet cradle ..... 1-7
    - vehicle cradle ..... 1-7
  - creating messages ..... 5-18
  - creating splash screen ..... 12-23
- D**
- demo program
    - about ..... B-22
    - ActiveX ..... B-5
    - audio ..... B-8
    - audio settings ..... B-19
    - CE applications ..... B-22
    - display ..... B-18
    - file explorer ..... B-9
    - GSM ..... C-1
    - HTML scan ..... B-6
    - images ..... B-9
    - ImageViewer ..... B-9
    - printer ..... B-16
    - Scan Wedge ..... B-6
    - ScanBrowse ..... B-6, B-7
    - scanner ..... B-4
    - scanner settings ..... B-20, B-21
    - sounds ..... B-8
    - utilities ..... B-11
  - DHCP ..... 4-40
  - display settings ..... B-18
  - drawing on screen ..... 2-20
- E**
- e-mail connection
    - creating messages ..... 5-18
    - inbox ..... 5-14
  - encryption ..... 4-40
    - 128-bit shared key ..... 4-40
    - 40-bit shared key ..... 4-40
    - kerberos ..... 4-40
    - open system ..... 4-40
  - entering characters ..... 2-14, 2-15
  - entering information ..... 2-12
    - drawing on screen ..... 2-20
    - recording message ..... 2-21
    - scanning ..... 2-21
    - writing on screen ..... 2-16
  - entering text ..... 2-12
  - error messages ..... 12-21, 12-23
  - ethernet
    - internet connection ..... 4-32
  - Excel
    - pocket ..... 6-8
- F**
- favorite links ..... 7-4
  - file explorer ..... 2-22, B-9
  - finding information ..... 2-22
  - flash card ..... 1-24
  - flash file system ..... 3-4
    - non-FFS partitions ..... 3-6
      - IPL ..... 3-6
      - splash screen ..... 3-6
    - partitions ..... 3-4
      - copyfile ..... 3-6
      - regmerge ..... 3-5
  - flash storage ..... 3-4
- G**
- GPRS
    - connecting ..... 10-18



- parameter configuration ..... 10-3
- WAN connection configuration .... 10-15
- GPRS parameters
  - edit ..... 10-6
  - Min. Qos. .... 10-8
  - PDP context ..... 10-7
  - registry file ..... 10-11
  - Req. Qos. .... 10-10
- GSM
  - connecting ..... 10-27
  - WAN connection configuration .... 10-23
- GSM Demo ..... C-1
- GSMDemo
  - file menu ..... C-6
  - help menu ..... C-13
  - install ..... 10-21
  - main screen ..... C-2
  - menu commands ..... C-6
  - options menu ..... C-6
  - screens ..... C-2
  - settings ..... C-6
  - SMS messages ..... 2-29

## H

- handstrap
  - attaching ..... 1-29
  - removing ..... 1-29
  - replacing ..... 1-30
- headset ..... 2-4
- holster ..... 1-7

## I

- icons
  - status ..... 2-9
- images
  - demo ..... B-9
- ImageViewer ..... B-9
- inbox application ..... 5-14, 5-18
  - connecting to e-mail server ..... 5-14
  - managing ..... 5-19
  - message list ..... 5-16
  - synchronizing e-mail ..... 5-14
- Infrared port ..... 13-7

- Infrared Receive ..... 6-16
- Initial Program Loader ..... 3-6, 12-12
- input panel ..... 2-12
  - block recognizer ..... 2-14
  - letter recognizer ..... 2-15
  - transcriber ..... 2-15
- install
  - communication software ..... 4-3
- installing compact flash card ..... 1-24
- installing MMC/SD card ..... 1-26
- installing SIM card ..... 1-24
- internet connection
  - via ethernet ..... 4-32
  - via GPRS ..... 10-18
  - via GSM ..... 10-27
  - via modem ..... 4-22
  - wireless ..... 4-39
- IP ..... 4-40
- IPL ..... 3-6, 12-12
  - error messages ..... 12-21
  - setup ..... 12-12, 12-16

## K

- kerberos ..... 4-40

## L

- letter recognizer ..... 2-15
- loading applications ..... 12-12
- loading software ..... 12-12
- loading splash screen ..... 12-24

## M

- magnetic stripe reader ..... 1-6
- maintenance ..... 13-3
- Media Player ..... 6-13
- Microsoft Reader ..... 6-13
- MMC/SD card ..... 1-26
  - inserting ..... 1-26
- mobile channels ..... 7-5
- mobile favorites ..... 7-4, 7-7
  - creating ..... 7-4
- modem



internet connection ..... 4-22  
 modem cradle ..... 1-6  
 MSN Messenger ..... 6-9

## N

navigation bar ..... 2-8  
 network  
   configuring GPRS WAN ..... 10-15  
   configuring GSM WAN ..... 10-23  
 network adapter  
   properties ..... 9-4  
 NICTT  
   APs ..... 9-16  
   encryption ..... 9-12  
   info ..... 9-8  
   IP config ..... 9-9  
   mode ..... 9-7  
   options ..... 9-11  
   ping ..... 9-14  
   power ..... 9-10  
 notational conventions ..... xv  
 notes application ..... 5-12

## O

open system ..... 4-40  
 operating environment ..... D-1

## P

partitions  
   FFS ..... 3-4  
   non-FFS ..... 3-6  
   IPL ..... 3-6  
   splash screen ..... 3-6  
 parts of the terminal ..... 1-4  
 phone call  
   making ..... 2-27  
   receiving ..... 2-28  
 pin-outs ..... D-3  
 Pocket Excel ..... 6-8  
 Pocket Internet Explorer  
   browsing web ..... 7-3  
   channels ..... 7-5

favorite links ..... 7-4  
 mobile favorites ..... 7-4, 7-7  
   using ..... 7-6

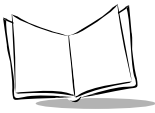
Pocket Word ..... 6-3  
 pop-up menus ..... 2-11  
 power button ..... 1-31, 2-3  
 printer settings ..... B-16  
 Programs ..... B-1  
 programs  
   adding ..... 3-8  
   adding to Start menu ..... 3-9  
   button assignment ..... 3-7  
   flash file system ..... 3-4  
   removing ..... 3-10  
   selecting ..... 2-10

## R

Reader  
   Microsoft ..... 6-13  
 recording ..... 2-21  
 removing handstrap ..... 1-29  
 removing programs ..... 3-10  
 replacing handstrap ..... 1-30  
 resetting ..... 2-34  
   hard reset ..... 2-35  
   soft reset ..... 2-34

## S

scanner  
   settings ..... B-20, B-21  
 scanning ..... 2-21, 2-33  
   LED indicators ..... 2-34  
 scripts  
   building ..... 12-10  
   checking ..... 12-10  
   creating ..... 12-8  
   demos/samples ..... 12-3  
   opening in TCM ..... 12-8  
   saving ..... 12-9  
 SDK ..... xvi, 1-7  
   installing ..... 11-4  
   installing on development PC ..... 11-4  
   system requirements ..... 11-3



- selecting a drawing . . . . . 2-20
- selecting programs . . . . . 2-10
- selecting text . . . . . 2-19
- selecting writing . . . . . 2-19
- serial charging cable . . . . . 1-6
- serial cradle . . . . . 1-6
- service information . . . . . xvi
- setting date . . . . . 1-33
- setting time . . . . . 1-33
- setting time zone . . . . . 1-33
- settings
  - adjusting . . . . . 3-3
- SIM card
  - installing SIM card . . . . . 1-24
- SMS messages . . . . . 2-29
  - reading . . . . . 2-33
  - receiving . . . . . 2-32
  - sending . . . . . 2-32
- snap-on Autocharger . . . . . 1-6
- snap-on DEX cable . . . . . 1-6
- snap-on modem . . . . . 1-6
- snap-on printer cable . . . . . 1-6
- sound
  - settings . . . . . B-19
- sounds demo . . . . . B-8
- spare batteries
  - charging . . . . . 1-18
- specifications . . . . . D-1
- Spectrum24
  - APs . . . . . 9-16
  - encryption . . . . . 9-12
  - info . . . . . 9-8
  - IP config . . . . . 9-9
  - mode . . . . . 9-7
  - options . . . . . 9-11
  - ping . . . . . 9-14
  - power . . . . . 9-10
  - signal . . . . . 9-15
- Spectrum24 settings . . . . . 9-6
  - advanced . . . . . 9-6
- splash screen . . . . . 3-6
  - creating . . . . . 12-23
  - loading . . . . . 12-24
- standard . . . . . 12-3

- Start menu
  - adding programs . . . . . 3-9
  - selecting programs . . . . . 2-10
- starting the terminal . . . . . 1-31
- static . . . . . 4-40
- status icons . . . . . 2-9
- stylus . . . . . 2-3
- Symbol Software Developer's Kit . . . . . 1-7
- symbol support center . . . . . xvi

## T

- tasks application . . . . . 5-9
  - summary screen . . . . . 5-11

## TCM

- building hex image . . . . . 12-3, 12-10, 12-11
- components . . . . . 12-5
- creating script . . . . . 12-8
- defining properties . . . . . 12-6
- error messages . . . . . 12-23
- file browser window . . . . . 12-5
- hex image download . . . . . 12-12
- loading splash screen . . . . . 12-24
- saving script . . . . . 12-9
- script window . . . . . 12-5
- starting . . . . . 12-4
- tool bar . . . . . 12-5

## terminal

- accessories . . . . . 1-6
- keyboard . . . . . 2-5
- parts . . . . . 1-4
- resetting . . . . . 2-34
- unpacking . . . . . 1-3

- Today screen . . . . . 2-7

## tools and utilities

- Spectrum24 settings . . . . . 9-6

- transcriber . . . . . 2-15

## Troubleshooting

- infrared communications . . . . . 13-7
- troubleshooting . . . . . 13-4

## U

- UBC adapter . . . . . 1-7
- unpacking . . . . . 1-3

USB cable ..... 1-6  
USB-to-ethernet cradle ..... 1-7  
using headset ..... 2-4  
using stylus ..... 2-3  
utilities ..... B-11

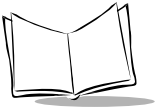
**V**

vehicle cradle ..... 1-7

**W**

wakeup sources ..... 1-34

web browser ..... 7-3  
wireless  
    internet connection ..... 4-39  
Word  
    pocket ..... 6-3  
writing on screen ..... 2-15, 2-16  
WWAN  
    configuring ..... 10-1  
    configuring GPRS ..... 10-15  
    configuring GSM ..... 10-23



*PDT 8000 Series Product Reference Guide*

# ***Tell Us What You Think...***

We'd like to know what you think about this Manual. Please take a moment to fill out this questionnaire and fax this form to: (631) 738-3318, or mail to:

Symbol Technologies, Inc.  
One Symbol Plaza M/S B-4  
Holtsville, NY 11742-1300  
Attention: Technical Publications Manager

**IMPORTANT:** If you need product support, please call the appropriate customer support number provided. Unfortunately, we cannot provide customer support at the fax number above.

User's Manual Title: \_\_\_\_\_  
(please include revision level)

How familiar were you with this product before using this manual?

Very familiar     Slightly familiar     Not at all familiar

Did this manual meet your needs? If not, please explain.

\_\_\_\_\_

\_\_\_\_\_

What topics need to be added to the index, if applicable?

\_\_\_\_\_

\_\_\_\_\_

What topics do you feel need to be better discussed? Please be specific.

\_\_\_\_\_

\_\_\_\_\_

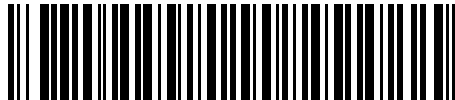
What can we do to further improve our manuals?

\_\_\_\_\_

\_\_\_\_\_







**72-58169-05**  
**Revision A — September 2003**

*Symbol Technologies, Inc. One Symbol Plaza, Holtsville N.Y. 11742-1300*  
<http://www.symbol.com/manuals>