



# PDT 6800 Series



## Product Reference Guide



*PDT 6800 Series  
Product Reference Guide*

70-32645-02

*Revision A*

*August 2001*



© 1998-2001 by Symbol Technologies, Inc. All rights reserved.

No part of this publication may be reproduced or used in any form, or by any electrical or mechanical means, without permission in writing from Symbol. This includes electronic or mechanical means, such as photocopying, recording, or information storage and retrieval systems. The material in this manual is subject to change without notice.

The software is provided strictly on an “as is” basis. All software, including firmware, furnished to the user is on a licensed basis. Symbol grants to the user a non-transferable and non-exclusive license to use each software or firmware program delivered hereunder (licensed program). Except as noted below, such license may not be assigned, sublicensed, or otherwise transferred by the user without prior written consent of Symbol. No right to copy a licensed program in whole or in part is granted, except as permitted under copyright law. The user shall not modify, merge, or incorporate any form or portion of a licensed program with other program material, create a derivative work from a licensed program, or use a licensed program in a network without written permission from Symbol. The user agrees to maintain Symbol’s copyright notice on the licensed programs delivered hereunder, and to include the same on any authorized copies it makes, in whole or in part. The user agrees not to decompile, disassemble, decode, or reverse engineer any licensed program delivered to the user or any portion thereof.

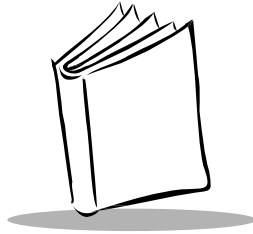
Symbol reserves the right to make changes to any software or product to improve reliability, function, or design.

Symbol does not assume any product liability arising out of, or in connection with, the application or use of any product, circuit, or application described herein.

No license is granted, either expressly or by implication, estoppel, or otherwise under any Symbol Technologies, Inc., intellectual property rights. An implied license only exists for equipment, circuits, and subsystems contained in Symbol products.

Symbol, Spectrum One, and Spectrum24 are registered trademarks of Symbol Technologies, Inc. Other product names mentioned in this manual may be trademarks or registered trademarks of their respective companies and are hereby acknowledged.

Symbol Technologies, Inc.  
One Symbol Plaza  
Holtsville, New York 11742-1300  
<http://www.symbol.com>



# Contents

## About This Guide

Chapter Descriptions .....	ix
Notational Conventions .....	x
Related Publications .....	x
Service Information .....	xi
Symbol Support Center .....	xii
Warranty .....	xiv
Warranty Coverage and Procedure .....	xv
General .....	xv

## Chapter 1. Getting Started

Introduction .....	1-1
Parts of the PDT 6800 Series Terminal .....	1-2
Accessories .....	1-3
Battery Chargers .....	1-3
Printer Interface Module .....	1-3
Radio and Network Options .....	1-3
Unpacking .....	1-4
Before You Use the Terminal .....	1-4
Install and Charge Battery .....	1-4
Load the Appropriate Software .....	1-4

## Chapter 2. Accessories Setup

Introduction .....	2-1
Required Parts .....	2-2
Parts of the CRD 38/6865 .....	2-3
Parts of the CRD 38/6866 .....	2-3
Wall Mounting the CRD 38/6865 .....	2-4
Wall Mounting the CRD 38/6866 .....	2-5

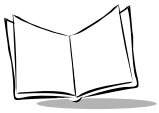


Table Mounting the CRD 38/6866 . . . . .	2-5
Connecting Power . . . . .	2-6
Connecting for Data Communications . . . . .	2-7
Connecting the CRD 38/6865 Internal Modem . . . . .	2-9
Connecting to the Telephone Network . . . . .	2-10
Connecting the CRD 38/6866 to Other Cradles . . . . .	2-10
CCM 38/6860 . . . . .	2-11
Parts of the CCM 38/6860 . . . . .	2-11
Wall Mounting . . . . .	2-12
Coupling CCMs . . . . .	2-12
Connecting Power . . . . .	2-13
Connecting the CCM for Serial Communications . . . . .	2-14
Daisy-Chaining Two or More CCMs . . . . .	2-15
PC Adapter . . . . .	2-16
Parts of the PC Adapter . . . . .	2-16
Connecting the PC Adapter to the Terminal and Serial Device . . . . .	2-17

### **Chapter 3. Batch and Spectrum One Terminal Setup**

Introduction . . . . .	3-1
Hardware Requirements . . . . .	3-1
Communications . . . . .	3-2
Downloading the Program . . . . .	3-2
Initiate Host Communications Software . . . . .	3-3

### **Chapter 4. Spectrum24 RF Terminal Setup**

Spectrum24 Terminals . . . . .	4-1
Accessing the Flash Disk . . . . .	4-1
Standard Spectrum24 Software . . . . .	4-2

### **Chapter 5. Operating the PDT 6800 Series**

Introduction . . . . .	5-1
Powering the Terminal On . . . . .	5-2
Removing Terminal From a Cradle . . . . .	5-2
Keyboard . . . . .	5-2
Real-Time Clock . . . . .	5-2
Laser Trigger . . . . .	5-3
Restoring Power After Automatic Shutdown . . . . .	5-3
Powering the Terminal Off . . . . .	5-3
Forcing Power Off . . . . .	5-3
Restarting After a Forced Power Off . . . . .	5-3
Booting the Terminal . . . . .	5-4

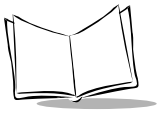
Warm Boot . . . . .	5-4
Cold Boot . . . . .	5-4
Boot to Command Mode. . . . .	5-7
Adjusting the Display . . . . .	5-7
Display Contrast . . . . .	5-7
Backlighting . . . . .	5-7
PDT 6800 Series Keyboard. . . . .	5-8
Using the Keyboard. . . . .	5-9
Scanning . . . . .	5-12
Scanning 1D Bar Codes . . . . .	5-12
Scanning 2D Bar Codes . . . . .	5-13
Scanning Considerations . . . . .	5-14
Running Communications . . . . .	5-16
Communicating With a Host. . . . .	5-16
Communicating With a Printer . . . . .	5-16
Radio Communications. . . . .	5-16

## Chapter 6. Maintaining the Terminal

Batteries . . . . .	6-1
Battery Life . . . . .	6-2
When to Replace or Recharge the Battery . . . . .	6-2
Replacing the Battery Pack . . . . .	6-3
Removing the Battery Pack . . . . .	6-3
Installing the Battery Pack . . . . .	6-4
Battery Charging Tips . . . . .	6-5
Charging the NiCd Battery Pack . . . . .	6-6
Charging the Lithium Ion Battery Pack . . . . .	6-7
Cleaning . . . . .	6-7
Storage . . . . .	6-8

## Chapter 7. Error Recovery and Troubleshooting

Introduction . . . . .	7-1
Error Messages . . . . .	7-2
Troubleshooting . . . . .	7-3
Startup Failure . . . . .	7-3
Boot Failure Messages . . . . .	7-3
Spectrum24 Terminal . . . . .	7-4
Self Test Function . . . . .	7-5
Running Self Test . . . . .	7-5
Self Test Summaries. . . . .	7-6
Keyboard Test. . . . .	7-6
Memory Transfer Program . . . . .	7-8



Hardware Setup .....	7-8
Set Communications Parameters .....	7-9
Internal Modem Problems .....	7-12
Scanning Problems .....	7-12
What If... .....	7-12

## **Appendix A. Null Modem Pin-outs**

Null Modem Pin-Outs for Full Duplex .....	A-1
Null Modem Pin-outs for Half-Duplex .....	A-2

## **Appendix B. Keyboard Layouts**

Introduction .....	B-1
35-Key Keyboard .....	B-2
46-Key Keyboard .....	B-5

## **Appendix C. Communications Status Codes**

Introduction .....	C-1
--------------------	-----

## **Appendix D. Specifications**

Environment .....	D-1
RF Communications .....	D-2
Scanning Decode Zones .....	D-3

## **Appendix E. Boot-Up Quick Reference**

Introduction .....	E-1
--------------------	-----

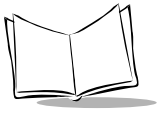
## Appendix F. 2D Scanner Drivers and Applications

Introduction .....	F-1
Using Scn2dssi.exe .....	F-1
Usage .....	F-1
Output Messages .....	F-2
Application Development .....	F-2
New APIs .....	F-3
Using Bldscan.exe .....	F-5
Screen Menus .....	F-6

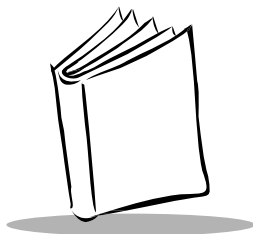
## Index

## Feedback





*PDT 6800 Series Product Reference Guide*



## About This Guide

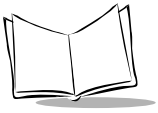
The *PDT 6800 Series Product Reference Guide* provides general instructions for setup, initializing, operating, troubleshooting, and maintaining the PDT 6800 Series terminal.

### Chapter Descriptions

---

Following are brief descriptions of each chapter in this guide.

- ◆ [Chapter 1, \*Getting Started\*](#) provides a product overview and information on terminal parts, operation, accessories, batteries, and loading software.
- ◆ [Chapter 2, \*Accessories Setup\*](#) general information on the CCM 38/6860, CRD 38/6865, CRD 38/6866, and PC adapter.
- ◆ [Chapter 3, \*Batch and Spectrum One Terminal Setup\*](#) provides information on batch and Spectrum One hardware requirements and loading programs.
- ◆ [Chapter 4, \*Spectrum24 RF Terminal Setup\*](#) provides general information on Spectrum24 software, initialization, and options.
- ◆ [Chapter 5, \*Operating the PDT 6800 Series\*](#) describes how to use the terminal.
- ◆ [Chapter 6, \*Maintaining the Terminal\*](#) includes tips on properly maintaining your terminal and batteries.
- ◆ [Chapter 7, \*Error Recovery and Troubleshooting\*](#) basic information on terminal and software troubleshooting.
- ◆ [Appendix A, \*Null Modem Pin-outs\*](#) provides the pin-outs for null modem communication.
- ◆ [Appendix B, \*Keyboard Layouts\*](#) describes the 35-key and 46-key keyboards and the associated key functions.
- ◆ [Appendix C, \*Communications Status Codes\*](#) provides communication status codes and their meaning.



- ◆ [Appendix D, Specifications](#) provides the technical specifications for the terminal.
- ◆ [Appendix E, Boot-Up Quick Reference](#) provides the key sequence necessary to initiate a warm boot, cold boot, or command mode start.
- ◆ [Appendix F, 2D Scanner Drivers and Applications](#) describes the installation of the 2D scan engine drivers and applications.

## Notational Conventions

---

The following conventions are used in this document:

- Italics are used to highlight specific items in the general text, and to identify chapters and sections in this and related documents.
- Bullets (•) indicate:
  - action items
  - lists of alternatives
  - lists of required steps that are not necessarily sequential
- ◆ Sequential lists (e.g., those that describe step-by-step procedures) appear as numbered lists.

## Related Publications

---

The following is a list of documents and publications that you may find useful if you want to know more about the PDT 6800 Series terminals or about the tools and utilities that are available for writing applications for the terminals.

- ◆ *PDT 6800 Series Quick Reference Guide*  
p/n 70-32644-XX
- ◆ *CCM 38/6860 Quick Reference Guide*  
p/n 70-33400-XX
- ◆ *CRD 38/6865 Quick Reference Guide*  
p/n 70-33401-XX
- ◆ *CRD 38/6866 Quick Reference Guide*  
p/n 70-33402-XX
- ◆ *Printer Interface Module Quick Reference Guide*  
p/n 59164-00-82
- ◆ *Series 3000 Application Programmer's Guide*  
p/n 70-16308-XX

- ◆ *Series 3000 Application Programmer's Reference Manual*  
p/n 70-16309-XX
- ◆ *Series 3000 System Software Manual*  
p/n 70-16310-XX
- ◆ *Series 3000 Application Developer's Library*  
p/n 70-16311-XX
- ◆ *Spectrum24 Access Point User's Guide*  
p/n 70-12057-XX
- ◆ *Spectrum24 Network Terminal Technical Reference Guide*  
p/n 70-20193-XX
- ◆ *Novell LAN Workplace Reference Manual*  
p/n 70-20288-XX
- ◆ *Spectrum24 TNClient System Administrator's Guide*  
p/n 70-20244-XX
- ◆ *Spectrum24 STEP Installation and Configuration Guide for Series 3000 Flash Disk Terminals*  
p/n 70-20343-XX
- ◆ *Spectrum24 NDK Series 3000*  
p/n 70-20481-XX

## Service Information

---

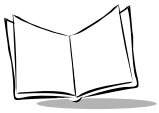
If you have a problem with your equipment, contact the [Symbol Support Center](#) for your region. See [page xii](#) for contact information. Before calling, have the model number, serial number, and several of your bar code symbols at hand.

Call the Support Center from a phone near the scanning equipment so that the service person can try to talk you through your problem. If the equipment is found to be working properly and the problem is symbol readability, the Support Center will request samples of your bar codes for analysis at our plant.

If your problem cannot be solved over the phone, you may need to return your equipment for servicing. If that is necessary, you will be given specific directions.

---

**Note:** *Symbol Technologies is not responsible for any damages incurred during shipment if the approved shipping container is not used. Shipping the units improperly can possibly void the warranty. If the*



*original shipping container was not kept, contact Symbol to have another sent to you.*

---

## **Symbol Support Center**

For service information, warranty information or technical assistance contact or call the Symbol Support Center in:

### **United States**

Symbol Technologies, Inc.  
One Symbol Plaza  
Holtsville, New York 11742-1300  
1-800-653-5350

### **United Kingdom**

Symbol Technologies  
Symbol Place  
Winnersh Triangle, Berkshire RG41 5TP  
United Kingdom  
0800 328 2424 (Inside UK)  
+44 208 945 7529 (Outside UK)

### **Australia**

Symbol Technologies Pty. Ltd.  
432 St. Kilda Road  
Melbourne, Victoria 3004  
1-800-672-906 (Inside Australia)  
+61-3-9866-6044 (Outside Australia)

### **Denmark**

Symbol Technologies AS  
Gydevang 2,  
DK-3450 Allerod, Denmark  
7020-1718 (Inside Denmark)  
+45-7020-1718 (Outside Denmark)

### **Canada**

Symbol Technologies Canada, Inc.  
2540 Matheson Boulevard East  
Mississauga, Ontario, Canada L4W 4Z2  
905-629-7226

### **Asia/Pacific**

Symbol Technologies Asia, Inc.  
230 Victoria Street #04-05  
Bugis Junction Office Tower  
Singapore 188024  
337-6588 (Inside Singapore)  
+65-337-6588 (Outside Singapore)

### **Austria**

Symbol Technologies Austria GmbH  
Prinz-Eugen Strasse 70  
Suite 3  
2.Haus, 5.Stock  
1040 Vienna, Austria  
1-505-5794 (Inside Austria)  
+43-1-505-5794 (Outside Austria)

### **Europe/Mid-East Distributor Operations**

Contact your local distributor or call  
+44 118 945 7360

**Finland**

Oy Symbol Technologies  
Kaupintie 8 A 6  
FIN-00440 Helsinki, Finland  
9 5407 580 (Inside Finland)  
+358 9 5407 580 (Outside Finland)

**Germany**

Symbol Technologies GmbH  
Waldstrasse 68  
D-63128 Dietzenbach, Germany  
6074-49020 (Inside Germany)  
+49-6074-49020 (Outside Germany)

**Latin America Sales Support**

7900 Glades Road  
Suite 340  
Boca Raton, Florida 33434 USA  
1-800-347-0178 (Inside United States)  
+1-561-483-1275 (Outside United States)

**Netherlands**

Symbol Technologies  
Kerkplein 2, 7051 CX  
Postbus 24 7050 AA  
Varsseveld, Netherlands  
315-271700 (Inside Netherlands)  
+31-315-271700 (Outside Netherlands)

**France**

Symbol Technologies France  
Centre d'Affaire d'Antony  
3 Rue de la Renaissance  
92184 Antony Cedex, France  
01-40-96-52-21 (Inside France)  
+33-1-40-96-52-50 (Outside France)

**Italy**

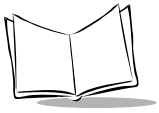
Symbol Technologies Italia S.R.L.  
Via Cristoforo Colombo, 49  
20090 Trezzano S/N Navigilo  
Milano, Italy  
2-484441 (Inside Italy)  
+39-02-484441 (Outside Italy)

**Mexico**

Symbol Technologies Mexico Ltd.  
Torre Picasso  
Boulevard Manuel Avila Camacho No 88  
Lomas de Chapultepec CP 11000  
Mexico City, DF, Mexico  
5-520-1835 (Inside Mexico)  
+52-5-520-1835 (Outside Mexico)

**Norway**

Symbol Technologies  
Trollasveien 36  
Postboks 72  
1414 Trollasen, Norway  
66810600 (Inside Norway)  
+47-66810600 (Outside Norway)



### **South Africa**

Symbol Technologies Africa Inc.  
Block B2  
Rutherford Estate  
1 Scott Street  
Waverly 2090 Johannesburg  
Republic of South Africa  
11-4405668 (Inside South Africa)  
+27-11-4405668 (Outside South Africa)

### **Spain**

Symbol Technologies S.A.  
Edificio la Piovera Azul  
C. Peonias, No. 2 - Sexta Planta  
28042 Madrid, Spain  
+913244000 (Inside Spain)  
+34-9-1-320-39-09 (Outside Spain)

### **Sweden**

Symbol Technologies AB  
Albygatan 109D  
Solna  
Sweden  
84452900 (Inside Sweden)  
+46 84452900 (Outside Sweden)

If you purchased your Symbol product from a Symbol Business Partner, contact that Business Partner for service.

## **Warranty**

---

Symbol Technologies, Inc. (“Symbol”) manufactures its hardware products in accordance with industry-standard practices. Symbol warrants that for a period of twelve (12) months from date of shipment, products will be free from defects in materials and workmanship.

This warranty is provided to the original owner only and is not transferable to any third party. It shall not apply to any product (i) which has been repaired or altered unless done or approved by Symbol, (ii) which has not been maintained in accordance with any operating or handling instructions supplied by Symbol, (iii) which has been subjected to unusual physical or electrical stress, misuse, abuse, power shortage, negligence or accident or (iv) which has been used other than in accordance with the product operating and handling instructions. Preventive maintenance is the responsibility of customer and is not covered under this warranty.

Wear items and accessories having a Symbol serial number, will carry a 90-day limited warranty. Non-serialized items will carry a 30-day limited warranty.

## **Warranty Coverage and Procedure**

During the warranty period, Symbol will repair or replace defective products returned to Symbol's manufacturing plant in the US. For warranty service in North America, call the Symbol Support Center at 1-800-653-5350. International customers should contact the local Symbol office or support center. If warranty service is required, Symbol will issue a Return Material Authorization Number. Products must be shipped in the original or comparable packaging, shipping and insurance charges prepaid. Symbol will ship the repaired or replacement product freight and insurance prepaid in North America. Shipments from the US or other locations will be made F.O.B. Symbol's manufacturing plant.

Symbol will use new or refurbished parts at its discretion and will own all parts removed from repaired products. Customer will pay for the replacement product in case it does not return the replaced product to Symbol within 3 days of receipt of the replacement product. The process for return and customer's charges will be in accordance with Symbol's Exchange Policy in effect at the time of the exchange.

Customer accepts full responsibility for its software and data including the appropriate backup thereof.

Repair or replacement of a product during warranty will not extend the original warranty term.

Symbol's Customer Service organization offers an array of service plans, such as on-site, depot, or phone support, that can be implemented to meet customer's special operational requirements and are available at a substantial discount during warranty period.

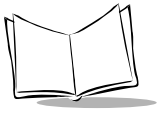
## **General**

Except for the warranties stated above, Symbol disclaims all warranties, express or implied, on products furnished hereunder, including without limitation implied warranties of merchantability and fitness for a particular purpose. The stated express warranties are in lieu of all obligations or liabilities on part of Symbol for damages, including without limitation, special, indirect, or consequential damages arising out of or in connection with the use or performance of the product.

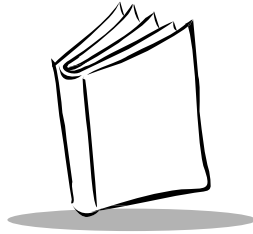
Seller's liability for damages to buyer or others resulting from the use of any product, shall in no way exceed the purchase price of said product, except in instances of injury to persons or property.

Some states (or jurisdictions) do not allow the exclusion or limitation of incidental or consequential damages, so the proceeding exclusion or limitation may not apply to you.





*PDT 6800 Series Product Reference Guide*



# Chapter 1

## Getting Started

### Introduction

---

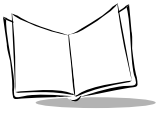
The PDT 6800 Series terminal is a hand-held, battery-powered, portable data collection device. Data is entered from the terminal's keyboard or through the integrated laser scanner.

As a remote terminal, it collects and stores data that is later uploaded to a host computer. The PDT 6800 Series terminals include:

- ◆ PDT 6800 - batch terminal (no radio)
- ◆ PDT 6810 - Spectrum One<sup>®</sup> network
- ◆ PDT 6842 - 2 Mb Spectrum24<sup>®</sup> radio network
- ◆ PDT 6845 - 2 Mb Spectrum24<sup>®</sup> radio (short range) network
- ◆ PDT 6846 - 11 Mb Spectrum24<sup>®</sup> radio network

Since the procedures and descriptions in this guide are similar for all terminals listed above, *PDT 6800 Series terminals* is used as a general term describing all terminals, unless otherwise specified.

PDT 6800 Series terminals use Caldera's DR DOS<sup>™</sup> operating system that is compatible with and extends Microsoft<sup>®</sup> MS-DOS<sup>®</sup>. Although the terminals are MS-DOS feature compatible, they are not one hundred percent MS-DOS compatible. DR DOS provides access to a number of commercially available programming tools. Additional programming tools are available from Symbol for easier programming and access to special features.



Power saving features of the PDT 6800 Series terminals include auto-off and power save modes, which reduce power consumption until an operator provides input. These features conserve battery power, lengthening the time between charges or replacement.

## Parts of the PDT 6800 Series Terminal

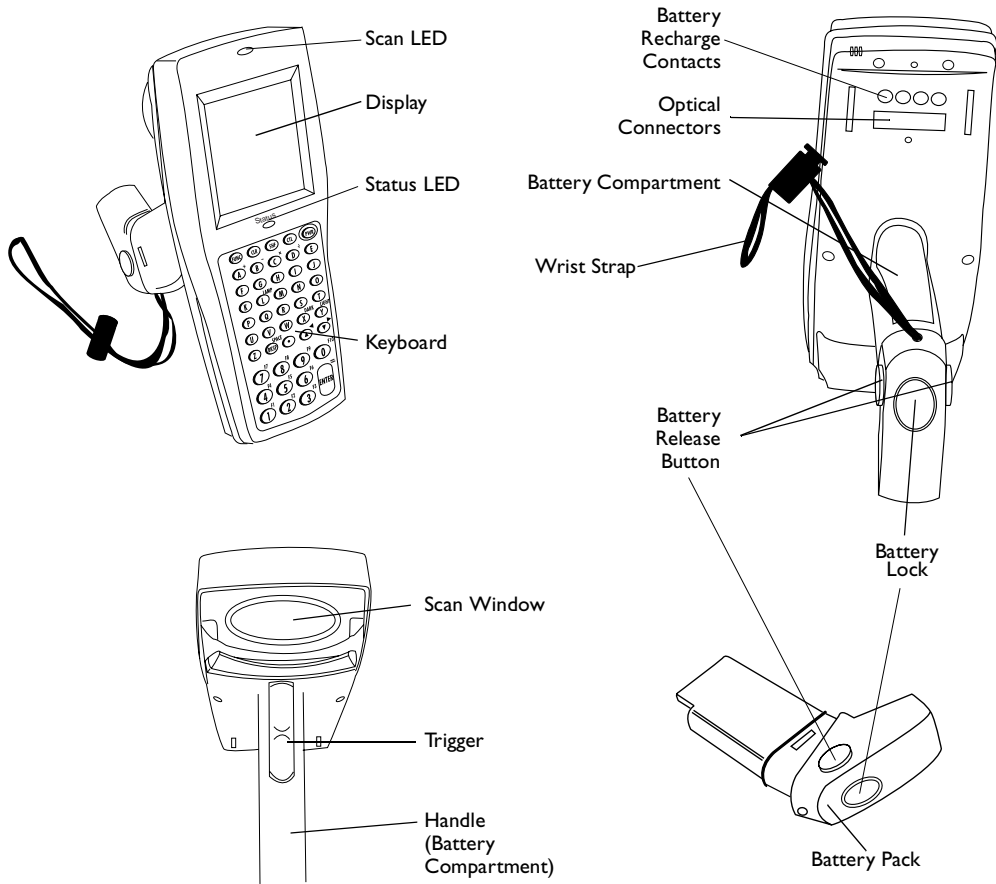


Figure I-1. Parts of the PDT 6800 Series Terminal

## Accessories

---

The following accessories are available for the PDT 6800 Series terminal.

### **Battery Chargers**

The terminal uses a six-cell 600 mAh (intrinsically safe) Nickel Cadmium (NiCd) battery, or a Lithium Ion battery.

The NiCd battery is charged using one of the following charging accessories:

- ◆ CCM 38/6860 — Four-slot Charging and Communications Module (CCM) for charging NiCd battery packs in the terminal and spare battery packs; also performs communications between terminals and a host, modem, or printer.
- ◆ CRD 38/6865 — Single-slot cradle for charging NiCd battery packs; also performs communications between terminals and a host, a modem, or a printer.
- ◆ CRD 38/6866 — Four-slot cradle for charging NiCd battery packs in the terminal and for communicating between terminals and a host, a modem, or a printer.
- ◆ UBC Charger — UBC 1000 or 2000 battery charger.
- ◆ PC Adapter — Works with the Printer Interface Module (PIM) to communicate with the host PC without a cradle or to charge a NiCd battery pack in the terminal without a cradle.

The Lithium Ion battery is charged using the UBC 2000 charging adapter p/n 21-32665-24.

### **Printer Interface Module**

The Printer Interface Module works with the PC Adapter to perform communications between the terminal and a host PC or a printer without a cradle.

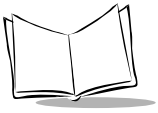
### **Radio and Network Options**

#### **Spectrum One Network**

The PDT 6810 includes an internal radio frequency transmitter/receiver for use in a Symbol Spectrum One network.

#### **Spectrum24 Network**

The PDT 6842, PDT 6845, and PDT 6846 include an internal radio frequency transmitter/receiver for use in a Symbol Spectrum24 network. Refer to *Spectrum24 Network Terminal Technical Reference Guide*, p/n 70-20193-XX, for more information.



## Unpacking

---

Remove the clear protective tape from the display and the optical connector.

Save the shipping container for later storage or shipping. Inspect all equipment for damage and make sure you have received everything listed on the packing slip.

If you find anything unsatisfactory or missing, contact your authorized customer support representative immediately.

## Before You Use the Terminal

---

### ***Install and Charge Battery***

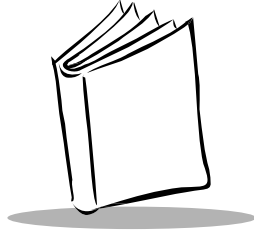
Prior to using the PDT 6800 Series terminal for the first time, install the battery pack. Be sure to charge the battery pack before use. Refer to [Chapter 6, \*Maintaining the Terminal\*](#).

If you hear a repeated tone or see a message on the display, recharge or replace the battery pack. Refer to [Chapter 6, \*Maintaining the Terminal\*](#).

### ***Load the Appropriate Software***

What software you load and how you load it depends on the environment in which you use it:

- ◆ If the terminal is intended for use in batch applications (PDT 6800) or in a Spectrum One network environment (PDT 6810), refer to [Chapter 3, \*Batch and Spectrum One Terminal Setup\*](#) for information on loading the software.
- ◆ If the terminal is intended for use in a Spectrum24 network environment (PDT 6842, PDT 6845, or PDT 6846), refer to [Chapter 4, \*Spectrum24 RF Terminal Setup\*](#) for information on loading the software.
- ◆ If you are using the 2D scan engine, install the appropriate drivers and applications. Refer to [Appendix E, \*2D Scanner Drivers and Applications\*](#).



## Chapter 2

# Accessories Setup

### Introduction

---

This chapter provides instructions for setting up the cradle, module, and PC adapter for charging the NiCd battery and communicating with a host, printer, or modem.

---

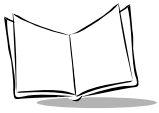
**Note:** *The Lithium Ion battery is charged in the UBC 2000 battery adapter p/n 21-32665-24. Refer to [Chapter 6, Maintaining the Terminal](#) for more information.*

---

The CRD 38/6865 cradle, CRD 38/6866 cradle, and CCM 38/6860 Charging and Communications Module provide RS-232 communication, charging, and storage for the PDT 6800 Series terminal.

The PC adapter provides charging for the NiCd battery and communications for the terminal.

Save the shipping container for storing or shipping the cradle, module, or PC adapter. Inspect all equipment for damage. If anything is damaged or missing, call your authorized customer support representative immediately.



## Required Parts

---

Before attempting to mount or connect the cradles, verify that you have the following parts:

CRD 38/6865	CRD 38/6866
Single-Slot Cradle with Charging Slot:	Four-Slot Cradle
◆ US Kit: 3865-110	◆ US Kit: 3866-100
◆ International Kit: 3865-111	◆ International Kit: 3866-101
AC Power Supply:	AC Power Supply
◆ US:59915-00-00	◆ US:60153-00-00
◆ International: 60507-00-00	◆ International: 60174-00-00
Null Modem Cable, DB 25 Male to DB 25 Female (p/n 25-19297-01)	Null Modem Cable, DB 25 Male to DB 25 Female (p/n 25-19297-01)
Null Modem Cable, DB25 Male to DB 9 Female (p/n 25-19299-01)	Null Modem Cable DB25 Male to DB 9 Female (p/n 25-19299-01)
Wall Mounting Kit (p/n 3866-000)	Chaining Interconnect Cable (p/n 60427-00-00)
	Two Wall Mounting Kits (p/n 3866-000) per 38/6866

Before attempting to mount or connect the Charging and Communications Module (CCM) 38/6860, verify that you have the following parts:

Four-slot CCM Kit (includes power supply, mounting brackets, and hardware:

- ◆ US: 3860-100
- ◆ International: 3860-101

AC Power Supply:

- ◆ US: 58690-00-00
- ◆ International: 58690-01-00

Null Modem Cable

- ◆ DB-25 Female to DB-25 Female (p/n 59846-00-00)
- ◆ DB-25 Female to DB-9 Female (p/n 25-19298-01)

CCM Four-Slot Add-on Kit (includes CCM, coupling kit, and mounting brackets):

- ◆ p/n 3861-101

## Parts of the CRD 38/6865

---

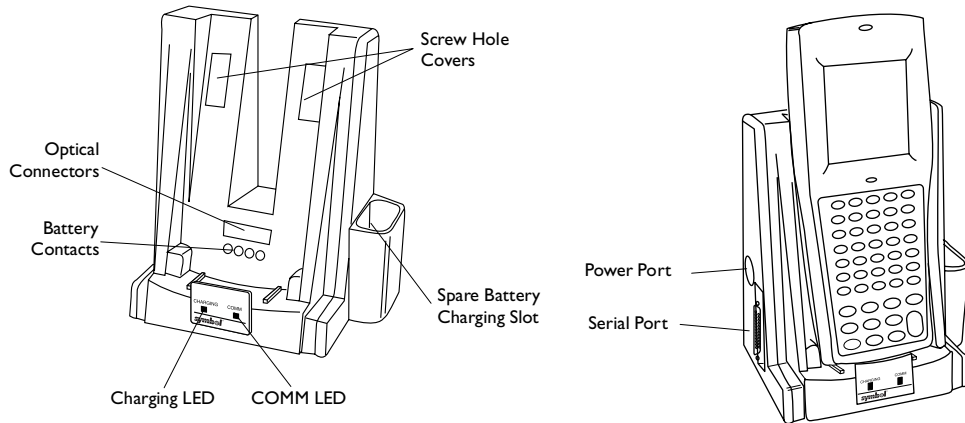


Figure 2-1. Parts of the CRD 38/6865

## Parts of the CRD 38/6866

---

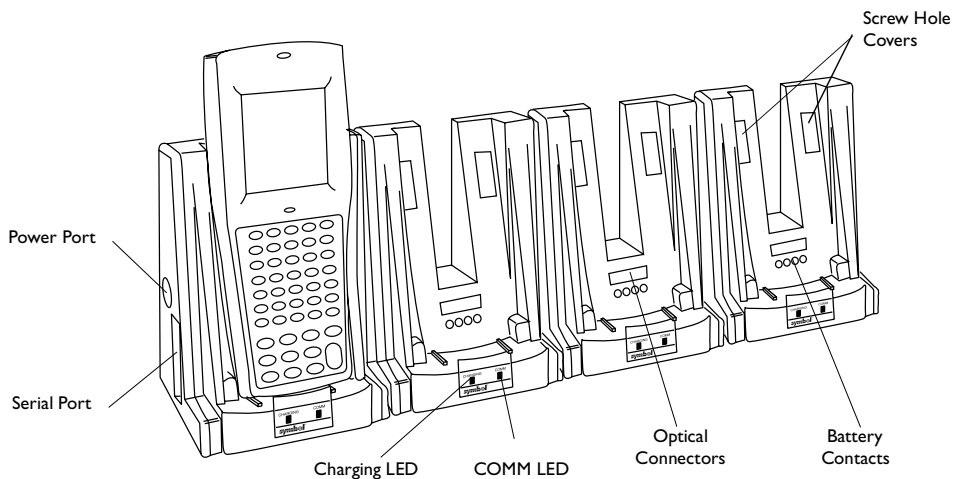
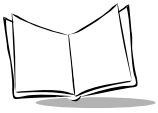


Figure 2-2. Parts of the CRD 38/6866



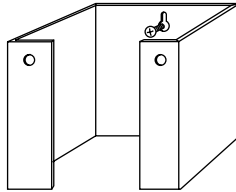


## Wall Mounting the CRD 38/6865

---

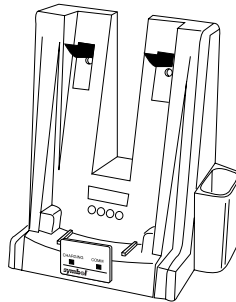
The CRD 38/6865 can be wall-mounted on a wall bracket for convenience. To wall-mount the 38/6865:

1. Mark where you want the cradle positioned on the wall.
2. Using a fastener appropriate to the wall construction, insert and secure the fastener ([Figure 2-3](#)). Let the head protrude slightly.



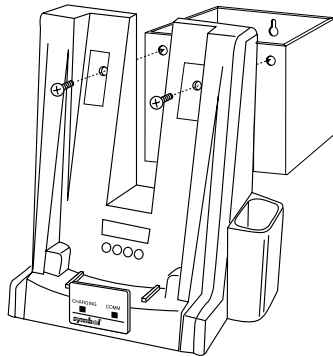
**Figure 2-3. Wall Mounting the 38/6865**

3. Slide the bracket down over the head of the fastener.
4. Remove the black tape covers from the cradle screw holes ([Figure 2-4](#)).



**Figure 2-4. Removing the Tape Covers**

5. Position the cradle on the bracket.



**Figure 2-5. Secure Cradle to Bracket**

6. Secure the cradle to the bracket using two #10 metal screws ([Figure 2-5](#)).

## Wall Mounting the CRD 38/6866

---

The CRD 38/6866 can be wall-mounted on two mounting brackets. Follow the directions for [Wall Mounting the CRD 38/6865](#) on page 2-4, using two brackets.

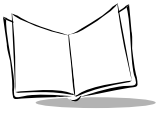
## Table Mounting the CRD 38/6866

---

*Note: Installing the suction cup feet is not mandatory but helps keep the cradle in place.*

---

1. On the bottom of the cradle, thread each of the four suction cup feet into the screw holes.



2. Wet the base of each suction cup and secure the cradle to a smooth tabletop by pushing firmly down on the cradle (Figure 2-6).



**Figure 2-6. Installing Suction Cups on the CRD 38/6866**

## Connecting Power

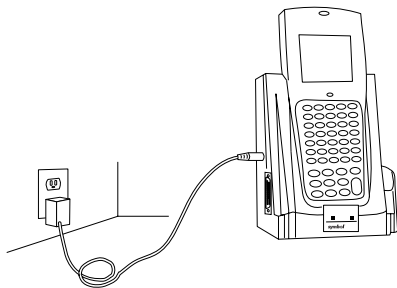
---

*Note: Connecting power to both CRD 38/6865 and CRD 38/6866 is the same.*

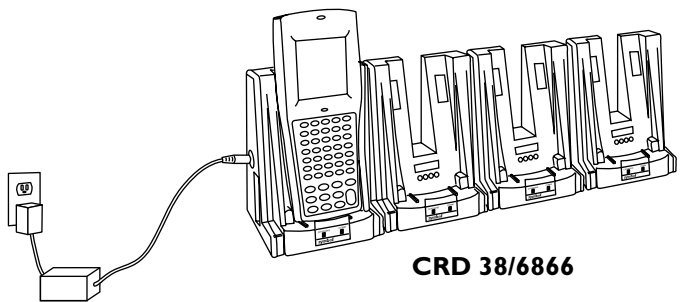
---

1. Connect the power supply cord's round plug to the power port on the left side of the cradle.
2. Connect the power supply's AC plug to a standard electrical outlet.

The green and red indicators light for 3 seconds, blink for 3 seconds, then go out.



**CRD 38/6865**



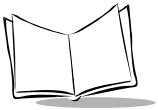
**CRD 38/6866**

**Figure 2-7. Connecting Power to the CRD 38/6865 and CRD 38/6866**

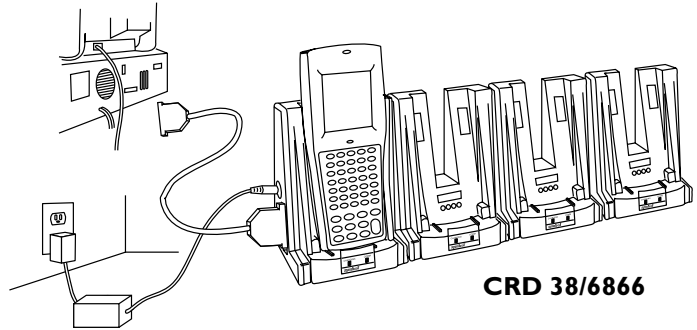
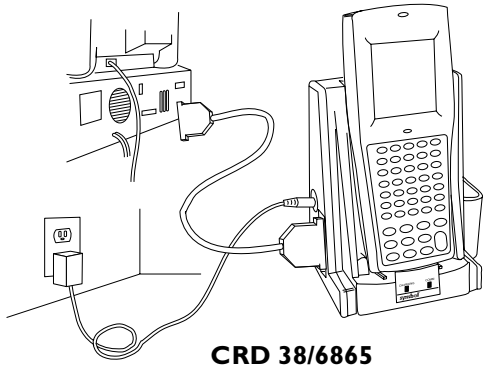
## **Connecting for Data Communications**

To connect the CRD 38/6865 or CRD 38/6866:

1. Be sure to unplug the cradle's power supply before connecting the serial cables.
2. Turn off the PC.
3. Plug the RS-232 serial cable's DB-25 connector in the cradle's communication port ([Figure 2-8](#)).
4. Connect the cable's other connector to the host computer's serial (COMM) port.



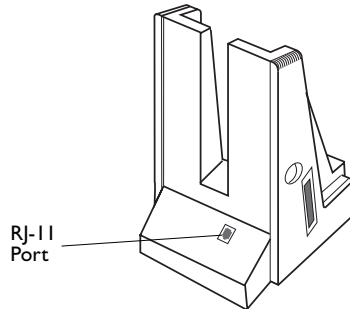
5. Reconnect the cradle's power supply



**Figure 2-8. Connecting the CRD 38/6865 and CRD 38/6866 for Communications with Computer, Printer, or Modem**

## Connecting the CRD 38/6865 Internal Modem

---



**Figure 2-9. RJ-11 Internal Modem Connection**

Some cradles use an optional internal modem that communicates at rates of up to 14,400 bps (with v.32 bit data compression). It can be connected directly to a telephone line through the RJ-11 port shown in [Figure 2-9](#).

---

**Note:** *The four-slot cradle does **not** have an internal modem.*

---

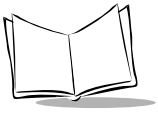
To connect the internal modem:

1. Connect the phone cord into the RJ-11 port on the back of the cradle.
2. Connect the other end of the phone cord into the wall phone jack.

### **Caution**

When connecting the internal modem to the phone line, always connect the phone line to the cradle first, then to the wall phone jack. When removing the connection, always remove the telephone line from the wall phone jack, then remove from the cradle.

There are specific firmware settings which are used to configure the modem's hardware and software for proper operation and regulatory compliance. The terminal's application can control these settings and enable you to view and amend the settings for country/region, pulse/tone dialing, or repeat dial timing. Incorrectly defining these settings can lead to illegal use of the modem and can create unreliable operation. The application developer should consult the Series 3000 Application Programmer's Reference Manual for correct settings.



## Connecting to the Telephone Network

---

A compliant telephone cord is required with an RJ-11 plug connection to the modem, terminated with an appropriate and correctly wired local telecom connector compatible with the telephone network. Such a cable may be obtained from your local supplier. Alternately, compliant RJ-11 plugs to RJ-11 plug cables may be used with a range of adapters for locations such as Europe.

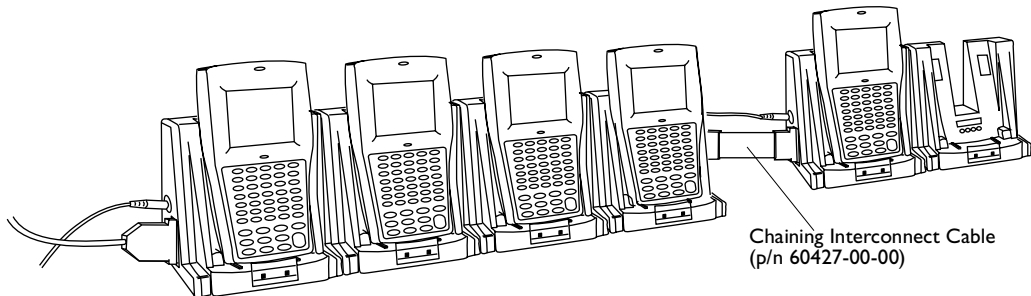
### Connecting the CRD 38/6866 to Other Cradles

Up to twenty-four CRD 38/6866 cradles can be connected in a series using an RS-232 inter-cradle cable (p/n 60427-00-00) between each cradle.

#### *Caution*

Each cradle must have its own power supply; any other power hook-up method is unsafe.

1. Plug one end of the inter-cradle cable into the communication port located on the right end of the first cradle.
2. Plug the other end of the inter-cradle cable into the communication port located below the power connector on the left end of the second cradle.
3. Connect the power supply to the second cradle as described in [Connecting Power](#) on page 2-6.
4. Repeat the above steps for any additional cradles being added to the chain.

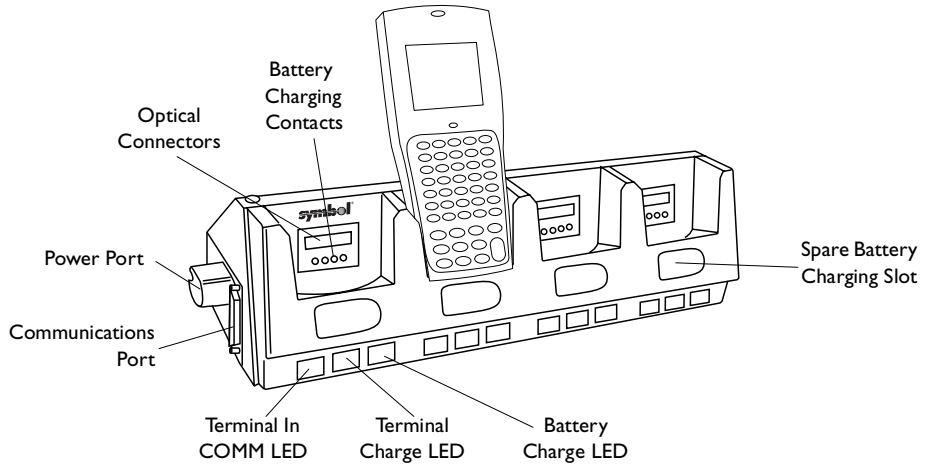


**Figure 2-10. Connecting the CRD 38/6866 to Other Cradles**

# CCM 38/6860

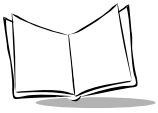
---

## Parts of the CCM 38/6860



**Figure 2-11. Parts of the CCM 38/6860**



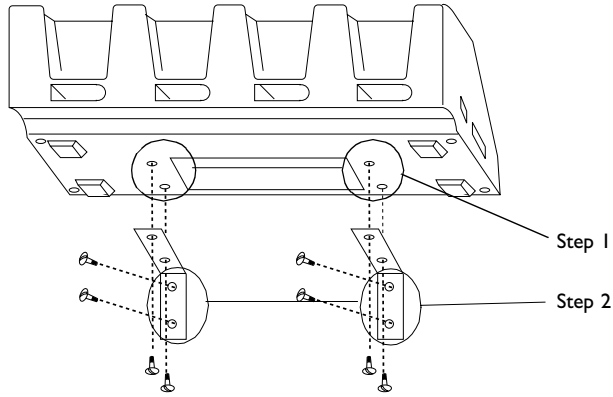


## Wall Mounting

The CCM 38/6860 can be table or wall mounted.

To wall mount the CCM:

1. Attach the wall-mounting brackets to the bottom of the CCM using the screws provided (Figure 2-12)



**Figure 2-12. Wall Mounting the CCM**

2. Position the CCM with attached brackets on the wall.
3. Insert the appropriate wall-mounting hardware into the bracket holes as shown in Figure 2-12 and secure.

---

*Note: Appropriate wall-mounting hardware is provided by customer.*

---

## Coupling CCMs

Up to four CCM 38/6860s can be coupled together for table or wall mounting, with power provided by a single power supply attached to the left-most CCM. To couple two or more CCMs for table or wall mounting:

1. Verify that add-on kit p/n 3861-101 contains the following parts:
  - ♦ 1 CCM
  - ♦ 1 coupling bracket
  - ♦ 6 cross-head screws
  - ♦ 2 flat-head screws

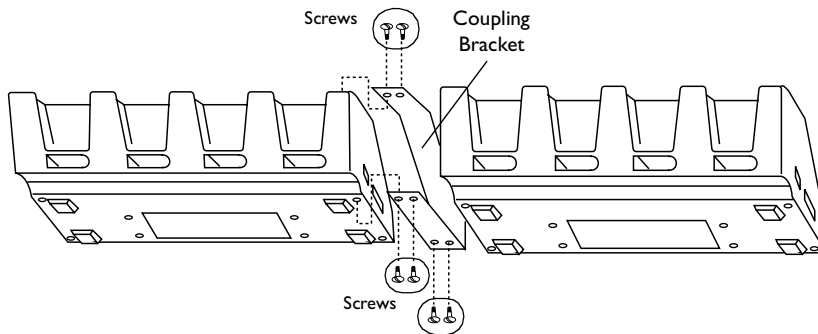
2. On the add-on (or right-hand) CCM, use a 3/16-inch driver and remove the jack screws, securing the communications port, and replace them with the flat-head screws ONE AT A TIME.

---

**Note:** *Be sure to remove the jack screws one at a time; otherwise, the connector will fall into the housing.*

---

3. Mate the power port on the right side of the first cradle with the power port on the left hand side of the second cradle.
4. Place the coupling bracket between the CCMs, aligning the holes in the coupling bracket with the holes in the CCM's base (Figure 2-13).
5. Install 6 cross-head screws through the coupling bracket into the CCMs and tighten.
6. To wall mount the coupled CCMs, refer to [Wall Mounting](#) above.

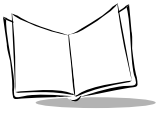


**Figure 2-13. Coupling Two CCMs**

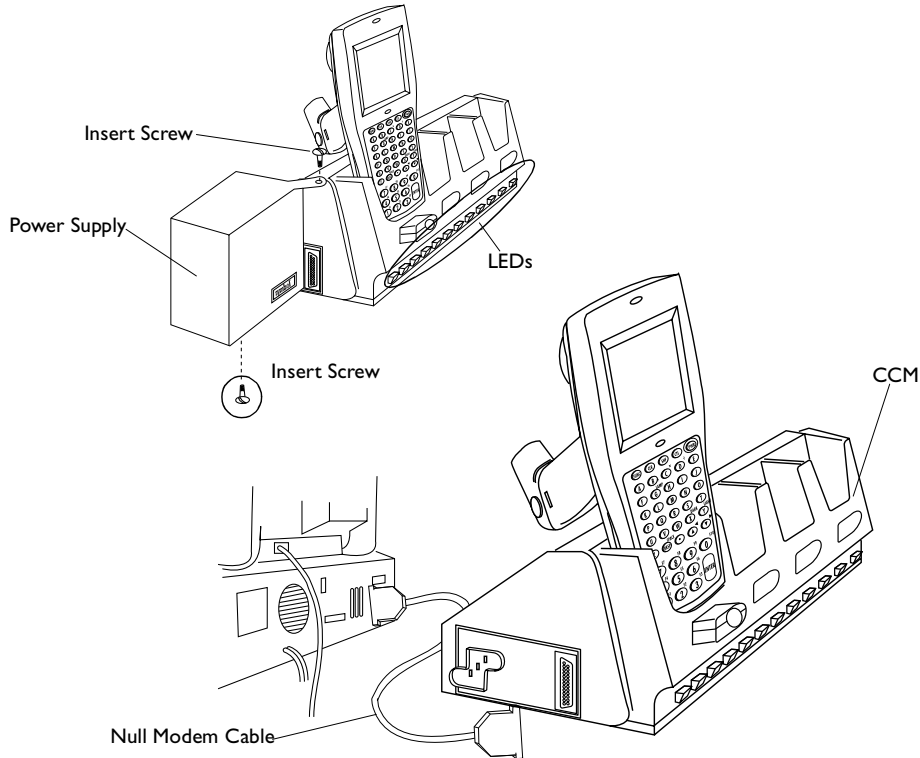
## Connecting Power

Only the power connection is required for charging batteries in the CCM.

1. Install the power supply.
  - a. Attach the power supply to the left side of the CCM as shown in [Figure 2-14](#) using two cross-head screws.
  - b. Connect the power supply plug to an AC wall outlet.



2. When the CCM is connected to power, all the LEDs flash at the same time for 3 seconds, flash once from left to right, and then turn on for 3 seconds before going out.



**Figure 2-14. Connecting the CCM 38/6860 for Charging and Communications**

## Connecting the CCM for Serial Communications

---

**Note:** Both the communications cables and the power supply connection are required for performing communications through the CCM.

---

1. Turn off the PC.
2. Plug the RS-232 null modem cable's DB-25 connector in the cradle's communication port.

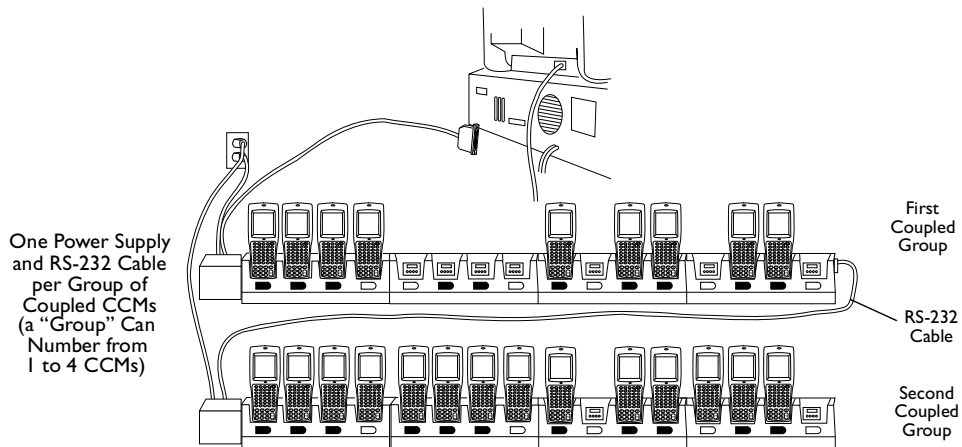
3. Connect the cable's other connector to the host computer's serial (COMM) port.

## Daisy-Chaining Two or More CCMs

Up to twenty-four CCMs can be daisy-chained together for charging and communications. To daisy chain two or more groups of four CCMs requires:

- ◆ one 25-pin, male-to-female, straight-through RS-232 cable per group of coupled CCMs
- ◆ one power supply per group of coupled CCMs.

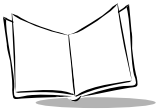
Depending on how close together you place the CCMs, the cables can be from 1-foot to 10-foot long.



**Figure 2-15. Daisy-Chaining Multiple CCMs**

To chain the CCMs:

1. Couple the CCMs as directed in the section [Coupling CCMs](#).
2. In the first coupled section, connect the serial cable to the left-most CCM.
3. Connect the RS-232 cable's (male or female) DB-25 connector in the serial port of the right-most CCM in the first coupling.
4. Connect the (male or female) DB-25 in the serial port of the left-most CCM in the second coupling.



5. Connect the power supplies for each coupled section as directed in [Connecting Power](#).

## PC Adapter

---

The PC Adapter works with the Printer Interface Module (PIM) so you can:

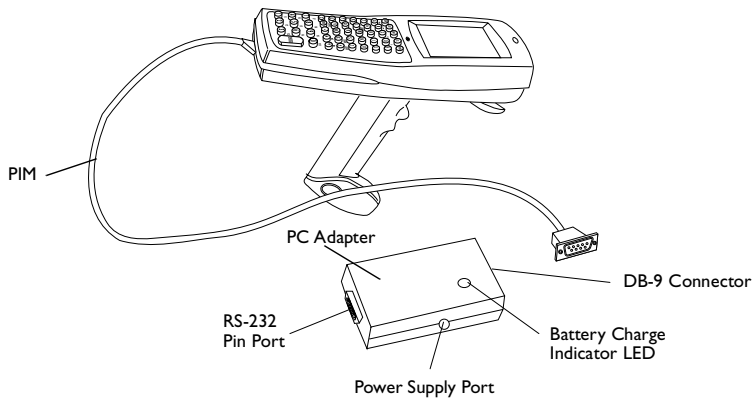
- ◆ Communicate to and from the PC without a CCM 38/6860, CRD 38/6865, or CRD 38/6866 cradle
- ◆ Charge the NiCd battery pack in the terminal without a cradle.

---

**Note:** *The Lithium Ion battery DOES NOT charge when the PC Adapter and PIM are connected. Use the UBC 2000 battery adapter p/n 21-32665-24 to charge the Lithium Ion battery.*

---

### Parts of the PC Adapter



**Figure 2-16. Parts of the PC Adapter**

- ◆ The Battery Charge Indicator LED flashes when the terminal power is turned on and while the NiCd battery pack is being charged.

---

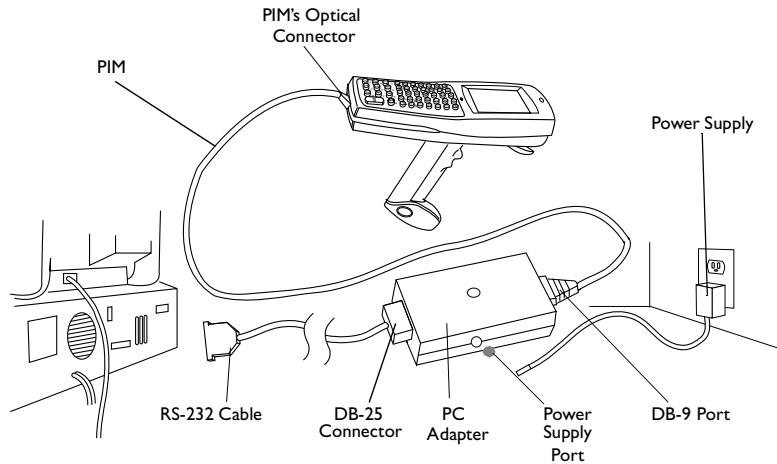
**Note:** *When power to the PC Adapter is turned on, NiCd battery charging begins automatically and continues for 7 hours.*

---

The LED flashes once when the terminal is turned on. It remains steady while the terminal is powered and blinks slowly during downloading.

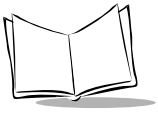
- ◆ The RS-232 25-pin port attaches the null modem cable connected to a PC or other RS-232 device. See [Appendix A, Null Modem Pin-outs](#) for null modem pin-outs.
- ◆ The DB-9 connector attaches the PIM's DB-9 connector.
- ◆ The power supply port attaches the 15-Volt power supply.

## Connecting the PC Adapter to the Terminal and Serial Device

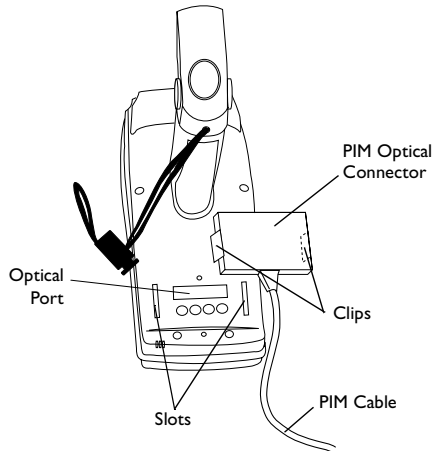


**Figure 2-17. Setting Up the PC Adapter**

1. Turn the PC and terminal OFF.
2. Plug the PIM's DB-9 connector in the PC Adapter's DB-9 port.

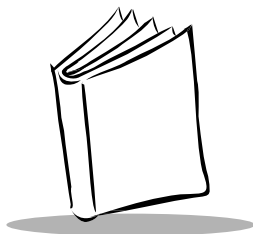


3. Attach the PIM's optical connector to the terminal by inserting the clips on the connector in the slots on either side of the port (Figure 2-18).



**Figure 2-18. Attaching the PIM's Optical Connector**

1. Connect the RS-232 cable's DB-25 connector in the PC Adapter's RS-232 port.
2. Plug the other end of the RS-232 cable in the RS-232 device (e.g., host PC).
3. Plug the jack end of the 16-Volt power supply into the power supply port.
4. Plug the 15-Volt power supply's cube into an electrical outlet. The Battery Charge Indicator LED flashes when the terminal is powered on.



## Chapter 3

# Batch and Spectrum One Terminal Setup

### Introduction

---

Before using the PDT 6800 Series terminal, perform the following:

- ◆ Install the battery (refer to [Chapter 6, Maintaining the Terminal](#))
- ◆ Charge the battery (refer to [Chapter 6, Maintaining the Terminal](#))
- ◆ Load the system files and application(s) (refer to *Series 3000 Application Programmer's Guide* p/n 70-16308-XX).

### Hardware Requirements

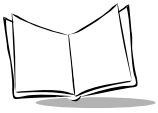
---

Following is the equipment required to initialize a batch or Spectrum One radio terminal:

- ◆ PDT 6800 (batch) or PDT 6810 (Spectrum One) terminal
- ◆ One or more CCM 38/6860 or CRD 38/6866, or a CRD 38/6865
- ◆ OR
- ◆ PC adapter with Printer Interface Module (PIM)
- ◆ RS-232 null modem cable
- ◆ Power Supply
- ◆ Host Computer.

Refer to [Chapter 2, Accessories Setup](#) for setting up the cradles or PC Adapter for communications.





## Communications

For terminals being used in a direct communications (batch) environment or a Spectrum One network environment, applications are transferred from a host computer to the terminal:

- ◆ over a communications line using a null modem connected to the cradle  
OR
- ◆ through the PC Adapter.

The procedure uses the SENDHEX program on the host computer and the Program Loader function (from Command Mode) on the terminal.

Programs are stored in the terminal's nonvolatile memory (NVM), also called the application EEPROM.

---

**Note:** For details on the SENDHEX program, refer to the Series 3000 Application Programmer's Manual.

---

Other software may be used in place of the SENDHEX program.

## Downloading the Program

---

To download the program, initiate the communications software on the host computer and terminal as described in the following sections.

---

**Note:** To cancel communications at any time during the session, press CLEAR on the terminal. The session stops immediately.

*Communications parameters specified on the host and the terminal must match. These parameters typically are:*

38400 bps  
7-bit parity  
Odd parity  
Xon/Xoff flow control

To program the EEPROM, the terminal must be connected to the host through a cradle, CCM 38/6860, or PC Adapter with PIM.

---

## Initiate Host Communications Software

If using a cradle (CCM 38/6860, CRD 38/6866, CRD 38/6865), do steps 1-3. Otherwise continue with step 4.

1. Connect the cradle to the host computer. Refer to [Chapter 2, Accessories Setup](#).
2. Power on the cradle.
3. Place the terminal in the cradle.
4. Connect the PC adapter.
5. Power on the host computer.
6. Start the communications program.
7. At the DOS prompt, enter the SENDHEX command:

```
sendhex pgmname 38400 com2
```

where:

SENDHEX	is the command
pgmname	is the application being loaded (.hex extension is optional)
parameters	are the communications parameters following the program name. Parameters include baud rate, communications port, data bits, parity, and flow control. To accept the default parameters, do not enter a value.

In the example, the baud rate is set to 38400 bps and the communications port to COM2. The default values are accepted for the remaining parameters.

---

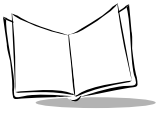
**Note:** *Versions of SENDHEX earlier than 3.0 do not support flow control. If you use an earlier version and encounter communication errors, use a lower baud rate.*

---

8. SENDHEX displays the prompt:

```
Press <Enter> to begin communications.
```

9. Do NOT press <ENTER> yet. Before starting communications (refer to [Starting Communications](#) on page 3-6), set up the terminal as described in [Initiate Terminal Communications](#).



## Initiate Terminal Communications

1. Boot the terminal to command mode.

For the 35-Key terminal:

- ♦ Press and hold <BKSP> and <SHIFT>.
- ♦ Press and release **PWR**.
- ♦ Release <BKSP> and <SHIFT>.

For the 46-Key terminal:

- ♦ Press and hold <F> and <I>.
- ♦ Press and release <PWR>.
- ♦ Release <F> and <I>.

The terminal displays:

```
COMMAND MODE

Select function
Self test
```

2. Scroll through Command Mode options using **UpArrow** or **DownArrow** until "Program loader" is displayed. Press <ENTER>.
3. The terminal displays:

```
Program loader
WARNING: EEPROM
WILL BE ERASED
CONTINUE? <ENT>
```

Before loading the new application, erase the NVM's original contents.

---

**Note:** *To cancel this operation, press CLEAR.*

---

4. Press <ENTER> to erase the EEPROM.  
Wait while the EEPROM is erased. When complete, the program prompts for the communications parameters.

5. **Baud Rate** - the terminal displays:

Comm Parameters

Baud

4 9600

Scroll through the list using **UpArrow** or **DownArrow**. When the correct rate is displayed (38400 is recommended), press **<ENTER>**.

6. **Data Bits** - the terminal displays:

Comm Parameters

Data Bits

7

Press **<7>** (recommended) or **<8>** to specify data bits, or scroll through the list using **UpArrow** and **DownArrow**. Press **<ENTER>** when the correct value is displayed.

---

**Note:** *If 8 data bits is selected, the program selects "No parity" and skips the next step.*

---

7. **Parity** - if 7 data bits is selected, the terminal displays:

Comm Parameters

Parity

Odd

Press the first letter of a parity option (**Even**, **Odd**, **None**, **Space**, or **Mark**), or scroll using **UpArrow** and **DownArrow** and press **<ENTER>** when the correct value is displayed.

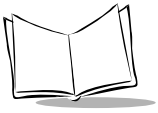
8. **Flow Control** - the terminal displays:

Comm Parameters

Flow Control

None

Press the first letter of a flow control option (**None**, **Xon/Xoff**, or **RTS/CTS**), or scroll using **UpArrow** or **DownArrow** and press **<ENTER>** when the correct value is displayed.



## Starting Communications

1. The terminal is ready to receive the program from the host PC and displays:

```
Comm Parameters
```

```
Start? <ENT>
```

2. Press <ENTER> on the terminal.
3. Press <ENTER> on the host computer. The SENDHEX program begins transmitting the program image. When communications are established, the terminal displays:

```
Program loader
```

```
Receiving: XXXX
```

where XXXX is the program segment address being transferred.

4. When the transmission is complete, the terminal displays:

```
Program loader
```

```
Status 0000
```

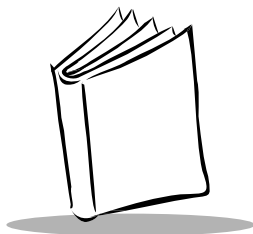
A status of 0000 (all zeros) indicates a successful transfer. Other status values indicate an error. These values are provided in [Appendix C, Communications Status Codes](#).

If you received an error, press **CLEAR** on the terminal to return to the Command Mode main menu.

## Ending Communications

To return to the Command Mode main menu:

1. Press **CLEAR** on the terminal.
2. Power down the terminal.
3. Detach any cables connected to the terminal.
4. Reboot the terminal using the appropriate cold boot sequence. Refer to [Booting the Terminal](#) on page 5-4.



## Chapter 4

# *Spectrum24 RF Terminal Setup*

### **Spectrum24 Terminals**

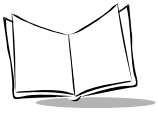
---

In Spectrum24 terminals, wireless connectivity is accomplished using standard communications protocols. Because they are standard, the protocols are generalized and take up considerably more space on the terminal's NVM than is required for Spectrum One<sup>®</sup> terminals. Because there is less space available in NVM for application files, the terminal operates with an additional megabyte of non-volatile memory or *flash disk*. This extra memory is used to reduce not only the boot times but also the time and resources required to load applications into the terminal. The flash disk also offers the possibility of running multiple applications from the same terminal (refer to the *Spectrum24 Setup and Utilities Reference Guide* p/n 72-50795-01 for more information). With version 3.03 or later of the system software (LWP.HEX), the terminal can also run diagnostic tools.

#### **Accessing the Flash Disk**

The flash disk is accessed through a driver, FLASHDSK.SYS, which makes the flash disk appear to a program as another disk drive (E:). The drive has characteristics of fast reading but slow writing (for example, even for the smallest files, the write process takes 3-4 seconds). These characteristics make it ideal for files that are written once, accessed often, and seldom updated.

We recommend that you use the flash disk (E:) mainly for application and configuration file storage. It is important to note that because of the slow writing time (3-4 seconds), writing files during a power interruption (low battery, dead battery, suspend, power off, or power failure) could corrupt the disk. Be sure to only write data to the disk with the terminal connected to external power or with the battery fully charged to avoid problems. To avoid overwriting the flash disk by mistake, the flash disk is set to read-only mode for normal



operation. The software installation or application software takes care of write/read mode switching for you.

## Standard Spectrum24 Software

---

The terminal comes with the system software installed, including:

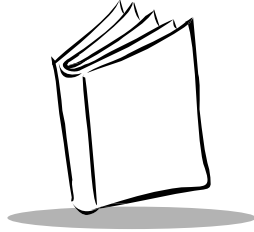
- ◆ Spectrum24 radio drivers
- ◆ TCP/IP software
- ◆ configuration files
- ◆ various utilities.

A BIOS of version 3.08 or later is required.

The default files cover most expected installations/initializations with minor changes as detailed in this chapter.

If your requirements are more advanced, refer to the *Spectrum24 Network Terminal Technical Reference Guide* (p/n 70-20193-XX) for more information on the Spectrum24 RF network, SLAODI.COM, the Symbol-provided ODI driver, and the configuration file setups required for various platforms.

Refer to the *Spectrum24 Setup and Utilities Reference Guide* (p/n 72-50795-XX) for more information on Spectrum24 boot options, addressing, initializing the terminal, and Access Point (AP) associations.



## *Chapter 5*

# *Operating the PDT 6800 Series*

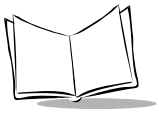
### **Introduction**

---

This chapter describes how to operate a PDT 6800 Series terminal, including:

- ◆ Powering the terminal on and off
- ◆ Booting the terminal
- ◆ PDT 6842 - Switching 802.11 to Spring RF protocol
- ◆ Adjusting the display contrast
- ◆ Entering data using the keyboard
- ◆ Entering data using the scanner
- ◆ Communicating with a PC or printer
- ◆ Communicating on an RF network.





## Powering the Terminal On

---

There are several ways to power on a terminal. Each way lets you resume at the same location in the application where you left off.

---

**Note:** *The PDT 6800 Series terminal always checks for enough battery power for safe operation before it powers on.*

---

## Removing Terminal From a Cradle

The terminal automatically powers on when it is removed from a cradle. While the terminal is in the cradle, the NiCd battery is constantly being charged. If you remove the terminal from the cradle but do not use it right away, press the **PWR** key to turn it off, or let it power off automatically. Refer to the section [Restoring Power After Automatic Shutdown](#) on page 53.

---

**Note:** *The Lithium Ion battery is charged in the UBC 2000 battery adapter p/n 21-32665-24, not in the cradle.*

---

## Keyboard

Your terminal can be programmed to power on from the keyboard by:

- ◆ Pressing the **PWR** key only
- ◆ Pressing any key.

If you press the **PWR** key while the terminal is in the cradle, the terminal powers on. If you leave the terminal in the cradle and press **PWR** to turn the terminal off, it appears to turn off, but is on very low power.

See the *Series 3000 Application Programmer's Guide* for more information on programming your keyboard.

## Real-Time Clock

If the application program allows it, the terminal can be powered on by the real-time clock. This lets the terminal perform unattended operations such as an overnight communication session.

## **Laser Trigger**

If the application program allows, you can power on the terminal by pulling the trigger.

## **Restoring Power After Automatic Shutdown**

The terminal shuts off if you do not use it for an amount of time set by your application. Press the **PWR** key or press the trigger to restore power and return to your application.

## **Powering the Terminal Off**

---

To perform a normal power off, press the **PWR** key or let the terminal shut down automatically as programmed. See your application guide or the section [Restoring Power After Automatic Shutdown](#) for more information. Consult your system administrator if you are unable to power off the terminal.

## **Forcing Power Off**

If pressing the **PWR** key does not turn off the terminal, force the power off to reduce battery drain and preserve your data.

To force power off, press and hold the **PWR** key for 15 seconds, until the terminal powers down.

## **Restarting After a Forced Power Off**

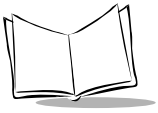
When a terminal is powered off because of software or hardware failure, use the following methods to restart:

- ◆ Use the warm-boot procedure for a software failure.
- ◆ When a warm boot fails, use the cold-boot procedure.
- ◆ If a system software problem in the nonvolatile memory (NVM) occurs, see [Chapter 3, Batch and Spectrum One Terminal Setup](#).

---

**Note:** *Do not use the **PWR** key to restart a terminal when it was forced off due to defective system or application software in the NVM. Pressing the **PWR** key causes the program to resume where it stopped, trying to perform the same unsuccessful operation.*

---



## Booting the Terminal

---

Powering the terminal on does not boot the system or initialize the program or data. To initialize the terminal, perform either a warm boot or cold boot.

### **Warm Boot**

A warm boot resets the operating system while preserving the program and data on the RAM disk. This process is similar to pressing the <Ctrl+Alt+Del> keys on a PC, except that it does not clear the system's memory. To perform a warm boot:

For the 35-Key terminal:

- ♦ Power the terminal off
- ♦ Press and hold <F> and <J>
- ♦ Press and release <PWR>
- ♦ Release <F> and <J>.

For the 46-Key terminal:

- ♦ Power the terminal off
- ♦ Press and hold <4> and <5>
- ♦ Press and release <PWR>
- ♦ Release <4> and <5>.

The terminal displays configuration information, copyright, RAM size, and expanded memory RAM size. Other information displayed depends on the operating system, installed device drivers, and AUTOEXEC.BAT commands. If this warm boot procedure fails to restart the terminal, use the [Cold Boot](#) procedure.

### **Cold Boot**

A cold boot fully resets the system and clears memory, including the RAM disk. Any programs and data stored in memory or on the RAM disk are deleted. Nonvolatile memory (NVM - the Application EEPROM) is not affected. If the cold-boot procedure fails to restart the terminal, see [Chapter 7, Error Recovery and Troubleshooting](#).

### *Caution*

This procedure permanently erases all data and software in the terminal unless they reside in NVM. Contents of RAM are lost.

To perform a cold boot:

For the 35-Key terminal:

- ♦ Power the terminal off
- ♦ Press and hold <SPACE>, <FUNC>, and Up Arrow
- ♦ Press and release <PWR>
- ♦ Release <SPACE>, <FUNC>, and Up Arrow.

For the 46-Key terminal:

- ♦ Power the terminal off
- ♦ Press and hold <A>, <B>, and <D>
- ♦ Press and release <PWR>
- ♦ Release <A>, <B>, and <D>.

The terminal displays version information, copyright, RAM size, and installed expanded memory RAM size. Other information displayed depends on the operating system, installed device drivers, and AUTOEXEC.BAT commands.

## Cold-Boot Failure

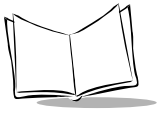
During a cold boot, the system briefly displays a status line for each driver as it loads in the format:

```
0: Driver    #.##
```

The line shows a status value, usually 0, followed by the name and version number of the driver. If the system halts at one of these lines and displays a status value other than 0, the displayed device driver failed to load properly.

If such a failure occurs, try cold booting the terminal again. If this does not solve the problem, call the Symbol Support Center.

More troubleshooting information is provided in the publications listed in [Related Publications](#) on page x.



## PDT 6842 - Switching 802.11 to Spring RF Protocol

After a cold boot, the PDT 6842 boots up with the 802.11 RF protocol. If you are using the Spring RF protocol, do the following to switch from 802.11 to Spring:

1. Cold boot the terminal. The following prompt displays:

```
SOFTWARE UPDATE
Update?[y/n]:
```

2. Within four seconds, type the letter “y”. If you do not type the letter “y” within four seconds, the terminal boots up with the 802.11 RF protocol.

The next prompt displays:

```
RF PROTOCOL UPDATE
OPPORTUNITY
Update RF protocol
[y/n]:
```

3. Within ten seconds, type the letter “y”. If you do not type the letter “y” within ten seconds, the terminal boots up with the 802.11 RF protocol.

The next prompt displays:

```
RF Protocol
Currently 802.11
1. Abort update
2. Make pre-802.11
3. Make 802.11
Select[1,2,3]:
```

4. Select 2 to boot up with the Spring RF protocol.

The next prompt displays:

```
Enter password
→
```

5. Enter the password RFPROT, then press ENTER. The terminal continues to boot up.

The procedure to switch to the Spring RF protocol is complete. If a compatibility problem exists, the terminal pauses with an error message. Contact your System Administrator.

## Boot to Command Mode

Command Mode provides functions for:

- ◆ Running the Self-Test program to verify that the hardware is operating properly (refer to [Chapter 7, Error Recovery and Troubleshooting](#)).
- ◆ Performing a Memory Transfer to upload data from a terminal to a host system (refer to [Chapter 7, Error Recovery and Troubleshooting](#)).
- ◆ Performing a Program Download to transfer an application from the host to a terminal (refer to [Chapter 3, Batch and Spectrum One Terminal Setup](#)).

To boot to Command Mode:

For the 35-Key terminal:

- ◆ Power the terminal off
- ◆ Press and hold <BKSP> and <SHIFT>
- ◆ Press and release <PWR>
- ◆ Release <BKSP> and <SHIFT>.

For the 46-Key terminal:

- ◆ Power the terminal off
- ◆ Press and hold <F> and <I>
- ◆ Press and release <PWR>
- ◆ Release <F> and <I>.

## Adjusting the Display

---

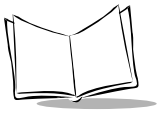
### Display Contrast

The screen's contrast is adjustable to eight levels, making the display more readable in different lighting conditions, at various temperatures, and at different viewing angles.

- ◆ To reduce (lighten) display contrast, press **FUNC Y**.
- ◆ To increase (darken) display contrast, press **FUNC X**.

### Backlighting

The backlight illuminates the display in dimly lit areas.



---

**Note:** Use of backlighting can significantly reduce battery life.

---

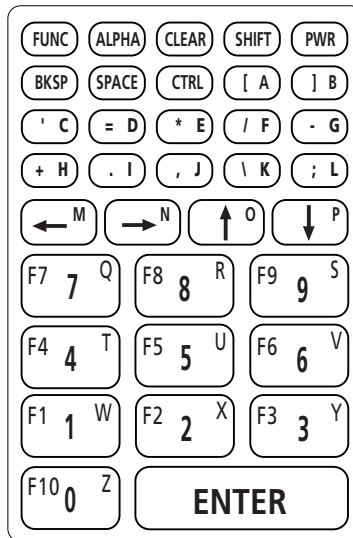
To turn the backlight on or off, press **FUNC** then **L**, or use the key sequence listed in your application guide. The backlight turns off automatically when the terminal is powered off or when the terminal has not been used for an amount of time set by the application. See the *Series 3000 Application Programmer's Guide* for more information.

## PDT 6800 Series Keyboard

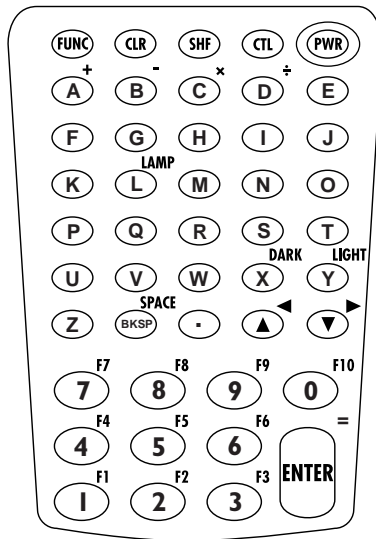
---

The keyboard is used for entering data and issuing commands to the terminal. Figure 5-1 and Figure 5-2 illustrate the standard 35-key and 46-key keyboards respectively. The keys on the keyboard are distinguished as modifier keys and character keys. Because terminal keyboards have fewer keys than PC keyboards, each character key can produce more than the usual one or two characters. The modifier keys, SHF (Shift), CTL, and FUNC, used individually or in combination, determine which character or special function the character keys produce.

Because the keyboard is programmable, your terminal may not work as described here. For more information and illustrations of other keyboard states, see the *Series 3000 Application Programmer's Guide* and your application guide.



**Figure 5-1. 35-Key Keyboard**



**Figure 5-2. 46-Key Keyboard**

## Using the Keyboard

Except during boot operations, the terminal expects the operator to press keys one at a time. If the terminal has been programmed for it (ERR3000 is loaded), and if two or more keys are pressed simultaneously, the terminal indicates a Double-Key.

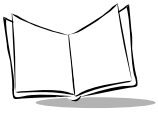
The keyboard also has an optionally configurable auto-repeat function. If the application allows, a character repeats as long as the key is held down. If the key is pressed immediately following a modifier key, the modifier sequence affects only the first occurrence of the character key.

## Modifier Keys

The Shift, Alpha, Function, and Control keys are modifier keys. When pressed individually or in certain combinations, these keys change the keyboard state and possibly the character produced by the character key subsequently pressed. Refer to [Table 5-1](#) for a list of the terminal's special keys.

For example, pressing <FUNC> followed by <CTRL> produces Alt characters, with the same effect as pressing the Alt key on a PC.





To cancel the effect of a modifier key, press it again.

## Keyboard Speed

If your application program allows it, the characters may be set to appear faster or slower. Refer to the *Series 3000 Application Programmer's Manual* for more information.

## Keyboard States

The keyboard states are listed below in the order in which they take priority, unless changed by the application.

- Unshifted
- Shifted
- Function
- Control

The standard cursor shapes for the keyboard states are shown in [Table 6-1 on page 6-2](#).

## Momentary and Locked States

Each keyboard state is either momentary or locked. A momentary state lasts for only the following keystroke. A locked state lasts until the activator key is pressed again.

Only one momentary state can be active at a time. Momentary states always take priority over locked states. If you press several momentary state keys in a row, the system changes to the state of the last key pressed. For example, if you press **SHF**, then **CTRL**, the terminal enters the **CONTROL** state.

The **CTRL**, **SHF**, and **FUNC** keys activate a momentary state. If you press a momentary state key twice in a row, the system enters the state and then cancels it. For example, if you press **SHF**, **SHF**, the terminal is shifted and then immediately unshifted.

When batteries are low, the cursor changes. See **Cursor Indicators**, [Table 6-1 on page 6-2](#).

When an operator ends a momentary state (by toggling it off or by completing the key sequence), the system returns the keyboard to the last active locked state.

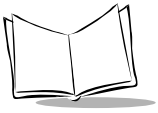
---

**Note:** *Pressing the **FUNC** key does not clear the last momentary state. However, pressing another momentary key after **FUNC** clears the **FUNCTION** state.*

---

**Table 5-1. Special Keys**

Key Name 35-Key	Key Name 46-Key	Description
CTRL (Control)	CTL (Control)	Invokes the control command.
FUNC (Function)	FUNC (Function)	Invokes the function command for certain utilities, such as turning on the back light. <ul style="list-style-type: none"> <li>♦ Press FUNC and the corresponding numeric key to produce function keys F1 to F10.</li> <li>♦ Press FUNC, then to scroll left and FUNC to scroll right.</li> <li>♦ Press FUNC then BKSP to enter a blank space.</li> </ul>
BKSP (Backspace)	BKSP (Backspace)	Erases information entered on the display one character at a time. Information erased this way cannot be recovered. This key is also used to produce a break by pressing CTL, BKSP.
PWR (Power)	PWR (Power)	Turns the terminal on and off.
CLEAR	CLR (Clear)	Partially or completely escapes from an application level or screen. CLR also clears all data typed from the display.
SHIFT	SHF (Shift)	Accesses the shifted keyboard.
ENTER	ENTER	Places entered data into the terminal's memory.
	▲▼	Move the cursor up, down. Press FUNC then ▲ to scroll left; press FUNC then ▼ to scroll right. Arrow key use depends on the application.
↑ ↓		Moves the cursor up, down.
← →		Move the cursor left, right.
ALPHA		Shifts the keyboard to produce alphabetic characters.
SPACE		Places a blank space on a line of the display.



## Scanning

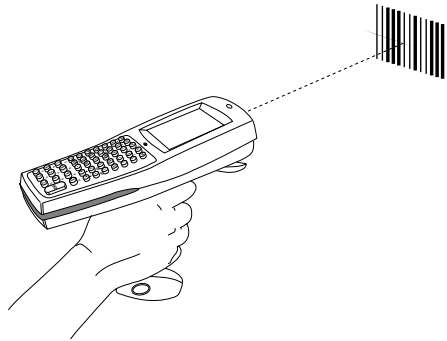
---

The PDT 6800 has an integrated scanner which allows you to collect data by scanning 1 or 2 dimensional bar codes. See [Appendix F, 2D Scanner Drivers and Applications](#) for information on enabling the 2D scanner.

Before scanning can occur, the terminal must be running an application that supports bar code scanning. The terminal must also be programmed to scan the type of bar code you want, such as Universal Product Code (UPC) or Code 3 of 9. For information on scanning applications and on programming the scanner, refer to the *Series 3000 Application Developer's Kit*.

### Scanning 1D Bar Codes

1. Pull the trigger on the handle to power on the terminal and laser scanner. The Scan LED turns red if scanning is enabled and the laser is on.
2. Point the terminal at a slight angle to the bar code and pull the trigger.



**Figure 5-3. Using the Laser Scanner**

3. Ensure that the scan beam crosses all bars and spaces on the 1D bar code symbol, as shown below. Do not hold the scanner directly over the bar code.



4. Hold the scanner farther away for larger symbols, and closer for symbols with bars that are close together. Optimal scanning distance varies with bar code density and scanner optics, but more combinations work within 4 to 10 inches.
5. If the decode is successful, the screen displays the code and the Scan LED turns from red to green. The terminal may also beep.

---

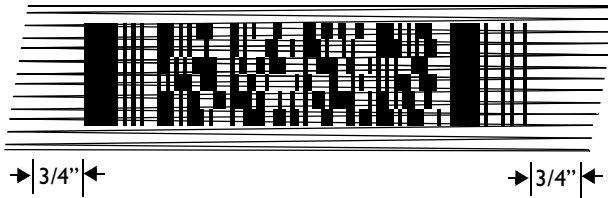
**Note:** *The procedure for your scanner may differ from the one given above. Scanner use depends on the application.*

---

## Scanning 2D Bar Codes

The terminal supports PDF417 bar code scanning. The raster pattern has multiple scanning rows to accommodate the PDF417 symbol's multiple rows.

1. Point the scanner at the bar code and press the trigger.
2. As the raster pattern spreads, keep the pattern in the same horizontal plane as the bar code.



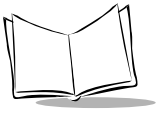
**Figure 5-4. Raster Pattern**

3. If the decode is successful, the screen displays the code and the Scan LED turns from red to green. The terminal may also beep.

---

**Note:** *The procedure for your scanner may differ from the one given above. Scanner use depends on the application.*

---



## “Tall” PDF Bar Codes

If the PDF417 symbol is “tall,” the vertical scan pattern may not be high enough to cover it.

In this case, try a slow “up and down” scanning motion. With the raster pattern open, move the terminal slowly down toward the bottom of the symbol, keeping the beam horizontal to the rows, then slowly back up toward the top.

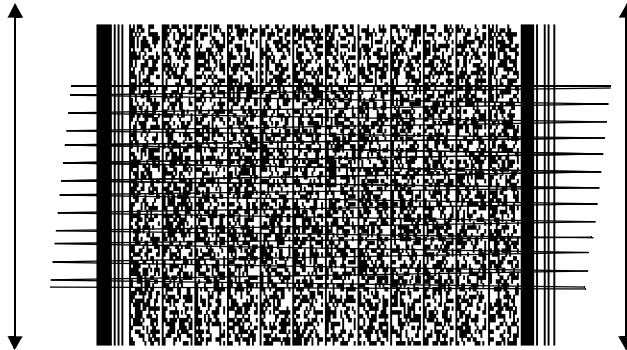


Figure 5-5. Scanning Tall PDF Bar Code

The scan beam does not have to be *perfectly* parallel with the top and bottom of the symbol.

## Scanning Considerations

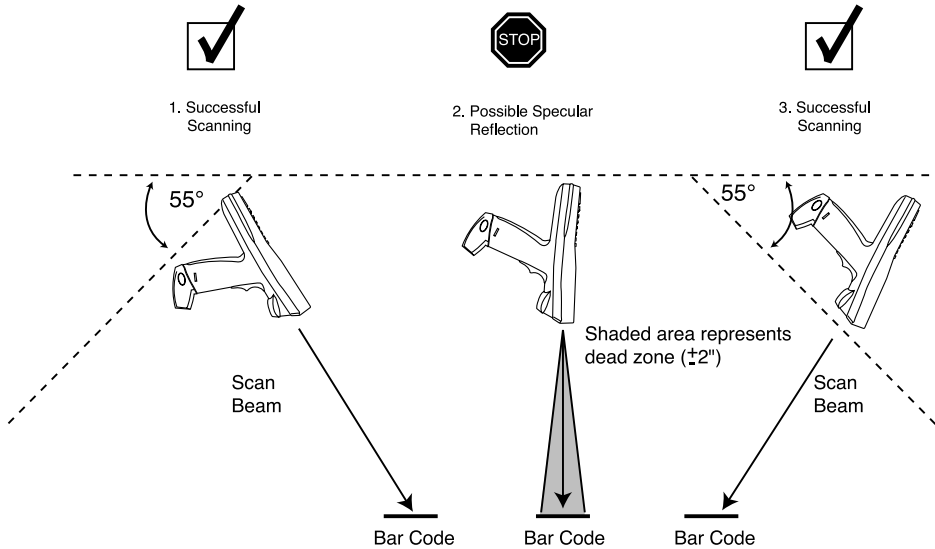
Usually, scanning is a simple matter of aim, scan, and decode, and a few quick trial efforts master it simply and intuitively. However, two important considerations can optimize any scanning technique — angle and range.

### Aiming: Hold at an Angle

Do not hold the terminal’s scan window directly over the bar code.

Laser light reflecting directly back into the scan window from the bar code is known as specular reflection. This strong light can “blind” the scanner and make decoding difficult. The area where specular reflection occurs is known as a “dead zone”.

You can tilt the terminal up to 55° forward or back and achieve a successful decode. Practice quickly shows what tolerances to work within.



**Figure 5-6. Scanning Angle and Specular Reflection**

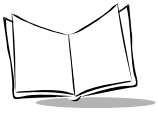
## Range

Any scanning device decodes well over a particular working range — minimum and maximum distances from the bar code. This range varies according to bar code density and scanning device optics.

Scanning within range brings quick and constant decodes; scanning too close or too far away prevents decodes. You need to find the right working range for the bar codes you are scanning. The best general advice is:

- ◆ Hold the scanner farther away for larger symbols.
- ◆ Move the scanner closer for symbols with bars that are close together.
- ◆ Start scanning at a distance from the bar code, not from direct contact. If the bar code does not readily decode, move the scanner in closer.

Practice quickly shows what distances to work within.



## Running Communications

---

### Communicating With a Host

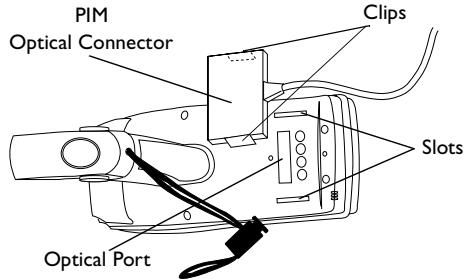
To communicate with a host:

1. Set up the CCM 38/6860, CRD 38/6865 cradle, CRD 38/6866 cradle, or the PC adapter as described in [Chapter 2, Accessories Setup](#).
2. If using a cradle, place the terminal in the CCM or cradle.
3. Start the communications program on the host and terminal.

### Communicating With a Printer

To communicate with a printer, attach the terminal to the Printer Interface Module (PIM):

1. Attach the PIM's optical connector to the terminal's optical port by inserting the clips on the connector in the slots on either side of the port.
2. Plug the PIM's DB-9 connector in the printer's port.
3. Power the printer and terminal on.



**Figure 5-7. Connecting the PIM to the PDT 6800 Series**

### Radio Communications

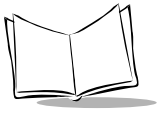
The PDT 6810 operates in a Symbol Spectrum One<sup>®</sup> RF network; the PDT 6840 Series operates in a Symbol Spectrum24<sup>®</sup> RF network.

The terminal's Status LED indicates the state of the 6800's connection to either of the RF networks:

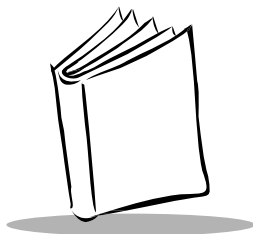
<b>Off</b>	indicates that the radio is working and associated with an access point (Spectrum24) or base station (Spectrum One).
<b>Flashes red once per second</b>	indicates that the radio is out of range or not associated with an access point or base station.

Refer to the network documentation for more information on operating the terminal in the specific RF environment.





*PDT 6800 Series Product Reference Guide*



## Chapter 6

# Maintaining the Terminal

### Batteries

---

The PDT 6800 Series terminal is powered by a rechargeable Nickel Cadmium (NiCd) or Lithium Ion battery pack. Fully charged, the battery pack provides up to 8 hours of continuous operation.

The NiCd battery pack is charged by:

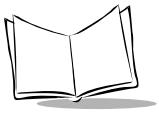
- ◆ placing a terminal with the battery installed in a CCM 38/6860, CRD 38/6865, or CRD 38/6866 cradle for 7 hours, or
- ◆ connecting the terminal to a PC Adapter, or
- ◆ placing the battery pack in a spare battery charging slot on the CCM 38/6860 or CRD 38/6865 for up to 7 hours.

---

**Note:** *The terminal can be used while the battery is being charged in the CCM 38/6860 or connected to the PC Adapter.*

---

The Lithium Ion battery pack p/n 21-40340-01 is charged by removing the battery from the terminal and charging in a UBC 2000 battery adapter p/n 21-32665-24. Refer to the *UBC 2000 Quick Reference Guide* for more information.



## Battery Life

Battery life is affected by many factors, including











- ◆ scanning
- ◆ radio communications
- ◆ very high or very low operating temperatures
- ◆ backlighting use
- ◆ battery age.

## When to Replace or Recharge the Battery

The PDT 6800 Series terminals provide two types of indicators to notify you when battery power is running low: warning messages and modified cursors. These indicators may be changed or disabled by an application.

- ◆ **LOW BATTERY** - When the battery is low, the cursor changes as shown in [Table 6-1 on page 6-2](#). If ERR3000 is loaded, the message LOW BATTERY also appears. At this level the terminal continues to operate, but there is probably less than 1 hour of usable power left.
- ◆ **VERY LOW** - When the power is very low, the DEAD BATTERY message appears and the system powers off. Replace or recharge the battery pack before attempting to use the terminal. If the battery is not immediately recharged or replaced, data may be lost.

**Table 6-1. Cursor Indicators**

Keyboard State	Cursor Character	Low Battery
Unshifted	 (inverted caret)	 (inverted solid caret)
Shifted	 (caret)	 (solid caret)
Momentary Shifted	 (up arrow)	 (solid up arrow)
Momentary Unshifted	 (down arrow)	 (solid down arrow)
Control	<u>C</u> (underline c)	 (inverse c)
Function	<u>f</u> (underlined f)	 (inverse f)

## Backup Batteries

To prevent data loss during battery replacement, the terminal utilizes a super cap as a backup. The super cap provides sufficient power to preserve memory contents for approximately 15 minutes while the primary battery is replaced. The super cap does not provide enough power to operate the terminal. On receiving a low battery message, replace or recharge the primary battery immediately.

## Replacing the Battery Pack

---

Battery packs available from Symbol are listed below.

System	P/N	Battery Pack
NiCd Six-cell, 600 mAh IS	21-36474-01	Intrinsically safe rechargeable in CCM 38/6860, CRD 38/6865, CRD 38/6866, and PC adapter
Lithium Ion	21-40340-01	Rechargeable in UBC 2000 battery adapter p/n 21-32665-24

---

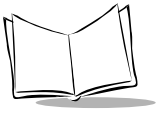
**Note:** *The Series 3800 NiCd battery packs, 3872-103, 3872-105, and 3872-115, CANNOT be used in the Series 6800 terminal.*

---

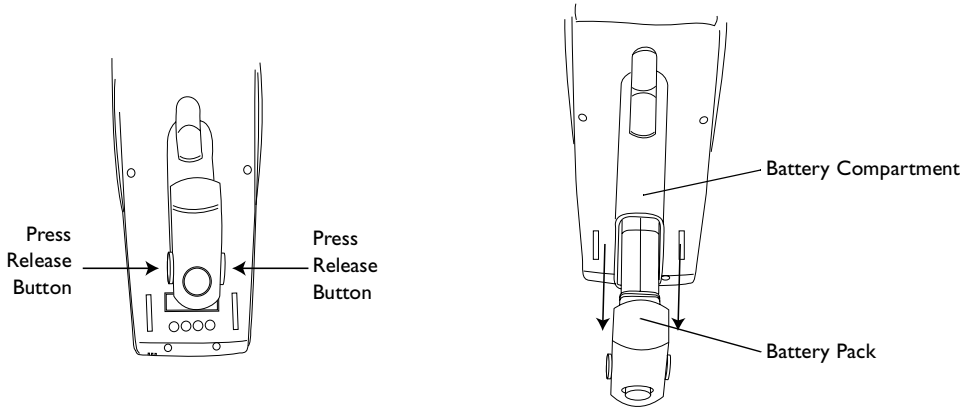
## Removing the Battery Pack

To remove the battery pack ([Figure 6-1](#)):

1. Power the terminal off.
2. Press the battery release buttons on both sides of the handle.



3. Slide the battery pack out of the handle.

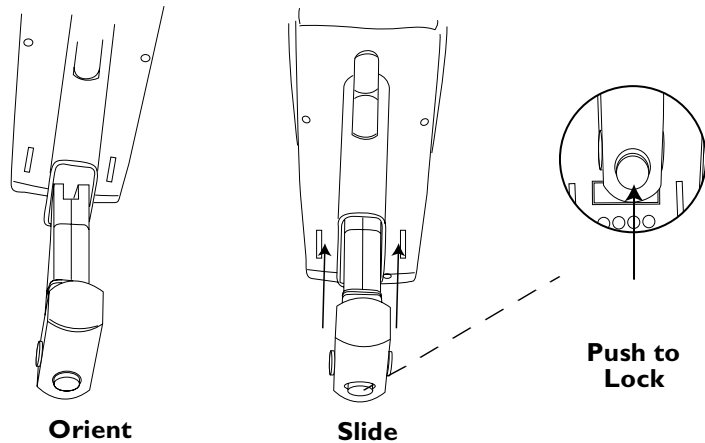


**Figure 6-1. Removing the Battery Pack**

If you intend to store your terminal without the battery pack, ensure that you have stored any data and/or programs you wish to keep on another terminal, a host computer, or another medium to avoid loss of data. The terminal backup power source retains data for approximately 15 minutes after the battery pack is removed, as long as the backup batteries remain in place.

### ***Installing the Battery Pack***

1. Orient the battery pack with the handle facing the terminal's scan window ([Figure 6-2](#)).
2. Slide the pack into the battery compartment while pressing the battery release buttons.
3. Press the battery lock in to secure.



**Figure 6-2. Installing the Battery Pack**

## **Battery Charging Tips**

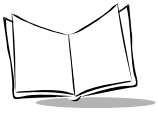
For maximum capacity and battery life, follow these helpful hints:

### **Do**

- ◆ Charge at temperatures between 0°C and 38°C (32°F to 100°F); 21°C (70°F) is preferred
- ◆ Recharge as soon as you see the “Low Battery” message
- ◆ Save your data and program on another terminal or another medium if you plan to store your terminal without the primary battery pack
- ◆ Store batteries at room temperature of 21°C (70°F) or cooler
- ◆ Recharge the NiCd battery pack after storage.

### **Don't**

- ◆ Store or recharge primary batteries at temperatures below 0°C (32°F) or above 38°C (100°F)
- ◆ Judge a battery's charge level by measuring its voltage; voltage does not indicate charge level.



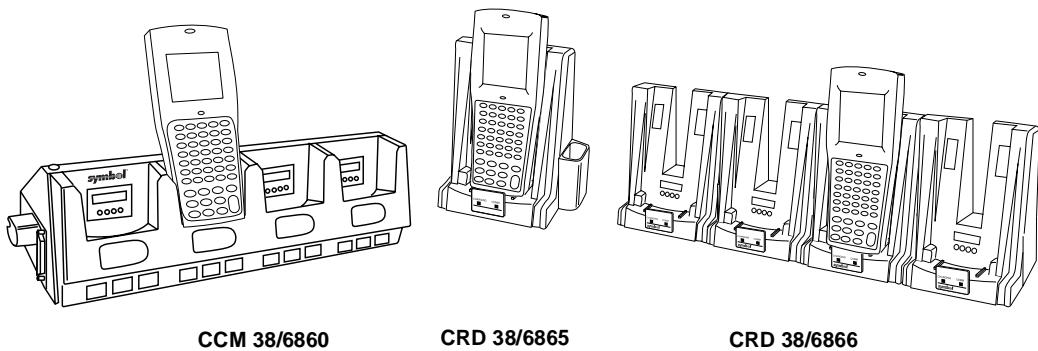
## Charging the NiCd Battery Pack

The NiCd battery pack automatically charges when the terminal is placed in a cradle or connected to a PC Adapter. A full charge takes about 7 hours. We recommend that you always keep the NiCd battery pack fully charged.

### Charging NiCd Battery pack in the Terminal Using a Cradle

To charge a NiCd battery in the terminal, using the CCM 38/6860, CRD 38/6865, or CRD 38/6866 cradle ([Figure 6-3](#)):

1. Place the terminal in the cradle. The cradle charging light flashes when charging a discharged battery and remains steady when trickle-charging a charged battery.



**Figure 6-3. Charging the Battery in the Cradle**

2. Leave the terminal up to 7 hours to recharge a fully discharged battery.

### Charging NiCd Battery Packs Outside the Terminal

Slots are provided in the CCM 38/6860 and CRD 38/6865 cradles to charge spare battery packs outside the terminal.

Place the battery pack to be charged in one of the battery slots in the cradle. The LED indicator lamp under the battery slot in which the terminal was placed indicates the battery is charging. (On the CCM 38/6860, the spare-battery-charging indicator lamp is on the right.) If the lamp is off, the battery pack is not charging. A blinking LED indicates fast charge; a solid on LED means slow charge/ready. See the cradle documentation listed in [Related Publications](#) on page x for details.

### *Caution*

The optional communications cradles are NOT certified for use in potentially hazardous environments. To charge an intrinsically safe PDT 6800 Series terminal in a cradle, remove the terminal from the potentially hazardous environment before charging.

### **Battery Charging with the PC Adapter**

Refer to [Chapter 2, Accessories Setup](#), for instructions on setting up the PC Adapter for charging.

Battery charging begins automatically when power is supplied to the PC Adapter. Fully charging a battery using the PC Adapter requires 7 hours.

### **Other Charging Options**

You have the option of charging battery packs in the UBC 1000 or 2000 Charger. Refer to the documentation for the charger for more information.

### **Charging the Lithium Ion Battery Pack**

---

*Note: Placing the terminal in the cradle with a Lithium Ion battery installed does not damage the battery.*

---

The Lithium Ion battery does not charge when the terminal is placed in a cradle. Use the cradle for communications and as a place holder for the terminal when a lithium Ion battery is installed.

To charge the Lithium Ion battery p/n 21-40340-01, remove the battery from the terminal and charge in a UBC 2000 battery adapter p/n 21-32665-24. Refer to the *UBC 2000 Quick Reference Guide* for more information.

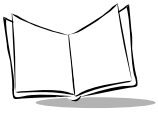
### **Cleaning**

---

The PDT 6800 Series terminals require a minimum amount of maintenance. However, keep the terminal clean to avoid problems and prolong the terminal's life.

Before doing any maintenance or cleaning, power the terminal off.





To clean a terminal, use a clean, soft cloth dampened with a mild cleaner such as soap and water. Do not use abrasive paper, cloth, or abrasive/corrosive cleaners.

Wipe the entire terminal, except for the scanner window, with the damp cloth. Clean the charging contacts, keypad, and scanner trigger.

Wipe the scanner window periodically with a lens tissue or other material suitable for cleaning optical material such as eyeglasses.

Do not pour, spray, or spill any liquid on any part of the terminal, particularly the scanner or scan element components.

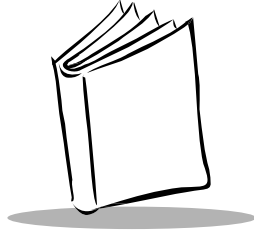
## **Storage**

If the terminal will not be used for a while, store it in a cool, dry place, away from dust. For the best protection, repack the terminal in the original shipping container for storage.

### *Caution*

If you remove the primary battery, the terminal maintains memory contents for at least 15 minutes. To prevent loss of programs and data, transmit them to a host computer before removing the primary batteries for longer than 15 minutes.

When you remove the terminal from storage without the battery pack, reset the real time clock. Refer to the *Series 3000 Application Programmer's Reference Manual* or *Series 3000 Application Programmer's Guide* for specific instructions.



## *Chapter 7*

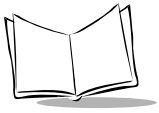
# *Error Recovery and Troubleshooting*

### **Introduction**

---

This chapter provides information to assist in basic troubleshooting analysis and correction, including:

- ◆ Error messages
- ◆ Troubleshooting start-up failures
- ◆ Troubleshooting Spectrum24 terminal initialization failures
- ◆ Running the Self Test function
- ◆ Self Test summaries
- ◆ Keyboard test
- ◆ Running memory transfer.
- ◆ Scanning problems



## Error Messages

---

If ERR3000 is loaded in the system configuration, the terminal displays the following messages to indicate error conditions that affect system performance. A message is usually accompanied by one or more beeps, after which the system returns to its previous status.

The application can change the actual wording of the messages or disable messages. The messages listed in [Table 7-1](#) are representative. Refer to the *Series 3000 Application Programmer's Guide* or your application guide for additional information.

**Table 7-1. Error Messages**

Message	Explanation
Double Key Error	Two or more keys were pressed at the same time. This does not include boot sequences described in <a href="#">Chapter 5, Operating the PDT 6800 Series</a> .
Low Battery	The battery pack should be recharged or replaced as soon as possible.
Dead Battery	Replace or recharge the battery pack immediately. This message is programmable, so it may be worded differently. See your application guide. After this message is displayed, the terminal shuts itself off. You may not be able to power it on again until the battery pack is charged.
Power Fault	The last terminal power off was caused by a power failure. Possible causes of a power failure include: <ul style="list-style-type: none"><li>• the battery pack is removed with the terminal on</li><li>• the terminal is dropped</li><li>• the batteries lose power suddenly</li><li>• the terminal displays a low battery power error message, and you attempt to power the terminal on without recharging or replacing the batteries.</li></ul>

## Troubleshooting

---

Table 7-2 lists some minor problems, causes, and actions to take. If you cannot resolve the problem after checking this list, call the Symbol Support Center for assistance.

**Table 7-2. Troubleshooting the Terminal**

Symptom	Possible Cause	Action
Display is blank.	Battery pack is dead or missing.	Replace or recharge battery pack.
Terminal does not respond when keys are pressed.	Application program was not successfully downloaded.	Repeat downloading.
Time and date are incorrect.	Real-time clock has malfunctioned or needs setting.	Set time and date. See your application guide.

### Startup Failure

Problems are most frequently start-up failures. If cold booting the terminal does not start the application successfully, the application, the system software, or the system is malfunctioning. If you can boot the system to Command Mode, try the following:

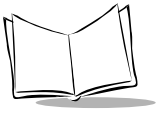
- ◆ Use Program Loader to download a new version of the software to NVM. This procedure is described in [Chapter 3, Batch and Spectrum One Terminal Setup](#) or [Chapter 4, Spectrum24 RF Terminal Setup](#). After downloading new software, warm boot the terminal as described in [Chapter 5, Operating the PDT 6800 Series](#).
- ◆ Use Self Test to check whether system hardware is operational. The SelfTest procedure is described later in this chapter. After downloading new software, warm boot the terminal as described in [Chapter 5, Operating the PDT 6800 Series](#).

### Boot Failure Messages

During a cold boot, the system briefly displays a status line for each driver as it loads, in the format

```
0:Driver  #.##
```

The line shows a status value, usually 0, followed by the name and version number of the driver. If the system halts at one of these lines and displays a status value other than 0, the displayed driver did not load properly.



If such a failure occurs, cold boot the terminal again. If this does not solve the problem, call Symbol Customer Support.

More troubleshooting information is found in the documentation listed in [Related Publications](#).

## Spectrum24 Terminal

Typical initialization and operating problems and solutions for Spectrum24 terminals are listed in [Table 7-3](#).

**Table 7-3. Troubleshooting Spectrum24 Terminal s**

<b>Problem</b>	<b>Explanation/Action</b>
Out of range	Terminal is out of the Access Point's range. If you move the terminal during initialization, the terminal may be out of range of the AP and unable to complete the initialization process. Move back in range and repeat the initialization process.
Startup process fails	Boot server type (BOOTP or DHCP) doesn't exist. Verify that the boot server is operating and able to respond to TCP/IP, BOOTP, or DHCP requests from the terminal.
Low battery message	Place the terminal in a cradle and recharge battery. <b>OR</b> Power terminal off and replace battery.
Battery is dead	Battery not replaced after receiving low battery message or terminal left on for more than 24 hours. Recharge or replace the battery.
Terminal disassociated from Access Point	Application does not respond to interactive operations. Applications using internal batch mode continue to function until required to transmit via radio, then fail to work. No message displayed.

## Self Test Function

---

Command mode includes a SelfTest function which verifies that terminal hardware components are operating properly. Components tested include:

- ◆ Real-time clock (RTC)
- ◆ Battery power
- ◆ Keyboard codes
- ◆ Liquid crystal display (LCD) controller
- ◆ Read-only memory (ROM), random-access memory (RAM), expanded memory (EMS), and non-volatile memory (NVM).

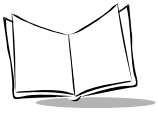
Run Self Test if you suspect a problem with the hardware. Except for keyboard testing, no operator input is necessary after selecting a test screen.

### **Running Self Test**

Access the Self Test function from the Command Mode Menu:

1. Boot to Command Mode (refer to [Chapter 5, Operating the PDT 6800 Series](#) for boot sequence).
2. In the Command Mode Main Menu, use the **UpArrow** or **DownArrow** to scroll through the options.
3. Highlight **Self Test** and press **<Enter>**.

Press **<CLR>** in any SelfTest screen to return to the SelfTest screen, or from the SelfTest screen to return to the Command Mode screen.



## **Self Test Summaries**

Self test is divided into five functions or screens:

**Config Screen 1** - Reports the terminal series, BIOS version, battery status, and current power source.

**Config Screen 2** - Reports information on the keyboard and display, including power wakeup source.

**Memory Screen** - Tests ROM, RAM, and EMS (Expanded) memory, and reports the amount of installed RAM and EMS.

**Fill Screen** - Fills the entire screen with a test pattern to verify that the entire screen displays.

**Set RTC Screen** - Sets the time and date settings of the real-time clock.

## **Keyboard Test**

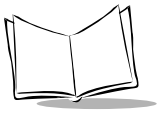
Keyboard testing can be performed while the terminal displays Config Screen 1 results.

Test any keys except <CLEAR> and <PWR>. When you press a key, the corresponding key code is displayed on the top row to the right of the test name. [Table 7-4](#) lists the codes for the 35-key keyboard and [Table 7-5](#) lists the codes for the 46-key keyboard.

**Table 7-4. 35-Key Keyboard Test Codes**

Key	Test Code	Key	Test Code
SPACE	00	L	19
ALPHA	01	M	20
CTRL	02	N	21
FUNC	03	O	22
BKSP	04	P	23
SHIFT	07	Q	24
A	08	R	25
B	09	S	26
C	10	T	27
=	11	U	28
E	12	V	29
F	13	W	30
G	14	X	31
H	15	Y	32
I	16	Z	33
J	17	ENTER	34
K	18		



**Table 7-5. 46-Key Keyboard Test Codes**

Key	Test Code	Key	Test Code	Key	Test Code
FUNC	01	M	17	Period	32
SHF	02	N	18	Up arrow	33
CTL	03	0	19	Down arrow	34
A	05	P	20	7	35
B	06	Q	21	8	36
C	07	R	22	9	37
D	08	S	23	4	38
E	09	T	24	5	39
F	10	U	25	6	40
G	11	V	26	1	41
H	12	W	27	2	42
I	13	X	28	3	43
J	14	Y	29	0	44
K	15	Z	30	ENTER	45
L	16	BKSP	31		

If numbers other than those given in the tables appear on the display, please contact your authorized representative. Press <CLEAR> to terminate the test and return to the Self Test screen.

## Memory Transfer Program

---

Command Mode includes a memory transfer utility that transfers data from a terminal to a host PC for program troubleshooting. Programmers can analyze an application using tools provided in the Series 3000 Application Development Kit and described in the *Series 3000 Application Programmer's Reference Manual*.

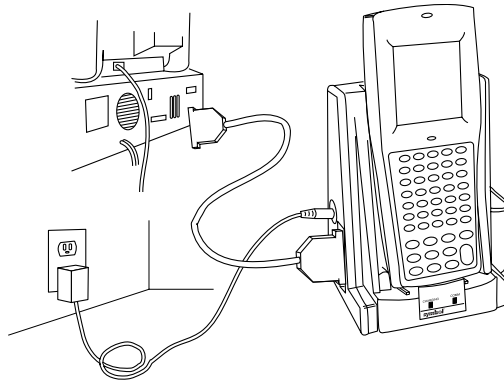
## Hardware Setup

1. Turn off the terminal and host PC. Disconnect or unplug the cradle, if used.

### Caution

Always power off the terminal before attaching or removing cables and adapters.

2. Connect an RS-232 null modem cable to the PC's serial port.



**Figure 7-1. MemoryTransfer Connections**

3. Connect the other end of the cable to the cradle's communication port.
4. Connect the cradle to a power source.
5. Place the terminal in the cradle.
6. Power on the host PC.

## Set Communications Parameters

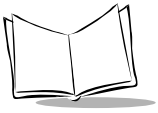
### Host

1. Start the communications program on the host PC.
2. Set up the host communication parameters (these parameters must match the terminal's parameters). At the DOS prompt on the host, enter:

```
RCVHEX <filename.hex> <baud rate> <comport#>
```

Typical parameters are:

38400 bps	Odd parity
7 bit data	Xon/Xoff flow control



## Terminal

1. Boot the terminal to Command Mode (refer to [Chapter 5, Operating the PDT 6800 Series](#) for the appropriate key sequence).
2. Select the Memory Transfer function from the Command Mode menu. Use **UpArrow** or **DownArrow** to scroll through the Command Mode options until Memory Transfer is displayed, then press **<ENTER>**.
3. Select the range of memory to transfer by pressing the first letter of the desired range (**All**, **Range**, or **None**), or use the **UpArrow** or **DownArrow** and press **<ENTER>**.  
If you select **All**, the program skips to the range verification screen (step 7, [page 10](#)).

If you select **Range**, the screen displays:

```
RAM
Use Arrow Keys
Start      End
00000     9FFFF
```

4. Specify a range of RAM by setting the Start and End addresses.
  - ♦ Use **RightArrow** and **LeftArrow** to move the cursor to the digit to be changed
  - ♦ Use **UpArrow** and **DownArrow** to change the values.Type a range and press **<ENTER>**.
5. Specify a range of NVM to transfer. Choose **All** or **None**.
6. If the system has EMS installed, it prompts for the range to transfer; otherwise, it skips this screen:

```
EMS

Use arrow keys
Start      End
```

The range is specified in page numbers (16 KB per page). Use **RightArrow** and **LeftArrow** to move between the Start and End values. Use **UpArrow** and **DownArrow** to change the page number value.

Set the range and press **<ENTER>**.

7. The terminal displays a range verification screen. For example:

```
RAM  0000  3FFF
NVM  D510  DFFF
```

```
EMS 0000 010  
Correct? <ENT>
```

If the values are correct, press <ENTER>. If the values are not correct, press <CLEAR> to clear the fields and select new values.

8. Specify the baud rate. Use the **UpArrow** and **DownArrow** to scroll through the list of baud rates until the correct rate is displayed and press <ENTER>.

---

**Note:** *Flow control may be necessary at 38400 bps and higher.*

---

9. Specify the data bits. Press <7> or <8>, or use **UpArrow** and **DownArrow** to display the values 7 or 8, and press <ENTER>.

---

**Note:** *If you select 8 data bits, the program selects No parity and skips the next screen.*

---

10. Specify parity type. Use **UpArrow** and **DownArrow** to display a parity option, or press the first letter of a parity option (Even, Odd, None, Space, or Mark) and press <ENTER>.
11. Set flow control. Use **UpArrow** and **DownArrow** to display the flow control options, or press the first letter of an option (None, Xon/Xoff, or RTS/CTS) and press <ENTER>.

## Start Communications

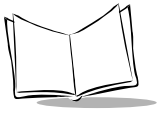
1. The terminal is ready to send the data to the host PC and displays:

```
Comm Parameters  
  
Start? <ENT>
```

2. Verify that the host is ready to receive data.
3. Press <ENTER> on the terminal.

While data is being transferred, the terminal displays a report of the 1 KB range being transferred:

```
Memory Transfer  
  
Sending: XXXX
```



The display is updated for every 1024 bytes (1 KB) of memory.

4. When the transmission completes or aborts, the terminal displays the transmission status screen:

```
Memory Transfer
```

```
Status 0000
```

A status of 0000 (all zeros) indicates that the transfer was successful. Any other status indicates failure. Refer to [Appendix C, Communications Status Codes](#), for the status codes which indicate the source of the error.

## End Communications

To return to the Command Mode Main Menu, press <CLEAR>. Take whatever corrective action is necessary and reboot the terminal.

## Internal Modem Problems

---

If you are having difficulties with your internal modem, please check the following before returning your product:

- ◆ Connection to the telephone network is correct.
- ◆ Any necessary special requirements such as dialing 9 and ignoring dial tone have been considered in the event of using a PBX.
- ◆ Firmware settings described in the Series 3000 Application Programmer's Guide have been configured correctly.

## Scanning Problems

---

### What If...

*Nothing happens when you follow the operating instructions?*

- ◆ Check the system power.
- ◆ Verify that the scanner is programmed to read the symbology you are trying to read.
- ◆ Try scanning a test symbol of the symbology you are trying to read.
- ◆ Check the bar code to ensure that it is not defaced. A defaced bar code may not be readable.

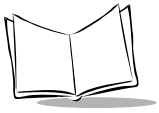
- ◆ Check to see that you are scanning from the proper distance.

*Your terminal operates but scanned data is not displayed correctly?*

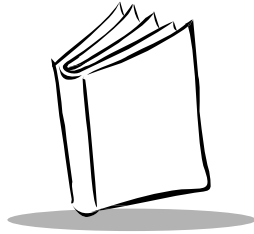
- ◆ Check the system power.
- ◆ Check that the communications parameters (baud rate, parity, stop bits, etc.) are set properly for the receiving device.

*The laser does not activate?*

- ◆ You may have exceeded the allowable amount of scanning activity within the limits of your laser class of operation; in this case, wait for a short interval before scanning again.
- ◆ You may be scanning in an inappropriately hot environment. If so, remove the equipment from the environment or allow the laser to cool down.



*PDT 6800 Series Product Reference Guide*



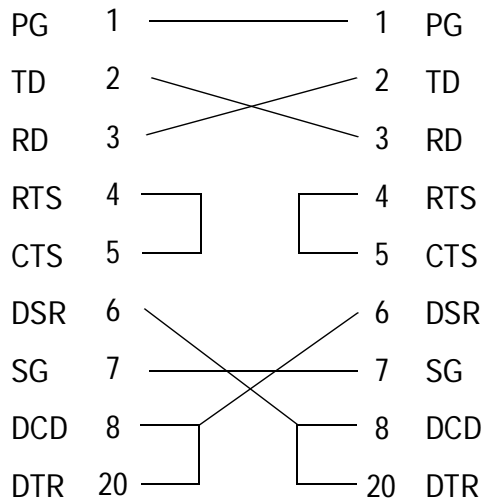
## *Appendix A*

### *Null Modem Pin-outs*

#### **Null Modem Pin-Outs for Full Duplex**

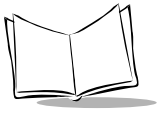
---

Use the pin-outs shown in [Figure A-1](#) for null modem communication.



**Figure A-1. Null Modem Pin-Outs - Full Duplex**

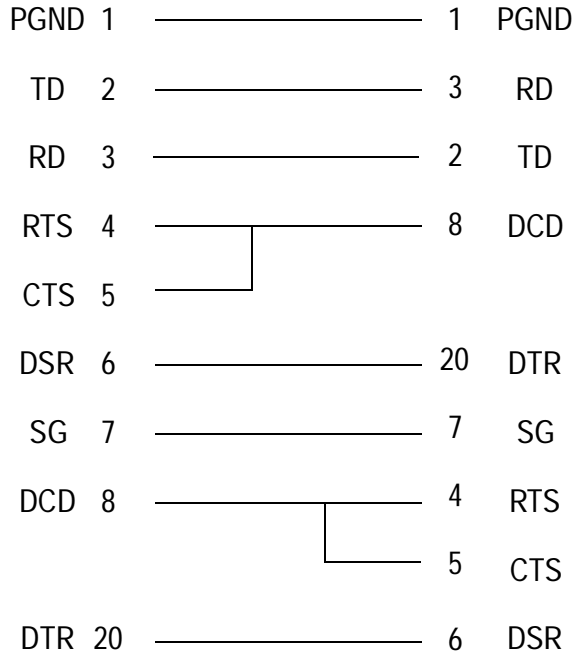




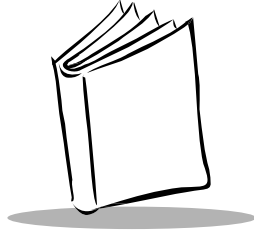
## Null Modem Pin-outs for Half-Duplex

---

Use the pin-outs shown in [Figure A-2](#) for testing.



**Figure A-2. Null Modem Pin-Outs - Half Duplex**



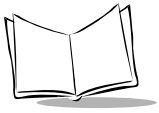
## *Appendix B*

### *Keyboard Layouts*

#### **Introduction**

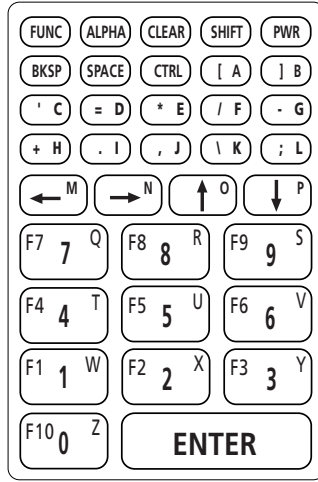
---

The following pages show the characters and character sequences produced by the 35-key and 46-key PDT 6800 Series keyboard when modified with the key sequence in the figure caption. For instance, [Figure B-4](#) shows what characters the keys produce when you press the Alpha key first.

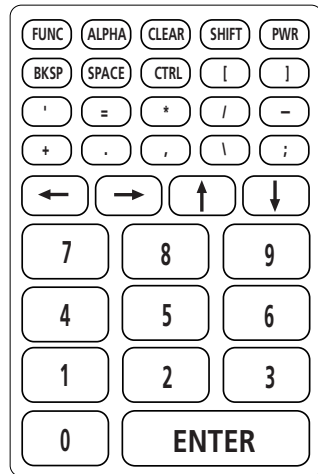


## 35-Key Keyboard

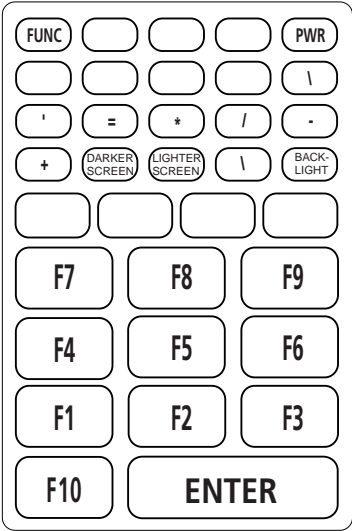
Key definitions can be changed by the application program. The captions indicate what sequence of modifier keys produce the keyboard.



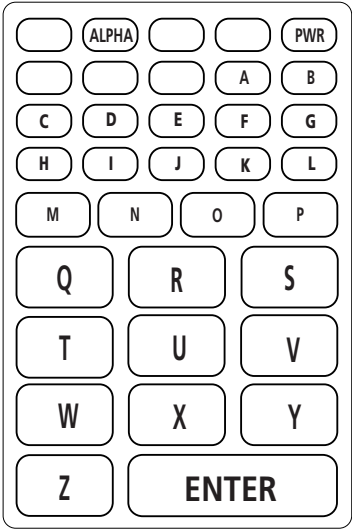
**Figure B-1. 35-Key PDT 6800 Series Keyboard**



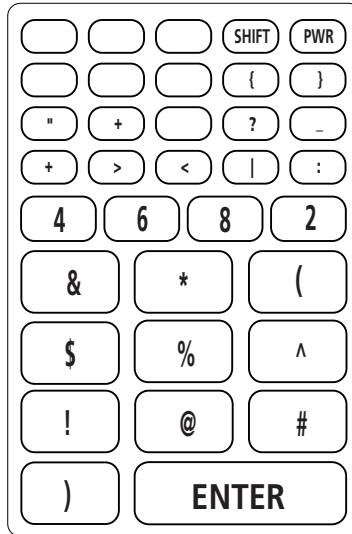
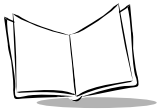
**Figure B-2. 35-Key Unmodified Keyboard**



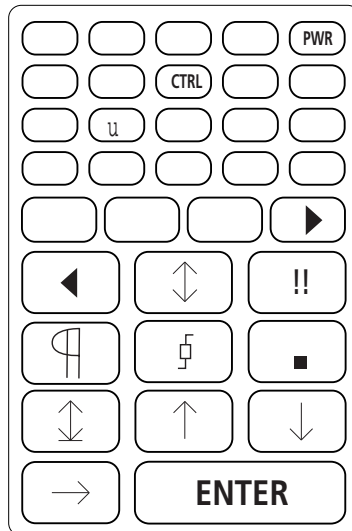
**Figure B-3. 35-Key Function Key Modified Keyboard**



**Figure B-4. 35-Key Alpha Key Modified Keyboard**



**Figure B-5. 35-Key Shift Key Modified Keyboard**



**Figure B-6. 35-Key Control (CTRL) Key Modified Keyboard**

# 46-Key Keyboard

Key definitions can be changed by the application program. The captions indicate what sequence of modifier keys produce the keyboard.

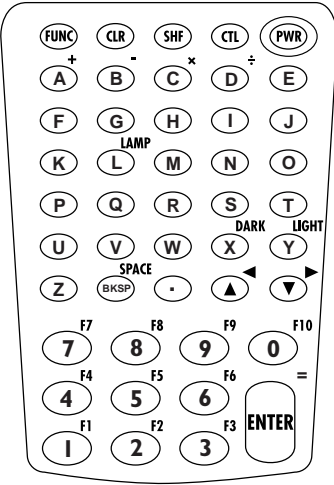


Figure B-7. 46-Key PDT 6800 Series Keyboard

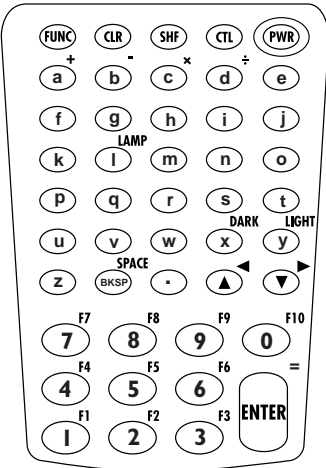


Figure B-8. 46-Key Unmodified Keyboard

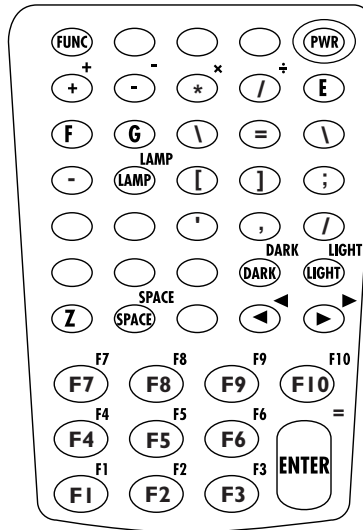
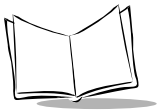


Figure B-9. 46-Key Function Key Modified Keyboard

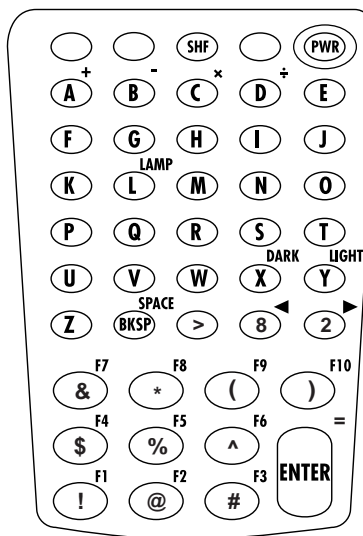


Figure B-10. 46-Key Shift Key Modified Keyboard

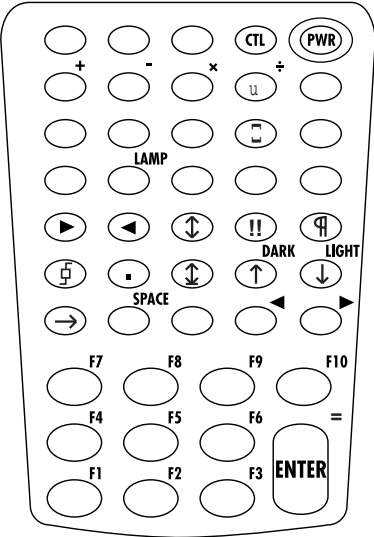
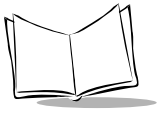
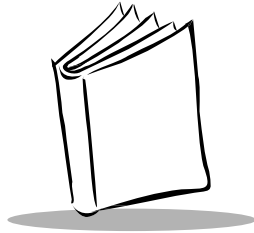


Figure B-11. 46-Key Control (CTL) Key Modified Keyboard





*PDT 6800 Series Product Reference Guide*



## *Appendix C*

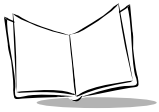
# *Communications Status Codes*

### **Introduction**

---

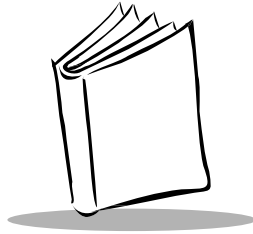
The program loader status code consists of four hexadecimal digits which indicate whether or not the transfer was successful, and if not, the source of the communications error. A status code of 0000 indicates success; any other code indicates failure.

[Table C-1](#) lists the failures associated with the status codes. The values are additive.



**Table C-1. Communications Status Codes**

Status Code	Meaning
0002	Receive overrun error
0004	Receive parity error
0008	Receive framing error
0010	Programming voltage not present
0020	Data Set Ready or Carrier Detect not detected on open
0040	Lost DSR while receiving
0080	ABORT key hit during comm
0100	Insufficient NVM for image
0200	Illegal Intel hexadecimal record
0400	Unsupported Intel record
0600	NVM EEPROM failed to erase
0800	Receive time-out error
1000	Control start character time-out
2000	Clear To Send inactive time-out error
4000	Receive buffer full



## Appendix D Specifications

### Environment

---

The terminal's operating conditions are listed in [Table D-1](#).

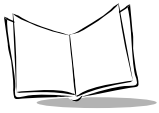
**Table D-1. Environmental Specifications**

Condition	Range
Operating Temperature	-13°F to 122°F (-20°C to 50°C)
Storage Temperature	-13°F to 140°F (-20°C to 60°C)
Humidity (Operating)	95% relative humidity, noncondensing
Altitude	Up to 10,000 feet
Electrostatic	Up to 15 KV discharge to all surfaces (terminal power may go off)
Shock	Withstands multiple 4-foot drops to concrete without malfunction or loss of data

---

**Note:** *Batteries lose power faster at extremely high and low temperatures.  
The LCD operates slowly at temperatures below 0°C.*

---

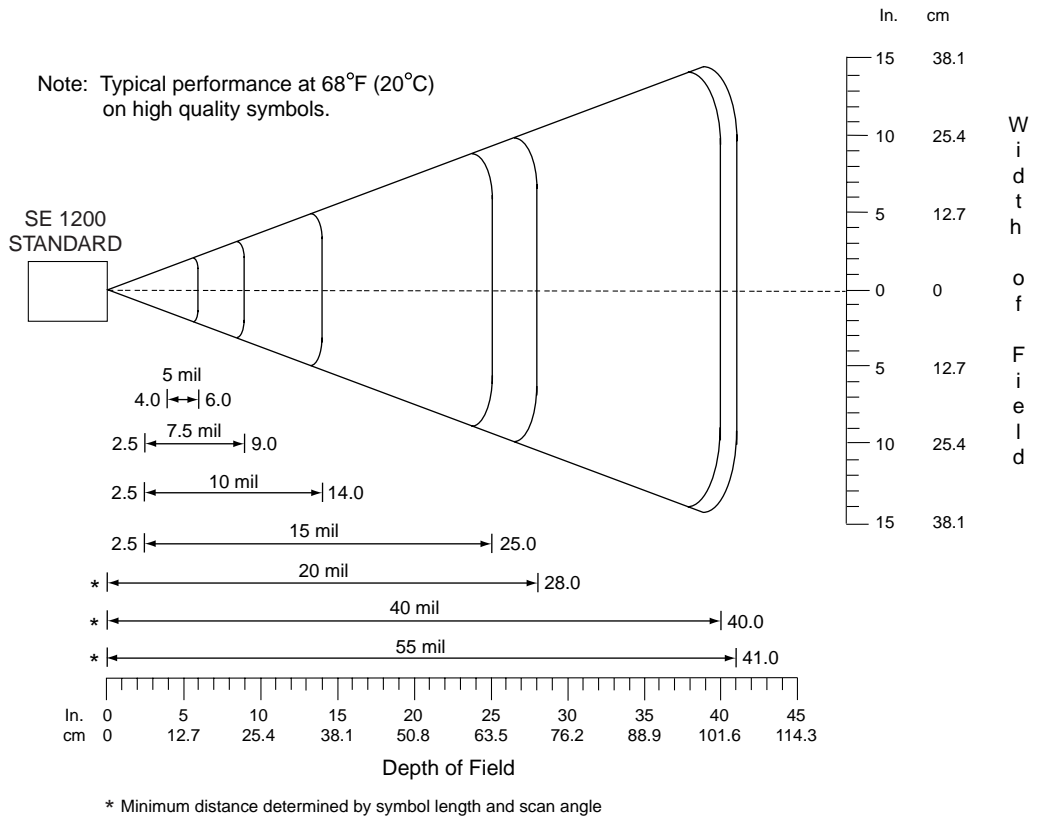


## RF Communications

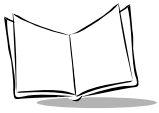
---

Specification	Spectrum One (6810)	Spectrum24 (6842, 6845)	Spectrum24 (6846)
Spreading Technique	Direct sequence	Frequency hopping	Frequency hopping
Data Rate	60.6 Kbps	1 Mbps/2 Mbps	11 Mbps
Range: Open Space	1500 feet/454 meters	Up to 1000 feet/303 meters	Up to 1000 feet/303 meters
Frequency Range	902-928 MHz	Country dependent. Typically 2.4 to 2.5 GHz	Country dependent. Typically 2.4 to 2.5 GHz
Output Power	250 mW	500 mW (US) 100 mW (International)	500 mW (US) 100 mW (International)
Ethernet Compatibility	Through NCU	Dix Ethernet	Dix Ethernet
Radio Channel Access Method	CSMA/CA	CSMA/CA	CSMA/CA

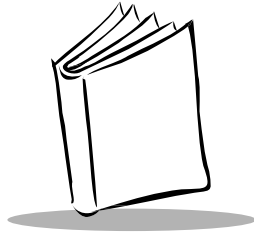
# Scanning Decode Zones



**Figure D-1. ID Scanning Decode Zones**



*PDT 6800 Series Product Reference Guide*



## Appendix E

### Boot-Up Quick Reference

#### Introduction

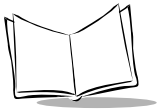
---

Table E-1 and Table E-2 list the boot procedures for the 35 and 46-key keyboards.

**Table E-1. 35-Key Boot Procedures**

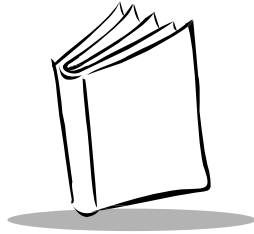
Boot Type	Key Sequence	Used For	Results
Power On	PWR, or Trigger, or remove terminal from cradle	Applying power	Returns terminal to where it was when it was turned off.
Warm Boot	<F> <J> <PWR>	Choosing a program that resides in NVM.	If system software is present, returns terminal to DOS. Otherwise, returns terminal to command mode. Retains contents of RAM.
Cold Boot	<SPACE> <FUNC> Up Arrow <PWR>	Resetting BIOS and the operating system.	Erases and recreates RAM disk. Only data in NVM is retained.
Command Mode Start	<BKSP> <SHIFT> <PWR>	Entering command mode for Self Test or communication	Takes terminal to beginning of command mode. The first time you turn the terminal on or after the terminal has been stored without batteries, acts the same as a Cold Boot (resets BIOS, loses contents of RAM).





**Table E-2. 46-Key Boot Procedures**

Boot Type	Key Sequence	Used For	Results
Power On	PWR, or Trigger, or remove terminal from cradle	Applying power	Returns terminal to where it was when it was turned off.
Warm Boot	<4> <5> <PWR>	Choosing a program that resides in NVM.	If system software is present, returns terminal to DOS. Otherwise, returns terminal to command mode. Retains contents of RAM.
Cold Boot	<A> <B> <D> <PWR>	Resetting BIOS and the operating system.	Erases and recreates RAM disk. Only data in NVM is retained.
Command Mode Start	<F> <I> <PWR>	Entering command mode for Self Test or communication	Takes terminal to beginning of command mode. The first time you turn the terminal on or after the terminal has been stored without batteries, acts the same as a Cold Boot (resets BIOS, loses contents of RAM).



## *Appendix F*

# *2D Scanner Drivers and Applications*

### **Introduction**

---

The PDT 6800 Series terminal uses additional scanner drivers and applications to scan 2D bar codes. This chapter covers the following:

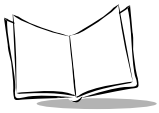
- ◆ Using `scn2dssi.exe`
- ◆ Output messages
- ◆ Application development
- ◆ Application Notes
- ◆ New APIs
- ◆ New API definitions
- ◆ Label Type definition for 2D scanner driver
- ◆ SCN2DSSI scanner driver default parameters
- ◆ Using `bldscn2D.exe`
- ◆ Code type menus
- ◆ Parameter menus.

### **Using Scn2dssi.exe**

---

#### ***Usage***

- ◆ `Scn2dssi.exe`: Load the driver
- ◆ `Scn2dssi.exe -o`: Overwrite the previous driver



- ◆ Scn2dssi.exe -r: Remove the current driver

## Output Messages

**Table F-1. Output Messages**

Screen	Description
0:NB2DSSIA 1.03 PDF DRIVER LOADED CRC Checksum:0x1949 NEW INTB6 INSTALLED  decoder: NBRWCAAE 	The driver is successfully loaded. The driver version string is NB2DSSIA; major revision 1.0, minor revision 0.3. The checksum is 0x1949 (checksum will be different based on the version number) with decoder version string of NBRWCAAE.
0:NB2DSSIA 1.03 PDF DRIVER LOADED CRC Checksum:0x1949 Re-Install Driver  NEW INTB6 INSTALLED  decoder: NBRWCAAE 	The driver is successfully loaded. The driver version string is NB2DSSIA; major revision 1.0, minor revision 0.3. The checksum is 0x1949 (checksum will be different based on the version number) with decoder version string of NBRWCAAE.
0:NB2DSSIA 1.03 PDF DRIVER LOADED CRC Checksum:0x1949 NEW INTB6 REMOVED  Driver Removed	The driver is successfully loaded. The driver version string is NB2DSSIA; major revision 1.0, minor revision 0.3. The checksum is 0x1949 (checksum will be different based on the version number).

## Application Development

The driver works with the standard Serial 3000 applications such as **scan.exe**. To use new APIs (ioctl functions), the **urm.gt** and **urm.gd** files must be updated.

## Application Notes

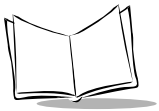
With composite codes enabled, you will experience a delay decoding UPC/EAN bar codes.

### New APIs

Table F-2 lists new APIs for `scn2dssi.exe`. Refer to `scan1d2d.c` for information on how to use these functions.

**Table F-2. APIs**

Function	Length	Structure
ConsIoctlGetExtDecoders (0x1B) ConsIoctlSetExtDecoders (0x19)	ConsIoctlGetExtDecodersLen ConsIoctlSetExtDecodersLen	<pre> struct ExtDecoders_S {   BYTE Bookland;   BYTE EAN128;   BYTE ISBT128;   BYTE CouponCode;   BYTE C39Trioptic;   BYTE TLC39;   BYTE RSS_14;   BYTE RSS_Limited;   BYTE RSS_Expanded;   BYTE CompositeAB; +   BYTE CompositeC; +   BYTE   Code128_Emulation; *   BYTE MicroPDF; };           </pre>

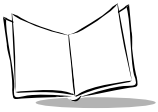


**Table F-2. APIs (Continued)**

Function	Length	Structure
ConsIoctlGetExtDecoderParms (0x1C) ConsIoctlSetExtDecoderParms (0x1A)	ConsIoctlGetExtDecoderParms Len ConsIoctlSetExtDecoderParms Len	<pre> struct ExtDecoderParms_S {   BYTE linear_security_level;   BYTE   linear_supp_enabled;   BYTE   code39_xmit_chkdgt;   BYTE xmit_i25_chkdgt;   BYTE msi_chkdgt_scheme;   BYTE check_i25_chkdgt;   BYTE   random_weight_chkdgt;   BYTE tri39_red_enabled;   BYTE   cvtEAN8_2_EAN13;   BYTE cvtI25_2_EAN13;   BYTE cvtC39_2_C32;   BYTE C32Prefix;   BYTE EnableC128Perf;   BYTE C128PerfLvl;   BYTE EnableC39Perf;   BYTE C39PerfLvl;   BYTE updf_performance;   BYTE UPC_Composite; };           </pre>
ConsIoctlGetScanOptions (0x1D) ConsIoctlSetScanOptions (0x1B)	ConsIoctlGetScanOptionsLen ConsIoctlSetScanOptionsLen	<pre> struct ScanOptions_S {   BYTE laser_on_time;   BYTE aim_time;   BYTE scan_mode;   BYTE aim_mode; };           </pre>

**Table F-2. APIs (Continued)**

Function	Length	Structure
ConsIoctlGetMacroPDF 0x1C ConsIoctlSetMacroPDF 0x1A	ConsIoctlGetMacroPDFLen ConsIoctlSetMacroPDFLen	<pre> struct MacroPDF_S { byte xmit_file_name; byte xmit_block_count; byte xmit_time_stamp; byte xmit_sender; byte xmit_addressee; byte xmit_csum; byte xmit_file_size; byte xmit_header; byte xmit_marker; }; </pre>
ConsIoctlGetMacroPDFAuxData (0x1E)	ConsIoctlGetMacroPDFAuxDataLen	<pre> struct MacroPDFAuxData_S { WORD SegmentIndex; WORD SegmentCount; CHAR FileId[256]; time_t Time_stamp; WORD FileSize; WORD CheckSum; CHAR FileName[256]; CHAR Sender[256]; CHAR Addressee[256]; }; ++ </pre>
ConsIoctlGetVersion (0x1F)	ConsIoctlGetVersionLen	<pre> struct Version_S { BYTE Major; BYTE Minor; BYTE Scannerver[20]; BYTE Decoderver[20]; }; </pre>



**Table F-2. APIs (Continued)**

Function	Length	Structure
ConsIoctlGetMultiPacketStatus (0x20)	ConsIoctlGetMultiPacketStatus Len	struct MultiPacketStatus_S { BYTE NumPacketsLeft; };
<p>* Code128 Emulation is not supported in current release, but will be supported in future releases.</p> <p>+ When Composite AB/C is enabled, the following barcode types are automatically enabled regardless of their status (EAN-128, EAN-13, EAN-8, RSS Expanded, RSS Limited, RSS-14, UPC-A, and UPCE). If driver-enabled barcode type is scanned, the driver WILL NOT send the data to application.</p> <p>++ For MacroPDF, the driver returns MacroPDF barcode type to the application along with the main block. An application can then call ConsIoctlGetMacroPDFAuxData to retrieve the control block information. MacroPDFAuxData structure contains the last scanned and decoded MacroPDF control block. If MacroPDF has never been scanned, the field will contain 0, or NULL.</p>		

## New API Definitions

### Get/Set Extended Decoders

ConsIoctlGetExtDecoders command returns the status of the additional supported decoders in the terminal and uses ConsIoctlSetExtDecoders command to enable or disable the additional decoders supported in the terminal.

**Table F-3. Get/Set Extended Decoders**

Field	Size	Value/Description
Subcommand Number	BYTE	27 = Get, 25 = Set
Error Code	BYTE	Not Used
Bookland*	BYTE	0 = Disable, 1 = Enable
EAN128	BYTE	0 = Disable, 1 = Enable
ISBT128	BYTE	0 = Disable, 1 = Enable
CouponCode* *	BYTE	0 = Disable, 1 = Enable
C39Trioptic ***	BYTE	0 = Disable, 1 = Enable
TLC39	BYTE	0 = Disable, 1 = Enable
RSS_14	BYTE	0 = Disable, 1 = Enable

**Table F-3. Get/Set Extended Decoders (Continued)**

Field	Size	Value/Description
RSS_Limited	BYTE	0 = Disable, 1 = Enable
RSS_Expanded	BYTE	0 = Disable, 1 = Enable
CompositeAB <sup>+</sup>	BYTE	0 = Disable, 1 = Enable
CompositeC <sup>+</sup>	BYTE	0 = Disable, 1 = Enable
Code128_Emulation <sup>++</sup>	BYTE	0 = Disable, 1 = Enable
MicroPDF	BYTE	0 = Disable, 1 = Enable
<p>* Bookland: User must enable UPC-A and/or EAN13 for Bookland.</p> <p>** CouponCode: When enabled, it decodes UPC-A, UPC-A with 2 supplemental, UPC-A with 5 supplemental, and UPC-A/EAN-128 barcode codes. User must enable UPC-A, EAN-13, and EAN-128.</p> <p>***C39Trioptic: Trioptic Code39 symbols always contain six characters. Trioptic Code39 and Code39 Full ASCII cannot be enabled simultaneously.</p> <p>+ Composite AB: When enabled, the following barcode types are automatically enabled regardless of their status (EAN-128, EAN-13, EAN-8, RSS Expanded, RSS Limited, RSS-14, UPC-A, and UPCE). If driver-enabled barcode type is scanned, the driver will not send the data to application.</p> <p>+ Composite C: When enabled, EAN-128 will be automatically enabled. If driver-enabled barcode type is scanned, the driver will not send the data to application.</p> <p>++ Code128 Emulation is not supported in current release. It will be supported in future release.</p>		

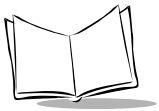
## Get/Set Extended Decoder Parameters

Uses `ConsIoctlGetExtDecoderParms` or `ConsIoctlSetExtDecoderParms` to get or set the extended parameters.

**Table F-4. Get/Set Extended Decoder Parameters**

Field	Size	Value/Description
Subcommand Number	BYTE	28 = Get, 26 = Set
Error Code	BYTE	Not Used





**Table F-4. Get/Set Extended Decoder Parameters (Continued)**

Field	Size	Value/Description
linear_security_level	BYTE	1 = Level 1, 2 = Level 2, 3 = Level 3, 4 = Level 4
linear_supp_enabled	BYTE	0 = Disable, 1 = Enable
code39_xmit_chkdg	BYTE	0 = Disable, 1 = Enable
xmit_i25_chkdg	BYTE	0 = Disable, 1 = Enable
msi_chkdg_scheme	BYTE	0 = Mod11/Mod10, 1 = Mod10/Mod10
check_i25_chkdg	BYTE	0 = Disable 1 = USS check digit 2 = OPCC check digit
random_weight_chkdg	BYTE	0 = disable 1 = use four digit method 2 = use five digit method
tri39_red_enabled	BYTE	0 = Disable, 1 = Enable
cvtEAN8_2_EAN13	BYTE	0 = Type is EAN-8 1 = Type is EAN-13
cvtI25_2_EAN13	BYTE	0 = Disable, 1 = Enable
cvtC39_2_C32	BYTE	0 = Disable, 1 = Enable
C32Prefix	BYTE	0 = Disable, 1 = Enable
EnableC128Perf	BYTE	0 = Disable, 1 = Enable
C128PerfLvl	BYTE	1 = Level 1, 2 = Level 2, 3 = Level 3
EnableC39Perf	BYTE	0 = Disable, 1 = Enable
C39PerfLvl	BYTE	1 = Level 1, 2 = Level 2, 3 = Level 3
updf_performance	BYTE	0 – 9; Level 0 to Level 9
UPC_Composite	BYTE	0 = UPC is never linked 1 = UPC always linked 2 = AutoD UPC linkage

`linear_security_level` Linear Code Type Security Level. Four levels of decode security for linear code types (e.g., Code 39, Interleaved 2 of 5, Code128 etc). Higher security levels are selected for decreasing levels of bar code quality. As security levels increase, the scanner's aggressiveness decreases. Select the security level appropriate for your bar code quality.

**Level 1:** The following code types must be successfully read twice before being decoded:

Code Type	Length
Codabar	All
MSI Plessey	4 or less
D 2 of 5	8 or less
I 2 of 5	8 or less

**Level 2:** All code types must be successfully read twice before being decoded.

**Level 3:** Code types other than the following must be successfully read twice before being decoded.

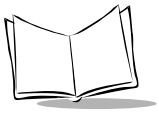
The following codes must be read three times:

Code Type	Length
MSI Plessey	4 or less
D 2 of 5	8 or less
I 2 of 5	8 or less

**Level 4:** All code types must be successfully read three times before being decoded.

`linear_supp_enabled` This option applies to supplemental code types. When enabled, a bar code is transmitted only when both blocks are successfully decoded within one laser scan.

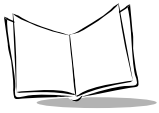
`code39_xmit_chkdgdt` Enable to transmit the check digit with the data. Disable to transmit the data without check digit



<code>xmit_i25_chkdg</code>	Enable to transmit the check digit with the data. Disable to transmit the data without check digit.
<code>msi_chkdg_scheme</code>	Select which algorithm to use when the number of check digits is set to 2 check digits.  0 = Mod11/Mod10 1 = Mod10/Mod10
<code>check_i25_chkdg</code>	Select I 2 of 5 check digit type:  0 = Do not use check digit 1 = Use USC (Uniform Symbology Specification) check digit 2 = Use OPCC (Optical Product Code Council) check digit
<code>random_weight_chkdg</code>	This parameter applies to both EAN-13 and UPC-A:  0 = disable random weight check digit 1 = use four digit method to calculate check digit 2 = use five digit method to calculate check digit
<code>tri39_red_enabled</code>	Enable TriopticCode39 redundancy.
<code>cvtEAN8_2_EAN13</code>	Convert EAN-8 barcode type to EAN-13. When EAN Zero Extend is enabled, this parameter gives you the option of labeling the extended symbol as either an EAN-13 bar code, or an EAN-8 bar code. This affects <i>Transmit Code ID Character</i> and <i>DECODE_DATA</i> message. When EAN Zero Extend is disabled, this parameter has no effect on bar code data. Uses <code>conv_ean8to13_b</code> from decoder parameters to enable EAN Zero Extend.
<code>cvtI25_2_EAN13</code>	Convert I 2 of 5 barcode type to EAN-13. This parameter converts a 14 character I 2 of 5 code into EAN-13. To accomplish

this, the I 2 of 5 code type must be enabled, one length must be set to 14, and the code must have a leading zero and a valid EAN-13 check digit.

cvtC39_2_C32	Convert Code39 to Code32. Code 39 must be enabled in order for this parameter to function.
C32Prefix	Code32 Prefix. Enable this parameter to add the prefix character “A” to all Code 32 bar codes. Convert Code 39 to Code 32 must be enabled for this parameter to function.
EnableC128Perf	Enable Code128 Performance. This option offers three levels of decode performance or “aggressiveness” for Code 128 symbols. Increasing the performance level reduces the amount of required bar code orientation, which is useful if you are scanning very long and/or truncated bar codes. Increased levels reduce decode security. If you enable this option, you may select a Decode Performance level to suit your performance needs.
C128PerfLvl	Code128 Decode Performance Level. Valid from Level 1 to Level 3.
EnableC39Perf	Enable Code39 Decode Performance. This option offers three levels of decode performance or “aggressiveness” for Code 39 symbols. Increasing the performance level reduces the amount of required bar code orientation, which is useful if you are scanning very long and/or truncated bar codes. Increased levels reduce decode security. If you enable this option, you may select a Decode Performance level to suit your performance needs. This option only works with Code 39 One Discrete Length.
C39PerfLvl	Code39 Decode Performance Level. Valid from Level 1 to Level 3.
updf_performance	MicroPDF Performance. Controls performance level of



MicroPDF decoding. Set the level to Level 3 or above to improve MicroPDF decode performance.

UPC\_CompositeUPC  
Composite Linking

Specifies how UPC Composite Linking is handled.

## Get/Set Scan options

Uses `ConsIoctlGetScanOptions` or `ConsIoctlSetScanOptions` to get/set scan option.

Field	Size	Value/Description
Subcommand Number	BYTE	29 = Get, 27 = Set
Error Code	BYTE	Not Used
laser_on_time	BYTE	5 - 99
aim_time	BYTE	0 - 2
scan_mode	BYTE	1 = Smart Raster, 2 = Always Raster, 4 = Slab Raster
aim_mode	BYTE	0 = Disable, 1 = Enable

laser\_on\_time           Scanner laser on time. This parameter sets the maximum time decode processing continues during a scan attempt. It is programmable in 0.1 second increments from 0.5 to 9.9 seconds.

aim\_time                Aim time. When a scanner with an aim mode is triggered, this parameter sets the duration the aiming pattern is seen before a scan attempt begins.  
1 = 200 ms.  
2 = 400 ms.

scan\_mode              Scan mode. Set the rastering mode of the scan engine. The following are the valid raster mode values: Smart Raster (0x01), Always Raster (0x02), Slab Only Raster (0x04). Programmable raster is not supported.

aim\_modeAim mode      Enable/Disable aiming.

## Get Macro PDF Auxiliary Data

MacroPDF Auxiliary Data contains control block information which can be used to recombine the data from the individual MarcoPDF symbols in the proper order to fully recreate the original file content. Uses `ConsIoctlGetMacroPDFAuxData` to retrieve the control block information.

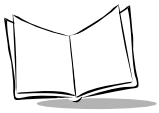
---

**Note:** *The structure will contain the last scanned and decoded MacroPDF control block information; if MacroPDF has never been scanned, the fields will contain 0, or NULL.*

---

Field	Size	Value/Description
Subcommand Number	BYTE	30 = Get
Error Code	BYTE	Not Used
SegmentIndex	WORD	0 – 65535
SegmentCount	WORD	0 – 65535
FileId	256 BYTES (Byte 6 to Byte 261)	File IDs
Time_stamp	LONG	Time Stamp is time_t format.
FileSize	WORD	0 – 65535
Checksum	WORD	CRC checksum
FileName	256 BYTES (Byte 269 to Byte 525)	Null terminated text string containing the original source file-name.
Sender	256 BYTES (Byte 526 to Byte 781)	Sender identification string.
Addressee	256 BYTES (Byte 782 to Byte 1037)	Identification string of intended receiver of file.

SegmentIndex	Contains segment index of the MacroPDF symbol.
SegmentCount	Contains total number of macro PDF symbol in the set.
FileIdNull	Terminated text string containing the File Identification sequence. The sequence should be the same for each symbol in set.
Time_stamp	The time stamp of the source file expressed as the elapsed time in seconds from 1-January-1970 00:00 GMT.



- FileSize                      Total number of bytes in original file.
- Checksum                     The 16-bit CCITT-16 CRC result computed over the entire source file.
- FineName                     Null terminated text string containing the original source filename.
- Sender                        Sender identification string.
- Addressee                    Identification string of intended receiver of file.

### Get Scanner Version

Uses `ConsIoctlGetVersion` to retrieve the version information.

Field	Size	Value/Description
Subcommand Number	BYTE	31 = Get
Error Code	BYTE	Not Used
Major	BYTE	Major version of the scanner driver
Minor	BYTE	Minor version of the scanner driver
Scannerver	20 BYTES (Byte 4 to Byte 23)	Scanner Driver version string, such as "NB2DSSIA"
Decoderver	20 BYTES (Byte 24 to Byte 43)	Software revision string of the SSI scanner software

- Major                         Major version of the scanner driver.
- Minor                        Minor version of the scanner driver.
- Scannerver                   Scanner Driver version string.
- Decoderver                   Software revision string of the SSI scanner software.

## Get Multi Packet Status

Uses `ConsIoctlGetMultiPacketStatus` to retrieve the number of packets left for a multi-packet barcode (such as composite code). For a single packet data, it will always return 0.

Field	Size	Value
Subcommand Number	BYTE	32 = Get
Error Code	BYTE	Not Used
NumPacketsLeft	BYTE	0 - 255

NumPacketsLeft                      Number of packets left to be read.

## Label Type Definition for 2D Scanner Driver

PDT68XX 2D scanner driver supports AIM ID as well as many new symbologies, such as Coupon Code, Composite Code, RSS, and TLC39. Tables below show the relation between label type, symbol ID, and AIM ID.

To support AIM ID, the `xmit_code_id_char` in `Ioctl Get/Set Return Format` command will be modified as follow:

0 = Don't transmit code ID

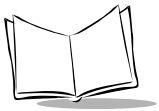
2 = Transmit AIM ID

2 = Transmit AIM ID

**Table F-5. Symbology table with LabelType, Symbol ID, and AIM ID**

Code Type Name	LabelType-Value (Hex)	Symbol ID (ASCII)	AIM ID Letter	AIM ID Modifier
UPCE0	0x0	A	E	0
UPCE1	0x1	A	E	0
UPCA	0x2	A	E	0
MSI	0x3	J	M	Same rules as for Code 39
EAN8	0x4	A	E	4
EAN13	0x5	A	E	0
CODABAR	0x6	C	F	0 (1) – standard (ABC)



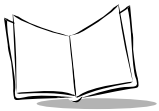


**Table F-5. Symbology table with LabelType, Symbol ID, and AIM ID (Continued)**

CODE39	0x7	B	A	0 – no check digit 1 (3) – check digit included (exclude)
D2OF5	0x8	G	S	0
I2OF5	0x9	F	I	Same rule as for Code39
CODE11	0xA	H	H	0 (1) [2] – 1 (2) [0] check digits included
CODE93	0xB	E	G	0
CODE128	0xC	D	C	0 (also see UCC/EAN-128)
PDF417	0xD	X	L	0 – Conforms with 1994 PDF-417 spec 1 – Backslash characters doubled 2 – Backslash characters not dou- bled
IATA2OF5	0xE	G	S	0
EAN128	0xF	K	C	1 (2) – character 1 (2) is Function 1 (F1)
BOOKLAND	0x11	L	X	0
TRIOPTIC39	0x12	M	X	0
COUPON	0x13	N	E + C *	1
POSTNET (US)	0x15	p+	X	0
PLANET (US)	0x16	p+	X	0
ISBT128	0x19	D	C	0
MICROPDF	0x1A	X	L	0,1 or 2 – same definition as PDF417 3 – Code128 emul: implied F1 in 1st position 4 – Code 128 emul: F1 after 1st letter/digits 5 – Code 128 emul: no implied F1
CODE32	0x20	B	A	Same rules as for Code 39
POSTBAR (CA)	0x26	p+	X	0
POSTAL (UK)	0x27	p+	X	0
MACROPDF	0x28	X	L	Same rules as for PDF-417
RSS 14	0x30	R	e	0
RSS LIMITED	0x31	R	e	0
RSS EXPANDED	0x32	R	e	0
COMPOSITE A EAN 128	0x51	T		See Composite Code Data Formats Table

**Table F-5. Symbology table with LabelType, Symbol ID, and AIM ID (Continued)**

COMPOSITE A EAN 13	0x52	T		See Composite Code Data Formats Table
COMPOSITE A EAN 8	0x53	T		See Composite Code Data Formats Table
COMPOSITE A RSS EXPANDED	0x54	T		See Composite Code Data Formats Table
COMPOSITE A RSS LIMITED	0x55	T		See Composite Code Data Formats Table
COMPOSITE A RSS 14	0x56	T		See Composite Code Data Formats Table
COMPOSITE A UPCA	0x57	T		See Composite Code Data Formats Table
COMPOSITE A UPCE	0x58	T		See Composite Code Data Formats Table
COMPOSITE C EAN128	0x59	T		See Composite Code Data Formats Table
TLC 39	0x5A	T		See Composite Code Data Formats Table
COMPOSITE B EAN 128	0x61	T		See Composite Code Data Formats Table
COMPOSITE B EAN 13	0x62	T		See Composite Code Data Formats Table
COMPOSITE B EAN 8	0x63	T		See Composite Code Data Formats Table
COMPOSITE B RSS EXPANDED	0x64	T		See Composite Code Data Formats Table
COMPOSITE B RSS LIMITED	0x65	T		See Composite Code Data Formats Table
COMPOSITE B RSS 14	0x66	T		See Composite Code Data Formats Table
COMPOSITE B UPCA	0x67	I		See Composite Code Data Formats Table
COMPOSITE B UPCE	0x68	T		See Composite Code Data Formats Table
MACRO MICRO PDF	0x9A	X	L	Same rules as for Micro PDF417



**Table F-5. Symbology table with LabelType, Symbol ID, and AIM ID (Continued)**

- + For CodeID begin with ‘P’, actually it should contain three letters (such as “P01”); but for backward compatible, only one letter will be returned.
- ◆ CouponCode AIM ID: E + C denotes 2 AIM IDs are transmitted: the first prefixes the main UPC/EAN block; the second prefixes the EAN-128 block. The sample data format for CouponCode with AIM ID: `î|E0512345678902|C112345678î`.

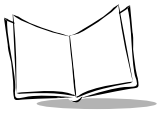
All Function 1 characters in the 1D and 2D are sent as G S (29 10); the first Function 1 in the EAN-128 is not transmitted.

**Table F-6. Symbology table with LabelType, Symbol ID, and AIM ID**

Code Type Name	LabelType-Value (Hex)	Symbol ID (ASCII)	AIM ID Letter	AIM ID Modifier
UPCE0	0x0	A	E	0
UPCE1	0x1	A	E	0
UPCA	0x2	A	E	0
MSI	0x3	J	M	Same rules as for Code 39
EAN8	0x4	A	E	4
EAN13	0x5	A	E	0
CODABAR	0x6	C	F	0 (1) – standard (ABC)
CODE39	0x7	B	A	0 – no check digit 1 (3) – check digit included (exclude)
D2OF5	0x8	G	S	0
I2OF5	0x9	F	I	Same rule as for Code39
CODE11	0xA	H	H	0 (1) [2] – 1 (2) [0] check digits included
CODE93	0xB	E	G	0
CODE128	0xC	D	C	0 (also see UCC/EAN-128)
PDF417	0xD	X	L	0 – Conforms with 1994 PDF-417 spec 1 – Backslash characters doubled 2 – Backslash characters not doubled
IATA2OF5	0xE	G	S	0
EAN128	0xF	K	C	1 (2) – character 1 (2) is Function 1 (F1)
BOOKLAND	0x11	L	X	0
TRIOPTIC39	0x12	M	X	0

**Table F-6. Symbology table with LabelType, Symbol ID, and AIM ID (Continued)**

COUPON	0x13	N	E + C *	1
POSTNET (US)	0x15	p+	X	0
PLANET (US)	0x16	p+	X	0
ISBT128	0x19	D	C	0
MICROPDF	0x1A	X	L	0,1 or 2 – same definition as PDF417 3 – Code128 emul: implied F1 in 1st position 4 – Code 128 emul: F1 after 1st letter/digits 5 – Code 128 emul: no implied F1
CODE32	0x20	B	A	Same rules as for Code 39
POSTBAR (CA)	0x26	p+	X	0
POSTAL (UK)	0x27	p+	X	0
MACROPDF	0x28	X	L	Same rules as for PDF-417
RSS 14	0x30	R	e	0
RSS LIMITED	0x31	R	e	0
RSS EXPANDED	0x32	R	e	0
COMPOSITE A EAN 128	0x51	T		See Composite Code Data Formats Table
COMPOSITE A EAN 13	0x52	T		See Composite Code Data Formats Table
COMPOSITE A EAN 8	0x53	T		See Composite Code Data Formats Table
COMPOSITE A RSS EXPANDED	0x54	T		See Composite Code Data Formats Table
COMPOSITE A RSS LIMITED	0x55	T		See Composite Code Data Formats Table
COMPOSITE A RSS 14	0x56	T		See Composite Code Data Formats Table
COMPOSITE A UPCA	0x57	T		See Composite Code Data Formats Table
COMPOSITE A UPCE	0x58	T		See Composite Code Data Formats Table
COMPOSITE C EAN128	0x59	T		See Composite Code Data Formats Table
TLC 39	0x5A	T		See Composite Code Data Formats Table
COMPOSITE B EAN 128	0x61	T		See Composite Code Data Formats Table



**Table F-6. Symbology table with LabelType, Symbol ID, and AIM ID (Continued)**

COMPOSITE B EAN 13	0x62	T		See Composite Code Data Formats Table
COMPOSITE B EAN 8	0x63	T		See Composite Code Data Formats Table
COMPOSITE B RSS EXPANDED	0x64	T		See Composite Code Data Formats Table
COMPOSITE B RSS LIMITED	0x65	T		See Composite Code Data Formats Table
COMPOSITE B RSS 14	0x66	T		See Composite Code Data Formats Table
COMPOSITE B UPCA	0x67	T		See Composite Code Data Formats Table
COMPOSITE B UPCE	0x68	T		See Composite Code Data Formats Table
MACRO MICRO PDF	0x9A	X	L	Same rules as for Micro PDF417
<p>+ For CodeID begin with 'P', actually it should contain three letters (such as "P01"); but for backward compatible, only one letter will be returned.</p> <p>* CouponCode AIM ID: E + C denotes 2 AIM Ids are transmitted: the first prefixes the main UPC/EAN block; the second prefixes the EAN-128 block. The sample data format for CouponCode with AIM ID: <code>¡ E0512345678902 C112345678¡</code>.</p> <p>All Function 1 characters in the 1D and 2D are sent as G S (29 10); the first Function 1 in the EAN-128 is not transmitted.</p>				

**Table F-7. New AIM ID for UPC/EAN family with supplemental**

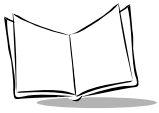
Code Type Name	LabelType- Value (Hex)	Symbol ID (ASCII)	AIM ID Letter	AIM ID Modifier
UPCE0 + 2	0x0	A	E + E	0 for main block; 1 for supplemental
UPCE0 + 5	0x0	A	E + E	0 for main block; 2 for supplemental
UPCE1 + 2	0x01	A	E + E	0 for main block; 1 for supplemental
UPCE1 + 5	0x01	A	E + E	0 for main block; 2 for supplemental
UPCA + 2	0x02	A	E + E	0 for main block; 1 for supplemental
UPCA + 5	0x02	A	E + E	0 for main block; 2 for supplemental
EAN8 + 2	0x04	A	E + E	4 for main block; 1 for supplemental
EAN8 + 5	0x04	A	E + E	4 for main block; 2 for supplemental

**Table F-7. New AIM ID for UPC/EAN family with supplemental**

EAN13 + 2	0x05	A	E + E	0 for main block; 1 for supplemental
EAN13 + 5	0x05	A	E + E	0 for main block; 2 for supplemental
Note: E + E denotes 2 AIM IDs are transmitted: the first prefixes the main UPC/EAN block; the second prefixes the supplemental block. Sample data format: <code>¡ E0123456 E112i.</code>				

**Table F-8. Composite Code Data Formats Table**

1D Component	Data Format	
	Standard Mode	EAN-128 Emulation Mode
EAN-13, UPC-A, UPC-E	1D:  E0 2D:  e0 See note 1	Not supported
EAN-8	1D:  E4 2D:  e0 See note 1	Not supported
RSS-14 RSS Limited	1D:  e0 2D:  e1 See note 2	Not supported
Code 39 (TLC39)	ANSI MH10.8.3M syntax: 06 Format:  >R S 06 G S 6P 1D G S S 2D R S EOT 05 Format:  >R S 05 G S 906P 1D G S 8004 2D R S EOT See note 3	
EAN-128 RSS Expanded	If the last AI in the EAN128 is a predefined, fixed length: e0 Otherwise,  e0 GS See note 2	Not supported
Notes: 1. If the UPC/EAN component has a supplemental,  E1 precedes a 2-digit supplemental and  E2 precedes the 5-digit supplemental 2. In standard mode, the data following symbol separator begins with AIM ID " e1". The data following the composite component escape mechanism begins with AIM ID " e2" if ECI interpretation is enabled, " e3" if ECI interpretation is not enabled. 3. RS is character 30 10 and EOT is character 04. The transmitted format (05 or 06) is data dependent.		



## SCN2DSSI Scanner Driver Default Parameters

The out-of-box SCN2DSSI.EXE has the following default values:

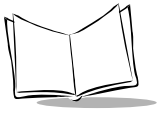
**Table F-9. Decoder Enable/Disable Default Table**

Code Type	Length (0 = fixed length)	Default Value
UPC A	0	Enable
UPC E0	0	Enable
EAN 13	0	Enable
EAN 8	0	Enable
UPC E1	0	Disable
SUPP 2	0	Enable
SUPP 5	0	Enable
SUPP_AUTO_D	0	Auto Discriminate supps
D2 OF 5	0 to 14	Disable
I2 OF 5	14 and 10	Enable
CODE 39	0 to 55	Enable
CODABAR	4 to 55	Enable
CODE 128	1 to 55	Enable
CODE 93	4 to 55	Disable
CODE 11	4 to 55	Disable
MSI	4 to 55	Disable
PDF 417	0	Enable
UCC/EAN 128	1 to 55	Enable
BOOKLAND	0	Disable
ISBT 128	1 to 55	Enable
COUPON CODE	0	Disable
TRIOPTIC 39	0	Disable
TLC 39	0	Disable
RSS 14	0	Disable
RSS LIMITED	0	Disable
RSS EXPANDED	0	Disable
COMPOSITE AB	0	Disable
COMPOSITE C	0	Disable
CODE 128 EMULATION	0	Disable always
MICRO PDF	0	Enable

**Table F-10. Decode Options Default Table**

Parameter	Default Value
<b>Check Digits Parameters</b>	
Code 39 Check Digit	Disable
Transmit Code 39 Check Digit	Disable
I 2 of 5 Check Digit	Disable
Transmit I 2 of 5 Check Digit	Disable
Transmit UPC-A Check Digit	Enable
Transmit UPC-E Check Digit	Enable
Transmit UPC-E1 Check Digit	Enable
Code 11 Check Digit	One
Transmit Code11 Check Digit	Disable
MSI Check Digits	Two check digits
Transmit MSI Check Digit	Disable
MSI Check Digit Algorithm	Mod 10/Mod 10
Random Weight Check Digit	Disable
<b>Conversion Parameters</b>	
EAN-8 Zero Extend	Disable
Convert UPC E0 to UPCA	Disable
Convert UPC E1 to UPCA	Disable
Convert EAN-8 to EAN-13 Type	Disable
Convert Code 39 to Code 32	Disable
Code 39 Full ASCII Conversion	Disable
Convert I 2 of 5 to EAN 13	Disable
UPC-A Preamble	System
UPC-E Preamble	System
UPC-E1 Preamble	System
Code 32 Prefix	Disable
<b>Security Parameters</b>	
Linear UPC/EAN Decode	Enable
Linear Code Type Security Levels	2
UPC/EAN Security Level	0
Bi-directional Redundancy	Disable
Code 11 Redundancy	Enable
Code 39 Redundancy	Disable
Code 128 Redundancy	Disable
MSI Redundancy	Enable
Codabar Redundancy	Enable
I 2 of 5 Redundancy	Enable
D 2 of 5 Redundancy	Enable
Code 93 Redundancy	Disable





**Table F-10. Decode Options Default Table (Continued)**

Trioptic 39 Redundancy	Enable
Decode Redundancy for UPC/EAN without supplemental	10
<b>Other Parameters</b>	
Code 128 Decode Performance	Enable
Code 128 Decode Performance Level	Level 1
Code 39 Decode Performance	Enable
Code 39 Decode Performance Level	Level 1
MicroPDF Performance	Level 0
UPC Composite Linking	Auto UPC linkage
Transmit Code ID Character	None
Laser On Time	5 Seconds
Scanning Mode	Smart Raster
Aim Mode	Dot Aim
Aim Time	0 Second (No Aiming)
Transmit "No Decode" Message	Disable

## Using BldScn2D.exe

---

The Bldscn2d.exe is based on the bldscan.exe and should only be used to build SCN2DSSI.EXE. Install the PDT6800 scankit before using Bldscn2d.exe.

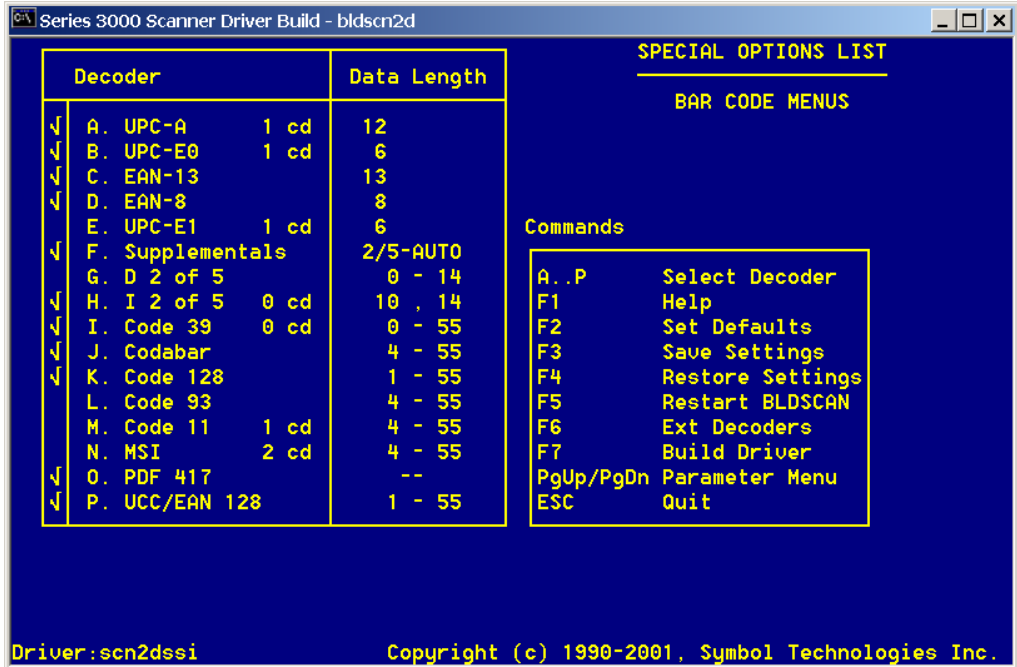
## Screen Menus

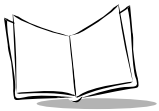
**Table F-11. Start Menu**

BldScn2D Version 1.00 Scn2dSSI scanner driver configuration tool.  Copyright (c) 1990-2001, Symbol Technologies Inc.  Usage: bldscn2d [output driver name]  Hit anykey to continue...
--

## Code Type Menu I

Alpha characters are used to select code types and function keys are used to perform actions.





## Code Type Menu 2

Series 3000 Scanner Driver Build - bldscn2d

Decoder	Data Length
√ A. BOOKLAND	
B. ISBT 128	1 - 55
C. Coupon Code	--
D. Trioptic 39	6
E. TLC 39	--
F. RSS_14	--
G. RSS_Limited	--
H. RSS_Expanded	--
I. CompositeAB	--
J. CompositeC	--
K. C128 Emulation	Variable
√ L. MicroPDF	--

**SPECIAL OPTIONS LIST**

**BAR CODE MENUS**

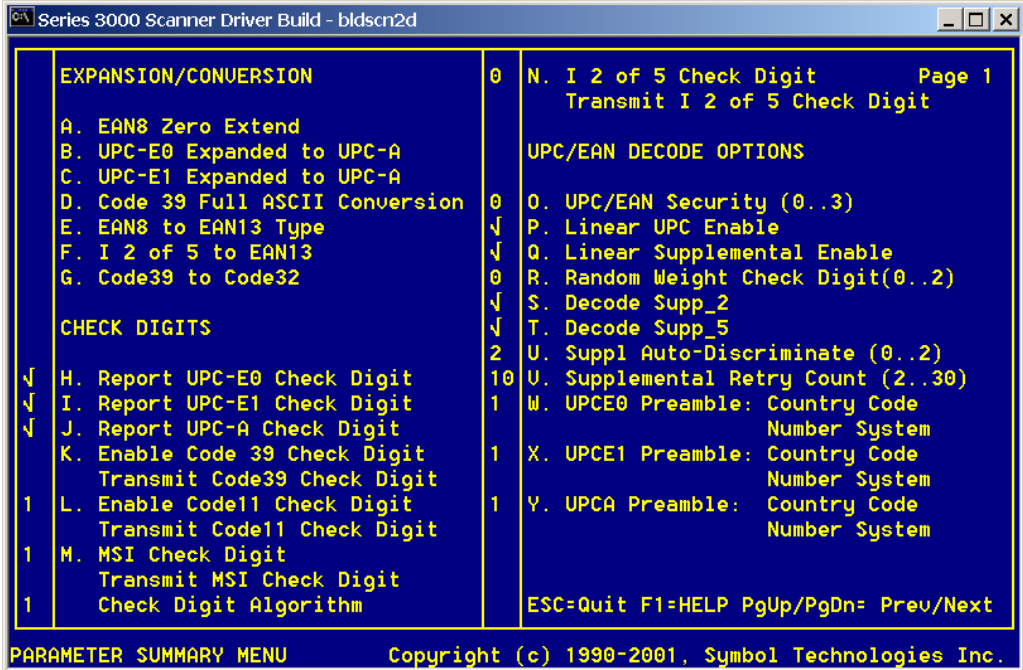
Commands

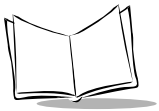
A..L	Select Decoder
F1	Help
F2	Set Defaults
F3	Save Settings
F4	Restore Settings
F5	Restart BLDFSCAN
F6	Standard Options
F7	Build Driver
PgUp/PgDn	Parameter Menu
ESC	Quit

Driver:scn2dssi Copyright (c) 1990-2001, Symbol Technologies Inc.

## Parameter Menu I

This menu contains information for programming decoder parameters.



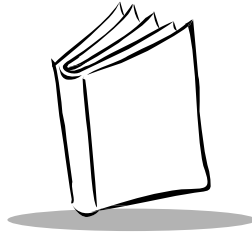


## Parameter Menu 2

Series 3000 Scanner Driver Build - bldscn2d \_ □ x

<p>Linear Redundancy/Security</p> <ul style="list-style-type: none"><li>A. Code 39 Redundancy</li><li>√ B. D 2 of 5 Redundancy</li><li>√ C. I 2 of 5 Redundancy</li><li>D. Code 128 Redundancy</li><li>√ E. Codabar Redundancy</li><li>√ F. Code 11 Redundancy</li><li>√ G. MSI Redundancy</li><li>H. Code 93 Redundancy</li><li>√ I. Trioptic Redundancy</li><li>J. Bidirectional (NON-UPC codes)</li><li>2 K. Linear Security Level(1..4)</li></ul> <p>Misc Options</p> <ul style="list-style-type: none"><li>√ L. Enable Code128 Performance</li><li>1 M. C128 Decode Performance Level Level1 - Level3 (1=highest)</li><li>√ N. Enable Code39 Performance</li><li>1 O. C39 Decode Performance Level Level1 - Level3 (1=highest)</li></ul>	<p>P. Code 32 Prefix <span style="float: right;">Page 2</span></p> <ul style="list-style-type: none"><li>0 Q. Micro PDF Performance</li><li>2 R. UPC Composite</li><li>S. System Info</li><li>0 T. Transmit Code ID (0..2) (0=None, 1-Symbol ID, 2-Aim ID)</li></ul> <p>Scan Options</p> <ul style="list-style-type: none"><li>50 U. Laser On Time (5..99)</li><li>0 U. Aim Time (0..2)</li><li>1 W. Scan Mode(1-smart,2-always,4-slab)</li><li>0_ X. Aim Mode (0-Disable,1-Enable)</li></ul> <p>ESC=Quit F1=HELP PgUp/PgDn= Prev/Next</p>
---	--

PARAMETER SUMMARY MENU Copyright (c) 1990-2001, Symbol Technologies Inc.



# Index

## Numerics

- 2D scanner
  - driver installation . . . . . F-1
- 38/6860
  - connecting for communications . . . . . 2-14
  - coupling 2 or more CCMs . . . . . 2-12
  - daisy-chaining 2 or more . . . . . 2-15
  - parts of . . . . . 2-11
  - parts required for set up . . . . . 2-2
  - wall mounting . . . . . 2-11, 2-12
- 38/6865
  - connecting for communications . . . . . 2-7
  - connecting to power . . . . . 2-6
  - description . . . . . 2-1, 2-2
  - parts of . . . . . 2-3
  - parts required . . . . . 2-2
  - wall mounting . . . . . 2-4
- 38/6866
  - connecting for communications . . . . . 2-7
  - connecting to other cradles . . . . . 2-10
  - connecting to power . . . . . 2-6
  - description . . . . . 2-1, 2-2
  - parts of . . . . . 2-3
  - parts required . . . . . 2-2
  - table mounting . . . . . 2-5
  - wall mounting . . . . . 2-5
- 6800
  - keyboard layouts . . . . . B-1
- 684X
  - description . . . . . 4-1
- 802.11
  - switching to Spring RF protocol . . . . . 5-6

## A

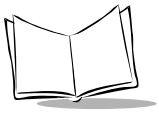
- adapter, pc . . . . . 2-16
- alarm . . . . . 5-2
- alarm power-on . . . . . 5-2

## B

- back lighting . . . . . 5-7
- Backspace Key . . . . . 5-11
- battery
  - charging the Lithium Ion . . . . . 6-7
  - charging the NiCd . . . . . 6-6
  - charging tips . . . . . 6-5
  - life . . . . . 6-2
  - recharging spare packs . . . . . 6-6
  - removing . . . . . 6-3
  - replacement . . . . . 6-3
- battery charge LED, PC adapter . . . . . 2-18
- battery storage . . . . . 6-5
- BKSP . . . . . 5-11
- booting
  - cold . . . . . E-1, E-2
  - Command Mode . . . . . 3-4
  - warm . . . . . E-1, E-2
- break, key sequence for . . . . . 5-11

## C

- CCM
  - daisy-chaining . . . . . 2-14
  - mounting . . . . . 2-11
- CCM 38/6860 . . . . . 2-1, 2-2
  - connecting for communications . . . . . 2-14
  - coupling 2 or more together . . . . . 2-12
  - parts of . . . . . 2-11



- wall mounting . . . . . 2-12
- chapter descriptions . . . . . ix
- charging
  - Lithium Ion battery pack . . . . . 6-7
  - NiCd battery pack . . . . . 6-6
  - spare battery packs . . . . . 6-6
  - time . . . . . 6-6
- charging and communications module . 2-1, 2-2
- cold boot . . . . . 5-5, E-1, E-2
- Command Mode . . . . . 3-2
  - booting to . . . . . 3-4
  - program loader . . . . . 3-3
- communications
  - RF network . . . . . 5-16
  - select parameters . . . . . 3-4
  - status codes . . . . . 3-6, C-1
  - with host or printer . . . . . 5-16
- connecting for communications . . . . . 2-14
  - 38/6860 . . . . . 2-14
  - 38/6865 cradle . . . . . 2-7
  - 38/6866 cradle . . . . . 2-7
- connecting to other cradles
  - 38/6866 cradle . . . . . 2-10
- connecting to power
  - 38/6865 cradle . . . . . 2-6
  - 38/6866 cradle . . . . . 2-6
- coupling 2 or more CCMs . . . . . 2-12
- cradles
  - 38/6865 . . . . . 2-1, 2-2
  - 38/6866 . . . . . 2-1, 2-2
  - connecting for communications . . . . . 2-7
  - connecting power . . . . . 2-6
  - coupling 2 or more CCMs . . . . . 2-12
  - mounting the 38/6865 . . . . . 2-4
  - mounting the 38/6866 . . . . . 2-5
  - parts required for setting up 38/6865 . . 2-2
  - parts required for setting up 38/6866 . . 2-2
  - parts required for setting up
    - CCM 38/6860 . . . . . 2-2
- CRD 38/6865
  - connecting for communications . . . . . 2-7
  - connecting to power . . . . . 2-6
  - parts of . . . . . 2-3
  - wall mounting . . . . . 2-4

- CRD 38/6866
  - connecting for communications . . . . . 2-7
  - connecting to other cradles . . . . . 2-10
  - connecting to power . . . . . 2-6
  - parts of . . . . . 2-3
  - table mounting . . . . . 2-5
  - wall mounting . . . . . 2-5

**D**

- display
  - key scan test . . . . . 7-8
- documents available from
  - Symbol Technologies . . . . . x
- downloading
  - program loader . . . . . 3-2
  - using SENDHEX command . . . . . 3-2
- downloading a program
  - cancelling . . . . . 3-4
  - ending communications . . . . . 3-6
  - selecting communications parameters . . 3-4
  - starting communications . . . . . 3-6
- driver, 2D
  - installation . . . . . F-1

**E**

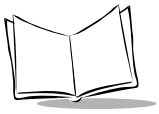
- ending self test . . . . . 7-8
- entering data
  - scanner entry . . . . . 5-12
- entering data with the scanner . . . . . 5-12
- error codes, communications . . . . . C-2
- error messages
  - double key error . . . . . 7-2
  - power fault . . . . . 7-2
  - replace cells . . . . . 7-2

**F**

- flash disk
  - application storage . . . . . 4-1
  - configuration file storage . . . . . 4-1
- FLASHDSK.SYS . . . . . 4-1
- FUNC Key . . . . . 5-10

- I**  
information, service ..... xi
- K**  
keyboard  
    35-key layouts ..... B-2  
    46-key layouts ..... B-5  
    modifier keys ..... 5-9  
    power on ..... 5-2  
    setting speed ..... 5-10  
    states ..... 5-10  
    test ..... 7-6  
    using ..... 5-9
- L**  
laser scanner ..... 5-12  
LEDs  
    battery charge indicator ..... 2-16  
    communications ..... 2-17  
lighting, back ..... 5-7  
loading a program ..... 3-2  
locked states ..... 5-10  
low battery ..... 7-2
- M**  
messages  
    double key error ..... 7-2  
    low battery ..... 7-2  
    power fault ..... 7-2  
    replace cells ..... 7-2  
momentary states ..... 5-10  
mounting CRD 38/6865 ..... 2-4
- N**  
normal power on ..... E-1, E-2  
NVM, erasing ..... 3-4
- P**  
PC adapter  
    battery charge LED ..... 2-16  
    charging time ..... 2-16  
    communication LED ..... 2-17  
    connecting to 6800 ..... 2-17  
    connecting to serial device ..... 2-17  
    DB-9 connector ..... 2-17  
    parts ..... 2-16  
    power supply port ..... 2-17  
    set up ..... 2-17  
PDF417  
    raster ..... 5-13  
PDT 6800  
    keyboard layouts ..... B-1  
PDT6842  
    switching 802.11 to  
        Spring RF protocol ..... 5-6  
PIM ..... 2-16  
    connecting for communicating  
        with printer ..... 5-16  
PIM, used with PC adapter ..... 2-16  
power connection  
    38/6865 cradle ..... 2-6  
    38/6866 cradle ..... 2-6  
power fault ..... 7-2  
Power Key ..... 5-11  
power off ..... 5-3  
    forced ..... 5-3  
power on ..... 5-2  
    keyboard ..... 5-2  
    real-time clock ..... 5-2  
    remove from cradle ..... 5-2  
    trigger ..... 5-3  
power, restoring after automatic shutdown ..... 5-3  
printer interface module (PIM) ..... 2-16  
printer, communicating with ..... 5-16  
program loader ..... 3-2  
    selecting ..... 3-4  
    status codes ..... C-1  
PWR Key ..... 5-11
- R**  
real-time clock ..... 5-2  
recharging spare battery packs ..... 6-6  
related documentation ..... x  
removing the battery ..... 6-3





replacing the battery . . . . . 6-3  
restoring power after automatic shutdown . 5-3

## S

scanning  
    adjusting the laser beam . . . . . 5-12  
    angle . . . . . 5-14  
    range . . . . . 5-15  
    raster . . . . . 5-13  
    tips for successful decode . . . . . 5-15

self test  
    Config Screen 1 . . . . . 7-6  
    Config Screen 2 . . . . . 7-6  
    ending . . . . . 7-8  
    Fill Screen . . . . . 7-6  
    Memory Screen . . . . . 7-6  
    running . . . . . 7-5  
    Set RTC Screen . . . . . 7-6  
    testing hardware components . . . . . 7-5

SENDHEX . . . . . 3-2  
    programming NVM . . . . . 3-2

service information . . . . . xi

setting the keyboard speed . . . . . 5-10

spare battery packs, charging . . . . . 6-6

Spectrum24  
    system software . . . . . 4-2

startup failures . . . . . 7-3

states  
    locked . . . . . 5-10  
    momentary . . . . . 5-10

symbol support center . . . . . xii

system software, Spectrum24 . . . . . 4-2

## T

table mounting, 38/6866 . . . . . 2-5

temperature  
    battery charging . . . . . 6-5  
    battery storage . . . . . 6-5

terminal  
    switching from 802.11 to Spring RF  
        protocol . . . . . 5-6

terminal initialization  
    program loader function . . . . . 3-2  
    sendhex command . . . . . 3-2

testing components, self test . . . . . 7-5

testing hardware components . . . . . 7-5

time required for charging . . . . . 6-6

tips  
    battery charging . . . . . 6-5  
    scanning . . . . . 5-15

troubleshooting . . . . . 7-3  
    boot failure . . . . . 7-3  
    startup failure . . . . . 7-3

## U

using the keyboard . . . . . 5-9

using the scanner . . . . . 5-12

## W

wall mounting  
    38/6860 . . . . . 2-12  
    38/6860 CCM . . . . . 2-11  
    38/6866 . . . . . 2-5

warm boot . . . . . E-1, E-2

warm start . . . . . E-1, E-2

# Tell Us What You Think...

---

We'd like to know what you think about this Manual. Please take a moment to fill out this questionnaire and fax this form to: (631) 738-3318, or mail to:

Symbol Technologies, Inc.  
One Symbol Plaza M/S B-4  
Holtsville, NY 11742-1300  
Attn: Technical Publications Manager

**IMPORTANT:** If you need product support, please call the appropriate customer support number provided. Unfortunately, we cannot provide customer support at the fax number above.

---

User's Manual Title: \_\_\_\_\_  
(please include revision level)

How familiar were you with this product before using this manual?

Very familiar    Slightly familiar    Not at all familiar

Did this manual meet your needs? If not, please explain. \_\_\_\_\_

\_\_\_\_\_

What topics need to be added to the index, if applicable? \_\_\_\_\_

\_\_\_\_\_

What topics do you feel need to be better discussed? Please be specific.

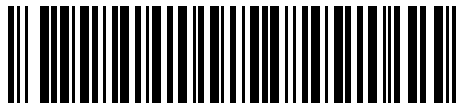
\_\_\_\_\_

What can we do to further improve our manuals? \_\_\_\_\_

\_\_\_\_\_

Thank you for your input—We value your comments.

## PDT 6800 Series Product Reference Guide



70-32645-02  
Revision A — August 2001