



# PDT 6100 Series



## Product Reference Guide



*PDT 6100 Series*  
*Product Reference Guide*

70-33222-02

*Revision A*

*June 2001*



© 2001 by Symbol Technologies, Inc. All rights reserved.

No part of this publication may be reproduced or used in any form, or by any electrical or mechanical means, without permission in writing from Symbol. This includes electronic or mechanical means, such as photocopying, recording, or information storage and retrieval systems. The material in this manual is subject to change without notice.

The software is provided strictly on an “as is” basis. All software, including firmware, furnished to the user is on a licensed basis. Symbol grants to the user a non-transferable and non-exclusive license to use each software or firmware program delivered hereunder (licensed program). Except as noted below, such license may not be assigned, sublicensed, or otherwise transferred by the user without prior written consent of Symbol. No right to copy a licensed program in whole or in part is granted, except as permitted under copyright law. The user shall not modify, merge, or incorporate any form or portion of a licensed program with other program material, create a derivative work from a licensed program, or use a licensed program in a network without written permission from Symbol. The user agrees to maintain Symbol’s copyright notice on the licensed programs delivered hereunder, and to include the same on any authorized copies it makes, in whole or in part. The user agrees not to decompile, disassemble, decode, or reverse engineer any licensed program delivered to the user or any portion thereof.

Symbol reserves the right to make changes to any software or product to improve reliability, function, or design.

Symbol does not assume any product liability arising out of, or in connection with, the application or use of any product, circuit, or application described herein.

No license is granted, either expressly or by implication, estoppel, or otherwise under any Symbol Technologies, Inc., intellectual property rights. An implied license only exists for equipment, circuits, and subsystems contained in Symbol products.

Symbol, Spectrum One, and Spectrum24 are registered trademarks of Symbol Technologies, Inc. Other product names mentioned in this manual may be trademarks or registered trademarks of their respective companies and are hereby acknowledged.

Symbol Technologies, Inc.  
One Symbol Plaza  
Holtsville, New York 11742-1300  
<http://www.symbol.com>

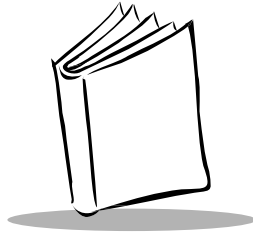

# Contents

## About This Guide

Notational Conventions . . . . .	vii
Related Publications . . . . .	vii
Service Information . . . . .	viii
Symbol Support Center . . . . .	ix
Warranty . . . . .	xi
Warranty Coverage and Procedure . . . . .	xii
General . . . . .	xii

## Chapter 1. Getting Started

Introduction . . . . .	1-1
Parts of the PDT 6100 Series Terminal . . . . .	1-2
Accessories . . . . .	1-3
Battery Chargers . . . . .	1-3
Scanners . . . . .	1-3
Connecting an External Scanner . . . . .	1-3
Radio and Network Options . . . . .	1-4
Spectrum One® Network . . . . .	1-4
Spectrum24® Network . . . . .	1-4
Printers . . . . .	1-4
Unpacking . . . . .	1-4
Miscellaneous Other Accessories . . . . .	1-4
Before You Use the Terminal . . . . .	1-4
Install and Charge Battery . . . . .	1-4
Load the Appropriate Software . . . . .	1-5

## Chapter 2. Installing the Hardware

Introduction . . . . .	2-1
Required Parts and Accessories . . . . .	2-1

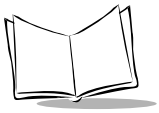

Parts of the Cradle . . . . .	2-2
Connecting the Cables . . . . .	2-3
Connecting the Internal Modem . . . . .	2-3
Connecting to the Telephone Network . . . . .	2-4

### **Chapter 3. Batch and Spectrum One Terminal Setup**

Introduction . . . . .	3-1
Hardware Requirements . . . . .	3-1
Communications . . . . .	3-2
Set up for Initialization . . . . .	3-2
Loading an Application . . . . .	3-3
Initiate Host Communications Software on the PC . . . . .	3-3
Initiate Terminal Communications . . . . .	3-4
Starting Communications . . . . .	3-6
Ending Communications . . . . .	3-7

### **Chapter 4. Spectrum24<sup>®</sup> RF Terminal Setup**

Spectrum24 Terminals . . . . .	4-1
Accessing the Flash Disk . . . . .	4-1
Standard Spectrum24 Software . . . . .	4-2

### **Chapter 5. Operating the PDT 6100 Series**

Introduction . . . . .	5-1
Powering a Terminal On and Off . . . . .	5-2
Normal Power . . . . .	5-2
Automatic Power . . . . .	5-2
Forcing Power Off . . . . .	5-3
Restarting After a Forced Power Off . . . . .	5-3
Booting the Terminal . . . . .	5-4
Warm Boot . . . . .	5-4
Cold Boot . . . . .	5-5
Cold-Boot Failure . . . . .	5-6
Boot to Command Mode . . . . .	5-6
Adjusting the Display . . . . .	5-7
Backlighting . . . . .	5-7
Display Contrast . . . . .	5-7
PDT 6100 Series Keyboard . . . . .	5-8
Using the Keyboard . . . . .	5-8
Key Descriptions . . . . .	5-10
Scanning . . . . .	5-12
Setting the Trigger . . . . .	5-12

Using the Integrated Laser Scanner . . . . .	5-13
Aiming: Hold at an Angle . . . . .	5-14
Running Communications . . . . .	5-16
Communicating with a Host . . . . .	5-16
Radio Communications . . . . .	5-17
Communicating With a Printer . . . . .	5-18

## Chapter 6. Maintaining the Terminal

Batteries . . . . .	6-1
Battery Life . . . . .	6-1
When to Replace or Recharge Batteries . . . . .	6-2
Replacement Batteries . . . . .	6-3
Installing a New or Recharged Battery Pack . . . . .	6-4
Charging the Battery . . . . .	6-5
Recharging a Spare Battery Pack . . . . .	6-7
Cleaning . . . . .	6-8
Storage . . . . .	6-8

## Chapter 7. Error Recovery and Troubleshooting

Introduction . . . . .	7-1
Error Messages . . . . .	7-1
Troubleshooting . . . . .	7-2
Start-up Failure . . . . .	7-2
Boot Failure Messages . . . . .	7-2
Spectrum24 Terminal . . . . .	7-3
Self Test Function . . . . .	7-4
Running the Self Test . . . . .	7-4
Self Test Summaries . . . . .	7-4
Keyboard Test . . . . .	7-5
Exiting Self Test . . . . .	7-8
Memory Transfer Program . . . . .	7-8
Hardware Setup . . . . .	7-8
Set Communications Parameters . . . . .	7-9
Internal Modem Problems . . . . .	7-12
Scanning Problems . . . . .	7-12
What If . . . . .	7-12

## Appendix A. Port Pin-Outs

Introduction . . . . .	A-1
Pinouts for PDT 6100 Serial Devices . . . . .	A-1

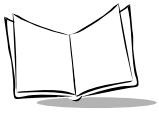

## **Appendix B. Keyboard Layouts**

Introduction.....	B-1
22-Key Keyboard.....	B-2
35-Key Keyboard.....	B-3
46-Key Keyboard .....	B-8

## **Appendix C. Communications Status Codes**

Introduction.....	C-1
-------------------	-----

## **Appendix D. Specifications**

Environment .....	D-1
-------------------	-----

## **Glossary**

## **Index**

## **Feedback**

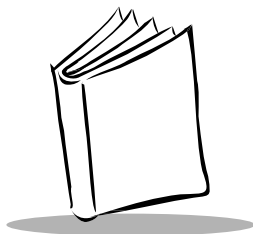

## *About This Guide*

The *PDT 6100 Product Reference Guide* provides general instructions for setup, initialization, operation, troubleshooting, and maintenance.

### **Notational Conventions**

---

The following conventions are used in this document:

- ◆ Italics are used to highlight specific items in the general text, and to identify chapters and sections in this and related documents.
- ◆ Bullets (●) indicate:
  - ◆ action items
  - ◆ lists of alternatives
  - ◆ lists of required steps that are not necessarily sequential
- ◆ Sequential lists (e.g., those that describe step-by-step procedures) appear as numbered lists.

### **Related Publications**

---

The following is a list of documents and publications that you may find useful if you want to know more about the PDT 6100 terminal itself or about the tools and utilities that are available for writing applications for the terminal.

- ◆ *PDT 6100 Quick Reference Guide*  
p/n 70-33221-XX
- ◆ *Series 3000 Application Programmer's Guide*  
p/n 70-16308-XX



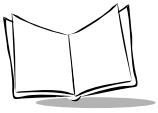

- ◆ *Series 3000 Application Programmer's Reference Manual*  
p/n 70-16309-XX
- ◆ *Series 3000 System Software Manual*  
p/n 70-16310-XX
- ◆ *Series 3000 Application Developer's Library*  
p/n 70-16311-XX
- ◆ *CRD 6100 Quick Reference Guide*  
p/n 70-33725-XX
- ◆ *Spectrum 24 Access Point User's Guide*  
p/n 70-12057-XX
- ◆ *Spectrum24 Flash Disk Addendum*  
p/n 70-31437-XX
- ◆ *Spectrum24 Network Terminal Technical Reference Guide*  
p/n 70-20193-XX
- ◆ *Novell LAN Workplace Reference Manual*  
p/n 70-20288-XX
- ◆ *Spectrum24 TNClient System Administrator's Guide*  
p/n 70-20244-XX
- ◆ *Spectrum24 STEP Installation and Configuration Guide for Series 3000 Flash Disk Terminals*  
p/n 70-20343-XX

## Service Information

---

If you have a problem with your equipment, contact the [Symbol Support Center](#) for your region. See [page ix](#) for contact information. Before calling, have the model number, serial number, and several of your bar code symbols at hand.

Call the Support Center from a phone near the scanning equipment so that the service person can try to talk you through your problem. If the equipment is found to be working properly and the problem is symbol readability, the Support Center will request samples of your bar codes for analysis at our plant.

If your problem cannot be solved over the phone, you may need to return your equipment for servicing. If that is necessary, you will be given specific directions.

---

**Note:** *Symbol Technologies is not responsible for any damages incurred during shipment if the approved shipping container is not used.*

*Shipping the units improperly can possibly void the warranty. If the original shipping container was not kept, contact Symbol to have another sent to you.*

---

## **Symbol Support Center**

For service information, warranty information or technical assistance contact or call the Symbol Support Center in:

### **United States**

Symbol Technologies, Inc.  
One Symbol Plaza  
Holtsville, New York 11742-1300  
1-800-653-5350

### **United Kingdom**

Symbol Technologies  
Symbol Place  
Winnersh Triangle, Berkshire RG41 5TP  
United Kingdom  
0800 328 2424 (Inside UK)  
+44 208 945 7529 (Outside UK)

### **Australia**

Symbol Technologies Pty. Ltd.  
432 St. Kilda Road  
Melbourne, Victoria 3004  
1-800-672-906 (Inside Australia)  
+61-3-9866-6044 (Outside Australia)

### **Denmark**

Symbol Technologies AS  
Gydevang 2,  
DK-3450 Allerod, Denmark  
7020-1718 (Inside Denmark)  
+45-7020-1718 (Outside Denmark)

### **Canada**

Symbol Technologies Canada, Inc.  
2540 Matheson Boulevard East  
Mississauga, Ontario, Canada L4W 4Z2  
905-629-7226

### **Asia/Pacific**

Symbol Technologies Asia, Inc.  
230 Victoria Street #04-05  
Bugis Junction Office Tower  
Singapore 188024  
337-6588 (Inside Singapore)  
+65-337-6588 (Outside Singapore)

### **Austria**

Symbol Technologies Austria GmbH  
Prinz-Eugen Strasse 70  
Suite 3  
2.Haus, 5.Stock  
1040 Vienna, Austria  
1-505-5794 (Inside Austria)  
+43-1-505-5794 (Outside Austria)

### **Europe/Mid-East Distributor Operations**

Contact your local distributor or call  
+44 118 945 7360

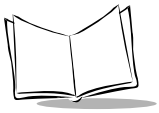

## *PDT 6100 Series Product Reference Guide*

### **Finland**

Oy Symbol Technologies  
Kaupintie 8 A 6  
FIN-00440 Helsinki, Finland  
9 5407 580 (Inside Finland)  
+358 9 5407 580 (Outside Finland)

### **Germany**

Symbol Technologies GmbH  
Waldstrasse 68  
D-63128 Dietzenbach, Germany  
6074-49020 (Inside Germany)  
+49-6074-49020 (Outside Germany)

### **Latin America Sales Support**

7900 Glades Road  
Suite 340  
Boca Raton, Florida 33434 USA  
1-800-347-0178 (Inside United States)  
+1-561-483-1275 (Outside United States)

### **Netherlands**

Symbol Technologies  
Kerkplein 2, 7051 CX  
Postbus 24 7050 AA  
Varsseveld, Netherlands  
315-271700 (Inside Netherlands)  
+31-315-271700 (Outside Netherlands)

### **France**

Symbol Technologies France  
Centre d'Affaire d'Antony  
3 Rue de la Renaissance  
92184 Antony Cedex, France  
01-40-96-52-21 (Inside France)  
+33-1-40-96-52-50 (Outside France)

### **Italy**

Symbol Technologies Italia S.R.L.  
Via Cristoforo Columbo, 49  
20090 Trezzano S/N Naviglio  
Milano, Italy  
2-484441 (Inside Italy)  
+39-02-484441 (Outside Italy)

### **Mexico**

Symbol Technologies Mexico Ltd.  
Torre Picasso  
Boulevard Manuel Avila Camacho No 88  
Lomas de Chapultepec CP 11000  
Mexico City, DF, Mexico  
5-520-1835 (Inside Mexico)  
+52-5-520-1835 (Outside Mexico)

### **Norway**

Symbol Technologies  
Trollasveien 36  
Postboks 72  
1414 Trollasen, Norway  
66810600 (Inside Norway)  
+47-66810600 (Outside Norway)

### **South Africa**

Symbol Technologies Africa Inc.  
Block B2  
Rutherford Estate  
1 Scott Street  
Waverly 2090 Johannesburg  
Republic of South Africa  
11-4405668 (Inside South Africa)  
+27-11-4405668 (Outside South Africa)

### **Spain**

Symbol Technologies S.A.  
Edificio la Piovera Azul  
C. Peonias, No. 2 - Sexta Planta  
28042 Madrid, Spain  
9-1-320-39-09 (Inside Spain)  
+34-9-1-320-39-09 (Outside Spain)

### **Sweden**

Symbol Technologies AB  
Albygatan 109D  
Solna  
Sweden  
84452900 (Inside Sweden)  
+46 84452900 (Outside Sweden)

If you purchased your Symbol product from a Symbol Business Partner, contact that Business Partner for service.

## **Warranty**

---

Symbol Technologies, Inc (“Symbol”) manufactures its hardware products in accordance with industry-standard practices. Symbol warrants that for a period of twelve (12) months from date of shipment, products will be free from defects in materials and workmanship.

This warranty is provided to the original owner only and is not transferable to any third party. It shall not apply to any product (i) which has been repaired or altered unless done or approved by Symbol, (ii) which has not been maintained in accordance with any operating or handling instructions supplied by Symbol, (iii) which has been subjected to unusual physical or electrical stress, misuse, abuse, power shortage, negligence or accident or (iv) which has been used other than in accordance with the product operating and handling instructions. Preventive maintenance is the responsibility of customer and is not covered under this warranty.

Wear items and accessories having a Symbol serial number, will carry a 90-day limited warranty. Non-serialized items will carry a 30-day limited warranty.

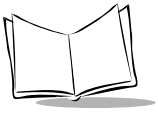

## **Warranty Coverage and Procedure**

During the warranty period, Symbol will repair or replace defective products returned to Symbol's manufacturing plant in the US. For warranty service in North America, call the Symbol Support Center at 1-800-653-5350. International customers should contact the local Symbol office or support center. If warranty service is required, Symbol will issue a Return Material Authorization Number. Products must be shipped in the original or comparable packaging, shipping and insurance charges prepaid. Symbol will ship the repaired or replacement product freight and insurance prepaid in North America. Shipments from the US or other locations will be made F.O.B. Symbol's manufacturing plant.

Symbol will use new or refurbished parts at its discretion and will own all parts removed from repaired products. Customer will pay for the replacement product in case it does not return the replaced product to Symbol within 3 days of receipt of the replacement product. The process for return and customer's charges will be in accordance with Symbol's Exchange Policy in effect at the time of the exchange.

Customer accepts full responsibility for its software and data including the appropriate backup thereof.

Repair or replacement of a product during warranty will not extend the original warranty term.

Symbol's Customer Service organization offers an array of service plans, such as on-site, depot, or phone support, that can be implemented to meet customer's special operational requirements and are available at a substantial discount during warranty period.

## **General**

Except for the warranties stated above, Symbol disclaims all warranties, express or implied, on products furnished hereunder, including without limitation implied warranties of merchantability and fitness for a particular purpose. The stated express warranties are in lieu of all obligations or liabilities on part of Symbol for damages, including without limitation, special, indirect, or consequential damages arising out of or in connection with the use or performance of the product.

Seller's liability for damages to buyer or others resulting from the use of any product, shall in no way exceed the purchase price of said product, except in instances of injury to persons or property.

Some states (or jurisdictions) do not allow the exclusion or limitation of incidental or consequential damages, so the proceeding exclusion or limitation may not apply to you.

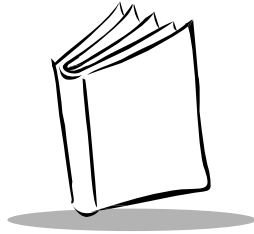

# *Chapter 1*

## *Getting Started*

### **Introduction**

---

The PDT 6100 terminal is a lightweight, battery powered, hand-held portable data collection device. Data is entered from the keyboard or an integrated laser scanner.

As a remote terminal, the PDT 6100 collects and stores data that is later uploaded to a host computer. The 6100 Series terminals include:

- ◆ PDT 6100 - batch terminal (no radio)
- ◆ PDT 6110 - Spectrum One<sup>®</sup> network
- ◆ PDT 6142 - 2 Mb Spectrum24<sup>®</sup> radio network
- ◆ PDT 6146 - 11 Mb Spectrum24<sup>®</sup> radio network

The operating system is DR DOS<sup>™</sup>, version 3.41. It is compatible with and extends the industry-standard IBM PC-DOS<sup>™</sup>. DR DOS provides access to a number of commercially available programming tools. Additional programming tools are available from Symbol for easier system programming and access to special features.

Power saving features of the PDT 6100 includes auto-off and power save modes, which reduce power consumption until an operator provides input. These features conserve battery power, lengthening the time between charges or replacement.

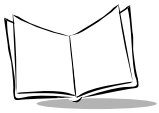

# Parts of the PDT 6100 Series Terminal

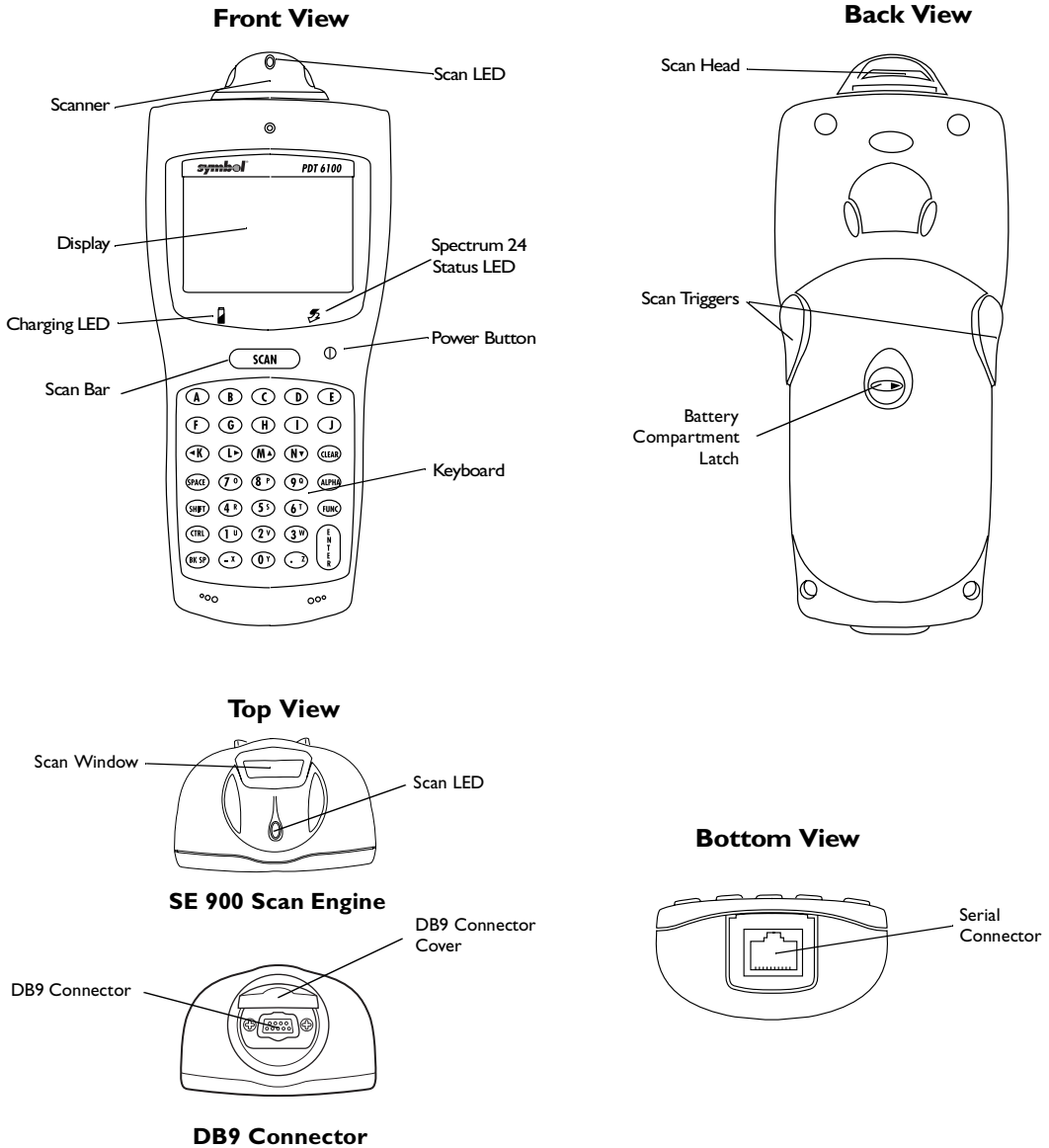

Figure I-1. Parts of the PDT 6100

## Accessories

---

The following accessories are available for the PDT 6100 terminal.

### Battery Chargers

PDT 6100 Series terminals use rechargeable Nickel Metal Hydride (NiMH) battery packs. NiMH batteries are charged using one of the charging accessories listed below.

**Table I-1. Battery Charging Accessories**

Accessory	Part Number
Single-Slot Cradle	CRD 6100-1000
UBC 2000	6004-xxx
Charging and Communications Cable (with power supply)	25-33665-01
Four-Slot Cradle	CRD 6100-4000 (not yet available)

## Scanners

---

The terminal uses:

- ◆ integrated, standard-range, 1-D bar code scanner
- ◆ external scanner with DB9 connector.

### Connecting an External Scanner

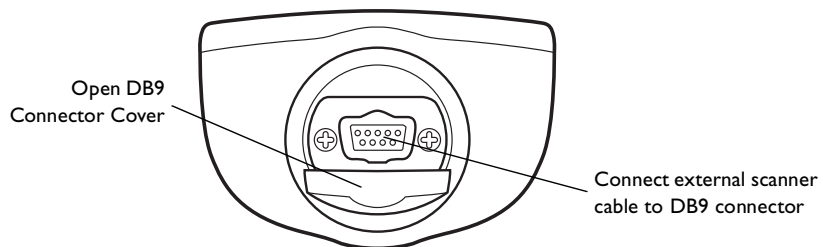

**Figure I-1. Connecting an External Scanner**



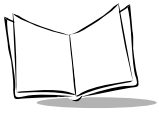

## Radio and Network Options

---

### **Spectrum One® Network**

The PDT 6110 includes an internal radio frequency transmitter/receiver for use in a Symbol Spectrum One network.

### **Spectrum24® Network**

The PDT 6142 and PDT 6146 include an internal radio frequency transmitter/receiver for use in a Symbol Spectrum24 network.

### **Printers**

The following printers can be used with the terminal:

- ◆ Monarch Rascal
- ◆ Monarch Renegade
- ◆ ComTec 2-inch, 4-inch, and 6-inch receipt printers

## Unpacking

---

Remove the clear protective tape from the display and the optical connector.

Save the shipping container for later storage or shipping. Inspect all equipment for damage and make sure you have received everything listed on the packing slip.

If you find anything unsatisfactory or missing, contact your authorized customer support representative immediately.

### **Miscellaneous Other Accessories**

A holster and other terminal storing/carrying devices are available for use with the PDT 6100.

## Before You Use the Terminal

---

### **Install and Charge Battery**

Prior to using the PDT 6100 for the first time, install the NiMH battery. Be sure to charge the battery before use. Refer to [Chapter 6, Maintaining the Terminal](#).

## **Load the Appropriate Software**

What software you load and how you load it depends on several factors:

- ◆ If this unit is intended for use in batch applications (6100) or in a Spectrum One network environment (PDT 6110), refer to [Chapter 3, \*Batch and Spectrum One Terminal Setup\*](#) for information on loading the software.
- ◆ If this unit is intended for use in a Spectrum24 network environment (PDT 6142 or PDT 6146), refer to [Chapter 4, \*Spectrum24® RF Terminal Setup\*](#) for general information on Spectrum24.

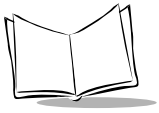

*PDT 6100 Product Reference Guide*

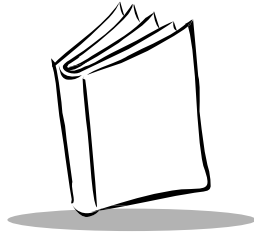

## *Chapter 2*

# *Installing the Hardware*

### **Introduction**

---

The CRD 6100 cradle is used for RS-232 communications, charging, and storing the PDT 6100 terminal.

This chapter provides information on setting up the cradle for charging the NiMH battery and communicating with a host or other serial device.

### **Required Parts and Accessories**

---

Verify that you have the following cradle parts, cables, and other kits/accessories before attempting to mount or connect the cradle:

- ◆ One-slot 61XX cradle with spare battery charging slot
- ◆ RS-232 Null Modem Cable, DB-25 Male to DB-25 Female or DB-25 Male to DB-9 Female
- ◆ AC Power Supply (p/n 50-14000-086)
- ◆ Power cord.

Save the shipping container for storing or shipping the cradle. Inspect all equipment for damage. If anything is damaged or missing, call your authorized customer support representative immediately.

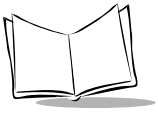

## Parts of the Cradle

---

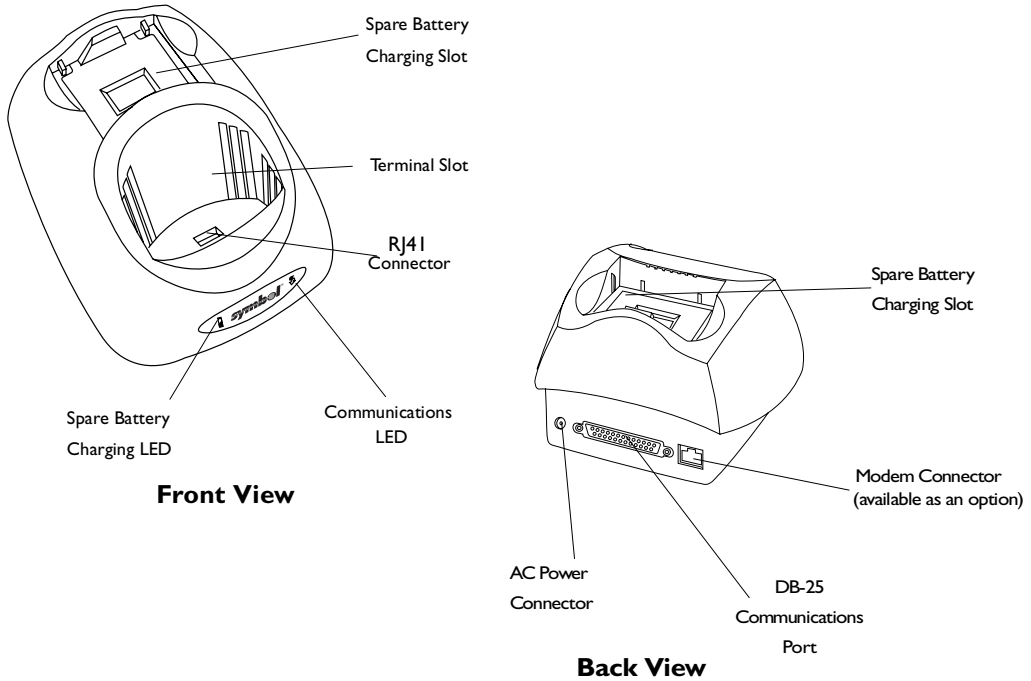
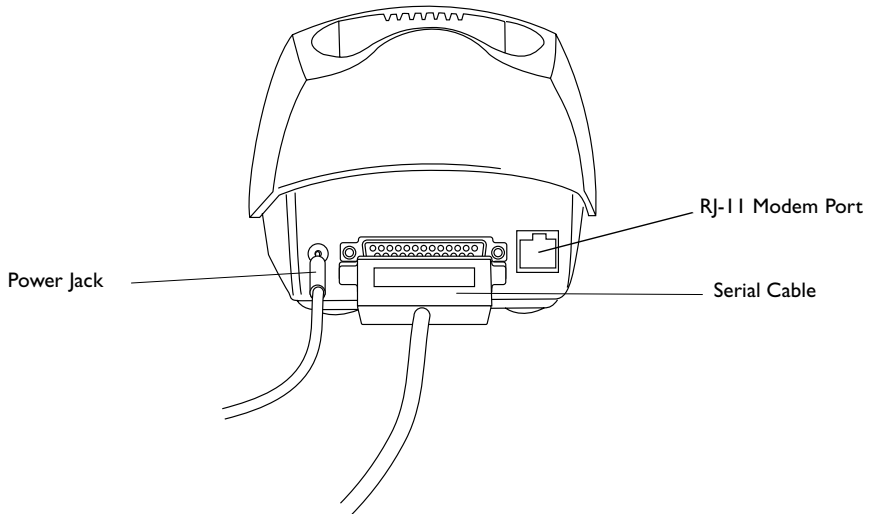

Figure 2-1. Parts of the Cradle

## Connecting the Cables

---

To connect the CRD 61XX communications cables and power supply:



**Figure 2-2. Connecting the Cables**

1. Plug the RS-232 serial cable in the communications port located on the back of the cradle.
2. Connect the serial cable's other end to the host PC's communications port.
3. Connect the power jack to the cradle's AC power port.
4. Connect the power supply to a line cord.
5. Insert the line cord's connector in a standard electrical outlet.

## Connecting the Internal Modem

---

Some cradles use an optional internal modem that communicates at rates of up to 14,400 bps (with v.32 bit data compression). It can be connected directly to a telephone line through the RJ-11 port shown in [Figure 2-2](#).

---

**Note:** *The four-slot cradle does **not** have an internal modem.*

---

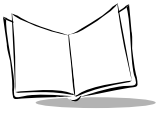

To connect the internal modem:

1. Connect the phone cord into the RJ-11 port on the back of the cradle.
2. Connect the other end of the phone cord into the wall phone jack.

### *Caution*

When connecting the internal modem to the phone line, always connect the phone line to the cradle first, then to the wall phone jack. When removing the connection, always remove the telephone line from the wall phone jack, then remove from the cradle.

There are specific firmware settings which are used to configure the modem's hardware and software for proper operation and regulatory compliance. The terminal's application can control these settings and enable you to view and amend the settings for country/region, pulse/tone dialing, or repeat dial timing. Incorrectly defining these settings can lead to illegal use of the modem and can create unreliable operation. The application developer should consult the Series 3000 Application Programmer's Reference Manual for correct settings.

## **Connecting to the Telephone Network**

---

A compliant telephone cord is required with an RJ-11 plug connection to the modem, terminated with an appropriate and correctly wired local telecom connector compatible with the telephone network. Such a cable may be obtained from your local supplier. Alternately, compliant RJ-11 plugs to RJ-11 plug cables may be used with a range of adapters for locations such as Europe.

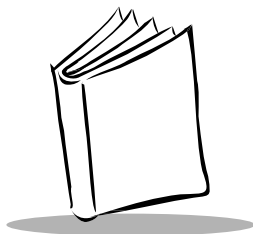

## Chapter 3

# *Batch and Spectrum One Terminal Setup*

### **Introduction**

---

Before using the PDT 6100 system, perform the following procedures:

- ◆ Set up the CRD 6100 cradle (refer to [Chapter 2, \*Installing the Hardware\*](#))
- ◆ Install the battery (refer to [Chapter 6, \*Maintaining the Terminal\*](#))
- ◆ Charge the battery (refer to [Chapter 6, \*Maintaining the Terminal\*](#))
- ◆ Load the system files and application(s).

### **Hardware Requirements**

---

Hardware required for performing initialization includes:

- ◆ Host PC
- ◆ RS-232 serial null modem cable
- ◆ PDT 6100 terminal
- ◆ Cradle with power supply.

Refer to [Chapter 2, \*Installing the Hardware\*](#) for setting up the cradle for communication.



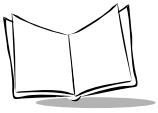

## Communications

---

For terminals being used in a direct communications (batch) environment or a Spectrum One network environment, applications are transferred from a host computer over a communications line to the terminal.

This procedure uses the SENDHEX program on the host computer and the Program Loader function (from Command Mode) on the PDT 6100.

Programs are stored in the terminal's nonvolatile memory (NVM), also called the application EEPROM.

For details on SENDHEX, refer to the *Series 3000 Application Programmer's Manual*.

Other software may be used in place of the SENDHEX program.

## Set up for Initialization

---

1. Verify that the cradle is connected to the host PC. Refer to [Chapter 2, \*Installing the Hardware\*](#).
2. Place the PDT 6100 in the cradle (refer to [Figure 3-1](#)) and power it off.

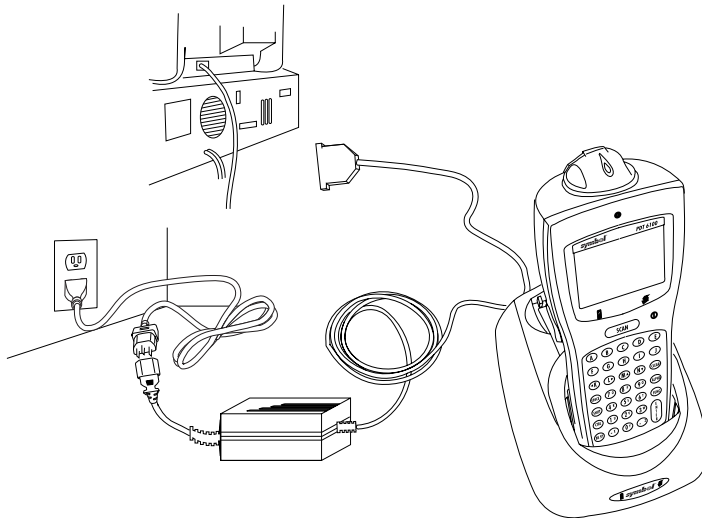

**Figure 3-1. Placing the PDT 6100 in the Cradle**

## Loading an Application

---

To download an application, initiate the communications software on the host computer and PDT 6100.

---

**Note:** *To cancel communications at any time during the session, press CLEAR on the PDT 6100. The session stops immediately.*

*Communication parameters specified on host and PDT 6100 must match. These parameters typically are:*

*38400 bps  
7 bit data  
Odd parity  
None*

*The PDT 6100 must be connected to the host through a cradle to program the NVM.*

---

## Initiate Host Communications Software on the PC

1. Power on host computer.
2. Start the communication program.
3. At a DOS prompt, enter the SENDHEX command:

```
sendhex pgmname 38400 com2
```

where:

SENDHEX	is the command.
pgmname	is the application being loaded (.hex extension is optional).
parameters	are the communications parameters following the program name. Parameters include baud rate, communications port, data bits, parity, and flow control. To accept the default parameters, do not enter a value.

In the example, baud rate is set to 38400 bps and communications port to COM2. The default values are accepted for the remaining parameters.

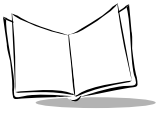

---

**Note:** *Versions of SENDHEX earlier than 3.0 do not support flow control. If you use an earlier version and encounter communication errors, use a lower baud rate. If you use a later version of SENDHEX and have communications errors, try setting flow control to XON/XOFF.*

---

4. SENDHEX displays the prompt:

Press <ENTER> to begin  
communications.

5. Do NOT press <ENTER> yet. Before starting communications (refer to [Starting Communications](#) on page 3-6), set up the PDT 6100 for loading a HEX image as directed in the following sections.

## **Initiate Terminal Communications**

1. Boot the PDT 6100 to command mode.

For the 22-Key terminal:

- ♦ Press and hold <SEND> and <9>.
- ♦ Press and release PWR.
- ♦ Release <SEND> and <9>.

For the 35-Key terminal:

- ♦ Press and hold <BKSP> and <SHIFT>.
- ♦ Press and release PWR.
- ♦ Release <BKSP> and <SHIFT>.

For the 46-Key terminal:

- ♦ Press and hold <F> and <I>.
- ♦ Press and release <PWR>.
- ♦ Release <F> and <I>.

The display shows the function selector screen:

COMMAND MODE

Select function  
Self Test

2. Scroll through Command Mode options using UpArrow or DownArrow until “Program loader” is displayed. Press <ENTER>.
3. The PDT 6100 displays:

```
Program loader
WARNING: NVM
WILL BE ERASED
CONTINUE? <ENT>
```

Before loading the new application, erase NVM's original contents.

---

**Note:** *To cancel this operation, press <CLEAR>.*

---

4. Press <ENTER> to erase the NVM.  
Wait while the NVM is erased. When complete, the program prompts for the communications parameters.
5. Baud Rate. The PDT 6100 displays:

```
Comm Parameters

Baud
5      38400
```

Scroll through the list using UpArrow or DownArrow. When the correct rate is displayed (38400 is recommended), press <ENTER>.

6. Data Bits. The PDT 6100 displays:

```
Comm Parameters

Data Bits
7
```

Press <7> (recommended) or <8> to specify data bits, or scroll through the list using UpArrow and DownArrow. Press <ENTER> when the correct value is displayed.

---

**Note:** *If 8 data bits is selected, the program selects “No parity” and skips the next step.*

---

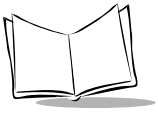

7. Parity. If 7 data bits is selected, the PDT 6100 displays:

Comm Parameters

Parity

Odd

Press the first letter of a parity option (Even, Odd, None, Space, or Mark), or scroll using UpArrow and DownArrow and press <ENTER> when the correct value is displayed.

8. Flow Control. The PDT 6100 displays:

Comm Parameters

Flow Control

None

Press the first letter of a flow control option (None, Xon/Xoff, or RTS/CTS), or scroll using UpArrow or DownArrow and press <ENTER> when the correct value is displayed.

9. Go to *Starting Communications* to continue.

## **Starting Communications**

The PDT 6100 is ready to receive the program from the host PC and displays:

Comm Parameters

Start? <ENT>

1. Press <ENTER> on the PDT 6100. The PDT 6100 waits a few seconds for the host PC to initiate communications. While waiting, the PDT 6100 displays:

Comm Parameters

Receiving:

If the host is not ready or the cable is not connected between the host PC and cradle, the terminal displays:

Awaiting DSR

2. Press <ENTER> on the host computer. SENDHEX begins transmitting the program image. When communications are established, the PDT 6100 displays:

Program loader

Receiving: XXXX

where XXXX is the program segment address being transferred.

3. When the transmission is complete, the PDT 6100 displays:

Program loader

Status 0000

A status of 0000 (all zeros) indicates a successful transfer. Other status values indicate an error. These values are provided in [Appendix C, Communications Status Codes](#).

## **Ending Communications**

To return to the Command Mode main menu:

1. Press <CLEAR> on the PDT 6100.
2. Power down the PDT 6100.
3. Remove the PDT 6100 from the cradle.
4. Reboot the PDT 6100 using the appropriate cold boot sequence described in [Booting the Terminal](#) on page 5-4.

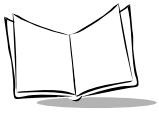

*PDT 6100 Product Reference Guide*

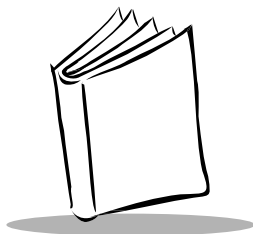

## Chapter 4

# Spectrum24<sup>®</sup> RF Terminal Setup

### Spectrum24 Terminals

---

In Spectrum24 terminals, wireless connectivity is accomplished using standard communications protocols. Because they are standard, the protocols are generalized and take up considerably more space on the terminal's NVM than is required for Spectrum One<sup>®</sup> terminals. Because there is less space available in NVM for application files, the terminal operates with an additional megabyte of non-volatile memory or *flash disk*. This extra memory is used to reduce not only the boot times but also the time and resources required to load applications into the terminal. The flash disk also offers the possibility of running multiple applications from the same terminal (refer to the *Spectrum24 Terminal Setup and Utilities Reference Guide* p/n 72-50795-01 for more information). With version 3.03 or later of the system software (LWP.HEX), the terminal can also run diagnostic tools.

#### **Accessing the Flash Disk**

The flash disk is accessed through a driver, FLASHDSK.SYS, which makes the flash disk appear to a program as another disk drive (E:). The drive has characteristics of fast reading but slow writing (for example, even for the smallest files, the write process takes 3-4 seconds). These characteristics make it ideal for files that are written once, accessed often, and seldom updated.

We recommend that you use the flash disk (E:) mainly for application and configuration file storage. It is important to note that because of the slow writing time (3-4 seconds), writing files during a power interruption (low battery, dead battery, suspend, power off, or power failure) could corrupt the disk. Be sure to only write data to the disk with the terminal connected to external power or with the battery fully charged to avoid problems. To avoid overwriting the flash disk by mistake, the flash disk is set to read-only mode for normal operation. The software installation or application software takes care of write/read mode switching for you.



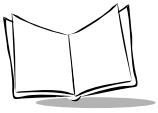

## Standard Spectrum24 Software

---

The terminal comes with the system software installed, including:

- ◆ Spectrum24 radio drivers
- ◆ TCP/IP software
- ◆ configuration files
- ◆ various utilities.

A BIOS of version 3.08 or later is required.

The default files cover most expected installations/initializations with minor changes as detailed in this chapter.

If your requirements are more advanced, refer to the *Spectrum24 Network Terminal Technical Reference Guide* (p/n 70-20193-XX) for more information on the Spectrum24 RF network, SLAODI.COM, the Symbol-provided ODI driver, and the configuration file setups required for various platforms.

Refer to the *Spectrum24 Terminal Setup and Utilities Reference Guide* (p/n 72-50795-XX) for more information on Spectrum24 boot options, addressing, initializing the terminal, and Access Point (AP) associations.

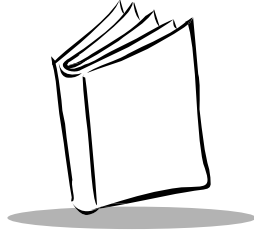

## *Chapter 5*

# *Operating the PDT 6100 Series*

### **Introduction**

---

This chapter describes how to operate a PDT 6100 terminal, including:

- ◆ Powering the terminal on/off
- ◆ Booting the terminal
- ◆ Adjusting the display's contrast
- ◆ Entering data using the keyboard
- ◆ Entering data through the integrated scanner
- ◆ Communicating with other devices using the Charging and Communications Cable.

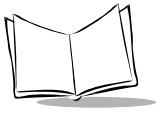

## Powering a Terminal On and Off

---

Because the terminal is battery powered, it is important to save power whenever possible. You can minimize power loss and increase battery life by turning the terminal off when data is not being entered.

While the terminal's processor and display are off, programs or data in the system's memory are retained. Before the terminal powers up, it checks the batteries for enough power to ensure reliable operation and data storage. Power-up restores the display, and processing continues from where it was before power-down.

Powering the terminal on does not boot the system or initialize either the program or data. For more information on initialization, refer to [Chapter 3, Batch and Spectrum One Terminal Setup](#).

### Normal Power

---

*Note: Charge the NiMH battery before use!*

---

To power the terminal on or off, press <Ⓛ> (PWR).

### Automatic Power

Depending on the application, a number of other events may turn a terminal on or off.

#### Power On

- ◆ The system powers on when a key other than <Ⓛ> (PWR) is pressed.
- ◆ The system powers on when a scanner trigger is pressed.
- ◆ The program powers on the system at a preset time to perform unattended operations, such as an overnight communications session.
- ◆ The program powers on the system in response to a modem ring or an RS-232 device connected to the RJ connector.

#### Power Off

If not used for a specific period of time, as determined by the application, the system powers off automatically to conserve power.

## **Forcing Power Off**

If a terminal freezes in the middle of operation and pressing <Ⓚ> (PWR) does not power it off, you can force the system to power off, which reduces the drain on the batteries until you can download any collected data to the host system.

To force the system to power off, press and hold <Ⓚ> (PWR) for 15-20 seconds.

Since the terminal is still frozen at this time, turning the power back on does not solve the problem. To recover the data held in memory, perform a Warm Boot (refer to *Booting the Terminal* on page 5-4).

## **Restarting After a Forced Power Off**

If an operator is forced to power down a terminal because of defective software, the System Administrator should restart the system using the warm or cold boot procedures in the following section.

---

**Note:** *Do not use the power key to restart if the terminal was forced off due to defective system or application program software in NVM. Pressing <Ⓚ> (PWR) only causes the program to resume where it left off, trying to perform the same unsuccessful operation.*

---

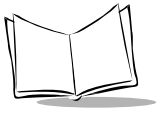

## Booting the Terminal

---

Powering the terminal on does not boot the system or initialize the program or data. To initialize the terminal, perform either a warm or cold boot.

### Warm Boot

A warm boot resets the operating system while preserving the program and data on the RAM disk. This process is similar to pressing the <Ctrl+Alt+Del> keys on a PC, except that it does not clear the system's memory. To perform a warm boot:

For the 22-Key terminal:

- ♦ Power the terminal off
- ♦ Press and hold *Down Arrow* and *Period*
- ♦ Press and release <PWR>
- ♦ Release *Down Arrow* and *Period*.

For the 35-Key terminal:

- ♦ Power the terminal off
- ♦ Press and hold <F> and <J>.
- ♦ Press and release <PWR>.
- ♦ Release <F> and <J>.

For the 46-Key terminal:

- ♦ Power the terminal off
- ♦ Press and hold <4> and <5>.
- ♦ Press and release <PWR>.
- ♦ Release <4> and <5>.

The terminal displays a copyright message, RAM size, expanded memory RAM size, etc., depending on the system's configuration. Other information displayed depends on the operating system, installed device drivers, and AUTOEXEC.BAT commands. If this warm boot procedure fails to restart the terminal, use the [Cold Boot](#) procedure.

---

**Note:** *If the batteries are replaced and the supercap is discharged, the terminal cold boots.*

---

## **Cold Boot**

A cold boot fully resets the system and clears memory, including the RAM disk. Any programs and data stored in memory or on the RAM disk are deleted. Nonvolatile memory (NVM — the Application EEPROM) is not affected. If the cold-boot procedure fails to restart the terminal, refer to [Chapter 7, Error Recovery and Troubleshooting](#).

### *Caution*

This procedure permanently erases all data and software in the terminal unless they reside in NVM. Contents of RAM are lost.

To perform a cold boot:

For the 22-Key terminal:

- ♦ Power the terminal off
- ♦ Press and hold *Up Arrow*, <4>, and <ENTER>
- ♦ Press and release <PWR>
- ♦ Release *Up Arrow*, <4>, and <ENTER>.

For the 35-Key terminal:

- ♦ Power the terminal off
- ♦ Press and hold <SPACE>, <FUNC>, and Up Arrow
- ♦ Press and release <PWR>
- ♦ Release <SPACE>, <FUNC>, and Up Arrow.

For the 46-Key terminal:

- ♦ Power the terminal off
- ♦ Press and hold <A>, <B>, and <D>
- ♦ Press and release <PWR>
- ♦ Release <A>, <B>, and <D>.

The terminal displays version information, copyright, RAM size, and installed expanded memory RAM size. Other information displayed depends on the operating system, installed device drivers, and AUTOEXEC.BAT commands.

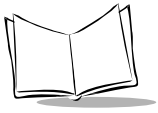

## Cold-Boot Failure

During a cold boot, the system briefly displays a status line for each driver as it loads in the format:

```
0: Driver    #.##
```

The line shows a status value, usually 0, followed by the name and version number of the driver. If the system halts at one of these lines and displays a status value other than 0, the displayed device driver failed to load properly.

If such a failure occurs, try cold booting the terminal again. If this does not solve the problem, call the Symbol Support Center.

More troubleshooting information is provided in the publications listed in [Related Publications](#) at the beginning of this manual.

## Boot to Command Mode

Command Mode provides functions for:

- ♦ Running the Self-Test program to verify that the hardware is operating properly (refer to [Chapter 7, Error Recovery and Troubleshooting](#)).
- ♦ Performing a Memory Transfer to upload data from a terminal to a host system (refer to [Chapter 7, Error Recovery and Troubleshooting](#)).
- ♦ Performing a Program Download to transfer an application from the host to a terminal (refer to [Chapter 3, Batch and Spectrum One Terminal Setup](#)).

To boot to Command Mode:

For the 22-Key terminal:

- ♦ Power the terminal off
- ♦ Press and hold <SEND> and <9>.
- ♦ Press and release <PWR>.
- ♦ Release <SEND> and <9>.

For the 35-Key terminal:

- ♦ Power the terminal off
- ♦ Press and hold <BKSP> and <SHIFT>.
- ♦ Press and release <PWR>.
- ♦ Release <BKSP> and <SHIFT>.

For the 46-Key terminal:

- ♦ Power the terminal off
- ♦ Press and hold <F> and <I>.
- ♦ Press and release <PWR>.
- ♦ Release <F> and <I>.

## Adjusting the Display

---

### **Backlighting**

The terminal's backlight illuminates the display in dimly lit areas.

---

*Note: Use of backlighting can significantly reduce battery life.*

---

To turn the backlight on or off, press the following keys in sequence:

<Func> then <L> (Lamp)

The backlight also turns off when a terminal is powered off or when a timeout set by the application occurs.

### **Display Contrast**

The LCD display contrast is adjustable, making the display more readable in different lighting conditions, at various temperatures, with different attachments, and at other viewing angles.

To increase contrast (darken) by one step, press the following keys in sequence:

<Func> then <X>

To decrease contrast (lighten) by one step, press:

<Func> then <Z>



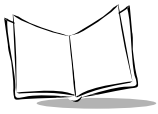

## PDT 6100 Series Keyboard

---

The keyboard is used for entering data and issuing commands to the terminal. [Figure 5-1](#), [Figure 5-2](#), and [Figure 5-3](#) illustrate the standard 22-key, 35-key, and 46-key keyboards respectively. Refer to [Appendix B, Keyboard Layouts](#) for more information.

The keys on the keyboard are distinguished as modifier keys and character keys. Because terminal keyboards have fewer keys than PC keyboards, each character key can produce more than the usual one or two characters. The four modifier keys, **Shift**, **Alpha**, **Ctrl**, and **Func**, used individually or in combination, determine which character or special function the character keys produce.

### Using the Keyboard

Except for during boot operations, the terminal expects the operator to press keys one at a time. If ERR3000 is loaded, and if two or more keys are pressed simultaneously, the system indicates a Double Key error:

The keyboard also has an optionally configurable auto-repeat function. If the application allows, a character repeats as long as the key is held down. If the key is pressed immediately following a modifier key, the modifier sequence affects only the first occurrence of the character key.

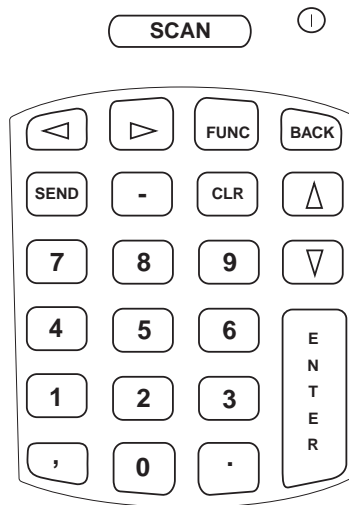

**Figure 5-1. PDT 6100 Standard 22-Key Keyboard**

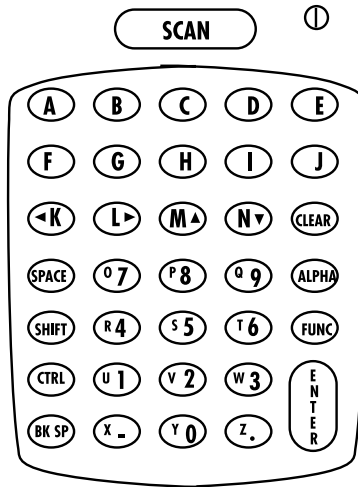

**Figure 5-2. PDT 6100 Standard 35-Key Keyboard**

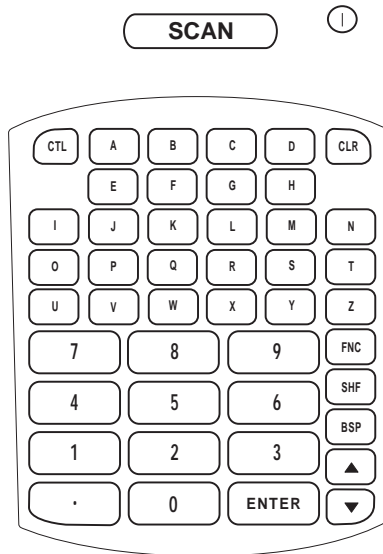

**Figure 5-3. PDT 6100 Standard 46-Key Keyboard**

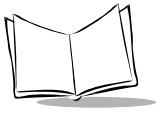

## Modifier Keys

The Shift, Alpha, Function, and Control keys are modifier keys. When pressed individually or in certain combinations, these keys change the keyboard state and possibly the character produced by the character key subsequently pressed.

For example:

- ◆ Pressing <Alpha> causes the numeric keys to produce letters.
- ◆ Pressing <Func> followed by <Ctrl> produces Alt characters, with the same effect as pressing the Alt key on a PC.
- ◆ Pressing <Func> and a scanner trigger enables that trigger for scanning. Refer to the section *Scanning* on page 5-12 for more information.
- ◆ The opposite trigger is another Alpha key (Alpha Shift), producing capital letters. It is active only when held down.
- ◆ The <Alpha> key on the keyboard affects all succeeding character keys until <Alpha> is pressed again. The other modifier keys affect only the next character key.

Refer to [Appendix B, Keyboard Layouts](#) for the characters and operations produced by pressing a sequence of modifier keys on the standard terminal keyboards. These key assignments can be changed by an application. Refer to your application documentation for any special key assignments.

## Cancelling a Modifier Key

To cancel the effect of a modifier key, press it again.

## Keyboard State

The cursor's shape indicates the current keyboard state, unless changed by the application. The standard cursor shapes are shown in [Table 6-2 on page 6-3](#).

## Key Descriptions

Most of the keys are self-explanatory. Letter keys produce letters, number keys produce numbers. Keys that perform special functions are described in [Table](#) .

Table 5-1. Special Keys

22-Key Key Name	35-Key Key Name	46-Key Key Name	Description
	CTRL (Control)	CTL (Control)	Invokes the control command.
FUNC	FUNC (Function)	FUNC (Function)	Invokes the function command for certain utilities, such as turning on the back light. <ul style="list-style-type: none"> <li>♦ Press FUNC and the corresponding numeric key to produce function keys F1 to F10.</li> <li>♦ Press FUNC, then to scroll left and FUNC to scroll right.</li> <li>♦ Press FUNC then BKSP to enter a blank space.</li> </ul>
BACK	BKSP (Backspace)	BKSP (Backspace)	Erases information entered on the display one character at a time. Information erased this way cannot be recovered. This key is also used to produce a break by pressing CTL, BKSP.
	PWR (Power)	PWR (Power)	Turns the terminal on and off.
	CLEAR	CLR (Clear)	Partially or completely escapes from an application level or screen. CLR also clears all data typed from the display.
	SHIFT	SHF (Shift)	Accesses the shifted keyboard.
ENTER	ENTER	ENTER	Places entered data into the terminal's memory.
		▲▼	Move the cursor up, down. Press FUNC then ▲ to scroll left; press FUNC then ▼ to scroll right. Arrow key use depends on the application.
▲▼	↑ ↓		Moves the cursor up, down.
← →	← →		Move the cursor left, right.
	ALPHA		Shifts the keyboard to produce alphabetic characters.
	SPACE		Places a blank space on a line of the display.
SEND			Allows you to send data to the host.

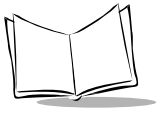

## Scanning

---

Before scanning can occur, the application must implement routines to support bar code scanning. For information on scanning applications and on programming the scanner, refer to the *Series 3000 Application Development Kit*.

The PDT 6100 terminal supports an integrated 1-D standard scanning device.

### Setting the Trigger

The integrated scanner has a unique trigger that the operator can configure. To use the integrated laser scanner:

1. Power on the system and scanner by pressing <Ⓚ> (PWR) or the scanner trigger.
2. Lift up and turn the scan element on the top of the terminal to the preferred orientation for scanning (refer to [Figure 5-4](#)). The scan head turns only toward the back of the terminal.

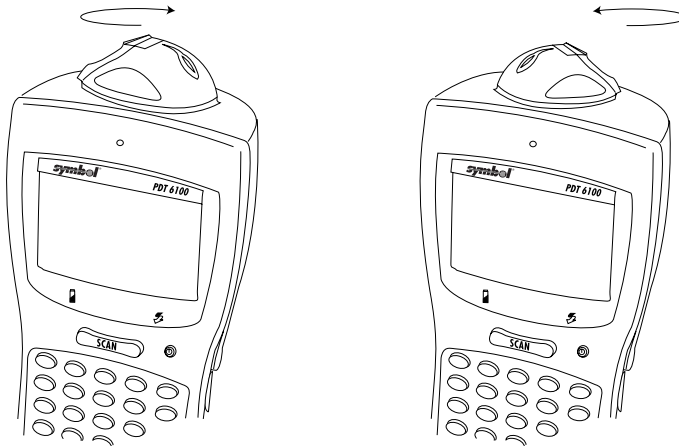

Figure 5-4. Positioning the Integrated Scanner

3. Lock the scan head in position, facing the side of the terminal.
4. To select the trigger, press the <FUNC> key and the trigger you are most comfortable using. The other trigger defaults to an ALPHA shift key. Depending on the application, the terminal may beep to indicate a trigger is selected.

## Using the Integrated Laser Scanner

To scan:

1. Power on the system and scanner by pressing the <⏻> (PWR), the SCAN bar, or a trigger. The Scan LED lights yellow if scanning is enabled and the laser is on.
2. Turn the scanner to the direction you wish to scan. The scanner turns toward the back of the 6100.
3. Point the PDT 6100 at the bar code and press the scan bar or a side trigger.

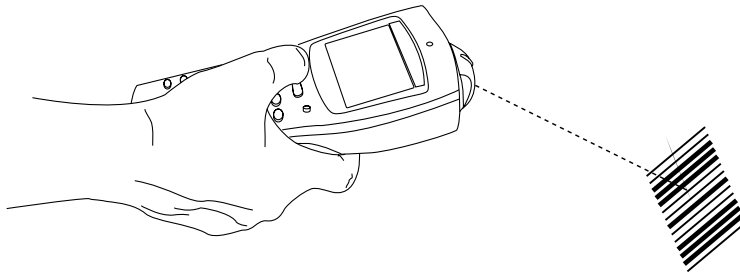
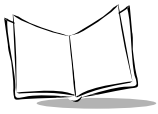

Figure 5-5. Scanning a Bar Code

4. Ensure that the scan beam crosses all bars and spaces on the symbol, as shown below.



5. Hold the scanner farther away for larger symbols, and closer for symbols with bars that are close together.
6. The LED turns from yellow to green for successful decodes. The PDT 6100 may also beep.



## Aiming: Hold at an Angle

Do not hold the 6100's scan window directly over the bar code. Laser light reflecting directly back into the scan window from the bar code is known as specular reflection. This strong light can "blind" the scanner and make decoding difficult. The area where specular reflection occurs is known as a "dead zone".

You can tilt the 6100 up to 55° forward or back and achieve a successful decode. Practice quickly shows what tolerances to work within.

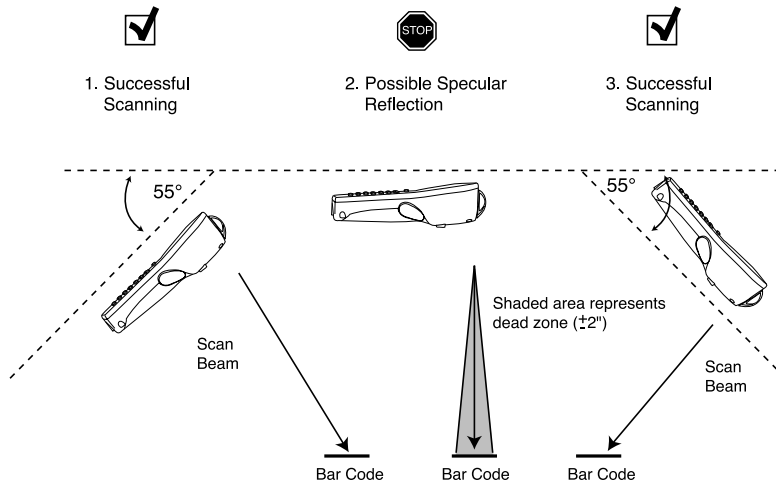

Figure 5-6. Scanning Angle and Specular Reflection

## Range

Any scanning device decodes well over a particular working range — minimum and maximum distances from the bar code. This range varies according to bar code density and scanning device optics.

Scanning within range brings quick and constant decodes; scanning too close or too far away prevents decodes. You need to find the right working range for the bar codes you are scanning. The best general advice is:

- ◆ Hold the scanner farther away for larger symbols.
- ◆ Move the scanner closer for symbols with bars that are close together.
- ◆ Start scanning *at a distance* from the bar code — not from direct contact. If the bar code does not readily decode, move the scanner in closer.

The best way to specify the appropriate working range is through a chart called a Decode Zone (Figure 5-7). A decode zone simply plots working range as a function of minimum element widths of bar code symbols.

Note: Typical performance at 68°F (20°C)  
on high quality symbols.

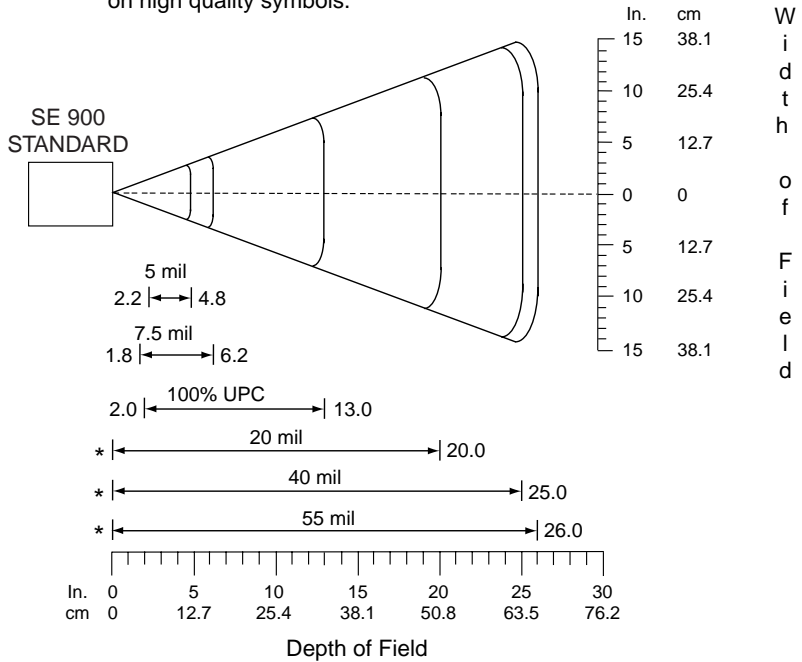

\* Minimum distance determined by symbol length and scan angle

Figure 5-7. PDT 6100 Decode Zone



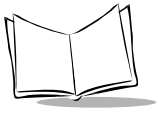

## Running Communications

---

### **Communicating with a Host**

The 6100 communicates with a host or printer through the CRD 6100 or the Charging and Communications Cable (CCC).

To communicate with a host or printer through the CRD 6100:

1. Set up the cradle as described in *Connecting the Cables* on page 2-3, or in the *CRD 6100 Quick Reference Guide*.
2. Place the 6100's base in the cradle. Press the top of the 6100 against the cradle back until it is firmly seated.

The terminal's Charging LED flashes yellow and then lights solid yellow when the terminal is securely placed in the cradle.

3. Start the communications program on the host and the 6100.

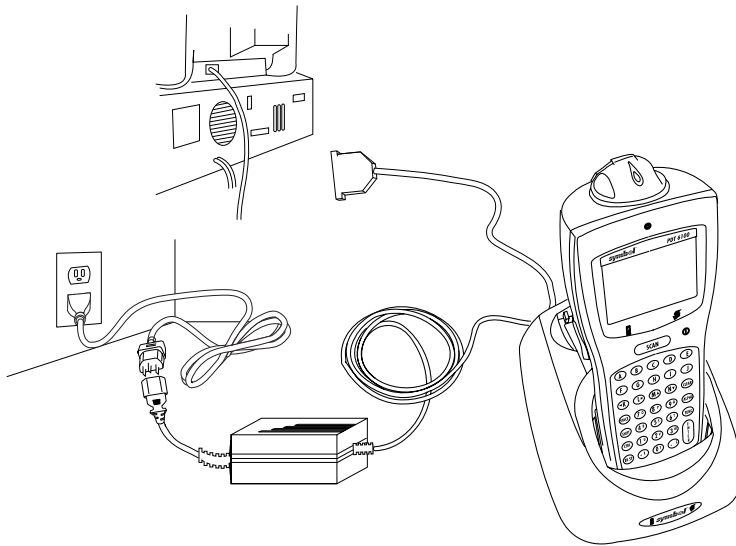

Figure 5-8. PDT 6100 Seated in CRD 6100

To communicate with a host through the CCC (refer to [Figure 5-9](#)):

1. Plug the CCC's 10-pin RJ41 connector in the 6100's base.
2. Connect the DB-9 connector to the host's serial (COMM) port.
3. Start the communications program on the host and the 6100.

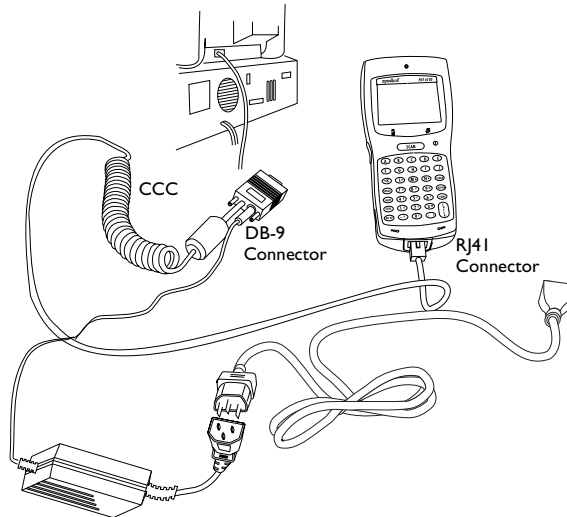

Figure 5-9. Using the CCC to Connect the PDT 6100 to a Host PC (shown) or Printer

## Radio Communications

The PDT 6110 operates in a Symbol Spectrum One RF network; the PDT 6140 operates in a Symbol Spectrum24 RF network.

The Status LED indicates the state of the 6100's connection to either of the RF networks:

- |                                |   |
|--------------------------------|---|
| Off                            | indicates that the radio is working and associated with an access point (Spectrum24) or base station (Spectrum One).<br><i>(The Status LED indication of RF activity is presently not available.)</i> |
| Flashing green once per second | indicates that the radio is out of range or not associated with an access point or base station.<br><i>(The Status LED indication of RF activity is presently not available.)</i>                     |

Refer to the network documentation for more information on operating the PDT 6100 in the specific RF environment.

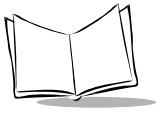

## Communicating With a Printer

---

To connect the terminal to a printer, use the CCC or the appropriate printer cable. The following directions apply to the CCC:

1. Plug the CCC's 10-pin RJ-41 connector into the PDT 6100 terminal's serial port (refer to [Figure 5-9](#)).
2. Plug the DB-9 connector in the communications port on the printer.
3. Start the communications program.

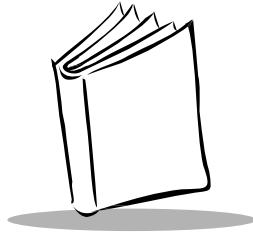

## *Chapter 6*

# *Maintaining the Terminal*

## **Batteries**

---

The PDT 6100 terminal's primary power is provided by a nickel metal hydride (NiMH) battery pack.

### ***Battery Life***

Many factors affect battery pack life, including temperature, battery age, and data collection method. Uses and operating conditions which affect battery life are:

- ◆ scanning
- ◆ “power save” mode
- ◆ radio communications
- ◆ backlighting
- ◆ very high operating temperatures
- ◆ very low operating temperatures.

The approximate battery life between charges is summarized in [Table 6-1](#). Note that these values vary with the application. Applications involving radio communications shorten these times.

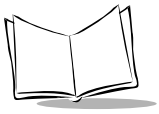

**Table 6-1. Battery Life: PDT 6100**

Battery Type	Input Method	Approx. Operating Time: PDT 6100	Approx. Operating Time: PDT 6110	Approx. Operating Time: PDT 614X
1500 mAh NiMH	Keyboard	50 hours	45 hours	48 hours
	Laser Scanner	6400 + scans	6100 + scans	6200 + scans
	Radio	N/A	7.5 hours	10 hours
<i>* Power consumption is highly application-dependent. The figures above represent battery life of typical applications. However, battery life with individual applications will vary.</i>				

## **When to Replace or Recharge Batteries**

The terminal provides two types of indicators to notify you when battery power is running low: warning messages and modified cursors. These indicators may be changed or disabled by an application program.

- ◆ **LOW POWER** — When the battery is low, the cursor changes as shown in [Table 6-2](#) If ERR3000 is loaded, the message LOW BATTERY also appears. At this level, the terminal continues to operate, but there is probably less than 1 hour of usable power left.
- ◆ **VERY LOW** — When the power is very low, the DEAD BATTERY message appears and the system powers off. Replace or recharge the battery before attempting to use the terminal. If the battery is not immediately recharged or replaced, data may be lost.

Battery life varies between 500 - 1000 charge / discharge cycles. This variation depends on the depth of discharge. In general, replace batteries which exhibit less than 80% of their total rated capacity.

Table 6-2. Cursor Indicators

<b>Keyboard State</b>	<b>Cursor Character</b>	<b>Low Battery</b>
Unshifted	∨	▼
Shifted	∧	▲
Momentary Shifted	↑	⬆
Momentary Unshifted	↓	⬇
Control	<b>C</b>	<b>C</b>
Alt	<b>A</b>	<b>A</b>
Function	<b>F</b>	<b>F</b>

### Supercap Power Backup

To prevent data loss during battery replacement, the terminals have a supercap power backup. The supercap backup provides sufficient power to preserve memory contents for approximately 15 minutes while batteries are replaced. The supercap does not provide enough power to operate the terminal. On receiving a low battery message, replace or recharge the primary batteries immediately.

### Replacement Batteries

A rechargeable 1500 mAh NiMH battery pack, p/n 21-33061-01, can be ordered from Symbol Technologies.

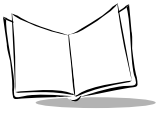

## Installing a New or Recharged Battery Pack

To install a new or recharged NiMH battery:

1. Turn the battery pack latch counterclockwise and remove the battery compartment door.

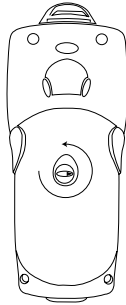

Figure 6-1. Removing the Battery Compartment Door

2. Lift the battery pack out.
3. Slide a NiMH battery pack in the compartment, with the contacts facing inside the compartment and the tab facing the top of the compartment (Figure 6-2).

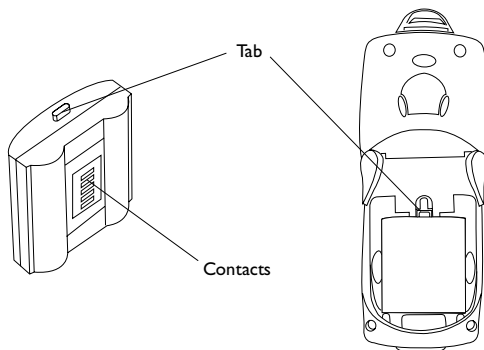

Figure 6-2. Inserting the NiMH Battery Pack

4. Replace the battery compartment door (Figure 6-3).

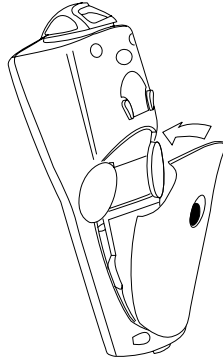

Figure 6-3. Replacing the Battery Compartment Door

5. Turn the latch clockwise to secure the battery.

## **Charging the Battery**

### **Using the CRD 6100**

To charge the NiMH battery in the PDT 6100:

1. Seat the PDT 6100 in a CRD 6100 connected to a power source.

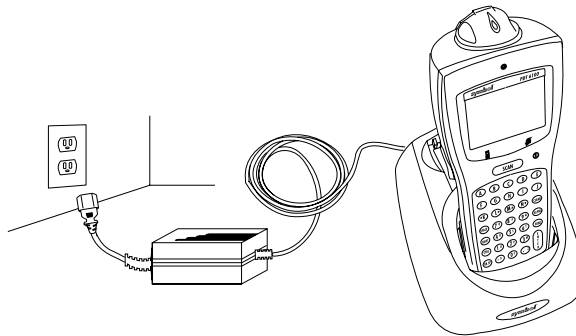
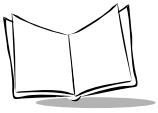

Figure 6-4. Seating the PDT 6100 in the CRD 6100

2. The PDT 6100's Charging LED flashes yellow at the start, lights solid yellow while the battery is charging, and lights solid green when the battery is fully charged. The charging time required is approximately 2.5 hours.





## Using the CCC

The optional CCC provides power from a wall-mounted power supply for recharging the NiMH battery while the 6100 is in use.

To connect the 6100 and the CCC:

1. Plug the CCC's 10-pin RJ41 connector in the 6100's base.
2. Plug the connector from the 12V power supply in the CCC's power input jack (power supply p/n 50-14000-086).
3. Connect the power supply's connector to a power line cord.

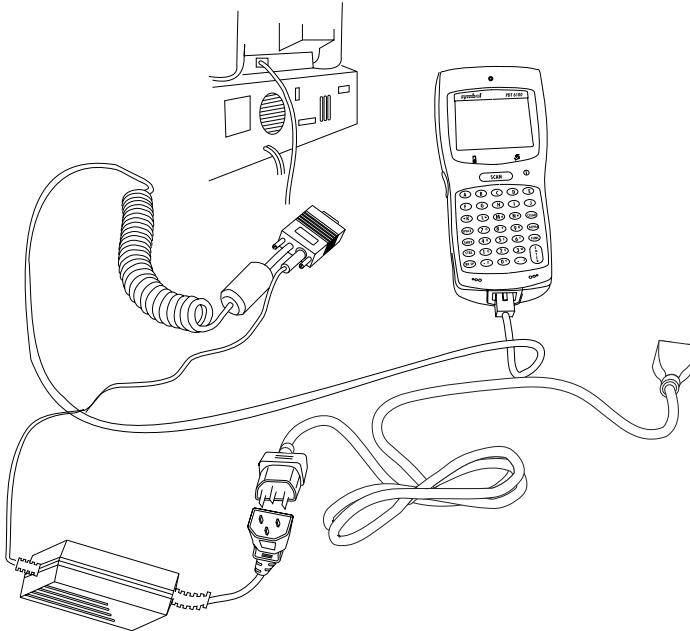

Figure 6-5. Connecting the CCC

4. Connect the power line cord to a wall outlet.  
Batteries recharge in 2.5 hours.

## Recharging a Spare Battery Pack

To recharge a spare battery pack in the cradle:

1. Insert the battery pack sideways, contacts down, into the spare battery slot, with the tab facing either the right or left side of the cradle.
2. Angle one side of the battery under the lip on the cradle's well.
3. Press down on the other side of the battery until the latch catches.

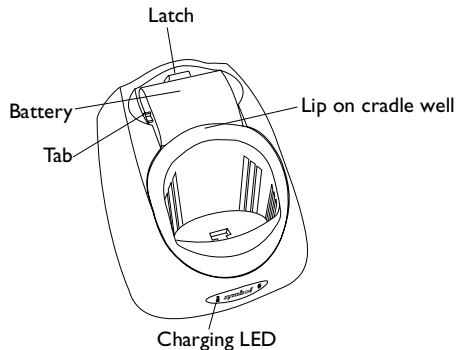

Figure 6-6. Charging a Spare Battery Pack

The cradle's Charging LED flashes yellow when the battery is first inserted. The LED lights solid yellow to indicate the spare battery is charging, and switches to solid green when the battery is charged. The spare battery recharges in 2.5 hours.

4. Remove the spare battery and place it in the PDT 6100, or leave it in the cradle for temporary storage.

To remove the battery, grip on either side of the battery and lift it out of the charging slot.

---

*Note: The spare battery can be inserted with the tab pointing to either side of the cradle well.*

---

## Other Charging Options

The NiMH battery pack can be charged in the UBC 2000 Charger. See instructions provided with the charger for more information.

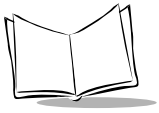

## Battery Charging Tips

For maximum capacity and battery life:

- ◆ Charge at temperatures between 0°C and 40°C (32°F and 104°F). Optimum charging occurs at room temperature (about 20°C to 25°C). Above or below that range, batteries may not charge to rated capacity.
- ◆ Recharge as soon as you see the "Low Battery" message.
- ◆ Charge NiMH batteries after storage.

## Cleaning

---

The terminal requires a minimum amount of maintenance. However, keep the terminal clean to avoid problems and prolong the terminal's life.

Before doing any maintenance or cleaning, power the terminal off.

To clean a terminal, use a clean, soft cloth dampened with a mild cleaner such as soap and water. Do not use abrasive paper, cloth, or abrasive/corrosive cleaners.

Wipe the entire terminal, except for the scanner window, with the damp cloth. Clean the keypad and scanner triggers.

Wipe the scanner window periodically with a lens tissue or other material suitable for cleaning optical material such as eyeglasses.

### *Caution*

Do not pour, spray, or spill any liquid onto any part of the terminal, particularly the scanner or scan element components.

## Storage

---

If the terminal will not be used for a while, store it in a cool, dry place, away from dust. For the best protection, repack the terminal in the original shipping container for storage.

### *Caution*

If you remove the primary battery, the terminal maintains memory contents for at least 15 minutes. To prevent loss of programs and data, transmit them

to a host computer before removing the primary batteries for longer than 15 minutes.

When you remove the terminal from storage without the battery pack, reset the real time clock. Refer to the *Series 3000 Application Programmer's Reference Manual* or *Series 3000 Application Programmer's Guide* for specific instructions.

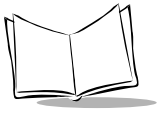

*PDT 6100 Product Reference Guide*

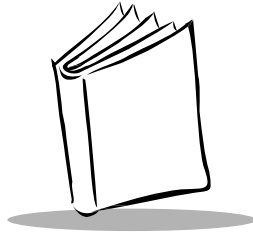

# Chapter 7

## *Error Recovery and Troubleshooting*

### Introduction

---

This chapter provides information to assist in basic trouble analysis and correction for the PDT 6100, including:

- ◆ Error messages
- ◆ Troubleshooting start-up failures
- ◆ Troubleshooting Spectrum24 terminal initialization failures
- ◆ Running the self test function
- ◆ Self test summaries
- ◆ Keyboard test
- ◆ Running memory transfer
- ◆ Scanning problems.

### Error Messages

---

If ERR3000 is loaded in the system configuration, the terminal displays the following messages to indicate error conditions that affect system performance. A message is usually accompanied by one or more beeps, after which the system returns to its previous status.

The application can change the actual wording of the messages or disable messages. The messages listed in [Table 7-1](#) are representative. Refer to the *Series 3000 Application Programmer's Guide* or your application guide for additional information.

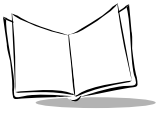

Table 7-1. Error Messages

Message	Explanation
Double Key Error	Two or more keys were pressed at the same time. This does not include boot sequences (refer to <a href="#">Chapter 5, Operating the PDT 6100 Series</a> , for boot sequences).
Low Battery	The battery pack should be recharged or replaced as soon as possible.
Dead Battery	Replace or recharge the battery pack immediately. After this message is displayed, the system shuts off. You may not be able to power it on again until the battery pack is charged.
Power Fault	The last power off was caused by a power failure. This occurs, for example, if the battery pack is removed while the terminal is on or the batteries fail suddenly.

## Troubleshooting

---

### Start-up Failure

Problems are most frequently start-up failures. If cold booting the terminal does not start the application successfully, either the application, the system software, or the system is malfunctioning. If you can boot the system to command mode, try the following:

- ◆ Use Program Loader to download a new version of the software to NVM. This procedure is described in [Chapter 3, Batch and Spectrum One Terminal Setup](#) for batch or Spectrum One terminals, or [Chapter 4, Spectrum24® RF Terminal Setup](#) for Spectrum24 terminals.
- ◆ Use Self Test to check whether system hardware is operational. The SelfTest procedure is described later in this chapter. After downloading new software, warm boot the terminal as described in [Chapter 5, Operating the PDT 6100 Series](#).

### Boot Failure Messages

During a cold boot, the system briefly displays a status line for each driver as it loads, in the format:

```
0:Driver    #.##
```

The line shows a status value, usually 0, followed by the name and version number of the driver. If the system halts at one of these lines and displays a status value other than 0, the displayed device driver did not load properly.

If such a failure occurs, cold boot the terminal again. If this does not solve the problem, call Symbol Customer Support.

More troubleshooting information is found in the documentation listed in [Related Publications](#).

## Spectrum24 Terminal

The command mode troubleshooting procedures utilized by 6100 batch or Spectrum One terminals are not available to terminals operating in a Spectrum24 network environment. Typical initialization and operating problems and solutions for Spectrum24 terminals are listed in [Table 7-2](#).

**Table 7-2. Troubleshooting Spectrum24 Terminals**

<b>Problem</b>	<b>Explanation/Action</b>
Out of range	Terminal is out of the Access Point's range. If you move the terminal during initialization, the terminal may be out of range of the AP and unable to complete the initialization process. Move back in range and repeat the initialization process.
Startup process fails	Boot server type (BOOTP or DHCP) doesn't exist. Verify that the boot server is operating and able to respond to TCP/IP, BOOTP, or DHCP requests from the terminal.
Low battery message.	Place the terminal in a cradle and recharge battery. <b>OR</b> Power terminal off and replace battery.
Battery is dead.	Battery not replaced after receiving low battery message or terminal left on for more than 24 hours. Recharge or replace the battery.
Terminal disassociated from Access Point.	Application does not respond to interactive operations. Applications using internal batch mode continue to function until required to transmit via radio, then fail to work. No message displayed.



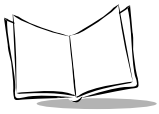

## Self Test Function

---

PDT 6100 terminal includes a series of self tests which verify that terminal hardware components are operating properly. Run self test if you suspect a problem with the hardware. Except for keyboard testing, no operator input is necessary after selecting a test screen.

### **Running the Self Test**

Access the Self Test function from the Command Mode menu:

1. Boot to command mode (refer to [Chapter 5, Operating the PDT 6100 Series](#) for boot sequences).
2. On the Command Mode screen, use the <UpArrow> or <DownArrow> to scroll through the options.
3. Highlight Screen Test and press <Enter>.

### **Self Test Summaries**

The Self Test is divided into five functions or screens:

**Config Screen 1** - Reports the terminal type and version, time, date, main battery status, current power source, and status of the serial ports when a loopback connector is used.

**Config Screen 2** - Reports information on the keyboard and display. If a laser scanner is attached, the test reports if the trigger is pulled or not. If a wand scanner is attached, the test reports whether the wand is scanning black or white.

**Memory Screen** - Tests ROM, RAM, and EMS (Expanded) memory, and reports the amount of RAM and EMS.

**Fill Screen** - Fills the entire screen with a test pattern to verify that the entire screen displays.

**Set RTC Screen** - Sets the time and date settings of the real-time clock.

## Keyboard Test

Keyboard testing can be performed while the terminal displays Config Screen 1 results.

Test any keys except Clear and PWR. When you press a key, the corresponding key code is displayed on the top row to the right of the test name. [Table 7-3](#), [Table 7-4](#), and [Table 7-5](#) list the codes for the 22-key, 35-key, and 46-key keyboards, respectively.

**Table 7-3. 22-Key Keyboard Test Codes**

Key	Test Code
Left Arrow	00
Right Arrow	01
Up Arrow	03
Down Arrow	04
FUNC	05
SEND	06
-	07
9	11
8	10
7	09

Key	Test Code
6	14
5	13
4	12
3	17
2	16
1	15
0	19
.	18
ENTER	20

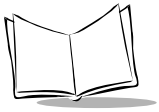

**Table 7-4. 35-Key Keyboard Test Codes**

Key	Test Code
Alpha	0
Space	1
Shift	2
Func	4
Ctrl	5
A	6
B	7
C	8
D	9
E	10
F	11
G	12
H	13
I	14
J	15
K	16
L	17

Key	Test Code
M	18
N	19
9	22
8	21
7	20
6	26
5	25
4	24
3	30
2	29
1	28
0	32
Backspace	27
X	31
Z	33
Enter	34

Table 7-5. 46-Key Keyboard Test Codes

Key	Test Code
CONTROL	3
SHIFT	2
A	5
B	6
C	7
D	8
E	9
F	10
G	11
H	12
I	13
J	14
K	15
L	16
M	17
N	18
O	19
P	20
Q	21
R	22
S	23
T	24
U	25

Key	Test Code
V	26
W	27
X	28
Y	29
Z	30
Up Arrow	33
Down Arrow	34
0	44
1	41
2	42
3	43
4	38
5	39
6	40
7	35
8	36
9	37
BKSP	31
SPACE	47
FUNC	1
.	32
ENTER	45

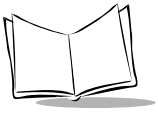

## Exiting Self Test

The test loop continues updating the time and battery status and processing keystrokes.

To end the test, press <Clear>.The display returns to the Command Mode menu.

## Memory Transfer Program

---

Command Mode includes a memory transfer utility that transfers data from a terminal to a host PC for program troubleshooting. Programmers can analyze an application using tools provided in the Series 3000 Application Development Kit and described in the *Series 3000 Application Programmer's Reference Manual*.

### Hardware Setup

1. Turn OFF the terminal and host PC. Disconnect or unplug the cradle, if used.

#### *Caution*

Always turn off the terminal before attaching or removing cables.

2. Connect the terminal and host PC using the communications/charger cable:
  - a. Plug the CCC's RJ41 connector in the terminal's base.
  - b. Plug the CCC's DB-9 connector in the host PC's communications port.

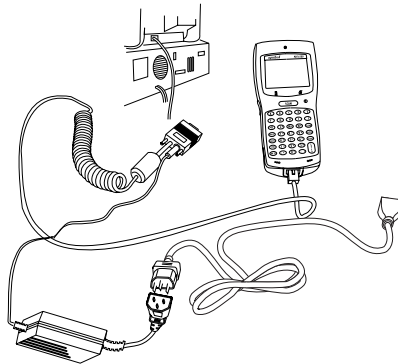

Figure 7-1. CCC Connections for MemoryTransfer

OR

3. Connect the host to the CRD 6100:
  - a. Plug the null modem's connector in the cradle's communications port.
  - b. Plug the other connector in the host's communications port.
  - c. Place the terminal in the cradle.
4. Power on the host PC.
5. Plug in the cradle, if used.

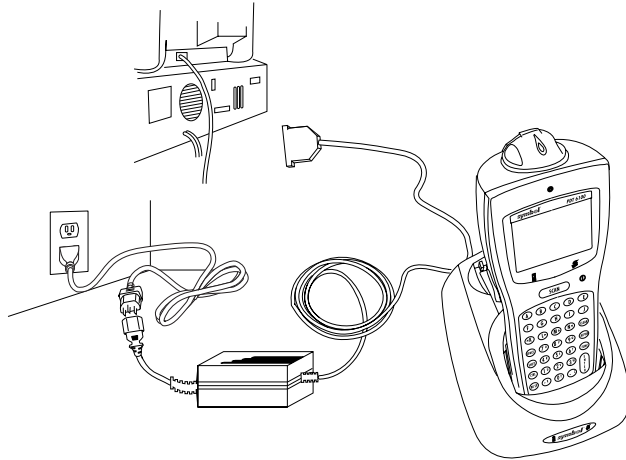

Figure 7-2. Cradle Connections for MemoryTransfer

## **Set Communications Parameters**

### **Host**

1. Start the Communications program on the host PC.
2. Set up the host communication parameters (these parameters must match the terminal's parameters). At the DOS prompt on the host, enter:

```
RCVHEX <filename.hex> <baud rate> <comport#>
```

Typical parameters are:

38400 bps  
7 bit data  
Odd parity  
Xon/Xoff flow control

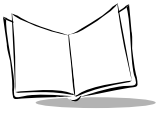

## Terminal

1. Boot the terminal to Command Mode (refer to [Chapter 5, Operating the PDT 6100 Series](#) for the appropriate key sequence).
2. Select the Memory Transfer function from the Command Mode menu. Use <UpArrow> or <DownArrow> to scroll through the command mode options until Memory Transfer is displayed, and press <Enter>.
3. Select the range of memory to transfer by pressing the first letter of the desired range (All, Range, or None), or use the <UpArrow> or <DownArrow> and press <Enter>. If you select All, the program skips to the range verification screen (step 7).

If you select Range, the screen displays:

```
RAM
Use Arrow Keys
Start      End
00000     9FFFF
```

4. Specify a range of RAM by setting the Start and End addresses.
  - ♦ Use <RightArrow> and <LeftArrow> to move the cursor to the digit to be changed
  - ♦ Use <UpArrow> and <DownArrow> to change the values.Type a range and press <Enter>.
5. Specify a range of NVM to transfer. Choose All or None.
6. If the system has EMS installed, it prompts for the range to transfer (otherwise, the program skips this screen):

```
EMS

Use arrow keys
Start      End
```

The range is specified in page numbers (16 KB per page). Use <RightArrow> and <LeftArrow> to move between the Start and End values. Use <UpArrow> and <DownArrow> to change the page number value.

Set the range and press <Enter>.

7. The terminal displays a range verification screen. For example:

```
RAM 0000 3FFF
NVM C839 DFFF
EMS None
Correct?
```

If the values are correct, press <Enter>. If the values are not correct, press <Clear> to clear the fields and select new values.

8. Specify the baud rate. Use the <UpArrow> and <DownArrow> to scroll through the list of baud rates until the correct rate is displayed, and press <Enter>. (Flow control may be necessary at 38400 bps and higher.)
9. Specify the data bits. Press <7> or <8>, or use <UpArrow> and <DownArrow> to display 7 or 8, and press <Enter>.

---

*Note: If you select 8 data bits, the program selects No parity and skips the next screen.*

---

10. Specify parity type. Use <UpArrow> and <DownArrow> to display a parity option, or press the first letter of a parity option (Even, Odd, None, Space, or Mark) and press <Enter>.
11. Set flow control. Use <UpArrow> and <DownArrow> to display the flow control options, or press the first letter of an option (None, Xon/Xoff, or RTS/CTS) and press <Enter>.

## Start Communications

1. The terminal is ready to send the data to the host PC and displays:

```
Comm Parameters

Start? <ENT>
```

2. Verify that the host is ready to receive data.
3. Press <Enter> on the terminal.

While data is being transferred, the terminal displays a report of the 1 KB range being transferred:

```
Memory Transfer

Sending: XXXX
```



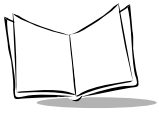

The display is updated for every 1024 bytes (1 KB) of memory.

4. When the transmission completes or aborts, the terminal displays the transmission status screen:

```
Memory Transfer
```

```
Status 0000
```

A status of 0000 (all zeros) indicates that the transfer was successful. Any other status indicates failure. Refer to Appendix C for communications status codes which indicate the source of the error.

## End Communications

To return to the Command Mode main menu, press <Clear>. Then take whatever corrective action is necessary, and reboot the terminal.

## Internal Modem Problems

If you are having difficulties with your internal modem, please check the following before returning your product:

- Connection to the telephone network is correct.
- Any necessary special requirements such as dialing 9 and ignoring dial tone have been considered in the event of using a PBX.
- Firmware settings described in the Series 3000 Application Programmer's Guide have been configured correctly.

## Scanning Problems

---

### What If ...

#### Nothing happens when you follow the operating instructions?

- ◆ Check the system power.
- ◆ Make sure the scanner is programmed to read the symbology you are trying to read.
- ◆ Check the bar code to make sure it is not defaced. A defaced 1-D bar code may not be readable by any scanner.
- ◆ Check to see if you are scanning from the proper distance.
- ◆ Try scanning a test symbol of the symbology you are trying to read.

## **Your terminal operates but scanned data is not displayed correctly?**

- ◆ Check the system power.
- ◆ Check that the communication parameters (baud rate, parity, stop bits, etc.) are set properly for the receiving device.

## **The laser does not activate?**

- ◆ You may have exceeded the allowable amount of scanning activity within the limits of your laser class of operation; in this case, wait for a short interval before scanning again.
- ◆ You may be scanning in an inappropriately hot environment. If so, remove the equipment from that environment, or allow the laser to cool down.

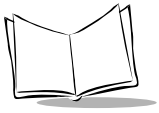

*PDT 6100 Product Reference Guide*

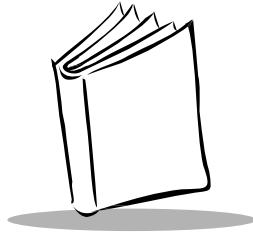

# *Appendix A*

## *Port Pin-Outs*

### **Introduction**

---

This appendix provides reference information for PDT 6100 ports and mappings for a null modem cable.

### **Pinouts for PDT 6100 Serial Devices**

---

The RJ41 connector is located in the base of the terminal.

**Table A-1. RJ-41 Connector**

Pin#	Signal	Description
1	DSR	Data Set Ready input
2	DCD	Data Carrier Detect input
3	RXD	Received Data input
4	RTS	Request to Send output
5	TXD	Transmit Data output
6		Power (+12VDC)
7	RING	Ring input
8	GND	Ground
9	CTS	Clear to Send input
10	DTR	Data Terminal ready output

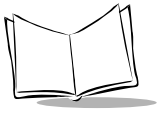

*PDT 6100 Product Reference Guide*

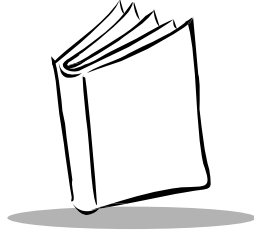

## Appendix B Keyboard Layouts

### Introduction

---

The following pages show the characters, scan codes, ASCII values, and character key sequences produced by the different PDT 6100 keyboards when modified with the appropriate key sequence.

As explained in Chapter 5, these key definitions can be changed by the application program. The captions indicate what sequence of modifier keys produce the keyboard.

[Figure B-1](#) shows a typical key and the location of its associated Scan Code, ASCII Value, and Printable Character or Logical Key Sequence.

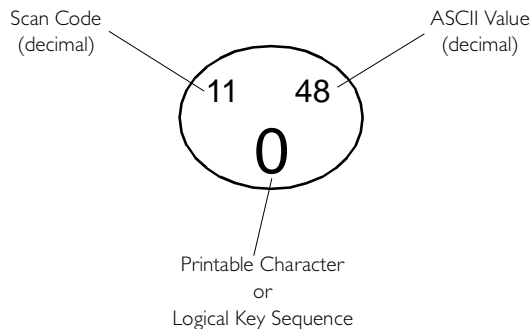

**Figure B-1. Key Representation**

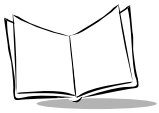

## 22-Key Keyboard

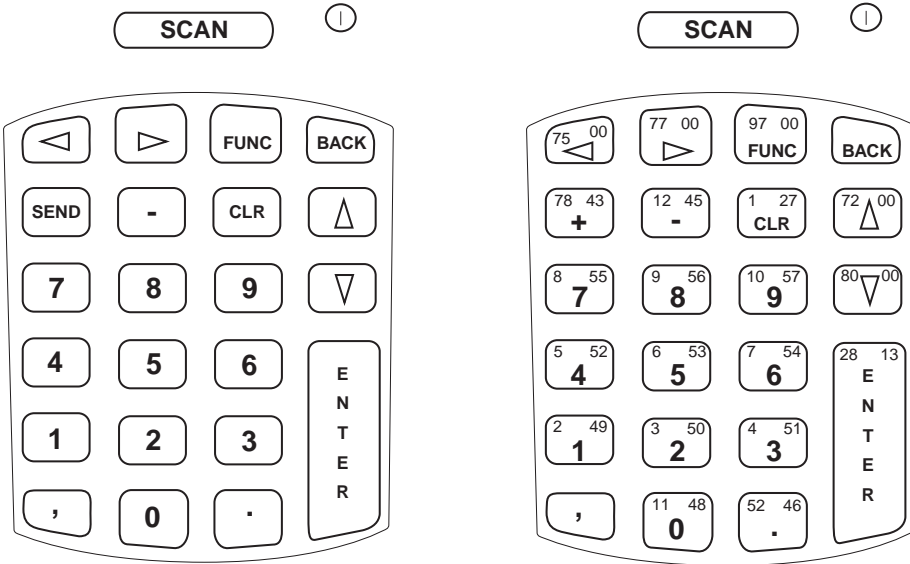

22-Key Keyboard

22-Key Unmodified Keyboard

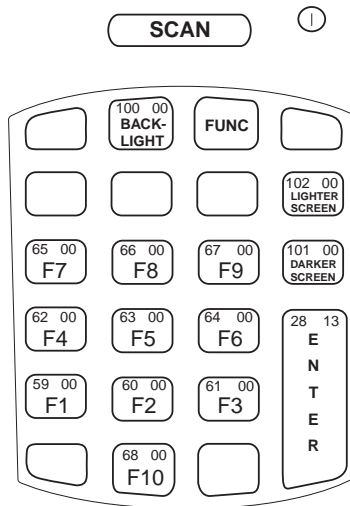

22-Key Function Key Modified Keyboard

# 35-Key Keyboard

35-Key Keyboard

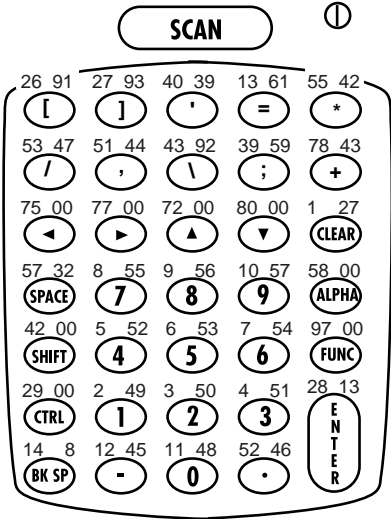
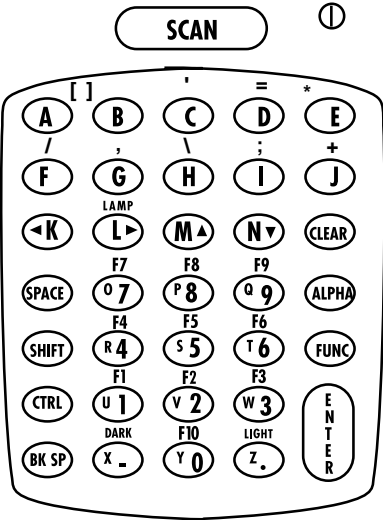

35-Key Unmodified Keyboard





### 35-Key Alpha Key Modified Keyboard

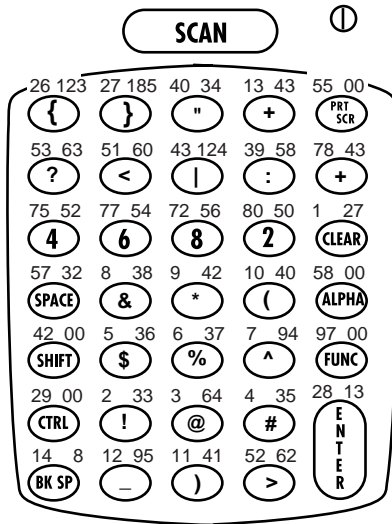
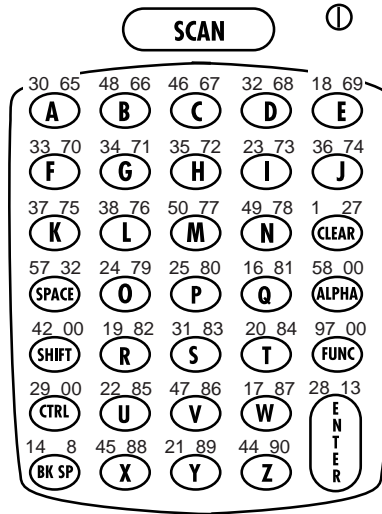

### 35-Key Shift Key Modified Keyboard

35-Key Control Key Modified Keyboard

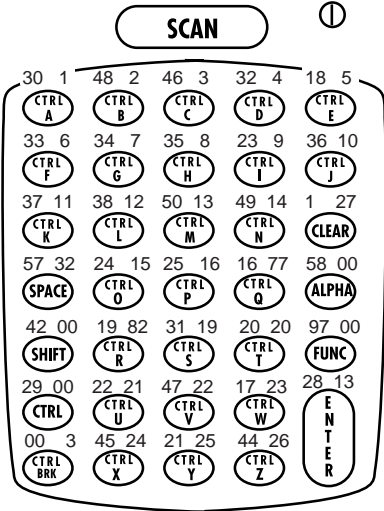

35-Key Function Key Modified Keyboard

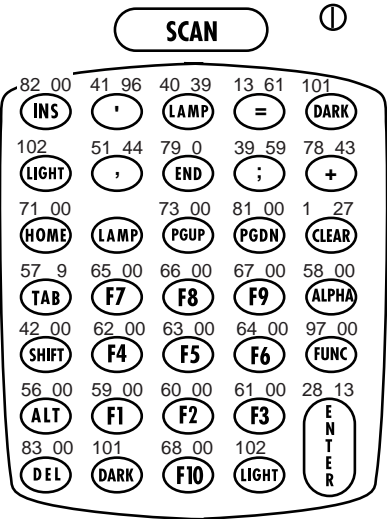

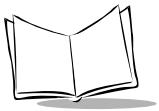

### 35-Key Alt Key Modified Keyboard

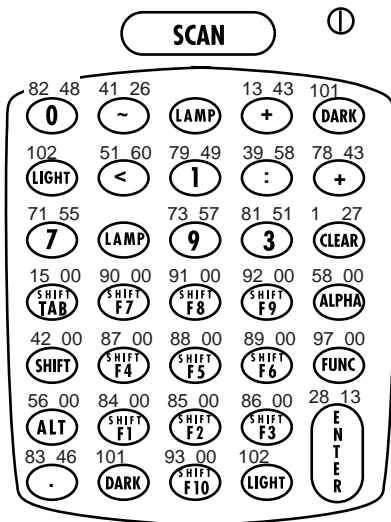
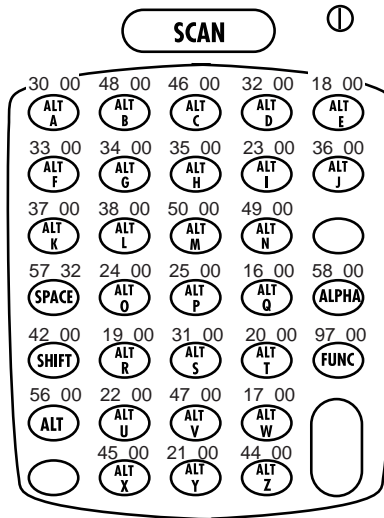

### 35-Key Shift + Func Modified Keyboard

35-Key Ctrl + Func Modified Keyboard

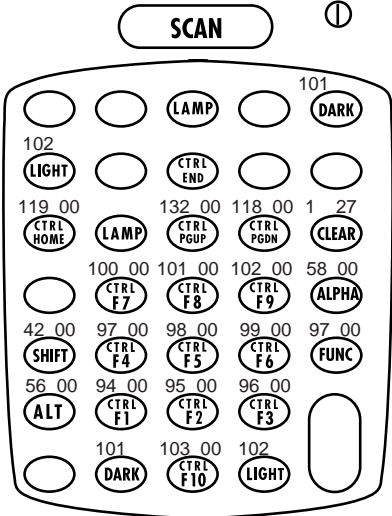

35-Key Alt + Func Modified Keyboard

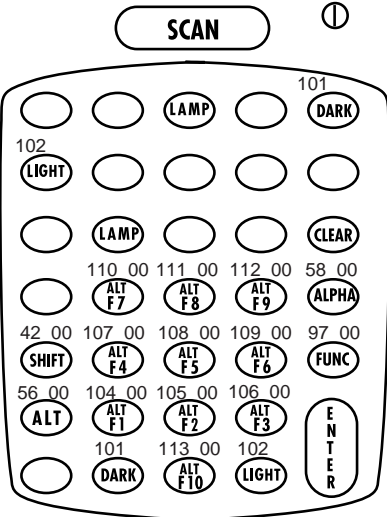

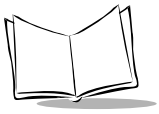

# 46-Key Keyboard

46-Key Keyboard

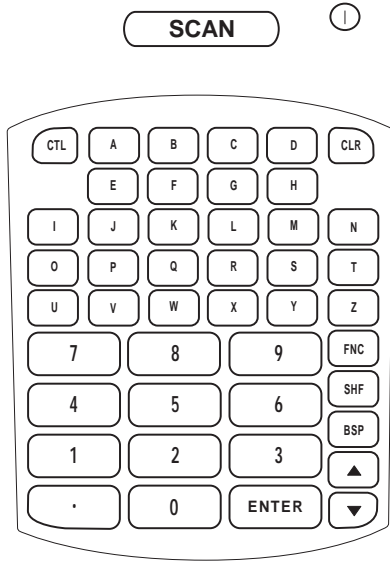

SCAN

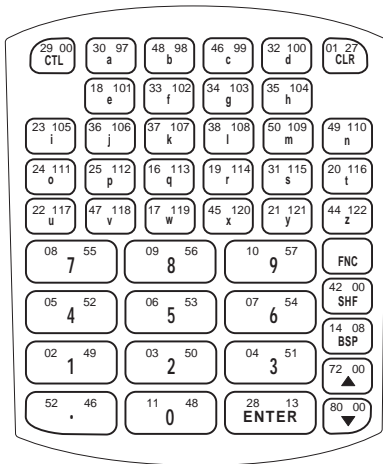

46-Key Unmodified Keyboard

46-Key Shift Modified Keyboard

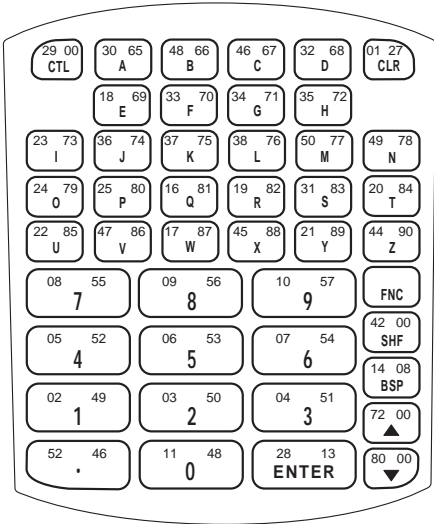
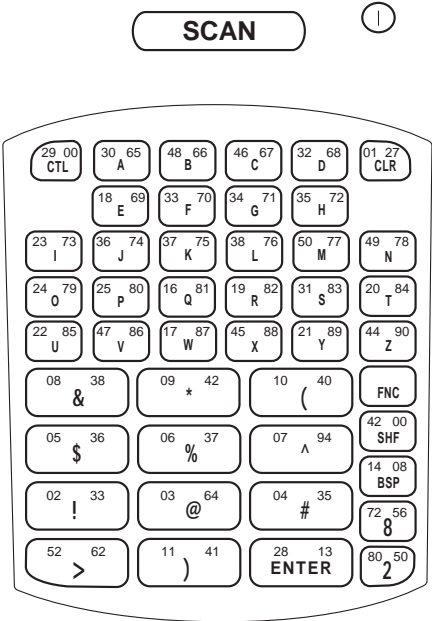

46-Key Caplock Modified Keyboard

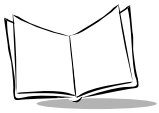

SCAN



### 46-Key Control Modified Keyboard

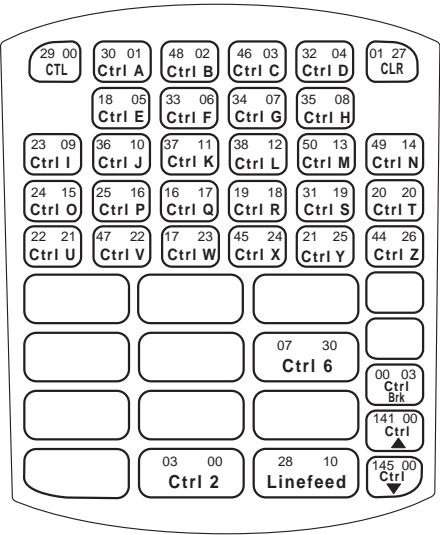

SCAN

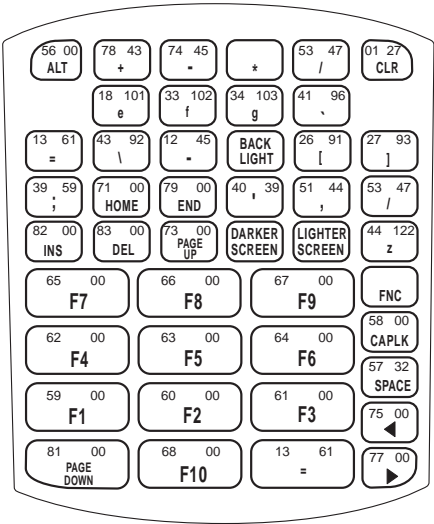

### 46-Key Func Modified Keyboard

46-Key Shift + Func Modified Keyboard

SCAN

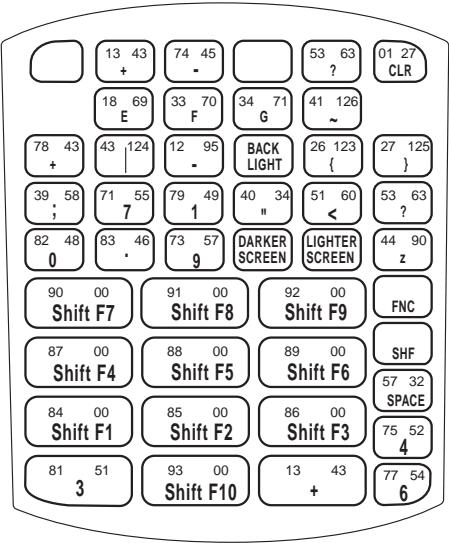

SCAN

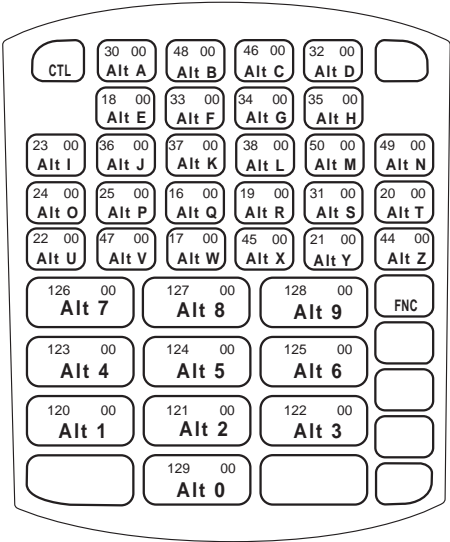

46-Key ALT (Func + Control) Modified Keyboard



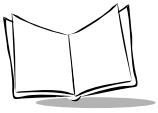

SCAN



### 46-Key Control + Func Modified Keyboard

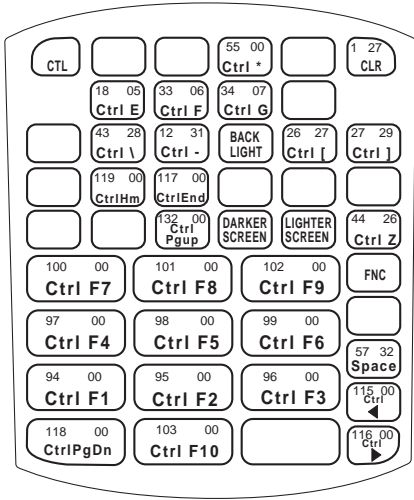

SCAN



### 46-Key ALT + Func Modified Keyboard

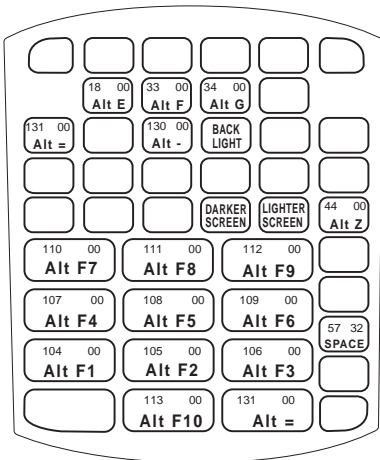

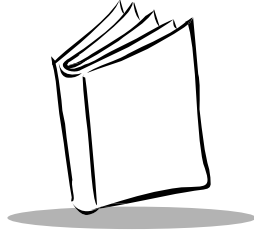

## *Appendix C*

# *Communications Status Codes*

### **Introduction**

---

The program loader status code consists of four hexadecimal digits which indicate whether or not the transfer was successful, and if not, the source of the communications error. A status code of 0000 indicates success; any other code indicates failure.

[Table C-1](#) lists the failures associated with the status codes. The values are additive.

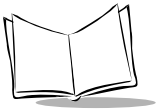

**Table C-1. Communications Status Codes**

Status Code	Meaning
0002	Receive overrun error
0004	Receive parity error
0008	Receive framing error
0010	Programming voltage not present
0020	Data Set Ready or Carrier Detect not detected on open
0040	Lost DSR while receiving
0080	ABORT key hit during comm
0100	Insufficient NVM for image
0200	Illegal Intel hexadecimal record
0400	Unsupported Intel record
0600	NVM EEPROM failed to erase
0800	Receive time-out error
1000	Control start character time-out
2000	Clear To Send inactive time-out error
4000	Receive buffer full

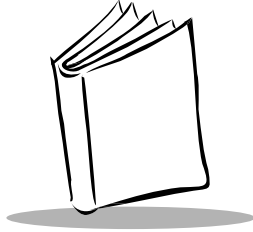

## *Appendix D Specifications*

### **Environment**

---

The terminal's operating conditions are listed in Table [Table D-1](#).

**Table D-1. Environmental Specifications**

<b>Condition</b>	<b>Range</b>	
Operating Temperature	-4° to 122°F	0° to 40°C
Storage Temperature	-40° to 158°F	-40° to 60°C
Humidity (Operating)	5% to 95% non-condensing @ 50°C for 168 hours	
Altitude	Up to 10,000 feet	

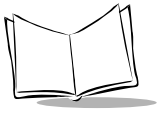

*PDT 6100 Product Reference Guide*

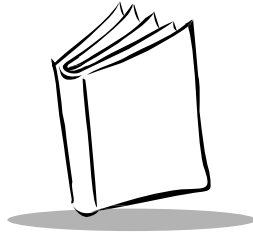

## *Glossary*

<b>Access Point</b>	A device that provides transparent access between Ethernet wired networks and IEEE 802.11 interoperable radio-equipped mobile units (MUs) like Symbol's hand-held computers or other devices equipped with a PCMCIA slot. The mobile unit may roam among the APs in the same subnet while maintaining a continuous, seamless connection to the wired network. Refer to <b>Subnet</b> .
<b>ADK</b>	Refer to <b>Application Development Kit</b> .
<b>Application Development Kit (ADK)</b>	A kit for use with Series 3000 terminals that provides various libraries, examples, utilities, and drivers. Use to enable program segments and build program images for execution on a PDT 6100 terminal.
<b>AP</b>	See <b>Access Point</b> .
<b>Application Programming Interface (API)</b>	An interface by means of which one software component communicates with or controls another. Usually used to refer to services provided by one software component to another, usually via software interrupts or function calls
<b>ASCII</b>	American Standard Code for Information Interchange. A 7 bit code representing 128 letters, numerals, punctuation marks, and control characters. It is a standard data transmission code in the U.S.
<b>Bar Code</b>	A pattern of variable-width bars and spaces which represents numeric or alphanumeric data in machine-readable form. The general format of a bar code symbol consists of a leading margin, start character, data or message character, check character (if any), stop character, and trailing margin. Within this framework, each recognizable symbology uses its own unique format. See <b>Symbology</b> .

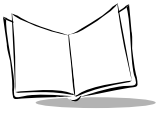

BIOS	Basic Input Output System. A collection of ROM-based code with a standard API used to interface with standard PC hardware.
Bit	Binary digit. One bit is the basic unit of binary information. Generally, eight consecutive bits compose one byte of data. The pattern of 0 and 1 values within the byte determines its meaning.
Bits per Second (bps)	Bits transmitted or received.
BOOTP	Bootstrap protocol.
Byte	On an addressable boundary, eight adjacent binary digits (0 and 1) combined in a pattern to represent a specific character or numeric value. Bits are numbered from the right, 0 through 7, with bit 0 the low-order bit. One byte in memory can be used to store one ASCII character.
Codabar	A discrete self-checking code with a character set consisting of digits 0 to 9 and six additional characters: (- \$ : / , +).
Code 128	A high density symbology which allows the controller to encode all 128 ASCII characters without adding extra symbol elements.
Code 3 of 9 (Code 39)	A versatile and widely used alphanumeric bar code symbology with a set of 43 character types, including all uppercase letters, numerals from 0 to 9, and 7 special characters (- . / + % \$ and space). The code name is derived from the fact that 3 of 9 elements representing a character are wide, while the remaining 6 are narrow.
Code 93	An industrial symbology compatible with Code 39 but offering a full character ASCII set and a higher coding density than Code 39.
Cradle	A cradle is used for charging the terminal battery and for communicating with a host computer, and provides a storage place for the terminal when not in use.
Data Communications Equipment (DCE)	A device (such as a modem) which is designed to attach directly to a DTE (Data Terminal Equipment) device.
Data Terminal Equipment (DTE)	A device (such as a terminal or printer) which is designed to attach directly to a DCE (Data Communications Equipment) device.
DCE	Refer to Data Communications Equipment.
Decode	To recognize a bar code symbology (e.g., Codabar, Code 128, Code 3 of 9, UPC/EAN, etc.) and analyze the content of the bar code scanned.

Development Kits	A set of software tools provided to customers to help them create applications for their terminals. See ADK.
Discrete 2 of 5	A binary bar code symbology representing each character by a group of five bars, two of which are wide. The location of wide bars in the group determines which character is encoded; spaces are insignificant. Only numeric characters (0 to 9) and START/STOP characters may be encoded.
DTE	Refer to Data Terminal Equipment.
EAN	European Article Number. This European/International version of the UPC provides its own coding format and symbology standards. Element dimensions are specified metrically. EAN is used primarily in retail.
Flash Disk	An additional megabyte of non-volatile memory for storing application and configuration files.
File Transfer Protocol (FTP)	A TCP/IP application protocol governing file transfer via network or telephone lines. Refer to TCP/IP.
Frequency Hopping	The use of a random sequence of frequency channels to achieve spread spectrum compliance. Stations that use frequency hopping change their communications frequency at regular intervals. A hopping sequence determines the pattern at which frequencies are changed. Messages take place within a hop. Refer to Hopping Sequence and Spread Spectrum.
FTP	See File Transfer Protocol.
Hopping Sequence	A set of random frequencies designed to minimize interference with other sets of random frequencies. A hopping sequence determines the pattern with which a station that uses frequency hopping changes its communications frequency. Refer to Frequency Hopping.
Host	A computer that serves other terminals in a network, providing services such as network control, data base access, special programs, supervisory programs, or programming languages.
Interleaved 2 of 5	A binary bar code symbology representing character pairs in groups of five bars and five interleaved spaces. Interleaving provides for greater information density. The location of wide elements (bar/spaces) within each group determines which characters are encoded. This continuous code type uses no intercharacter spaces. Only numeric (0 to 9) and START/STOP characters may be encoded.



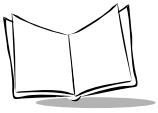

IOCTL	Input/Output Control.
IP	Internet Protocol.
LAN	Local Area Network.
LCD	Refer to Liquid Crystal Display.
LED	Refer to Light Emitting Diode.
Light Emitting Diode (LED)	A low power electronic light source commonly used as an indicator light. Uses less power than incandescent light bulb but more than a Liquid Crystal Display (LCD).
Liquid Crystal Display (LCD)	A display that uses liquid crystal sealed between two glass plates. The crystals are excited by precise electrical charges, causing them to reflect light outside according to their bias. They use little electricity and react relatively quickly. They require external light to reflect their information to the user.
MU	Mobile Unit.
NCU	Network Control Unit.
Null Modem	A special cable that allows direct connection of two DTE (Data Terminal Equipment) devices by making each perceive the other as a DCE (Data Communications Equipment) device.
NVM	Non-Volatile Memory.
PDT	Portable Data Terminal.
RAM	Random Access Memory.
RF	Radio Frequency.
Router	A device that connects networks and supports the required protocols for packet filtering. Routers are typically used to extend the range of cabling and to organize the topology of a network into subnets. Refer to Subnet.

Scanner	An electronic device used to scan bar code symbols and produce a digitized pattern that corresponds to the bars and spaces of the symbol. Its three main components are: <ol style="list-style-type: none"> <li>1. Light source (laser or photoelectric cell) - illuminates a bar code.</li> <li>2. Photodetector - registers the difference in reflected light (more light reflected from spaces).</li> <li>3. Signal conditioning circuit - transforms optical detector output into a digitized bar pattern.</li> </ol>
SE 900	Symbol's miniature laser scan modules that can be integrated into portable computing devices.
SHIP	Symbol Host Interface Program.
Spectrum24	Symbol's frequency-hopping, spread spectrum cellular network.
Spectrum One	Symbol's implementation of the Spread Spectrum wireless network, utilizing direct sequencing.
Spread Spectrum	A technique for uniformly distributing the information content of a radio signal over a frequency range larger than normally required for robust transmission of data. Spreading the signal without adding additional information adds significant redundancy, which allows the data to be recovered in the presence of strong interfering signals such as noise and jamming signals. The primary advantage of spread spectrum technology is its ability to provide robust communications in the presence of interfering signals.
STEP	Symbol Terminal Enabler Program.
Subnet	A subset of nodes on a network that are serviced by the same router. Refer to Router.
SVTP	Symbol Virtual Terminal Program.
Symbology	The set of structural rules and conventions used to represent data within a particular bar code (e.g., UPC/EAN, Code 39, PDF417, etc.).
TCP/IP	Refer to Transmission Control Protocol/Internet Protocol.
Terminal	A Symbol portable computer product.

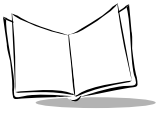

<b>Terminate and Stay Resident (TSR)</b>	A program under DOS that ends its foreground execution to remain resident in memory to service hardware/software interrupts, providing background operation. It remains in memory and may provide services on behalf of other DOS programs.
<b>Transmission Control Protocol/Internet Protocol (TCP/IP)</b>	A suite of the standard network protocols that were originally used in UNIX environments but are now used in many others. The TCP governs sequenced data; the IP governs packet forwarding. TCP/IP is the primary protocol that defines the Internet.
<b>TFTP</b>	Trivial File Transfer Protocol
<b>TSR</b>	Refer to <b>Terminate and Stay Resident</b> .
<b>UPC</b>	Universal Product Code. A relatively complex numeric symbology. Each character consists of two bars and two spaces, each of which can be any of four widths. The standard symbology for retail food packages in the United States.
<b>WLAN</b>	Wireless Local Area Network.

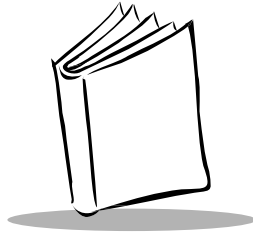

# Index

## Numerics

22-key keyboard	B-2
22-key test codes	7-5
35-key keyboard	B-3
35-key test codes	7-6
46-key keyboard	B-8
46-key test codes	7-7
6100	
initialization procedures	3-1
keyboard layouts	B-1
specifications	D-1
standard keyboard	5-8, 5-9
troubleshooting	7-1
6110	
loading applications	3-2
Spectrum One terminal	1-4
6140	
Spectrum24 terminal	1-5
684X	
description	4-1

## A

accessories	
battery chargers	1-3
holsters	1-4
printers	1-4
radio transmitter	1-4
rechargeable batteries	1-3, 6-1
scanners	1-3
adjusting the display	5-7
Alpha key	5-10
ALPHA key default	5-12
ALPHA trigger	5-12

ALT key	5-10
---------	------

## B

backlight	5-7
Backspace Key	5-11
batch	
loading applications	3-1
loading system files	3-1
batch environment	3-2
loading an application	3-3
set up for software download	3-2
batteries	
backup	6-3
chargers	1-3
charging	6-5
charging a spare in the cradle	6-7
charging tips	6-8
installing	6-4
life	6-1
low power messages	6-2
NiMH	6-1
primary	6-1
replacement	6-3
Very Low indicator	6-2
when to replace	6-2
when to replace/recharge	6-2
battery chargers	1-3
battery charging	
UBC 2000	6-7
battery condition	
see self test	
BKSP	5-11
boot	
cold	5-5

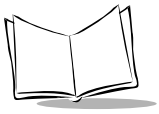

- to Command Mode ..... 5-6
- warm ..... 5-4
- booting
  - to Command Mode ..... 3-4
- break, key sequence for ..... 5-11
- bullets ..... vii

## C

- cancelling communications ..... 3-3
- CapLock key ..... 5-10
- character keys ..... 5-10
- charging and communications cable
  - charging the battery ..... 6-6
- cleaning ..... 6-8
- cold boot
  - description ..... 5-5
  - failure ..... 5-6
  - messages ..... 7-2
  - status ..... 7-3
  - troubleshooting failure ..... 7-2
- Command Mode ..... 3-2, 5-6, 7-8
  - booting to ..... 3-4, 5-6
  - downloading a program ..... 5-6
  - program loader ..... 3-4
  - running self test ..... 5-6
  - self test ..... 5-6, 7-4
  - transferring memory ..... 5-6
- communications
  - cancelling ..... 3-3
  - select parameters ..... 3-5
  - status codes ..... 3-7, C-1
- connecting
  - external scanner ..... 1-3
- connectors
  - pin assignments ..... A-1
- Control key ..... 5-10
- conventions
  - notational ..... vii
- cradle
  - connecting ..... 2-3
  - description ..... 2-1
  - parts of ..... 2-2
- cradles

- single-slot ..... 1-3
- CRD 6100
  - accessories ..... 2-1
  - charging a spare battery ..... 6-7
  - charging the battery ..... 6-5
  - connecting the cables ..... 2-3
    - power supply ..... 2-1
    - required parts ..... 2-1
  - cursor shapes ..... 6-2

## D

- display
  - adjusting contrast ..... 5-7
  - backlight ..... 5-7
  - darker ..... 5-7
  - lighter ..... 5-7
- display information
  - see self test
- Double Key Error message ..... 5-8
- downloading
  - application ..... 3-1
  - program loader ..... 3-2
  - sendhex command ..... 3-2
- downloading a program
  - cancelling ..... 3-5
  - ending communications ..... 3-7
  - procedure ..... 3-3-3-7
  - selecting communications parameters .. 3-5
  - starting communications ..... 3-6
- drivers
  - load message ..... 7-3

## E

- EMS available
  - see self test
- error codes
  - communications ..... C-2
- error messages ..... 7-1
- external event power on ..... 5-2

## F

- flash disk

- application storage ..... 4-1
- configuration file storage ..... 4-1
- FLASHDSK.SYS ..... 4-1
- Function key ..... 5-10

**I**

- information, service ..... viii
- integrated scanner
  - trigger selection ..... 5-12

**K**

- key sequences ..... 5-10
- keyboard
  - 22-key ..... B-2
  - 35-key ..... B-3
  - 46-key ..... B-8
  - about the ..... 5-8
  - key assignments ..... 5-10
  - key descriptions ..... 5-10
  - modifier keys ..... 5-10
  - standard 6100 22-key ..... 5-8
  - standard 6100 35-key ..... 5-9
  - standard 6100 46-key ..... 5-9
  - states ..... 5-10
  - test ..... 7-5
  - using ..... 5-8
- keyboard status
  - see self test

**L**

- laser scanner
  - selecting the trigger ..... 5-12
  - using ..... 5-12
- loading a program ..... 3-2
- Low Power message ..... 6-2

**M**

- maintenance
  - cleaning ..... 6-8
- memory transfer ..... 5-6, 7-8
  - ending communications ..... 7-12
  - initiating transfer to host ..... 7-11

- selecting a range ..... 7-10
- selecting communications parameters ..... 7-11
- status ..... 7-12
- messages
  - Double Key Error ..... 5-8
  - driver loading ..... 7-3
  - Low Power ..... 6-2
- modifier keys ..... 5-10

**N**

- network options
  - Spectrum One ..... 1-4
  - Spectrum24 ..... 1-4
- NiMH battery
  - charging ..... 6-5
  - installing ..... 6-4
- NiMH battery pack ..... 6-1
- notational conventions ..... vii
- NVM
  - erasing ..... 3-5

**O**

- operating system
  - DR DOS ..... 1-1

**P**

- PDT 6100
  - initializing ..... 3-1
  - keyboard layouts ..... B-1
  - loading files ..... 3-1
  - specifications ..... D-1
  - standard keyboard ..... 5-8, 5-9
  - troubleshooting ..... 7-1
- pin-outs
  - terminal power port ..... A-1
- port pin-outs ..... A-1
- power
  - backup ..... 6-3
  - primary ..... 6-1
- Power Key ..... 5-11
- power off
  - automatic ..... 5-2

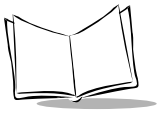

forced	5-3
normal	5-2
restarting	5-3
power on	
modem ring	5-2
normal	5-2
power source	
see self test	
printers	
cables	5-18
Comtec	1-4
Monarch Rascal	1-4
Monarch Renegade	1-4
problem solving	
program hang	5-3
program loader	3-2, 5-6
selecting	3-5
status codes	C-1
program loading	
hardware required	3-1
PWR Key	5-11
<b>R</b>	
radio	
Spectrum One	1-4
Spectrum24	1-4
radio frequency option	1-4
radio terminal	1-4
RAM available	
see self test	
range	
scan	5-14
real time clock	5-2
real-time clock settings	
see self test	
<b>S</b>	
scanner	
connecting external	1-3
scanner trigger	
selecting	5-12
scanners	
integrated	1-3
laser	1-3
positioning the scanner	5-12
using the integrated scanner	5-12
working range	5-14
scanning	
integrated scanner	5-12
scanning angle	5-14
screen display verification	
see self test	
self test	5-6, 7-4
battery condition	7-4
display information	7-4
EMS available	7-4
exiting	7-8
keyboard status	7-4
power source	7-4
RAM available	7-4
real-time clock verification	7-4
screen display verification	7-4
serial port status	7-4
terminal type	7-4
testing memory	7-4
self test function	7-4
SENDHEX command	3-2
serial port status	
see self test	
service information	viii
setting the scanner trigger	5-12
Shift key	5-10
specifications	
environment	D-1
Spectrum One	
loading applications	3-1, 3-2
loading system files	3-1
Spectrum One network	1-4
Spectrum24	
system software	4-2
troubleshooting	7-3
specular reflection	5-14
startup failures	7-2
storage	6-8
supercap	6-3
symbol support center	ix
system software, Spectrum24	4-2

**T**

terminal  
    storage ..... 6-8

terminal initialization  
    program loader function ..... 3-2  
    sendhex command ..... 3-2

terminal type  
    see self test

test codes  
    22-key ..... 7-5  
    35-key ..... 7-6  
    46-key ..... 7-7

testing memory  
    see self test

troubleshooting ..... 7-2  
    applications ..... 7-8  
    memory transfer ..... 7-8  
    scanning ..... 7-12  
    Spectrum24 terminals ..... 7-3

**U**

UBC 2000 ..... 6-7

**W**

warm boot  
    description ..... 5-4



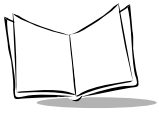

*PDT 6100 Product Reference Guide*

# Tell Us What You Think...

We'd like to know what you think about this Manual. Please take a moment to fill out this questionnaire and fax this form to: (631) 738-3318, or mail to:

Symbol Technologies, Inc.  
One Symbol Plaza M/S B-4  
Holtsville, NY 11742-1300  
Attn: Technical Publications Manager

**IMPORTANT:** If you need product support, please call the appropriate customer support number provided. Unfortunately, we cannot provide customer support at the fax number above.

---

User's Manual Title: \_\_\_\_\_  
(please include revision level)

How familiar were you with this product before using this manual?

Very familiar    Slightly familiar    Not at all familiar

Did this manual meet your needs? If not, please explain. \_\_\_\_\_

\_\_\_\_\_

What topics need to be added to the index, if applicable? \_\_\_\_\_

\_\_\_\_\_

What topics do you feel need to be better discussed? Please be specific.

\_\_\_\_\_

What can we do to further improve our manuals? \_\_\_\_\_

\_\_\_\_\_

Thank you for your input—We value your comments.



## PDT 6100 Series Product Reference Guide



70-33222-02  
Revision A — June 2001