

MC70 Enterprise Digital Assistant

User Guide

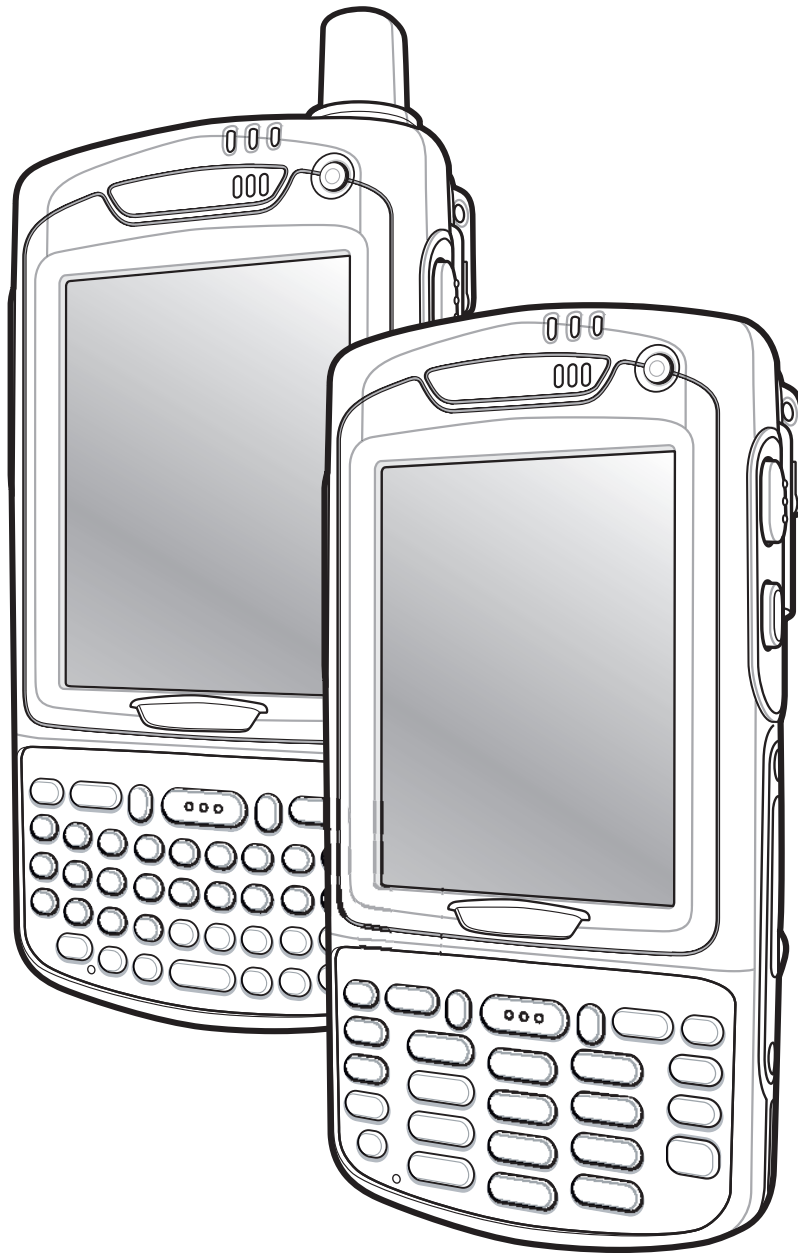

MC70

User Guide

72E-71769-01

Revision B

August 2006

© 2006 by Symbol Technologies, Inc. All rights reserved.

No part of this publication may be reproduced or used in any form, or by any electrical or mechanical means, without permission in writing from Symbol. This includes electronic or mechanical means, such as photocopying, recording, or information storage and retrieval systems. The material in this manual is subject to change without notice.

The software is provided strictly on an “as is” basis. All software, including firmware, furnished to the user is on a licensed basis. Symbol grants to the user a non-transferable and non-exclusive license to use each software or firmware program delivered hereunder (licensed program). Except as noted below, such license may not be assigned, sublicensed, or otherwise transferred by the user without prior written consent of Symbol. No right to copy a licensed program in whole or in part is granted, except as permitted under copyright law. The user shall not modify, merge, or incorporate any form or portion of a licensed program with other program material, create a derivative work from a licensed program, or use a licensed program in a network without written permission from Symbol. The user agrees to maintain Symbol's copyright notice on the licensed programs delivered hereunder, and to include the same on any authorized copies it makes, in whole or in part. The user agrees not to decompile, disassemble, decode, or reverse engineer any licensed program delivered to the user or any portion thereof.

Symbol reserves the right to make changes to any software or product to improve reliability, function, or design.

Symbol does not assume any product liability arising out of, or in connection with, the application or use of any product, circuit, or application described herein.

No license is granted, either expressly or by implication, estoppel, or otherwise under any Symbol Technologies, Inc., intellectual property rights. An implied license only exists for equipment, circuits, and subsystems contained in Symbol products.

Symbol and the SYmbol logo are registered trademarks of Symbol Technologies, Inc. Bluetooth is a registered trademark of Bluetooth SIG. Microsoft, Windows and ActiveSync are either registered trademarks or trademarks of Microsoft Corporation. Other product names mentioned in this manual may be trademarks or registered trademarks of their respective companies and are hereby acknowledged.

Symbol Technologies, Inc.
One Symbol Plaza
Holtsville, New York 11742-1300
<http://www.symbol.com>

Patents

This product is covered by one or more of the patents listed on the website: www.symbol.com/patents

Revision History

Changes to the original manual are listed below:

Change	Date	Description
A	1/2006	Initial release.
B	8/2006	Add Revision History page. Chapter 2: Add vibrator feature information. Remove Green and Red Phone button remapping information. Not supported. Update cold boot procedure to remove step to calibrate screen after cold boot.

Table of Contents

Patents.....	ii
Revision History	iii

About This Guide

Introduction	xi
Documentation Set	xi
Configurations.....	xii
Chapter Descriptions	xiii
Notational Conventions.....	xiii
Related Documents	xiv
Service Information.....	xiv
Symbol Support Center.....	xiv

Chapter 1: Getting Started

Introduction	1-1
Unpacking	1-2
Accessories	1-3
Getting Started	1-4
Installing and Removing the Main Battery	1-4
Installing the Main Battery	1-4
Removing the Main Battery	1-5
Charging the Battery	1-6
Charging the Main Battery and Memory Backup Battery	1-6
Charging Spare Batteries	1-7
Charging Temperature	1-8
Powering On the EDA	1-8
Calibrating the Screen	1-8
Checking Battery Status	1-8
SIM Card	1-9
Adjusting the Handstrap	1-10
Removing the Screen Protector	1-11
Battery Management	1-11
Changing the Power Settings	1-12
Changing the Backlight Settings	1-12
Changing the Keypad Backlight Settings	1-12
Turning Off the Radios	1-12

Turning Off the WLAN Radio	1-12
Turning Off the Bluetooth and WAN Radios	1-13

Chapter 2: Using the MC70

Introduction	2-1
Status Icons	2-1
Speaker Icon	2-3
Battery Icon	2-4
Connectivity Icon	2-4
WWAN Icon	2-5
Time Icon	2-5
Instant Message Icon	2-6
E-Mail Icon	2-7
Multiple Notifications Icon	2-7
LED Indicators	2-8
Keypads	2-9
Numeric Keypad Configuration	2-9
QWERTY Keypad Configuration	2-13
Special Character Key	2-17
Function Buttons	2-19
Stylus	2-19
Using a Headset	2-20
Data Capture	2-20
Linear Scanning	2-21
Imaging	2-21
Operational Modes	2-21
Scanning Considerations	2-21
Linear Scanning	2-22
Imager Scanning	2-23
Resetting the EDA	2-24
Performing a Warm Boot	2-24
Performing a Cold Boot	2-24
Waking the EDA	2-25
Locking the EDA	2-25

Chapter 3: Using Bluetooth

Introduction	3-1
Adaptive Frequency Hopping	3-1
Security	3-2
Turning the Bluetooth Radio Mode On and Off	3-2
Disabling Bluetooth	3-3
Enabling Bluetooth	3-3
Bluetooth Power States	3-3
Cold Boot	3-3
Warm Boot	3-4
Suspend	3-4
Resume	3-4

Modes	3-4
Wizard Mode	3-4
Explorer Mode	3-6
Discovering Bluetooth Device(s)	3-7
Bonding with Discovered Device(s)	3-8
Renaming a Bonded Device	3-10
Deleting a Bonded Device	3-11
Accepting a Bond	3-12
Discovering Services	3-12
File Transfer Services	3-13
Creating a New File or Folder	3-14
Deleting a File	3-14
Getting a File	3-14
Copying a File	3-15
Connecting to the Internet Using an Access Point	3-15
Dial-Up Networking Services	3-15
Adding a Dial-up Entry	3-18
Object Exchange Push Services	3-19
Sending a Contact	3-19
Sending a Picture	3-20
Headset Services	3-21
Serial Port Services	3-22
ActiveSync Using Serial Port Services	3-23
Personal Area Network Services	3-24
Bluetooth Settings	3-25
Device Info Tab	3-25
Services Tab	3-25
Dial-Up Networking Service	3-26
File Transfer Service	3-27
Hands-Free Service	3-27
Headset Service	3-28
OBEX Object Push Service	3-28
Personal Area Networking Service	3-29
Serial Port Service	3-29
Security Tab	3-30
Discovery Tab	3-31
Virtual COM Port Tab	3-31
Miscellaneous Tab	3-32

Chapter 4: Using the MC7004/MC7094 Phone

Introduction	4-1
Accessing the Phone Keypad	4-1
Making a Call Using the Keypad	4-2
Turning the Phone On and Off (Flight Mode)	4-2
Answering a Call	4-3
Audio Modes	4-3
Incoming Call Features	4-4
Muting a Call	4-4

Taking Notes	4-5
Using Speed Dial	4-6
Adding a Speed Dial Entry	4-6
Editing a Speed Dial Entry	4-8
Deleting a Speed Dial Entry	4-9
Making a Speed Dial Call	4-10
Using Call History	4-11
Managing Call History	4-12
Changing the Call History View	4-12
Resetting the Recent Calls Counter	4-12
Deleting Call History Items by Call Date	4-13
Deleting All Call History Items	4-14
Viewing Call Status	4-14
Using the Call History Menu	4-15
Using Contacts	4-16
Swapping Calls	4-16
Conference Calling	4-17
Text Messaging	4-18
Sending a Message	4-18

Chapter 5: Accessories

Introduction	5-1
Cables	5-1
Cradles	5-1
Miscellaneous	5-1
Snap-on Modules	5-1
Headset	5-2
Multi Media Card (MMC) / Secure Digital (SD) Card	5-2
Single Slot USB/Serial Cradle	5-3
Charging the EDA Battery	5-4
Charging the Spare Battery	5-4
Battery Charging Indicators	5-5
Charging Temperature	5-5
Four Slot Ethernet Cradle	5-5
Charging	5-6
Battery Charging Indicators	5-6
Charging Temperature	5-6
VCD7000 Vehicle Cradle	5-7
Charging the EDA Battery	5-7
Removing the EDA	5-8
Charging the Spare Battery	5-8
Battery Charging Indicators	5-9
Charging Temperature	5-9
Four Slot Spare Battery Charger	5-10
MC70 Battery Shim Installation	5-10
Spare Battery Charging	5-11
Battery Charging Indicators	5-11
Charging Temperature	5-11

Magnetic Stripe Reader (MSR)	5-12
Attaching and Removing the MSR	5-12
Using the MSR	5-13
TRG7000 Trigger Handle	5-13
Inserting the EDA into the Trigger Handle	5-14
Removing the EDA	5-14
Scanning	5-14
Using a Cradle	5-15
Cables	5-16
Battery Charging and Operating Power	5-17
LED Charge Indications	5-17
Charging Temperature	5-17

Chapter 6: Maintenance & Troubleshooting

Introduction	6-1
Maintaining the EDA	6-1
Troubleshooting	6-2
EDA	6-2
Bluetooth Connection	6-4
Single Slot USB/Serial Cradle	6-6
Four Slot Ethernet Cradle	6-7
Vehicle Cradle	6-8
Four Slot Spare Battery Charger	6-8
Cables	6-9
Magnetic Stripe Reader	6-9
Trigger Handle	6-10

Appendix A: Technical Specifications

MC70 Technical Specifications	A-1
MC70 Accessory Specifications	A-4

Introduction

This guide provides information about using the MC70 Enterprise Digital Assistant (EDA) and accessories.

✓ **NOTE** Screens and windows pictured in this guide are samples and can differ from actual screens.

Documentation Set

The documentation set for the MC70 provides information for specific user needs, and includes:

- **Microsoft® Windows Mobile 5.0 Applications User Guide for Symbol Devices** - describes how to use Microsoft developed applications.
- **Symbol Application Guide** - describes how to use Symbol developed sample applications.
- **MC70 User Guide** - describes how to use the MC70 EDA.
- **MC70 Integrator Guide** - describes how to set up the MC70 EDA and accessories.
- **SMDK Help File** - provides API information for writing applications.

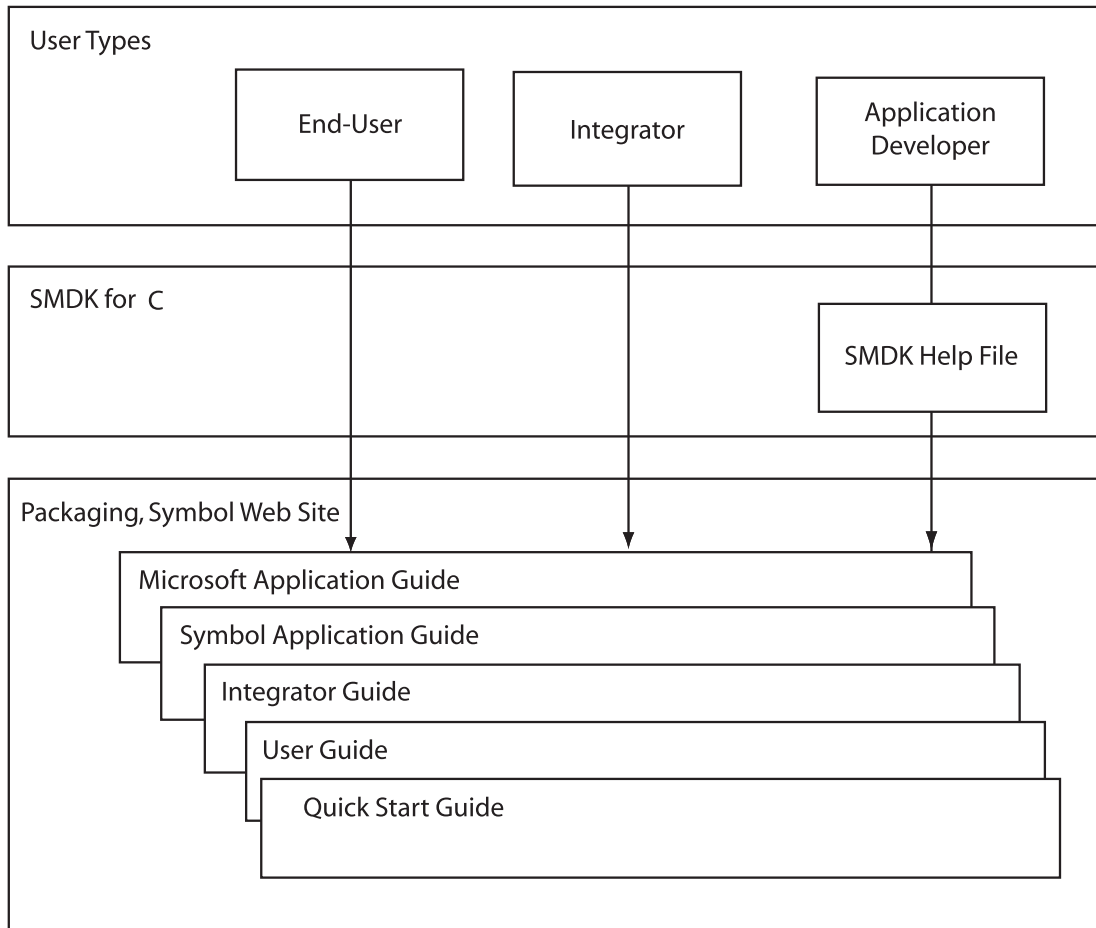

Configurations

This guide covers the following configurations:

- **MC7004** - Windows® Mobile 5.0 Operating System; EDGE GPRS quad-band WAN radio; Bluetooth® wireless technology (Class II); QVGA 3.5" color display; 64MB RAM/128MB flash memory; 1D laser scanner or 2D imager; numeric or QWERTY keypad; VoIP ready (VoIP application does not ship with the EDA); user accessible SD card slot.
- **MC7090** - Windows® Mobile 5.0 Operating System; 802.11a/b/g radio; Bluetooth® wireless technology; color display; 64MB RAM/128MB flash memory; 1D laser scanner or 2D imager; numeric or QWERTY keypad; VoIP ready (VoIP application does not ship with the EDA); user accessible SD card slot.
- **MC7094** - Windows® Mobile 5.0 Operating System; 802.11a/b/g radio; GPRS WAN radio; Bluetooth® wireless technology; color display; 64MB RAM/128MB flash memory; 1D laser scanner or 2D imager; numeric or QWERTY keypad; VoIP ready (VoIP application does not ship with the EDA); user accessible SD card slot.

Chapter Descriptions

Topics covered in this guide are as follows:

- *Chapter 1, Getting Started* provides information on getting the EDA up and running for the first time.
- *Chapter 2, Using the MC70* provides basic instructions for using the EDA, including powering on and resetting the EDA, and entering and capturing data.
- *Chapter 3, Using Bluetooth* explains Bluetooth functionality on the EDA.
- *Chapter 4, Using the MC7004/MC7094 Phone* provides basic instructions for using the MC70 phone.
- *Chapter 5, Accessories* describes the available accessories and how to use them with the EDA.
- *Chapter 6, Maintenance & Troubleshooting* includes instructions on cleaning and storing the EDA, and provides troubleshooting solutions for potential problems during EDA operation.
- *Appendix A, Technical Specifications* provides the technical specifications for the EDA.

Notational Conventions

The following conventions are used in this document:

- “EDA” refers to the Symbol MC70 series of hand-held EDAs.
- *Italics* are used to highlight the following:
 - Chapters and sections in this and related documents
 - Dialog box, window, and screen names
 - Drop-down list and list box names
 - Check box and radio button names
 - Icons on a screen.
- **Bold** text is used to highlight the following:
 - Key names on a keypad
 - Button names on a screen.
- bullets (•) indicate:
 - Action items
 - Lists of alternatives
 - Lists of required steps that are not necessarily sequential
- Sequential lists (e.g., those that describe step-by-step procedures) appear as numbered lists.

Related Documents

- *MC70 Quick Start Guide*, p/n 72-71770-xx
- *MC70 Microsoft Mobile 5.0 Regulatory Information*, p/n 72-71767-xx
- *MC70 Integrator Guide*, p/n 72E-71768-xx
- *Microsoft® Applications for Mobile and CE 5.0 User Guide*, p/n 72E-78456-xx
- *Symbol Application Guide*, p/n 72E-68901-xx
- *Symbol Mobility Developer Kits (SMDKs)*, available at: <http://devzone.symbol.com/>.
- Latest ActiveSync software, available at: <http://www.microsoft.com>.

For the latest version of this guide and all guides, go to: <http://www.symbol.com/mc70>.

Service Information

If you have a problem with your equipment, contact the “Symbol Support Center,” for your region. See page xiv for contact information. Before calling, have the model number, serial number, and several of your bar code symbols at hand.

Call the Support Center from a phone near the scanning equipment so that the service person can try to talk you through your problem. If the equipment is found to be working properly and the problem is symbol readability, the Support Center will request samples of your bar codes for analysis at our plant.

If your problem cannot be solved over the phone, you may need to return your equipment for servicing. If that is necessary, you will be given specific directions.

Symbol Technologies is not responsible for any damages incurred during shipment if the approved shipping container is not used. Shipping the units improperly can possibly void the warranty. If the original shipping container was not kept, contact Symbol to have another sent to you.

Symbol Support Center

For service information, warranty information or technical assistance contact or call the Symbol Support Center in:

Country/Region	Address	Telephone
United States	Symbol Technologies, Inc. One Symbol Plaza Holtsville, New York 11742-1300	1-800-653-5350
Canada	Symbol Technologies Canada, Inc. 5180 Orbitor Drive Mississauga, Ontario, Canada L4W 5L9	1-866-416-8545 (Inside Canada) 905-629-7226 (Outside Canada)
United Kingdom	Symbol Technologies Symbol Place Winnersh Triangle, Berkshire RG41 5TP United Kingdom	0800 328 2424 (Inside UK) +44 118 945 7529 (Outside UK)

Country/Region	Address	Telephone
Asia/Pacific	Symbol Technologies Asia, Inc. (Singapore Branch) 230 Victoria Street #12-06/10 Bugis Junction Office Tower Singapore 188024	Tel: +65-6796-9600 Fax: +65-6337-6488
Australia	Symbol Technologies Pty. Ltd. 432 St. Kilda Road Melbourne, Victoria 3004 Australia	1-800-672-906 (Inside Australia) +61-3-9866-6044 (Outside Australia)
Austria/Österreich	Symbol Technologies Austria GmbH Prinz-Eugen Strasse 70 / 2.Haus 1040 Vienna, Austria 01-5055794-0 (Inside Austria)	+43-1-5055794-0 (Outside Austria)
Denmark/Danmark	Symbol Technologies AS Dr. Neergaardsvej 3 2970 Hørsholm, Denmark	7020-1718 (Inside Denmark) +45-7020-1718 (Outside Denmark)
Europe/Mid-East Distributor Operations		Contact your local distributor or call +44 118 945 7360
Finland/Suomi	Oy Symbol Technologies Kaupintie 8 A 6 FIN-00440 Helsinki, Finland	9 5407 580 (Inside Finland) +358 9 5407 580 (Outside Finland)
France	Symbol Technologies France Centre d'Affaire d'Antony 3 Rue de la Renaissance 92184 Antony Cedex, France	01-40-96-52-21 (Inside France) +33-1-40-96-52-50 (Outside France)
Germany/ Deutschland	Symbol Technologies GmbH Waldstrasse 66 D-63128 Dietzenbach, Germany	6074-49020 (Inside Germany) +49-6074-49020 (Outside Germany)
Italy/Italia	Symbol Technologies Italia S.R.L. Via Cristoforo Columbo, 49 20090 Trezzano S/N Navigilo Milano, Italy	2-484441 (Inside Italy) +39-02-484441 (Outside Italy)
Latin America Sales Support	2730 University Dr. Coral Springs, FL 33065 USA	1-800-347-0178 (Inside United States) +1-954-255-2610 (Outside United States) 954-340-9454 (Fax)
Mexico/México	Symbol Technologies Mexico Ltd. Torre Picasso Boulevard Manuel Avila Camacho No 88 Lomas de Chapultepec CP 11000 Mexico City, DF, Mexico	5-520-1835 (Inside Mexico) +52-5-520-1835 (Outside Mexico)
Netherlands/Neder land	Symbol Technologies Kerkplein 2, 7051 CX Postbus 24 7050 AA Varsseveld, Netherlands	315-271700 (Inside Netherlands) +31-315-271700 (Outside Netherlands)

Country/Region	Address	Telephone
Norway/Norge	Symbol's registered and mailing address: Symbol Technologies Norway Hoybratenveien 35 C N-1055 OSLO, Norway Symbol's repair depot and shipping address: Symbol Technologies Norway Enebakkveien 123 N-0680 OSLO, Norway	+47 2232 4375
South Africa	Symbol Technologies Africa Inc. Block B2 Rutherford Estate 1 Scott Street Waverly 2090 Johannesburg Republic of South Africa	11-809 5311 (Inside South Africa) +27-11-809 5311 (Outside South Africa)
Spain/España	Symbol Technologies S.L. Avenida de Bruselas, 22 Edificio Sauce Alcobendas, Madrid 28108 Spain	91 324 40 00 (Inside Spain) +34 91 324 40 00 (Outside Spain) Fax: +34.91.324.4010
Sweden/Sverige	"Letter" address: Symbol Technologies AB Box 1354 S-171 26 SOLNA Sweden Visit/shipping address: Symbol Technologies AB Solna Strandväg 78 S-171 54 SOLNA Sweden	Switchboard: 08 445 29 00 (domestic) Call Center: +46 8 445 29 29 (international) Support E-Mail: Sweden.Support@se.symbol.com

If you purchased your Symbol product from a Symbol Business Partner, contact that Business Partner for service.

For the latest version of this guide go to: <http://www.symbol.com/manuals>.

Introduction

This chapter lists the parts and accessories for the EDA and explains how to install and charge the batteries, replace the strap, and power on the EDA for the first time.

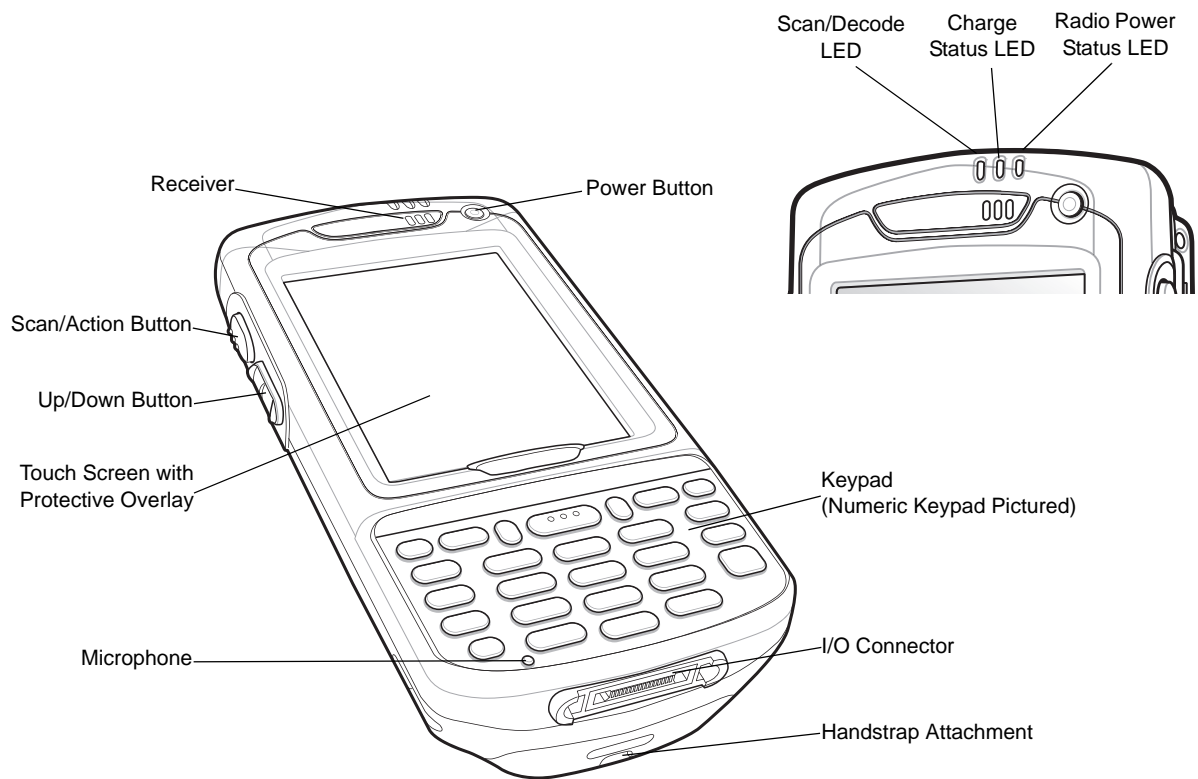

Figure 1-1 MC70 Front View

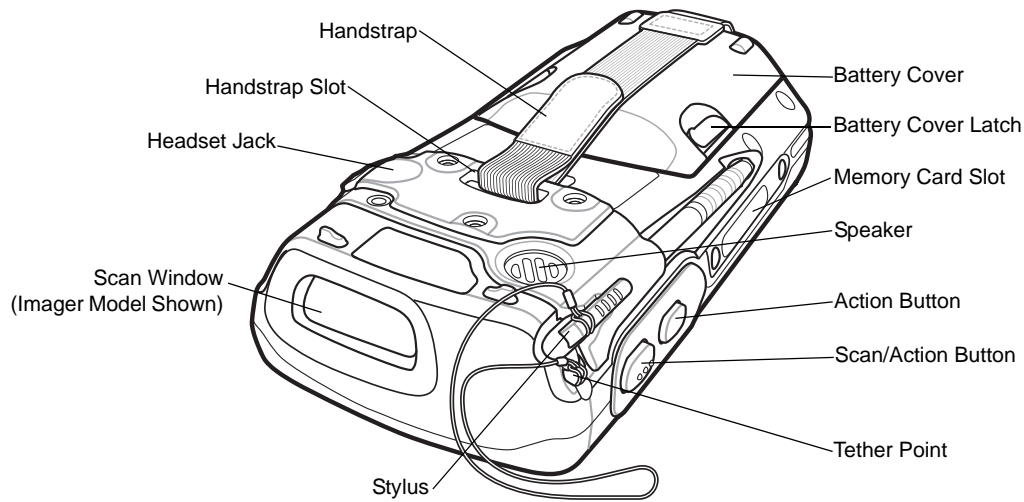

Figure 1-2 MC70 Rear View

Unpacking

Carefully remove all protective material from the EDA and save the shipping container for later storage and shipping.

Verify that you received the following equipment:

- MC70 EDA
- Lithium-ion battery
- Battery cover/strap assembly
- Tethered stylus
- Protective overlay, installed on display window
- Regulatory Guide
- Quick Start Guide.

Inspect the equipment for damage. If any equipment is missing or damaged, contact the Symbol Technologies Support Center immediately. See *page xiv* for contact information.

Accessories

Table 1-1 lists the accessories available for the MC70 EDA.

Table 1-1 MC70 Accessories

Accessory	Description
Snap-on Cables	The EDA supports the following cables: <ul style="list-style-type: none"> • AC line cord (country-specific) and power supply, charges the EDA. • Auto charge cable, charges the EDA using a vehicle's cigarette lighter. • DEX cable, connects the EDA to a vending machine. • Serial cable, adds serial communication capabilities. • USB cable, adds USB communication capabilities. • Modem inverter cable. • Printer cables, available for O'Neil and Zebra printers from printer vendors.
Single Slot USB/Serial Cradle	Charges the EDA main battery and a spare battery. Synchronizes the EDA with a host computer through either a serial or a USB connection.
Four Slot Ethernet Cradle	Charges the EDA main battery and connects the EDA with an Ethernet network.
VCD7000 Vehicle Cradle	Installs in a vehicle and charges the EDA main battery and a spare battery. Provides serial data communication between an MC70 and an external device.
Four Slot Spare Battery Charger	Charges up to four EDA spare batteries. Includes an adapter.
Headset	Use in noisy environments.
Belt Mounted Rigid Holster	Clips onto belt to hold the EDA when not in use.
Magnetic Stripe Reader (MSR)	Snaps on to the EDA and adds magstripe read capabilities.
Memory Card (MMC/SD)	Provides secondary non-volatile storage.
Software	<i>Symbol Mobility Developer Kits (SMDKs)</i> , available at: http://www.symbol.com/mc70 .
Spare lithium-ion battery	Replacement batteries: standard capacity 1900 mAh battery; extended capacity 3800 mAh battery.
Stylus	Performs pen functions.
Trigger Handle	Snap-on attachment adds a gun-style handle to the EDA.
Wall Mounting Kit	Use for wall mounting the cradles.

Getting Started

To start using the EDA for the first time:

- Install the main battery and cover assembly.
- Charge the EDA.
- Power on the EDA.
- Configure the EDA.

Installing and Removing the Main Battery

Installing the Main Battery

Before using the EDA, install a lithium-ion battery. The standard capacity 1900 mAh battery is shown. The extended capacity 3800 mAh battery requires a larger capacity battery cover.

1. Insert the battery, top first, into the battery compartment in the back of the EDA.
2. Press the battery down into the battery compartment until the battery release latch snaps into place.

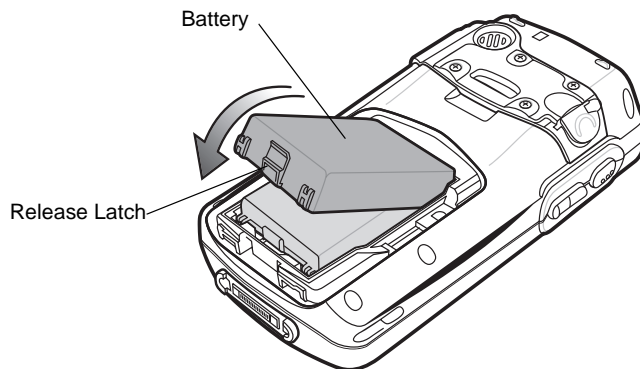

Figure 1-3 *Inserting the Battery*

- ✓ **NOTE** Position the battery correctly, with the battery charging contacts on top of the charging contacts in the battery compartment.

3. With the battery cover latches open, insert the cover, bottom first, then press down on the top of the cover.

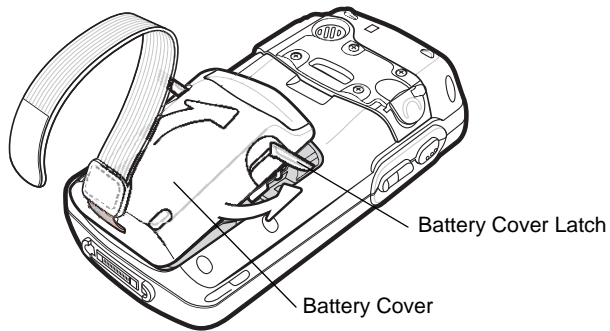

Figure 1-4 *Inserting the Battery Cover*

4. Close the battery cover latches on either side of the battery cover.
5. Insert the handstrap through the handstrap slot, then tighten and press down to secure.

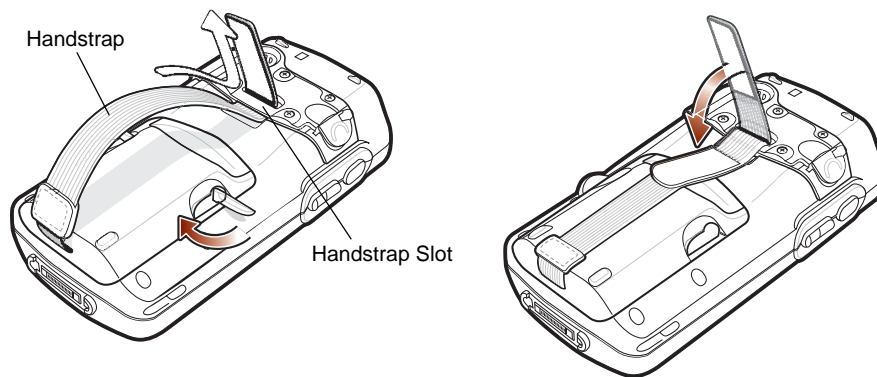

Figure 1-5 *Inserting the Handstrap*

The EDA powers up after inserting the battery.

Removing the Main Battery

1. Press the red **Power** button to suspend the EDA.
2. Loosen the handstrap at the top of the EDA.
3. Open the battery cover latches on either side of the battery cover.

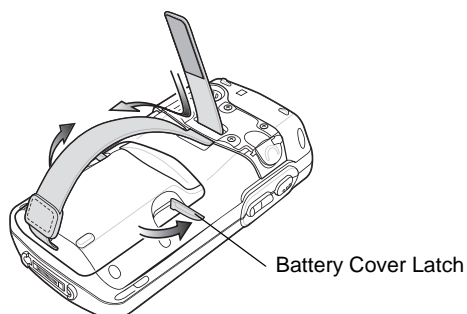

Figure 1-6 *Opening the Battery Cover Latches*

4. Lift the top of the battery cover and remove.

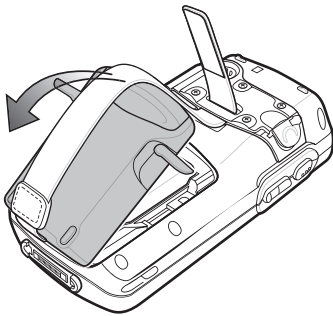

Figure 1-7 Removing the Battery Cover

5. Press the battery release latch on the bottom of the battery to unlock, and lift the battery out of the well.

Charging the Battery

Charging the Main Battery and Memory Backup Battery

Before using the EDA for the first time, charge the main battery until the amber Charge Status LED remains lit (see [Table 1-2 on page 1-7](#) for charge status indications). To charge the EDA, use a cable or a cradle with the appropriate power supply. For information about the accessories available for the EDA, see [Chapter 5, Accessories](#).

The EDA is equipped with a memory backup battery which automatically charges from the fully-charged main battery. When using the EDA for the first time, the backup battery requires approximately 24 hours to fully charge. This is also true any time the backup battery is discharged, which occurs when the main battery is removed for several hours. The backup battery retains RAM data in memory for at least 30 minutes (at room temperature) when the EDA's main battery is removed. When the EDA reaches a very low battery state, the combination of main battery and backup battery retains data in memory for at least 40 hours.

To charge batteries, use either a cable or one of the following cradles. For cradle setup and charging procedures refer to the *MC70 Integrator Guide*.

- Single Slot USB/Serial Cradle
- Four Slot Ethernet Cradle
- Vehicle Cradle.

Snap-on accessories such as the Magnetic Stripe Reader (MSR) and the Trigger Handle provide a pass-through port for charging.

To charge the main battery:

1. Connect the charging accessory to the appropriate power source.
2. Insert the EDA into a cradle or attach the cable. The EDA begins charging. The Charge LED blinks amber while charging, then turns solid amber when fully charged. See [Table 1-2](#) for charging indications.

The standard capacity battery (1900 mAh) fully charges in less than four hours. The extended capacity battery (3800 mAh) fully charges in less than eight hours.

Table 1-2 LED Charge Indicators

Charge Status LED	Indication
Off	EDA is not charging; EDA is not inserted correctly in the cradle or connected to a power source; charger is not powered.
Slow Blinking Amber (1 blink every 2 seconds)	EDA is charging.
Solid Amber	Charging complete. Note: When the battery is initially inserted in the EDA, the amber LED flashes once if the battery power is low or the battery is not fully inserted.
Fast Blinking Amber (2 blinks/second)	Charging error, e.g.: <ul style="list-style-type: none"> • Temperature is too low or too high. • Charging has gone on too long without completing (typically eight hours).

Charging Spare Batteries

Use one of the following accessories to charge a 1900 mAh or 3800 mAh spare battery:

- Single Slot USB/Serial Cradle
- Four Slot Battery Charger
- VCD7000 Vehicle Cradle.

To charge a spare battery:

1. Connect the spare battery charging accessory to the appropriate power source.
2. Insert the spare battery into the accessory's spare battery charging slot with the charging contacts facing down (over the charging pins) and gently press down on the battery to ensure proper contact.

The battery begins charging. The amber charge LED on the accessory lights to show the charge status.

The standard spare battery fully charges in less than four hours, and the extended spare battery fully charges in less than eight hours.

Charging Temperature

Charge batteries in temperatures from 0°C to 40°C (32°F to 104°F). Note that at temperatures above 35°C, charging is intelligently controlled by the EDA and the charging accessory in order to ensure safe operation and optimize long-term battery life.

To accomplish this, for small periods of time, the EDA or accessory alternately enables and disables battery charging to keep the battery at acceptable temperatures. The EDA or accessory indicates when charging is disabled due to abnormal temperatures via its LED. See [Table 1-2](#).

Powering On the EDA

Press the **Power** button to turn on the EDA. If the EDA does not power on, reset it. See [Resetting the EDA on page 2-24](#).

When turning the EDA on for the first time, the Symbol splash screen displays for about a minute as the EDA initializes its flash file system, then the calibration window appears. Note that these windows also appear upon cold boot.

✓ **NOTE** When the EDA powers up after inserting a battery for the first time, the device boots and powers on automatically.

Calibrating the Screen

To calibrate the screen so the cursor on the touch screen aligns with the tip of the stylus:

1. Remove the stylus from its holder on the back of the EDA.
2. Carefully press and briefly hold the tip of stylus on the center of each target that appears on the screen.
3. Repeat as the target moves around the screen, then tap the screen to continue.

Checking Battery Status

To check the charge status of the main battery or backup battery in the EDA, tap *Start - Settings - System - Power* icon to display the *Power* window.

To save battery power, tap the *Advanced* tab and set the EDA to turn off after a specified number of minutes.

SIM Card

✓ **NOTE** MC7004 and MC7094 only.

GPRS phone service requires a Subscriber Identification Module (SIM) card, or smart card. Obtain this card from the phone service provider. The card fits into the EDA and can contain the following information:

- Mobile phone service provider account details.
- Information regarding service access and preferences.
- Contact information, which can be moved to Contacts on the EDA.
- Any additional services to which you have subscribed.

✓ **NOTE** For more information about SIM cards, refer to the mobile phone service provider's documentation.

To install the SIM card:

1. Press the red **Power** button to suspend the EDA.
2. Remove the battery.
3. Lift the SIM cover using the stylus tip.

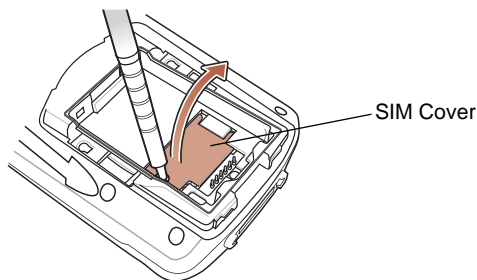

Figure 1-8 *Lifting the SIM Cover*

4. Insert the SIM card, as shown in [Figure 1-9](#), with the cut edge of the card facing out and the contacts facing down.

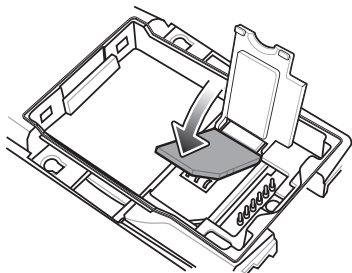

Figure 1-9 *Inserting the SIM Card*

5. Lower the SIM cover and snap it in place.
6. Replace the battery and battery cover.

7. Press the red **Power** button.
8. Tap *Start - Phone - Menu - Options - Network* tab and verify that the service provider appears in the *Current network:* field.
9. Make a call to verify connection.

✓ **NOTE** For detailed information about WWAN activation and settings, refer to the *MC70 Integrator Guide*.

Adjusting the Handstrap

The EDA handstrap is attached to the bottom of the battery cover. Adjust the handstrap to increase comfort when holding the EDA for extended periods of time. To adjust the handstrap:

1. Feed the handstrap through the handstrap slot in either direction, to tighten or loosen.
2. Secure the handstrap by pressing the two sides together as shown in [Figure 1-10](#).

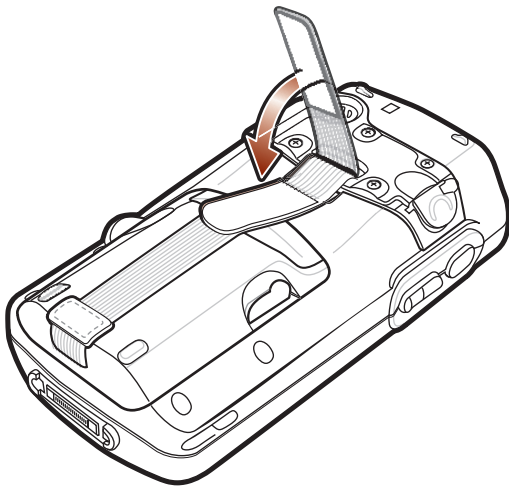

Figure 1-10 *Handstrap Adjustment*

Removing the Screen Protector

A screen protector is applied to the MC70. Symbol recommends using this to minimize wear and tear. Screen protectors enhance the usability and durability of touch screen displays.

To remove the screen protector, lift the corner using a thin plastic card, such as a credit card, then carefully lift it off the display.

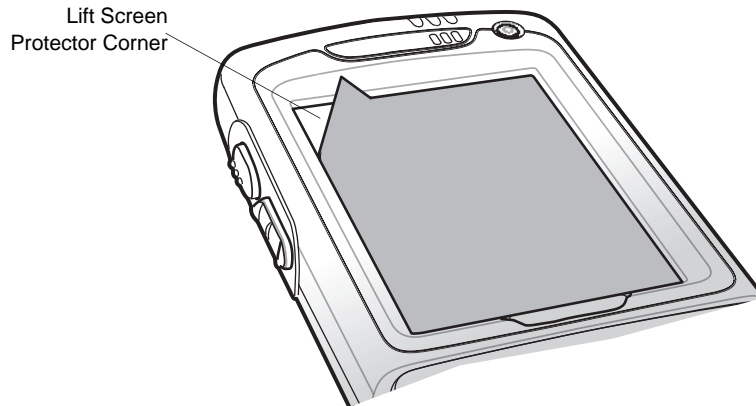

Figure 1-11 *Removing the Screen Protector*



CAUTION Do not use a sharp object to remove the protector. Doing so can damage the display.



NOTE Not using a screen protector can affect warranty coverage. To purchase replacement protectors, contact your local account manager or Symbol Technologies, Inc. These include screen protector installation instructions. Part number: KT-67525-01 Screen Protector 3/pk.

Battery Management

Observe the following battery saving tips:

- Leave the EDA connected to AC power at all times when not in use.
- Set the EDA to turn off after a short period of non-use.
- Set the backlight to turn off after a short period of non-use.
- Turn off all wireless activities when not in use.
- Power off the EDA when charging to charge at a faster rate.

Changing the Power Settings

To set the EDA to turn off after a short period of non-use:

1. Tap *Start - Settings - System* tab - *Power* icon - *Advanced* tab.
2. Select the **On battery power: Turn off device if not used for** check box and select a value from the drop-down list.
3. Select **ok**.

Changing the Backlight Settings

To change the backlight settings in order to conserve more battery power:

1. Tap *Start - Settings - System* tab - *Backlight* icon - *Battery Power* tab.
2. Select the **Disable backlight if device is not used for** check box and select a value from the drop-down list.
3. Select the *Brightness* tab.
4. Tap the **Disable backlight** check box to turn off the display backlight, or use the slider to set a low value for the backlight.
5. Select **ok**.

Changing the Keypad Backlight Settings

To change the keypad backlight settings in order to conserve more battery power:

1. Tap *Start - Settings - System* tab - *Keypress* icon - *Battery Power* tab.
2. Select the **On battery power: Disable keylight if device if not used for** check box and select a value from the drop-down list.
3. Select the *Advanced* tab.
4. Tap the **Disable keylight** check box to turn off the keypad backlight.
5. Select **ok**.

Turning Off the Radios

Turning Off the WLAN Radio



To turn off the WLAN radio, tap the **Signal Strength** icon and select *Disable Radio*. A red X appears across the icon indicating the radio is disabled (off).

To turn the WLAN radio back on, tap the **Signal Strength** icon and select *Enable Radio*. The red X disappears from the icon indicating the radio is enabled (on).

Turning Off the Bluetooth and WAN Radios

- ✓ **NOTE** The Flight Mode feature only turns off the WAN and Bluetooth radios. You must turn off the WLAN radio separately.



To turn off the Bluetooth and WAN radios:

- Tap the **Connectivity** icon  (on non-WAN devices) or the **Antenna/Signal** icon  (on WAN devices) and select *Turn on flight mode*

OR

- Tap the **Bluetooth** icon and select *Disable Bluetooth*.

To turn on the Bluetooth and WAN radios:

- Tap the **Connectivity** icon  (on non-WAN devices) or the **Antenna/Signal** icon  (on WAN devices) and select *Turn off flight mode*

OR

- Tap the **Bluetooth** icon and select *Enable Bluetooth*.















Introduction

This chapter explains the buttons, status icons, and controls on the EDA, and provides basic instructions for using the EDA, including powering on and resetting the EDA, and entering and capturing data.

Status Icons















The navigation bar at the top of the screen can contain the status icons listed in [Table 2-1](#).

Table 2-1 *Status Icons*

Icon	Function	Description
	Speaker	All sounds are on.
		All sounds are off.
		Vibrate is on.
	Battery	Backup battery is very low.
		Main battery is charging.*
		Main battery is low.
		Main battery is very low.
		Main battery is full.*
	Connectivity	Connection is active.
		GPRS available.
		GPRS in use.
		EGPRS available.
		EGPRS in use.
		Synchronization is occurring.

* Only appears in the *Time and Next Appointment* dialog box.





Table 2-1 Status Icons (Continued)

Icon	Function	Description
	WWAN	Call missed.
		Voice call.
		Voice call in progress.
		Calls are forwarded.
		Call on hold.
		Speakerphone is on.
		Antenna/signal icon: wireless on/good signal.
		Antenna/signal icon: wireless off.
		Antenna/signal icon: no service or searching.
		Roaming.
	Time and Next Appointment	Displays current time in analog or digital format.
	Instant Message	Notification that one or more instant messages were received.
	E-Mail	Notification that one or more e-mail messages were received.
	Voice Mail	Notification that one or more voice messages were received.
	Multiple Notifications	There are more notification icons than can be displayed. Tap to display remaining icons.

* Only appears in the *Time and Next Appointment* dialog box.

The command bar at the bottom of the screen can contain the task tray icons listed in [Table 2-2](#).

Table 2-2 *Task Tray Icons*

Icon	Description	
	Wireless connection status	Indicates WLAN signal strength.
	Bluetooth Enabled	Bluetooth radio is on.
	Bluetooth Disabled	Bluetooth radio is off.
	ActiveSync	Active connection between the EDA and the development PC.

Speaker Icon

To adjust the system volume using the *Speaker* icon in the navigation bar:

1. Tap the *Speaker* icon. The *Volume* dialog box appears.

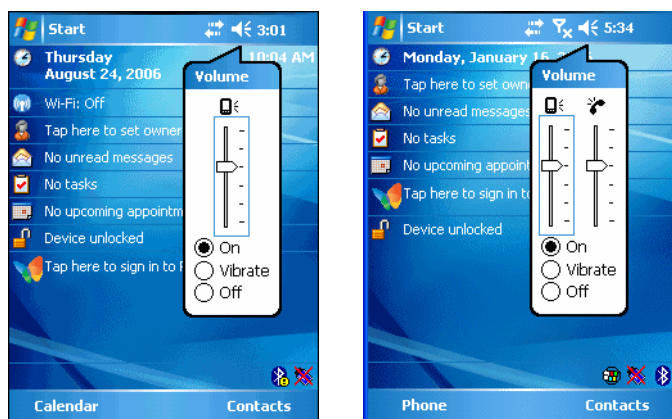

Figure 2-1 *Volume Dialog Box*

2. Tap and move the slide bar to adjust the volume.
3. Select the *On* or *Off* radio button to turn the volume on or off.

You can also adjust the system volume using the *Sounds & Notifications* window, or use the **Up/Down** button on the side of the EDA.

Battery Icon

Battery icons appear on the navigation bar when the main battery or backup battery power falls below a predetermined level. A *Battery* dialog box also appears indicating the status of the main or backup battery.

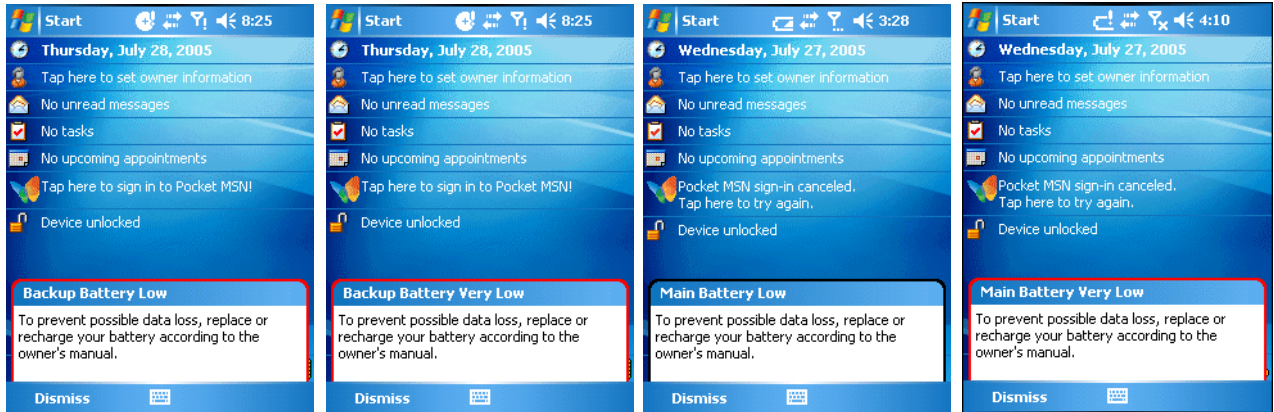

Figure 2-2 *Battery Status Dialog Box*

Also view the battery status using the *Power* window.

Connectivity Icon

The *Connectivity* icon indicates the communication status of the EDA when it is connecting to the internet or host computer.

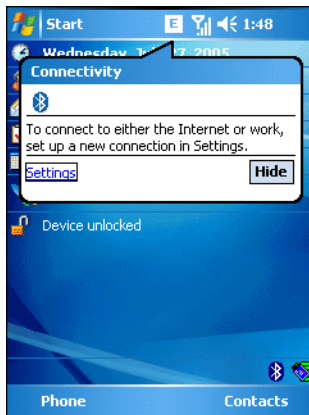

Figure 2-3 *Connectivity Dialog Box*

WWAN Icon

The *WWAN* icons indicate the status of the phone and antenna/signal.

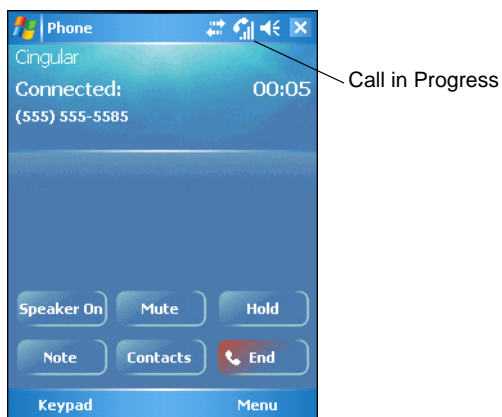

Figure 2-4 *WWANConnectivity Icon*

Time Icon

The *Time* icon displays the current time in a digital or analog format. To change the time format, tap and hold the *Time* icon until a menu appears. Select the format.



Figure 2-5 *Time Icon Format Menu*

To display current date, time, and appointments, tap the *Time* icon to display the *Time and Next Appointment* dialog box.

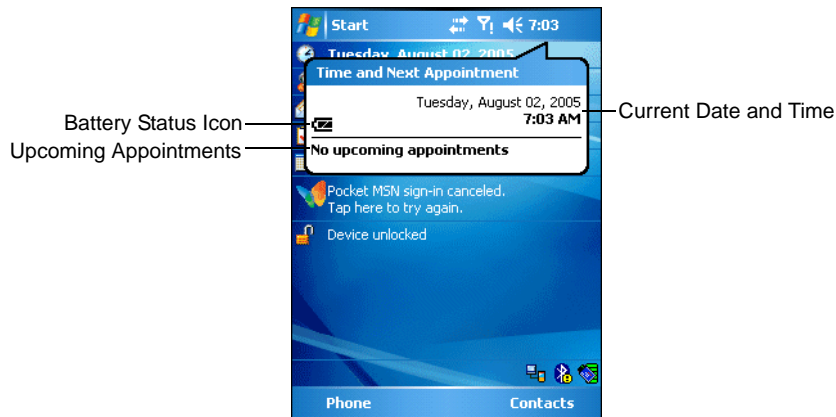

Figure 2-6 *Time and Next Appointment Dialog Box*

The dialog box displays the current date and time, the battery status, and any upcoming appointments in the *Calendar*.

Instant Message Icon

The *Instant Message* icon notifies you when *MSN Messenger* receives a new message.

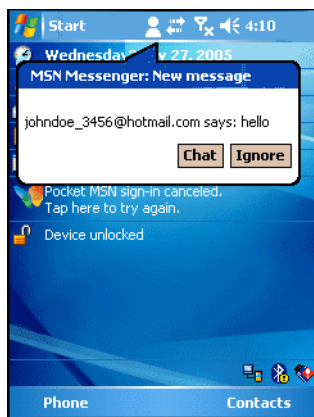

Figure 2-7 *MSN Messenger Dialog Box*

E-Mail Icon

The *E-Mail* icon notifies you when you receive incoming e-mails.

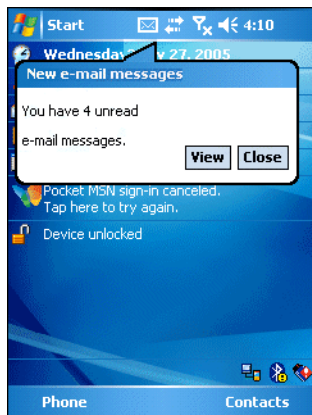

Figure 2-8 *New E-mail Messages Dialog Box*

Multiple Notifications Icon

The *Multiple Notifications* icon appears when two or more message notifications occur. Tap the icon to display the multiple notification icons.

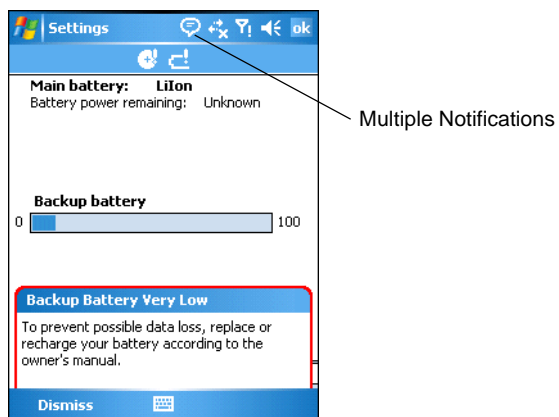

Figure 2-9 *Multiple Notifications Icon*

LED Indicators

The MC70 has three LED indicators. The Scan/Decode LED indicates status for scanning. The Charge Status LED indicates status for main battery charging. The Radio Power Status LED indicates radio status. [Table 2-3](#) describes the LED indications.

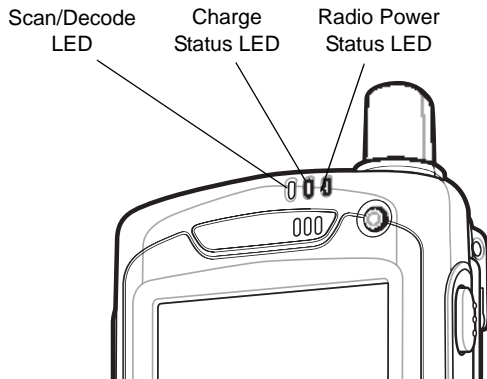

Figure 2-10 LED Indicators

Table 2-3 LED Indications

LED State	Indication
Scan/Decode LED	
Solid Green	Successful decode/capture.
Solid Red	Laser enabled, scanning/imaging in process.
Off	Not enabled.
Charge Status LED	
Slow Blinking Amber	Main battery in EDA is charging.
Solid Amber	Main battery in EDA is fully charged.
Fast Blinking Amber	Charging error.
Off	Not charging.
Radio Power Status LED*	
Slow Blinking Green	Any one of the radios is on.
Off	No radio is on.

*The Radio Power Status LED is disabled by default. A registry setting change is required to make this LED functional. Refer to the *MC70 Integrator Guide*.

✓ **NOTE** For information about scanning/decoding, see *Data Capture on page 2-20*. For information about radio status and settings, see *Chapter 3, Using Bluetooth*, *Chapter 4, Using the MC7004/MC7094 Phone*, or refer to the *MC70 Integrator Guide*.

Keypads

The EDA offers two modular keypad configurations: Numeric and QWERTY.

Numeric Keypad Configuration

The numeric keypad contains application keys, scroll keys, and function keys. The keypad is color-coded to indicate the alternate function key (blue) values. Note that an application can change keypad functions so the EDA's keypad may not function exactly as described. See [Table 2-4](#) for key and button descriptions and [Table 2-5 on page 2-11](#) for the keypad's special functions.

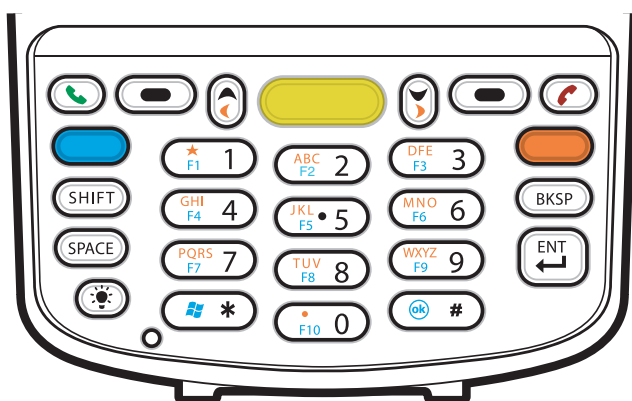

Figure 2-11 MC70 Numeric Keypad

Table 2-4 MC70 Numeric Keypad Descriptions











Key	Description
Blue Key (left) 	Use this key to launch applications or access items (shown on the keypad in blue). Press the Blue key once to activate this mode, followed by another key. A single press displays the following icon at the bottom of the screen, until a second key is pressed: 
Orange Key (right) 	Use this key to access the secondary layer of characters and actions (shown on the keypad in orange). Press the Orange key once to lock the keypad into Alpha state. A single press displays the following icon at the bottom of the screen:  Press the Orange key a second time to return to the normal state. Press the Orange key, then the Shift key to add a temporary shift (that applies only to the next key pressed) to the orange lock state. This displays the following icon at the bottom of the screen: 
Green/Red Phone  	MC7094 and MC7004: Green Phone: press to display the phone keypad window or to dial a phone number (from the phone keypad window). Red Phone: press when the phone keypad window displays to stop dialing or end a call. .
Scan (yellow) 	Activates the scanner/imager in a scan enabled application.
Scroll Up and Down 	Moves up one item. Moves left one item when pressed with the Orange key.
Scroll Left and Right 	Moves down one item. Moves right one item when pressed with the Orange key.
Menu 	Accesses the command or menu above it on the screen.
Star 	Produces an asterisk in default state. Press and release the blue key, then press the Star key to open the <i>Start</i> menu.

Table 2-4 MC70 Numeric Keypad Descriptions (Continued)



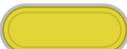





Key	Description
Alphanumeric 	<p>In default state, produces the numeric value on the key.</p> <p>In Alpha state, produces the lower case alphabetic characters on the key. Each key press produces the next alphabetic character in sequence. For example, press and release the Orange key and then press the '4' key once to produce the letter 'g'; press and release the Orange key and then press the '4' key three times to produce the letter 'i'.</p> <p>Press the SHIFT key in Alpha state to produce the upper case alphabetic characters on the key. For example, press and release the Orange key, press and release the SHIFT key, and then press the '4' key once to produce the letter 'G'; press and release the Orange key, press and release the SHIFT key and then press the '4' key three times to produce the letter 'I'.</p>
SPACE 	Produces a space.
BACKSPACE 	Produces a backspace.
SHIFT 	<p>Press and release the SHIFT key to activate the keypad alternate SHIFT functions.</p> <p>A single press displays the following icon at the bottom of the screen, until a second key is pressed: </p> <p>Press the Orange key, then the Shift key to add a temporary shift (that applies only to the next key pressed) to the orange lock state. This displays the following icon at the bottom of the screen: </p>
ENT (Enter) 	Executes a selected item or function.
Pound 	<p>Produces a pound/number sign.</p> <p>Press and release the blue key, then press the Pound key to produce an OK.</p>

Table 2-5 Numeric Keypad Input Modes

Key	Numeric Mode			Orange Key (Alpha Lowercase Mode)				Orange + Shift Keys (Alpha Uppercase Mode)			
		Blue+ Key	SHIFT + Key	1st Press	2nd Press	3rd Press	4th Press	1st Press	2nd Press	3rd Press	4th Press
1	1	F1	!	*	*	*	*	*	*	*	*
2	2	F2	@	a	b	c		A	B	C	
3	3	F3	#	d	e	f		D	E	F	

Note: An application can change the key functions. The keypad may not function exactly as described.

Table 2-5 *Numeric Keypad Input Modes (Continued)*

Key	Numeric Mode			Orange Key (Alpha Lowercase Mode)				Orange + Shift Keys (Alpha Uppercase Mode)			
		Blue+ Key	SHIFT + Key	1st Press	2nd Press	3rd Press	4th Press	1st Press	2nd Press	3rd Press	4th Press
4	4	F4	\$	g	h	i		G	H	I	
5	5	F5	%	j	k	l		J	K	L	
6	6	F6	^	m	n	o		M	N	O	
7	7	F7	&	p	q	r	s	P	Q	R	S
8	8	F8	*	t	u	v		T	U	V	
9	9	F9	(w	x	y	z	W	X	Y	Z
0	0	F10)	.				>			
Up	Up	Up	Hilight Up	Left				Left			
Down	Down	Down	Hilight Down	Right				Right			
Enter	Action	Action	Action	Action				Action			

Note: An application can change the key functions. The keypad may not function exactly as described.

QWERTY Keypad Configuration

The QWERTY keypad produces the 26-character alphabet (A-Z, both lowercase and uppercase), numbers (0-9), and assorted characters. The keypad is color-coded to indicate which modifier key to press to produce a particular character or action. The keypad default is alphabetic, producing lowercase letters. See [Table 2-6](#) for key and button descriptions and [Table 2-7 on page 2-15](#) for the keypad's special functions.



Figure 2-12 QWERTY Keypad Configuration

Table 2-6 QWERTY Keypad Descriptions





Key	Action
Blue Key (left) 	Launches applications (shown on the keypad in blue). <ul style="list-style-type: none"> Press the Blue key once to activate this mode temporarily, followed by another key. This displays the following icon at the bottom of the screen, until a second key is pressed:  Press the Blue key twice to lock this mode. This displays the following icon at the bottom of the screen:  Press the Blue key a third time to unlock. Press and hold the Blue key while selecting a sequence of keys to activate this mode temporarily. This displays the following icon at the bottom of the screen as long as the key is pressed: 

Table 2-6 QWERTY Keypad Descriptions (Continued)













Key	Action
Orange Key (right) 	Accesses the secondary layer of characters and actions (shown on the keypad in orange). <ul style="list-style-type: none"> • Press the Orange key once to activate this mode temporarily, followed by another key. This displays the following icon at the bottom of the screen, until a second key is pressed:  • Press the Orange key twice to lock this mode. This displays the following icon at the bottom of the screen:  • Press the Orange key a third time to unlock. • Press and hold the Orange key while selecting a sequence of keys to activate this mode temporarily. This displays the following icon at the bottom of the screen as long as the key is pressed: 
Green/Red Phone  	MC7094 and MC7004: Green Phone: press to display the phone keypad window or to dial a phone number (from the phone keypad window). Red Phone: press when the phone keypad window displays to stop dialing or end a call.
Scroll Up and Left 	Moves up one item. Moves left one item when pressed with the Orange key.
Scroll Down and Right 	Moves down one item. Moves right one item when pressed with the Orange key.
Menu 	Accesses the command or menu above it on the screen.
Shift 	Changes the state of the alpha characters from lowercase to uppercase. <ul style="list-style-type: none"> • Press the Shift key once to activate this mode temporarily, followed by another key. This displays the following icon at the bottom of the screen, until a second key is pressed:  • Press the Shift key twice to lock this mode. This displays the following icon at the bottom of the screen:  • Press the Shift key a third time to unlock. • Press and hold the Shift key while selecting a sequence of keys to apply a temporary shift. This displays the following icon at the bottom of the screen as long as the key is pressed: 

Table 2-6 QWERTY Keypad Descriptions (Continued)









Key	Action
Backlight 	Turns the display backlight on and off.
Backspace 	Produces a backspace.
Enter 	Executes a selected item or function.
Star 	Produces an asterisk.
OK 	Use this key in conjunction with the Blue key as an OK or close button. This function is user programmable.
Start Menu 	Use this key in conjunction with the Blue key to instantly display the <i>Start</i> menu from any application without tapping the screen. This function is user programmable.
Menu 	Use this key in conjunction with the Blue key to instantly display the context menu from any application without tapping the screen. This function is user programmable.
Phonepad 	Use this key in conjunction with the Blue key to display the Phonepad application without tapping the screen. This function is user programmable.

Table 2-7 QWERTY Keypad Input Modes

Key	Normal	Shift + Key	Orange + Key	Blue + Key
Q	q	Q	*	Start Menu
W	w	W	1	Menu
E	e	E	2	Phone
R	r	R	3	
T	t	T	+	
Y	y	Y	—	
U	u	U	-	

Note: An application can change the key functions. The keypad may not function exactly as described.

Table 2-7 QWERTY Keypad Input Modes (Continued)

Key	Normal	Shift + Key	Orange + Key	Blue + Key
I	i	l	=	
O	o	O	“	
P	p	P	áü	OK
A	a	A	#	
S	s	S	4	
D	d	D	5	
F	f	F	6	
G	g	G	(
H	h	H)	
J	j	J	/	
K	k	K	:	
L	l	L	‘	
BACKSPACE	Backspace			
Shift	Shift			
Z	z	Z	7	
X	x	X	8	
C	c	C	9	
V	v	V	%	
B	b	B	&	
N	n	N	!	
M	m	M	?	
,	,	<	@	
TAB	Tab		Back tab	
SPACE	Space			
.	.	>	0	
ENTER	Enter			

Note: An application can change the key functions. The keypad may not function exactly as described.

Special Character Key

✓ **NOTE** Special characters are only available on the QWERTY keypad configurations.

To add special characters using the MC70 **áü** key, type the related character first, then press the Orange + **áü** (**P**) key. Continue holding the Orange key and pressing the **áü** key until the special character displays. To modify an existing character, move the cursor to the right of the character then press and hold the Orange key and press the **áü** key until the special character replaces the original character. [Table 2-8](#) lists the special characters you can generate.

Table 2-8 *Special Characters*

Key	Special Characters
a	à á â ã ä å æ ç è é
A	À Á Â Ã Ä Å Æ Ç È É
c	ç
C	Ç
d	ð
D	Ð
e	è é ê ë
E	È É Ê Ë
i	ì í î ï
I	Ì Í Î Ï
l	ł
L	Ł
n	ñ
N	Ñ
o	ò ó ô õ ö ø
O	Ò Ó Ô Õ Ö Ø
p	þ
P	Þ
r	®
R	®
s	ş š
S	Ş Š
t	ţ

Table 2-8 *Special Characters (Continued)*

Key	Special Characters
T	Ŧ
u	ù ú û ü
U	Û Ü
y	ÿ
Y	Ÿ
z	ž ž
Z	Ž Ž
\$	€ £ ¥
/	\\
“	' « ' »
([{ < «
)] } > »
+	± & - _
!	! ? ¿
.	: ;
*	#
@	~ %
%	^
,	; . :
#	*
&	- _ + ±
_	+ ± & -
'	« » "
?	¿ ! !
:	: ; .
-	_ + ± &

Function Buttons

The EDA's buttons perform certain functions.

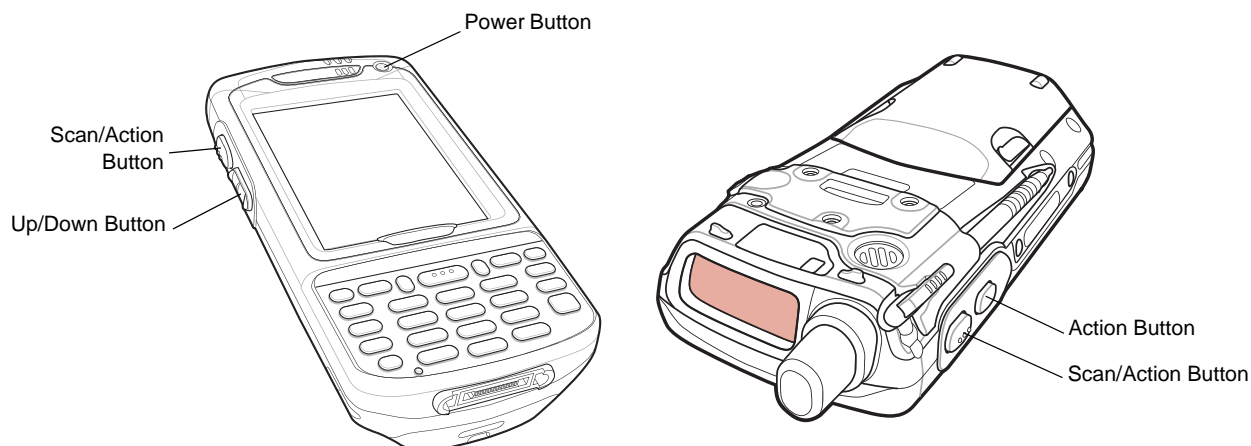

Figure 2-13 *Function Buttons*

- **Power:** Press the red **Power** button to turn the EDA screen on and off. The EDA is in suspend mode when the screen is off. For more information, see *Powering On the EDA* on page 1-8. Also use the **Power** button to reset the EDA by performing a warm or cold boot. See *Resetting the EDA* on page 2-24.
- **Scan/Action:** Press to scan bar codes or capture images. See *Data Capture* on page 2-20. Or, press to open an application or perform a function. See the *Microsoft® Applications for Mobile and CE 5.0 User Guide* to set an application to open.
- **Up/Down:** Press to increase or decrease the EDA's volume.
- **Action:** Press to open an application or perform a function. See the *Microsoft® Applications for Mobile and CE 5.0 User Guide* to set an application to open.

Stylus

Use the EDA stylus to select items and enter information. The stylus functions as a mouse.

- **Tap:** Touch the screen once with the stylus to press option buttons and open menu items.
- **Tap and Hold:** Tap and hold the stylus on an item to see a list of actions available for that item. On the pop-up menu that appears, tap the action to perform.
- **Drag:** Hold the stylus on the screen and drag across the screen to select text and images. Drag in a list to select multiple items.

✓ **NOTE** Symbol recommends using the spring-loaded tip of the stylus to write on the screen, and the back end of the stylus to tap the screen. Use your finger to press the **Power** button and keypad buttons.



CAUTION To prevent damage to the screen, do not use any device other than the Symbol-provided stylus.

Using a Headset

You can use a stereo headset for audio communication when using an audio-enabled application. To use a headset, plug the headset jack into the audio connector on the side of the EDA. Set the EDA's volume appropriately before putting the headset on. Plugging a headset into the jack mutes the speaker.

For the best audio performance, symbol recommends a 2.5mm jack headset, p/n 50-11300-050.

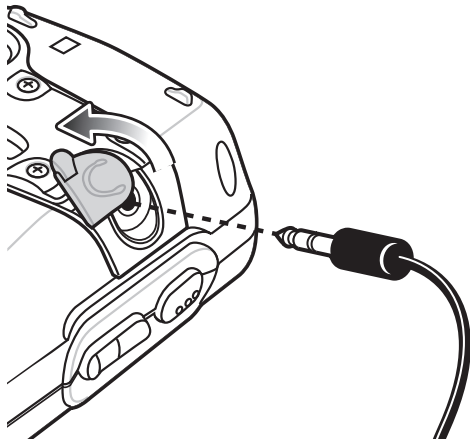
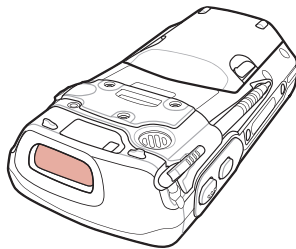

Figure 2-14 Using a Headset

Data Capture

The MC70 offers two types of data capture options:

- Linear scanning
- Imaging.



Linear Scanner

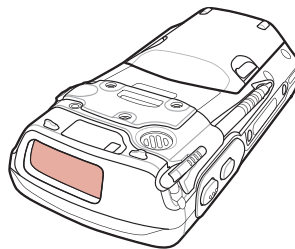

Imager

Figure 2-15 Data Capture Configurations

Linear Scanning

EDAs with an integrated linear scanner have the following features:

- Reading of a variety of bar code symbologies, including the most popular linear, postal, and 1-D code types.
- Intuitive aiming for easy point-and-shoot operation.

Imaging

EDAs with an integrated imager have the following features:

- Omnidirectional reading of a variety of bar code symbologies, including the most popular linear, postal, PDF417, and 2D matrix code types.
- The ability to capture and download images to a host for a variety of imaging applications.
- Advanced intuitive laser aiming for easy point-and-shoot operation.

The imager uses digital camera technology to take a digital picture of a bar code, stores the resulting image in its memory, and executes state-of-the-art software decoding algorithms to extract the data from the image.

Operational Modes

EDAs with an integrated imager support three modes of operation, listed below. Activate each mode by pulling the trigger or pressing the **Scan** button.

- **Decode Mode:** In this mode, the EDA attempts to locate and decode enabled bar codes within its field of view. The imager remains in this mode as long as you hold the trigger, or until it decodes a bar code.
- **Pick List Mode:** This mode allows you to selectively decode a bar code when more than one bar code is in the EDA's field of view. To accomplish this, move the aiming crosshair over the required bar code to decode only this bar code. This feature is ideal for pick lists containing multiple bar codes and manufacturing or transport labels containing more than one bar code type (either 1D or 2D).
- **Image Capture Mode:** Use this mode to capture an image within the EDA's field of view. This is useful for capturing signatures or images of items like damaged boxes.

Scanning Considerations

Typically, scanning is a simple matter of aim, scan, and decode and a few quick trial efforts master it. However, consider the following to optimize scanning performance:

- **Range**
Any scanning device decodes well over a particular working range — minimum and maximum distances from the bar code. This range varies according to bar code density and scanning device optics.
Scanning within range brings quick and constant decodes; scanning too close or too far away prevents decodes. Move the scanner closer and further away to find the right working range for the bar codes being scanned.

- Angle

Scanning angle is important for promoting quick decodes. When laser beams reflect directly back into the scanner from the bar code, this specular reflection can “blind” the scanner.

To avoid this, scan the bar code so that the beam does not bounce directly back. But don't scan at too sharp an angle; the scanner needs to collect scattered reflections from the scan to make a successful decode. Practice quickly shows what tolerances to work within.

- Hold the EDA farther away for larger symbols.
- Move the EDA closer for symbols with bars that are close together.

✓ **NOTE** Scanning procedures depend on the application and EDA configuration. An application may use different scanning procedures from the one listed above.

Linear Scanning

1. Ensure that a scan enabled application is loaded on the EDA.
2. Aim the scan window at the bar code.

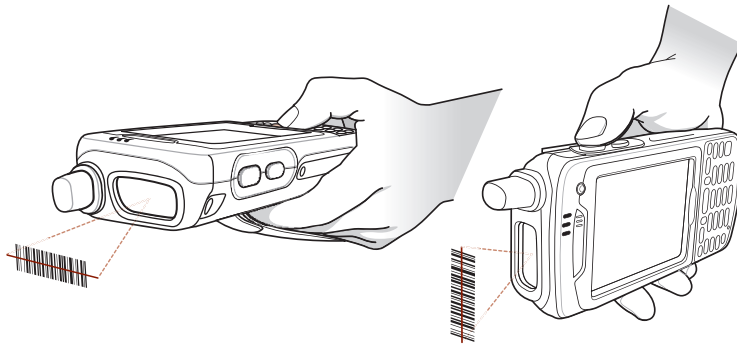

Figure 2-16 *Linear Scanning*

3. Press the scan button. Ensure the red scan beam covers the entire bar code. The Scan/Decode LED lights red to indicate that scanning is in process, then lights green and a beep sounds, by default, to indicate the bar code was decoded successfully.

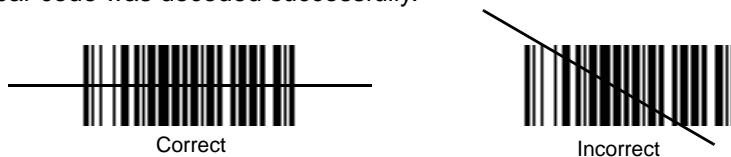

Figure 2-17 *Linear Scanner Aiming Pattern*

Imager Scanning

1. Ensure that a scan-enabled application is loaded on the EDA.
2. Aim the scan window at the bar code.

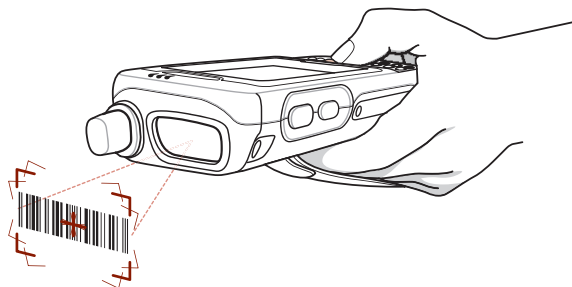

Figure 2-18 *Imager Scanning*

3. Press the scan button. The red laser aiming pattern turns on to assist in aiming. Ensure the bar code is within the area formed by the brackets in the aiming pattern. The Scan/Decode LED lights red to indicate that scanning is in process, then lights green and a beep sounds, by default, to indicate the bar code was decoded successfully. Note that when the EDA is in Pick List Mode, the imager does not decode the bar code until the crosshair touches the bar code.

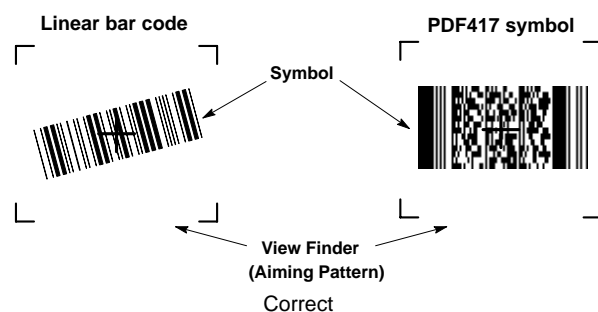

Figure 2-19 *Imager Aiming Pattern: Bar Code Centered*

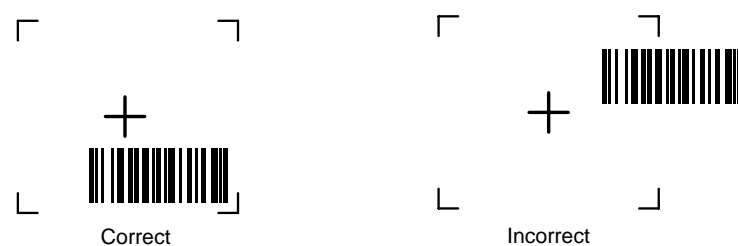

Figure 2-20 *Imager Aiming Pattern: Bar Code Not Centered*

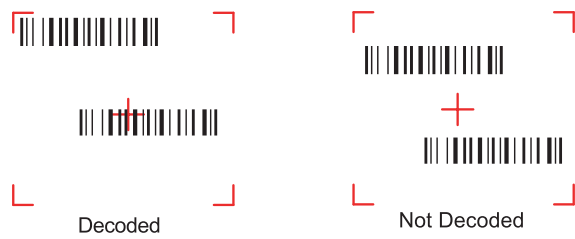

Figure 2-21 *Pick List Mode with Multiple Bar Codes in Aiming Pattern*

4. Release the scan button.

✓ **NOTE** Imager decoding usually occurs instantaneously. The EDA repeats the steps required to take a digital picture (image) of a poor or difficult bar code as long as the scan button remains pressed.

Resetting the EDA

There are two reset functions, warm boot and cold boot. A warm boot restarts the EDA by closing all running programs. A cold boot also restarts the EDA, and also resets the clock. Data saved in flash memory or a memory card is not lost.

Perform a warm boot first. If the EDA still does not respond, perform a cold boot.

Performing a Warm Boot

Hold down the **Power** button for approximately five seconds. As soon as the EDA starts to boot release the **Power** button.

Performing a Cold Boot

To perform a cold boot simultaneously press the **Power** button and the **1** and **9** keys.

Waking the EDA

The wakeup conditions define what actions wake up the EDA. These settings are configurable and the factory default settings shown in [Table 2-9](#) are subject to change/update.

Table 2-9 *Wakeup Conditions (Default Settings)*

Status	Description	Conditions for Wakeup
Power Off (Suspend Mode)	When the EDA suspends by pressing Power , these actions wake the EDA.	1. Power button is pressed. 2. AC power added or removed. 3. Cradle/cable connect or disconnect.
		Key or scan button is pressed.
		Real Time Clock set to wake up.
		Incoming phone call (MC7004/7094 only)
Auto Off	When the EDA suspends by an automatic power-off function, these actions wake the EDA.	1. Power button is pressed. 2. AC power added or removed. 3. Cradle/cable connect or disconnect.
		Key or scan button is pressed.
		Real Time Clock set to wake up.
		Incoming phone call (MC7004/7094 only)

Locking the EDA

Use the Device Lock feature to prevent use of the device. Note that when locked, the EDA does not respond to screen or keypad input.

To lock the device, tap the *Device unlocked* icon. The icon changes to locked.

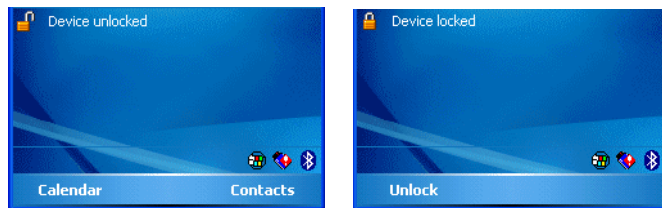

Figure 2-22 *Device Locked/Unlocked Icons*

To unlock the device and free it for use, tap *Unlock*.



Figure 2-23 *Unlock Device Window*

Tap **Unlock** on the *Unlock Device* window.

Introduction

Bluetooth-equipped devices can communicate without wires, using frequency-hopping spread spectrum (FHSS) radio frequency (RF) to transmit and receive data in the 2.4 GHz Industry Scientific and Medical (ISM) band (802.15.1). Bluetooth wireless technology is specifically designed for short-range (30 feet/10 meters) communication and low power consumption.

EDAs with Bluetooth capabilities can exchange information (e.g., files, appointments, and tasks) with other Bluetooth enabled devices such as phones, printers, access points, and other mobile computers. To use the Bluetooth phone as a modem, create a dial-up modem connection between the Bluetooth mobile computer and a Bluetooth enabled phone.

Symbol mobile computers with Bluetooth technology use the StoneStreet Bluetooth stack. To program Bluetooth within the EDA refer to the Microsoft Embedded Visual C++ help.

Adaptive Frequency Hopping

Adaptive Frequency Hopping (AFH) is a method of avoiding fixed frequency interferers, and can be used with Bluetooth voice. All devices in the piconet (Bluetooth network) must be AFH-capable in order for AFH to work. There is no AFH when connecting and discovering devices. Avoid making Bluetooth connections and discoveries during critical 802.11b communications. AFH for Bluetooth consists of four main sections:

- Channel Classification - A method of detecting an interference on a channel-by-channel basis, or pre-defined channel mask.
- Link Management - Coordinates and distributes the AFH information to the rest of the Bluetooth network.
- Hop Sequence Modification - Avoids interference by selectively reducing the number of hopping channels.
- Channel Maintenance - A method for periodically re-evaluating the channels.

When AFH is enabled, the Bluetooth radio “hops around” (instead of through) the 802.11b high-rate channels. AFH coexistence allows Symbol mobile computers to operate in any infrastructure.

The Bluetooth radio in this EDA operates as a Class 2 device power class. The maximum output power is 2.5mW and the expected range is 32.8 feet (10 meters). A definition of ranges based on power class is difficult to obtain due to power and device differences, and whether one measures open space or closed office space.

- ✓ **NOTE** It is not recommended to perform Bluetooth wireless technology inquiry when high rate 802.11b operation is required.

Security

The current Bluetooth specification defines security at the link level. Application-level security is not specified. This allows application developers to define security mechanisms tailored to their specific need. Link-level security occurs between devices, not users, while application-level security can be implemented on a per-user basis. The Bluetooth specification defines security algorithms and procedures needed to authenticate devices, and if needed, encrypt the data flowing on the link between the devices. Device authentication is a mandatory feature of Bluetooth while link encryption is optional.

Pairing of Bluetooth devices is accomplished by creating an initialization key that is used to authenticate the devices and create a link key for them. Entering a common PIN number in the devices being paired generates the initialization key. The PIN number is never sent over the air. By default, the Bluetooth stack responds with no key when a key is requested (it is up to user to respond to the key request event). Authentication of Bluetooth devices is based-upon a challenge-response transaction. Bluetooth allows for a PIN number or passkey that is used to create other 128-bit keys used for security and encryption. The encryption key is derived from the link key used to authenticate the pairing devices. Also worthy of note is the limited range and fast frequency hopping of the Bluetooth radios that makes long-distance eavesdropping difficult.

Recommendations are:

- Perform pairing in a secure environment
- Keep PIN codes private and don't store the PIN codes in the mobile computer
- Implement application-level security.

Turning the Bluetooth Radio Mode On and Off

Turn off the Bluetooth radio to save power or if entering an area with radio restrictions (e.g., an airplane). When the radio is off, other Bluetooth devices cannot see or connect to the EDA. Turn on the Bluetooth radio to exchange information with other Bluetooth devices (within range). Communicate only with Bluetooth radios in close proximity.

✓ **NOTE** To achieve the best battery life in EDAs with multiple radios, turn off radios not in use.

Disabling Bluetooth

To disable Bluetooth, tap *Bluetooth* icon - *Disable Bluetooth*. The *Bluetooth* icon changes to indicate that Bluetooth is disabled.

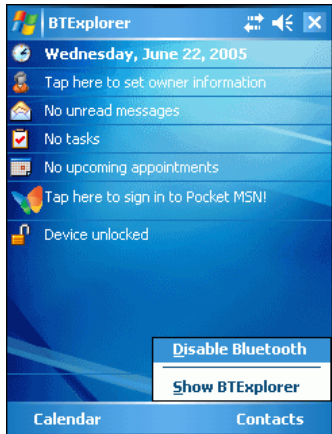

Figure 3-1 *Disable Bluetooth*

Enabling Bluetooth

To enable Bluetooth, tap *Bluetooth* icon - *Enable Bluetooth*. The *Bluetooth* icon changes to indicate that Bluetooth is enabled.

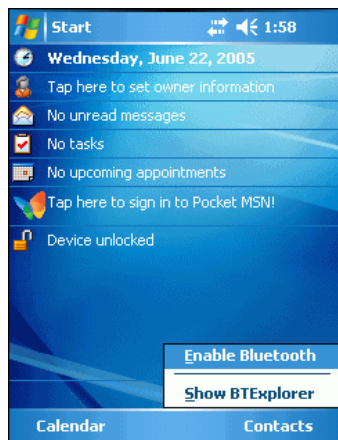

Figure 3-2 *Enable Bluetooth*

Bluetooth Power States

Cold Boot

Performing a cold boot on the EDA turns off Bluetooth after initialization (which takes a few moments). It is normal to see the *Bluetooth* icon appear and disappear, as well as a wait cursor, when initialization proceeds in all modes.

Warm Boot

Performing a warm boot on the EDA returns Bluetooth to the last state after initialization.

Suspend

Suspending the EDA turns off Bluetooth.

- ✓ **NOTE** Suspending the EDA powers off the Bluetooth radio and drops the piconet (Bluetooth connection). When the EDA resumes, it take approximately 10 seconds for the Bluetooth radio driver to re-initialize the radio.

Resume

When the EDA resumes, Bluetooth turns on if it was on prior to suspend.

Modes

The BTE Explorer application has two mode for managing Bluetooth connections: Wizard Mode and Explorer Mode. The Wizard Mode is for novice Bluetooth users and the Explorer Mode is for experienced Bluetooth users. To switch between modes, select *View - Wizard Mode* or *View - Explorer Mode*.

Wizard Mode

Wizard Mode provides a simple process for discovering and connecting to Bluetooth devices.

- ✓ **NOTE** Switching between Wizard Mode and Explorer Mode closes all active connections.

The following steps provide an example for using the Wizard to connect to remote devices.

1. Tap the *Bluetooth* icon and select *Show BTE Explorer*. The *BTE Explorer* window appears.
2. Tap *File - New Connection*. The *New Connection Wizard* window appears.



Figure 3-3 *New Connection Wizard Window*

3. Select an action from the drop-down list. Options include:

- Explore Services on Remote Device
- Pair with a Remote Device
- Active Sync via Bluetooth
- Browse Files on Remote Device
- Connect to Headset
- Connect to Internet Using Access Point
- Connect to Internet Using Phone/Modem
- Connect to a Personal Area Network
- Send or Exchange Objects
- Associate Serial Port.

✓ **NOTE** If you select *Active Sync via Bluetooth*, ensure that the Bluetooth software is set up properly on the host device.

4. Tap **Next**. The *BTE Explorer* searches for Bluetooth devices in the area and displays the devices in the *Select Remote Device* window.

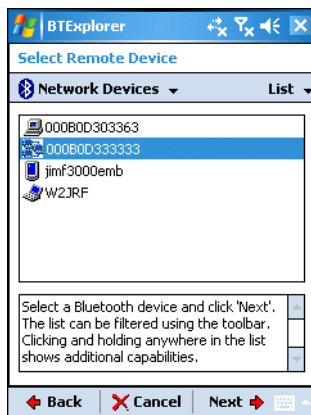

Figure 3-4 *Select Remote Device Window*

5. Select a device from the list and then tap **Next**. The *Connection Favorite Options* window appears.



Figure 3-5 *Connection Favorite Options Window*

6. Select the *Save As Favorite* check box to save this service in the *Favorite* view.
7. In the *Favorite Name* text box, enter a name for this service that will appear in the *Favorite* list.
8. Tap **Next**. The *Connection Summary* window appears.



Figure 3-6 *Connection Summary Window*

9. Tap **Connect** to connect to the service.

Explorer Mode

The *Explorer Mode* window is easy to navigate and provides greater control to users familiar with Bluetooth. The menu bar provides quick access to the options and tools used to connect to devices. To access Explorer Mode, tap *View - Explorer Mode*.

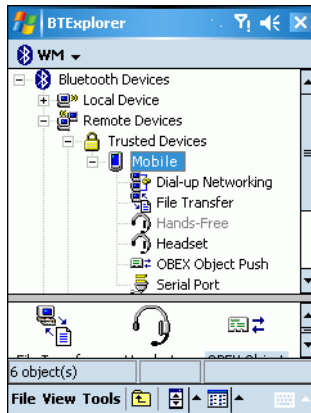

Figure 3-7 *Explorer Mode Window*

You can also use the “tap and hold” technique to view available options. Scroll bars and view options are similar to those on the Windows desktop. The tree structure lists the following sub-items:

- Local Device - This EDA
- Remote Device - Other Bluetooth devices
 - Trusted Devices - Bonded (paired) Bluetooth devices
 - Untrusted Devices - Discovered devices that are not bonded
- Favorites - Selected services that are set as *Favorite* for quick access.

✓ **NOTE** Switching between Wizard Mode and Explorer Mode closes all active connections.

Discovering Bluetooth Device(s)

The EDA can receive information from discovered devices without bonding. However, once bonded, the EDA and a bonded device exchange information automatically when you turn the Bluetooth radio on.

To find Bluetooth devices in the area:

1. Ensure that the Bluetooth device to discover is in discoverable mode.
2. Ensure that the two devices are within 30 feet (10 meters) of one another.
3. Tap the *Bluetooth* icon and select *Show BTE Explorer*. The *BTE Explorer* window appears.

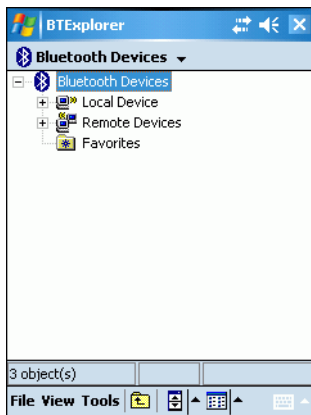

Figure 3-8 *BTE Explorer Window*

4. Tap and hold *Remote Devices* and select *Discover Devices* from the pop-up menu. The EDA searches for Bluetooth devices in the area.

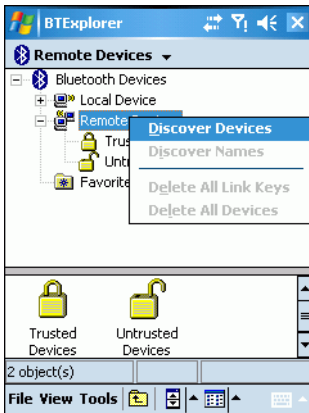

Figure 3-9 *Discover Devices*

The discovered devices display in the *Untrusted Devices* folder.

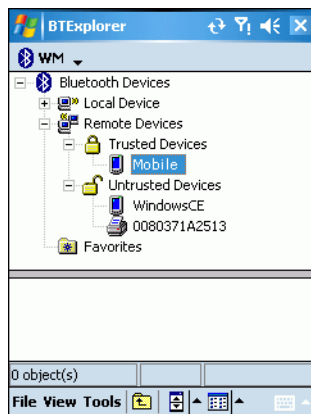

Figure 3-10 *Discovered Devices Listed in Untrusted Folder*

Bonding with Discovered Device(s)

A bond is a relationship created between the EDA and another Bluetooth device in order to exchange information in a secure manner. Creating a bond involves entering the same PIN on the two devices. After creating a bond and turning on the Bluetooth radios, the devices recognize the bond and can exchange information without re-entering a PIN.

To bond with a discovered Bluetooth device:

1. Discover remote devices. See *Discovering Bluetooth Device(s) on page 3-7*.
2. In the *Untrusted Devices* folder, tap and hold on a device to pair with.

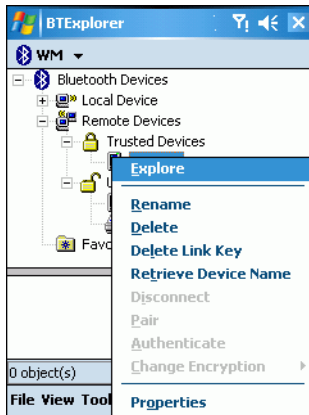

Figure 3-11 Pairing a Remote Device

3. Select *Pair* from the pop-up menu. The *PIN Code Request* window appears.



Figure 3-12 PIN Code Request Window

4. In the *PIN Code*: text box, enter the PIN number (between 1 and 16 characters) and then tap **OK**.
5. On the remote device, enter the same PIN number.

- The devices pair and the device name moves to the *Trusted Devices* folder.

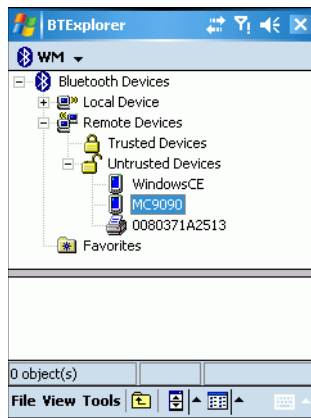

Figure 3-13 Bonded (Paired) Discovered Device

Renaming a Bonded Device

To rename a bonded device:

- Launch *BTE Explorer*.
- Tap and hold the device to rename.

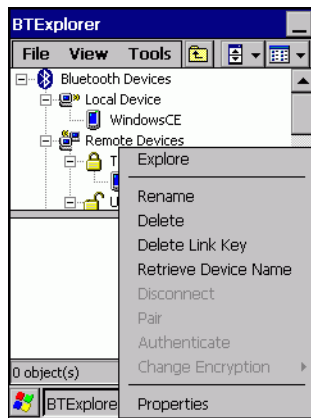

Figure 3-14 Rename Device Selection Dialog Box

3. Select *Rename* in the pop-up menu. The *Change Device Name* window appears.

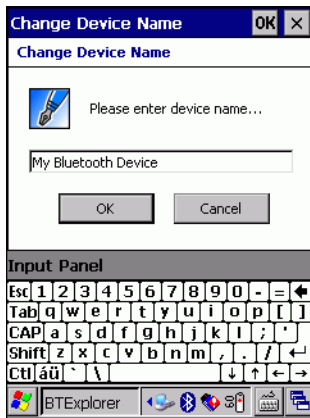

Figure 3-15 *Change Device Name Window*

4. Enter a new name for the bonded device in the text box. Tap **OK**.

Deleting a Bonded Device

To delete a device no longer needed:

1. Launch *BTExplorer*.
2. Tap and hold the device to delete and select *Delete* in the pop-up menu.

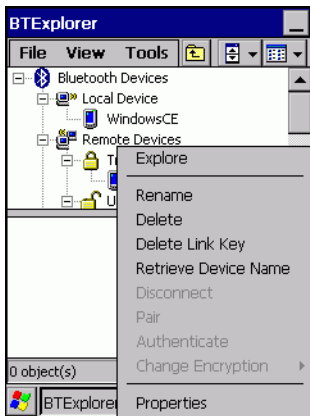

Figure 3-16 *Deleting a Bonded Device*

3. A confirmation dialog appears. Tap **Yes**.

Accepting a Bond

When a remote device wants to bond with the EDA, enter a PIN when requested to grant permission.

1. Ensure that the EDA is set to discoverable and connectable. See *Bluetooth Settings* on page 3-25. When prompted to bond with the remote device the *PIN Code Request* window appears.

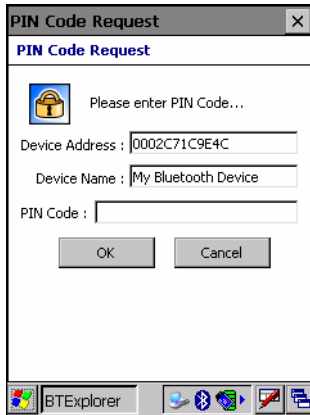

Figure 3-17 *PIN Code Request Window*

2. In the *PIN Code*: text box, enter the same PIN entered on the device requesting the bond. The PIN must be between 1 and 16 characters.
3. In the *Device Name*: text box, edit the name of the device requesting the bond, if desired.
4. Tap **OK** to create the bond. The EDA can now exchange information with the other device.

Discovering Services

Before using services, first discover remote devices and then bond to those devices.

To determine what services are available on a bonded remote device:

1. Tap the *Bluetooth* icon and select *Show BTE Explorer*.
2. In *BTE Explorer* window, tap and hold on the remote device and select *Explore* from the pop-up menu.

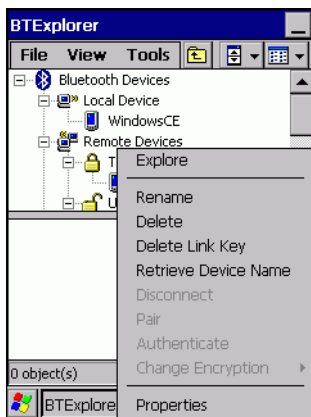

Figure 3-18 *Discovering Services*

The EDA communicates with the remote device and lists the services under the device name.

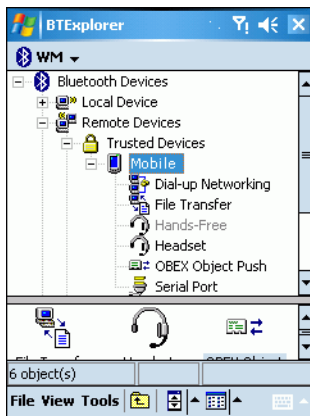

Figure 3-19 *List of Discovered Services*

Some examples of available services are:

- File Transfer Services
- Dial-Up Networking Services
- OBEX Object Push Services
- Headset or Hands-Free Services
- Serial Port Services.

See the following sections for information on these services.

File Transfer Services

To transfer files between the EDA and another Bluetooth enabled device:

1. Ensure the EDA is discoverable and connectable. See *Bluetooth Settings* on page 3-25.
2. Discover and bond (pair) with the remote access point. See *Bonding with Discovered Device(s)* on page 3-8.
3. In *BTE Explorer*, select the *Remote Devices* folder.
4. Select the *Trusted Devices* folder.
5. Tap the remote device folder.
6. Tap and hold on the remote device and select *Explore* from the pop-up menu.
7. Tap and hold on *File Transfer* and select *Connect*. The remote device's accessible folders appear.

8. Select a folder. The contents of the folder appear in the sub-window.

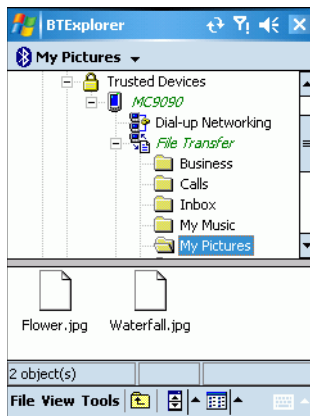

Figure 3-20 Remote Device Folders

9. Tap and hold on the file. A pop-up menu appears.
10. Select the action to perform:
 - *New* - create a new file or folder on the remote device
 - *Delete* - delete the selected file on the remote device.
 - *Get File* - copy the file from the remote device to the EDA.
 - *Put File* - copy a file from the EDA to the remote device.

Creating a New File or Folder

To create a new folder or file on the remote device:

1. Tap and hold on the file and select *New - Folder* or *New - File*. The *Create New Folder* or *Create New File* window appears.
2. Enter the name for the new folder or file.
3. Tap **OK** to create the new folder or file on the remote device.

Deleting a File

To delete a file from the remote device:

1. Tap and hold on the file and select *Delete*.
2. In the *Delete Remote Device File* dialog box tap **OK**.

Getting a File

To copy a file from a remote device:

1. Tap and hold on the file and select *Get*. The *Save Remote File* window appears.
2. Navigate to the directory to save the file.
3. Tap **Save**. The file is transferred from the remote device to the EDA.

Copying a File

To copy a file to a remote device:

1. Tap and hold on the file and select *Put*. The *Send Local File* window appears.
2. Navigate to the directory to save the file and select a file.
3. Tap **Open**. The file copies from the EDA to the remote device.

Connecting to the Internet Using an Access Point

This section explains how to access a Bluetooth-enabled LAN access point (AP) for a network connection. Use Internet Explorer to connect to a server.

1. Ensure the EDA is discoverable and connectable. See *Bluetooth Settings* on page 3-25.
2. Discover and bond (pair) with the remote access point. See *Bonding with Discovered Device(s)* on page 3-8.
3. In *BTE Explorer*, select the *Remote Devices* folder.
4. Select the *Trusted Devices* folder.
5. Tap the remote device folder.
6. Tap and hold on the remote device and select *Explore* from the pop-up menu.
7. Tap and hold *LAN Access using PPP service* and select *Connect* from the pop-up menu. The EDA connects with the access point.
8. Tap *Start - Internet Explorer*. The *Internet Explorer window* appears.
9. In the address field, enter an internet address and tap the **Enter** button. The web page loads.

Dial-Up Networking Services

To use a phone that has Bluetooth capabilities as a modem for the EDA, create a Bluetooth modem connection on the EDA and send information to the phone using Bluetooth. The phone relays the information over the phone line and sends back to the EDA any information that was requested over the connection. After creating a modem connection to the Bluetooth phone, you can reuse it.

Prior to creating a connection, ensure the following:

- Bluetooth phone is turned on.
- Bluetooth phone is discoverable. (Some phones must also be pairable to accept a bonding request. For more information, refer to the phone documentation.)
- EDA's and phone's Bluetooth radios are turned on.
- EDA and phone are within range of each other (30 feet/10 meters).

Before setting up dial-up networking, obtain dial-up information and other necessary settings for the office network or ISP. To create a new Bluetooth connection:

1. Ensure the EDA is discoverable and connectable. See *Bluetooth Settings* on page 3-25.
2. Discover and bond (pair) with the remote device. See *Bonding with Discovered Device(s)* on page 3-8.
3. In *BTE Explorer*, select the *Remote Devices* folder.
4. Select the *Trusted Devices* folder.
5. Tap the remote device folder.
6. Tap and hold on *Dial-up Networking* and select *Connect* from the pop-up menu. The *Select Dial-up Networking Entry* window appears.

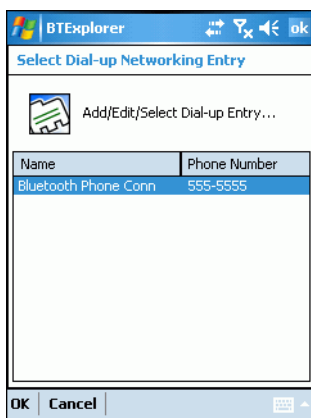

Figure 3-21 *Select Dial-up Networking Entry Window*

✓ **NOTE** If a dial-up entry is not listed, see *Adding a Dial-up Entry* on page 3-18.

7. Select a dial-up entry.
8. Tap **OK**. The EDA begins to communicate with the phone. If required, the phone requests permission to communicate with the EDA.
9. Confirm the connection on the phone. The *Network Log On* window appears.

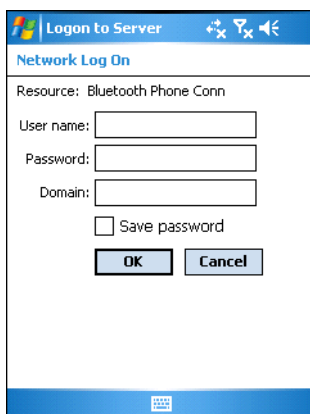

Figure 3-22 *Network Log On Window*

10. In the *User name*: text box, enter the user name for this connection.
11. In the *Password*: text box, enter the password for this connection.
12. In the *Domain*: text box, enter the domain for this connection, if required.
13. Tap **OK**. The phone begins dialing, then connects to the network.

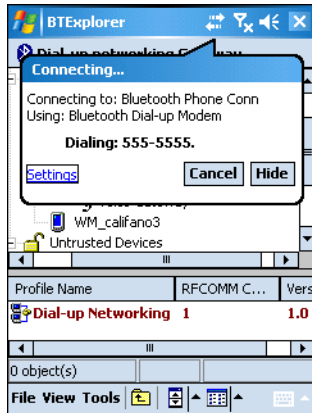

Figure 3-23 Connecting to Bluetooth Phone

14. To end a session, tap the *Connection* icon and then tap **Disconnect** in the dialog box.

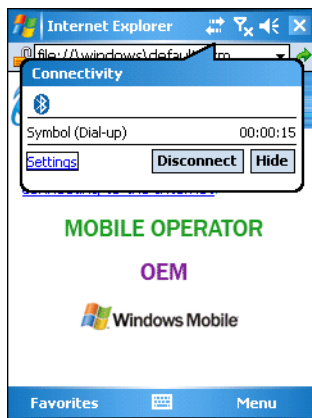

Figure 3-24 Connectivity Dialog Box

Adding a Dial-up Entry

To add a dial-up entry:

1. In the *Select Dial-up Networking Entry* window, tap and hold, then select *Add Entry* from the pop-up menu.



Figure 3-25 Add Dial-Up Entry

The *Add Phone Book Entry* window appears.

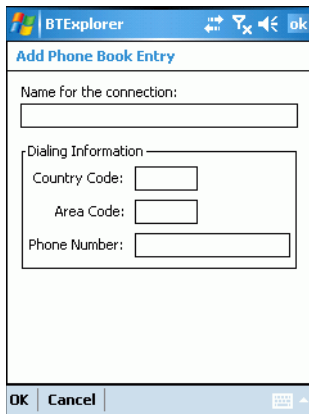

2. In the *Name for the connection:* text box, enter a name for this connection.
3. In the *Country Code:* text box, enter the country code for the country that you are calling.
4. In the *Area Code:* text box, enter the area code.
5. In the *Phone Number:* text box, enter the phone number.
6. Tap **OK**.

Object Exchange Push Services

Object Exchange (OBEX) is a set of protocols that allows sharing objects such as Contacts or pictures using Bluetooth.

To exchange contact information with another Bluetooth enabled device:

1. Ensure the EDA is discoverable and connectable. See *Bluetooth Settings on page 3-25*.
2. Discover and bond (pair) with the remote device. See *Bonding with Discovered Device(s) on page 3-8*.
3. In *BTE Explorer*, select the *Remote Devices* folder.
4. Select the *Trusted Devices* folder.
5. Tap the remote device folder.
6. Tap and hold on *OBEX Object Push* and select *Connect*. The *OBEX Object Push* window appears.
7. In the *Action* drop-down list, select one of the following options: *Send Contact Information*, *Swap Contact Information*, *Fetch Contact Information*, or *Send a Picture*.

Sending a Contact

To send a contact to another device:

1. Ensure the EDA is discoverable and connectable. See *Bluetooth Settings on page 3-25*.
2. Discover and bond (pair) with the remote device. See *Bonding with Discovered Device(s) on page 3-8*.
3. In *BTE Explorer*, select the *Remote Devices* folder.
4. Select the *Trusted Devices* folder.
5. Tap the remote device folder.
6. Tap and hold on *OBEX Object Push* and select *Connect*. The *OBEX Object Push* window appears.



Figure 3-26 *OBEX Object Push Window*

7. In the *Action*: drop-down list, select *Send Contact Information*.

8. Tap  . The *Select Contact Entry* window appears.

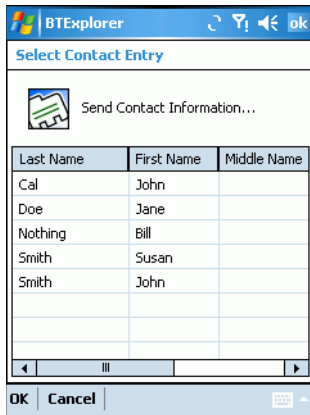

Figure 3-27 *Select Contact Entry Window*

9. Select a contact to send to the other device.
10. Tap **OK**.
11. Tap **OK** to send the contact to the other device and display a confirmation dialog box on the other device to accept the contact. A *Send Contact* dialog appears.
12. Tap **Ok**.

Sending a Picture

To send a picture to another device:

1. Ensure the EDA is discoverable and connectable. See *Bluetooth Settings* on page 3-25.
2. Discover and bond (pair) with the remote device. See *Bonding with Discovered Device(s)* on page 3-8.
3. In *BTE Explorer*, select the *Remote Devices* folder.
4. Select the *Trusted Devices* folder.
5. Tap the remote device folder.

6. Tap and hold on *OBEX Object Push* and select *Connect*. The *OBEX Object Push* window appears.

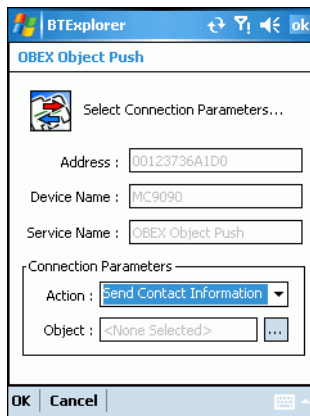

Figure 3-28 *OBEX Object Push Window*

7. In the *Action:* drop-down list, select *Send A Picture*.
8. Tap . The *Send Local Picture* window appears.

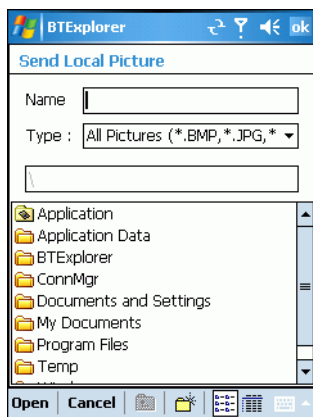

Figure 3-29 *Send Local Picture Window*

9. Navigate to the picture to send to the other device.
10. Tap **Open**.
11. Tap **OK** to send the picture to the other device and display a confirmation dialog box on the other device to accept the picture. A *Send Picture* dialog appears.
12. Tap **Ok**.

Headset Services

To connect to a Bluetooth headset:

1. Ensure the EDA is discoverable and connectable. See *Bluetooth Settings* on page 3-25.
2. Discover and bond (pair) with the headset. See *Bonding with Discovered Device(s)* on page 3-8.
3. In *BTExplorer*, select the *Remote Devices* folder.

4. Select the *Trusted Devices* folder.
5. Tap the remote device folder.
6. Tap and hold on the remote device and select *Explore*. A headset service item appears.
7. Tap and hold on the headset service name and select *Connect*. The EDA connects to the headset. Refer to the headset user manual for instructions on communicating with a Bluetooth device.

To adjust the microphone gain:

1. Tap and hold on the headset service item and select *Adjust Microphone* from the pop-up menu. The *Microphone Properties* window appears.
2. Select the slider and adjust the gain.
3. Tap **OK**.

Serial Port Services

Use the wireless Bluetooth serial port connection as you would a physical serial cable connection. Configure the application that will use the connection to the correct serial port.

To establish a serial port connection:

1. Ensure the EDA is discoverable and connectable. See *Bluetooth Settings* on page 3-25.
2. Discover and bond (pair) with the remote device. See *Bonding with Discovered Device(s)* on page 3-8.
3. In *BTE Explorer*, select the *Remote Devices* folder.
4. Select the *Trusted Devices* folder.
5. Tap the remote device folder.
6. Tap and hold *Serial Port* and select *Connect* in the pop-up menu. The *Remote Service Connection* window appears.

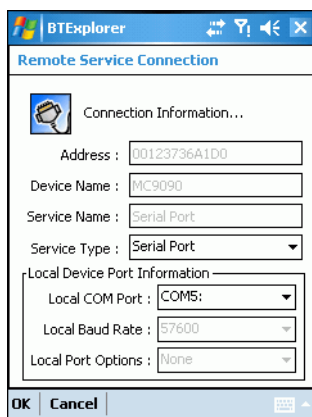

Figure 3-30 *Remote Service Connection Window*

7. In the *Local COM Port*: drop-down list select a COM port.
8. Tap **OK**.

ActiveSync Using Serial Port Services

- ✓ **NOTE** By default, COM ports COM4, COM5, and COM9 are Bluetooth virtual ports. If an application opens one of these ports, the Bluetooth driver activates and guides you through a Bluetooth connection.

Use the wireless Bluetooth serial port connection for ActiveSync just as you would a physical serial cable connection. You must configure the application that will use the connection to the correct serial port.

To establish an ActiveSync connection:

1. On the host computer, ensure the Bluetooth software is set up properly.
2. Ensure the mobile computer is discoverable and connectable. See *Bluetooth Settings* on page 3-25.
3. Discover and bond (pair) with the remote device. See *Bonding with Discovered Device(s)* on page 3-8.
4. In *BTE Explorer*, select the *Remote Devices* folder.
5. Select the *Trusted Devices* folder.
6. Tap the remote device folder.
7. Tap and hold *ActiveSync* and select *Connect* in the pop-up menu.

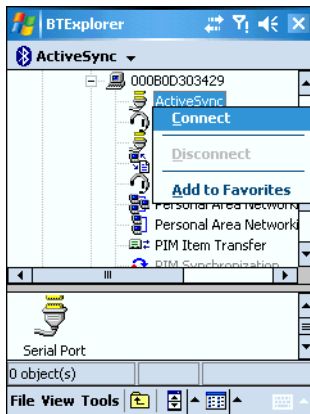

Figure 3-31 Connect to ActiveSync Service

8. The *Remote Service Connection* window appears. In the *Local COM Port* drop-down list, select a COM port.

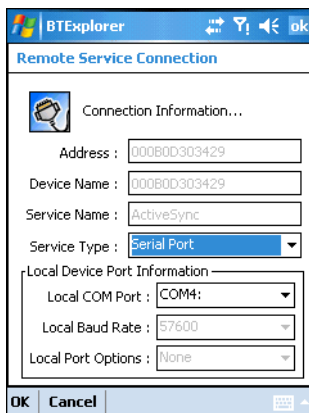

Figure 3-32 Remote Service Connection Window

9. Tap **OK**. The mobile computer communicates with the host computer and ActiveSync initiates.

Personal Area Network Services

Connect two or more Bluetooth devices to share files, collaborate, or play multi-player games.

To establish a Personal Area Network connection:

1. Ensure the EDA is discoverable and connectable. See *Bluetooth Settings on page 3-25*.
2. Discover and bond (pair) with the remote device. See *Bonding with Discovered Device(s) on page 3-8*.
3. In *BTE Explorer*, select the *Remote Devices* folder.
4. Select the *Trusted Devices* folder.
5. Tap the remote device folder.
6. Tap and hold *Personal Area Network* and select *Connect* in the pop-up menu.

Bluetooth Settings

Use the *BTE Explorer Settings* window to configure the operation of the *BTE Explorer* application. Tap *Tools - Settings*. The *BTE Explorer Settings* window appears.

Device Info Tab

Use the *Device Info* tab to configure the EDA's Bluetooth connection modes.

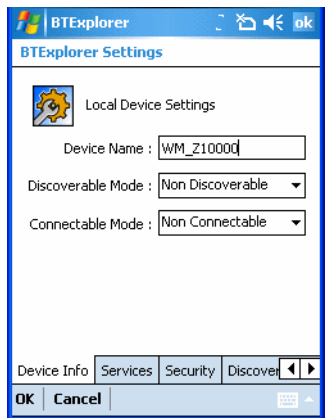

Figure 3-33 *BTE Explorer Settings - Device Info Tab*

Device Name	Displays the name of the EDA.
Discoverable Mode	Select whether or not the EDA is discoverable by other Bluetooth devices.
Connectable Mode	Select whether or not the EDA is connectable by other Bluetooth devices.

Services Tab

Use the *Services* tab to add or delete Bluetooth services.

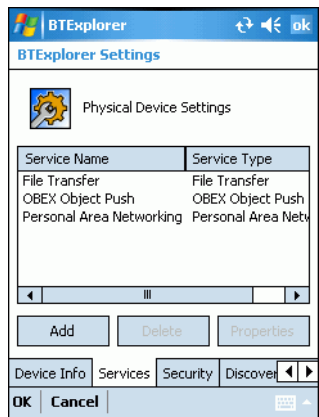

Figure 3-34 *BTE Explorer Settings - Services Tab*

To add a service:

1. Tap **Add**. The *Add Local Service* window displays.

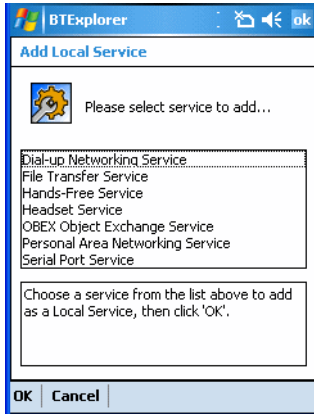

Figure 3-35 *Add Local Service Window*

2. In the list, select a service to add.
3. Tap **OK**. The *Edit Local Service* window displays for the selected service.
4. Select the appropriate information and then tap **OK**. See the following sections for information on the available services.

Dial-Up Networking Service

Dial-up Networking allows other Bluetooth devices to access a dial-up modem.

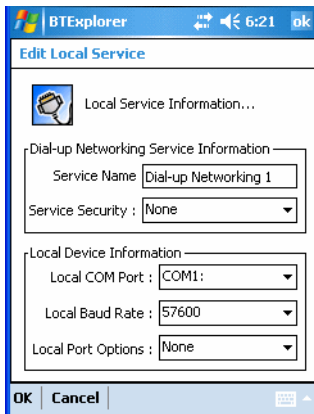

Figure 3-36 *Add Local Service Window*

Service Name	Displays the name of the service.
Service Security	Select the type of security from the drop-down list. Options are <i>None</i> , <i>Authenticate</i> , or <i>Authenticate/Encrypt</i> .
Local COM Port	Select the COM port.
Local Baud Rate	Select the communication baud rate.
Local Port Options	Select the port option.

File Transfer Service

File transfer allows other Bluetooth devices to browse files.

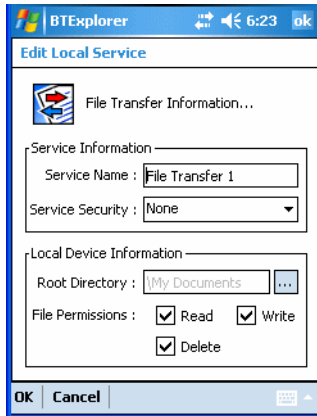

Figure 3-37 File Transfer Information Window

Service Name	Displays the name of the service.
Service Security	Select the type of security from the drop-down list. Options are <i>None</i> , <i>Authenticate</i> , or <i>Authenticate/Encrypt</i> .
Root Directory	Select the directory that other Bluetooth devices can access.
File Permissions	Select the file permissions for the selected directory. Check the appropriate box to grant read access, write access, and delete access.

Hands-Free Service

Hands-Free Service allows connection to hands-free devices.

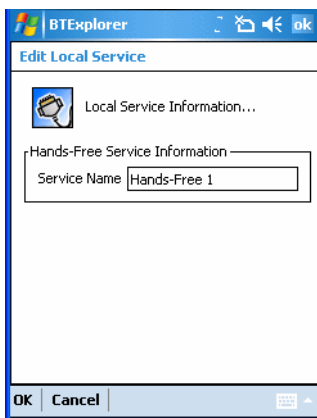

Figure 3-38 Hands-Free Service Window

Service Name	Lists the name of the audio service.
--------------	--------------------------------------

Headset Service

Headset Service allows connection to headset devices.



Figure 3-39 Headset Service Window

Service Name Lists the name of the audio service.

OBEX Object Push Service

OBEX Object Push allows other Bluetooth devices to push contacts, business cards, pictures, appointments, and tasks to the EDA.



Figure 3-40 OBEX Exchange Information Window

Service Name	Displays the name of the service.
Service Security	Select the type of security from the drop-down list. Options are <i>None</i> , <i>Authenticate</i> , or <i>Authenticate/Encrypt</i> .
Do not allow clients to push objects	Disables clients from pushing objects to the EDA.
Inbox Directory	Select a directory where another Bluetooth device can store files.

Personal Area Networking Service

Personal Area Networking hosts a Personal Area Network which allows communication with other Bluetooth devices.

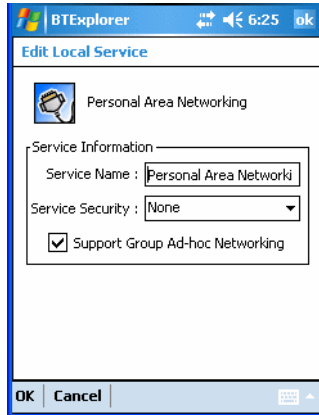

Figure 3-41 Personal Area Networking Window

Service Name	Displays the name of the service.
Service Security	Select the type of security from the drop-down list. Options are <i>None</i> , <i>Authenticate</i> , or <i>Authenticate/Encrypt</i> .
Support Group Ad-Hoc Networking	Select to enable Ad-Hoc networking.

Serial Port Service

Serial port allows other Bluetooth devices to access COM ports.

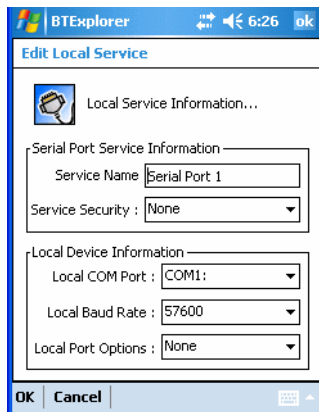

Figure 3-42 Serial Port Service Window

Service Name	Displays the name of the service.
Service Security	Select the type of security from the drop-down list. Options are <i>None</i> , <i>Authenticate</i> , or <i>Authenticate/Encrypt</i> .
Local COM Port	Select the COM port.
Local Baud Rate	Select the communication baud rate.
Local Port Options	Select the port option.

Security Tab

To adjust the security settings for an individual service, select the *Services* tab first, then select the individual service, then *Properties*.



Figure 3-43 *BTExplorer Settings - Security Tab*

Use PIN Code (Incoming Connection)

Select for automatic use of the PIN code entered in the *PIN Code* text box. It is recommended not to use this automatic PIN code feature. See *Security* on page 3-2 for more information.

PIN Code

Enter the PIN code.

Encrypt Link On All Outgoing Connections

Select to enable or disable encryption. Use encryption whenever possible.

Discovery Tab

Use the *Discovery* tab to set and modify discovered devices.

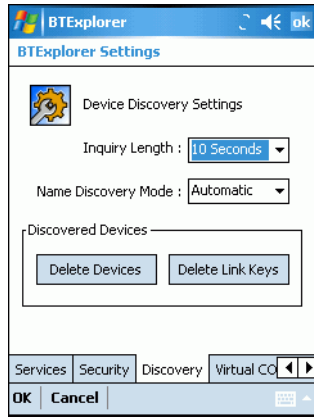

Figure 3-44 *BTExplorer Settings - Discovery Tab*

Inquiry Length	Sets the amount of time the EDA takes to discover Bluetooth devices in the area.
Name Discovery Mode	Select either <i>Automatic</i> or <i>Manual</i> .
Discovered Devices	Deletes all discovered devices and link keys.

Virtual COM Port Tab

Use the *Virtual COM Port* tab to select the COM ports for Bluetooth communication.

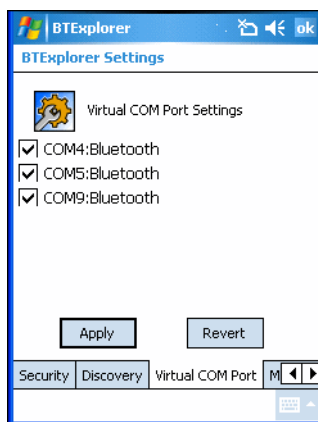

Figure 3-45 *BTExplorer Settings - Virtual COM Port Tab*

COM4:Bluetooth	Enable or disable COM Port 4.
COM5:Bluetooth	Enable or disable COM Port 5
COM9:Bluetooth	Enable or disable COM Port 9

Miscellaneous Tab

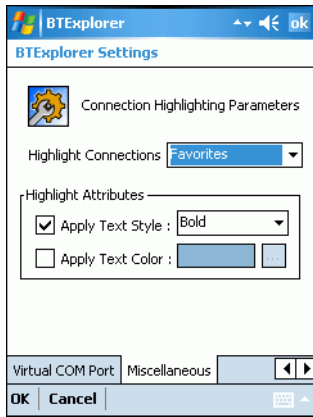

Figure 3-46 BTE Explorer Settings - Miscellaneous Tab

Highlight Connections

Select the connection type to highlight when connected. In the Wizard Mode, the only options are *Favorites* or *None*. In the Explorer Mode the options are *None*, *Tree View Only*, *List View Only*, or *Tree and List View*.

Apply Text Style

Select the text style to apply to the connection text.

Apply Text Color

Select the text color to apply to the connection text.

Introduction

Use the MC7004 and MC7094 phone to make phone calls, set up speed dials, keep track of calls, and send text messages. Your wireless service provider may also provide other services such as voice mail, call forwarding, and caller ID.

Also use the integrated phone to connect to an ISP or work network in order to browse the Web and read e-mail. Connect to the Internet or work network over GPRS using Cellular Line, or using the modem specified by the mobile operator. For more information, or to customize the EDA phone by changing phone settings, see the *MC70 Integrator Guide*.

Accessing the Phone Keypad

Access the keypad regardless of the program in use. Applications on the EDA can be in use during a call.



Figure 4-1 Phone Keypads

- ✓ **NOTE** Keypads vary depending on services and the state of the phone. For example, place calls on hold and use **Swap** to switch active calls on hold. (See [Three-way or Conference Calling on page 4-14.](#))

To access the phone keypad tap *Start - Phone* or press the green phone key on the EDA's keypad.

To receive calls when the EDA is suspended, leave the phone radio turned on and ensure the EDA is set to wake with any key.

Making a Call Using the Keypad

Dial phone calls from the phone keypad using speed dial or from call history. The most direct method is using the phone keypad.

To make a call using the phone keypad:

1. Tap *Start - Phone* or press the green phone key on the EDA's keypad.
2. From the Phone keypad, tap the number to call.
3. Tap **Talk**.
4. Tap **End** to stop dialing or end the call.

✓ **NOTE** Alternatively, use the green and red phone keys on the EDA keypad to dial (green) and end (red) calls.

Turning the Phone On and Off (Flight Mode)

You can turn the phone on and off while keeping the EDA turned on. The phone is turned off when it is in flight mode.

To turn the phone on, tap the *Signal icon - Turn off flight mode*.

To turn the phone off, tap the *Signal icon - Turn on flight mode*.

✓ **NOTE** To receive calls when your device is turned off, leave the phone turned on.

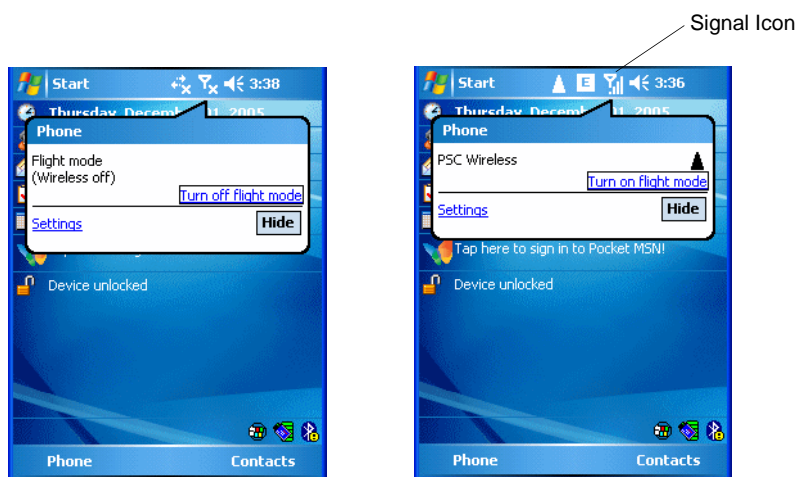

Figure 4-2 Turning Flight Mode On and Off

Answering a Call

A dialog box appears on the EDA when it receives an incoming call. If the phone is set to ring, a ring tone sounds. Answer or ignore the incoming call.

To answer an incoming call tap **Answer** on the *Phone - Incoming...* dialog or press the green phone key on the EDA keypad.

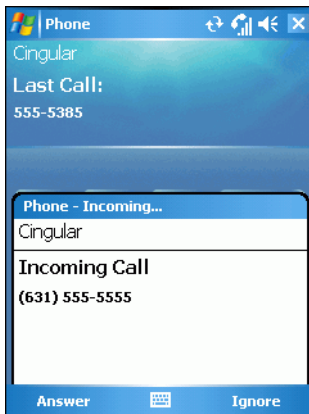

Figure 4-3 *Incoming Call*

To ignore the incoming call tap **Ignore**. This may send the caller to voice mail, depending on the service provider. Otherwise, this presents *Busy* to the calling party.

To end the call tap **End** or press the red phone key on the EDA keypad.

Audio Modes

The EDA offers three audio modes to use during phone calls:

- **Speaker Mode:** Use the EDA as if on speaker phone. Tap the **Speaker On** button to activate this mode.
- **Receiver/Handset Mode:** Switches audio to the speaker at the top front of the EDA, so you can use the EDA as a handset. To select this mode, tap **Speaker Off**.
- **Headset Mode:** Connect a headset to the headset jack to automatically switch audio to the headset.

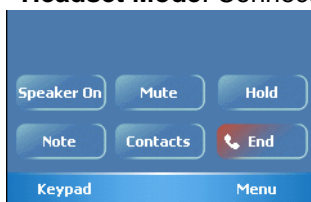

Figure 4-4 *Speaker Button*

Incoming Call Features

- If you receive a call while in a call, tap **Wait** to place the call in call waiting.
- You can use other programs on the EDA during a call. To switch back to Phone, tap **Talk** or tap *Start - Phone*. Tap **End** to end the call.
- If a caller isn't in your contact list, create a contact during the call or from Call History by tapping *Menu - Save to Contacts*.
- To terminate a call when a second call comes in and answer the waiting call, tap **End** on the Phone keypad to disconnect the active call, then tap **Answer** or press the **Send** key to answer the waiting call.
- To hold the current call and answer a waiting call, tap **Answer** or press the **Send** key to place the current call on hold and answer the incoming call.
- To put a call on hold to call another number or answer an incoming call, tap **Hold**. To move from one call to another, tap **Swap**.

Muting a Call

During a call, you can mute the microphone so you can hear the person on the line but he or she cannot hear conversation from the microphone. This is useful when there is conversation or background noise on your end.

To mute or unmute a call:

1. Tap *Start - Phone* or press the green phone key on the EDA's keypad.
2. Tap **Mute** on the display to mute audio. The *Mute* icon appears.

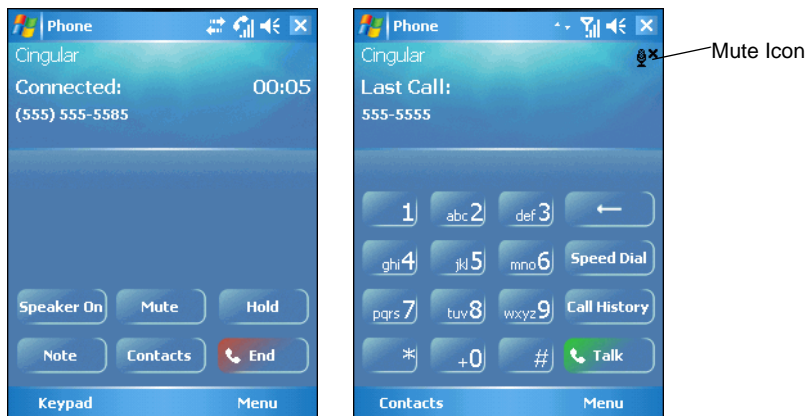

Figure 4-5 Mute Button and Icon

Taking Notes

To create a note during a call, tap **Note** on the display, then enter the note. For more information about creating notes see the Windows On-Device Help.

To access a note created during a call:

1. Tap *Start - Phone* or press the green phone key on the EDA's keypad.
2. From the Phone keypad, tap **Call History**.
3. Tap and hold the number or the *Note* icon for the phone call entry containing the note.

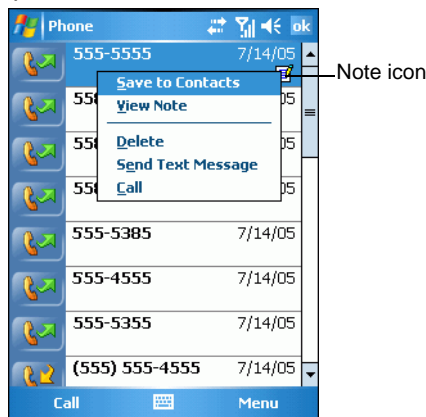

Figure 4-6 Call History - Notes Menu

4. Tap *View Note*.

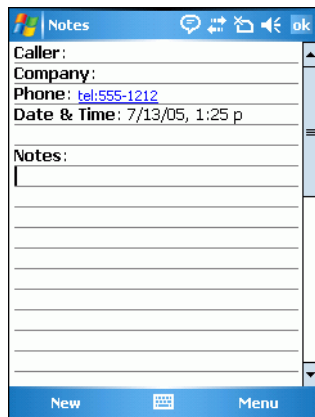

Figure 4-7 Call History - Notes

5. Tap **ok** to exit.

✓ **NOTE** Also access notes directly from the Notes application by tapping *Start - Notes*.

Using Speed Dial

Create speed dial numbers to dial frequently called numbers with a single tap. Before creating a speed dial entry, ensure the phone number exists in Contacts.

Adding a Speed Dial Entry

To add a speed dial entry from the phone keypad:

1. Ensure the contact and phone number are in the Contacts list.
2. Tap *Start - Phone* or press the green phone key on the EDA's keypad.
3. Tap **Speed Dial - Menu - New**.

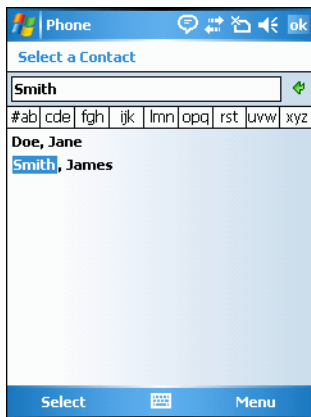

Figure 4-8 *Contacts*

4. Tap the desired contact name and number in the list.

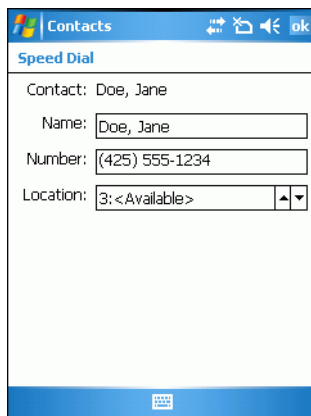

Figure 4-9 *Speed Dial Contact Location*

5. In the *Location* field, tap the Up/Down arrows to select an available location to assign as the new speed dial entry. The first speed dial location is reserved for voice mail.

6. Tap **ok** to add the contact to the speed dial list.

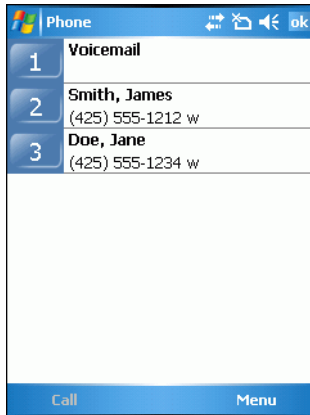

Figure 4-10 Speed Dial Contact List

7. Tap **ok** to exit the *Speed Dial Contact List*.

To add a speed dial entry from the *Contacts* window:

1. Tap *Start - Contacts*.

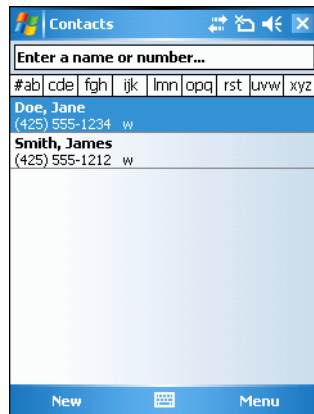

Figure 4-11 Contacts

2. Tap and hold the contact name.

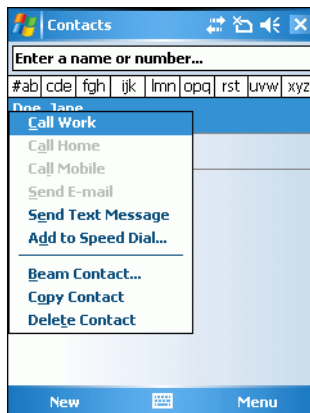

Figure 4-12 Contacts Menu

3. Tap *Add to Speed Dial*.

Phone

Speed Dial

Contact: Doe, Jane

Name: Doe, Jane

Number: (425) 555-1234

Location: 4: <Available>

Delete

Figure 4-13 Speed Dial Contact Location

4. Tap the up/down arrows to select an available location to assign as the new speed dial entry. The first speed dial location is reserved for voice mail.
5. Tap **ok**.

Editing a Speed Dial Entry

1. Tap *Start - Phone* or press the green phone key on the EDA's keypad.
2. Tap **Speed Dial**.

Phone

1	Voicemail
2	Smith, James (425) 555-1212 w
3	Doe, Jane (425) 555-1234 w

Call Menu

Figure 4-14 Speed Dial Contact List

3. Tap and hold the contact name.

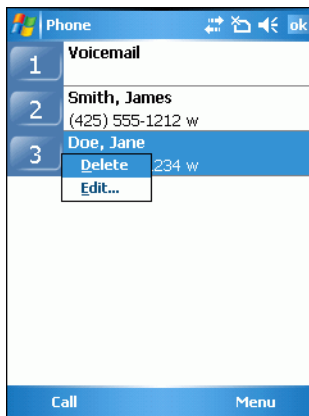

Figure 4-15 Speed Dial Delete Menu

4. Tap *Edit...*
5. Change the name, phone number, or location information.
6. Tap **ok**.

✓ **NOTE** Editing names and phone numbers in *Speed Dial* does not alter contact information in *Contacts (Start - Contacts)*.

Deleting a Speed Dial Entry

1. Tap *Start - Phone* or press the green phone key on the EDA's keypad.
2. Tap **Speed Dial**.
3. Tap and hold the contact name.

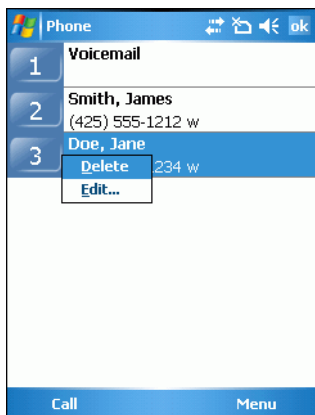

Figure 4-16 Speed Dial Delete Menu

4. Tap *Delete*.

5. Tap **Yes** to confirm permanently deleting the speed dial entry.

✓ **NOTE** Deleting names and phone numbers in *Speed Dial* does not delete the contact information in *Contacts (Start - Contacts)*.

Making a Speed Dial Call

Use Speed Dial to call someone saved in the speed dial directory.

To make a speed dial call:

1. Tap *Start - Phone* or press the green phone key on the EDA's keypad.
2. From the Phone keypad, tap and hold the speed dial location number assigned to a contact. (To dial a one-digit speed dial location number, tap and hold the speed dial number. To dial a two-digit speed dial location number, tap the first digit and then tap and hold the second digit.)

or

From the Phone keypad, tap **Speed Dial** and tap the speed dial location number of the desired contact in the list.

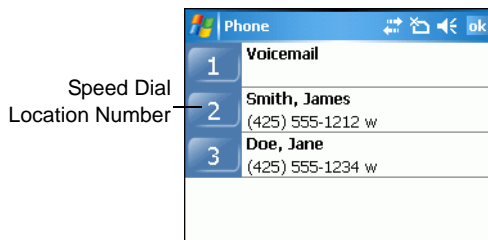





Figure 4-17 *Speed Dial Contact List*

3. To stop dialing or end the call, tap **End** or press the red phone key on the EDA keypad.

Using Call History

Use Call History to call someone who was recently called, or recently called in. Call History provides the time and duration of all incoming, outgoing, and missed calls. It also provides a summary of total calls and easy access to notes taken during a call. [Table 4-1](#) lists the call history icons that appear in the *Call History* window.

Table 4-1 *Call History Icons*

Icon	Description
	This icon appears next to the contact information for all outgoing calls.
	This icon appears next to the contact information for all incoming calls.
	This icon appears next to the contact information for all missed calls.

To make a call using call history:

1. Tap **Start - Phone** or press the green phone key on the EDA's keypad.
2. From the Phone keypad, tap **Call History**.

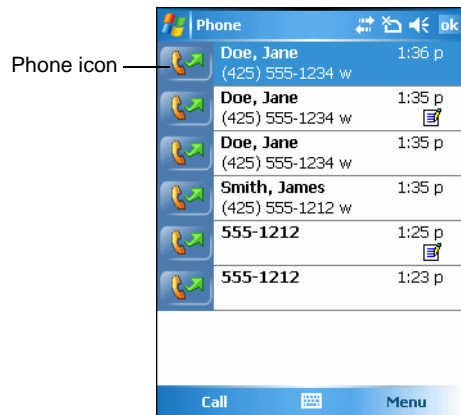

Figure 4-18 *Call History*

3. Tap the phone icon next to the number to begin dialing and return to the phone keypad.
4. Tap **End** or press the red phone key on the EDA keypad to stop dialing or end the call.

Managing Call History

Change views, reset the call timer, and delete calls to manage the calls stored in Call History.

Changing the Call History View

1. Tap *Start - Phone* or press the green phone key on the EDA's keypad to display the Phone keypad.
2. From the Phone keypad, tap **Call History**.
3. Tap *Menu - Filter* to show the menu.

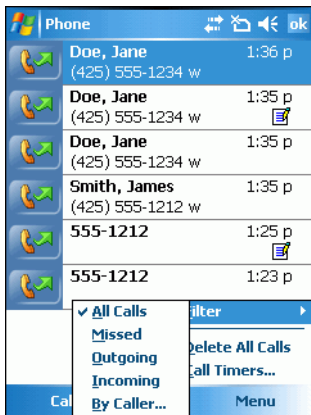

Figure 4-19 Call History - All Calls/Show Menu

4. Select a view type from the menu to display only missed calls, outgoing calls, incoming calls, or calls listed alphabetically by caller name.
5. Tap **ok** to exit the *Call History* window.

Resetting the Recent Calls Counter

1. Tap *Start - Phone* or press the green phone key on the EDA's keypad to display the Phone keypad.
2. From the Phone keypad, tap **Call History**.
3. Tap *Menu*.

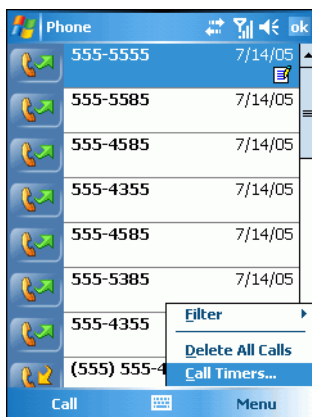
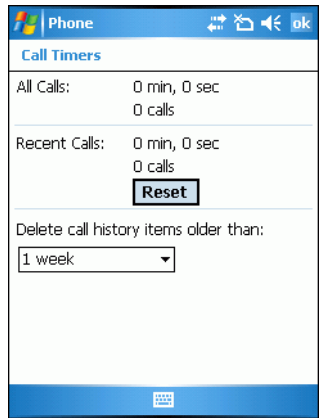

Figure 4-20 Call History - Tools Menu

4. Select *Call Timers...*Figure 4-21 *Call History - Call Timers*

5. Tap **Reset**. (The *All Calls*: counter cannot be reset.)
6. Tap **ok** to exit the *Call Timers* window.

Deleting Call History Items by Call Date

1. Tap *Start - Phone* or press the green phone key on the EDA's keypad to display the Phone keypad.
2. From the Phone keypad, tap **Call History**.
3. Tap *Menu - Call Timers...*

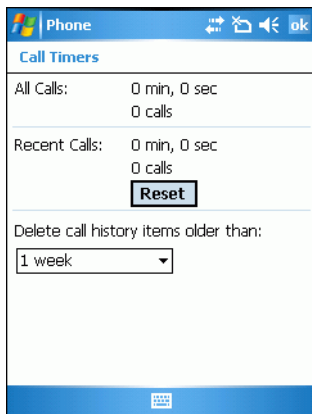
Figure 4-22 *Call History - Call Timers*

4. In the *Delete call history items older than:* drop-down list select a time period on which to base deletion of stored items.
5. Tap **ok** to exit the *Call Timers* window.

Deleting All Call History Items

1. Tap *Start - Phone* or press the green phone key on the EDA's keypad to display the Phone keypad.
2. From the Phone keypad, tap **Call History**.
3. Tap *Menu*.

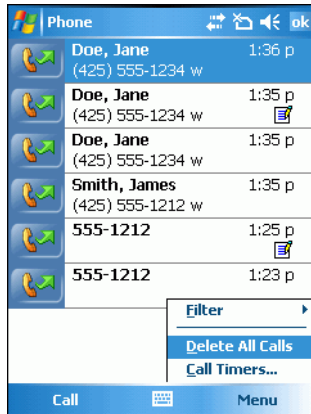

Figure 4-23 Call History - Tools Menu

4. Select *Delete all calls*.

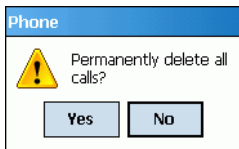

Figure 4-24 Call History - Delete All Dialog

5. Tap **Yes**.
6. Tap **ok** to exit the *Call History* window.

Viewing Call Status

1. Tap *Start - Phone* or press the green phone key on the EDA's keypad to display the Phone keypad.
2. From the Phone keypad, tap **Call History**.

3. Tap an entry in the list to see the date, time, and duration of a call.

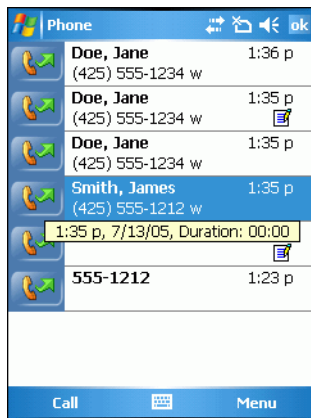

Figure 4-25 Call History - Detail

✓ **NOTE** When more than one call is on the phone line, only the duration of the first call is recorded.

4. Tap **ok** to exit.

Using the Call History Menu

Use the Call History menu to dial voice mail, access the Activation Wizard, save to contacts, view a note, delete a listing, send an SMS, and make a call.

1. Tap *Start - Phone* or press the green phone key on the EDA's keypad to display the Phone keypad.
2. From the Phone keypad, tap **Call History**.
3. Tap and hold an item in the list.

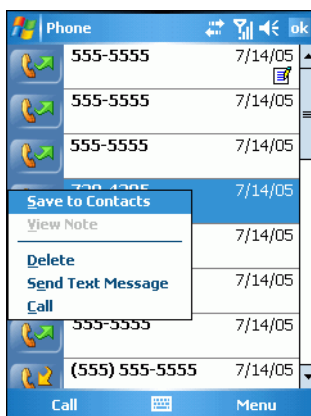

Figure 4-26 Call History - Menu

4. Select an applicable item from the menu, as needed.
5. Depending on the item selected, the appropriate window displays. For example, select *Send SMS* to display the *Inbox* window.
6. Tap **ok** to exit the *Call History* window.

Using Contacts

Use Contacts to make a call without looking up or entering the phone number.

To make a call from Contacts:

1. Tap *Start - Contacts*.
2. From the contact list, tap and hold the contact name.

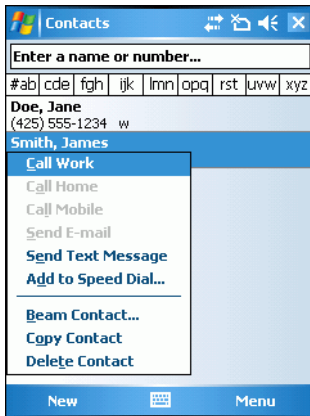

Figure 4-27 *Contacts Menu*

3. Tap *Call Work*.

✓ **NOTE** To make a call from an open contact, tap the number to call. See On-Device Help for more information about Contacts.

Swapping Calls

To move between two or more phone calls:

1. Tap *Start - Phone* or press the green phone key on the EDA's keypad to display the Phone keypad.
2. Enter the first phone number and press **Talk**. When the call connects, **Hold** appears on the keypad.

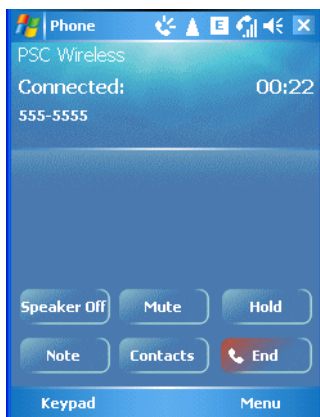

Figure 4-28 *Call Swapping - Hold*

3. Tap **Hold** to place the first number on hold.
4. Enter the second number and tap **Talk**.

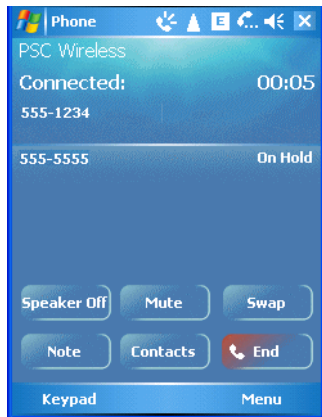

Figure 4-29 Call Conferencing - Conferencing

5. Tap **Swap** to move from one call to the other.
6. Tap **End** or press the red phone key on the EDA keypad to end each call.

Conference Calling

To create a conference phone session with two or more people and the initiator:

1. Tap *Start - Phone* or press the green phone key on the EDA's keypad to display the Phone keypad.
2. Enter the first phone number and press **Talk**. When the call connects, **Hold** appears on the keypad.

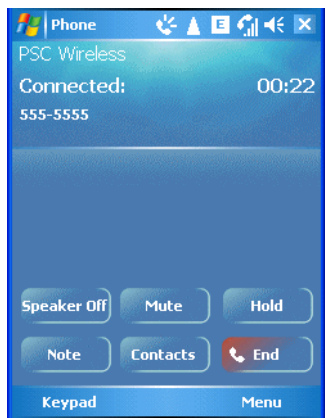

Figure 4-30 Call Swapping - Hold

3. Tap **Hold** to place the first number on hold.
4. Enter the second number and tap **Talk**.
5. Tap **Hold** to place the second number on hold.

6. Tap *Menu - Conference* to place the two numbers in conference mode.

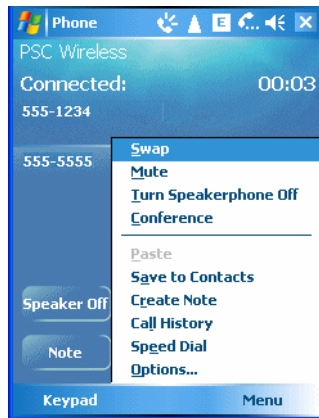

Figure 4-31 *Creating a Conference Call*

7. Tap **End** or press the red phone key on the EDA keypad to end the conference call.

✓ **NOTE** To speak privately with one party during a conference call, tap *Menu - Private*. To include all parties again, tap *Menu - Conference*.

Text Messaging

Use the *Text Messages* window to send and receive text messages to and from mobile phones. The text can contain words, numbers, or an alphanumeric combination no longer than 160 characters.

Short text messages delivered over mobile networks transmit from the sending EDA, are stored in a central short message center, then forwarded to the destination mobile device. If the recipient is not available, the short message is stored and can be sent later. With the PCS networks based on GSM, CDMA, and TDMA technologies supporting SMS, SMS is a universal mobile data service.

Sending a Message

To send a message:

1. Tap *Start - Phone* or press the green phone key on the EDA's keypad to display the Phone keypad.
2. Tap *Contacts*.

3. Tap and hold on a contact and select *Send Text Message*.

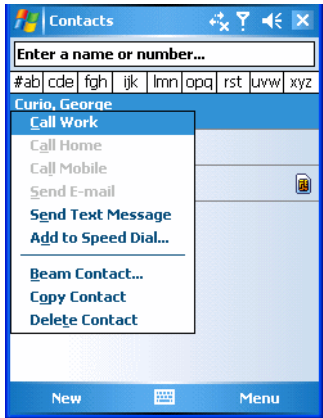

Figure 4-32 Tools Menu

4. On the *Text Messages* window, enter your message.

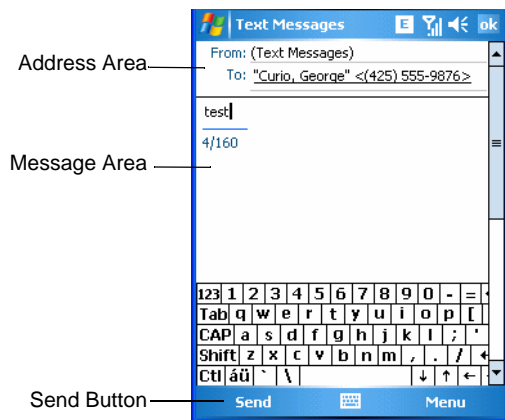

Figure 4-33 Text Messages Window

5. Tap **Send** to send the message.

Introduction

MC70 accessories, listed below, provide a variety of product support capabilities.

Cables

Snap one of the following cables on to the EDA to connect an external device.

- USB Client charge cable
- RS232 charge cable
- DEX cable
- Modem inverter
- Autocharge cable.

Cradles

- Single Slot USB/Serial cradle charges the EDA main battery and a spare battery. It also synchronizes the EDA with a host computer through a USB connection.
- Four Slot Ethernet cradle charges the EDA main battery and connects the EDA with an Ethernet network.
- Vehicle cradle charges the EDA main battery and a spare battery.

Miscellaneous

- Four Slot Spare Battery Charger charges up to four EDA spare batteries.
- Headset can be used in noisy environments.
- Multimedia Card or Secure Digital (SD) Card provides secondary non-volatile storage.
- Belt Mounted Rigid Holster holds the EDA when not in use.

Snap-on Modules

- MSR snaps on to the EDA and adds magstripe read capabilities.
- TRG7000 Trigger Handle adds a gun-style handle with a scanning trigger to the EDA.

Headset

Use the headset to communicate via Voice-Over-IP (VOIP) or for audio playback and telephony applications. To connect the headset, remove the plug from the headset jack at the top of the EDA and insert the headset connector. Contact a Symbol representative for compatible headsets.

For best performance, Symbol recommends a 2.5mm jack headset, p/n 50-11300-050.

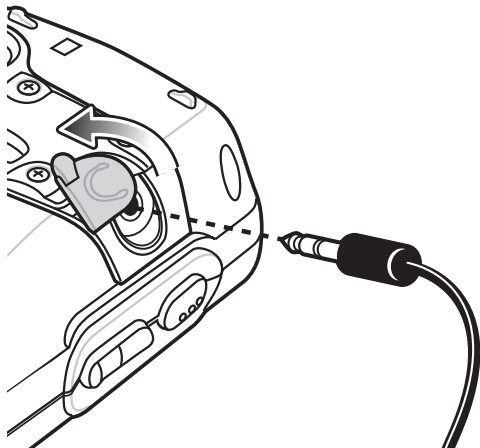

Figure 5-1 Headset Connection

Multi Media Card (MMC) / Secure Digital (SD) Card

The MMC/SD card slot provides secondary non-volatile storage. The slot is located on the side of the EDA (see [Figure 5-2](#)). Refer to the documentation provided with the card for more information, and follow the manufacturer's recommendations for use.

✓ **NOTE** SD cards are interoperable with MMC cards; both can be used in MC70 EDAs.



CAUTION Follow proper ESD precautions to avoid damaging the MMC/SD. Proper ESD precautions include, but are not limited to, working on an ESD mat and ensuring that the operator is properly grounded.

To insert the MMC/SD card:

1. Power off the EDA.
2. Remove the card cover on the side of the EDA by loosening the screws and lifting the cover out of the slot.

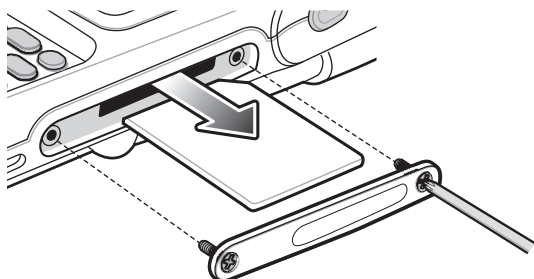

Figure 5-2 Card Cover Removal

3. Insert the card with the card contacts facing down and the cut corner on the right, until you feel a click.
4. Replace the housing cover and secure with the screws.

To remove an MMC/SD card:

1. Power off the EDA.
2. Remove the card cover at the top of the EDA by loosening the screws and lifting the cover out of the slot.
3. Using the stylus, press and release the card to eject it.
4. Remove the card from the card slot.
5. Replace the card cover.

Single Slot USB/Serial Cradle

This section describes how to use a Single Slot USB/Serial cradle with the EDA. For USB communication setup procedures refer to the *MC70 Integrator Guide*.

The Single Slot USB/Serial Cradle:

- Provides 5.4 VDC power for operating the EDA.
- Synchronizes information between the EDA and a host computer. Refer to the *MC70 Integrator Guide* for information on setting up a partnership between the EDA and a host computer.
- Charges the EDA's battery.
- Charges a spare battery.

✓ **NOTE** Use only a Symbol-approved power supply output rated 12 Vdc and minimum 3.33A. The power supply is certified to EN60950 with SELV outputs. Use of an alternative power supply will invalidate any approval given to this device and may be dangerous.

HINWEIS Benutzen Sie nur eine von Symbol Technologies genehmigte Stromversorgung mit einer Ausgangsleistung von 12 V (Gleichstrom) und mindestens 3.33A. Die Stromversorgung ist nach EN60950 für die Verwendung in SELV-Stromkreisen zertifiziert. Bei Verwendung eines anderen Netzteils werden alle für das Gerät gewährten Genehmigungen außer Kraft gesetzt, und der Betrieb kann gefährlich sein.

Charging the EDA Battery

Connect the cradle to power. Insert the EDA into the EDA slot to begin charging.

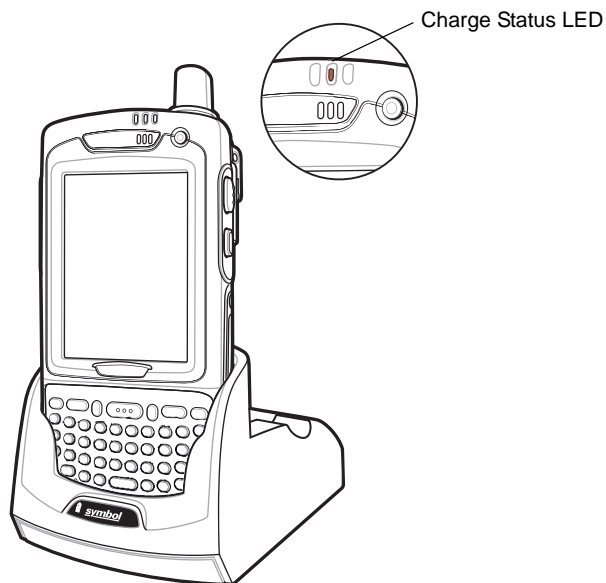

Figure 5-3 EDA Battery Charging

Charging the Spare Battery

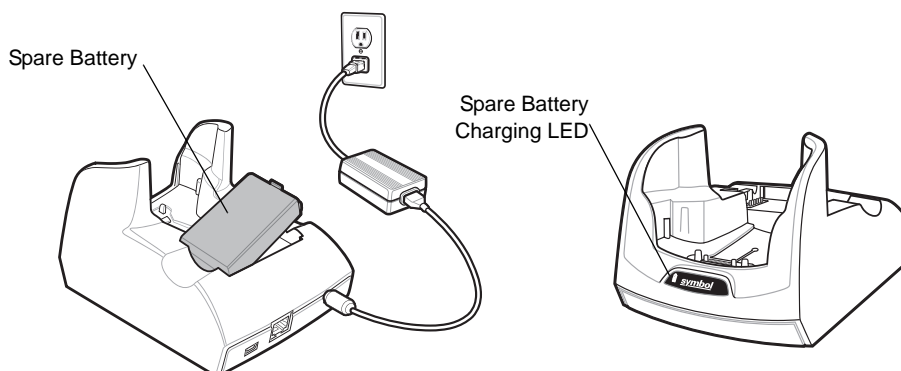

Figure 5-4 Spare Battery Charging

Battery Charging Indicators

The Single Slot USB/Serial Cradle charges the EDA's main battery and a spare battery simultaneously.

The EDA's charge LED indicates the status of the battery charging in the EDA. See [Table 1-2 on page 1-7](#) for charging status indications.

The spare battery charging LED on the cradle indicates the status of the spare battery charging in the cradle. See [Table 5-1](#) for charging status indications.

The standard battery fully charges in approximately four hours and the extended capacity battery fully charges in approximately eight hours.

Charging Temperature

Charge batteries in temperatures from 0°C to 40°C (32°F to 104°F). Note that at temperatures above 35°C, charging is intelligently controlled by the EDA and the charging accessory in order to ensure safe operation and optimize long-term battery life.

To accomplish this, for small periods of time, the EDA or accessory alternately enables and disables battery charging to keep the battery at acceptable temperatures. The EDA or accessory indicates when charging is disabled due to abnormal temperatures via its LED. See [Table 1-2 on page 1-7](#) and [Table 5-1](#).

Table 5-1 Spare Battery LED Charging Indicators

Spare Battery LED (on cradle)	Indication
Off	Battery is not charging; battery is not inserted correctly in the cradle; cradle is not powered
Slow Blinking Amber	Spare battery is charging.
Solid Amber	Charging complete.
Fast Blinking Amber	Charging error.

Four Slot Ethernet Cradle

This section describes how to set up and use a Four Slot Ethernet cradle with the EDA. For cradle communication setup procedures refer to the *MC70 Integrator Guide*.

The Four Slot Ethernet cradle:

- Provides 5.4 VDC power for operating the EDA.
- Connects the EDA (up to four) to an Ethernet network.

- Simultaneously charges up to four EDAs.

✓ **NOTE** Use only a Symbol-approved power supply output rated 12 Vdc and minimum 9A. The power supply is certified to EN60950 with SELV outputs. Use of an alternative power supply will invalidate any approval given to this device and may be dangerous.

HINWEIS Benutzen Sie nur eine von Symbol Technologies genehmigte Stromversorgung mit einer Ausgangsleistung von 12 V (Gleichstrom) und mindestens 9A. Die Stromversorgung ist nach EN60950 für die Verwendung in SELV-Stromkreisen zertifiziert. Bei Verwendung eines anderen Netzteils werden alle für das Gerät gewährten Genehmigungen außer Kraft gesetzt, und der Betrieb kann gefährlich sein.

Charging

Insert the EDA into a slot to begin charging.

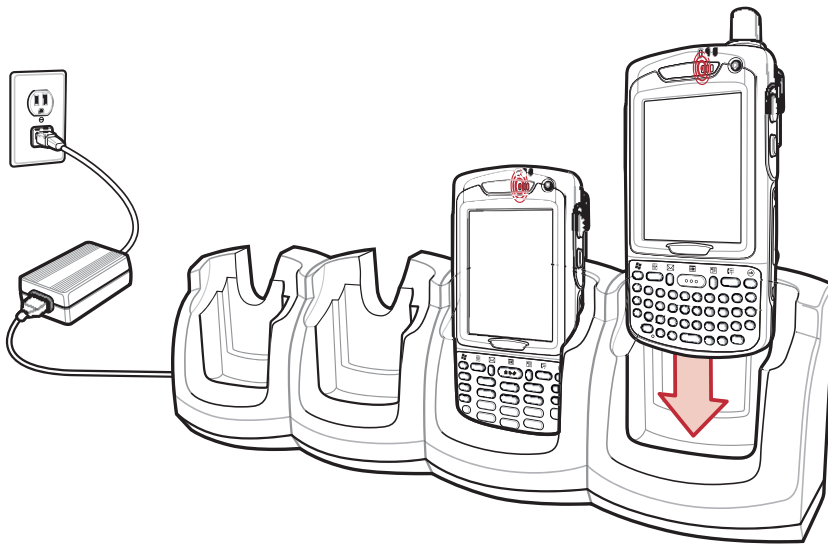

Figure 5-5 EDA Battery Charging

Battery Charging Indicators

The EDA's charge LED shows the status of the battery charging in the EDA. See [Table 1-2 on page 1-7](#) for charging status indications.

The standard battery fully charges in approximately four hours and the extended capacity battery fully charges in approximately eight hours.

Charging Temperature

Charge batteries in temperatures from 0°C to 40°C (32°F to 104°F). Note that at temperatures above 35°C, charging is intelligently controlled by the EDA and the charging accessory in order to ensure safe operation and optimize long-term battery life.

To accomplish this, for small periods of time, the EDA or accessory alternately enables and disables battery charging to keep the battery at acceptable temperatures. The EDA or accessory indicates when charging is disabled due to abnormal temperatures via its LED. See [Table 1-2 on page 1-7](#).

VCD7000 Vehicle Cradle

This section describes how to use a VCD7000 vehicle cradle with the EDA. For cradle installation and communication setup procedures refer to the *MC70 Integrator Guide*.

Once installed in a vehicle, the cradle:

- holds the EDA securely in place
- provides power for operating the EDA
- provides a serial port for data communication between an EDA and an external device (e.g., a printer)
- re-charges the battery in the EDA
- re-charges a standard capacity or extended capacity spare battery.

Charging the EDA Battery

Insert the EDA into the vehicle cradle to begin charging. A click indicates that the EDA button release locking mechanism is enabled and the EDA is locked in place.

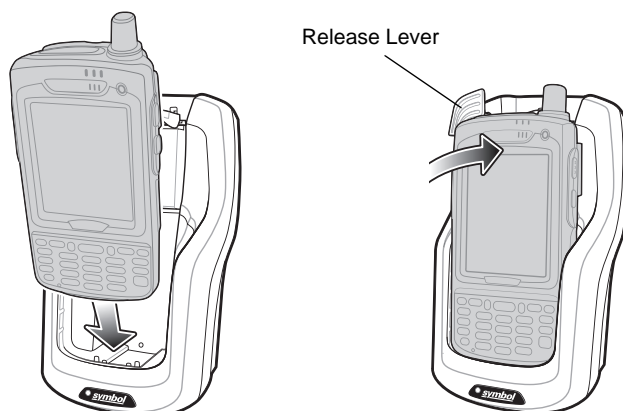

Figure 5-6 EDA Battery Charging



CAUTION Ensure the EDA is fully inserted in the cradle. Lack of proper insertion may result in property damage or personal injury. Symbol Technologies, Inc. is not responsible for any loss resulting from the use of the products while driving.

Removing the EDA

To remove the EDA, hold back the release lever on the cradle and pull the EDA up and out of the cradle.

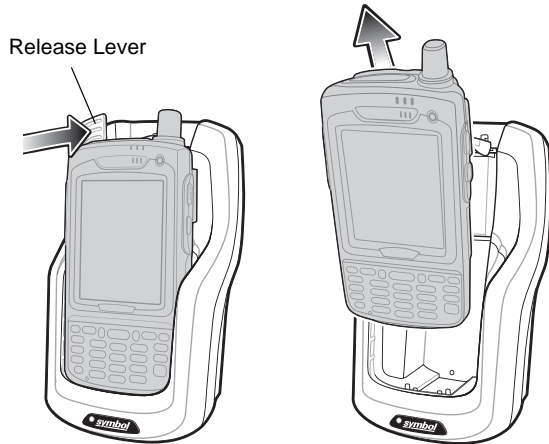

Figure 5-7 *Removing the EDA*

Charging the Spare Battery

Insert a spare battery to begin charging:

1. Lift the battery release lever.

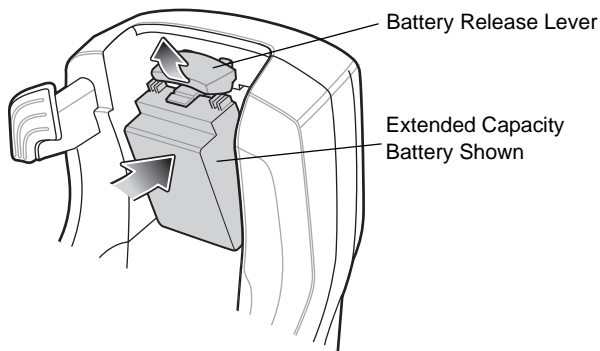

Figure 5-8 *Inserting the Spare Battery*

2. Insert the spare battery in the spare battery charging slot in the cradle with the charging contacts facing up and to the rear of the cradle.
3. Release the battery release lever. The battery release lever locks the spare battery into place.

To remove a spare battery, hold back the battery release lever and lift the battery from the spare battery slot.

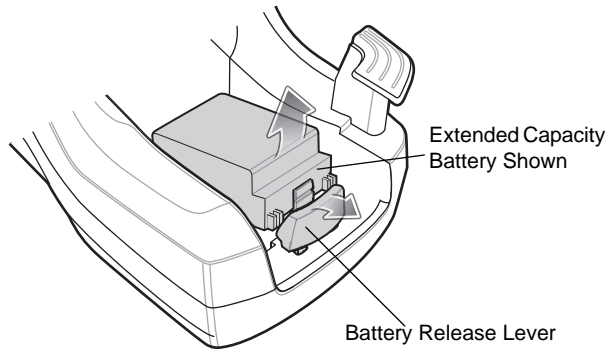

Figure 5-9 Removing the Spare Battery

Battery Charging Indicators

The Vehicle Cradle charges the EDA's main battery and a spare battery simultaneously.

The EDA's charge LED indicates the status of the battery charging in the EDA. See [Table 1-2 on page 1-7](#) for charging status indications.

The spare battery charging LED on the cradle indicates the status of the spare battery charging in the cradle. See [Table 5-2](#) for charging status indications.

The standard battery fully charges in approximately four hours and the extended capacity battery fully charges in approximately eight hours.

Charging Temperature

Charge batteries in temperatures from 0°C to 40°C (32°F to 104°F). Note that at temperatures above 35°C, charging is intelligently controlled by the EDA and the charging accessory in order to ensure safe operation and optimize long-term battery life.

To accomplish this, for small periods of time, the EDA or accessory alternately enables and disables battery charging to keep the battery at acceptable temperatures. The EDA or accessory indicates when charging is disabled due to abnormal temperatures via its LED. See [Table 1-2 on page 1-7](#) and [Table 5-2](#).

Table 5-2 Vehicle Cradle Spare Battery LED Charging Indicators

Spare Battery LED (on cradle)	Indication
Off	Battery is not charging; battery is not inserted correctly in the cradle; cradle is not powered
Slow Blinking Amber	Spare battery is charging.
Solid Amber	Charging complete.
Fast Blinking Amber	Charging error.

Four Slot Spare Battery Charger

This section describes how to use the Four Slot Spare Battery Charger to charge up to four MC70 spare batteries.

- ✓ **NOTE** Use only a Symbol-approved power supply output rated 12 Vdc and minimum 3.33A. The power supply is certified to EN60950 with SELV outputs. Use of an alternative power supply will invalidate any approval given to this device and may be dangerous.

HINWEIS Benutzen Sie nur eine von Symbol Technologies genehmigte Stromversorgung mit einer Ausgangsleistung von 12 V (Gleichstrom) und mindestens 3.33A. Die Stromversorgung ist nach EN60950 für die Verwendung in SELV-Stromkreisen zertifiziert. Bei Verwendung eines anderen Netzteils werden alle für das Gerät gewährten Genehmigungen außer Kraft gesetzt, und der Betrieb kann gefährlich sein.

MC70 Battery Shim Installation

Before charging a spare battery, snap the MC70 shim into the battery slot as shown in [Figure 5-10](#).

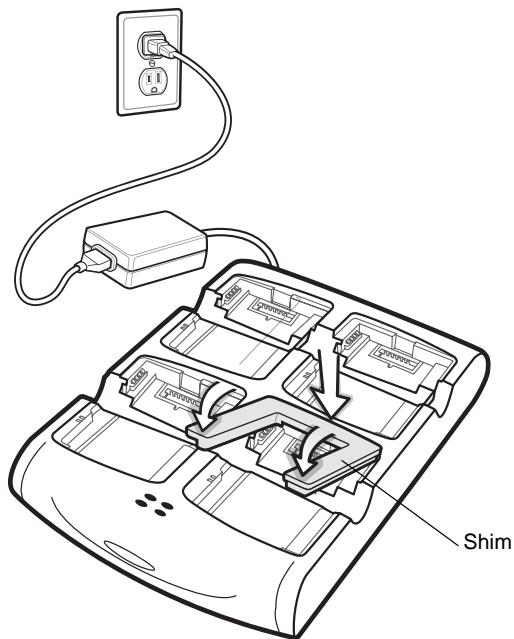

Figure 5-10 MC70 Spare Battery Shim Installation

- ✓ **NOTE** To purchase additional shims, contact your local account manager or Symbol Technologies, Inc. Part number: KT-76490-01.

Spare Battery Charging

1. Connect the charger to a power source.
2. Insert the spare battery into a spare battery charging well and gently press down on the battery to ensure proper contact.

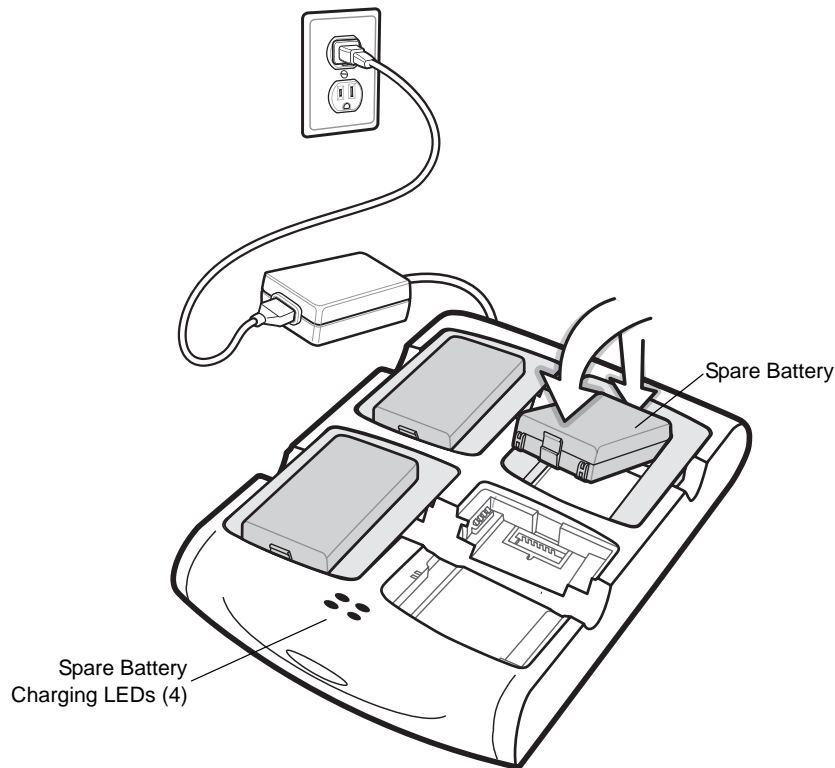

Figure 5-11 Four Slot Spare Battery Charger

Battery Charging Indicators

The charger has an amber LED for each battery charging well. See [Table 5-3](#) for charging status indications. The standard battery fully charges in approximately 2.5 hours and the extended capacity battery fully charges in approximately six hours.

Charging Temperature

Charge batteries in temperatures from 0°C to 40°C (32°F to 104°F). Note that at temperatures above 35°C, charging is intelligently controlled by the charger in order to ensure safe operation and optimize long-term battery life.

To accomplish this, for small periods of time, the charger alternately enables and disables battery charging to keep the battery at acceptable temperatures. The charger indicates when charging is disabled due to abnormal temperatures via its LED. See [Table 5-3](#).

Table 5-3 Spare Battery LED Charging Indicators

LED	Indication
Off	No spare battery in slot; battery is not charging; battery is not inserted correctly in the charger; charger is not powered.
Slow Blinking Amber	Spare battery is charging.
Solid Amber	Charging complete.
Fast Blinking Amber	Charging error.

Magnetic Stripe Reader (MSR)

This section describes how to set up and use the snap-on MSR with the EDA. The MSR snaps on to the bottom of the EDA and removes easily when not in use.

When attached to the EDA, the MSR allows the EDA to capture data from magnetic stripe cards. To download MSR data capture software, visit <http://devzone.symbol.com>.

Attaching and Removing the MSR

To attach, slide the MSR onto the bottom of the EDA and secure by snapping the arms into the EDA housing.

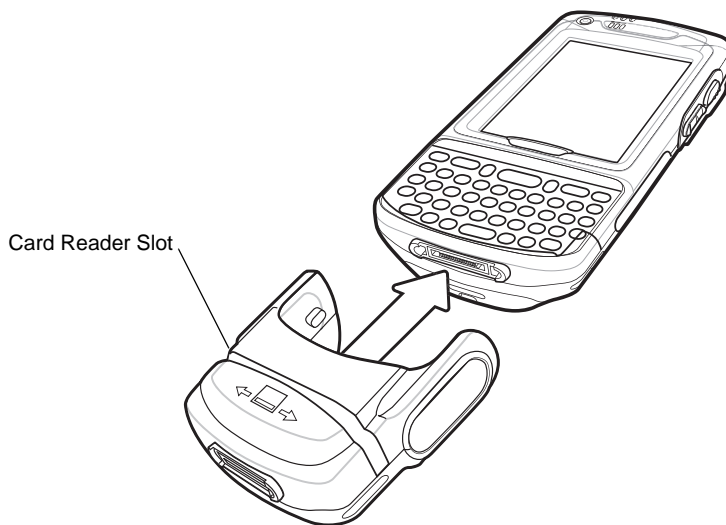
**Figure 5-12** MSR Installation

To remove the MSR open the arms and pull the MSR from the EDA.

- ✓ **NOTE** When attaching a cable with a cup connector through the MSR to charge the device, you cannot swipe cards.

Using the MSR

The *MSR3000* sample application illustrates how an application handles MSR input (refer to *Symbol Applications User's Guide*).

To use the MSR:

1. Attach the MSR to the EDA.
2. Power on the EDA.
3. Install the MC70 Demo application onto the EDA. The demo is available with the SMDK. See the *MC70 Integrator Guide* for more information.
4. Tap *Start - MC70 Demo - Test Apps - MSR MC70* or *MSR Cameo* to start the sample application.
5. Swipe the magnetic stripe card through the MSR, with the magnetic stripe on the card facing down. Swipe the card in either direction, from left to right or from right to left. For best results, gently press down on the card while swiping to ensure contact with the bottom of the reader.

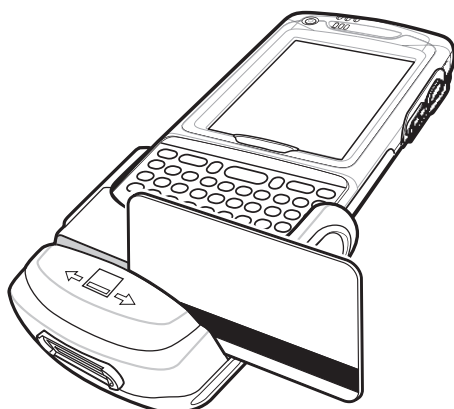

Figure 5-13 Magnetic Stripe Card Swiping

TRG7000 Trigger Handle

The TRG7000 Trigger Handle pistol grip accessory adds a gun-style handle with a scanning trigger to the EDA. It increases comfort when using the EDA in scan-intensive applications for extended periods of time. The TRG7000 is intended for use with MC70 WLAN/PAN configurations.

Install the cleat onto the EDA before using the trigger handle. For cleat installation and communication setup procedures refer to the *MC70 Integrator Guide*.

Inserting the EDA into the Trigger Handle

Slide the EDA into the Trigger Handle until it locks in place. The release secures the EDA to the Trigger Handle.

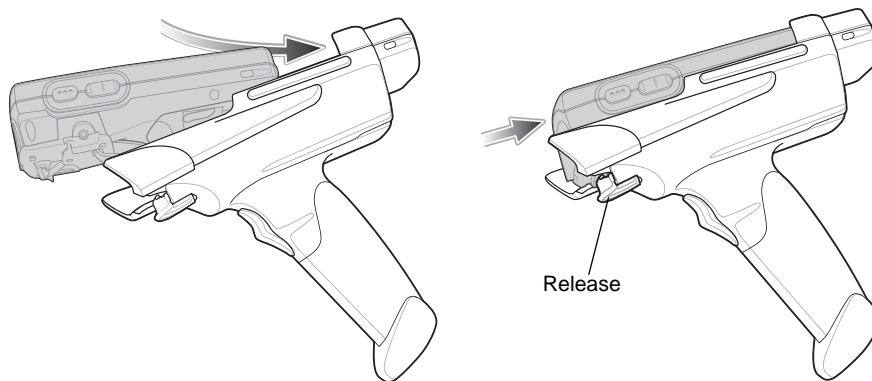

Figure 5-14 Inserting the EDA into the Trigger Handle

Removing the EDA

To remove the EDA, press the release down and pull the EDA forward.



Figure 5-15 Removing the EDA

Scanning

To scan bar codes:

1. Start the EDA's scanning application.
2. Aim the EDA at the bar code.

3. Pull the trigger on the handle. The Scan/Decode LED lights and a beep sounds to indicate a successful decode.

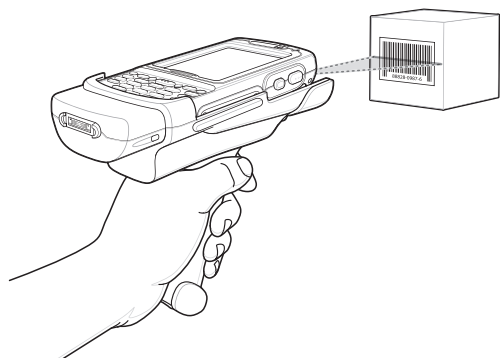

Figure 5-16 Scanning with the Trigger Handle

Using a Cradle



CAUTION Do not place a Trigger Handle with an attachment, such as a Magnetic Stripe Reader (MSR) into a cradle. Remove the attachment before inserting the Trigger Handle into the cradle.

To charge the EDA's battery while the EDA is in the Trigger Handle, insert the EDA into either the Single-Slot USB/Serial cradle or the Four-Slot Ethernet cradle.

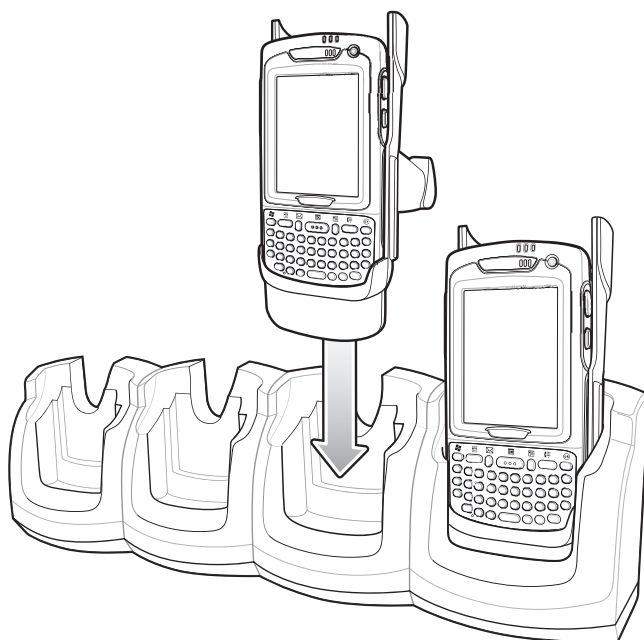

Figure 5-17 Inserting the EDA Into the Cradle for Charging

Cables

This section describes how to set up and use the cables. The cables are available with a variety of connection capabilities.

The following communication/charge cables are available:

- Serial (RS232) Charge cable (9-pin D female with power input receptacle)
- USB Client Charge cable (standard-A connector and a barrel receptacle for power)
- Auto charge cable
- DEX cable
- Modem inverter cable.

The following printer cables are available directly from the printer manufacturer:

- O'Neil Printer cable
- Zebra Printer cable.

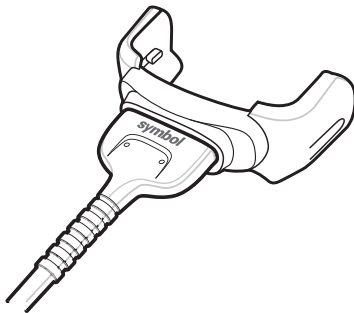

Figure 5-18 Cables

Communication/charge cables:

- Provide the EDA with operating and charging power when used with the Symbol approved power supply.
- Synchronize information between the EDA and a host computer. With customized or third party software, it can also synchronize the EDA with corporate databases.
- Provide serial connection through the serial pass-through port for communication with a serial device, such as a host computer. For communication setup procedures, refer to the *MC70 Integrator Guide*.
- Provide USB connection through the USB pass-through port for communication with a USB device, such as a host computer. For communication setup procedures, refer to the *MC70 Integrator Guide*.

Dedicated printer cables provide communication with a printer.

Battery Charging and Operating Power

The communication/charge cables can charge the EDA battery and supply operating power.

To charge the EDA battery:

1. Connect the communication/charge cable power input connector to the Symbol approved power source.
2. Slide the bottom of the EDA into the connector end of the communication/charge cable and gently press in until it latches into the EDA. The EDA amber Charge LED indicates the EDA battery charging status. The standard battery charges in less than four hours and the extended capacity battery charges in less than six hours. See [Table 1-2 on page 1-7](#) for charging status indications.
3. When charging is complete, remove the cable by gently pulling the EDA and the cable apart.

LED Charge Indications

The amber Charge LED on the EDA indicates battery charging status. See [Table 1-2 on page 1-7](#) for charging status indications.

Charging Temperature

Charge batteries in temperatures from 0°C to 40°C (32°F to 104°F). Note that at temperatures above 35°C, charging is intelligently controlled by the EDA and the charging accessory in order to ensure safe operation and optimize long-term battery life.

To accomplish this, for small periods of time, the EDA or accessory alternately enables and disables battery charging to keep the battery at acceptable temperatures. The EDA or accessory indicates when charging is disabled due to abnormal temperatures via its LED. See [Table 1-2 on page 1-7](#).

Introduction

This chapter includes instructions on cleaning and storing the EDA, and provides troubleshooting solutions for potential problems during EDA operation.

Maintaining the EDA

For trouble-free service, observe the following tips when using the EDA:

- Do not scratch the screen of the EDA. When working with the EDA, use the supplied stylus or plastic-tipped pens intended for use with a touch-sensitive screen. Never use an actual pen or pencil or other sharp object on the surface of the EDA screen.

Symbol recommends using a screen protector, p/n KT-67525-01.

- The touch-sensitive screen of the EDA is glass. Do not drop the EDA or subject it to strong impact.
- Protect the EDA from temperature extremes. Do not leave it on the dashboard of a car on a hot day, and keep it away from heat sources.
- Do not store or use the EDA in any location that is dusty, damp, or wet.
- Use a soft lens cloth to clean the EDA. If the surface of the EDA screen becomes soiled, clean it with a soft cloth moistened with a diluted window-cleaning solution.
- Periodically replace the rechargeable battery to ensure maximum battery life and product performance. Battery life depends on individual usage patterns.
- A screen protector is applied to the EDA. Symbol recommends using this to minimize wear and tear. Screen protectors enhance the usability and durability of touch screen displays. Benefits include:
 - Protection from scratches and gouges
 - Durable writing and touch surface with tactile feel
 - Abrasion and chemical resistance
 - Glare reduction
 - Keeping the device's screen looking new
 - Quick and easy installation.

Troubleshooting

EDA

Table 6-1 *Troubleshooting the EDA*

Problem	Cause	Solution
EDA does not turn on.	Lithium-ion battery not charged.	Charge or replace the lithium-ion battery in the EDA.
	Lithium-ion battery not installed properly.	Install the battery properly. See <i>Installing and Removing the Main Battery</i> on page 1-4.
	System crash.	Perform a warm boot. If the EDA still does not turn on, perform a cold boot. See <i>Resetting the EDA</i> on page 2-24.
Rechargeable lithium-ion battery did not charge.	Battery failed.	Replace battery. If the EDA still does not operate, perform a warm boot, then a cold boot. See <i>Resetting the EDA</i> on page 2-24.
	EDA removed from cradle while battery was charging.	Insert EDA in cradle. The standard capacity battery (1900 mAh) fully charges in less than four hours. The extended capacity battery (3800 mAh) fully charges in less than eight hours.
Cannot see characters on display.	EDA not powered on.	Press the Power button.
During data communication, no data transmitted, or transmitted data was incomplete.	EDA removed from cradle or disconnected from host computer during communication.	Replace the EDA in the cradle, or reattach the communication cable and re-transmit.
	Incorrect cable configuration.	See the system administrator.
	Communication software was incorrectly installed or configured.	Perform setup. Refer to the <i>MC70 Integrator Guide</i> for details.
No sound.	Volume setting is low or turned off.	Adjust the volume. See <i>Speaker Icon</i> on page 2-3.
EDA shuts off.	EDA is inactive.	The EDA turns off after a period of inactivity. If the EDA is running on battery power, set this period from 1 to 5 minutes, in one-minute intervals. If the EDA is running on external power, set this period to 1, 2, 5, 10, 15, or 30 minutes. Check the <i>Power</i> window by selecting <i>Start - Settings - System tab</i> and tapping the <i>Power</i> icon. Select the <i>Advanced</i> tab and change the setting for a longer delay before the automatic shutoff feature activates.
	Battery is depleted.	Replace the battery.
	Battery is not inserted properly.	Insert the battery properly. See <i>Installing and Removing the Main Battery</i> on page 1-4.

Table 6-1 Troubleshooting the EDA (Continued)

Problem	Cause	Solution
Tapping the window buttons or icons does not activate the corresponding feature.	Screen is not calibrated correctly.	Re-calibrate the screen. See <i>Calibrating the Screen</i> on page 1-8.
	The system is not responding.	Warm boot the system. See <i>Resetting the EDA</i> on page 2-24.
A message appears stating that the EDA memory is full.	Too many files stored on the EDA.	Delete unused memos and records. If necessary, save these records on the host computer (or use an SD card for additional memory).
	Too many applications installed on the EDA.	Remove user-installed applications on the EDA to recover memory. Select <i>Start - Settings - System tab</i> and tap the <i>Remove Programs</i> icon. Select the unused program and tap Remove .
EDA keeps powering down to protect memory contents.	The EDA's battery is low.	Recharge the battery.
	The radio is powered on for a long time.	Because this mode requires battery power, power it off when not needed. Using the SetDeviceState() API (refer to the <i>SMDK Help File</i>), set the Bluetooth to D4 power state.
The EDA does not accept scan input.	Scanning application is not loaded.	Load a scanning application on the EDA. See the system administrator.
	Unreadable bar code.	Ensure the symbol is not defaced.
	Distance between exit window and bar code is incorrect.	Place the EDA within proper scanning range.
	EDA is not programmed for the bar code.	Program the EDA to accept the type of bar code being scanned.
	EDA is not programmed to generate a beep.	If the EDA does not beep on a good decode, set the application to generate a beep on good decode.
	Battery is low.	If the scanner stops emitting a laser beam upon a trigger press, check the battery level. When the battery is low, the scanner shuts off before the EDA low battery condition notification. Note: If the scanner is still not reading symbols, contact the distributor or Symbol Technologies.

Bluetooth Connection

Table 6-2 *Troubleshooting Bluetooth Connection*

Problem	Cause	Solution
EDA cannot find any Bluetooth devices nearby.	Too far from other Bluetooth devices.	Move closer to the other Bluetooth device(s), within a range of 10 meters.
	The Bluetooth device(s) nearby are not turned on.	Turn on the Bluetooth device(s) to find.
	The Bluetooth device(s) are not in discoverable mode.	Set the Bluetooth device(s) to discoverable mode. If needed, refer to the device's user documentation for help.
When trying to connect a Bluetooth phone and EDA, the phone thinks a previously paired EDA is used.	The phone remembers the name and address of the EDA it last paired with via the Bluetooth radio.	Manually delete the pairing device and name from the phone. Refer to the phone's user documentation for instructions.
Can't make my Ericsson R520 phone discoverable.	You attempted to bond with the phone, and when the phone presented a "pairing query," you entered No. This prevents the phone from being discoverable until it is reset.	Reset the phone by removing its battery.
There is a delay in the Bluetooth stack re-initializing during a resume from suspend.	This is normal behavior.	No solution required.

Table 6-2 Troubleshooting Bluetooth Connection (Continued)

Problem	Cause	Solution
Piconet (the connection between a Bluetooth master and one or more Bluetooth slaves) drops.	<p>The EDA suspends and the Bluetooth radio power turns off.</p> <p>One of the devices are out of range.</p>	An application can register for notification of an EDA resume by creating a message queue using the CreateMsgQueue() API and power notifications using the RequestPowerNotifications() API (refer to the <i>SMDK Help File</i>). After an application receives a resume notification it should close open Bluetooth sessions and reopen them. This reestablishes the piconet lost during the suspend.
My application created a successful RFCOMM session with another Bluetooth device but the session was dropped.	Device went out of range or was shut off.	Check the return value of APIs for errors. Look for a DCD state change event in the Microsoft Bluetooth stack DCD window of the Bluetooth connection.
After completing an RFCOMM session with another Bluetooth device, I was unable to create a virtual COM port to connect to another Bluetooth device.	The Microsoft Bluetooth stack holds a baseband connection for ten seconds after an application closes its session and exits. This was designed to allow for speedy connections to the same device if other profiles were to connect.	Either wait 10 seconds, choose a different COM port number for the virtual COM port, or modify HKLM\software\Microsoft\bluetooth\l2cap\IdlePhys (which defines the number of seconds to hold the connection).

Single Slot USB/Serial Cradle

Table 6-3 Troubleshooting the Single Slot USB/Serial Cradle

Symptom	Possible Cause	Action
LEDs do not light when EDA or spare battery is inserted.	Cradle is not receiving power.	Ensure the power cable is connected securely to both the cradle and to AC power.
	EDA is not seated firmly in the cradle.	Remove and re-insert the EDA into the cradle, ensuring it is firmly seated.
	Spare battery is not seated firmly in the cradle.	Remove and re-insert the spare battery into the charging slot, ensuring it is firmly seated.
EDA battery is not charging.	EDA was removed from cradle or cradle was unplugged from AC power too soon.	Ensure cradle is receiving power. Ensure EDA is seated correctly. Confirm main battery is charging under <i>Start - Settings - System - Power</i> . The standard capacity battery (1900 mAh) fully charges in less than four hours. The extended capacity battery (3800 mAh) fully charges in less than eight hours.
	Battery is faulty.	Verify that other batteries charge properly. If so, replace the faulty battery.
	The EDA is not fully seated in the cradle.	Remove and re-insert the EDA into the cradle, ensuring it is firmly seated.
	Ambient temperature of the cradle is too warm.	Move the cradle to an area where the ambient temperature is between 0°C and 35°C.
Spare battery is not charging.	Battery not fully seated in charging slot.	Remove and re-insert the spare battery in the cradle, ensuring it is firmly seated.
	Battery inserted incorrectly.	Re-insert the battery so the charging contacts on the battery align with the contacts on the cradle.
	Battery is faulty.	Verify that other batteries charge properly. If so, replace the faulty battery.
	Ambient temperature of the cradle is too warm.	Move the cradle to an area where the ambient temperature is between 0°C and 35°C.
During data communication, no data transmits, or transmitted data was incomplete.	EDA removed from cradle during communications.	Replace EDA in cradle and retransmit.
	Incorrect cable configuration.	See the system administrator.
	Communication software is not installed or configured properly.	Perform setup as described in the <i>MC70 Integrator Guide</i> .

Four Slot Ethernet Cradle

Table 6-4 Troubleshooting the Four Slot Ethernet Cradle

Symptom	Cause	Solution
Attempt by the EDA to ActiveSync failed.	EDA removed from the cradle while the LED was blinking green.	Wait one minute and reinsert the EDA in the cradle. This allows the cradle to attempt another synchronization.
	Using an outdated version of ActiveSync.	Visit http://www.microsoft.com for the latest ActiveSync software.
	ActiveSync on the host computer has not yet closed the previous ActiveSync session.	Wait one minute and reinsert the EDA in the cradle. This allows the cradle to attempt another synchronization.
	Incorrect cable configuration.	Ensure the correct cable (Ethernet) is used with the cradle.
	Communication software improperly configured.	Perform setup as described in the <i>MC70 Integrator Guide</i> .
	EDA ActiveSync disabled or not configured to accept network connection.	On the EDA, tap <i>Start - ActiveSync - Tools - Options - Options</i> button. Then, uncheck the <i>Enable PC sync using this connection:</i> check box.
	Host ActiveSync disabled or not configured to accept network connection.	On the host computer, check <i>File - Connection Settings - Allow network (Ethernet) Server Connection with this desktop computer</i> .
During communication, no data transmits, or transmitted data was incomplete.	EDA removed from cradle during communications.	Replace EDA in cradle and retransmit.
	EDA has no active connection.	An icon is visible in the status bar if a connection is currently active.
Battery is not charging.	EDA removed from the cradle too soon.	Replace the EDA in the cradle. The standard capacity battery (1900 mAh) fully charges in less than four hours. The extended capacity battery (3800 mAh) fully charges in less than eight hours. Tap <i>Start - Settings - System - Power</i> to view battery status.
	Battery is faulty.	Verify that other batteries charge properly. If so, replace the faulty battery.
	EDA is not inserted correctly in the cradle.	Remove the EDA and reinsert it correctly. Verify charging is active. Tap <i>Start - Settings - System - Power</i> to view battery status.
	Ambient temperature of the cradle is too warm.	Move the cradle to an area where the ambient temperature is between 0°C and 35°C.

Vehicle Cradle

Table 6-5 *Troubleshooting the Vehicle Cradle*

Symptom	Possible Cause	Action
EDA battery charging LED does not light up.	Cradle is not receiving power.	Ensure the power input cable is securely connected to the cradle's power port.
EDA battery is not recharging.	EDA was removed from the cradle too soon.	Replace the EDA in the cradle. The standard capacity battery (1900 mAh) fully charges in less than four hours. The extended capacity battery (3800 mAh) fully charges in less than eight hours.
	Battery is faulty.	Replace the battery.
	EDA is not placed correctly in the cradle.	Remove the EDA from the cradle, and re-insert correctly. If the battery still does not charge, contact customer support. The EDA battery charging LED slowly blinks amber when the EDA is correctly inserted and charging.
	Ambient temperature of the cradle is too warm.	Move to an area where the ambient temperature is between 0°C and 35°C.
No data transmitted, or transmitted data was incomplete.	EDA removed from cradle during communication.	Replace EDA in cradle and retransmit.
	No null modem cable was used.	Some external devices require a null modem cable. Retransmit using a null modem cable.
	Incorrect cable configuration.	See the system administrator.
	Cable missing or disconnected.	Re-connect cable.

Four Slot Spare Battery Charger

Table 6-6 *Troubleshooting The Four Slot Spare Battery Charger*

Symptom	Possible Cause	Action
Battery not charging.	Battery was removed from the charger or charger was unplugged from AC power too soon.	Re-insert the battery in the charger or re-connect the charger's power supply. The standard capacity battery (1900 mAh) fully charges in less than four hours. The extended capacity battery (3800 mAh) fully charges in less than eight hours.
	Battery is faulty.	Verify that other batteries charge properly. If so, replace the faulty battery.
	Battery contacts not connected to charger.	Verify that the battery is seated in the battery well correctly with the contacts facing down.
	Ambient temperature of the cradle is too warm.	Move the cradle to an area where the ambient temperature is between 0°C and 35°C.

Cables

Table 6-7 Troubleshooting the Cables

Symptom	Possible Cause	Action
EDA battery is not charging.	EDA was disconnected from AC power too soon.	Connect the power cable correctly. Confirm main battery is charging under <i>Start - Settings - System - Power</i> . The standard capacity battery (1900 mAh) fully charges in less than four hours. The extended capacity battery (3800 mAh) fully charges in less than eight hours.
	Battery is faulty.	Verify that other batteries charge properly. If so, replace the faulty battery.
	The EDA is not fully attached to power.	Detach and re-attach the power cable to the EDA, ensuring it is firmly connected.
During data communication, no data transmits, or transmitted data was incomplete.	Cable was disconnected from EDA during communications.	Re-attach the cable and retransmit.
	Incorrect cable configuration.	See the system administrator.
	Communication software is not installed or configured properly.	Perform setup as described in the <i>MC70 Integrator Guide</i> .

Magnetic Stripe Reader

Table 6-8 Troubleshooting the Magnetic Stripe Reader

Symptom	Possible Cause	Action
MSR cannot read card.	MSR removed from EDA during card swipe.	Reattach MSR to EDA and reswipe the card.
	Faulty magnetic stripe on card.	See the system administrator.
	MSR application is not installed or configured properly.	Ensure the MSR application is installed on the EDA. Ensure the MSR application is configured correctly.
EDA battery is not charging.	EDA was removed from MSR or MSR was unplugged from AC power too soon.	Ensure MSR is receiving power. Ensure EDA is attached correctly. Confirm main battery is charging under <i>Start - Settings - System - Power</i> . The standard capacity battery (1900 mAh) fully charges in less than four hours. The extended capacity battery (3800 mAh) fully charges in less than eight hours.
	Battery is faulty.	Verify that other batteries charge properly. If so, replace the faulty battery.
	The EDA is not fully attached to the MSR.	Detach and re-attach the MSR to the EDA, ensuring it is firmly connected.

Table 6-8 *Troubleshooting the Magnetic Stripe Reader (Continued)*

Symptom	Possible Cause	Action
During data communication, no data transmits, or transmitted data was incomplete.	EDA detached from MSR during communications.	Reattach EDA to MSR and retransmit.
	Incorrect cable configuration.	See the system administrator.
	Communication software is not installed or configured properly.	Perform setup as described in the <i>MC70 Integrator Guide</i> .

Trigger Handle

Table 6-9 *Troubleshooting the Trigger Handle*

Problem	Cause	Solution
Cannot insert EDA in Trigger Handle.	Cleat is not installed on the EDA.	Install the cleat. Refer to the <i>MC70 Integrator Guide</i> .
Scan line does not appear when trigger is pressed.	EDA is not attached properly to the Trigger Handle and is not making contact with the connector.	Remove the EDA from the Trigger Handle and reinsert.
	EDA does not contain a scanning application.	Load a scanning application on the EDA.
	Scanning application is not active.	Start the scanning application.
EDA battery does not charge when Trigger Handle is placed in a cradle.	Trigger Handle is not properly seated in the cradle.	Remove the Trigger Handle from the cradle and reinsert.
	Power is not available to the cradle.	Ensure that power connections to the cradle are connected properly.
Cannot print to printer.	Printer cable not connected properly.	Ensure cable is connected properly to the printer and Trigger Handle.
EDA does not wake from suspend mode when trigger is pressed.	The trigger only wakes the EDA from the suspend mode if a scanning application is active.	Press a key on the EDA to wake from the suspend mode.

MC70 Technical Specifications

The following tables summarize the EDA's intended operating environment and technical hardware specifications.

Table A-1 EDA Technical Specifications

Item	Description
Physical Characteristics	
Dimensions	6 in. L x 3 in. W x 1.5 in H 15.3 cm L x 7.6 cm W x 3.7 cm H
Weight (inc. standard battery)	LAN/PAN configurations: 11.2 oz./314 g WAN/LAN/PAN configurations: 12 oz./336 g
Display	Transflective color 3.5" QVGA with backlight, TFT-LCD, 65K colors, 240 W x 320 L (QVGA size)
Touch Panel	Glass analog resistive touch
Backlight	LED backlight
Main Battery	Rechargeable Lithium Ion 3.7V, 1900 mAh Smart Battery
Extended Cap. Battery	Optional 3.7V, 3800 mAh Smart Battery
Backup Battery	NiMH battery (rechargeable) 20mAh 1.2V (not user-accessible)
Expansion Slot	User accessible SDIO slot (with secure cover), accommodates extended cards (with cover removed)
Network Connections	Ethernet (via cradle) High-speed USB, host or client, Bluetooth
Notification	Vibrator and audible alert
Keypad Options	26 Numeric key 44 QWERTY key
Audio	Speaker, receiver, microphone, headset jack, software support for full duplex record and playback (stereo)
Performance Characteristics	
CPU	Intel® XScale™ Bulverde PXA270 processor at 624MHz

Table A-1 EDA Technical Specifications (Continued)

Item	Description
Operating System	Microsoft® Windows Mobile™ 2005
Memory	64MB RAM/128MB ROM
Interface/Communications	RS-232, USB 1.1
User Environment	
Operating Temperature	14°F to 155°F / -10°C to 68°C
Storage Temperature	-40° F to 140° F / -40° C to 60° C
Charging Temperature	32°F to 104°F / 0° C to 40° C
Humidity	95% non-condensing
Drop Specification	4 ft. drop to concrete, 6 drops per 6 sides over operating temperature range; 5 ft. drop to concrete, 2 drops per 6 sides at ambient temperature 73° F/23° C
Electrostatic Discharge (ESD)	+/-15kVdc air discharge, +/-8kVdc direct discharge, +/-8kVdc indirect discharge
Sealing	IP54
Wireless WAN Data and Voice Communications	
Wireless Wide Area (WWAN) radio	eGPRS/GSM (850, 900, 1800 and 1900 MHz)
Wireless LAN Data and Voice Communications	
Wireless Local Area (WLAN) radio	Tri-mode IEEE® 802.11a/b/g
Data Rates Supported	1, 2, 5.5, 6, 9, 11, 12, 18, 24, 36, 48, and 54 Mbps
Operating Channels	Chan 8-169 (5040 – 5845 MHz) (4920 – 4980 MHz) Japan only Chan 1-13 (2412-2472 MHz) Chan 14 (2484 MHz) Japan only Actual operating frequencies depend on regulatory rules and certification agency
Security	WPA, WEP (40 or 128 bit), TKIP, TLS, TTLS (MS-CHAP), TTLS (MS-CHAP v2), TTLS (CHAP), TTLS-MD5, TTLS-PAP, PEAP-TLS, PEAP (MS-CHAP v2), AES, LEAP
Spreading Technique	Direct Sequence Spread Spectrum (DSSS) and Orthogonal Frequency Division Multiplexing (OFDM)
Antenna	Internal for LAN, External for WAN
Voice Communication	Integrated Voice-over-IP ready (P2P, PBX, PTT), Wi-Fi™-certified, IEEE 802.11a/b/g direct sequence wireless LAN
Wireless PAN Data and Voice Communications	
Bluetooth	Class II, v 1.2
Data Capture Specifications	
Options	2D imager, 1D linear

Table A-1 EDA Technical Specifications (Continued)

Item	Description
Linear 1D Scanner (SE800HP) Specifications	
Optical Resolution	0.005 in. minimum element width
Roll	+/- 30° from vertical
Pitch Angle	+/- 65° from normal
Skew Tolerance	+/- 60° from normal
Ambient Light	Sunlight: 8,000 ft. candles (86,112 Lux) Artificial Light: 450 ft. candles (4,844 Lux)
Shock	2,000 +/- 5% G
Scan Rate	50 (+/- 6) scans/sec (bidirectional)
Scan Angle	46.5° (typical)
Laser Power	1.0 mW nominal
2D Imager Engine (SE4400) Specifications	
Field of View	Horizontal - 32.2° Vertical - 24.5°
Optical Resolution	640 H x 480 V pixels (gray scale)
Roll	360°
Pitch Angle	+/- 60° from normal
Skew Tolerance	+/- 50° from normal
Ambient Light	Total darkness to 9,000 ft. candles (96,900 Lux)
Shock	2,000 +/- 5% G
Focal Distance from Front of Engine	Near: 5 inches Far: 9 inches
Aiming Element (VLD)	650 nm +/- 5 nm
Illumination Element (LED)	635 nm +/- 20 nm

MC70 Accessory Specifications

Table A-2 *Single Slot USB/Serial Cradle Technical Specifications*

Feature	Description
Dimensions	4.3 in. L x 2.3 in. W x 3.2 in. H (10.92 cm L x 5.84 cm W x 8.13 cm H)
Weight	6.9 oz (196 g)
Power	12 V
Interface	USB, Serial
Operating Temperature	32° to 122° F (0° to 50° C)
Storage Temperature	-40° to 158° F (-40° to 70° C)
Charging Temperature	32° to 104° F (0° to 40° C)
Humidity	5% to 95% non-condensing
Drop	30.0 in. (76.2 cm) drops to vinyl tiled concrete at room temperature
Electrostatic Discharge (ESD)	+/- 15 kV air +/- 8 kV contact

Table A-3 *Four Slot Ethernet Cradle Technical Specifications*

Feature	Description
Dimensions	5.40 in. H x 18.25 in. W x 4.38 in. D (13.72 cm H x 46.36 cm W x 11.13 cm D)
Weight	2.38 lb (1079 g)
Power	12 V
Interface	Ethernet
Operating Temperature	32° to 122° F (0° to 50° C)
Storage Temperature	-40° to 158° F (-40° to 70° C)
Charging Temperature	32° to 104° F (0° to 40° C)
Humidity	5% to 95% non-condensing
Drop	30.0 in. (76.2 cm) drops to vinyl tiled concrete at room temperature
Electrostatic Discharge (ESD)	+/- 15 kV air +/- 8 kV contact

Table A-4 Four Slot Spare Battery Charger Technical Specifications

Feature	Description
Dimensions	8.25 in. L x 6.0 in. W x 1.7 in. H (20.96 cm L x 15.24 cm W x 4.32 cm H)
Weight	13.6 oz (386 g)
Power	12 V
Operating Temperature	32° to 104° F (0° to 40° C)
Storage Temperature	-40° to 158° F (-40° to 70° C)
Charging Temperature	32° to 104° F (0° to 40° C)
Humidity	5% to 95% non-condensing
Drop	30.0 in. (76.2 cm) drops to vinyl tiled concrete at room temperature
Electrostatic Discharge (ESD)	+/- 15 kV air +/- 8 kV contact

Table A-5 Magstripe Reader (MSR) Technical Specifications

Feature	Description
Dimensions	3.1 in. L x 3.3 in. W x 1.4 in. H (7.87 cm L x 8.38 cm W x 3.56 cm H)
Weight	1.7 oz (48 g)
Interface	Serial with baud rate up to 19,200
Format	ANSI, ISO, AAMVA, CA DMV, user-configurable generic format
Swipe Speed	5 to 50 in. (127 to 1270 mm) /sec, bi-directional
Decoders	Generic, Raw Data
Mode	Buffered, unbuffered
Track Reading Capabilities	Tracks 1 and 3: 210 bpi Track 2: 75 and 210 bpi, autodetect
Operating Temperature	32° to 122° F (0° to 50° C)
Storage Temperature	-40° to 158° F (-40° to 70° C)
Humidity	5% to 95% non-condensing
Drop	4 ft. (1.22 m) drops to concrete
Electrostatic Discharge (ESD)	+/- 15 kV air +/- 8 kV contact

A

API. An interface by means of which one software component communicates with or controls another. Usually used to refer to services provided by one software component to another, usually via software interrupts or function calls

Aperture. The opening in an optical system defined by a lens or baffle that establishes the field of view.

Application Programming Interface. See **API**.

ANSI Terminal. A display terminal that follows commands in the ANSI standard terminal language. For example, it uses escape sequences to control the cursor, clear the screen and set colors. Communications programs support the ANSI terminal mode and often default to this terminal emulation for dial-up connections to online services.

ASCII. American Standard Code for Information Interchange. A 7 bit-plus-parity code representing 128 letters, numerals, punctuation marks and control characters. It is a standard data transmission code in the U.S.

Autodiscrimination. The ability of an interface controller to determine the code type of a scanned bar code. After this determination is made, the information content is decoded.

B

Bar. The dark element in a printed bar code symbol.

Bar Code. A pattern of variable-width bars and spaces which represents numeric or alphanumeric data in machine-readable form. The general format of a bar code symbol consists of a leading margin, start character, data or message character, check character (if any), stop character, and trailing margin. Within this framework, each recognizable symbology uses its own unique format. See **Symbology**.

Bar Code Density. The number of characters represented per unit of measurement (e.g., characters per inch).

Bar Height. The dimension of a bar measured perpendicular to the bar width.

Bar Width. Thickness of a bar measured from the edge closest to the symbol start character to the trailing edge of the same bar.

BIOS. Basic Input Output System. A collection of ROM-based code with a standard API used to interface with standard PC hardware.

Bit. Binary digit. One bit is the basic unit of binary information. Generally, eight consecutive bits compose one byte of data. The pattern of 0 and 1 values within the byte determines its meaning.

Bits per Second (bps). Bits transmitted or received.

BOOTP. A protocol for remote booting of diskless devices. Assigns an IP address to a machine and may specify a boot file. The client sends a bootp request as a broadcast to the bootp server port (67) and the bootp server responds using the bootp client port (68). The bootp server must have a table of all devices, associated MAC addresses and IP addresses.

boot or boot-up. The process a computer goes through when it starts. During boot-up, the computer can run self-diagnostic tests and configure hardware and software.

bps. See **Bits Per Second**.

Byte. On an addressable boundary, eight adjacent binary digits (0 and 1) combined in a pattern to represent a specific character or numeric value. Bits are numbered from the right, 0 through 7, with bit 0 the low-order bit. One byte in memory is used to store one ASCII character.

C

CDRH. Center for Devices and Radiological Health. A federal agency responsible for regulating laser product safety. This agency specifies various laser operation classes based on power output during operation.

CDRH Class 1. This is the lowest power CDRH laser classification. This class is considered intrinsically safe, even if all laser output were directed into the eye's pupil. There are no special operating procedures for this class.

CDRH Class 2. No additional software mechanisms are needed to conform to this limit. Laser operation in this class poses no danger for unintentional direct human exposure.

Character. A pattern of bars and spaces which either directly represents data or indicates a control function, such as a number, letter, punctuation mark, or communications control contained in a message.

Character Set. Those characters available for encoding in a particular bar code symbology.

Check Digit. A digit used to verify a correct symbol decode. The scanner inserts the decoded data into an arithmetic formula and checks that the resulting number matches the encoded check digit. Check digits are required for UPC but are optional for other symbologies. Using check digits decreases the chance of substitution errors when a symbol is decoded.

Codabar. A discrete self-checking code with a character set consisting of digits 0 to 9 and six additional characters: (- \$: / , +).

Code 128. A high density symbology which allows the controller to encode all 128 ASCII characters without adding extra symbol elements.

Code 3 of 9 (Code 39). A versatile and widely used alphanumeric bar code symbology with a set of 43 character types, including all uppercase letters, numerals from 0 to 9 and 7 special characters (- . / + % \$ and space). The code name is derived from the fact that 3 of 9 elements representing a character are wide, while the remaining 6 are narrow.

Code 93. An industrial symbology compatible with Code 39 but offering a full character ASCII set and a higher coding density than Code 39.

Code Length. Number of data characters in a bar code between the start and stop characters, not including those characters.

Cold Boot. A cold boot restarts the mobile computer and erases all user stored records and entries.

COM port. Communication port; ports are identified by number, e.g., COM1, COM2.

Continuous Code. A bar code or symbol in which all spaces within the symbol are parts of characters. There are no intercharacter gaps in a continuous code. The absence of gaps allows for greater information density.

Cradle. A cradle is used for charging the terminal battery and for communicating with a host computer, and provides a storage place for the terminal when not in use.

D

Data Communications Equipment (DCE). A device (such as a modem) which is designed to attach directly to a DTE (Data Terminal Equipment) device.

DCE. See **Data Communications Equipment**.

DCP. See **Device Configuration Package**.

Dead Zone. An area within a scanner's field of view, in which specular reflection may prevent a successful decode.

Decode. To recognize a bar code symbology (e.g., UPC/EAN) and then analyze the content of the specific bar code scanned.

Decode Algorithm. A decoding scheme that converts pulse widths into data representation of the letters or numbers encoded within a bar code symbol.

Decryption. Decryption is the decoding and unscrambling of received encrypted data. Also see, **Encryption** and **Key**.

Depth of Field. The range between minimum and maximum distances at which a scanner can read a symbol with a certain minimum element width.

Device Configuration Package. The Symbol Device Configuration Package provides the Product Reference Guide (PRG), flash partitions, Terminal Configuration Manager (TCM) and the associated TCM scripts. With this package hex images that represent flash partitions can be created and downloaded to the mobile computer.

Discrete Code. A bar code or symbol in which the spaces between characters (intercharacter gaps) are not part of the code.

Discrete 2 of 5. A binary bar code symbology representing each character by a group of five bars, two of which are wide. The location of wide bars in the group determines which character is encoded; spaces are insignificant. Only numeric characters (0 to 9) and START/STOP characters may be encoded.

DRAM. Dynamic random access memory.

DTE. See **Data Terminal Equipment**.

E

EAN. European Article Number. This European/International version of the UPC provides its own coding format and symbology standards. Element dimensions are specified metrically. EAN is used primarily in retail.

Element. Generic term for a bar or space.

Encoded Area. Total linear dimension occupied by all characters of a code pattern, including start/stop characters and data.

ENQ (RS-232). ENQ software handshaking is also supported for the data sent to the host.

ESD. Electro-Static Discharge

F

File Transfer Protocol (FTP). A TCP/IP application protocol governing file transfer via network or telephone lines. See **TCP/IP**.

Flash Disk. An additional megabyte of non-volatile memory for storing application and configuration files.

Flash Memory. Flash memory is nonvolatile, semi-permanent storage that can be electronically erased in the circuit and reprogrammed. Series 9000 mobile computers use Flash memory to store the operating system (ROM-DOS), the terminal emulators, and the Citrix ICA Client for DOS.

FTP. See **File Transfer Protocol**.

H

Hard Reset. See **Cold Boot**.

Hz. Hertz; A unit of frequency equal to one cycle per second.

Host Computer. A computer that serves other terminals in a network, providing such services as computation, database access, supervisory programs and network control.

I

IDE. Intelligent drive electronics. Refers to the solid-state hard drive type.

- IEC.** International Electrotechnical Commission. This international agency regulates laser safety by specifying various laser operation classes based on power output during operation.
- IEC (825) Class 1.** This is the lowest power IEC laser classification. Conformity is ensured through a software restriction of 120 seconds of laser operation within any 1000 second window and an automatic laser shutdown if the scanner's oscillating mirror fails.
- IEEE Address.** See **MAC Address**.
- Input/Output Ports.** I/O ports are primarily dedicated to passing information into or out of the terminal's memory. Series 9000 mobile computers include Serial and USB ports.
- Interleaved 2 of 5.** A binary bar code symbology representing character pairs in groups of five bars and five interleaved spaces. Interleaving provides for greater information density. The location of wide elements (bar/spaces) within each group determines which characters are encoded. This continuous code type uses no intercharacter spaces. Only numeric (0 to 9) and START/STOP characters may be encoded.
- Intercharacter Gap.** The space between two adjacent bar code characters in a discrete code.
- Interleaved Bar Code.** A bar code in which characters are paired together, using bars to represent the first character and the intervening spaces to represent the second.
- Internet Protocol Address.** See **IP**.
- IOCTL.** Input/Output Control.
- I/O Ports.** interface The connection between two devices, defined by common physical characteristics, signal characteristics, and signal meanings. Types of interfaces include RS-232 and PCMCIA.
- IP.** Internet Protocol. The IP part of the TCP/IP communications protocol. IP implements the network layer (layer 3) of the protocol, which contains a network address and is used to route a message to a different network or subnetwork. IP accepts "packets" from the layer 4 transport protocol (TCP or UDP), adds its own header to it and delivers a "datagram" to the layer 2 data link protocol. It may also break the packet into fragments to support the maximum transmission unit (MTU) of the network.
- IP Address.** (Internet Protocol address) The address of a computer attached to an IP network. Every client and server station must have a unique IP address. A 32-bit address used by a computer on a IP network. Client workstations have either a permanent address or one that is dynamically assigned to them each session. IP addresses are written as four sets of numbers separated by periods; for example, 204.171.64.2.
- IPX/SPX.** Internet Package Exchange/Sequential Packet Exchange. A communications protocol for Novell. IPX is Novell's Layer 3 protocol, similar to XNS and IP, and used in NetWare networks. SPX is Novell's version of the Xerox SPP protocol.
- IS-95.** Interim Standard 95. The EIA/TIA standard that governs the operation of CDMA cellular service. Versions include IS-95A and IS-95B. See CDMA.

K

Key. A key is the specific code used by the algorithm to encrypt or decrypt the data. Also see, **Encryption** and **Decrypting**.

L

LASER. Light Amplification by Stimulated Emission of Radiation. The laser is an intense light source. Light from a laser is all the same frequency, unlike the output of an incandescent bulb. Laser light is typically coherent and has a high energy density.

Laser Diode. A gallium-arsenide semiconductor type of laser connected to a power source to generate a laser beam. This laser type is a compact source of coherent light.

laser scanner. A type of bar code reader that uses a beam of laser light.

LCD. See **Liquid Crystal Display**.

LED Indicator. A semiconductor diode (LED - Light Emitting Diode) used as an indicator, often in digital displays. The semiconductor uses applied voltage to produce light of a certain frequency determined by the semiconductor's particular chemical composition.

Light Emitting Diode. See **LED**.

Liquid Crystal Display (LCD). A display that uses liquid crystal sealed between two glass plates. The crystals are excited by precise electrical charges, causing them to reflect light outside according to their bias. They use little electricity and react relatively quickly. They require external light to reflect their information to the user.

M

MC. Mobile Computer.

MDN. Mobile Directory Number. The directory listing telephone number that is dialed (generally using POTS) to reach a mobile unit. The MDN is usually associated with a MIN in a cellular telephone -- in the US and Canada, the MDN and MIN are the same value for voice cellular users. International roaming considerations often result in the MDN being different from the MIN.

MIL. 1 mil = 1 thousandth of an inch.

MIN. Mobile Identification Number. The unique account number associated with a cellular device. It is broadcast by the cellular device when accessing the cellular system.

Misread (Misdecode). A condition which occurs when the data output of a reader or interface controller does not agree with the data encoded within a bar code symbol.

Mobile Computer. In this text, *mobile computer* refers to the Symbol Series 9000 wireless portable computer. It can be set up to run as a stand-alone device, or it can be set up to communicate with a network, using wireless radio technology.

N

Nominal. The exact (or ideal) intended value for a specified parameter. Tolerances are specified as positive and negative deviations from this value.

Nominal Size. Standard size for a bar code symbol. Most UPC/EAN codes are used over a range of magnifications (e.g., from 0.80 to 2.00 of nominal).

NVM. Non-Volatile Memory.

O

ODI. See **Open Data-Link Interface**.

Open Data-Link Interface (ODI). Novell's driver specification for an interface between network hardware and higher-level protocols. It supports multiple protocols on a single NIC (Network Interface Controller). It is capable of understanding and translating any network information or request sent by any other ODI-compatible protocol into something a NetWare client can understand and process.

Open System Authentication. Open System authentication is a null authentication algorithm.

P

PAN . Personal area network. Using Bluetooth wireless technology, PANs enable devices to communicate wirelessly. Generally, a wireless PAN consists of a dynamic group of less than 255 devices that communicate within about a 33-foot range. Only devices within this limited area typically participate in the network.

Parameter. A variable that can have different values assigned to it.

PC Card. A plug-in expansion card for laptop computers and other devices, also called a PCMCIA card. PC Cards are 85.6mm long x 54 mm wide, and have a 68 pin connector. There are several different kinds:

Type I; 3.3 mm high; use - RAM or Flash RAM

Type II; 5 mm high; use - modems, LAN adaptors

Type III; 10.5 high; use - Hard Disks

PCMCIA. Personal Computer Memory Card Interface Association. See **PC Card**.

Percent Decode. The average probability that a single scan of a bar code would result in a successful decode. In a well-designed bar code scanning system, that probability should approach near 100%.

PING. (Packet Internet Groper) An Internet utility used to determine whether a particular IP address is online. It is used to test and debug a network by sending out a packet and waiting for a response.

Print Contrast Signal (PCS). Measurement of the contrast (brightness difference) between the bars and spaces of a symbol. A minimum PCS value is needed for a bar code symbol to be scannable. $PCS = (RL - RD) / RL$, where RL is the reflectance factor of the background and RD the reflectance factor of the dark bars.

Programming Mode. The state in which a scanner is configured for parameter values. See **Scanning Mode**.

Q

Quiet Zone. A clear space, containing no dark marks, which precedes the start character of a bar code symbol and follows the stop character.

QWERTY. A standard keyboard commonly used on North American and some European PC keyboards. "QWERTY" refers to the arrangement of keys on the left side of the third row of keys.

R

RAM. Random Access Memory. Data in RAM can be accessed in random order, and quickly written and read.

Reflectance. Amount of light returned from an illuminated surface.

Resolution. The narrowest element dimension which is distinguished by a particular reading device or printed with a particular device or method.

RF. Radio Frequency.

ROM. Read-Only Memory. Data stored in ROM cannot be changed or removed.

Router. A device that connects networks and supports the required protocols for packet filtering. Routers are typically used to extend the range of cabling and to organize the topology of a network into subnets. See **Subnet**.

RS-232. An Electronic Industries Association (EIA) standard that defines the connector, connector pins, and signals used to transfer data serially from one device to another.

S

Scan Area. Area intended to contain a symbol.

Scanner. An electronic device used to scan bar code symbols and produce a digitized pattern that corresponds to the bars and spaces of the symbol. Its three main components are: 1) Light source (laser or photoelectric cell) - illuminates a bar code;; 2) Photodetector - registers the difference in reflected light (more light reflected from spaces); 3) Signal conditioning circuit - transforms optical detector output into a digitized bar pattern.

Scanning Mode. The scanner is energized, programmed and ready to read a bar code.

Scanning Sequence. A method of programming or configuring parameters for a bar code reading system by scanning bar code menus.

SDK. Software Development Kit

Self-Checking Code. A symbology that uses a checking algorithm to detect encoding errors within the characters of a bar code symbol.

Shared Key. Shared Key authentication is an algorithm where both the AP and the MU share an authentication key.

SHIP. Symbol Host Interface Program.

SID. System Identification code. An identifier issued by the FCC for each market. It is also broadcast by the cellular carriers to allow cellular devices to distinguish between the home and roaming service.

SMDK. Symbol Mobility Developer's Kit.

Soft Reset. See **Warm Boot**.

Space. The lighter element of a bar code formed by the background between bars.

Specular Reflection. The mirror-like direct reflection of light from a surface, which can cause difficulty decoding a bar code.

Start/Stop Character. A pattern of bars and spaces that provides the scanner with start and stop reading instructions and scanning direction. The start and stop characters are normally to the left and right margins of a horizontal code.

STEP. Symbol Terminal Enabler Program.

Subnet. A subset of nodes on a network that are serviced by the same router. See **Router**.

Subnet Mask. A 32-bit number used to separate the network and host sections of an IP address. A custom subnet mask subdivides an IP network into smaller subsections. The mask is a binary pattern that is matched up with the IP address to turn part of the host ID address field into a field for subnets. Default is often 255.255.255.0.

Substrate. A foundation material on which a substance or image is placed.

SVTP. Symbol Virtual Terminal Program.

Symbol. A scannable unit that encodes data within the conventions of a certain symbology, usually including start/stop characters, quiet zones, data characters and check characters.

Symbol Aspect Ratio. The ratio of symbol height to symbol width.

Symbol Height. The distance between the outside edges of the quiet zones of the first row and the last row.

Symbol Length. Length of symbol measured from the beginning of the quiet zone (margin) adjacent to the start character to the end of the quiet zone (margin) adjacent to a stop character.

Symbology. The structural rules and conventions for representing data within a particular bar code type (e.g. UPC/EAN, Code 39, PDF417, etc.).

T

TCP/IP. (Transmission Control Protocol/Internet Protocol) A communications protocol used to internetwork dissimilar systems. This standard is the protocol of the Internet and has become the global standard for communications. TCP provides transport functions, which ensures that the total amount of bytes sent is received correctly at the other end. UDP is an alternate transport that does not guarantee delivery. It is widely used for real-time voice and video transmissions where erroneous packets are not retransmitted. IP provides the routing mechanism. TCP/IP is a routable protocol, which means that all messages contain not only the address of the destination station, but the address of a destination network. This allows TCP/IP messages to be sent to multiple networks within an organization or around the world, hence its use in the worldwide Internet. Every client and server in a TCP/IP network requires an IP address, which is either permanently assigned or dynamically assigned at startup.

Telnet. A terminal emulation protocol commonly used on the Internet and TCP/IP-based networks. It allows a user at a terminal or computer to log onto a remote device and run a program.

Terminal. See **Mobile Computer**.

Terminal Emulation. A "terminal emulation" emulates a character-based mainframe session on a remote non-mainframe terminal, including all display features, commands and function keys. The VC5000 Series supports Terminal Emulations in 3270, 5250 and VT220.

Terminate and Stay Resident (TSR). A program under DOS that ends its foreground execution to remain resident in memory to service hardware/software interrupts, providing background operation. It remains in memory and may provide services on behalf of other DOS programs.

TFTP. (Trivial File Transfer Protocol) A version of the TCP/IP FTP (File Transfer Protocol) protocol that has no directory or password capability. It is the protocol used for upgrading firmware, downloading software and remote booting of diskless devices.

Tolerance. Allowable deviation from the nominal bar or space width.

Transmission Control Protocol/Internet Protocol. See **TCP/IP**.

Trivial File Transfer Protocol. See **TFTP**.

TSR. See **Terminate and Stay Resident**.

U

UDP. User Datagram Protocol. A protocol within the IP protocol suite that is used in place of TCP when a reliable delivery is not required. For example, UDP is used for real-time audio and video traffic where lost packets are simply

ignored, because there is no time to retransmit. If UDP is used and a reliable delivery is required, packet sequence checking and error notification must be written into the applications.

UPC. Universal Product Code. A relatively complex numeric symbology. Each character consists of two bars and two spaces, each of which is any of four widths. The standard symbology for retail food packages in the United States.

V

Visible Laser Diode (VLD). A solid state device which produces visible laser light.

W

Warm Boot. A warm boot restarts the mobile computer by closing all running programs. All data that is not saved to flash memory is lost.

Numerics

1-D bar codes	2-21
2-D bar codes	2-21

A

accessories	1-3
auto charge cable	1-3
cables	1-3, 5-1, 5-16
communication/charge cables	
battery charging	5-17
LED indicators	5-17
DEX cable	1-3
four slot Ethernet cradle	1-3, 5-1, 5-5
four slot spare battery charger	1-3, 5-1, 5-10
headset	1-3, 5-1, 5-2
holster	1-3
magnetic stripe reader	1-3, 5-1, 5-12
MMC	5-1, 5-2
modem cable	1-3
MSR	1-3, 5-12
installation	5-12
magnetic stripe reading	5-13
multi media card	1-3
printer cable	1-3
rigid holster	5-1
SD card	5-1, 5-2
shelf slide	1-3
SIM card	1-9
single slot USB serial cradle	5-1, 5-3
SMDK	1-3
snap-on cable	1-3
snap-on handle	1-3
spare battery	1-3
specifications	A-4
stylus	1-3
trigger handle	5-1, 5-13
USB charger cable	1-3
USB cradle	1-3
vehicle cradle	1-3, 5-1, 5-7
wall mounting kit, cradle	1-3
action button	2-19

ActiveSync	
icon	2-3
adaptive frequency hopping	3-1
adjusting handstrap	1-10
adjusting volume	2-3
AFH	3-1
answering a call	4-3
auto charge cable	1-3, 5-16

B

backup battery	
charging	1-6
bar codes	
one dimensional	2-21
two dimensional	2-21
battery	
charging	1-6, 5-4, 5-6, 5-7, 5-11
check status	1-8
installing	1-4
removing	1-5
battery chargers	
communication/charge cables	5-17
LED indicators	5-17
four slot	5-10
battery charging	1-6
communication/charge cables	5-17
using four slot Ethernet cradle	5-6
using four slot spare battery charger	5-11
using single slot USB serial cradle	5-4
using vehicle cradle	5-7
battery icon	2-1, 2-4
bluetooth	
adaptive frequency hopping	3-1
bonding	3-8
deleting bonded device	3-11
discovering devices	3-7
icon	2-3
renaming bonded device	3-10
security	3-2
turning off	3-3

- turning on 3-3
- bonding, bluetooth 3-8
- boot
 - cold 2-24, 3-3
 - warm 2-24, 3-4
- bullets xiii
- buttons
 - action 2-19
 - function 2-19
 - power 1-8, 2-19, 2-24
 - scan 2-19
 - up and down 2-19

C

- cables 1-3, 5-1, 5-16
 - auto charge cable 1-3
 - connecting 5-17
 - DEX cable 1-3
 - modem 1-3
 - printer cable 1-3
 - USB charger 1-3
- calibrating the screen 1-8
- call history 4-2, 4-5, 4-11
- charging
 - spare batteries 1-7, 5-4, 5-8, 5-11
 - using four slot Ethernet cradle 5-6
 - using four slot spare battery charger 5-11
 - using single slot USB serial cradle 5-4
 - using vehicle cradle 5-7
- charging indicators 2-8, 5-17
 - four slot Ethernet cradle 5-6
 - four slot spare battery charger 5-11
 - single slot USB serial cradle 5-5
 - vehicle cradle 5-9
- charging temperature 1-8, 5-5
- cleaning 6-1
- cold boot 2-24, 3-3
- command bar 2-3
 - icons 2-3
- communication 5-16
- communication/charge cables 5-16
 - battery charging 5-17
 - LED indicators 5-17
- conference call 4-17
- configuration 1-4
- connectivity icon 2-1, 2-4
- contacts application 4-16
- conventions
 - notational xiii
- cradles
 - four slot Ethernet 1-3, 5-1, 5-5, 5-6
 - four slot spare battery charger 5-1, 5-10

- single slot USB serial 5-1, 5-3
- vehicle 1-3, 5-1, 5-7

D

- data capture
 - imager operational modes
 - decode mode 2-21
 - image capture mode 2-21
 - pick list mode 2-21
 - imaging 2-21
 - linear scanning 2-21
 - one dimensional bar codes 2-21
 - scan angle 2-22
 - scan button 2-19
 - scan range 2-21
 - scanning 2-22, 2-23
 - scanning with trigger handle 5-14
 - two dimensional bar codes 2-21
- deleting bluetooth bond 3-11
- DEX cable 1-3, 5-16

E

- email icon 2-2, 2-7
- ESD 5-2
- Ethernet cradle 1-3, 5-1, 5-5

F

- flash card 1-3, 5-2
- four slot Ethernet cradle 5-5
 - charging 5-6
 - charging indicators 5-6
- four slot spare battery charger 1-3, 5-1, 5-10
 - charging 5-11
 - charging indicators 5-11
 - setup 5-11
 - shim installation 5-10
- function buttons 2-19

H

- handstrap
 - adjusting 1-10
- hard reset 2-24, 3-3
- headset 1-3, 2-20, 5-1, 5-2
- holster 1-3

I

- icons

- ActiveSync 2-3
- battery 2-1, 2-4
- bluetooth 2-3
- connectivity 2-1, 2-4
- email 2-2, 2-7
- instant message 2-2, 2-6
- multiple notifications 2-2, 2-7
- phone 2-2, 2-5
- speaker 2-1, 2-3
- status 2-1
- task tray 2-3
- time and appointment 2-2, 2-5
- voice mail 2-2
- wireless status 2-3
- imager. *See* data capture, imaging, imagersample
- imaging 2-21
- information, service xiv
- installing battery 1-4
- instant message icon 2-2, 2-6

K

- key descriptions
 - numeric keypad 2-10
 - QWERTY keypad 2-13
- keypads
 - input modes 2-11, 2-15
 - key descriptions 2-10, 2-13
 - numeric 2-9
 - phone 4-1
 - QWERTY 2-13
 - special character key 2-17
 - types 2-9

L

- laser scanning
 - See* data capture 2-20
- LEDs 2-8
 - charging 2-8, 5-5, 5-6, 5-9, 5-11, 5-17
 - radio power 2-8
 - scan and decode 2-8, 2-22, 2-23
- lithium-ion battery 1-2
- locking EDA 2-25

M

- magnetic stripe reader 1-3, 5-1, 5-12
 - installation 5-12
 - magnetic stripe reading 5-13
- main battery
 - charging 1-4, 1-6

- installing 1-4
- maintenance 6-1
- MMC 1-3, 5-1, 5-2
- modem cable 1-3, 5-16
- MSR 1-3, 5-1, 5-12
 - installation 5-12
 - magnetic stripe reading 5-13
- multi media card 1-3, 5-1, 5-2
- muting a call 4-4

N

- navigation bar 2-1
 - icons 2-1
- notational conventions xiii
- notes application 4-5
- numeric keypad 2-9
 - input modes 2-11
 - key descriptions 2-10

O

- O'Neil printer cable 5-16
- operating environment A-1

P

- phone
 - answering a call 4-3
 - call history 4-11
 - call swapping 4-16
 - conference call 4-17
 - contacts 4-16
 - keypad 4-1
 - muting a call 4-4
 - speed dial
 - adding entry 4-6
 - calling 4-10
 - deleting entry 4-9
 - editing entry 4-8
 - taking notes 4-5
 - text messaging 4-18
 - three-way call 4-17
 - using keypad 4-2
- phone icon 2-2, 2-5
- power button 1-8, 2-19, 2-24
- printer cable 1-3

Q

- QWERTY keypad 2-13
 - input modes 2-15

key descriptions 2-13

R

removing main battery 1-5
 renaming bluetooth bond 3-10
 reset 2-24
 hard 2-24, 3-3
 soft 2-24, 3-4
 resume 3-4
 rigid holster 1-3, 5-1
 RS232 charge cable 5-16

S

scan button 2-19
 scanning
 button 2-19
 imaging 2-21
 See data capture 2-20
 screen
 calibration 1-8
 SD 5-1, 5-2
 SDK
 See SMDK 1-3
 secure digital card 5-1, 5-2
 security
 bluetooth 3-2
 sending a message 4-18
 serial charge cable 5-16
 service information xiv
 shelf slide 1-3
 shim installation 5-10
 SIM card
 accessories 1-9
 install 1-9
 single slot USB serial cradle 5-3
 charging 5-4
 charging indicators 5-5
 SMDK xiv
 snap-on handle 1-3
 soft reset 2-24, 3-4
 spare battery 1-3
 charging 1-7, 5-4, 5-8, 5-11
 spare battery charger 5-1
 charging 5-11
 charging indicators 5-11
 setup 5-11
 speaker icon 2-1, 2-3
 special characer key 2-17
 speed dial 4-6, 4-10
 starting the EDA 1-4, 1-8

status icon 2-1
 battery 2-1, 2-4
 connectivity 2-1, 2-4
 email 2-2, 2-7
 instant message 2-2, 2-6
 multiple notifications 2-2, 2-7
 phone 2-2, 2-5
 speaker 2-1, 2-3
 time and appointment 2-2, 2-5
 voice mail 2-2
 strap 1-2
 stylus 1-2, 1-3, 2-19
 subscriber identification module 1-9
 suspend 1-5, 2-19, 3-4
 Symbol mobility developer kit xiv, 1-3
 symbol support center xiv

T

task tray icons 2-3
 technical specifications A-1
 accessories A-4
 temperature A-2
 charging 1-8, 5-5
 three-way call 4-17
 time and appointment icon 2-2, 2-5
 TRG7000 5-1
 trigger handle 5-1, 5-13
 troubleshooting 6-2

U

unpacking 1-2
 up and down button 2-19
 USB charger 1-3
 USB client charge cable 5-16
 USB cradle 1-3
 using headset 2-20
 using stylus 2-19

V

vehicle cradle 1-3, 5-1, 5-7
 charging indicators 5-9
 voice mail icon 2-2

W

wakeup conditions 2-25
 waking EDA 2-25
 wall mounting kit, cradle 1-3
 warm boot 2-24, 3-4

wireless status 2-3

Z

Zebra printer cable 5-16

Tell Us What You Think...

We'd like to know what you think about this Manual. Please take a moment to fill out this questionnaire and fax this form to: (631) 738-3318, or mail to:

Symbol Technologies, Inc.
One Symbol Plaza M/S B-4
Holtsville, NY 11742-1300
Attention: Technical Publications Manager

IMPORTANT: If you need product support, please call the appropriate customer support number provided. Unfortunately, we cannot provide customer support at the fax number above.

Manual Title: _____
(please include revision level)

How familiar were you with this product before using this manual?

Very familiar Slightly familiar Not at all familiar

Did this manual meet your needs? If not, please explain.

What topics need to be added to the index, if applicable?

What topics do you feel need to be better discussed? Please be specific.

What can we do to further improve our manuals?

Symbol Technologies, Inc.
One Symbol Plaza
Holtsville, New York 11742-1300
<http://www.symbol.com>



72E-71769-01
Revision B - August 2006