

**symbol**<sup>®</sup>

**LS 5700/LS 5800**



**Product Reference Guide**





**70-16692-03**  
**Revision A — May 2003**

***LS 5700/5800***  
***Product Reference Guide***

*70-16692-03*

*Revision A*

*May 2003*



©1997-2003 by Symbol Technologies, Inc. All rights reserved.

No part of this publication may be reproduced or used in any form, or by any electrical or mechanical means, without permission in writing from Symbol. This includes electronic or mechanical means, such as photocopying, recording, or information storage and retrieval systems. The material in this manual is subject to change without notice.

The software is provided strictly on an “as is” basis. All software, including firmware, furnished to the user is on a licensed basis. Symbol grants to the user a non-transferable and non-exclusive license to use each software or firmware program delivered hereunder (licensed program). Except as noted below, such license may not be assigned, sublicensed, or otherwise transferred by the user without prior written consent of Symbol. No right to copy a licensed program in whole or in part is granted, except as permitted under copyright law. The user shall not modify, merge, or incorporate any form or portion of a licensed program with other program material, create a derivative work from a licensed program, or use a licensed program in a network without written permission from Symbol. The user agrees to maintain Symbol’s copyright notice on the licensed programs delivered hereunder, and to include the same on any authorized copies it makes, in whole or in part. The user agrees not to decompile, disassemble, decode, or reverse engineer any licensed program delivered to the user or any portion thereof.

Symbol reserves the right to make changes to any software or product to improve reliability, function, or design.

Symbol does not assume any product liability arising out of, or in connection with, the application or use of any product, circuit, or application described herein.

No license is granted, either expressly or by implication, estoppel, or otherwise under any Symbol Technologies, Inc., intellectual property rights. An implied license only exists for equipment, circuits, and subsystems contained in Symbol products.

Symbol, Spectrum One, and Spectrum24 are registered trademarks of Symbol Technologies, Inc. Other product names mentioned in this manual may be trademarks or registered trademarks of their respective companies and are hereby acknowledged.

Symbol Technologies, Inc.  
One Symbol Plaza  
Holtsville, New York 11742-1300  
<http://www.symbol.com>



# *Contents*

---

## **About This Manual**

Notational Conventions . . . . .	ix
Related Publications . . . . .	ix
Service Information . . . . .	x
Symbol Support Center . . . . .	xi

## **Chapter 1. The LS 5700/5800 Scanner**

Scanning Made Easy . . . . .	1-1
------------------------------	-----

## **Chapter 2. Set Up**

Unpacking . . . . .	2-1
Input/Output Ports . . . . .	2-2
Connecting Your Scanner . . . . .	2-4
To an IBM 468x/469x Terminal, Port 9E or Port 17 . . . . .	2-4
To an IBM 468x/469x Terminal, Port 5B RS-232C or Syn- apse Host . . . . .	2-5
To an RS-232C Host Using the RS-232C Port . . . . .	2-6
Dual-Port RS-232C . . . . .	2-7
Connecting a Hand-Held Laser Scanner . . . . .	2-8
Electronic Article Surveillance (EAS) . . . . .	2-10
EAS Options . . . . .	2-11
Mounting . . . . .	2-12
LS 5700 . . . . .	2-12
LS 5800 . . . . .	2-14
Layout . . . . .	2-15
Stainless Steel Top . . . . .	2-16
Replacing Other Symbol Fixed-Mount Scanners . . . . .	2-18
Beeper . . . . .	2-20



LS 5700 Controls . . . . .	2-20
LS 5700 Connectors . . . . .	2-22

## **Chapter 3. Scanning**

Scanning Bar Codes . . . . .	3-1
Rest/Sleep Mode . . . . .	3-2
What If... . . . .	3-3
Programming . . . . .	3-4
Scanning Sequence Examples . . . . .	3-4
Errors While Scanning . . . . .	3-4
Setting Parameters . . . . .	3-5
Host Types . . . . .	3-5
RS-232C Port Options . . . . .	3-5
Code Types & Options . . . . .	3-5
Custom Tailoring . . . . .	3-5
Decode Options . . . . .	3-6
Data Transmission Formats . . . . .	3-7
Programming Utilities . . . . .	3-7

## **Chapter 4. Maintenance and Specifications**

Routine Maintenance . . . . .	4-1
LS 5700 . . . . .	4-1
LS 5800 . . . . .	4-2
Accessories . . . . .	4-3
Technical Specifications . . . . .	4-4
Beeper Definitions . . . . .	4-8

## **Chapter 5. Parameter Menus**

Set Default Parameter . . . . .	5-5
---------------------------------	-----

Default Table . . . . .	5-6
EAS Interlock. . . . .	5-11
Enable EAS Interlock . . . . .	5-11
Disable EAS Interlock . . . . .	5-12
RS-232C Host Types . . . . .	5-13
No Host . . . . .	5-14
Single Port RS-232C Host . . . . .	5-15
Nixdorf RS-232C Host . . . . .	5-16
ICL RS-232C Host . . . . .	5-17
Fujitsu RS-232C Host . . . . .	5-18
RS-232C Port Host Options . . . . .	5-19
Baud Rate . . . . .	5-20
Parity . . . . .	5-28
Check Parity. . . . .	5-33
Do Not Check Parity. . . . .	5-34
Hardware Handshaking . . . . .	5-35
Software Handshaking . . . . .	5-42
Serial Response Time-out . . . . .	5-47
Stop Bit Select . . . . .	5-48
ASCII Format . . . . .	5-50
Serial Host RTS Line State . . . . .	5-52
Beep on <BEL> . . . . .	5-54
Do Not Beep on <BEL> . . . . .	5-55
RS-232C Port Auxiliary Options . . . . .	5-56
Baud Rate . . . . .	5-57
Parity . . . . .	5-65
Check Parity. . . . .	5-70
Do Not Check Parity. . . . .	5-71
Hardware Handshaking . . . . .	5-72
Software Handshaking . . . . .	5-76
Serial Response Time-out . . . . .	5-78
Stop Bit Select . . . . .	5-79



ASCII Format . . . . .	5-81
RTS Line State . . . . .	5-83
Hand-Held Laser Scanner Options . . . . .	5-85
Program Hand-Held Scanner Only . . . . .	5-85
Program Primary Scanner Only . . . . .	5-86
Program Hand-Held Scanner Only . . . . .	5-87
Program Primary Scanner Only . . . . .	5-88
Program All Scanners . . . . .	5-89
Beep After Good Decode . . . . .	5-90
Do Not Beep After Good Decode . . . . .	5-91
Code Types & Options . . . . .	5-92
UPC-A . . . . .	5-92
Disable UPC-A . . . . .	5-93
UPC-E . . . . .	5-94
Disable UPC-E . . . . .	5-95
EAN-8 . . . . .	5-96
Disable EAN-8 . . . . .	5-97
EAN-13 . . . . .	5-98
Disable EAN-13 . . . . .	5-99
Bookland EAN . . . . .	5-100
Disable Bookland EAN . . . . .	5-101
Decode UPC/EAN Supplementals . . . . .	5-102
Ignore UPC/EAN With Supplementals . . . . .	5-103
Autodiscriminate UPC/EAN With Supplementals . . . . .	5-104
UCC/EAN Coupon Code . . . . .	5-105
Disable UCC/EAN Coupon Code . . . . .	5-106
Random Weight Check Digit . . . . .	5-107
Random Weight Check Digit . . . . .	5-108
Random Weight Check Digit . . . . .	5-109
Code 128 . . . . .	5-110
Disable Code 128 . . . . .	5-111
UCC/EAN-128 . . . . .	5-112
Disable UCC/EAN-128 . . . . .	5-113



---

Lengths for Code 128 .....	5-114
Code 39 .....	5-115
Disable Code 39 .....	5-116
Code 39 Full ASCII .....	5-117
Enable Code 39 Full ASCII .....	5-118
Disable Code 39 Full ASCII .....	5-119
Set Lengths for Code 39 .....	5-120
Set Lengths for Code 39 .....	5-121
Set Lengths for Code 39 .....	5-122
Set Lengths for Code 39 .....	5-123
Code 39 Check Digit Verification .....	5-124
Disable Code 39 Check Digit .....	5-125
Interleaved 2 of 5 .....	5-126
Disable I 2 of 5 .....	5-127
Set Lengths for Interleaved 2 of 5 .....	5-128
Set Lengths for Interleaved 2 of 5 .....	5-129
Set Lengths for Interleaved 2 of 5 .....	5-130
Set Lengths for Interleaved 2 of 5 .....	5-131
I 2 of 5 Check Digit Verification - USS .....	5-132
OPCC Check Digit Verification - OPCC .....	5-133
I 2 of 5 Check Digit Verification .....	5-134
Codabar .....	5-135
Disable Codabar .....	5-136
Set Lengths for Codabar .....	5-137
CLSI Editing .....	5-141
Disable CLSI Editing .....	5-142
NOTIS Editing .....	5-143
Disable NOTIS Editing .....	5-144
Custom Tailoring .....	5-145
Scanning Range .....	5-145
Internal Beeper .....	5-148
Disable Internal Beeper .....	5-149



RS-232C Port External Beeper . . . . .	5-150
Disable RS-232C Port External Beeper . . . . .	5-151
Beeper Volume . . . . .	5-152
Beeper Frequency . . . . .	5-155
Time-out Between Decodes, Same Symbol . . . . .	5-158
Time-out Between Decodes, Different Symbols . . . . .	5-159
Decode Buffering . . . . .	5-160
Disable Decode Buffering . . . . .	5-161
Rest Mode . . . . .	5-162
Sleep Mode . . . . .	5-163
Time Delay to Rest/Sleep Mode . . . . .	5-164
Primary Decode Session Time . . . . .	5-168
Decode Options . . . . .	5-169
UPC/EAN Predecode Block . . . . .	5-169
Reject Predecode Block . . . . .	5-170
Accept Predecode Block . . . . .	5-171
UPC/EAN Security Level . . . . .	5-172
Linear UPC/EAN Decode . . . . .	5-176
Disable Linear UPC/EAN Decode . . . . .	5-177
Linear Supplemental Decode . . . . .	5-178
Disable Linear Supplemental Decode . . . . .	5-179
Decode Redundancy for UPC/EAN (only in Autodiscriminate Mode) . . . . .	5-180
UPC/EAN Decode Performance . . . . .	5-181
Disable UPC/EAN Decode Performance . . . . .	5-182
UPC/EAN Decode Performance . . . . .	5-183
Linear Code Type Security . . . . .	5-186
Code 128 Decode Performance . . . . .	5-190
Disable Code 128 Decode Performance . . . . .	5-191
Code 128 Decode Performance . . . . .	5-192
Code 39 Decode Performance . . . . .	5-195
Disable Code 39 Decode Performance . . . . .	5-196
Code 39 Decode Performance . . . . .	5-197

---

Data Transmission Formats . . . . .	5-200
Transmit UPC-A Check Digit . . . . .	5-200
Do Not Transmit UPC-A Check Digit . . . . .	5-201
Transmit UPC-E Check Digit . . . . .	5-202
Do Not Transmit UPC-E Check Digit . . . . .	5-203
UPC-A Preamble . . . . .	5-204
UPC-E Preamble . . . . .	5-208
Convert UPC-E to UPC-A . . . . .	5-210
Do Not Convert UPC-E to UPC-A . . . . .	5-211
EAN Zero Extend . . . . .	5-212
Disable EAN Zero Extend . . . . .	5-213
Convert EAN-8 to EAN-13 Type . . . . .	5-214
Do Not Convert EAN-8 to EAN-13 Type . . . . .	5-215
Convert I 2 of 5 to EAN-13 . . . . .	5-216
Do Not Convert I 2 of 5 to EAN-13 . . . . .	5-217
Transmit I 2 of 5 Check Digit . . . . .	5-218
Do Not Transmit I 2 of 5 Check Digit . . . . .	5-219
Transmit Code 39 Check Digit . . . . .	5-220
Do Not Transmit Code 39 Check Digit . . . . .	5-221
Beep After Good Decode . . . . .	5-222
Do Not Beep After Good Decode . . . . .	5-223
Intercharacter Delay . . . . .	5-224
Transmit Code ID Character . . . . .	5-225
Transmit AIM Code ID Character . . . . .	5-226
Do Not Transmit AIM or Symbol ID Character . . . . .	5-227
Pause Duration . . . . .	5-228
Prefix/Suffix Values . . . . .	5-229
Scan Data Transmission Format . . . . .	5-233
Serial Data Transmission Format . . . . .	5-238
Ignore Unknown Characters . . . . .	5-243
Disable Ignore Unknown Characters . . . . .	5-244
Data Format Cancel . . . . .	5-245



Programming Utilities . . . . .	5-246
Numeric Bar Codes . . . . .	5-246
Cancel . . . . .	5-256
Enter . . . . .	5-257
Applications Items . . . . .	5-258

## **Appendix**

UCC/EAN-128 . . . . .	A-1
AIM Code Identifiers . . . . .	A-3



## About This Manual

---

The *LS 5700/5800 Product Reference Guide* provides general instructions for setup, operation, troubleshooting, maintenance, and programming.

### Notational Conventions

The following conventions are used in this document:

- Bullets (•) indicate:
  - action items
  - lists of alternatives
  - lists of required steps that are not necessarily sequential
- Sequential lists (e.g., those that describe step-by-step procedures) appear as numbered lists.

### Related Publications

- *LS 5700/5800 Quick Reference Guide (p/n 70-16691-xx)*
- *LS 5800 Mounting & EAS Installation Guide (p/n 70-17856-xx)*



## **Service Information**

If you have a problem with your equipment, contact the Symbol Support Center for your region. See page xi for contact information. Before calling, have the model number, serial number, and several of your bar code symbols at hand.

Call the Support Center from a phone near the scanning equipment so that the service person can try to talk you through your problem. If the equipment is found to be working properly and the problem is symbol readability, the Support Center will request samples of your bar codes for analysis at our plant.

If your problem cannot be solved over the phone, you may need to return your equipment for servicing. If that is necessary, you will be given specific directions.

**Note:** Symbol Technologies is not responsible for any damages incurred during shipment if the approved shipping container is not used. Shipping the units improperly can possibly void the warranty. If the original shipping container was not kept, contact Symbol to have another sent to you.

## **Symbol Support Center**

For service information, warranty information or technical assistance contact or call the Symbol Support Center in:

### **United States <sup>1</sup>**

Symbol Technologies, Inc.  
One Symbol Plaza  
Holtsville, New York 11742-1300  
1-800-653-5350

### **Canada**

Symbol Technologies Canada, Inc.  
2540 Matheson Boulevard East  
Mississauga, Ontario, Canada L4W 4Z2  
905-629-7226

### **United Kingdom**

Symbol Technologies  
Symbol Place  
Winnersh Triangle, Berkshire RG41 5TP  
United Kingdom  
0800 328 2424 (Inside UK)  
+44 118 945 7529 (Outside UK)



**Asia/Pacific**

Symbol Technologies Asia, Inc (Singapore Branch)

230 Victoria Street #05-07/09

Bugis Junction Office Tower

Singapore 188024

Tel : +65-6796-9600

Fax : +65-6337-6488

**Australia**

Symbol Technologies Pty. Ltd.

432 St. Kilda Road

Melbourne, Victoria 3004

1-800-672-906 (Inside Australia)

+61-3-9866-6044 (Outside Australia)

**Austria/Österreich**

Symbol Technologies Austria GmbH

Prinz-Eugen Strasse 70 / 2.Haus

1040 Vienna, Austria

01-5055794-0 (Inside Austria)

+43-1-5055794-0 (Outside Austria)

**Denmark/Danmark**

Symbol Technologies AS

Dr. Neergaardsvej 3

2970 Hørsholm

7020-1718 (Inside Denmark)

+45-7020-1718 (Outside Denmark)



**Europe/Mid-East Distributor Operations**

Contact your local distributor or call

+44 118 945 7360

**Finland/Suomi**

Oy Symbol Technologies

Kaupintie 8 A 6

FIN-00440 Helsinki, Finland

9 5407 580 (Inside Finland)

+358 9 5407 580 (Outside Finland)

**France**

Symbol Technologies France

Centre d’Affaire d’Antony

3 Rue de la Renaissance

92184 Antony Cedex, France

01-40-96-52-21 (Inside France)

+33-1-40-96-52-50 (Outside France)

**Germany/Deutschland**

Symbol Technologies GmbH

Waldstrasse 66

D-63128 Dietzenbach, Germany

6074-49020 (Inside Germany)

+49-6074-49020 (Outside Germany)



**Italy/Italia**

Symbol Technologies Italia S.R.L.

Via Cristoforo Colombo, 49

20090 Trezzano S/N Navigilo

Milano, Italy

2-484441 (Inside Italy)

+39-02-484441 (Outside Italy)

**Latin America Sales Support**

2730 University Dr.

Coral Springs, FL 33065 USA

1-800-347-0178 (Inside United States)

+1-954-255-2610 (Outside United States)

954-340-9454 (Fax)

**Mexico/México**

Symbol Technologies Mexico Ltd.

Torre Picasso

Boulevard Manuel Avila Camacho No 88

Lomas de Chapultepec CP 11000

Mexico City, DF, Mexico

5-520-1835 (Inside Mexico)

+52-5-520-1835 (Outside Mexico)

**Netherlands/Nederland**

Symbol Technologies

Kerkplein 2, 7051 CX

Postbus 24 7050 AA

Varsseveld, Netherlands

315-271700 (Inside Netherlands)

+31-315-271700 (Outside Netherlands)

**Norway/Norge**

Symbol's registered and mailing address:

Symbol Technologies Norway

Hoybratenveien 35 C

N-1055 OSLO, Norway

Symbol's repair depot and shipping address:

Symbol Technologies Norway

Enebakkveien 123

N-0680 OSLO, Norway

+47 2232 4375

**South Africa**

Symbol Technologies Africa Inc.

Block B2

Rutherford Estate

1 Scott Street

Waverly 2090 Johannesburg

Republic of South Africa

11-809 5311 (Inside South Africa)

+27-11-809 5311 (Outside South Africa)



**Spain/España**

Symbol Technologies S.L.  
Avenida de Bruselas, 22  
Edificio Sauce  
Alcobendas, Madrid 28108  
Spain  
91 324 40 00 (Inside Spain)  
+34 91 324 40 00 (Outside Spain)  
Fax: +34.91.324.4010

**Sweden/Sverige**

“Letter” address:  
Symbol Technologies AB  
Box 1354  
S-171 26 SOLNA  
Sweden

Visit/shipping address:  
Symbol Technologies AB  
Solna Strandväg 78  
S-171 54 SOLNA  
Sweden

Switchboard: 08 445 29 00 (domestic)  
Call Center: +46 8 445 29 29 (international)  
Support E-Mail: [Sweden.Support@se.symbol.com](mailto:Sweden.Support@se.symbol.com)

<sup>1</sup>Customer support is available 24 hours a day, 7 days a week.

If you purchased your Symbol product from a Symbol Business Partner, contact that Business Partner for service.

For the latest version of this guide go to:

<http://www.symbol.com/manuals>.



*LS 5700/LS 5800 Product Reference Guide*

---



## Chapter 1 *The LS 5700/5800 Scanner*

---

### Scanning Made Easy

The LS 5700 and LS 5800 are compact, high performance, omni-directional scanners that bring easy, hands-free scanning to your point-of-sale system.

- The **LS 5700** mounts on the counter and lets you scan side-to-side, or perpendicular to the face of the scanner.
- The **LS 5800** is designed for in-counter mounting. It allows slide-through scanning of items, thereby enhancing productivity and throughput.

The LS 5700 and LS 5800 scanners ([Figure 1-1](#)) are identical electrically, and provide the same reliable scanning capabilities. In instances where no distinction is drawn between the LS 5700 and LS 5800, they will be collectively referred to as the “scanner.”

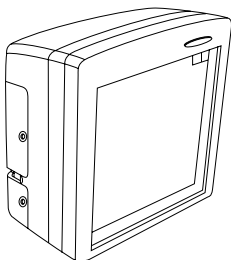

**LS 5700**

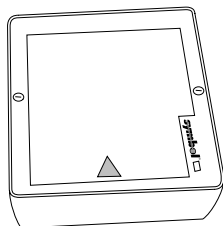

**LS 5800**

**Figure 1-1. LS 5700/LS 5800 Scanners**



Pass an item's bar code symbol past the scanner window and the item number is quickly sent to your host system. The scanner is compact, easy to install, and fits most check stand designs.

The scanner decodes UPC/EAN, UPC/EAN Supplementals, Code 39, Code 39 Full ASCII, I 2 of 5, Code 128, and Codabar. Additionally, UPC/EAN Random Weight Goods Check Digit, UCC 128 Coupon Code, Bookland EAN-13, and ITF-14 are supported.

In most instances, changing host systems is as easy as scanning the appropriate bar code and changing the cable. The scanner provides connection for an optional Synapse™ compatible hand-held scanner such as an LS 4004. The hand-held scanner allows you to scan heavy items without lifting them.

Some scanner models have an integrated radio frequency-based electronic article surveillance (EAS) system for deactivating tags. An optional external kit is available for models that do not contain an integrated antenna.





## Chapter 2 Set Up

---

### Unpacking

Remove the scanner from its packing and inspect it for damage. [Figure 2-1](#) shows the items which should be included with the shipment:

- Scanner
- Power supply or power cable (if applicable)
- RS-232C Host interface cable, or Synapse Adapter cable and Synapse cable
- Quick Reference Guide

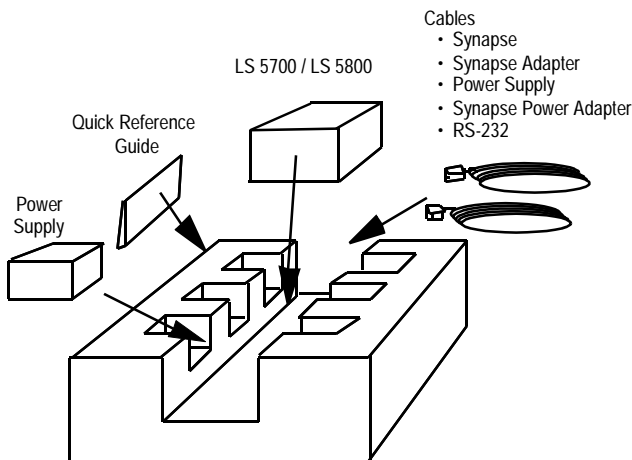

Figure 2-1. Items Contained in a Typical Scanner Package



Some host terminals (e.g., IBM 46xx Series) can supply power to the scanner. In those cases, an external power supply is not required. See your Symbol representative for more information.

If the scanner or any other content is missing, or was damaged in transit, call the [Symbol Support Center](#) at the telephone number listed on page xi.

**KEEP THE PACKING.** It is the approved shipping container and should be used if you ever need to return your equipment for servicing.

## Input/Output Ports

The scanner contains the ports as shown in [Figure 2-2](#).

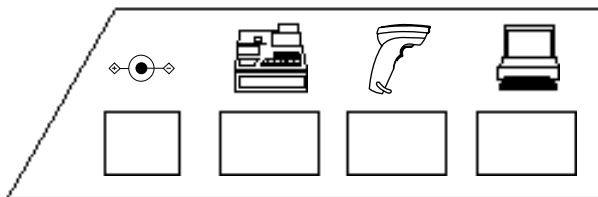

Figure 2-2. Input/Output Ports



**Power In Port.** When external power is required, the input to this port is 5 V @ 550 mA nominal. Current draw on this port should not exceed 1.2 A.



**Host Port.** A 6-pin modular connector. Plug the Synapse Adapter cable, or Synapse Power Regulator cable into this port.



**Hand-Held Laser Scanner Port.** A 6-pin modular connector. Plug a Symbol Synapse-compatible scanner such as the LS 4004, LS 3603MX, or LS 3203ER into this port. This scanner can be used to program the LS 5700/LS 5800, and adapts itself to the LS 5700/LS 5800 decode parameters (i.e., code types, lengths and check digits). A separate AC adapter may be necessary when using a hand-held scanner. Current draw on this port should not exceed 200 mA.



**RS-232C Port.** A 10-pin modular connector. This input/output port is used to connect the scanner to an RS-232C host. It is also used as an auxiliary port to connect serial devices such as a scale, magstripe reader, etc. Current draw on this port should not exceed 200 mA.



## Connecting Your Scanner

### To an IBM 468x/469x Terminal, Port 9E or Port 17

Attach the Synapse Power Regulator Y-cable as shown in [Figure 2-3](#). One connector goes to the **Host** port and the other to the **Power** port. Attach a Synapse cable between the Power Regulator cable and the IBM terminal. No additional power supply is needed, as the IBM terminal supplies power to the scanner. If additional scanning versatility is desired, plug a Synapse-compatible scanner into the **Hand-Held Laser Scanner** port.

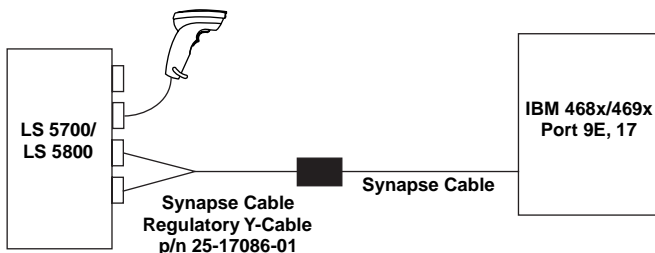

Figure 2-3. Connecting to an IBM Terminal, Port 9E or Port 17

*In this configuration, the scanner draws power from the host.*

---

### To an IBM 468x/469x Terminal, Port 5B RS-232C or Synapse Host

Attach the Synapse Adapter cable to the **Host** port on the scanner. Attach the appropriate Synapse cable to the Adapter cable and to the host terminal. Attach the power supply to the **Power** port. If additional scanning versatility is desired, plug a Synapse-compatible scanner into the **Hand-Held Laser Scanner** port (Figure 2-4).

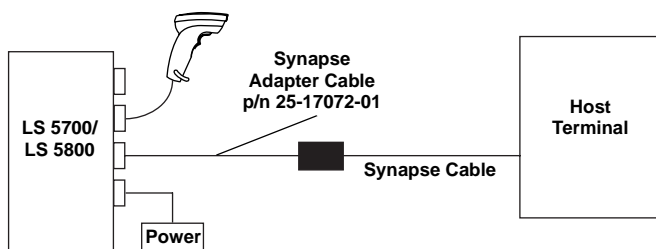

**Figure 2-4. Connecting to an IBM Terminal Port 5B RS-232C**

*In this configuration, an external power supply is required.*



### To an RS-232C Host Using the RS-232C Port

Connect one end of the RS-232C cable to the **RS-232C** port, and the other to the host. Attach the power supply to the **Power** port. If additional scanning versatility is desired, plug a Synapse-compatible scanner into the **Hand-Held Laser Scanner** port (Figure 2-5).



Figure 2-5. Connecting to an RS-232C Host

*In this configuration, an external power supply is required.*

## Dual-Port RS-232C

Attach the Synapse adapter cable to the **Host** port on the scanner. Attach the appropriate Synapse cable to the adapter cable, the host terminal, and auxiliary RS-232C device. Attach the power supply to the **Power** port. If additional scanning versatility is desired, plug a Synapse-compatible scanner into the **Hand-Held Laser Scanner** port (Figure 2-6).

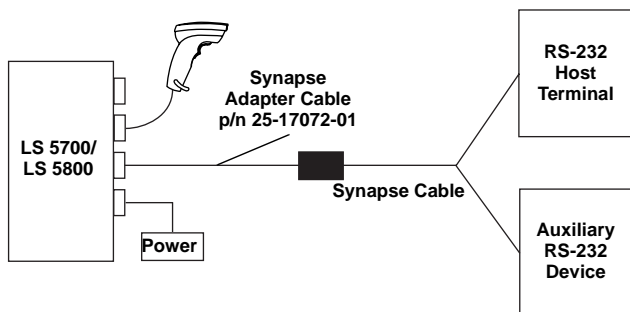

Figure 2-6. Dual Port RS-232C

*In this configuration, an external power supply is required.*



## Connecting a Hand-Held Laser Scanner

Attach the hand-held laser scanner's Synapse Adapter cable to the **Scanner** port of the LS 5700/LS 5800 (primary scanner). In most cases, the hand-held laser scanner automatically configures itself at this point. If it does not, follow the hand-held laser scanner's Synapse setup directions.

When the hand-held laser scanner is connected to the **Scanner** port of the primary scanner, the hand-held scanner auto-configures and inherits some of the primary scanner's decode parameters. Any changes to the primary scanner's settings are automatically reflected back to the hand-held scanner. Programming bar codes are provided to:

- program only the hand-held laser scanner
- program only the LS 5700/LS 5800
- program both scanners simultaneously

If you are using a Symbol LS 2603MX, LS 3603MX, or LS 3203 hand-held scanner, different bar codes are used to set these programming modes. They begin on page 5-87.

Some hand-held scanners do not support these programming modes. Parameter bar codes affect only these scanners, not the primary scanner – regardless of the programming mode selected.

When this type of hand-held scanner is connected, the only way to program the primary scanner is to scan parameter bar codes with the primary scanner.



To ascertain which type of hand-held scanner you have, plug the scanner into the **Scanner** port. Using the hand-held scanner, scan a parameter bar code. If the primary scanner issues a warble beep, the hand-held scanner you have supports the programming modes. If the hand-held scanner issues a warble beep, it does not support these modes.



## Electronic Article Surveillance (EAS)

When installing an EAS system, be sure to follow the criteria outlined in the *LS 5800 Mounting Instructions and EAS Installation Guide*.

For those scanners equipped with an EAS antenna, *Parameter Menus* in *Chapter 5* allow you to activate the EAS system independent of the scanner, or combine the two in an exclusive interlock feature.

The interlock feature discourages “sweetheart shopping.” These are instances where some customers are favored, and not all items are scanned. The interlock prohibits the deactivation of the EAS tag without the item being scanned first.

Do not attempt to activate the interlock feature yourself. The following instructions are for a Symbol qualified technician only.

1. Peel off the EAS sticker on the scanner.
2. Open the scanner and run the EAS Interlock cable through the hole where the EAS sticker was.
3. Attach this cable to the PCB connector.
4. Attach the other end of the cable to the EAS system.

*Be sure to scan the proper bar code to activate this feature.*

The deactivation range is mapped suitable to the scanning range, so both can be accomplished almost simultaneously.

---

## EAS Options

EAS is available with either an internal antenna, or an external antenna kit. Various configurations are shown in [Table 2-1](#).

**Table 2-1. EAS Options**

<b>Option</b>	<b>Model Number</b>	<b>Bucket or Kit Number</b>
<b>Internal</b>	LS-5700-I000GC	Not Applicable
<b>Internal</b>	LS-5800-I20xTC	12-17206-02
<b>External</b>	LS-5800-I21xSN	KT-19430-01
<b>External</b>	LS-5800-I21xDN	KT-19430-01
<b>Internal</b>	LS-5800-I210SC	Not Applicable

These are the only standard models offering EAS.

Complete mounting instructions and details are provided in the *LS 5800 Mounting Instructions and EAS Installation Guide*.



## Mounting

### LS 5700

The LS 5700 is designed to rest on top of the counter. The dotted area in [Figure 2-7](#) represents the active scan area, or the area in which a bar code is decoded.

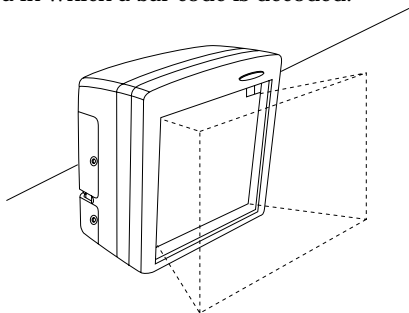

Figure 2-7. LS 5700 Active Scan Area

For added stability, the LS 5700 can also be mounted in a stand.

1. Attach the stand to the counter top or other stable base. Secure with three screws ([Figure 2-8](#)).

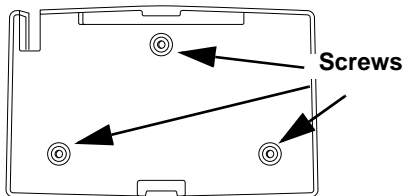
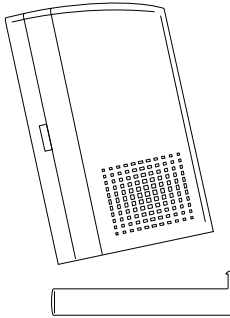

Figure 2-8. Attaching the Stand to the Counter Top

2. Place the front of the scanner under the front lip of the stand ([Figure 2-9](#)).



**Figure 2-9. Placing the LS 5700 into the Stand**

3. Push the rear of the scanner down until it snaps into place ([Figure 2-10](#)).

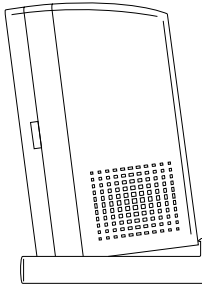

**Figure 2-10. Seating the Scanner**



## Mounting

### LS 5800

The LS 5800 mounts in the counter, with the face of the scanner either flush with the counter top or resting on it. The dotted area in [Figure 2-11](#) depicts the active scan area, and the arrow shows the optimal direction of product flow. The scanner's active scan zone extends about 6 in. (15.24 cm) above the window, and is angled at approximately 38° from the counter.

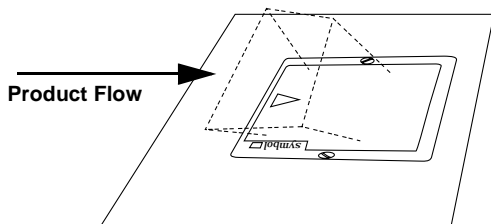
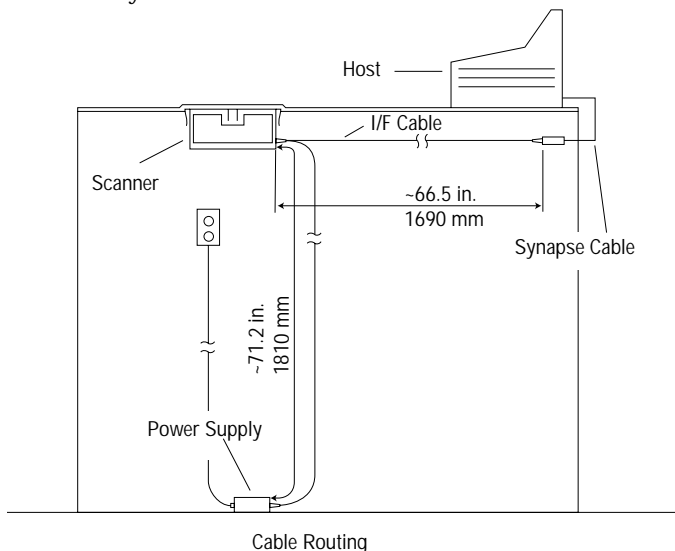

Figure 2-11. LS 5800 Active Scan Area

## Layout

Figure 2-12 shows a typical LS 5800 installation. For best operating results, locate the power supply at least 4 in. (10.16 cm) below the scanner chassis or 2 in. (5.08 cm) away laterally.



**Figure 2-12. Typical LS 5800 Installation**

LS 5800-IXXTN and LS 5800-IXXTC models have a Tempax Scratch-Resistant glass window. An in-counter mounting kit is required for these models. Instructions for mounting can be found in the *LS 5800 Mounting & EAS Installation Guide*.



Mounting instructions for other LS 5800 models begin below.

### Stainless Steel Top

- The LS-5800-I210DN has a Stainless Steel Top with a Diamondex-Coated glass.
- The LS-5800-I210SN has a Stainless Steel Top with a Sapphire glass.
- The LS-5800-I210SC has a Stainless Steel Top with a Sapphire glass and is EAS ready.

There are two options for mounting the LS 5800 with a Stainless Steel Top.

#### Option A - Resting on the counter top

**Note:** Not applicable to the LS-5800-I210SC configuration.

1. Cut a hole in the counter 6.81 in. (173 mm) square.

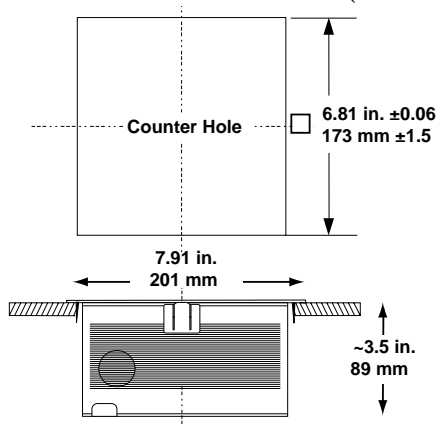

Figure 2-13. Stainless Steel Top Option A



2. Route the cables from beneath the hole and attach to the scanner as shown in [Figure 2-12](#).
3. Lower the scanner into the counter hole.

### **Option B- Flush with the counter top**

1. On the counter top, measure two concentric squares: an inside square of 6.81 in. (173 mm), and an outside square of 7.91 in. (201 mm) ([Figure 2-14](#))
2. Cut out the 6.81 in. (173 mm) inner square.
3. With a router set to the appropriate depth, route out the outside square. The corner radius should not exceed 0.20 in. (5 mm).
  - LS-5800-I210DN: depth = 0.05in. (1.2mm)
  - LS-5800-I210SN: depth = 0.05in. (1.2mm)



- LS-5800-I210SC: depth = 0.27in. (6.8mm)

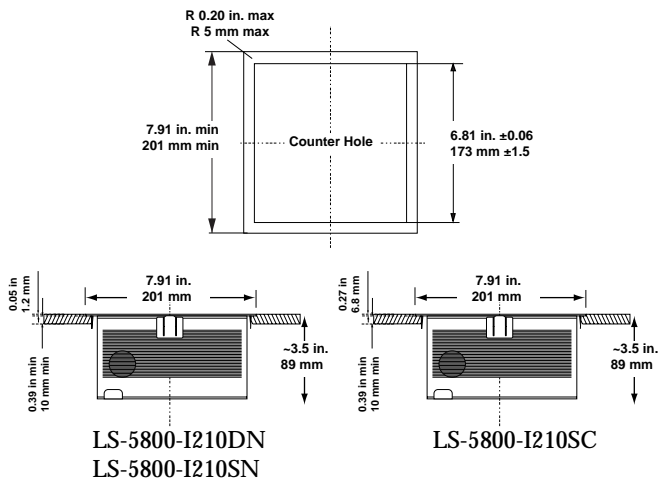

Figure 2-14. Stainless Steel Top Option B

4. Route the cables from beneath the hole and attach to the scanner as shown in [Figure 2-12](#).
5. Lower the scanner into the counter hole.

### Replacing Other Symbol Fixed-Mount Scanners (LS 5100/LS 5400) with LS 5800-I220SN

1. Remove the LS 5100/LS 5400 scanner.
2. Place the LS 5800-IxxxZN or LS 5800-I220SN scanner on the counter near the hole.
3. Route the cables from beneath the hole and attach to the scanner as shown in [Figure 2-12](#).

4. Lower the scanner into the hole.

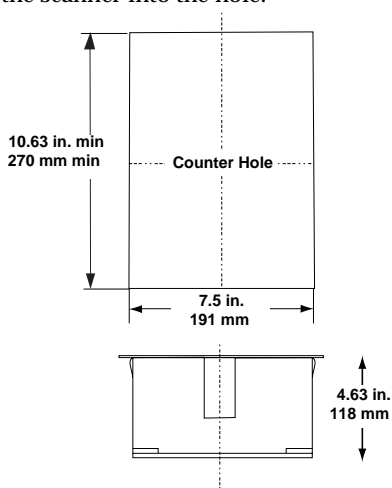

Figure 2-15. Replacement Bucket



## Beeper

The scanner has an internal beeper to signal a good decode or provide other information (see [Beeper Definitions](#) beginning on page 4-8). An external beeper can also be connected to the RS-232C port. Either or both of these beepers can be enabled or disabled through the use of bar code menus.

## LS 5700 Controls

See [Figure 2-16](#) on the following page. The LS 5700 has a push button near the top right corner. This push button is to adjust both the volume and tone of the beeper, and to wake the scanner from its Rest or Sleep mode.

When the scanner is operating, depress this button to adjust the volume/tone. Hold down the button until the desired sound is obtained. There are five distinct volume/tone combinations. Each combination beeps two times before cycling to the next sound. When you hear the volume/tone combination you want, immediately release the button.

If the scanner is in a Rest or Sleep mode, depressing this push button briefly will awaken the scanner.

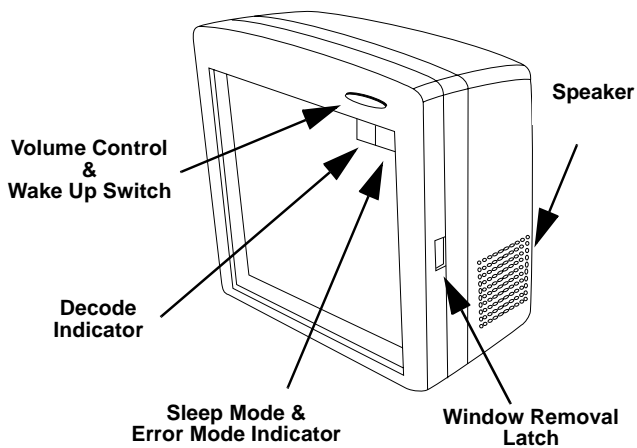

**Figure 2-16. LS 5700 Controls**



## LS 5700 Connectors

Removing the connector cover will allow access to the scanner's connectors ([Figure 2-17](#)).

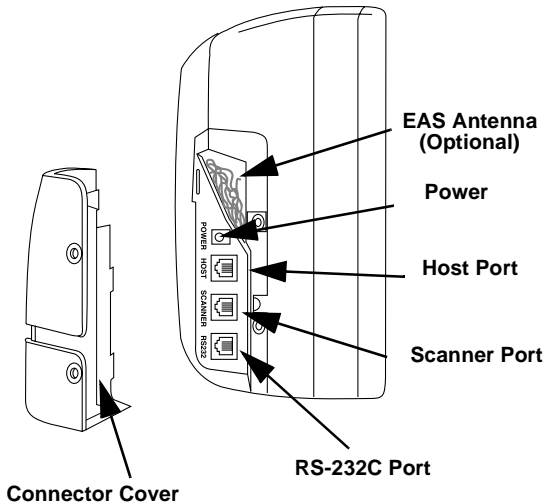

Figure 2-17. LS 5700 Connectors



## Chapter 3 Scanning

---

### Scanning Bar Codes

For the best scanning performance, the counter top or surface area covered by the active scan area should be free of any designs (e.g. stripes or patterns). Ideally, that area should be a light solid color. To scan a bar code, move an item through the active scan area in the direction of the arrows, with the bar code label facing the scan window (Figure 3-1). The scanner beeps when a bar code has been decoded successfully.

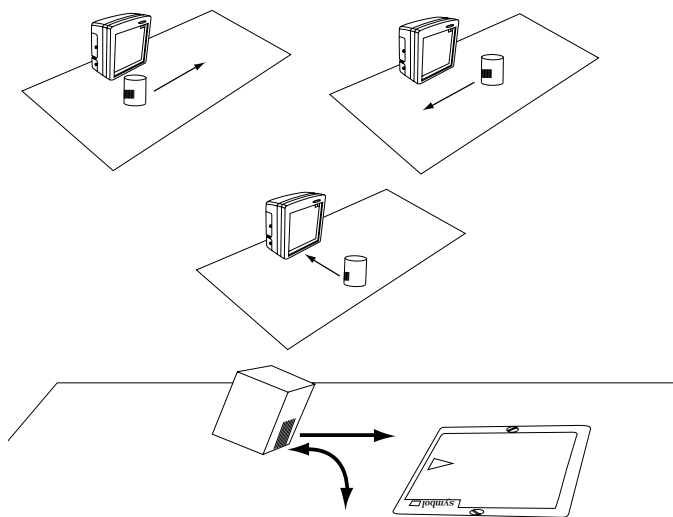

Figure 3-1. Scanning Bar Codes



## Rest/Sleep Mode

If there is no scanning activity for a specified period of time, the scanner enters a Rest, or reduced power mode. The default time of 30 minutes can be changed by scanning the appropriate bar code in [Chapter 5](#). This mode saves power and extends the life of the scanner. The scanner automatically awakens as soon as you pass a bar coded item in front of the scan window.

The LS 5700 also has a programmable shut down Sleep option that turns off the laser and the motor. The scanner can be awakened from this mode or the Rest mode by momentarily depressing the push button on the top right corner. When you press this button, the scanner emits two beeps, and the volume and tone settings remain unchanged.



## What If...

**Nothing happens when you follow the operating instructions.**

### You Should

- Check that the scanner is plugged into an AC outlet.
- Ensure that the power supply DC output is connected firmly to the scanner.
- Make sure the scanner is connected to the point-of-sale register.
- Be sure that you've scanned a host type.
- Check for loose cable connections.
- Make certain the code type you're trying to decode is enabled, and that it is supported by your host.
- Check the symbol to make sure it is of suitable quality (not damaged).
- Try scanning similar symbols of the same code type.
- Be sure you're using the proper power supply.

**Note:** If after performing these checks the symbol still does not scan, contact your distributor or call the *Symbol Support Center*. See page xi for the telephone number.



## Programming

You can custom tailor the performance and operation of the scanner with a series of bar codes. Refer to the [Default Table](#) beginning on page 5-6 for a list of the factory-programmed defaults. A table of [Beeper Definitions](#) applicable to programming is located on page 4-8.

### Scanning Sequence Examples

In most cases you need only scan one bar code to set a specific parameter. For example, if you want to set the baud rate to 9600, simply scan the **9600** bar code listed under **BAUD RATE**. The scanner issues a warble tone, signifying a successful parameter entry.

If you want to enable or disable prefixes and suffixes, or customize the data transmission format, you have to scan several bar codes.

### Errors While Scanning

Don't worry if you make an error during a scanning sequence. Merely scan **CANCEL** and reenter the correct parameter.

## Setting Parameters

If the default values suit your requirements, all you need to do is scan a **Host Type**. See [Table 5-1](#) on *page 5-6*. Parameters other than default values can be set by scanning appropriate bar codes.

### Host Types

To communicate properly with your host terminal, a **Host Type** must be selected. If you are using a Synapse Smart Cable, a programming sheet containing a host bar code is packaged with the cable. Select your host type using that bar code.

### RS-232C Port Options

Serial RS-232C data can be modified to meet host requirements.

### Code Types & Options

Enable or disable host-supported code types and options such as UPC or EAN supplementals and selectable code lengths.

### Custom Tailoring

Customize any combination of the following parameters to suit your specific environment or application requirements.

- Scanning Range
- Beeper Volume
- Beeper Tone



- **Decode Time-out** or “Time-out period between successive decodes of identical bar codes.” This time-out minimizes the chances of reading a single item more than once during a scanning attempt. Generally speaking, a minimal time-out period is best in a high throughput environment (e.g. supermarket). A longer time-out period may be preferred in a lower throughput environment.
- **Decode Session Time-out.** This parameter applies to the primary scanner (i.e., LS 5700 or LS 5800), and refers to the length of time decode processing continues during a scan attempt.
- **Power down** or Rest mode. Select how long the scanner remains on during periods of inactivity. On the LS 5700, you can also select a Sleep mode.

## **Decode Options**

- **Reject Predecode Block.** Added security against accidental misdecodes caused by an operator bringing similar but not identical items into the scanners field of view simultaneously. When enabled, the scanner rejects a bar code which contains a block similar to the last decoded bar code.
- **Accept Predecode Block.** Allows the scanner to decode any bar code regardless of the item last decoded.
- **Security Levels.** Provides increasing levels of security against misdecoding out of spec bar codes. Increasing levels of security adversely affect the aggressiveness of the scanner.

## Data Transmission Formats

- The options listed below modify the bar code or serial data into a host-compatible format prior to transmission.
  - Transmit Check Digits
  - Preambles
  - Prefix, Suffix values
  - Transmit Code ID Character
  - Ignore Unknown Characters

## Programming Utilities

This section contains numeric bar codes used to quantify certain options, application specific bar codes, **Enter** and **Cancel** bar codes.



*LS 5700/LS 5800 Product Reference Guide*

---



## Chapter 4 Maintenance and Specifications

---

### Routine Maintenance

Cleaning the exit window is the only maintenance required. A dirty or scratched window may affect scanning activity.

- Remove any dirt particles with a damp cloth.
- Wipe the window with a tissue moistened with ammonia/water.

### LS 5700

To change or clean the exit window:

- Press window removal latch and rotate forward (Figure 4-1).

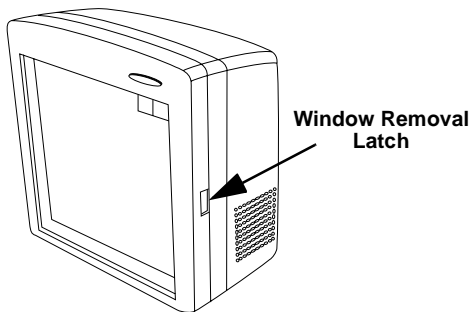

Figure 4-1. Removing window from an LS 5700

### To Clean:

- Wipe clean the underside of the upper window.
- Wipe clean the top surface of the lower window.
- Re-install the window by snapping into place.



## LS 5800

To change or clean the exit window:

- Insert a coin into the large screw heads on the front of the scanner and turn counter-clockwise (Figure 4-2).

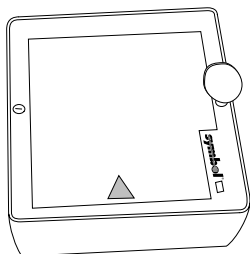

Figure 4-2. Removing Window from an LS 5800

- Lift off the window.

### To Clean:

- Wipe clean the underside of the upper window.
- Wipe clean the top surface of the lower window.
- Re-install the top cover by tightening the two large screws.



### Removal from Counter:

- Remove the window as described on the previous page.
- Lift the unit out by the two lift straps (Figure 4-3).

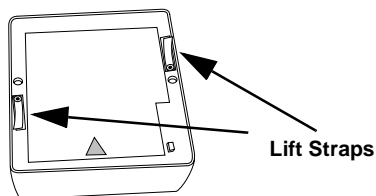

Figure 4-3. Removing the Scanner

### Accessories

The following accessories are available from Symbol Technologies. See your Symbol representative or re-seller for ordering information.

- LS 5700 Mounting Stand
- LS 5800 In-counter Mounting Kit
- LS 5800 Stainless steel top plate with various hardened window options
- LS 5700/LS 5800 External Beeper
- Competitive Scanner Adapter Kit\*
- EAS Antenna kit
  - Pre-loaded on some models
  - Add-on kit for either model

\*Contact your Symbol representative for more information.



## Technical Specifications

Table 4-1. Technical Specifications

Item	Description
<b>Power Requirements</b>	+5.0 VDC $\pm$ 5% Consumes 3.5 watts nominal
<b>Scanner System</b> <b>LS 5700</b>  <b>LS 5800</b>	16-line, 4-direction dynamic cross pattern  18-line, 6-direction dynamic cross pattern
<b>Angular Orientation</b> <b>Yaw</b> <b>Roll</b> <b>Pitch</b> <b>LS 5700</b> <b>LS 5800</b>	-45° to +45° 360°  -30° to +60° 0° to 90°
<b>Decode Depth of Field</b>	On 100% UPC symbols See <a href="#">Table 4-2</a> .
<b>Print Contrast Minimum</b>	25% absolute dark/light reflectance differential, measured at 675 nm.
<b>Ambient Light Immunity</b> <b>Fluorescent</b> <b>Incandescent</b> <b>Mercury Vapor</b> <b>Sodium Vapor</b> <b>Sunlight</b>	450 ft. candles      4844 lux 450 ft. candles      4844 lux 450 ft. candles      4844 lux 450 ft. candles      4844 lux 9000 ft. candles     96876 lux

Table 4-1. Technical Specifications (cont'd)

Item	Description	
Operating Temperature	32° to 104°F	0° to 40°C
Operating Humidity	5% to 95% non-condensing	
Storage Temperature	-40° to 140°F	-40° to 60°C
Storage Humidity	5% to 95% non-condensing	
Weight		
LS 5700	1.9 lbs	.86 kg
LS 5800	1.8 lbs	.81 kg
Dimensions		
LS 5700		
Depth	3.82 in.	9.7 cm
Height	6.2 in.	15.7 cm
Width	5.97 in.	15.2 cm
LS 5800	See <a href="#">Table 4-3</a>	
Cable Length	6 ft.	183 cm

Table 4-2. LS 5700/LS 5800 Decode Range

	LS 5700	LS 5800
Full Range	10 in. 25.4 cm	6.7 in. 17.0 cm
Medium Range	7.0 in. 17.8 cm	6.0 in. 15.2 cm
Short Range	3.5 in. 8.9 cm	3.5 in. 8.9 cm
Decode range depends on contrast, density, orientation, and quality of the bar code being decoded.		



**Table 4-3. LS 5800 Scanner Dimensions**

<b>Model</b>	<b>Outer Window Type of Glass</b>	<b>Depth In. (cm)</b>	<b>Width in. (cm)</b>	<b>Length in. (cm)</b>	<b>Outer Window (Glass) Size in. (cm)</b>
<b>LS 5800-I200TN</b>	Tempax	3.1 (7.62)	6 (15.24)	6 (15.24)	5 x 5 (12.7 x 12.7)
<b>LS 5800-I200TC</b>	Tempax	3.1 (7.62)	6 (15.24)	6 (15.24)	5 x 5 (12.7 x 12.7)
<b>LS 5800-I210DN</b>	Diamond coated	3.3 (8.4)	7.9 (20.1)	7.9 (20.1)	4.6 x 5.1 (11.7 x 12.9)
<b>LS 5800-I210SN</b>	Sapphire coated	3.3 (8.4)	7.9 (20.1)	7.9 (20.1)	4 x 5 (10.2 x 12.7)
<b>LS 5800-I220SN</b>	Sapphire coated	3.3 (8.4)	11.8 (30.)	8.8 (22.3)	5 x 4 (12.7 x 10.2)
<b>LS 5800-I210SC</b>	Sapphire coated	3.3 (8.4)	11.8 (30.)	8.8 (22.3)	5 x 4 (12.7 x 10.2)

**Table 4-4. LS 5800 Bucket Dimensions**

<b>Model</b>	<b>Top Plate</b>		<b>Depth In. (cm)</b>
	<b>Width In. (cm)</b>	<b>Length In. (cm)</b>	
<b>Standard (12-17206-xx)</b>	7.87 (200)	7.87 (200)	3.16 (80.2)
<b>LS 5000 Replacement (12-17207-xx)</b>	8.5 (216)	11.65 (296)	3.16 (80.2)
<b>Spectra-Physics Freedom Adaptor (12-17208-xx)</b>	11.3 (287)	14.37 (365)	3.16 (80.2)



## Beeper Definitions

Table 4-5. Beeper Definitions

Beeper Sequence	Indication
<b>Standard Use</b>	
<b>1 Beep - short high tone</b>	A bar code symbol was decoded, or serial data was received.
<b>Lo/med/hi tone</b>	Power-on reset. Occurs immediately after the unit is turned on or after a system reset, indicating the system software is working properly. If three beeps occur during normal operation, it is due to a reset; any work in progress is lost. If this occurs often, contact the Symbol Support Center.
<b>4 Beeps - long high tone</b>	A format or transmission error has been detected in the serial data or in a scanned symbol. The data is ignored. This occurs if a unit is not properly configured. Check option settings.
<b>5 Beeps - long high tone</b>	Data conversion error.

**Table 4-5. Beeper Definitions (cont'd)**

<b>Beeper Sequence</b>	<b>Indication</b>
<b>Parameter Menu Scanning</b>	
<b>Lo/hi tone</b>	Input error, incorrect bar code or "Cancel" scanned, wrong entry, incorrect bar code programming sequence; remain in program mode.
<b>Hi/lo tone</b>	Keyboard parameter selected. Enter value using bar code keypad.
<b>Hi/lo/hi/lo tone</b>	Successful program exit with change in the parameter setting.
<b>Serial Communication</b>	
<b>1 Beep - short high tone</b>	Serial communication was successfully received, then transmitted to the host.
<b>4 Beeps - short high tone</b>	Serial communications error.
<b>Hi/hi/hi/hi</b>	Parity error.



*LS 5700/LS 5800 Product Reference Guide*

---





## Chapter 5 Parameter Menus

---

Set All Defaults	5-5
EAS Interlock	5-11 to 5-12
<b>RS-232C Host Types</b>	<b>5-13 to 5-17</b>
<b>RS-232C Port Host Options</b>	<b>5-19 to 5-55</b>
Baud Rate	5-20 to 5-27
Parity	5-28 to 5-32
Check Parity	5-33 to 5-34
Hardware Handshaking	5-35 to 5-41
Software Handshaking	5-42 to 5-46
Serial Response Time-out	5-47
Stop Bit Select	5-48 to 5-49
ASCII Format	5-50 to 5-51
Serial Host RTS Line State	5-52 to 5-53
Beep on <BEL>	5-54 to 5-55
<b>RS-232C Port Auxiliary Options</b>	<b>5-56 to 5-84</b>
Baud Rate	5-57 to 5-64
Parity	5-65 to 5-69
Check Parity	5-70 to 5-71
Hardware Handshaking	5-72 to 5-75
Software Handshaking	5-76 to 5-77
Serial Response Time-out	5-78
Stop Bit Select	5-79 to 5-80
ASCII Format	5-81 to 5-82
Aux Serial RTS Line State	5-83 to 5-84



<b>Hand-Held Laser Scanner Options</b>	<b>5-85 to 5-91</b>
Program Hand-Held Scanner Only	5-85
Program Primary Scanner Only	5-86
Program Hand-Held Scanner Only*	5-87
Program Primary Scanner Only*	5-88
Program All Scanners	5-89
Hand-Held Scanner Beeper	5-90
*Applies only to LS 2603MX/LS 3603MX and LS 3203	

<b>Code Types &amp; Options</b>	<b>5-92 to 5-144</b>
UPC-A/ UPC-E	5-92 to 5-95
EAN-8/EAN-13, Bookland, EAN, Supplementals	5-96 to 5-104
UCC/EAN Coupon Code	5-105 to 5-106
Random Weight Check Digit	5-107 to 5-109
Code 128	5-110 to 5-114
Code 39	5-115 to 5-125
I 2 of 5	5-126 to 5-134
Codabar	5-135 to 5-144

<b>Custom Tailoring</b>	<b>5-145 to 5-168</b>
Scanning Range	5-145 to 5-147
Internal Beeper	5-148 to 5-149
RS-232C Port External Beeper	5-150 to 5-151
Beeper Volume	5-152 to 5-154
Beeper Frequency	5-155 to 5-157
Time-out Between Decodes, Same Symbol	5-158
Different Symbols	5-159
Decode Buffering	5-160 to 5-161
Rest Mode	5-162
Sleep Mode	5-163
Time Delay to Rest/Sleep Mode	5-164 to 5-167
Primary Decode Session Time	5-168

<b>Decode Options</b>	<b>5-169 to 5-199</b>
UPC/EAN Predecode Block	5-169 to 5-171
UPC/EAN Security Level	5-172 to 5-175
Linear UPC/EAN Decode	5-176 to 5-177
Linear Supplemental Decode	5-178 to 5-179
Decode Redundancy for UPC/EAN (only in Autodiscriminate Mode)	5-180
UPC/EAN Decode Performance	5-181 to 5-185
Linear Code Type Security Level	5-186 to 5-189
Code 128 Decode Performance	5-190 to 5-194
Code 39 Decode Performance	5-195 to 5-199
<b>Data Transmission Formats</b>	<b>5-200 to 5-245</b>
UPC-A Check Digit	5-200 to 5-201
UPC-E Check Digit	5-202 to 5-203
UPC-A Preamble	5-204 to 5-207
UPC-E Preamble	5-208 to 5-209
Convert UPC-E to UPC-A	5-210 to 5-211
EAN Zero Extend	5-212 to 5-213
Convert EAN-8 to EAN-13 Type	5-214 to 5-215
Convert I 2 of 5 to EAN-13	5-216 to 5-217
Transmit I 2 of 5 Check Digit	5-218 to 5-219
Transmit Code 39 Check Digit	5-220 to 5-221
Beep After Good Decode	5-222 to 5-223
Intercharacter Delay	5-224
Transmit Code ID Character	5-225 to 5-227
Pause Duration	5-228
Prefix/Suffix Values	5-229 to 5-232
Scan Data Transmission Format	5-233 to 5-242
Serial Data Transmission Format	5-238 to 5-242
Ignore Unknown Characters	5-243 to 5-244
Data Format Cancel	5-245



<b>Programming Utilities</b>	<b>5-246 to 5-264</b>
Numeric Bar Codes	5-246 to 5-255
Cancel	5-256
Enter	5-257
Application Items	5-258 to 5-264

## **Set Default Parameter**

Scanning this bar code returns all parameters to the values listed in the [Default Table](#) beginning on page 5-6.

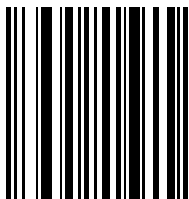

**SET ALL DEFAULTS**



## Default Table

Table 5-1. Default Table

Parameter	Default	Page
EAS Interlock	Disabled	5-12
<b>RS-232C Port Host Options</b>		
Baud Rate	9600	5-26
Parity	Even	5-29
Check Parity	Enable	5-33
Hardware Handshaking	None	5-37
Software Handshaking	None	5-42
Serial Response Time-out	2.0 seconds	5-47
Stop Bit Select	One	5-49
ASCII Format	8-Bit	5-50
Host Serial Line State	High	5-53
Beep on <BEL>	Disable	5-55
<b>RS-232C Port Auxiliary Options</b>		
Baud Rate	9600	5-63
Parity	Even	5-66
Check Parity	Enable	5-70
Hardware Handshaking	None	5-74
Software Handshaking	None	5-76
Serial Response Time-out	2.0 seconds	5-78
Stop Bit Select	One	5-79

Table 5-1. Default Table (cont'd)

Parameter	Default	Page
ASCII Format	8-Bit	5-82
Aux Serial Line State	Low	5-84
<b>Hand-Held Laser Scanner Options</b>		
Programming Mode	Program Primary Scanner Only	5-86
Beep After Good Decode	Disable	5-91
<b>Code Types &amp; Options</b>		
UPC-A	Enable	5-92
UPC-E	Enable	5-94
EAN-8	Enable	5-96
EAN-13	Enable	5-98
Bookland EAN	Disable	5-101
Decode UPC/EAN Supplementals	Ignore	5-102
UPC/EAN Coupon Code	Disable	5-106
Random Weight Check Digit	Disable	5-107
Code 128	Enable	5-110
UCC/EAN-128	Enable	5-112
Lengths for Code 128	Any Length	5-114
Code 39	Enable	5-115
Code 39 Full ASCII Conversion	Disable	5-119
Set Length(s) for Code 39	5 to 55	5-120
Code 39 Check Digit Verification	Disable	5-125



**Table 5-1. Default Table (cont'd)**

<b>Parameter</b>	<b>Default</b>	<b>Page</b>
<b>Interleaved 2 of 5</b>	Disable	5-127
<b>Set Length(s) for I 2 of 5</b>	14	5-128
<b>Codabar</b>	Disable	5-136
<b>Set Lengths for Codabar</b>	5-55	5-137
<b>CLSI Editing</b>	Disable	5-142
<b>NOTIS Editing</b>	Disable	5-144
<b>Custom Tailoring</b>		
<b>Scanning Range</b>	Full	5-145
<b>Internal Beeper</b>	Enable	5-148
<b>RS-232C Port External Beeper</b>	Disable	5-151
<b>Beeper Volume</b>	High	5-154
<b>Beeper Frequency</b>	High	5-157
<b>Time out between reads, same symbol</b>	0.6 seconds	5-158
<b>Time out between reads, different symbols</b>	0.2 seconds	5-159
<b>Decode Buffering</b>	Disable	5-161
<b>Time Delay to Rest/Sleep Mode</b>	30 minutes	5-165
<b>Primary Decode Session Time</b>	2.0 seconds	5-168



Table 5-1. Default Table (cont'd)

Parameter	Default	Page
<b>Decode Options</b>		
<b>Decode Security Measures:</b>		
- UPC/EAN Predecode block	Reject	5-170
- UPC/EAN Security	Level 0	5-172
- Linear UPC/EAN Decode	Disable	5-177
- Linear Supplemental Decode	Disable	5-179
<b>Decode UPC/EAN Redundncy (only when autodiscriminate mode is enabled)</b>	7	5-180
<b>UPC/EAN Decode Performance</b>	Enable, Level 3	5-185
<b>Linear Code Type Security</b>	Level 1	5-186
<b>Code 128 Decode Performance</b>	Enable, Level 3	5-194
<b>Code 39 Decode Performance</b>	Enable, Level 3 (for fixed length only)	5-199
<b>Data Transmission Formatting</b>		
<b>Transmit UPC-A Check Digit</b>	Enable	5-200
<b>Transmit UPC-E Check Digit</b>	Enable	5-202
<b>UPC-A Preamble</b>	System Char	5-205
<b>UPC-E Preamble</b>	System Char	5-208
<b>Convert UPC-E to A</b>	Disable	5-211
<b>EAN-8 Zero Extend</b>	Disable	5-213
<b>Convert EAN-8 to EAN-13 Type</b>	Type if EAN-13	5-214
<b>Convert I 2 of 5 to EAN-13</b>	Disable	5-217



**Table 5-1. Default Table (cont'd)**

<b>Parameter</b>	<b>Default</b>	<b>Page</b>
<b>Transmit I 2 of 5 Check Digit</b>	Disable	5-219
<b>Transmit Code 39 Check Digit</b>	Disable	5-221
<b>Beep After Good Decode</b>	Enable	5-222
<b>Intercharacter Delay</b>	0	5-224
<b>Transmit Code ID Character</b>	None	5-227
<b>Pause Duration</b>	0	5-228
<b>Prefix/Suffix Values</b>	7013 (<CR/LF> for serial)	5-229
<b>Scan Data Transmission Format</b>	Data as is	5-234
<b>Serial Data Transmission Format</b>	Data as is	5-239
<b>Ignore Unknown Characters</b>	Enable	5-243

## **EAS Interlock**

### **Enable EAS Interlock**

When enabled, the EAS tag is not de-activated until the associated bar code is decoded.



**ENABLE EAS INTERLOCK**



## **EAS Interlock**

### **Disable EAS Interlock**

When disabled (default), the EAS tag is de-activated independently of any bar code scanning.



**DISABLE EAS INTERLOCK**

## RS-232C Host Types

Select a Host Interface from the list below, then scan the corresponding bar code.



<b>Host Interface</b>	<b>Page</b>
No Host	5-14
RS-232C	
Single Port	5-15
Nixdorf	5-16
ICL	5-17
Fujitsu	5-18



## **RS-232C Host Types**

### **No Host**

When this bar code is scanned, the scanner decodes a bar code but does not transmit the data to the host.

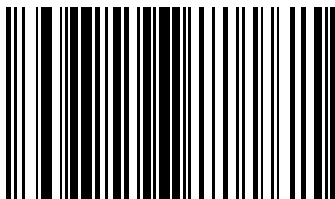

**NO HOST**

**RS-232C Host Types**  
**Single Port RS-232C Host**

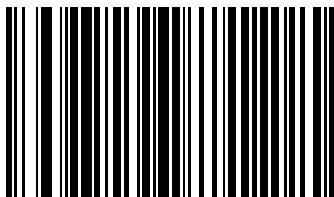

**SINGLE PORT RS-232C HOST**



## **RS-232C Host Types**

### **Nixdorf RS-232C Host**

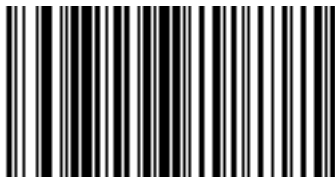

**Nixdorf RS-232C HOST**



## **RS-232C Host Types**

**ICL RS-232C Host**



**ICL RS-232C HOST**



## **RS-232C Host Types**

### **Fujitsu RS-232C Host**



**Fujitsu RS-232C HOST**

## RS-232C Port Host Options



The **RS-232C** port is used either as an output RS-232C host port or as an auxiliary RS-232C input port.

To use the **RS-232C** port as a host port:

1. Connect an RS-232C host device to this port.
2. Scan the **Single Port RS-232C Host** on page 5-15, or one of the terminal specific RS-232C Host bar codes on pages 5-16 to 5-18.
3. Use the programming bar codes on pages 5-20 to 5-55 to set the applicable parameters.

To use the **RS-232C** port as an auxiliary input port, see page 5-56.

If you are using an RS-232C host (single or dual port) connected to the **Host** port with a Synapse Smart Cable, and you wish to change any of the host parameters, use the **Synapse** parameters provided with the cable instructions.



## **RS-232C Port Host Options**

### **Baud Rate**



Baud rate is the number of bits of data transmitted per second. The scanner's baud rate setting should match the data rate setting of the host device. If not, data may not reach the host device or may reach it in distorted form. To select a baud rate of **110**, scan the bar code below. To select other baud rates, scan the corresponding bar code on the following pages.

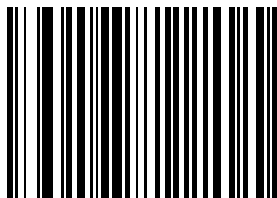

**BAUD RATE 110**

## **RS-232C Port Host Options**

**Baud Rate**

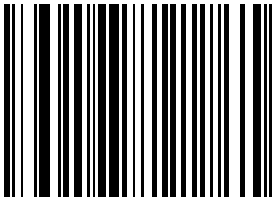

**BAUD RATE 300**



## **RS-232C Port Host Options**

### **Baud Rate**

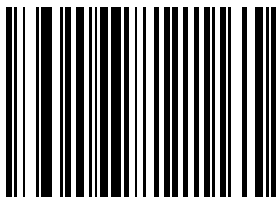

**BAUD RATE 600**

## **RS-232C Port Host Options**

**Baud Rate**

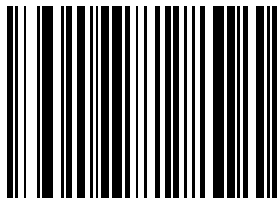

**BAUD RATE 1200**



## **RS-232C Port Host Options**

### **Baud Rate**

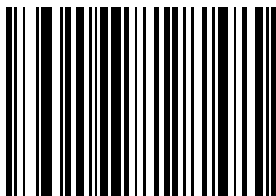

**BAUD RATE 2400**



## **RS-232C Port Host Options**

**Baud Rate**

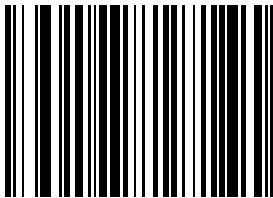

**BAUD RATE 4800**



## **RS-232C Port Host Options**

### **Baud Rate**

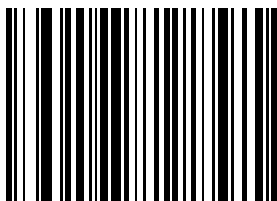

**BAUD RATE 9600**

## **RS-232C Port Host Options**

**Baud Rate**



**BAUD RATE 19200**



## **RS-232C Port Host Options**

### **Parity**

A parity check bit is the most significant bit of each ASCII coded character.



### **Odd**

If you select **ODD** parity, the parity bit has a value 0 or 1, based on data, to ensure that an odd number of 1 bits are contained in the coded character.

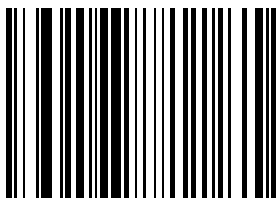

**ODD**

## RS-232C Port Host Options

### Parity

#### Even

If you select **EVEN** parity, the parity bit has a value 0 or 1, based on data, to ensure that an even number of 1 bits are contained in the coded character.

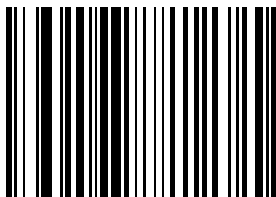

**EVEN**



## **RS-232C Port Host Options**

### **Parity**

### **Mark**



Select **MARK** parity and the parity bit is always 1.

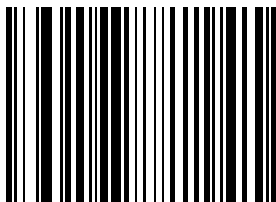

**MARK**

## **RS-232C Port Host Options**

**Parity**

**Space**



Select **SPACE** parity and the parity bit is always 0.

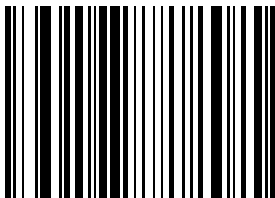

**SPACE**



## **RS-232C Port Host Options**

**Parity**

**None**



If no parity is required, select **NONE**.

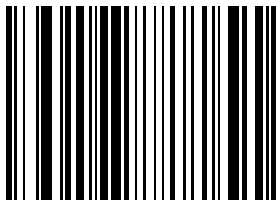

**NONE**



## **RS-232C Port Host Options**

### **Check Parity**



Select whether or not the parity of received characters is checked. The type of parity used is selectable through the **PARITY** parameter.

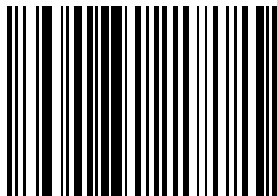

**CHECK PARITY**



## **RS-232C Port Host Options**

### **Do Not Check Parity**

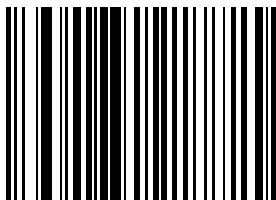

**DO NOT CHECK PARITY**

## RS-232C Port Host Options

### Hardware Handshaking



The data interface consists of an RS-232C port. The port has been designed to operate either with or without the hardware handshaking lines, *Request to Send (RTS)*, and *Clear to Send (CTS)*.

If Standard RTS/CTS handshaking is selected, scan data is transmitted according to the following sequence:

- The controller reads the CTS line for activity. If CTS is asserted, the controller waits up to 2 seconds for the host to negate the CTS line. If, after 2 seconds the CTS line is still asserted, the scanner sounds a transmit error and any scanned data is lost.
- When the CTS line is negated, the controller asserts the RTS line and waits up to 2 seconds for the host to assert CTS. When the host asserts CTS, data is transmitted. If, after 2 seconds, the CTS line is not asserted, the scanner sounds a transmit error and discards the data.
- When data transmission is complete, the controller negates RTS 10 msec after sending the last character.
- The host should respond by negating CTS. The controller checks for a negated CTS upon the next transmission of data.



## **RS-232C Port Host Options**

### **Hardware Handshaking**



During the transmission of data, the CTS line should be asserted. If CTS is de-asserted for more than 50 msec between characters, the transmission is aborted, the scanner sounds a transmission error, and the data is discarded.

If the above communications sequence fails, the scanner issues an error indication. In this case, the data is lost and must be rescanned.

**Note:** The DTR signal is jumpered active.

## **RS-232C Port Host Options**

### **Hardware Handshaking**



#### **None**

Scan the bar code below if no Hardware Handshaking is desired.

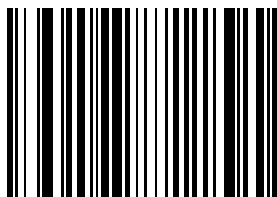

**NONE**



## **RS-232C Port Host Options**

### **Hardware Handshaking**

#### **Standard**

Scan the bar code below to select Standard  
RTS/CTS Hardware Handshaking.

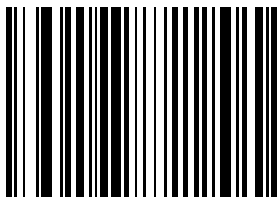

**STANDARD RTS/CTS**

## **RS-232C Port Host Options**

### **Hardware Handshaking**

#### **RTS/CTS Option 1**



When RTS/CTS Option 1 is selected, the scanner asserts RTS before transmitting and ignores the state of CTS. The scanner de-asserts RTS when the transmission is complete.

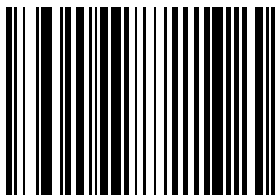

**RTS/CTS OPTION 1**



## **RS-232C Port Host Options**

### **Hardware Handshaking**

#### **RTS/CTS Option 2**



When Option 2 is selected, RTS is always high or low (user-programmed logic level). However, the scanner waits for CTS to be asserted before transmitting data. If CTS is not asserted within 2 seconds, the scanner issues an error indication and discards the data.

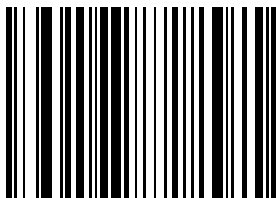

**RTS/CTS OPTION 2**



## **RS-232C Port Host Options**

### **Hardware Handshaking**

#### **RTS/CTS Option 3**



When Option 3 is selected, the scanner asserts RTS prior to any data transmission, regardless of the state of CTS. The scanner waits up to 2 seconds for CTS to be asserted. If CTS is not asserted during this time, the scanner issues an error indication and discards the data. The scanner de-asserts RTS when transmission is complete.

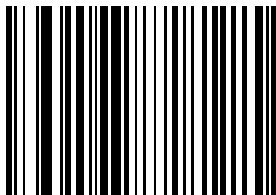

**RTS/CTS OPTION 3**



## **RS-232C Port Host Options**

### **Software Handshaking**



This parameter offers control of the data transmission process in addition to, or instead of, that offered by hardware handshaking.

#### **NONE**

When this option is selected, data is transmitted immediately.

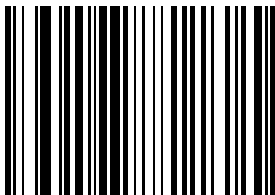

**NONE**

## RS-232C Port Host Options

### Software Handshaking



#### ACK/NAK

When this option is selected, after transmitting data, the scanner expects either an ACK or NAK response from the host. Whenever a NAK is received, the scanner transmits the same data again and waits for either an ACK or NAK. After three unsuccessful attempts to send data when NAKs are received, the scanner issues an error indication and discards the data.

The scanner waits up to the programmable Host Serial Response Time-out to receive an ACK or NAK. If the scanner does not get a response in this time, it issues an error indication and discards the data. There are no retries when a time-out occurs.

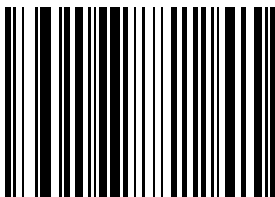

ACK/NAK



## **RS-232C Port Host Options**

### **Software Handshaking**



#### **ENQ**

When this option is selected, the scanner waits for an ENQ character from the host before transmitting data. If an ENQ is not received within 2 seconds, the scanner issues an error indication and discards the data. The host must transmit an ENQ character at least every 2 seconds to prevent transmission errors.

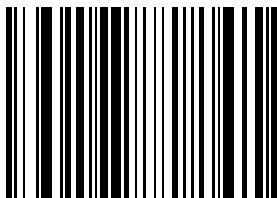

**ENQ**

## **RS-232C Port Host Options**

### **Software Handshaking**

#### **ACK/NAK with ENQ**

This combines the 2 previous options.

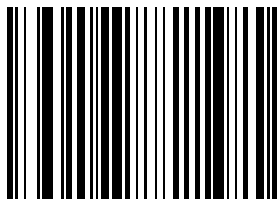

**ACK/NAK with ENQ**



## RS-232C Port Host Options

### Software Handshaking

#### XON/XOFF



An XOFF character turns the scanner transmission off until the scanner receives an XON character. There are two situations for XON/XOFF:

- XOFF is received before the scanner has data to send. When the scanner has data to send, it then waits for an XON character before transmission. The scanner waits up to 2 seconds to receive the XON. If the XON is not received within this time, the scanner issues an error indication and discards the data.
- XOFF is received during a transmission. Data transmission then stops after sending the current byte. When the scanner receives an XON character, it sends the rest of the data message. The scanner waits indefinitely for the XON.

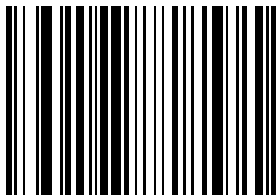

XON/XOFF

## **RS-232C Port Host Options**

### **Serial Response Time-out**



This parameter determines the maximum period allowed to elapse before the scanner assumes end of transmission. The delay period can range from 0.0 to 9.9 seconds in .1 second increments. After scanning the bar code below, scan two bar codes on pages 5-246 to 5-255 to set the desired time-out.

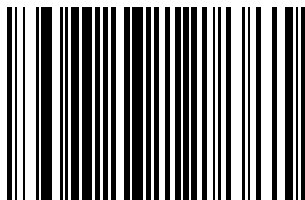

**SERIAL RESPONSE TIME-OUT**



## **RS-232C Port Host Options**

### **Stop Bit Select**



The stop bit(s) at the end of each transmitted character marks the end of transmission of one character and prepares the receiving device for the next character in the serial data stream. The number of stop bits selected (one or two) depends on the number the receiving terminal is programmed to accommodate. Set the number of stop bits to match those device requirements.

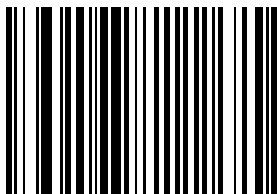

**1 STOP BIT**



## **RS-232C Port Host Options**

### **Stop Bit Select**

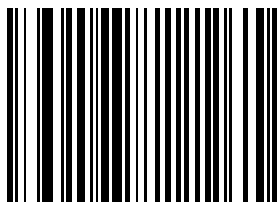

**2 STOP BITS**



## **RS-232C Port Host Options**

### **ASCII Format**



Data is normally transmitted in 7-bit ASCII format. This parameter allows the scanner to interface with devices requiring an 8-bit ASCII protocol.

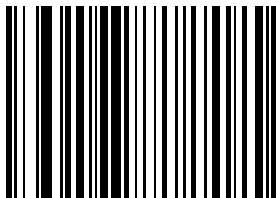

**7-BIT**

## **RS-232C Port Host Options**

### **ASCII Format**

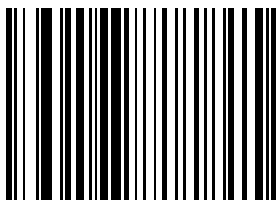

**8-BIT**



## **RS-232C Port Host Options**

### **Serial Host RTS Line State**



This parameter is used to set the idle state of the Serial Host RTS line. To select **HIGH RTS** line state, scan the bar code below.



**HOST: HIGH RTS**

**RS-232C Port Host Options**  
**Serial Host RTS Line State**



**HOST: LOW RTS**



## **RS-232C Port Host Options**

### **Beep on <BEL>**



When this parameter is enabled, the scanner issues a beep when a <BEL> character is detected on the RS-232C serial line. <BEL> is issued to gain a user's attention to indicate an illegal entry or other important event.

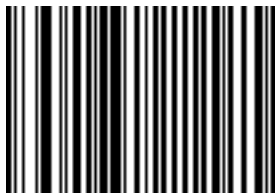

**BEEP ON <BEL> CHARACTER**

## **RS-232C Port Host Options**

**Do Not Beep on <BEL>**

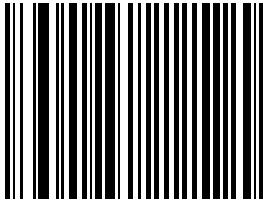

**DO NOT BEEP ON <BEL> CHARACTER**



## RS-232C Port Auxiliary Options

The **RS-232C** port is used either as an output RS-232C host port or as an input auxiliary RS-232C port.

To use the **RS-232C** port as an auxiliary RS-232C input port:

1. Connect the auxiliary device (scale, magstripe reader, etc.) to this port.
2. Use the programming bar codes on pages 5-57 to 5-84 to set the applicable RS-232C auxiliary parameters.

To use the **Host** port and **RS-232C** port:

1. Connect a host device such as an OCIA terminal to the **Host** port and an RS-232C device, such as a portable terminal or scale to the **RS-232C** port.
2. Use the programming bar codes on pages 5-57 to 5-84 to set the applicable RS-232C auxiliary parameters.

Connecting to two RS-232C devices:

- Connect an RS-232C device to the **Host** port using a Synapse™ Smart Cable, and another RS-232C device, requiring different parameters (baud rate, parity, etc.) to the **RS-232C** port. In this case, the device connected to the **Host** port would use the **Synapse** parameters provided with the cable instructions. The device connected to the **RS-232C** port would use the **RS-232C Port** parameters on pages 5-57 to 5-84.

To use the **RS-232C** port as an output host port, see page 5-19.



## RS-232C Port Auxiliary Options

### Baud Rate



Baud rate is the number of bits of data transmitted per second. The scanner's baud rate setting should match the data rate setting of the host device. If not, data may not reach the host device or may reach it in distorted form. To select a baud rate of **110**, scan the bar code below. To select other baud rates, scan the corresponding bar code on the following pages.

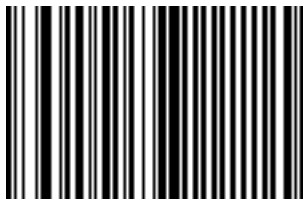

**BAUD RATE 110**



## **RS-232C Port Auxiliary Options**

### **Baud Rate**

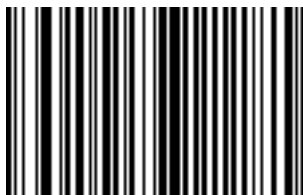

**BAUD RATE 300**

## **RS-232C Port Auxiliary Options**

**Baud Rate**

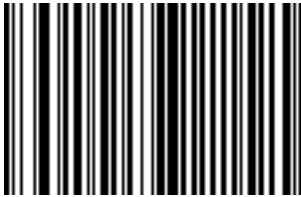

**BAUD RATE 600**



## **RS-232C Port Auxiliary Options**

### **Baud Rate**



**BAUD RATE 1200**

## **RS-232C Port Auxiliary Options**

**Baud Rate**



**BAUD RATE 2400**



## **RS-232C Port Auxiliary Options**

### **Baud Rate**



**BAUD RATE 4800**

## **RS-232C Port Auxiliary Options**

**Baud Rate**

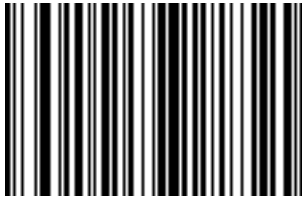

**BAUD RATE 9600**



## **RS-232C Port Auxiliary Options**

### **Baud Rate**

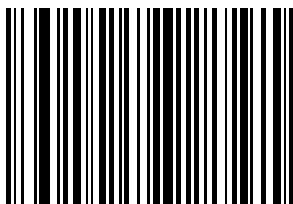

**BAUD RATE 19200**



## RS-232C Port Auxiliary Options

### Parity



A parity check bit is the most significant bit of each ASCII coded character.

### Odd

If you select **ODD** parity, the parity bit has a value 0 or 1, based on data, to ensure that an odd number of 1 bits are contained in the coded character.

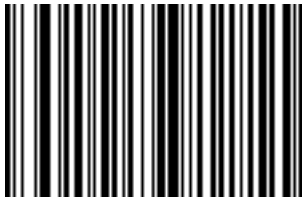

ODD



## **RS-232C Port Auxiliary Options**

### **Parity**



#### **Even**

If you select **EVEN** parity, the parity bit has a value 0 or 1, based on data, to ensure that an even number of 1 bits are contained in the coded character.



**EVEN**

## **RS-232C Port Auxiliary Options**

**Parity**

**Mark**



Select **MARK** parity and the parity bit is always 1.



**MARK**



## **RS-232C Port Auxiliary Options**

### **Parity**

### **Space**



Select **SPACE** parity and the parity bit is always 0.



**SPACE**

## **RS-232C Port Auxiliary Options**

**Parity**

**None**



If no parity is required, select **NONE**.



**NONE**



## **RS-232C Port Auxiliary Options**

### **Check Parity**



Select whether or not the parity of received characters is checked. The type of parity used is selectable through the **PARITY** parameter.

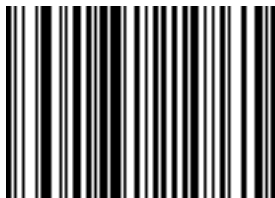

**CHECK PARITY**

## **RS-232C Port Auxiliary Options**

**Do Not Check Parity**



**DO NOT CHECK PARITY**



## RS-232C Port Auxiliary Options

### Hardware Handshaking



The data interface consists of an RS-232C port.

The port has been designed to operate either with or without the hardware handshaking lines, *Request to Send (RTS)*, and *Clear to Send (CTS)*.

If Standard RTS/CTS handshaking is selected, scan data is transmitted according to the following sequence:

- The controller reads the CTS line for activity. If CTS is asserted, the controller waits up to 2 seconds for the host to negate the CTS line. If, after 2 seconds the CTS line is still asserted, the scanner sounds a transmit error and any scanned data is lost.
- When the CTS line is negated, the controller asserts the RTS line and waits up to 2 seconds for the host to assert CTS. When the host asserts CTS, data is transmitted. If, after 2 seconds, the CTS line is not asserted, the scanner sounds a transmit error and discards the data.
- When data transmission is complete, the controller negates RTS 10 msec after sending the last character.
- The host should respond by negating CTS. The controller checks for a negated CTS upon the next transmission of data.



## RS-232C Port Auxiliary Options

### Hardware Handshaking



During the transmission of data, the CTS line should be asserted. If CTS is de-asserted for more than 50 msec between characters, the transmission is aborted, the scanner sounds a transmission error, and the data is discarded.

If the above communications sequence fails, the scanner issues an error indication. In this case, the data is lost and must be rescanned.

**Note:** The DTR signal is jumpered active.



## **RS-232C Port Auxiliary Options**

### **Hardware Handshaking**



#### **None**

Scan the bar code below if no Hardware Handshaking is desired.



**NONE**

## **RS-232C Port Auxiliary Options**

### **Hardware Handshaking**

#### **Standard RTS/CTS**



Scan the bar code below to select Standard RTS/CTS  
Hardware Handshaking.

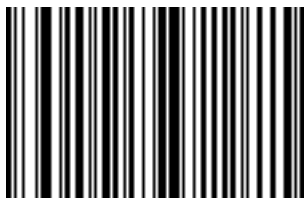

**STANDARD RTS/CTS**



## **RS-232C Port Auxiliary Options**

### **Software Handshaking**



This parameter offers control of the data transmission process in addition to, or instead of, that offered by hardware handshaking.

#### **NONE**

When this option is selected, data is transmitted immediately.



**NONE**

## RS-232C Port Auxiliary Options

### Software Handshaking



#### ON/XOFF

An XOFF character turns the scanner transmission off until the scanner receives an XON character. There are two situations for XON/XOFF:

- **XOFF is received before the scanner has data to send.** When the scanner has data to send, it then waits for an XON character before transmission. The scanner waits up to 2 seconds to receive the XON. If the XON is not received within this time, the scanner issues an error indication and discards the data.
- **XOFF is received during a transmission.** Data transmission then stops after sending the current byte. When the scanner receives an XON character, it sends the rest of the data message. The scanner waits indefinitely for the XON.



XON/XOFF



## **RS-232C Port Auxiliary Options**

### **Serial Response Time-out**



This parameter determines the maximum period allowed to elapse before the scanner assumes end of transmission. The delay period can range from 0.0 to 9.9 seconds in .1 second increments. After scanning the bar code below, scan two bar codes on pages 5-246 to 5-255 to set the desired time-out.



**SERIAL RESPONSE TIME-OUT**

## RS-232C Port Auxiliary Options

### Stop Bit Select



The stop bit(s) at the end of each transmitted character marks the end of transmission of one character and prepares the receiving device for the next character in the serial data stream. The number of stop bits (one or two) selected depends on the number the receiving terminal is programmed to accommodate. Set the number of stop bits to match those device requirements.



1 STOP BIT



## **RS-232C Port Auxiliary Options**

### **Stop Bit Select**



**2 STOP BITS**



## **RS-232C Port Auxiliary Options**

### **ASCII Format**



Data is normally transmitted in 7-bit ASCII format. This parameter allows the scanner to interface with devices requiring an 8-bit ASCII protocol.



**7-BIT**



## **RS-232C Port Auxiliary Options ASCII Format**



**8-BIT**

## **RS-232C Port Auxiliary Options**

### **RTS Line State**



This parameter is used to set the idle state of the Auxiliary Serial RTS line. To select **HIGH RTS** line state, scan the bar code below.

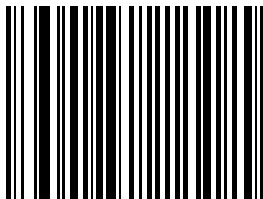

**AUXILIARY: HIGH RTS**



## **RS-232C Port Auxiliary Options**

### **RTS Line State**

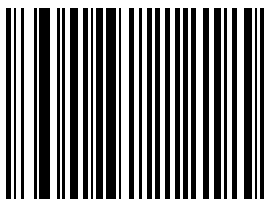

**AUXILIARY: LOW RTS**

## Hand-Held Laser Scanner Options

### Program Hand-Held Scanner Only



When this mode is enabled, parameter bar codes scanned change the settings on the hand-held laser scanner only. The LS 5700/LS 5800 (primary scanner) is not affected. Any changes made to the decode parameters (i.e., code types, lengths or check digits) are not recognized by the primary scanner. However, if any of these parameters on the primary scanner is changed, the change overrides the hand-held scanner setting.

**This parameter does not apply to LS 2603MX, LS 3603MX, or LS 3203 scanners.**



**PROGRAM HAND-HELD SCANNER ONLY**



## Hand-Held Laser Scanner Options

### Program Primary Scanner Only



When this mode is enabled, parameter bar codes scanned only change the settings on the primary scanner (LS 5700/LS 5800). They do not affect the hand-held laser scanner. Any changes made to the decode parameters (i.e., code types, lengths or check digits) are reflected back to the hand-held scanner as well. This mode is useful for programming the primary scanner using the hand-held scanner.

**This parameter does not apply to LS 2603MX, LS 3603MX, or LS 3203 scanners.**



**PROGRAM PRIMARY SCANNER ONLY**

## Hand-Held Laser Scanner Options

### Program Hand-Held Scanner Only

#### LS 2603MX/LS 3603MX/LS 3203 Only



When this mode is enabled, parameter bar codes scanned change the settings on the hand-held laser scanner only. The LS 5700/LS 5800 (primary scanner) is not affected. Any changes made to the decode parameters (i.e., code types, lengths or check digits) are not recognized by the primary scanner. However, if any of these parameters on the primary scanner is changed, the change overrides the hand-held scanner setting.



**PROGRAM HAND-HELD SCANNER ONLY**



## **Hand-Held Laser Scanner Options**

### **Program Primary Scanner Only**



#### **LS 2603MX/LS 3603MX/LS 3203 Only**

When this mode is enabled, parameter bar codes scanned only change the settings on the primary scanner (LS 5700/LS 5800). They do not affect the hand-held laser scanner. Any changes made to the decode parameters (i.e., code types, lengths or check digits) are reflected back to the hand-held scanner as well. This mode is useful for programming the primary scanner using the hand-held scanner.



**PROGRAM PRIMARY SCANNER ONLY**



## Hand-Held Laser Scanner Options



### Program All Scanners

When this mode is enabled, parameter bar codes scanned change the settings on the primary scanner (LS 5700/LS 5800) and the hand-held scanner. If either scanner does not recognize a particular parameter bar code (the parameter was not meant for that scanner), that scanner emits an error beep. The other scanner emits a warble tone.



**PROGRAM ALL SCANNERS**



## **Hand-Held Laser Scanner Options**

### **Beep After Good Decode**



This parameter affects the hand-held scanner only. When enabled, the scanner plugged into the Scanner port beeps after a successful decode.



**BEEP AFTER GOOD DECODE**

## **Hand-Held Laser Scanner Options**



### **Do Not Beep After Good Decode**

This parameter affects the hand-held scanner only. When disabled, the scanner plugged into the Scanner port does not beep after a successful decode. Beeps for parameter menu scanning and serial communications are not affected.



**DO NOT BEEP AFTER GOOD DECODE**



## **Code Types & Options**

### **UPC-A**

To enable UPC-A scan the bar code below.



**ENABLE UPC-A**

## **Code Types & Options**

### **Disable UPC-A**

To disable UPC-A scan the bar code below.

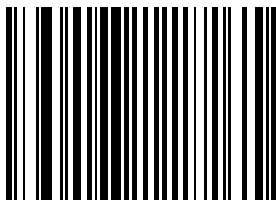

**DISABLE UPC-A**



## **Code Types & Options**

### **UPC-E**

To enable UPC-E scan the bar code below.

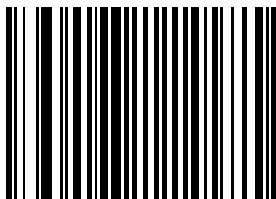

**ENABLE UPC-E**

## **Code Types & Options**

### **Disable UPC-E**

To disable UPC-E scan the bar code below.

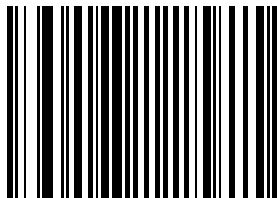

**DISABLE UPC-E**



## **Code Types & Options**

### **EAN-8**

To enable EAN-8 scan the bar code below.

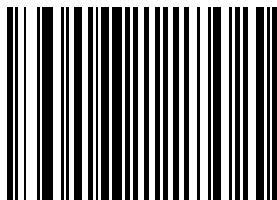

**ENABLE EAN-8**



## **Code Types & Options**

### **Disable EAN-8**

To disable EAN-8 scan the bar code below.

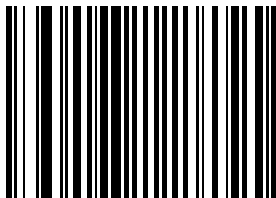

**DISABLE EAN-8**



## **Code Types & Options**

### **EAN-13**

To enable EAN-13 scan the bar code below.

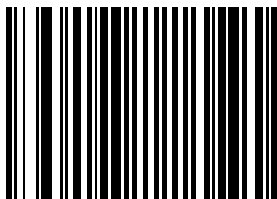

**ENABLE EAN-13**

## **Code Types & Options**

### **Disable EAN-13**

To disable EAN-13 scan the bar code below.

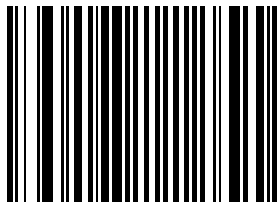

**DISABLE EAN-13**



## **Code Types & Options**

### **Bookland EAN**

A Bookland EAN symbol is an EAN 13 bar code containing a leading “978” prefix. The symbol may contain a five-digit supplemental. The first digit is a currency code, and the remaining four are a price digit code. When scanning this code type, enabling **Autodiscriminate UPC/EAN With Supplementals** on page 5-104 is recommended.



**ENABLE BOOKLAND EAN**

## **Code Types & Options**

### **Disable Bookland EAN**

To disable Bookland EAN scan the bar code below.



**DISABLE BOOKLAND EAN**



## Code Types & Options

### Decode UPC/EAN Supplementals

Supplementals are additionally appended characters (2 or 5) according to specific code format conventions (e.g., UPC A+2, UPC E+2, EAN 8+2). Three options are available.

- If UPC/EAN with supplemental characters is selected, UPC/EAN symbols without supplemental characters are not decoded.
- An autodiscriminate option is also available.

**Note:** In order to minimize the risk of invalid data transmission, it is recommended that you select whether to read or ignore supplemental characters.

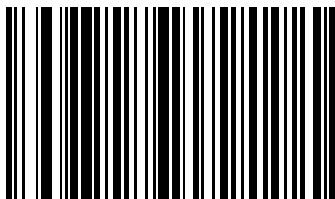

**DECODE UPC/EAN WITH SUPPLEMENTALS**

## Code Types & Options

### Ignore UPC/EAN With Supplementals

Supplementals are additionally appended characters (2 or 5) according to specific code format conventions (e.g., UPC A+2, UPC E+2, EAN 8+2). Three options are available.

- If UPC/EAN without supplemental characters is selected, and the scanner is presented with a UPC/EAN plus supplemental symbol, the UPC/EAN are decoded and the supplemental characters ignored.
- An autodiscriminate option is also available.

**Note:** In order to minimize the risk of invalid data transmission, it is recommended that you select whether to read or ignore supplemental characters.

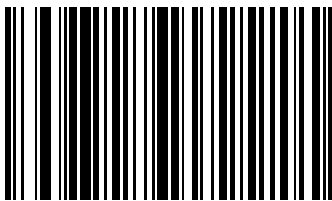

DECODE UPC/EAN WITHOUT SUPPLEMENTALS



## **Code Types & Options**

### **Autodiscriminate UPC/EAN With Supplementals**

**Note:** In order to minimize the risk of invalid data transmission, it is recommended that you select whether to read or ignore supplemental characters.

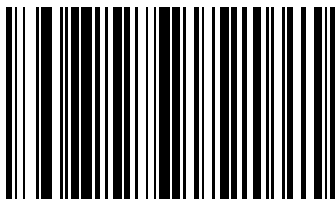

**AUTODISCRIMINATE UPC/EAN WITH SUPPLEMENTALS**



## Code Types & Options

### UCC/EAN Coupon Code

When enabled, this parameter decodes UPC-A, UPC-A with 2 supplemental characters, UPC-A with 5 supplemental characters, and UPC-A/EAN-128 bar codes.

To enable this code type:

1. Scan the bar code below.
2. Scan *AUTODISCRIMINATE UPC/EAN WITH SUPPLEMENTALS* on page 5-104.

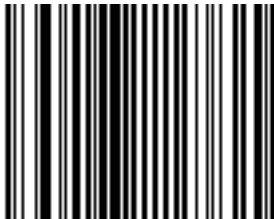

**ENABLE UPC/EAN COUPON CODE**



## **Code Types & Options**

### **Disable UCC/EAN Coupon Code**



**DISABLE UPC/EAN COUPON CODE**

## **Code Types & Options**

### **Random Weight Check Digit**

A 4-digit or 5-digit random weight check digit may be embedded in a UPC-A or EAN-13 bar code for added price verification. To enable either of these options, or to disable this parameter entirely, scan the appropriate bar code below, or on the following pages.

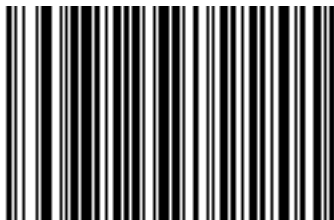

**DISABLE RANDOM WEIGHT CHECK DIGIT**



## **Code Types & Options**

### **Random Weight Check Digit**



**ENABLE 4-DIGIT RANDOM WEIGHT CHECK DIGIT**

## **Code Types & Options**

### **Random Weight Check Digit**

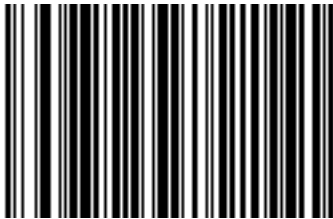

**ENABLE 5-DIGIT RANDOM WEIGHT CHECK DIGIT**



## **Code Types & Options**

### **Code 128**

To enable Code 128, scan the bar code below.

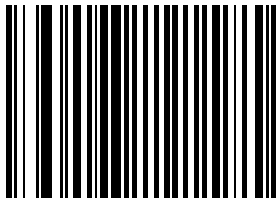

**ENABLE CODE 128**

## **Code Types & Options**

### **Disable Code 128**

To disable Code 128, scan the bar code below.

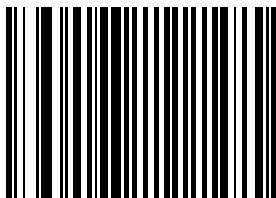

**DISABLE CODE 128**



## **Code Types & Options**

### **UCC/EAN-128**

To enable UCC/EAN-128, scan the bar code below.

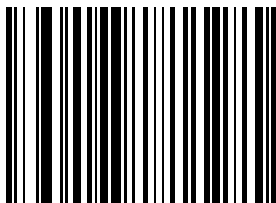

**ENABLE UCC/EAN-128**



## **Code Types & Options**

### **Disable UCC/EAN-128**

To disable UCC/EAN-128, scan the bar code below.

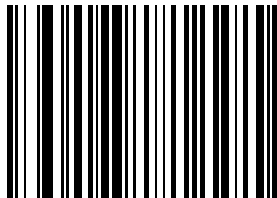

**DISABLE UCC/EAN-128**



## **Code Types & Options**

### **Lengths for Code 128**

No length setting is required for Code 128. The default setting is Any Length.

## **Code Types & Options**

### **Code 39**

To enable Code 39 scan the bar code below.

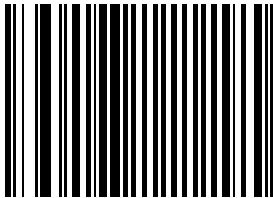

**ENABLE CODE 39**



## **Code Types & Options**

### **Disable Code 39**

To disable Code 39 scan the bar code below.

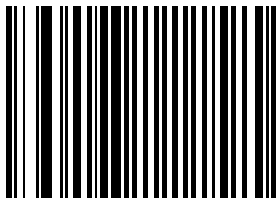

**DISABLE CODE 39**

## Code Types & Options

### Code 39 Full ASCII

To enable or disable Code 39 Full ASCII, scan the appropriate bar code on the following pages.

When enabled, the ASCII character set assigns a code to letters, punctuation marks, numerals, and most control keystrokes on the keyboard.

The first 32 codes are non-printable and are assigned to keyboard control characters such as BACKSPACE and RETURN. The other 96 are called printable codes because all but SPACE and DELETE produce visible characters.

Code 39 Full ASCII interprets the bar code special character (\$ + % /) preceding a Code 39 character and assigns an ASCII character value to the pair. For example, when Code 39 Full ASCII is enabled and a +**B** is scanned, it is interpreted as **b**, %**J** as **?**, and **\$H** emulates the keystroke **BACKSPACE**. Scanning **ABC\$M** outputs the keystroke equivalent of **ABC ENTER**. Refer to [Table A-4](#) in the *Appendix* to this guide.

The scanner does not autodiscriminate between Code 39 and Code 39 Full ASCII.



## **Code Types & Options**

### **Enable Code 39 Full ASCII**

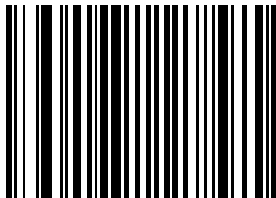

**ENABLE CODE 39 FULL ASCII**

## **Code Types & Options**

### **Disable Code 39 Full ASCII**

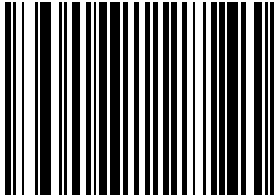

**DISABLE CODE 39 FULL ASCII**



## Code Types & Options

### Set Lengths for Code 39

Lengths for Code 39 may be set for any length, one or two discrete lengths, or lengths within a specific range. The length of a code refers to the number of characters (i.e., human readable characters) the code contains.

**One Discrete Length** - This option allows you to decode only those codes containing a selected length. For example, if you select **Code 39 One Discrete Length**, then scan **1, 4**, only Code 39 symbols containing 14 characters are decoded. Numeric bar codes are on pages 5-246 to 5-255. If you make a mistake, scan **CANCEL** on page 5-256.

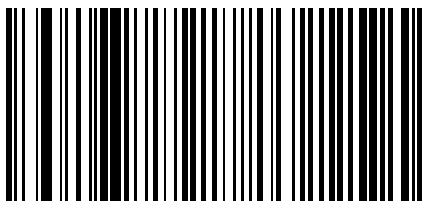

CODE 39 - ONE DISCRETE LENGTH



## Code Types & Options

### Set Lengths for Code 39

**Two Discrete Lengths** - This option allows you to decode only those codes containing two selected lengths. For example, if you select **Code 39 Two Discrete Lengths**, then scan **0, 2, 1, 4**, only Code 39 symbols containing 2 or 14 characters are decoded. Numeric bar codes are on pages 5-246 to 5-255. If you make a mistake, scan **CANCEL** on page 5-256.

**Note:** Selecting this option disables Code 39 Decode Performance.

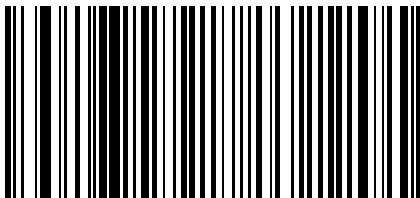

**CODE 39 - TWO DISCRETE LENGTHS**



## Code Types & Options

### Set Lengths for Code 39

**Length Within Range** - This option allows you to decode a code type within a specified range. For example to decode Code 39 symbols containing between 4 and 12 characters, first scan **Code 39 Length Within Range**. Then scan **0, 4, 1, and 2** (single digit numbers must always be preceded by a leading zero). Numeric bar codes are on pages 5-246 to 5-255. If you make a mistake, scan **CANCEL** on page 5-256.

**Note:** Selecting this option disables Code 39 Decode Performance.

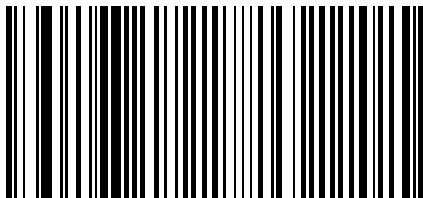

**CODE 39 - LENGTH WITHIN RANGE**

## **Code Types & Options**

### **Set Lengths for Code 39**

**Any Length** - Scanning this option allows you to decode Code 39 symbols containing any number of characters.

**Note:** Selecting this option disables Code 39 Decode Performance.

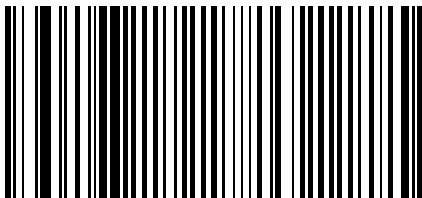

**CODE 39 - ANY LENGTH**



## **Code Types & Options**

### **Code 39 Check Digit Verification**

When enabled, this parameter checks the integrity of a Code 39 symbol to ensure it complies with specified algorithms.

Only those Code 39 symbols which include a modulo 43 check digit are decoded when this parameter is enabled.

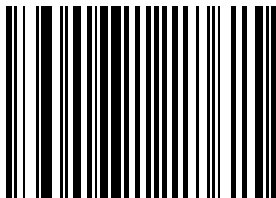

**ENABLE CODE 39 CHECK DIGIT**

**Code Types & Options**  
**Disable Code 39 Check Digit**

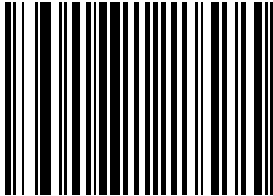

**DISABLE CODE 39 CHECK DIGIT**



## **Code Types & Options**

### **Interleaved 2 of 5**

To enable Interleaved 2 of 5, scan the bar code below.

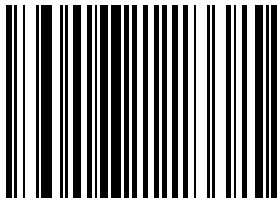

**ENABLE I 2 OF 5**

## **Code Types & Options**

**Disable | 2 of 5**

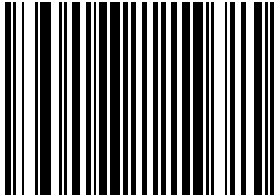

**DISABLE | 2 OF 5**



## Code Types & Options

### Set Lengths for Interleaved 2 of 5

Lengths for I 2 of 5 may be set for any length, one or two discrete lengths, or lengths within a specific range. The length of a code refers to the number of characters (i.e., human readable characters) the code contains.

**One Discrete Length** - This option allows you to decode only those codes containing a selected length. For example, if you select **I 2 of 5 One Discrete Length**, then scan **1, 4**, only I 2 of 5 symbols containing 14 characters are decoded. Numeric bar codes are on pages 5-246 to 5-255. If you make a mistake, scan **CANCEL** on page 5-256.

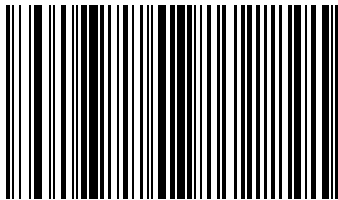

**I 2 of 5 - ONE DISCRETE LENGTH**



## Code Types & Options

### Set Lengths for Interleaved 2 of 5

**Two Discrete Lengths** - This option allows you to decode only those codes containing two selected lengths. For example, if you select **I 2 of 5 Two Discrete Lengths**, then scan **0, 2, 1, 4**, only I 2 of 5 symbols containing 2 or 14 characters are decoded. Numeric bar codes are on pages 5-246 to 5-255. If you make a mistake, scan **CANCEL** on page 5-256.

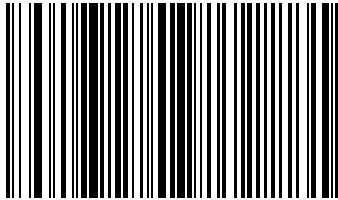

**I 2 of 5 - TWO DISCRETE LENGTHS**



## Code Types & Options

### Set Lengths for Interleaved 2 of 5

**Length Within Range** - This option allows you to decode a code type within a specified range. For example to decode I 2 of 5 symbols containing between 4 and 12 characters, first scan **I 2 of 5 Length Within Range**. Then scan **0, 4, 1,** and **2** (single digit numbers must always be preceded by a leading zero). Numeric bar codes are on pages 5-246 to 5-255. If you make a mistake, scan **CANCEL** on page 5-256.

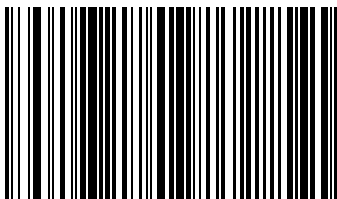

**I 2 of 5 - LENGTH WITHIN RANGE**

## **Code Types & Options**

### **Set Lengths for Interleaved 2 of 5**

**Any Length** - Scanning this option allows you to decode I 2 of 5 symbols containing any number of characters.

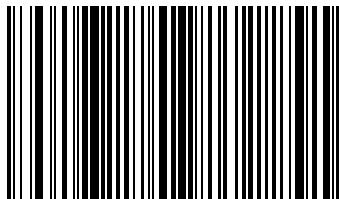

**I 2 of 5 ANY LENGTH**



## **Code Types & Options**

### **I 2 of 5 Check Digit Verification - USS**

When enabled, this parameter checks the integrity of an I 2 of 5 symbol to ensure it complies with a specified algorithm, either USS (Uniform Symbology Specification), or OPCC (Optical Product Code Council).



**USS CHECK DIGIT**

## **Code Types & Options**

### **OPCC Check Digit Verification - OPCC**

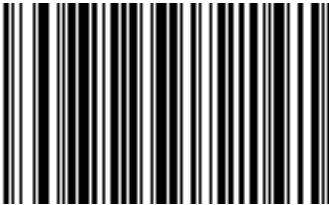

**OPCC CHECK DIGIT**



## **Code Types & Options**

### **I 2 of 5 Check Digit Verification**



**DISABLE I 2 OF 5 CHECK DIGIT VERIFICATION**

## **Code Types & Options**

### **Codabar**

To enable Codabar, scan the bar code below.

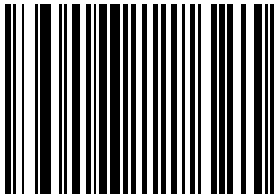

**ENABLE CODABAR**



## **Code Types & Options**

### **Disable Codabar**

To disable Codabar, scan the symbol below.

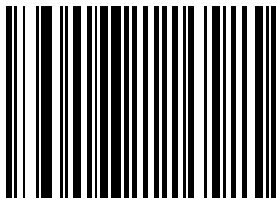

**DISABLE CODABAR**



## Code Types & Options

### Set Lengths for Codabar

Lengths for Codabar may be set for any length, one or two discrete lengths, or lengths within a specific range. The length of a code refers to the number of characters (i.e., human readable characters) the code contains.

**One Discrete Length** - This option allows you to decode only those codes containing a selected length. For example, if you select **Codabar One Discrete Length**, then scan **1, 4**, only Codabar symbols containing 14 characters are decoded. Numeric bar codes are on pages 5-246 to 5-255. If you make a mistake, scan **CANCEL** on page 5-256.

**Note:** Codabar lengths include start and stop characters.

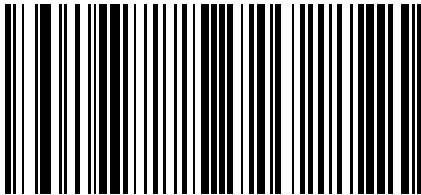

**CODABAR - ONE DISCRETE LENGTH**



## **Code Types & Options**

### **Set Lengths for Codabar**

**Two Discrete Lengths** - This option allows you to decode only those codes containing two selected lengths. For example, if you select **Codabar Two Discrete Lengths**, then scan **0, 2, 1, 4**, only Codabar symbols containing 2 or 14 characters are decoded. Numeric bar codes are on pages 5-246 to 5-255. If you make a mistake, scan **CANCEL** on page 5-256.

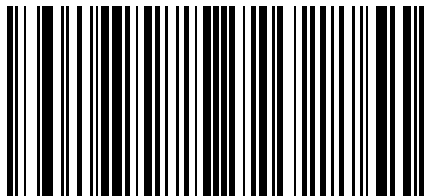

**CODABAR - TWO DISCRETE LENGTHS**

## Code Types & Options

### Set Lengths for Codabar

**Length Within Range** - This option allows you to decode a code type within a specified range. For example to decode Codabar symbols containing between 4 and 12 characters, first scan **Codabar Length Within Range**. Then scan **0, 4, 1,** and **2** (single digit numbers must always be preceded by a leading zero). Numeric bar codes are on pages 5-246 to 5-255. If you make a mistake, scan **CANCEL** on page 5-256.

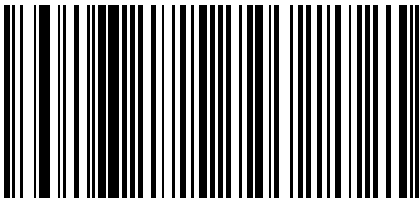

**CODABAR - LENGTH WITHIN RANGE**



## **Code Types & Options**

### **Set Lengths for Codabar**

**Any Length** - Scanning this option allows you to decode Codabar symbols containing any number of characters.

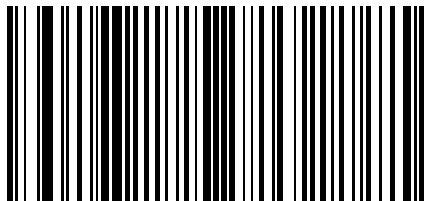

**CODABAR - ANY LENGTH**

## **Code Types & Options**

### **CLSI Editing**

If enabled, this parameter strips the start and stop characters and inserts a space after the first, fifth, and tenth characters of a 14-character Codabar symbol. Note that symbol length does not include start and stop characters.

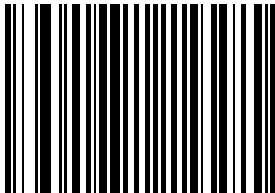

**ENABLE CLSI EDITING**



## **Code Types & Options**

### **Disable CLSI Editing**

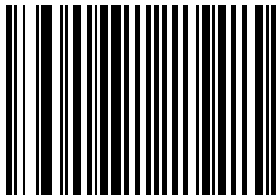

**DISABLE CLSI EDITING**

## **Code Types & Options**

### **NOTIS Editing**

If enabled, this parameter strips the start and stop characters from decoded Codabar symbol.

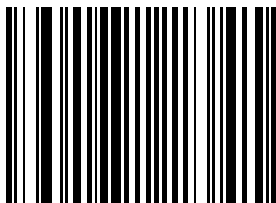

**ENABLE NOTIS EDITING**



## **Code Types & Options**

### **Disable NOTIS Editing**

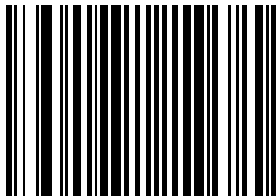

**DISABLE NOTIS EDITING**



## Custom Tailoring

### Scanning Range

Select the decode range that best suits your scanning needs. **FULL RANGE** covers the maximum scanning range, and is recommended for in-counter applications and installations where there is no opportunity for inadvertent reads.

Decode range data is shown in [Table 4-2](#) on page 4-5.

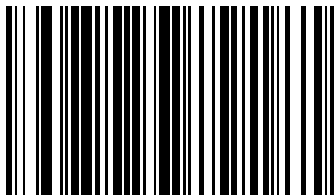

**FULL RANGE**



## **Custom Tailoring**

### **Scanning Range**

**MEDIUM RANGE** is recommended for on-counter applications and installations where full range may allow inadvertent reads.

Decode range data is shown in [Table 4-2](#) on page 4-5 .

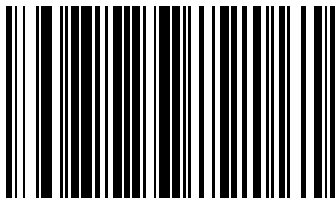

**MEDIUM RANGE**

## **Custom Tailoring**

### **Scanning Range**

**SHORT RANGE** is recommended for on-counter applications where counter space is at a minimum.

Decode range data is shown in [Table 4-2](#) on page 4-5 .

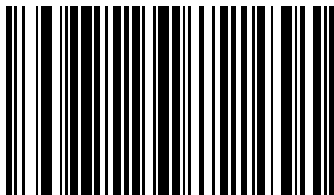

**SHORT RANGE**



## **Custom Tailoring**

### **Internal Beeper**

This parameter connects the beeper signal to the internal beeper.



**ENABLE INTERNAL BEEPER**

## **Custom Tailoring**

### **Disable Internal Beeper**

This parameter disconnects the beeper signal to the internal beeper.



**DISABLE INTERNAL BEEPER**



## **Custom Tailoring**

### **RS-232C Port External Beeper**

This parameter connects the beeper signal to the RS-232C Port.



**ENABLE RS-232C PORT EXTERNAL BEEPER**

## **Custom Tailoring**

### **Disable RS-232C Port External Beeper**

This parameter disconnects the beeper signal to the RS-232C Port.



**DISABLE RS-232C PORT EXTERNAL BEEPER**



## **Custom Tailoring**

### **Beeper Volume**

Select the beeper volume that best suits your operation.

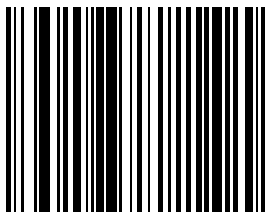

**LOW VOLUME**



## **Custom Tailoring**

### **Beeper Volume**



**MEDIUM VOLUME**



## **Custom Tailoring**

### **Beeper Volume**



**HIGH VOLUME**

## **Custom Tailoring**

### **Beeper Frequency**

To select a decode beep frequency (tone), scan the **LOW FREQUENCY**, **MEDIUM FREQUENCY**, or **HIGH FREQUENCY** bar code.

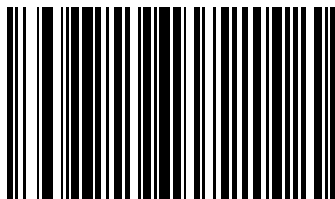

**LOW FREQUENCY**



## **Custom Tailoring**

### **Beeper Frequency**

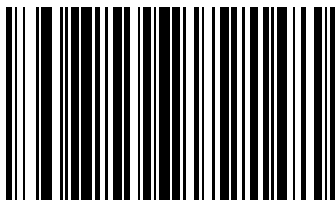

**MEDIUM FREQUENCY**

**Custom Tailoring**  
**Beeper Frequency**

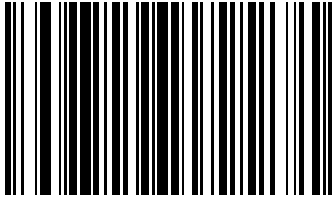

**HIGH FREQUENCY**



## Custom Tailoring

### Time-out Between Decodes, Same Symbol

This parameter sets the minimum time between decodes of the same symbol. It is programmable in 0.1 second increments from 0.0 to 9.9 seconds. (Setting this above 0.4 seconds is recommended.)

Scan the bar code below to select a new time-out. Next scan two numeric bar codes on pages 5-246 to 5-255, the first representing seconds, the second tenths of seconds. If you make an error, or wish to change your selection, scan **CANCEL** on page 5-256.

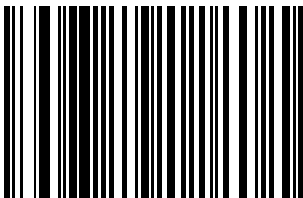

**TIME-OUT BETWEEN SAME SYMBOL**

## **Custom Tailoring**

### **Time-out Between Decodes, Different Symbols**

This parameter sets the minimum time between decodes of different symbols. It is programmable in 0.1 second increments from 0.0 to 9.9 seconds.

Scan the bar code below to select a new time-out. Next scan two numeric bar codes on pages 5-246 to 5-255, the first representing seconds, the second tenths of seconds. If you make an error, or wish to change your selection, scan **CANCEL** on page 5-256.

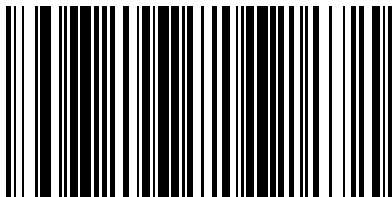

**TIME-OUT BETWEEN DIFFERENT SYMBOLS**



## **Custom Tailoring**

### **Decode Buffering**

When enabled, successive decodes are buffered by the scanner. This is useful when the host takes a long time to receive and/or process a symbol.

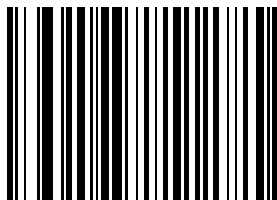

**ENABLE DECODE BUFFERING**



## **Custom Tailoring**

### **Disable Decode Buffering**

When disabled, successive decodes are no longer buffered by the scanner. The scanner waits until a decoded symbol is transmitted to the host device before processing another symbol.

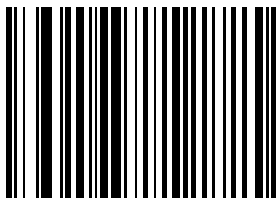

**DISABLE DECODE BUFFERING**



## **Custom Tailoring**

### **Rest Mode**

To choose a Rest Mode for the LS 5700/LS 5800, scan the bar code below. The default time is 30 minutes. That is, 30 minutes after a scan attempt, the scanner enters this mode. To change the time to rest mode, scan a bar code beginning on page 5-164.



**REST MODE**

## **Custom Tailoring**

### **Sleep Mode**

The LS 5700 can be programmed to completely shut down. The default time is 30 minutes. That is, 30 minutes after a scan attempt, the scanner enters this mode. To change the time to sleep mode, scan a bar code beginning on page 5-164.



**SLEEP MODE**



## **Custom Tailoring**

### **Time Delay to Rest/Sleep Mode**

This parameter sets the time the scanner remains active after any scanning activity. Scan one of the four options. Depending on the selection, the scanner enters a rest/sleep mode 15, 30, 60, or 90 minutes after the last attempted decode.

If you make a mistake, scan **CANCEL** on page 5-256.

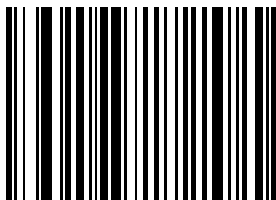

**15 MINUTES**

## **Custom Tailoring**

### **Time Delay to Rest/Sleep Mode**

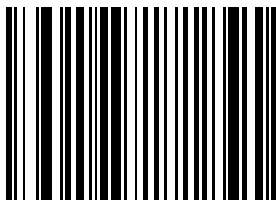

**30 MINUTES**



## **Custom Tailoring**

### **Time Delay to Rest/Sleep Mode**

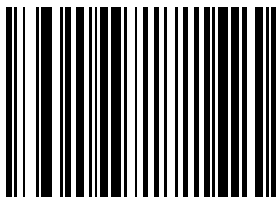

**60 MINUTES**

## **Custom Tailoring**

### **Time Delay to Rest/Sleep Mode**

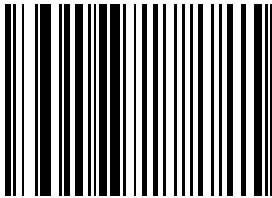

**90 MINUTES**



## Custom Tailoring

### Primary Decode Session Time

This parameter sets the maximum time decode processing continues during a scan attempt. It is programmable in 0.1 second increments from 0.1 to 9.9 seconds. (Setting this between 1.0 and 3.0 seconds is recommended.)

Scan the bar code below to select a new time-out. Next scan two numeric bar codes on pages 5-246 to 5-255, the first representing seconds, the second tenths of seconds. If you make an error, or wish to change your selection, scan **CANCEL** on page 5-256.

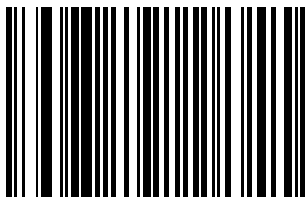

**DECODE ATTEMPT DURATION**



## **Decode Options**

### **UPC/EAN Predecode Block**

UPC/EAN bar codes are made up of two blocks representing “left” and “right” halves. For example, bar code 1234567890 is divided into left block “12345,” and right block “67890.”

To maximize its aggressiveness, the scanner is capable of decoding a UPC/EAN symbol by “splicing” together a left block read by one of the 20 scan lines, and a right block read by another.



## Decode Options

### Reject Predecode Block

This option provides additional protection (beyond the embedded check digit) against mis-splicing a UPC/EAN block from a symbol that has just been decoded (but has not completely exited the scanner's field of view), with a block from a new symbol that has just been presented to the scanner.

This option requires the scanner to compare the new symbol against the symbol just decoded to see if there are common blocks.

If either the left or right blocks match between symbols, the scanner rejects the common block for the period of time dictated by the **TIME OUT BETWEEN DECODES - SAME SYMBOL** parameter.

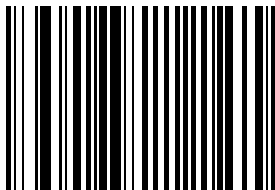

**REJECT PREDECODE BLOCK**

## **Decode Options**

### **Accept Predecode Block**

This option allows immediate decode of a new UPC/EAN bar code regardless of the previously decoded UPC/EAN bar code's block content.

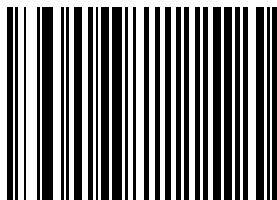

**ACCEPT PREDECODE BLOCK**



## **Decode Options**

### **UPC/EAN Security Level**

The LS 5700/LS 5800 offers four levels of decode security for UPC/EAN bar codes. Increasing levels of security are provided for decreasing levels of bar code quality. There is an inverse relationship between security and scanner aggressiveness, so be sure to choose only that level of security necessary for any given application.

#### **Level 0**

This is the default setting which allows the scanner to operate in its most aggressive state, while providing sufficient security in decoding “in-spec” UPC/EAN bar codes.

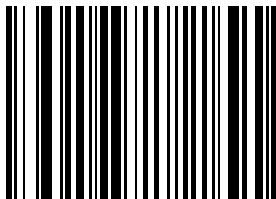

**UPC/EAN SECURITY LEVEL 0**

## **Decode Options**

### **UPC/EAN Security Level**

#### **Level 1**

As bar code quality levels diminish, certain characters become prone to mis-decodes before others (i.e., 1, 2, 7, 8). If you are experiencing mis-decodes of poorly printed bar codes, and the mis-decodes are limited to these characters, select this security level.

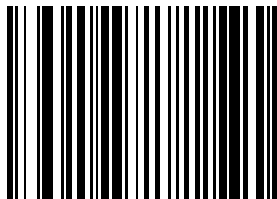

**UPC/EAN SECURITY LEVEL 1**



## **Decode Options**

### **UPC/EAN Security Level**

#### **Level 2**

If you are experiencing mis-decodes of poorly printed bar codes, and the mis-decodes are not limited to characters 1, 2, 7, and 8, select this security level.

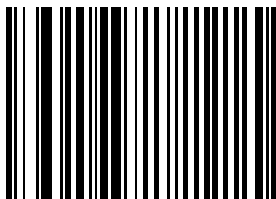

**UPC/EAN SECURITY LEVEL 2**

## **Decode Options**

### **UPC/EAN Security Level**

#### **Level 3**

If you have tried Security Level 2, and are still experiencing misdecodes, select this security level. Be advised, selecting this option is an extreme measure against mis-decoding severely out of spec bar codes. Selection of this level significantly impairs the decoding ability of the scanner. If this level of security is necessary, you should try to improve the quality of your bar codes.

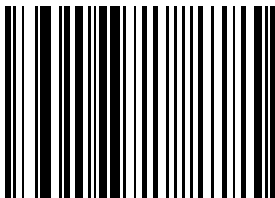

**UPC/EAN SECURITY LEVEL 3**



## **Decode Options**

### **Linear UPC/EAN Decode**

This option applies to code types containing two adjacent blocks (e.g. UPC-A, EAN-8, EAN-13). When enabled, a bar code is transmitted only when both the left and right blocks are successfully decoded within one laser scan. This option should be enabled when bar codes are in proximity to each other.

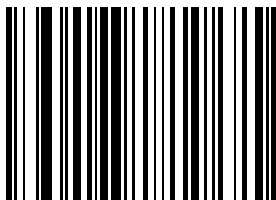

**ENABLE LINEAR UPC/EAN DECODE**



## **Decode Options**

### **Disable Linear UPC/EAN Decode**

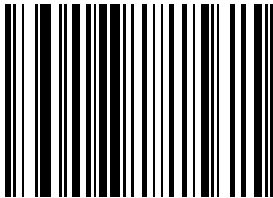

**DISABLE LINEAR UPC/EAN DECODE**



## **Decode Options**

### **Linear Supplemental Decode**

This option applies to code types containing two or five character supplementals. When enabled, a bar code is transmitted only when both the supplemental block and its adjacent block are successfully decoded within one laser scan. This option should be enabled when bar codes are in proximity to each other.



**ENABLE LINEAR SUPPLEMENTAL DECODE**

## **Decode Options**

### **Disable Linear Supplemental Decode**



**DISABLE LINEAR SUPPLEMENTAL DECODE**



## Decode Options

### Decode Redundancy for UPC/EAN (only in Autodiscriminate Mode)

With Autodiscriminate UPC/EAN Supplementals selected, this option adjusts the number of times a symbol is decoded before transmission. The range is from two to thirty times. Ten or above is recommended when decoding a mix of UPC/EAN symbols with and without supplementals.

Scan the bar code below to select a decode redundancy value. Next scan two numeric bar codes on pages 5-246 to 5-255 that represent the desired number of times. For single digit numbers, include a leading zero. If you make an error, or wish to change your selection, scan **CANCEL** on page 5-256.

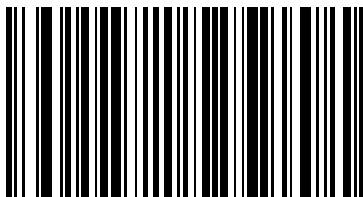

**DECODE REDUNDANCY for UPC/EAN**

## **Decode Options**

### **UPC/EAN Decode Performance**

This option offers three levels of decode performance or “aggressiveness” for UPC/EAN symbols without supplementals. Increasing the performance level reduces the amount of required bar code orientation, which is useful if you are scanning very long and/or truncated bar codes. Increased levels reduce decode security.

If you enable this option, you may select a Decode Performance level from the following pages to suit your performance needs.



**ENABLE UPC/EAN DECODE PERFORMANCE**



## **Decode Options**

### **Disable UPC/EAN Decode Performance**



**DISABLE UPC/EAN DECODE PERFORMANCE**

## **Decode Options**

### **UPC/EAN Decode Performance**

#### **Level 1**



**UPC/EAN DECODE PERFORMANCE LEVEL 1**



## **Decode Options**

### **UPC/EAN Decode Performance**

#### **Level 2**

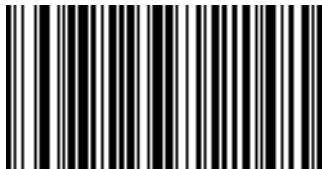

**UPC/EAN DECODE PERFORMANCE LEVEL 2**



## **Decode Options**

### **UPC/EAN Decode Performance**

#### **Level 3**



**UPC/EAN DECODE PERFORMANCE LEVEL 3**



## **Decode Options**

### **Linear Code Type Security**

#### **Level 1**

The LS 5700/LS 5800 offers four levels of decode security for linear code types (e.g. Code 39, Interleaved 2 of 5). Higher security levels are selected for decreasing levels of bar code quality. As security levels increase, the scanner's aggressiveness decreases.

Select the security level appropriate for your bar code quality.

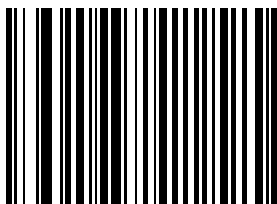

**LINEAR SECURITY LEVEL 1**

**Decode Options**  
**Linear Code Type Security**  
**Level 2**

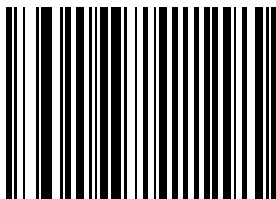

**LINEAR SECURITY LEVEL 2**



## **Decode Options**

### **Linear Code Type Security**

#### **Level 3**

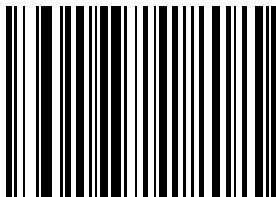

**LINEAR SECURITY LEVEL 3**

**Decode Options**  
**Linear Code Type Security**  
**Level 4**

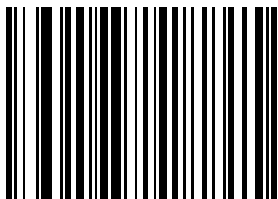

**LINEAR SECURITY LEVEL 4**



## **Decode Options**

### **Code 128 Decode Performance**

This option offers three levels of decode performance or “aggressiveness” for Code 128 symbols. Increasing the performance level reduces the amount of required bar code orientation, which is useful if you are scanning very long and/or truncated bar codes. Increased levels reduce decode security.

If you enable this option, you may select a Decode Performance level from the following pages to suit your performance needs.

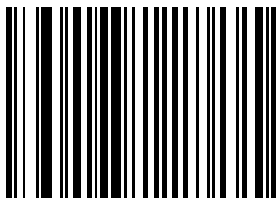

**ENABLE CODE 128 DECODE PERFORMANCE**

## **Decode Options**

### **Disable Code 128 Decode Performance**

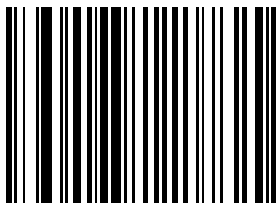

**DISABLE CODE 128 DECODE PERFORMANCE**



## **Decode Options**

### **Code 128 Decode Performance**

#### **Level 1**

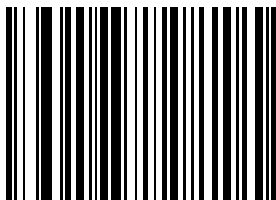

**CODE 128 DECODE PERFORMANCE LEVEL 1**



## **Decode Options**

### **Code 128 Decode Performance**

#### **Level 2**

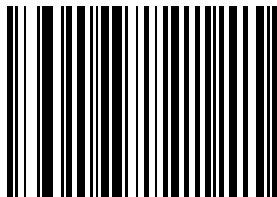

**CODE 128 DECODE PERFORMANCE LEVEL 2**



## **Decode Options**

### **Code 128 Decode Performance**

#### **Level 3**

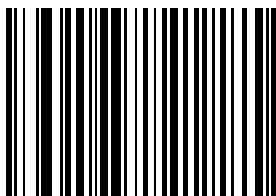

**CODE 128 DECODE PERFORMANCE LEVEL 3**

## Decode Options

### Code 39 Decode Performance

This option offers three levels of decode performance or “aggressiveness” for Code 39 symbols. Increasing the performance level reduces the amount of required bar code orientation, which is useful if you are scanning very long and/or truncated bar codes. Increased levels reduce decode security.

If you enable this option, you may select a Decode Performance level from the following pages to suit your performance needs.

**Note:** This option only works with Code 39 One Discrete Length.

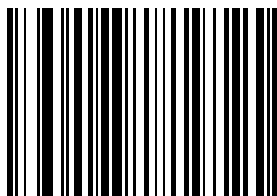

**ENABLE CODE 39 DECODE PERFORMANCE**



## **Decode Options**

### **Disable Code 39 Decode Performance**

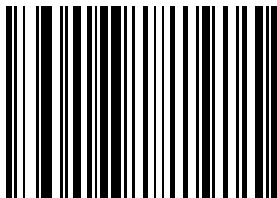

**DISABLE CODE 39 DECODE PERFORMANCE**

## **Decode Options**

### **Code 39 Decode Performance**

#### **Level 1**

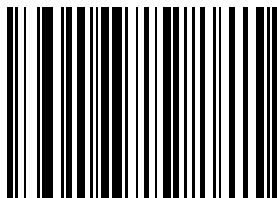

**CODE 39 DECODE PERFORMANCE LEVEL 1**



## **Decode Options**

### **Code 39 Decode Performance**

#### **Level 2**

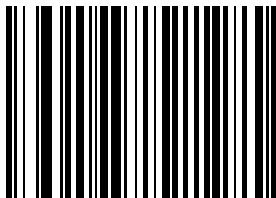

**CODE 39 DECODE PERFORMANCE LEVEL 2**

## **Decode Options**

### **Code 39 Decode Performance**

#### **Level 3**

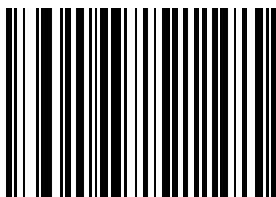

**CODE 39 DECODE PERFORMANCE LEVEL 3**



## **Data Transmission Formats**

### **Transmit UPC-A Check Digit**

Scan this bar code to transmit the symbol with the UPC-A check digit.

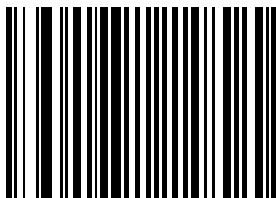

**TRANSMIT  
UPC-A CHECK DIGIT**



## **Data Transmission Formats**

### **Do Not Transmit UPC-A Check Digit**

Scan this bar code to transmit the symbol without the UPC-A check digit.

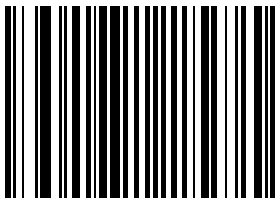

**DO NOT TRANSMIT  
UPC-A CHECK DIGIT**



## **Data Transmission Formats**

### **Transmit UPC-E Check Digit**

Scan this bar code to transmit the symbol with the UPC-E check digit.

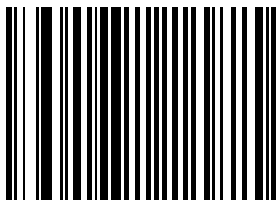

**TRANSMIT  
UPC-E CHECK DIGIT**

## **Data Transmission Formats**

### **Do Not Transmit UPC-E Check Digit**

Scan this bar code to transmit the symbol without the UPC-E check digit.

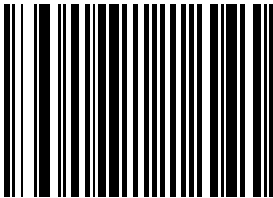

**DO NOT TRANSMIT  
UPC-E CHECK DIGIT**



## **Data Transmission Formats**

### **UPC-A Preamble**

Three options are given for lead-in characters for UPC-A symbols transmitted to the host device: transmit system character only, transmit system character and country code (“0” for USA), and no preamble transmitted. The lead-in characters are considered part of the symbol.

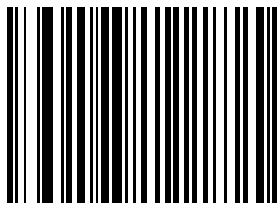

**NO PREAMBLE  
(<DATA>)**

## **Data Transmission Formats**

### **UPC-A Preamble**

Scan this bar code if you want to transmit the symbol with the System Character.

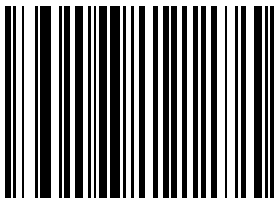

**SYSTEM CHARACTER**  
**(<SYSTEM CHARACTER> <DATA>)**



## **Data Transmission Formats**

### **UPC-A Preamble**

Scan this bar code if you want to transmit the symbol with the System Character and Country Code.

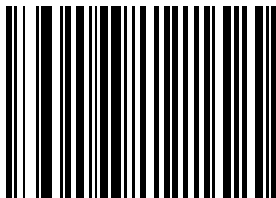

**SYSTEM CHARACTER & COUNTRY CODE  
(<COUNTRY CODE> <SYSTEM CHARACTER> <DATA>)**

## **Data Transmission Formats**

### **UPC-A Preamble**

Three options are given for lead-in characters for UPC-E symbols transmitted to the host device: transmit system character only, transmit system character and country code ("0" for USA), and no preamble transmitted. The lead-in characters are considered part of the symbol.

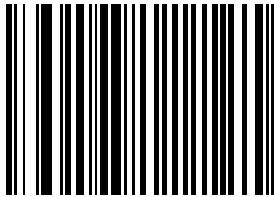

**NO PREAMBLE  
(<DATA>)**



## **Data Transmission Formats**

### **UPC-E Preamble**

Scan this bar code if you want to transmit the symbol with the System Character.

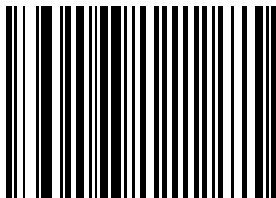

**SYSTEM CHARACTER**  
**(<SYSTEM CHARACTER> <DATA>)**



## **Data Transmission Formats**

### **UPC-E Preamble**

Scan this bar code if you want to transmit the symbol with the System Character and Country Code.

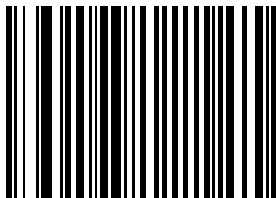

**SYSTEM CHARACTER & COUNTRY CODE**  
**(<COUNTRY CODE> <SYSTEM CHARACTER> <DATA>)**



## **Data Transmission Formats**

### **Convert UPC-E to UPC-A**

This parameter converts UPC-E (zero suppressed) decoded data to UPC-A format before transmission. After conversion, data follows UPC-A format and is affected by UPC-A programming selections (e.g., Preamble, Check Digit).

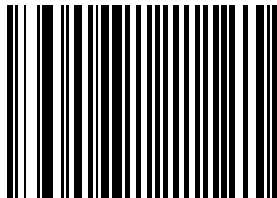

**CONVERT UPC-E TO UPC-A**

## **Data Transmission Formats**

### **Do Not Convert UPC-E to UPC-A**

Scanning **DO NOT CONVERT UPC-E TO UPC-A** allows you to transmit UPC-E (zero suppressed) decoded data.

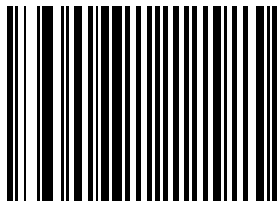

**DO NOT CONVERT UPC-E TO UPC-A**



## **Data Transmission Formats**

### **EAN Zero Extend**

If this parameter is enabled, five leading zeros are added to decoded EAN-8 symbols to make them compatible in format to EAN-13 symbols.

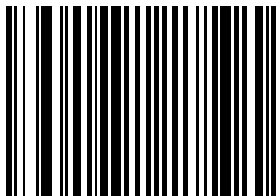

**ENABLE EAN ZERO EXTEND**

## **Data Transmission Formats**

### **Disable EAN Zero Extend**

Disabling this parameter returns EAN-8 symbols to their normal format.

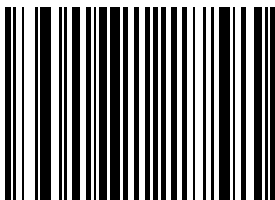

**DISABLE EAN EXTEND**



## **Data Transmission Formats**

### **Convert EAN-8 to EAN-13 Type**

When EAN Zero Extend is enabled, this parameter gives you the option of labeling the extended symbol as either an EAN-13 bar code, or an EAN-8 bar code.

When EAN Zero Extend is disabled, this parameter has no effect on bar code data.

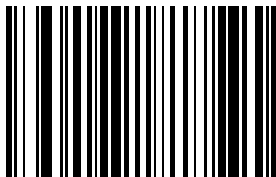

**TYPE IS EAN-13**

## **Data Transmission Formats**

### **Do Not Convert EAN-8 to EAN-13 Type**

When EAN Zero Extend is enabled, this parameter gives you the option of labeling the extended symbol as either an EAN-13 bar code, or an EAN-8 bar code.

When EAN Zero Extend is disabled, this parameter has no effect on bar code data.

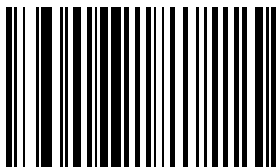

**TYPE IS EAN-8**



## **Data Transmission Formats**

### **Convert I 2 of 5 to EAN-13**

This parameter converts a 14 character I 2 of 5 code into EAN-13, and transmits to the host as EAN-13. In order to accomplish this, the I 2 of 5 code must be enabled, one length must be set to 14, and the code must have a leading zero and a valid EAN-13 check digit.

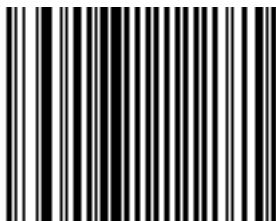

**CONVERT I 2 of 5 to EAN-13  
(ENABLE)**



## **Data Transmission Formats**

**Do Not Convert I 2 of 5 to EAN-13**



**DO NOT CONVERT I 2 of 5 to EAN-13  
(DISABLE)**



## **Data Transmission Formats**

### **Transmit 1 2 of 5 Check Digit**

Scan this symbol if you want to transmit the check digit with the data.



**TRANSMIT 1 2 of 5 CHECK DIGIT  
(ENABLE)**

## **Data Transmission Formats**

### **Do Not Transmit I 2 of 5 Check Digit**

Scan this symbol if you want to transmit the data without the check digit.



**DO NOT TRANSMIT I 2 of 5 CHECK DIGIT  
(DISABLE)**



## **Data Transmission Formats**

### **Transmit Code 39 Check Digit**

Scan this symbol if you want to transmit the check digit with the data.



**TRANSMIT CODE 39 CHECK DIGIT  
(ENABLE)**

## **Data Transmission Formats**

### **Do Not Transmit Code 39 Check Digit**

Scan this symbol if you want to transmit the data without the check digit.



**DO NOT TRANSMIT CODE 39 CHECK DIGIT  
(DISABLE)**



## **Data Transmission Formats**

### **Beep After Good Decode**

Scan this symbol if you want the unit to beep after a good decode.



**BEEP AFTER GOOD DECODE**

## **Data Transmission Formats**

### **Do Not Beep After Good Decode**

Scan this symbol if you want the unit not to beep after a good decode. The beeper still operates during parameter menu scanning and indicates error conditions.



**DO NOT BEEP AFTER GOOD DECODE**



## **Data Transmission Formats**

### **Intercharacter Delay**

Select the intercharacter delay option matching host requirements. The intercharacter delay gives the host system time to service its receiver and perform other tasks between characters. The delay period can range from no delay to 99 msec in 1 msec increments. After scanning the bar code below, scan two bar codes on pages 5-246 to 5-255 to set the desired time-out.



**INTERCHARACTER DELAY**



## Data Transmission Formats

### Transmit Code ID Character

A code ID character identifies the code type of a scanned bar code. This may be useful when the scanner is decoding more than one code type. In addition to any single character prefix already selected, the code ID character is inserted between the prefix and the decoded symbol.

The user may select no code ID character, a Symbol Code ID character, or an AIM Code ID character. The Symbol Code ID characters are listed below; see [Table A-2](#) in the *Appendix* for AIM Identifiers.

A = UPC-A, UPC-E, EAN-8 or EAN-13

B = Code 39

C = Codabar

D = Code 128

F = Interleaved 2 of 5

K = UCC/EAN-128

L = Bookland EAN

N = Coupon Code



**TRANSMIT SYMBOL CODE ID CHARACTER**



## **Data Transmission Formats**

### **Transmit AIM Code ID Character**

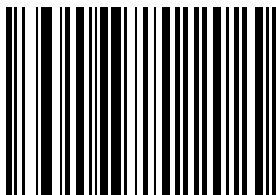

**TRANSMIT AIM CODE ID CHARACTER**

## **Data Transmission Formats**

**Do Not Transmit AIM or Symbol ID Character**

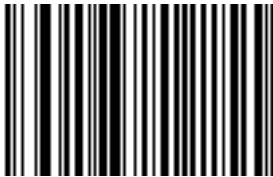

**DO NOT TRANSMIT AIM OR SYMBOL  
CODE ID CHARACTERS**



## **Data Transmission Formats**

### **Pause Duration**

This parameter allows a pause to be inserted at any point in the data transmission. Pauses are set by scanning a two digit number (i.e., two bar codes), and are measured in 1/10 second intervals. For example, scanning bar codes “0” and “1” inserts a 1/10 second pause; “0” and “5” gives you a 1/2 second delay. Numeric bar codes are found on pages 5-246 to 5-255. If you make a mistake, scan **DATA FORMAT CANCEL** on page 5-245.



**PAUSE DURATION**

## Data Transmission Formats

### Prefix/Suffix Values

A prefix/suffix may be appended to scan data for use in data editing. These values are set by scanning a four digit number (i.e., four bar codes) that corresponds to key codes for various terminals. See [Table A-4](#) in the *Appendix*.

Numeric bar codes are on pages 5-246 to 5-255. If you make a mistake, scan the **DATA FORMAT CANCEL** bar code on page 5-245, and start over.



SCAN PREFIX



## **Data Transmission Formats**

### **Prefix/Suffix Values**



**SCAN SUFFIX**

## **Data Transmission Formats**

### **Prefix/Suffix Values**

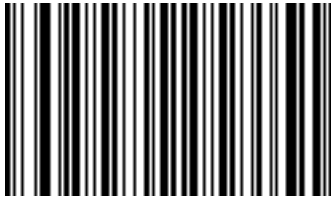

**SERIAL PREFIX**



## **Data Transmission Formats**

### **Prefix/Suffix Values**



**SERIAL SUFFIX**



## Data Transmission Formats

### Scan Data Transmission Format

A prefix/suffix may be appended to scan data for use in data editing. These values are set by scanning a four digit number (i.e., four bar codes) that corresponds to key codes for various terminals. See [Table A-4](#) in the *Appendix*.

Numeric bar codes are on pages 5-246 to 5-255. If you make a mistake, scan the **DATA FORMAT CANCEL** bar code on page 5-245, and start over.

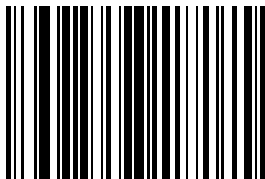

**SCAN OPTIONS**



## **Data Transmission Formats**

### **Scan Data Transmission Format**



**DATA AS IS**

## **Data Transmission Formats**

### **Scan Data Transmission Format**



**<DATA> <CR (1013)>**



## **Data Transmission Formats**

### **Scan Data Transmission Format**



**<PREFIX> <DATA>**

## **Data Transmission Formats**

### **Scan Data Transmission Format**



**<PREFIX> <DATA> <SUFFIX>**



## **Data Transmission Formats**

### **Serial Data Transmission Format**



**SERIAL OPTIONS**

## **Data Transmission Formats**

### **Serial Data Transmission Format**

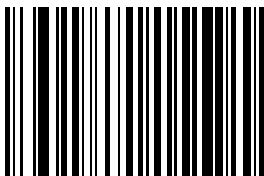

**DATA AS IS**



## **Data Transmission Formats**

### **Serial Data Transmission Format**

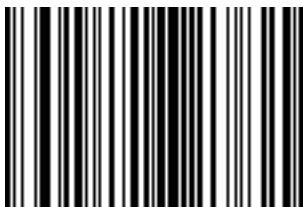

**<DATA> <SUFFIX>**



## **Data Transmission Formats**

### **Serial Data Transmission Format**



**<PREFIX > <DATA>**



## **Data Transmission Formats**

### **Serial Data Transmission Format**



**<PREFIX > <DATA> <SUFFIX>**

## **Data Transmission Formats**

### **Ignore Unknown Characters**

When enabled, all data is sent except for unknown characters, and no error beeps are sounded. Unknown characters are those characters the selected terminal does not recognize.

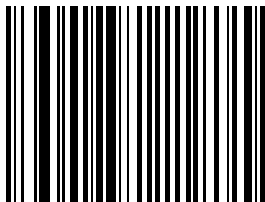

**ENABLE  
IGNORE UNKNOWN CHARACTERS**



## **Data Transmission Formats**

### **Disable Ignore Unknown Characters**

When disabled, bar codes with unknown characters are decoded, but not transmitted to the host. A decode beep is followed by a communications error beep indication.

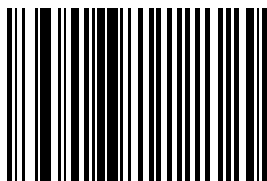

**DISABLE  
IGNORE UNKNOWN CHARACTERS**

## **Data Transmission Formats**

### **Data Format Cancel**

If you make an error while entering scan, or serial data transmission formats, or wish to change your selection, scan the bar code below.

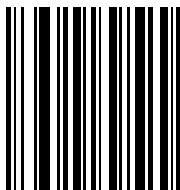

**DATA FORMAT CANCEL**



## **Programming Utilities**

### **Numeric Bar Codes**

For parameters requiring specific numeric values, scan the appropriately numbered bar code(s).

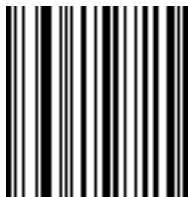

**0**

## **Programming Utilities**

### **Numeric Bar Codes**

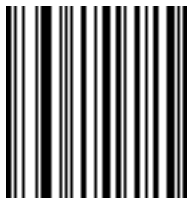

**1**



## **Programming Utilities**

### **Numeric Bar Codes**

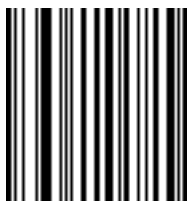

2



## **Programming Utilities**

### **Numeric Bar Codes**

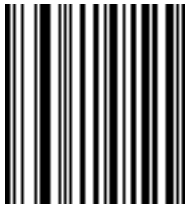

**3**



## **Programming Utilities**

### **Numeric Bar Codes**

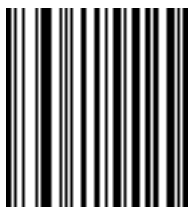

4

## **Programming Utilities**

### **Numeric Bar Codes**

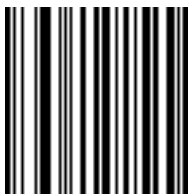

5



## **Programming Utilities**

### **Numeric Bar Codes**

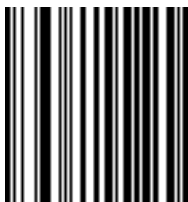

6

## **Programming Utilities**

### **Numeric Bar Codes**

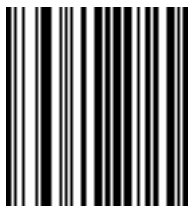

**7**



## **Programming Utilities**

### **Numeric Bar Codes**

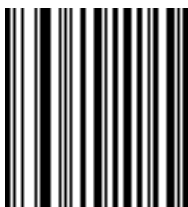

8

## **Programming Utilities**

### **Numeric Bar Codes**

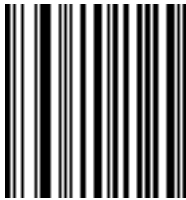

**9**



## **Programming Utilities**

### **Cancel**

If you make an error, or wish to change your selection, scan **CANCEL**, below.

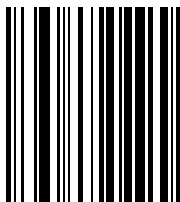

**CANCEL**



## **Programming Utilities**

### **Enter**

When an **ENTER** is required, such as for **DATA TRANSMISSION FORMATS**, scan the bar code below.

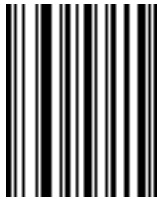

**ENTER**



## **Programming Utilities**

### **Applications Items**

**Reserved for future use.**

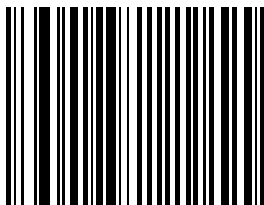

**APPLICATIONS ITEM 1  
ENABLE**

## **Programming Utilities**

### **Applications Items**

Reserved for future use.

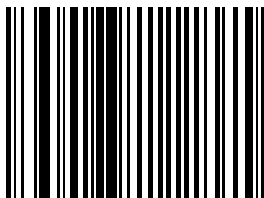

**APPLICATIONS ITEM 1  
DISABLE**



## **Programming Utilities**

### **Applications Items**

**Reserved for future use.**

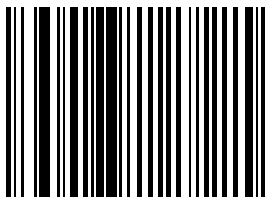

**APPLICATIONS ITEM 2  
ENABLE**

## **Programming Utilities**

### **Applications Items**

Reserved for future use.

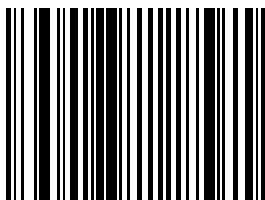

**APPLICATIONS ITEM 2  
DISABLE**



## **Programming Utilities**

### **Applications Items**

**Reserved for future use.**

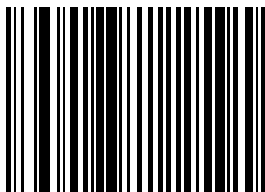

**APPLICATIONS ITEM 3  
ENABLE**

## **Programming Utilities**

### **Applications Items**

Reserved for future use.

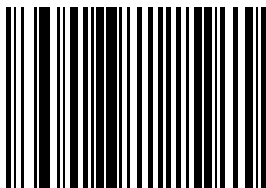

**APPLICATIONS ITEM 3  
DISABLE**



## **Programming Utilities**

### **Applications Items**

**Reserved for future use.**

Enter a 3 digit value from 0 to 255.



**APPLICATIONS VALUE**





## *Appendix*

---

### **UCC/EAN-128**

UCC/EAN-128 is a convention for printing data fields with standard Code 128 bar code symbols. UCC/EAN-128 symbols are distinguished by a leading FNC 1 character as the first or second character in the symbol. Other FNC 1 characters are used to delineate fields.

When EAN-128 symbols are read, they are transmitted after special formatting strips off the leading FNC 1 character, and replaces other FNC 1 characters with the ASCII 29 GS control character.

When AIM symbology identifiers are transmitted, the modifier character indicates the position of the leading FNC 1 character according to AIM guidelines.

Standard Code 128 bar codes which do not have a leading FNC 1 may still be used, but will not be encoded according to the EAN-128 convention. Standard Code 128 and UCC/EAN-128 may be mixed in an application. The scanner autodiscriminates between these symbols, and can enable or disable one or both code types via bar code menus. The following table indicates the behavior of the scanner in each of the four possible parameter settings.



**Table A-1. Code 128 - UCC/EAN 128**

Standard Code 128	UCC/ EAN-128	Effect and Example
Disable	Disable	No Code 128 symbols can be read.
Disable	Enable	Read only symbols with leading FNC 1. Examples: $FNC1ABCD^{FNC1}E$ are read as $ABCD^{29}E$ $A^{FNC1}BCD^{FNC1}E$ are read as $ABCD^{29}E$ $FNC1FNC1ABCD^{FNC1}E$ are read as $ABCD^{29}E$ $ABCD^{FNC1}E$ cannot be read $ABCDE$ cannot be read
Enable	Disable	Read only symbols without leading FNC 1. Examples: $FNC1ABCD^{FNC1}E$ cannot be read $A^{FNC1}BCD^{FNC1}E$ cannot be read $FNC1FNC1ABCD^{FNC1}E$ cannot be read $ABCD^{FNC1}E$ is read as $ABCD^{29}E$ $ABCDE$ is read as $ABCDE$
Enable	Enable	Read both types of symbols. Examples: $FNC1ABCD^{FNC1}E$ are read as $ABCD^{29}E$ $A^{FNC1}BCD^{FNC1}E$ are read as $ABCD^{29}E$ $FNC1FNC1ABCD^{FNC1}E$ are read as $ABCD^{29}E$ $ABCD^{FNC1}E$ is read as $ABCD^{29}E$ $ABCDE$ is read as $ABCDE$

---

## AIM Code Identifiers

Each AIM Code Identifier contains the three-character string **jcm** where:

**j** = Flag Character (ASCII 93)

**c** = Code Character (see [Table A-2](#))

**m** = Modifier Character (see [Table A-3](#))

**Table A-2. Code Characters**

Code Character	Code Type
A	Code 39
C	Code 128
E	UPC/EAN
F	Codabar
I	Interleaved 2 of 5
X	Bookland EAN



The modifier character is the sum of the applicable option values based on the following table.

**Table A-3. Modifier Characters**

<b>Code Type</b>	<b>Option Value</b>	<b>Option</b>
<b>Code 39</b>		
	0	No Check character or Full ASCII processing.
	1	Reader has checked one check character.
	3	Reader has checked and stripped check character.
	4	Reader has performed Full ASCII character conversion.
	5	Reader has performed Full ASCII character conversion, and checked one check character.
	7	Reader has performed Full ASCII character conversion, and checked and stripped check character.
	Example:	A Full ASCII bar code with check character W, <b>A+I+MI+DW</b> , is transmitted as <b>JA7AimId</b> where $7 = (3+4)$ .

Table A-3. Modifier Characters (cont'd)

Code Type	Option Value	Option
<b>Code 128</b>		
	0	Standard data packet, No Function code 1 in first symbol position.
	1	Function code 1 in first symbol character position.
	2	Function code 1 in second symbol character position.
	Example:	A Code (EAN) 128 bar code with Function 1 character in the first position, FNC1 Aim Id is transmitted as <b>JC1AimId</b>
<b>I 2 of 5</b>		
	0	No check digit processing.
	1	Reader has validated check digit.
	3	Reader has validated and stripped check digit.
	Example:	An I 2 of 5 bar code without check digit, 4123, is transmitted as <b>Ji04123</b>
<b>Codabar</b>		
	0	No check digit processing.
	1	Reader has checked check digit.
	3	Reader has stripped check digit before transmission.
	Example:	A Codabar bar code without check digit, 4123, is transmitted as <b>JF04123</b>



**Table A-3. Modifier Characters (cont'd)**

Code Type	Option Value	Option
<b>UPC/EAN</b>		
	0	Standard packet in full EAN country code format, which is 13 digits for UPC-A and UPC-E (not including supplemental data).
	1	Two digit supplement data only.
	2	Five digit supplement data only.
	4	EAN-8 data packet.
	Example:	A UPC-A bar code 012345678905 is transmitted as <b>JE00012345678905</b>
<b>Bookland EAN</b>		
	0	No options specified at this time. Always transmit 0.
	Example:	A Bookland EAN bar code 123456789X is transmitted as <b>JX0123456789X</b>

According to AIM standards, a UPC with supplemental bar code is transmitted in one of the following formats:

**JE0** (UPC chars) (terminator) **JE2** (supplemental) (terminator) or

**JE2** (supplemental) (terminator) **JE0** (UPC chars) (terminator)

In the scanner , however, the format is changed to:

**JE0** (UPC chars) **JE2** (supplemental)

Therefore, a UPC with two supplemental characters, 01234567890510, is transmitted to the host as a 21-character string, **JE00012345678905JE110**.

---

The following values can be assigned as prefixes or suffixes for data transmission. Not all options are available on every keyboard. Refer to your own keyboard for pertinent keystrokes.

**Table A-4. ASCII Character Set**

<b>ASCII Value</b>	<b>Full ASCII Code 39 Encode Char.</b>	<b>Keystroke</b>
1000	%U	CTRL 2
1001	\$A	CTRL A
1002	\$B	CTRL B
1003	\$C	CTRL C
1004	\$D	CTRL D
1005	\$E	CTRL E
1006	\$F	CTRL F
1007	\$G	CTRL G
1008	\$H	CTRL H
1009	\$I	CTRL I
1010	\$J	CTRL J
1011	\$K	CTRL K
1012	\$L	CTRL L
1013	\$M	CTRL M
1014	\$N	CTRL N
1015	\$O	CTRL O
1016	\$P	CTRL P
1017	\$Q	CTRL Q
1018	\$R	CTRL R
1019	\$S	CTRL S
1020	\$T	CTRL T
1021	\$U	CTRL U



## LS 5700/LS 5800 Product Reference Guide

---

<b>ASCII Value</b>	<b>Full ASCII Code 39 Encode Char.</b>	<b>Keystroke</b>
1022	\$V	CTRL V
1023	\$W	CTRL W
1024	\$X	CTRL X
1025	\$Y	CTRL Y
1026	\$Z	CTRL Z
1027	%A	CTRL [
1028	%B	CTRL \
1029	%C	CTRL ]
1030	%D	CTRL 6
1031	%E	CTRL -
1032	Space	Space
1033	/A	!
1034	/B	"
1035	/C	#
1036	/D	\$
1037	/E	%
1038	/F	&
1039	/G	'
1040	/H	(
1041	/I	)
1042	/J	*
1043	/K	+
1044	/L	,
1045	-	-
1046	.	.
1047	/	/
1048	0	0



---

<b>ASCII Value</b>	<b>Full ASCII Code 39 Encode Char.</b>	<b>Keystroke</b>
1049	1	1
1050	2	2
1051	3	3
1052	4	4
1053	5	5
1054	6	6
1057	7	7
1056	8	8
1057	9	9
1058	/Z	:
1059	%F	;
1060	%G	<
1061	%H	=
1062	%I	>
1063	%J	?
1064	%V	@
1065	A	A
1066	B	B
1067	C	C
1068	D	D
1069	E	E
1070	F	F
1071	G	G
1072	H	H
1073	I	I
1074	J	J
1075	K	K



## LS 5700/LS 5800 Product Reference Guide

---

<b>ASCII Value</b>	<b>Full ASCII Code 39 Encode Char.</b>	<b>Keystroke</b>
1076	L	L
1077	M	M
1078	N	N
1079	O	O
1080	P	P
1081	Q	Q
1082	R	R
1083	S	S
1084	T	T
1085	U	U
1086	V	V
1087	W	W
1088	X	X
1089	Y	Y
1090	Z	Z
1091	%K	[
1092	%L	\
1093	%M	]
1094	%N	^
1095	%O	_
1096	%W	'
1097	+A	a
1098	+B	b
1099	+C	c
1100	+D	d
1101	+E	e
1102	+F	f

---

<b>ASCII Value</b>	<b>Full ASCII Code 39 Encode Char.</b>	<b>Keystroke</b>
1103	+G	g
1104	+H	h
1105	+I	i
1106	+J	j
1107	+K	k
1108	+L	l
1109	+M	m
1110	+N	n
1111	+O	o
1112	+P	p
1113	+Q	q
1114	+R	r
1115	+S	s
1116	+T	t
1117	+U	u
1118	+V	v
1119	+W	w
1120	+X	x
1121	+Y	y
1122	+Z	z
1123	%P	{
1124	%Q	
1125	%R	}
1126	%S	~
1127		Undefined



## LS 5700/LS 5800 Product Reference Guide

---

<b>ALT Keys</b>	<b>Keystroke</b>	<b>Misc. Key</b>	<b>Keystroke</b>
2064	ALT 2	3001	PA 1
2065	ALT A	3002	PA 2
2066	ALT B	3003	CMD 1
2067	ALT C	3004	CMD 2
2068	ALT D	3005	CMD 3
2069	ALT E	3006	CMD 4
2070	ALT F	3007	CMD 5
2071	ALT G	3008	CMD 6
2072	ALT H	3009	CMD 7
2073	ALT I	3010	CMD 8
2074	ALT J	3011	CMD 9
2075	ALT K	3012	CMD 10
2076	ALT L	3013	¥
2077	ALT M	3014	£
2078	ALT N	3015	¤
2079	ALT O	3016	¬
2080	ALT P	3017	°
2081	ALT Q	3018	1/2
2082	ALT R	3019	¶
2083	ALT S	3020	§
2084	ALT T	3021	
2085	ALT U	3022	0/00
2086	ALT V		
2087	ALT W		
2088	ALT X		
2089	ALT Y	<b>PF Keys</b>	<b>Keystroke</b>
2090	ALT Z	4001	PF 1
2091	ALT [	4002	PF 2
2092	ALT \	4003	PF 3
2093	ALT ]	4004	PF 4
2094	ALT 6	4005	PF 5
2095	ALT -	4006	PF 6

---

<b>PF Keys</b>	<b>Keystroke</b>	<b>F Keys</b>	<b>Keystroke</b>
4007	PF 7	5010	F 10
4008	PF 8	5011	F 11
4009	PF 9	5012	F 12
4010	PF 10	5013	F 13
4011	PF 11	5014	F 14
4012	PF 12	5015	F 15
4013	PF 13	5016	F 16
4014	PF 14	5017	F 17
4015	PF 15	5018	F 18
4016	PF 16	5019	F 19
4017	PF 17	5020	F 20
4018	PF 18	5021	F 21
4019	PF 19	5022	F 22
4020	PF 20	5023	F 23
4021	PF 21	5024	F 24
4022	PF 22	5025	F 25
4023	PF 23	5026	F 26
4024	PF 24	5027	F 27
		5028	F 28
		5029	F 29
<b>F Keys</b>	<b>Keystroke</b>	5030	F 30
5001	F 1	5031	F 31
5002	F 2	5032	F 32
5003	F 3	5033	F 33
5004	F 4	5034	F 34
5005	F 5	5035	F 35
5006	F 6	5036	F 36
5007	F 7	5037	F 37
5008	F 8	5038	F 38
5009	F 9	5039	F 39



## LS 5700/LS 5800 Product Reference Guide

---

<b>Numeric Keypad</b>	<b>Keystroke</b>	<b>Extended Keypad</b>	<b>Keystroke</b>
6042	*	7001	Break
6043	+	7002	Delete
6044	Undefined	7003	Pg Up
6045	-	7004	End
6046	.	7005	Pg Dn
6047	/	7006	Pause
6048	0	7007	Scroll Lock
6049	1	7008	Backspace
6050	2	7009	Tab
6051	3	7010	Prnt Screen
6052	4	7011	Insert
6053	5	7012	Home
6054	6	7013	Enter
6055	7	7014	Escape
6056	8	7015	Up Arrow
6057	9	7016	Dn Arrow
6058	Enter	7017	Left Arrow
6059	Num Lock	7018	Right Arrow
6060	00	7019	Back Tab



# *Index*

---

## **A**

- accessories ..... 4-3
- AIM code identifiers ..... A-3
- ASCII values ..... A-7–A-14
- auxiliary options
  - RS-232C ..... 5-56

## **B**

- bar codes, scanning ..... 3-1
- beeper ..... 2-20
- beeper definitions ..... 4-8
- bullets ..... ix

## **C**

- code types & options ..... 3-5, 5-92
  - Bookland-EAN ..... 5-100
  - codabar ..... 5-135
  - code 128 ..... 5-110
  - code 39 ..... 5-115
  - code 39 check digit verification ..... 5-124
  - code 39 full ASCII ..... 5-117
  - EAN-13 ..... 5-98
  - EAN-8 ..... 5-96
  - interleaved 2 of 5 ..... 5-126
  - interleaved 2 of 5 check digit verification
    - OPCC ..... 5-133
    - USS ..... 5-132
  - lengths
    - CLSI editing ..... 5-141
    - codabar ..... 5-137



code 128	5-114
code 39	5-120
interleaved 2 of 5	5-128
NOTIS editing	5-143
UCC/EAN coupon code	5-105, 5-107
UCC/EAN-128	5-112
UPC/EAN supplementals	5-102
UPC-A	5-92
UPC-E	5-94
connecting	
dual-port RS-232C	2-7
hand-held laser scanner	2-8
IBM 468x/469x	
Port 5B RS-232C	2-5
Port 9E/ Port 17	2-4
RS-232C host	2-6
synapse host	2-5
connectors	2-22
controls	2-20
conventions, notational	ix
custom tailoring	3-5, 5-145, 5-168
beeper frequency	5-155
beeper volume	5-152
decode buffering	5-160
internal beeper	5-148
primary decode session time	5-168
rest mode	5-162
RS-232C port external beeper	5-150
scanning range	5-145
sleep mode	5-163
time delay to rest/sleep mode	5-164
time-out between decodes, different symbols	5-159
time-out between decodes, same symbol	5-158



## D

---

data transmission format	3-7
beep after good decode	5-222
convert EAN-8 to EAN-13 type	5-214
convert I 2 of 5 to EAN-13	5-216
convert UPC-E to UPC-A	5-210
data format cancel	5-245
EAN zero extend	5-212
ignore unknown characters	5-243
intercharacter delay	5-224
pause duration	5-228
prefix/suffix values	5-229
scan data transmission format	5-233
serial data transmission format	5-238
transmit code 39 check digit	5-220
transmit code ID character	5-225
transmit I 2 of 5 check digit	5-218
transmit UPC-A check digit	5-200
transmit UPC-E check digit	5-202
UPC/A preamble	5-204
UPC-A preamble	5-204
UPC-E preamble	5-208
data transmission formats	5-200
decode options	3-6, 5-169
code 128 decode performance	5-190
code 39 decode performance	5-195
decode redundancy for UPC/EAN	5-180
linear code type security	5-186
linear supplemental decode	5-178
UPC/EAN decode performance	5-181
UPC/EAN security level	5-172
default	5-5



default parameter	5-5
default table	5-6
Disable	5-144
disable	
Bookland-EAN	5-101
CLSI editing	5-142
codabar	5-136
code 128	5-111
code 39	5-116
code 39 check digit verification	5-125
code 39 full ASCII	5-119
EAN-13	5-99
EAN-8	5-97
interleaved 2 of 5	5-127
interleaved 2 of 5 check digit verification	5-134
NOTIS editing	5-144
UCC/EAN coupon code	5-106
UCC/EAN-128	5-113
UPC-A	5-93
UPC-E	5-95
dual port RS-232C	2-7

## **E**

EAS	1-2, 2-10
EAS interlock	5-11
disable	5-12
enable	5-11
enable	
Bookland-EAN	5-100
CLSI editing	5-141
codabar	5-135
code 128	5-110
code 39	5-115

---

code 39 check digit verification	5-124
code 39 full ASCII	5-118
EAN-13	5-98
EAN-8	5-96
interleaved 2 of 5	5-126
NOTIS editing	5-143
UCC/EAN coupon code	5-105
UCC/EAN-128	5-112
UPC-A	5-92
UPC-E	5-94
errors while scanning	3-4

## H

hand-held laser scanner	
connecting	2-8
hand-held laser scanner options	5-85
beep after good decode	5-90
program all scanners	5-89
program hand-held scanner only	5-85
program LS2603MX/LS 3603MX/LS 3203 only	5-87
program primary scanner only	5-86
program primary scanner only with LS 2603MX/LS3603MX/LS 3203	5-88
hardware handshaking	5-35
host options	
RS-232C	5-19
host types	3-5
RS-232C	5-13

## I

information, service	x
input/output ports	2-2



hand-held laser scanner port	2-3
host port	2-3
power-in port	2-2
RS-232C port	2-3

## L

### lengths

codabar	5-137
code 128	5-114
code 39	5-120
interleaved 2 of 5	5-128

## M

maintenance	4-1
mounting	
LS 5700	2-12
LS 5800	2-14
stainless steel top	2-16

## N

notational conventions	ix
------------------------	----

## P

parameter menus	5-1
EAS interlock	5-11
RS-232C host types	5-13
RS-232C port auxiliary options	5-56
RS-232C port host options	5-19
set default	5-5
programming	3-4
programming utilities	3-7, 5-246
application items	5-258
cancel	5-256

---

enter .....	5-257
numeric bar codes .....	5-246

**R**

random weight check digit .....	5-107
related publications .....	.ix
replacing other Symbol scanners .....	2-18
rest/sleep mode .....	3-2
routine maintenance .....	4-1
RS-232C host types .....	5-13
fujitsu .....	5-18
ICL .....	5-17
nixdorf .....	5-16
no host .....	5-14
single port .....	5-15
RS-232C port auxiliary options .....	5-56
ASCII format .....	5-81
baud rate .....	5-57
check parity .....	5-70
hardware handshaking .....	5-72
none .....	5-74
standard RTC/CTS .....	5-75
parity .....	5-65
even .....	5-66
mark .....	5-67
none .....	5-69
odd .....	5-65
space .....	5-68
serial response time-out .....	5-78
software handshaking .....	5-76
none .....	5-76
ON/XOFF .....	5-77



stop bit select	5-79
RS-232C port host options	5-19
ASCII format	5-50
baud rate	5-20
beep on bel	5-54
check parity	5-33
do not beep on bel	5-55
do not check parity	5-34
hardware handshaking	5-35
none	5-37
RTS/CTS Option 1	5-39
RTS/CTS Option 2	5-40
standard	5-38
parity	5-28
even	5-29
mark	5-30
none	5-32
odd	5-28
space	5-31
serial host RTS line state	5-52
serial response time-out	5-47
software handshaking	5-42
ACK/NAK	5-43
ACK/NAK with ENQ	5-45
ENQ	5-44
none	5-42
stop bit select	5-48
RS-232C port options	3-5

## S

scanning bar codes	3-1
scanning made easy	1-1
scanning sequence	3-4

sequential lists .....	ix
service information .....	x
set default parameter .....	5-5
set up .....	2-1
setting parameters .....	3-5
code types and options .....	3-5
custom tailoring .....	3-5
data transmission formats .....	3-7
decode options .....	3-6
host types & options .....	3-5
programming utilities .....	3-7
RS-232C port options .....	3-5
software handshaking .....	5-42
Symbol Support Center .....	xi

**T**

technical specifications .....	4-4
--------------------------------	-----

**U**

UCC/EAN-128 .....	A-1
unpacking .....	2-1

**W**

what if .....	3-3
---------------	-----



*LS 5700/LS 5800 Product Reference Guide*

---