



# Quick Check® 600/800 Series

*Bar Code Verifiers*



# User's Guide

---

## ***Disclaimer***

Hand Held Products, Inc. ("Hand Held Products") reserves the right to make changes in specifications and other information contained in this document without prior notice, and the reader should in all cases consult Hand Held Products to determine whether any such changes have been made. The information in this publication does not represent a commitment on the part of Hand Held Products.

Hand Held Products shall not be liable for technical or editorial errors or omissions contained herein; nor for incidental or consequential damages resulting from the furnishing, performance, or use of this material.

This document contains proprietary information that is protected by copyright. All rights are reserved. No part of this document may be photocopied, reproduced, or translated into another language without the prior written consent of Hand Held Products.

© 2001-2007 Hand Held Products, Inc. All rights reserved.

Web Address: [www.handheld.com](http://www.handheld.com)

## ***For European Community Users***

Hand Held Products complies with Directive 2002/69/EC OF THE EUROPEAN PARLIAMENT AND OF THE COUNCIL of 27 January 2003 on waste electrical and electronic equipment (WEEE).

## ***Waste Electrical and Electronic Equipment Information***

This product has required the extraction and use of natural resources for its production. It may contain hazardous substances that could impact health and the environment, if not properly disposed.

In order to avoid the dissemination of those substances in our environment and to diminish the pressure on the natural resources, we encourage you to use the appropriate take-back systems for product disposal. Those systems will reuse or recycle most of the materials of the product you are disposing in a sound way.



— The crossed out wheeled bin symbol informs you that the product should not be disposed of along with municipal waste and invites you to use the appropriate separate take-back systems for product disposal.

If you need more information on the collection, reuse, and recycling systems, please contact your local or regional waste administration.

You may also contact your supplier for more information on the environmental performances of this product.

---

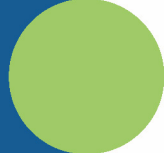

# Table of Contents

## ***Chapter 1 - Getting Started***

About This Guide .....	1-1
Unpacking the Quick Check 600/800 Verifier .....	1-2
Noting the Verifier's Features.....	1-3
Specifications.....	1-7
Installing the Batteries .....	1-7
Charging the Batteries.....	1-8
Turning the Unit On and Off.....	1-9
Calibrating the Quick Check 600/800 Verifier .....	1-12
Properly Scanning With the Unit .....	1-13
Cleaning the Wand.....	1-14
Accessories and Options .....	1-14

## ***Chapter 2 - Quick Start Guide***

## ***Chapter 3 - Changing the Settings***

Changing the Specifications .....	3-1
Symbologies.....	3-2
Symbology Specifications.....	3-3
Magnification Factor.....	3-4
Expand U.P.C./EO .....	3-4
Check Options.....	3-4
Modes Shown.....	3-4
Character Font & Tolerances .....	3-5
Wide-to-Narrow Ratio .....	3-6
Fixed Message Length .....	3-6
Industry Applications .....	3-7
Changing the Test Criteria.....	3-8
Scan Grade .....	3-8
Decodability .....	3-9
ISO/IEC grades .....	3-9
Number of Scans .....	3-9

---

Changing the Scanning Options .....	3-10
Beeper Pitch .....	3-11
Extended Accuracy .....	3-11
Decode Direction .....	3-11
Changing the Output Options .....	3-12
Display Options.....	3-12
Parameter Result Lines .....	3-12
Print Options .....	3-13
AutoPrint/Store .....	3-13
Scan Profile .....	3-14
Resetting the Default Settings .....	3-15
Locking the Settings .....	3-15
Using a Command Code.....	3-16
About Command Codes .....	3-16
Choosing a Command Code.....	3-18
Customized Command Codes .....	3-18

#### ***Chapter 4 - Reviewing Scan Data***

Reviewing Scan Results .....	4-1
Scan Grades .....	4-1
ISO/IEC Symbol Grade.....	4-2
Reviewing a Scan Example .....	4-5
LED Display .....	4-7
Audio Sounds.....	4-8
Reviewing the Dimensional Parameters.....	4-9
Errors in Dimensional Parameters .....	4-9
Calculating X .....	4-10
Reviewing the Reflectance Parameters .....	4-11
Errors in Reflectance Parameters .....	4-12
Reviewing the Format Parameters.....	4-14
Errors in Format Parameters .....	4-14
Reviewing Messages.....	4-15
Using SSTR Codes to Review Data.....	4-16
Using the Quick Check Verifier as a Reflectometer .....	4-17

---

## ***Chapter 5 - Saving and Printing***

Saving Data.....	5-1
Checking the Print Buffer During Operation.....	5-1
Printing Data.....	5-2
Deleting Stored Data.....	5-3
Interfacing With a Computer.....	5-4
Reviewing the Printouts.....	5-4
Printing Guidelines.....	5-6
Using the QCP or QCHSP.....	5-6
Troubleshooting the QCP or QCHSP.....	5-11

## ***Chapter 6 - Background Information***

General Bar Code Information.....	6-1
Symbology Specifications.....	6-2
Symbologies.....	6-2
Symbology Characteristics.....	6-4
How a Bar Code Verifier Works.....	6-6
Additional Information.....	6-7

## ***Chapter 7 - Using DataMatch***

Understanding the DataMatch Feature.....	7-1
Downloading DataMatch.....	7-1
Structuring and Loading the Database.....	7-1
Selecting the DataMatch Feature.....	7-4
Reviewing DataMatch Results.....	7-5

## ***Chapter 8 - Using a Quick Check 800 Verifier***

Using the Quick Check 800 Verifier with a QC3800V Linear Imager.....	8-1
General Operation.....	8-1
Reflectance-Based Information.....	8-2
ScanProfile Output.....	8-2
Percent Decoded/Scanned Mode.....	8-2

---

***Chapter 9 - Error, Application, and Type Messages***

***Chapter 10 - Flow Charts***

***Chapter 11 - SSTR Codes***

***Chapter 12 - Special Codes***

***Chapter 13 - Unrecognized Symbols***

Unrecognized Symbols..... 13-1

***Chapter 14 - Customer Support***

Troubleshooting..... 14-1  
Technical Assistance ..... 14-1  
Online Technical Assistance..... 14-2  
For Further Information..... 14-2  
Product Service and Repair ..... 14-2  
Online Product Service and Repair Assistance ..... 14-3  
Limited Warranty..... 14-3

## *About This Guide*

This manual contains information on the Quick Check® 600/800 Series Bar Code Verifiers. It describes all the features and functions of the Quick Check 600/800 Verifier and all the industry applications that can be enabled on the Quick Check 600/800 Verifier. Your particular Quick Check Verifier may have fewer applications.

This manual is organized into the following chapters:

- Chapter 1 Getting Started
- Chapter 2 Quick Start Guide
- Chapter 3 Changing the Settings
- Chapter 4 Reviewing Scan Data
- Chapter 5 Saving and Printing
- Chapter 6 Background Information
- Chapter 7 Using DataMatch
- Chapter 8 Using a Quick Check 800 Verifier  
(Specific to the Quick Check 800 Verifier **only**)
- Chapter 9 Error, Application, and Type Messages
- Chapter 10 Flow Charts
- Chapter 11 SSTR Codes
- Chapter 12 Special Codes
- Chapter 13 Unrecognized Symbols
- Chapter 14 Customer Support

This manual uses several special symbols to refer to the controls on the instrument. The following table shows the symbols and their descriptions.

Symbol	Description
<b>POWER</b> or <b>SELECT</b> or ↑, ↓, ←, →	Represents a button on the Quick Check Verifier unit
Scan or Low Battery	Shows the LED display on the Quick Check unit
◆	Indicates steps to follow to perform a procedure

Some terms used in this manual may differ slightly from the terms used in the Quick Check Verifier software menus due to space restrictions. The following table shows these terms.

Term in manual	Term in software
W/N	WN
U.P.C. (Universal Product Code)	UPC

## *Unpacking the Quick Check 600/800 Verifier*

When you first receive your Quick Check 600/800 Verifier, you should unpack it carefully. Before attempting to use the instrument, inspect the contents of the package for any shipping damage. If there is evidence of damage, please keep all packing materials and contact the delivery carrier **as soon as possible** for claim procedure.

Confirm that you have the following items:

- Quick Check 600/800 Verifier
- Wand scanner (specific to the QC600 series)
- Linear Imager (specific to the QC800 series)
- AC Charger
- Four “AA” NiCad batteries
- Quick Check 600/800 Verifier User’s Guide (this publication)
- Manual Package containing:
  - Test Symbols
  - Warranty Card
  - Gauge Ruler



---

“X” Dimension Ruler  
QCRFPG Calibration Reflectance Bar Code Page

If you do not have all these items, contact your sales representative.

### *Noting the Verifier’s Features*

The Quick Check 600/800 Verifier is a full-featured bar code verifier compatible with all major linear bar code symbologies. It is suitable for desktop use in the office and is easily carried for portable verification in the field. It is both a quick and easy to use pass/fail tester for bar code symbols and a powerful measuring tool for detailed testing of these same symbols.

All the information you need to interpret overall symbol quality is available. The Quick Check 600/800 Verifier unit is housed in a compact and lightweight impact resistant case.

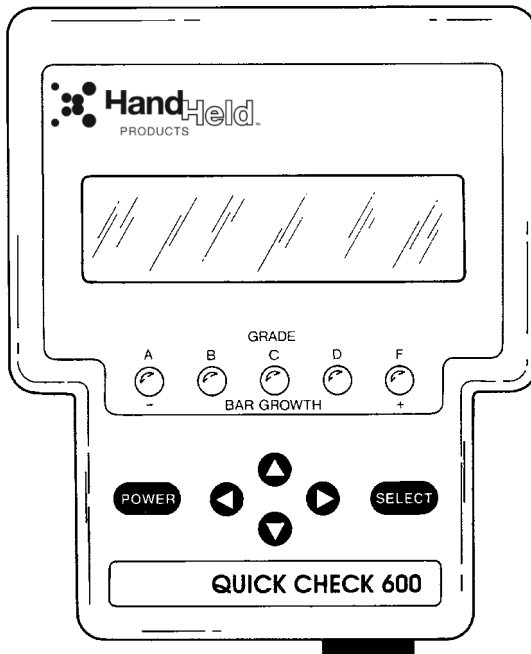

**Quick Check 600/800 Verifier**

---

The symbologies tested by the verifier include

- EAN/UPC
- Code 39
- Interleaved 2 of 5
- Code 128
- Code 93
- Codabar
- Code 11
- Code 16K
- Code 49
- MSI
- IATA 2 of 5
- Interleaved 2 of 5

Each model of the Quick Check 600/800 Verifier is capable of testing either all, none, or different sets of industry applications. If you are not sure which applications are available on your unit, refer to ["Changing the Specifications" on page 3-1](#) of this manual to display a list of available applications. Industry standard symbols (applications) tested by the Quick Check 600/800 Verifier include:

- AIAG
- CTIA/ABCD
- LOGMARS
- SCC
- Coupon Code
- HIBC
- CCBBA
- SISAC
- BOOKLAND

The Quick Check 600/800 Verifier provides the following types of scan data:

- Type of symbology verified
- ISO/IEC and traditional print quality results
- Uniformity in bar guard size (UPC)
- Data string identifiers
- Application identifiers
- Function characters
- Data check characters
- Bar/Space dimensional indication and measurement
- Wide/Narrow ratio measurement
- Character format verification
- Quiet zone tests
- With a printer, hardcopy results and ISO/IEC scan profiles
- Profile

---

You can customize the settings for specifications, test criteria, scanning options, and output options to your preferences. These options are described in *Chapter 3, Changing the Settings*.

## ***Display***

The liquid crystal display (LCD) provides four lines of text, each with up to 20 characters per line. The four lines allow you to quickly and easily review a large amount of scan data and view a variety of options. Some text, such as the word "SCAN," is displayed in a larger size for easier reading. Each scan grade and the resulting ISO/IEC symbol grade appear in a large letter or number on the right of the display.

While the scan and symbol grade look the same, the difference is clear. The second line of a symbol grade display states it is a symbol grade, either running or final. For additional information, refer to *Chapter 4, Reviewing Scan Data*

## ***LEDs***

If you set the verifier to evaluate symbols using traditional methods, the light-emitting diodes (LEDs) indicate bar growth and shrinkage. If you set the verifier to use ISO/IEC evaluation criteria, the LEDs display the ISO/IEC grade. For your convenience, the display option feature called LEDs allows you to select ISO/IEC test criteria, yet have the LEDs display bar growth rather than pass or fail. See "Changing the Output Options" on page 3-12 for additional information.

## ***Buttons***

You can review the software selections using the four arrow buttons (↓,↑,←,→) and the SELECT button. The arrows allow you to move the on-screen cursor. If the scan data length exceeds the display length, a right-hand arrow appears as the right character of the display. Press → to review the additional data and then press ← to restore the original display.

## ***Audio Sound***

An audio signal gives you a quick indication if a scan passes or fails the current test. You can change the pitch/volume of these beeps. After a scan, one beep indicates that the symbol passes an appropriate battery of tests, while three beeps indicate that it fails in some regard.

## ***Special Features***

In addition, the Quick Check 600/800 Verifier has a database feature. You can connect the verifier to your computer and download a database into the verifier. While scanning, the verifier can provide additional information about the scanned code; for example, the name of the product. More information about the database feature is provided in *Chapter 7, Using DataMatch*.

---

The Quick Check 600/800 Verifier also supports two customized operational modes: Reflectometer mode and Command Code function. In the Reflectometer mode, the unit operates as a free-running reflectometer. ["Using the Quick Check Verifier as a Reflectometer" on page 4-17](#) contains information about reflectometer mode. The Command Code is a specially structured bar code symbol that offers a unique way for you to quickly program the settings. *Chapter 3, Changing the Settings*, contains instructions on changing the settings. This manual contains separate and versatile bar code menus to Single-Scan-to-Result (SSTR) Codes or to customize the unit (Command Code).

## ***Ports***

The ports on the back of the unit connect to a recharging unit or to a printer interface cable. The smaller port is for charging the unit. The larger port connects to RS-232 serial communication devices, such as Hand Held Products' QCP and QCHSP printers.

The port on the front of the unit connects to the pen or mouse wand scanner. A wand scanner holder, on the back of the unit, secures the wand when it is not in use.

---

## Specifications

Item	Specification
Dimensions	4.30"W x 2.75"H x 5.25"D (10.9 cm W x 7.0 cm H x 13.3 cm D)
Weight	1.0 lb. (454 g) with wand attached and batteries installed
Temperature	Storage: -20° to 70°C Operational: 0° to 50°C
Humidity	5% to 95% RH non condensing
Sealability	Designed to meet NEMA 1
Regulatory approvals	FCC - Class A limits
Display	4 x 20 characters/line LCD
Keypad	6-button: POWER, SELECT, ↑, ↓, ←, →
Audible signal	Volume/tone adjustable beeper (includes volume off position)
LED indicators	Five tri-colored LEDs
Batteries	Four "AA" NiCad
Data Buffer	32 KB; the onboard memory can store data and scan profiles.

## Installing the Batteries

The Quick Check 600/800 Verifier is shipped with four "AA" NiCad rechargeable batteries. You must install the batteries in the unit before you use it. The batteries may be discharged and need to be charged.



### WARNING

You must install the four NiCad rechargeable batteries in the Quick Check 600/800 Verifier before you connect the charger or the printer to the unit. If you do not install the batteries first, you may damage the unit and consequently void the warranty. Use only the supplied batteries. If you use other types of batteries (such as alkaline) and attempt to recharge them, you could cause the batteries to explode, damage the unit, and possibly cause a personal injury. Damage caused by attempts to recharge any batteries, except those supplied with the unit, voids any and all Quick Check 600/800 Verifier warranties.

---

---

### ◆ To Install the Batteries

1. Slide off the battery cover on the bottom of the unit.
2. Insert the four batteries into the compartment, matching the “+” on the battery ends with the “+” on the bottom of the compartment, and press each battery into place.
3. Slide the battery cover back in place.

## *Charging the Batteries*

The Quick Check 600/800 Verifier uses rechargeable batteries. An AC charger is supplied to recharge these batteries. The Quick Check 600/800 Verifier is intended to be powered from the batteries, not directly from an adapter or AC outlet. With a set of properly charged batteries, the unit operates continuously for a minimum of 1.5 hours. When not in use, you can leave the unit connected to the charger. To extend the battery life, battery manufacturers recommend you fully charge the unit, use it until the batteries are *completely* discharged, and then fully charge the batteries.

A `Low Battery` message on the bottom line of the opening display may appear when you power up your Quick Check 600/800 Verifier or during use. When this message appears, you cannot scan bar code symbols, but you can perform other operations, such as changing the settings. If you turn the unit off and then on again, the `Low Battery` message may disappear momentarily, but reappears when the batteries are discharged more.

The `Low Battery` message appears before the battery is completely discharged to preserve proper unit operation. However, this message may appear for a variety of other reasons including variations in battery power, temperature, component efficiency, or rapid cycle time. If your battery has not lasted for a continuous hour and a half of operation, and you suspect a low battery is *not* the cause for the message, turn the unit off and then on again. If the message reappears immediately on power up, the batteries are discharged and you should recharge the unit. If the message does not reappear, you can continue to use the unit. If you think there is a problem with your batteries, contact Hand Held Products.

### ◆ To charge the batteries:

1. Turn off the verifier.
2. Plug the AC charger into the port on the back of the unit.
3. Plug the AC charger into a VAC wall outlet.
4. The batteries start charging. If you have completely discharged the batteries, charge them for a minimum of 12 hours. If the batteries are partially discharged, charge them for less time.
5. After charging, remove the AC charger from the unit. The verifier is ready for use.

---

## Turning the Unit On and Off

When you turn on the verifier, it contains the settings stored from the last time you changed them. *Chapter 3, Changing the Settings* describes these settings and provides instructions for changing them.

The verifier shuts itself off after a minute of inactivity to conserve battery power. You can also turn the unit off at any time. When you turn off the unit, the setting options you selected are automatically saved. There is no need for a separate save command.

Insert the wand scanner into the port on the front of the unit.

### ◆ To turn on the unit:

1. Press the **POWER** button.

The unit emits four quick beeps and displays the opening screen. The upper lines of the opening display show the Quick Check 600/800 Verifier model number. The bottom line of the opening display provides a variety of information. If the bottom line of the opening display states:

- Low Battery, then charge the batteries as described previously.
- Recalibrate, then calibrate the unit as described later in this chapter.
- Other information as described below. Review it and then scan a bar code symbol.
- If the unit was set to verify an industry application (rather than symbologies) before being turned off, the bottom line of the opening display shows the name of the application that was in use.

If the unit was set to verify symbologies before being turned off, the bottom line shows the spectral response of the wand scanner connected to the unit, such as 660 nanometers (nm) and the wand aperture size for the unit such as 6 mils (one thousandth of an inch).

"[Accessories and Options](#)" on page 1-14 describes the available wands. The wavelength and aperture described are necessary to obtain the proper symbol grade.

If the unit was set to use the database feature before being turned off, the bottom line shows the term **DATABASE**.

X Dimension inches (mm)	Measuring Aperture	
	Diameter inches (mm)	Number
0.004 (0.102) ≤ X < 0.007 (0.178)	0.003 (0.076)	03
0.007 (0.178) ≤ X < 0.013 (0.330)	0.005 (0.127)	05
0.013 (0.330) ≤ X < 0.025 (0.635)	0.010 (0.254)	10
0.025 (0.635) ≤ X	0.020 (0.508)	20

---

*Note: 6 mil (0.006 inch) diameter aperture is recommended for EAN/UPC.*

2. The display that follows the opening screen depends on two conditions: whether a printer is available, and how the AutoPrint/Store feature is set. If the first line of the display states:

- No Printer Attached, then refer to [step 2.a](#)
- Print Buffer, then refer to [step 3](#).

2.a If a No Printer Attached message appears, it indicates that a printer is not available to the verifier; that is, the verifier is not connected to a printer, or the verifier is connected to a printer but the printer is turned off. The second line of this display provides both the percent of the memory used for the stored records and the number of scan records in the memory. If there are no stored records, both values are zero.

Depending on the status of the AutoPrint/Store feature (on or off), you have different ways to respond to this display.

If the AutoPrint/Store feature is set to On (the default), you can:

- Continue with the AutoStore
- Clear
- Change

The cursor is at the asterisk next to the term Continue with AutoStore.

- 2.b To continue obtaining scan results with the AutoPrint/Store feature setting On, press **SELECT**. After a scan, the results appear on the display and are automatically stored in the memory. The previously stored results remain in the memory.
- 2.c To clear (delete) the records stored in the memory, press ↓ to place the cursor on the asterisk next to the term Clear and then press **SELECT**. The stored results and the result from the last scan are deleted from the Quick Check 600/800 Verifier's memory.
- 2.d To change the AutoPrint/Store feature setting to Off, press ↓ and → to place the cursor on the asterisk next to the term Change and then press **SELECT**. The Change settings printout options display appears. Press → to change the setting to Off. After a scan, the results appear on the display, but are not automatically stored in the memory. The previously stored results remain in the memory.



---

If the AutoPrint/Store feature is set to Off, you can:

- Continue
- Clear
- Continue with AutoStore

The cursor is at the asterisk next to the term `Continue`.

- 2.e To continue obtaining scan results with the AutoPrint/Store feature setting `Off`, press **SELECT**. After a scan, the results appear on the display but are not automatically stored in the memory. The previously stored results remain in the memory.
- 2.f To clear (delete) the records stored in the memory, press `→` to place the cursor on the asterisk next to the term `Clear` and then press **SELECT**. The stored results and the results from the last scan are deleted from the Quick Check 600/800 Verifier's memory.
- 2.g To continue obtaining scan results but change the Auto Print/Store feature setting to `On`, press `↓` to move the cursor to the asterisk next to the terms `Continue w/AutoStore` and then press **SELECT**. After a scan, the results appear on the display and are automatically stored in the memory. The previously stored results remain in the memory.

3. If a `Print Buffer` message appears, it indicates a printer is available (the Quick Check 600/800 Verifier is connected to a printer that is turned on) and the Auto Print/Store feature setting is `On`. The second line of this display provides both the percent of the memory used for the stored records and the number of scan records in the memory. If there are no stored records, both values are zero. You can

- Continue
- Print
- Clear

The cursor is at the asterisk next to the term `Continue`.

- 3.a To continue obtaining scan results, press **SELECT**. The opening display appears. You can then scan a symbol. The scan results print on the printer. The previously stored results remain in the memory.
- 3.b To print the stored records, press `↓` to place the cursor on the asterisk next to `Print`. Then press **SELECT**. The stored records print. Once printed, the stored results are removed from the Quick Check 600/800 Verifier's memory, however, the results from the last scan remaining in the buffer. (Press `←` at the opening menu to display the last scan's results.)

- 
- 3.c To clear (delete) the records stored in the memory, press ↓ and → to place the cursor on the asterisk next to the term **C**lear and then press **SELECT**. The stored results and the result from the last scan are deleted from the Quick Check 600/800 Verifier's memory.

◆ **To turn off the unit:**

1. Press and hold down **POWER** for about two seconds until the unit beeps once and clears the display.

OR

Let the unit turn itself off.

If the unit is connected to a charger, it turns off after ten minutes of inactivity. If the unit is not connected to a charger, it turns off after one minute of inactivity.

*Note: If the unit turned itself off and you want to review the results of the last scan, press **POWER** to turn on the unit and then press ←. The results from the last scan appear.*

## ***Calibrating the Quick Check 600/800 Verifier***

Even though the verifier is calibrated at the factory, you should calibrate it before its first use to ensure its accuracy. For continued accuracy, periodically calibrate the unit during normal operation. You calibrate the unit using a reflectance page that is included in the pack of accessories. Each page has a serial number on it. For accurate calibration and data collection, you scan the reflectance page ten times and the Quick Check 600/800 Verifier performs a consistency test. If it passes, the unit is calibrated.

If, during the measurement of a symbol, a scan reflectance value of XX or — — appears on the display or on a printout, an out-of-range reading was recorded. Recalibrate the unit and then rescan the symbol.

The reflectance page is a precision standard made of photographic materials. If it becomes physically damaged or dirty, replace it to insure proper calibration. To order a new reflectance page, contact your sales representative.

◆ **To calibrate the Quick Check 600/800 Verifier:**

1. Using the proper scan technique, scan the reflectance symbol from the accessory pack. You will hear a long beep followed by two short beeps after the first good scan, and the LCD displays REFLECTANCE CALIBRATION -9- More Scans!.
2. Continue to scan the reflectance page for a total of ten good scans. After each good scan, a single beep sounds and the display indicates how many good scans you need to obtain. After the tenth good scan, three beeps sound and the message Now Lift the Scanner Up off the Target appears. When you lift the scanner up, the opening display appears. To scan, set the wand scanner on a symbol's quiet zone.

---

Three beeps (one long followed by two short beeps) sound if the unit detects reflectance readings significantly different from the previously recorded ones. You may be scanning too slowly, too quickly or unevenly, or using an improper scan angle. A message appears and prompts you to begin again. Continue scanning using the recommended scanning technique until the unit is calibrated.

## ***Properly Scanning With the Unit***

Variations in scan rates and angles can affect bar code verification. Before you begin collecting data, review and practice the recommended method for whichever configuration you are using, the pen wand or the mouse wand.

### **◆ To scan properly using a pen wand:**

1. Turn on the verifier and confirm that it is operational (that is, does not need to be charged or calibrated).
2. Hold the pen wand as you would a pen or pencil, placing your fingers on each side of the foot near the tip.
3. Lightly touch the scanner tip against either quiet zone (clear area) of the bar code. You have the proper scanning angle when the tip and the reflectance guide are flat on the scan surface. (If the unit does not respond, press **POWER**.)
4. At about the same speed with which you would quickly underline a sentence in this manual, and without interruption, gently drag the tip across the center of the bar code. You do not need to press the tip on the bar code. Gentle pressure on the tip will not scratch the contacted surface.
5. Listen for audible tones.
  - If you hear a long beep tone followed by a short tone, it signifies a good read.
  - If you hear a long beep and then three short beeps, the unit detects an error in the scanned symbol.
  - If one of these messages appears *slowly, please!; faster, please!; or more evenly, please!*; adjust your scan technique accordingly. If a symbol consistently produces no beeping, it is either fatally out of spec or it is not one of the symbologies programmed on the unit.
  - If you receive a message about a bad quiet zone, you may have started scanning too close to the first bar. Rescan the symbol, starting a little farther away from the first bar.
6. Practice your scanning technique until you can successfully scan, on the first attempt, each of the test symbols supplied with the verifier.

### **◆ To scan properly using a mouse wand:**

1. Turn on the Quick Check 600/800 Verifier and confirm that it is operational (that is, does not need to be charged or calibrated).

2. Hold the mouse wand as you would a computer mouse, placing your fingers on each side of the mouse near the front.
3. Lightly pass the mouse wand over either quiet zone (clear area) of the bar code. If the unit does not respond, press **POWER**.
4. At about the same speed with which you would quickly underline a sentence in this manual, and without interruption, gently pass the mouse wand across the center of the bar code. You do not need to press the mouse on the bar code.
5. Listen for audible tones.
  - If you hear a long beep tone followed by a short tone, it signifies a good read.
  - If you hear a long beep and then three short beeps, the unit detects an error in the scanned symbol.
  - If one of these messages appears, *slowly, please!*; *faster, please!*; or *more evenly, please!*; adjust your scan technique accordingly. If a symbol consistently produces no beeping, it is either fatally out of spec or it is not one of the symbologies programmed on the unit.
  - If you receive a message about a bad quiet zone, you may have started scanning too close to the first bar. Rescan the symbol, starting a little farther away from the first bar.
6. Practice your scanning technique until you can successfully scan, on the first attempt, each of the test symbols supplied with the verifier.

### ***Cleaning the Wand***

Occasionally the scanner tip or window may become partially obstructed by ink, paper fibers, or other particulate deposits (such as wax or varnish). To ensure reliable scanning, you should periodically check and, if necessary, clean the tip with a soft cloth.

*Note: Damaged tips for the pen wand should be replaced. Consult your dealer or Hand Held Products' Customer Service Department for details.*

### ***Accessories and Options***

Hand Held Products supplies a variety of accessories and options for the Quick Check 600/800 Verifier. The items indicated by an asterisk are supplied with the verifier.

#### **Item/Description Order code**

##### **Charger & Batteries**

\*Quick Check 600/800 Verifier AC Charger . . . . . QCAC = 110 VAC  
    QCAC 220B = 220 VAC UK  
    QCAC 220A = 220 VAC Europe

\*NiCad Rechargeable batteries (set of four "AA" size) . . . . . QCB

---

Documentation

\*QC600/800 User's Guide & Programming Manual . . . . QC600-800-UG

\*QC600/800 Reflectance Page . . . . . QCRFPG

Printers

QC Standard Speed Dot Matrix Printer . . . . QCP68-USA/QCP68-EURO

QC High Speed Dot Matrix Printer . . . QCHSP68-USA/QCHSP68-EURO

Printer supplies

Power supply for QCP & QCHSP Printers. . . . . QCPAC

Printer ribbon for QCP & QCHSP . . . . . QCPR

Printer paper for QCP & QCHSP (4 roll/pack). . . . . QCPP

Interface cable for QC600/800 to QCP or QCHSP . . . . . QCPC

Wand Scanner

QCIW05V Pen Wand 5 mil visible red . . . . . 622301

QCIW06V Pen Wand 6 mil visible red . . . . . 622302

QCIW10V Pen Wand 10 mil visible red . . . . . 622299

QCMWI03 Mouse Wand 3 mil infrared . . . . . MOUSE3MIR

QCMWV03 Mouse Wand 3 mil visible red . . . . . MOUSE3MVR

QCMWI05 Mouse Wand 5 mil infrared . . . . . MOUSE5MIR

QCMWV05 Mouse Wand 5 mil visible red . . . . . MOUSE5MVR

QCMWI06 Mouse Wand 6 mil infrared . . . . . MOUSE6MIR

QCMWV06 Mouse Wand 6 mil visible red . . . . . MOUSE6MVR

QCMWI10 Mouse Wand 10 mil infrared . . . . . MOUSE10MIR

QCMWV10 Mouse Wand 10 mil visible red . . . . . MOUSE10MVR

QCMWI20 Mouse Wand 20 mil infrared . . . . . MOUSE20MIR

QCMWV20 Mouse Wand 20 mil visible red . . . . . MOUSE20MVR



If you are familiar with bar code verifiers, this section will get you up and running in a few minutes. We assume the factory defaults are in effect.

### 1. Install the batteries

Chapter 1

- Slide off battery cover on the bottom of unit.
- Insert four batteries into compartment, matching “+” on battery ends with “+” in case.
- Slide battery cover back in place.

### 2. Charge the batteries

Chapter 1

- Plug AC charger into port on back of unit.
- Plug charger into a VAC wall outlet.
- Charge completely discharged batteries at least 12 hours; charge low charge batteries less time.
- After charging, remove AC charger from unit.

### 3. Turn on the verifier

Chapter 1

- Press **POWER**. Unit emits four quick beeps. If unit displays:
- **RECALIBRATE**, calibrate unit. Go to [step 4](#).
- **LOW BATTERY!**, charge batteries. Go to [step 2](#).
- **NO PRINTER ATTACHED...** records may be stored in buffer. Use arrow keys to select an option. Either continue to scan using current AutoPrint/Store setting, clear (delete) records, or change AutoPrint/Store setting to **Off** (not store data). Go to [step 5](#). **Chapter 5**
- **PRINT BUFFER...** records are stored in buffer. Use arrow keys to select an option. Either continue to scan and leave records in buffer, print records, or clear (delete) records. Go to [step 5](#).
- **SCAN**, go to [step 5](#).
- **QUICK-CHECK** Opening Menu, go to [step 5](#).

### 4. Calibrate the unit

Chapter 1

- Scan reflectance page if you're using either a pen or mouse wand. Three beeps (one long, two short) sound after a good scan.
- Continue to scan page for ten good scans.

### 5. Scan the bar code symbol

Chapter 3

- The scan grade display appears. (Extended Accuracy setting default is off).
- To obtain final symbol grade, scan symbol nine more times (# Scan/Symbol setting default is 10).

### 6. Review the scan results

Chapter 4

- 
- The standard decode display appears.
  - Use arrow keys to view data  
OR  
Scan SSTR Codes to view data.

## **7. Print your scan results**

**Chapter 3**

- If the Quick Check 600/800 Verifier is connected to a printer and it is turned on, results print automatically (AutoPrint/Store setting default is On).
- If a printer is not connected or is turned off, results are stored in buffer.

## **8. Review the option settings:**

**Chapter 3**

- If data parameters are not customized the way you want, press SELECT to display Print Results menu and then press Ø three times to change the settings.



## Changing the Settings

There are four types of options on the Quick Check 600/800 Verifier you can customize: specifications (applications and symbologies), test criteria, scanning options, and output options. Each option has several items that you can turn on, turn off, or change a value. This section describes all the selectable option settings.

You can easily review and change the settings using **SELECT** and the ↑, ↓, ← and → buttons. You save settings by displaying their name and then making the changes you want. A separate save command is not necessary. You can exit the settings menu at any point and scan a bar code symbol by placing the wand tip or the mouse wand on a quiet zone and scanning or by pressing **POWER**.

It may be useful to create a customized Command Code for each type or set type of operations you perform. When you need to perform another procedure, just scan the Command Code that contains those settings. Refer to instructions for making and using a Command Code starting on "[Using a Command Code](#)" on [page 3-16](#). Sometimes you may want to change just one or two of the settings, but not create a new Command Code that differs only slightly from the one you frequently use. You can easily change settings after you use a Command Code.

*Chapter 10, Flow Charts* contains a flow chart that displays all the settings changes you can make and how to access each of them using the menus.

### Changing the Specifications

The Quick Check 600/800 Verifier specification section consists of the industry application standards and symbologies. The Quick Check 600/800 Verifier can verify the quality of the following symbologies and industry application standards:

#### *Symbologies*

- EAN/UPC
- Code 39
- Interleaved 2 of 5
- Code 128
- Code 93
- Codabar
- Code 11
- Code 16K
- Code 49
- MSI Code
- IATA 2 of 5
- Regular 2 of 5

#### *Industry Applications*

- AAIG
- Comp Tia
- LOGMARS
- SCC
- HIBCC
- CCBBA
- SISAC
- BOOKLAND
- Coupon Code

---

## *Symbologies*

You can enable (turn on) the symbologies available on your Quick Check 600/800 Verifier so they are recognized. When a symbology is enabled, you can modify some of its test parameters. "[Symbology Specifications](#)" on page 3-3 lists the parameters you can modify and their factory installed defaults. The parameters are described after the table.

## Symbology Specifications

Symbology	Parameters (defaults are in bold)
EAN/UPC	Enable: <b>On</b> or off Magnification factor: (080/085/090/ <b>100</b> /105/110/115/120/130/140/150/160/180/200) Expand U.P.C.-EO: <b>Yes</b> or No
Code 39	Enable: <b>On</b> or off Check Character: <b>None</b> or Checked Fixed W/N: <b>None</b> or a value between 1.4 and $3.9 \pm 0.2$
Interleaved 2 of 5	Fixed Msg Len*: <b>None</b> or a value between 1 and 49 characters Enable: <b>On</b> or off Check Digit: <b>None</b> or Checked Fixed W/N: <b>None</b> or a value between 1.4 and $3.9 \pm 0.2$
Code 128	Fixed Msg Len*: <b>None</b> or a value between 1 and 78 digits Enable: <b>On</b> or off
Code 93	Modes Shown? <b>Yes</b> or No Fixed Msg Len*: <b>None</b> or a value between 1 and 70 characters Enable: <b>On</b> or off
Codabar	Fixed Msg Len*: <b>None</b> or a value between 1 and 80 characters (from Code 39 set) Enable: <b>On</b> or off
Code 11	Character Font & Tolerances: <b>Trad'I</b> ,"USS" or ISO/IEC'83 Fixed W/N: <b>None</b> or a value between 1.4 and $3.9 \pm 0.2$ Fixed Msg Len*: <b>None</b> or a value between 1 and 61 digits Enable: <b>On</b> or off 1 or <b>2</b> check digits Fixed Msg Len*: <b>None</b> or a value between 1 and 80 digits
Code 16K	Enable: On or <b>Off</b> Modes Shown? <b>Yes</b> or No Fixed Msg Len*: <b>None</b> or up to 154 characters, full symbol
Code 49	Enable: On or <b>Off</b> Fixed Msg Len*: <b>None</b> or up to 49 alpha (81 numeric characters, full symbol)
MSI Code	Enable: On or <b>Off</b> User Check: <b>None</b> , Mod 10 or Mod 11 Fixed Msg Len*: <b>None</b> or a value between 1 and 50 digits
IATA 2 of 5	Enable: Yes or <b>No</b>
Regular 2 of 5	Enable: Yes or <b>No</b> Enable: Checked or <b>None</b>

\* The message length specification for each symbology is listed. Although you can enter any value between 0 and 255, the unit does not decode more than the values indicated by the specification.

---

## *Magnification Factor*

The Magnification (Mag) Factor applies to the EAN/UPC symbologies. By setting the size of the bar code symbols that you test, you define appropriate tolerances.

You can select a mag factor from the following values: 80%, 90%, 95%, 100%, 105%, 110%, 115%, 120%, 125%, 130%, 140%, 150%, 160%, 180% or 200%. The default is 100%.

## *Expand U.P.C./EO*

The **Yes** setting for this parameter allows you to expand the compressed U.P.C. code. When you expand the scan data, the digits are shifted to the left and + appears on the display to indicate that additional data is available for your review.

The **No** setting for this parameter presents the data in zero suppression format.

## *Check Options*

The check character, check digit and UserCheck are optional characters or digits in some symbologies that are placed in a predetermined position in a symbol. You can use them to validate that the correct data has been decoded.

Check characters in a symbol may be mandated by a bar code symbology industry specification, by you, by both, or not at all. Refer to the relevant industry's publication for specific information on check characters.

- When you select **Checked**, the verifier looks for and checks the check character or digit.
- When you select **None**, the verifier does not look for the check character or digit. None is the default setting.

Selected symbologies offer additional options:

- Code 39 contains an optional Mod 43 check character.
- Interleaved 2 of 5 contains an optional 3-1-3-1 weighted check digit.
- MSI Code can contain a second check digit (UserCheck), either the Modulo (Mod) 10 or Modulo (Mod) 11.

## *Modes Shown*

This parameter allows you to have additional information appear on the display and on the printout. This information includes special extra characters and control characters within the encoded message. Having this extra information displayed may help you analyze reading or printing problems. In Code 128, for example, you can display starting mode, mode changes and shifts. Code 16K allows you to display similar additional characters.

The **Yes** setting for this parameter is the default. Some of the extra characters are represented by special character “strings” as shown in the following [Character Translation Table](#). When you select the **No** setting, this information does not appear on the display or the printout.

***Character Translation Table***  
***(Code 128, Code 16K, and Code 49)***

Character	On LCD	On Printout	Character	On LCD	On Printout
00(NUL)	0	<NL>	15(NAK)	15	<NK>
01(SOH)	1	<SH>	16(SYN)	16	<SY>
02(STX)	2	<SX>	17(ETB)	17	<EB>
03(ETX)	3	<EX>	18(CAN)	18	<CN>
04(EOT)	4	<ET>	19(EM)	19	<EM>
05(ENQ)	5	<EQ>	1A(SUB)	1A	<SB>
06(ACK)	6	<AK>	1B(ESC)	1B	<ES>
07(BEL)	7	<8L>	1C(FS)	1C	<FS>
08(BS)	8	<BS>	1D(GS)	1D	<GS>
09(HT)	9	<HT>	1E(RS)	1E	<RS>
0A(LF)	A	<LF>	1F(US)	1F	<US>
0B(VT)	B	<VT>	7F(DEL)	*	<DL>
0C(FF)	C	<FF>	FCN1	F1	<F1>
0D(CR)	D	<CR>	FCN2	F2	<F2>
0E(SO)	E	<SO>	FCN3	F3	<F3>
0F(SI)	F	<SI>	FCN4	F4	<F4>
10(DLE)	10	<DE>	Mode A	A	<A:>
11(DCI)	11	<D1>	Mode B	B	<B:>
12(DC2)	12	<D2>	Mode C	C	<C:>
13(DC3)	13	<D3>	Shift	Sh	<Sh>
14(DC4)	14	<D4>	Pad**	Pd	Pd

\* No “special” character is displayed for <DEL>.

\*\* For Code 16K only.

## ***Character Font & Tolerances***

Codabar supports two options for Character font and tolerances.

- **Trad’I** (Traditional Codabar) uses traditional print tolerances based on Monarch’s original print tolerances. This is the default setting.
- **USS Codabar** uses the ISO/IEC 1983 MH10.8M standards.

Refer to Codabar and ISO/IEC publications for specific information on print tolerances.

---

## Wide-to-Narrow Ratio

The wide-to-narrow ratio (W/N) applies to symbologies with two element widths, including Codabar, Interleaved 2 of 5, and Code 39. "W/N" is the ratio of wide to narrow elements. Only one symbology can have a W/N ratio at a time. The range of values is  $1.4$  to  $3.9 \pm 0.2$ .

## Fixed Message Length

You can set a Fixed Message Length for any symbology except EAN/UPC, but only one symbology can have a fixed message length at a time. You can enter the message length for any value between 0 and 255. "[Symbology Specifications](#)" on [page 3-3](#) lists the message length specification for each symbology.

### ◆ To modify the symbology options:

1. Display the menu that begins with `Print Results` (press **POWER** and then **SELECT**).
2. Set the cursor on the asterisk next to `Change Settings` and then press **SELECT**.  
A menu that begins with `Specifications` appears.
3. With the cursor on the asterisk next to `Specifications`, press **SELECT**.  
A menu that begins with `Symbologies` appears.
4. With the asterisk next to `Symbologies`, press **SELECT**.  
A list containing the names of the first four available symbologies appears. Next to each symbology name is either the term **ON** or **OFF** indicating its enable status. To review the entire list, press  $\uparrow$  or  $\downarrow$  and hold it down, or press  $\uparrow$  or  $\downarrow$  and let up each time. The names of the additional available symbologies appear.
5. To change the enable status of a symbology, position the cursor next to the symbology name and press **SELECT**. For all the symbologies except Code 93 and Code 49, a new menu appears with the name of the symbology on top and a list of parameters that you can change.  
With the cursor on the asterisk next to **ENABLE**, press  $\rightarrow$  or **SELECT**. The symbology enable status changes between **Yes** and **No**.
  - To change a parameter, use  $\downarrow$  to move the cursor to the asterisk next to the name of the first parameter.
  - To change a numeric value such as the magnification factor, press  $\rightarrow$  to move the cursor from the asterisk to the parameter value, then press  $\uparrow$  or  $\downarrow$  until the value you want appears.
  - To change a selection such as **Yes/No** or **Checked!/None**, press  $\rightarrow$  or **SELECT**.
  - To return to the previous menu, press **POWER**.

When you exit any menu, all the displayed parameter choices are saved.

---

6. To change which symbology has a W/N Ratio:

- Press  $\uparrow$  or  $\downarrow$  to set the cursor on the asterisk next to Fixed W/N Ratio and then press **SELECT**. A menu appears with Fixed W/N Ratio on top and asks you to choose the symbology name and the ratio amount.
- To choose the symbology, press **SELECT** or  $\rightarrow$  to move the cursor from the asterisk next to Symbgy to the name of the specific symbology. You can set the W/N ratio for only one symbology at a time. Now press  $\uparrow$  or  $\downarrow$  to display the symbology that you want to have a fixed W/N ratio.
- To save the selection, press **SELECT** or  $\leftarrow$  to move the cursor back to the asterisk next to Symbgy.
- To set the fixed W/N ratio amount, press  $\downarrow$  to move the cursor to the asterisk next to Ratio. Then press **SELECT** or  $\rightarrow$  to move the cursor to the numeric value. Use  $\uparrow$  or  $\downarrow$  to display the value you want. The value can range from 1.4 to  $3.9 \pm 0.2$ .
- To save the selection, press **SELECT** or  $\leftarrow$  to move the cursor back to the asterisk next to Ratio.
- To return to the previous menu, press **POWER**.

7. To change which symbology has a fixed message length:

- Press  $\uparrow$  or  $\downarrow$  to set the cursor on the asterisk next to Fixed Len and then press **SELECT**. A menu appears with Fixed Message Length on the top and asks you to choose the symbology name and the specific length.
- To choose the symbology, press **SELECT** or  $\rightarrow$  to move the cursor from the asterisk next to Symbgy to the name of the specific symbology. Now press  $\uparrow$  or  $\downarrow$  to display the symbology that you want to have a fixed message length.
- To save the selection, press **SELECT** or  $\leftarrow$  to move the cursor back to the asterisk next to Symbgy.
- To set the specific length, press  $\downarrow$  to move the cursor to the asterisk next to Length. Then press **SELECT** or  $\rightarrow$  to move the cursor to the numeric value. Now press  $\uparrow$  and  $\downarrow$  to display the value you want. The length can range from 0 to 255 characters. (See "[Symbology Specifications](#)" on page 3-3.)
- To save the selection, press **SELECT** or  $\leftarrow$  to move the cursor back to the asterisk next to Length.
- To return to the previous menu, press **POWER**.

8. To change other symbologies and their parameters, repeat [step 5](#). on [page 3-6](#).

- To return to the previous menu, press **POWER**.
- To scan a symbol, set the wand on the symbol's quiet zone.

## *Industry Applications*

You can enable only one application at a time. Your verifier may not have all the applications installed in it.

---

◆ **To select an application:**

1. Display the menu that begins with Print Results (press **POWER** and **SELECT**).
2. Set the cursor on the asterisk next to Change Settings and then press **SELECT**.  
A menu that begins with Specifications appears.
3. With the asterisk next to Specifications, press **SELECT**.  
A menu that begins with Symbologies appears.

A list containing the term Symbologies and the names of the applications appears. The application that is currently enabled has a ← to the right of the name. If a → is to the right of the term Symbologies, no application is enabled.

4. To enable another application, set the cursor next to the application name and then press **SELECT**.
  - When you select AIAG, SCC, Coupon Code or BOOKLAND, you are prompted to provide additional information. AIAG asks if you want Supplier or Customer. Use ↑ and ↓ to set the cursor on the asterisk next to the term you want and then press **SELECT**.
  - When you select SCC for the SCS/ITF, Coupon Code and BOOKLAND, you are prompted to provide a magnification factor. Use ↑ and ↓ to display the magnification factor you want to use and then press **SELECT**.
5. To return to the previous menu, press **POWER**.  
To scan a symbol, set the wand on the symbol's quiet zone.

## *Changing the Test Criteria*

The test criteria apply to the standards used to evaluate the scanned symbols. You can select the following items:

- ISO/IEC scan grade or pass/fail criteria for traditional parameters
- Character averaged decodability or ISO/IEC Decodability
- ISO/IEC grades in letters or numbers
- Number of scans used to determine the final ISO/IEC Symbol Grade

## *Scan Grade*

The Quick Check 600/800 Verifier acquires data using the ScanProfile Methodology specified in the ISO/IEC's "Bar Code Print Quality Guideline." The verifier then evaluates the acquired data and provides a scan grade (also called a scan profile grade).

The default number of scans used to obtain the scan grade is one (with Extended Accuracy set to **Off**). You can obtain an averaged scan grade when the Extended Accuracy scanning option is On (set to a value >1).



---

You can obtain the scan grade result in two ways:

- Set the verifier to use traditional print quality parameters to make a pass/fail judgment about the symbol and provide detailed measurements.
- Set the verifier to use ISO/IEC methods to judge the symbol and report an ISO/IEC scan grade of A, B, C, D or F. The default setting is ISO/IEC scan grade C.

All the test criteria options are available for you to select regardless of which scan grade method (ISO/IEC or traditional) you selected. For example, if you select the traditional pass/fail criteria, you can view and change the ISO/IEC grade letter or number option, even though it has no affect on the traditional criteria you selected.

## *Decodability*

Decodability is the percentage of the symbology's safe decoding margin available for the scanner after printing errors. Lower margin values and corresponding lower grades indicate an increased susceptibility to decoding failure due to scanning errors. Scanning variations, such as acceleration, cause bar or space deviations due to uneven, too fast or too slow scanning and could yield lower margin values.

You can choose the decodability method you want to use — ISO/IEC Decodability or character averaged decodability (Avg):

- **ISO/IEC Decodability** is a graded measure of how close a given scan comes to a reference decode failure due to variations in bar and/or space widths. The default setting is ISO/IEC decodability.
- **Avg** is the character-averaged value of decodability and is referred to as "D Margin" on a Quick Check 600/800 Verifier printout.

## *ISO/IEC grades*

For all symbologies, and most of the applications, you can view the test results, ISO/IEC scan grade and ISO/IEC symbol grades reported as letters (A, B, C, D, or F) or as numbers (4, 3, 2, 1, or 0). The default setting is letters, with A=4, B=3, C=2, D=1, and F=0. For some applications, such as AIAG, the grade level is specified by the application and you cannot change it. If you set an incorrect grade level, the application resets the correct one.

## *Number of Scans*

You use the **#Scans/Symbol** setting to specify the number of individual scan grades that you want used to calculate the final symbol grade. The term "**#Scans/Symbol**" is shorthand for the number of scan grades used to determine the final symbol grade. For further discussion and comparison to scan grades, refer to "[Reviewing Scan Results](#)" on page 4-1.

You can select from the following settings: 1 through 10, 12, 15, 20, 30, 50, 100 and Var. The default #Scans/Symbol setting is 10.

---

Consider the symbol grade as the average resulting from scans you take from all over the symbol. The ISO/IEC standard requires you to obtain ten scans of each symbol.

For example, you might sample the symbol at ten different paths in the symbol — four in the upper portion, two in the middle and four in the lower portion. Multiple scans of the same symbol across different scan paths take advantage of the vertical redundancy of bar codes and give you a more accurate value of the symbol's overall print quality.

◆ **To change the test criteria:**

1. Display the menu that begins with Print Results (press **POWER** and then **SELECT**).
2. Set the cursor on the asterisk next to Change Settings and then press **SELECT**. A menu that begins with Specifications appears.
3. Set the cursor on the asterisk next to Test Criteria and then press **SELECT**. A menu that begins with Passing appears.
  - **To change the pass/fail criteria**, set the cursor on the asterisk next to the term Passing and then press **SELECT** or →. The cursor moves to the right of Passing. Press ↑ and ↓ until the grade (Trad'l, ISO/IEC "A," ISO/IEC "B," ISO/IEC "C," ISO/IEC "D,") you want appears. To save the selection, press **SELECT**, **POWER** or ←. The cursor moves back to the asterisk next to Passing.
  - **To change the Decodability**, set the cursor on the asterisk next to Decodability and then press **SELECT** or →. The setting changes between ISO/IEC and Avg.
  - **To change the Grades**, set the cursor on the asterisk next to Grades and then press **SELECT** or →. The setting changes between Letters and Numbers.
  - **To change the number of scans used to determine the final ISO/IEC Symbol Grade**, set the cursor on the asterisk next to #Scans/Symbol and then press **SELECT** or →. The cursor moves to the right of the terms #Scans/Symbol. Press ↑ and ↓ until the numeric value you want (1 through 10, 12, 15, 20, 30, 50, 100 or Var) appears. To save the selection, press **SELECT** or ←. The cursor moves back to the asterisk next to #Scans/Symbol.

When you exit any menu (press **POWER**), all the displayed parameter choices are saved.

4. **To return to the previous menu**, press **POWER**.  
**To scan a symbol**, set the wand on the symbol's quiet zone.

## *Changing the Scanning Options*

The scanning options apply to the general operation of the Quick Check 600/800 Verifier. You can change the following options:

- 
- Beeper Pitch (raise or lower)
  - Extended Accuracy
  - Decoding direction (both ways or forward only)

## ***Beeper Pitch***

You can change the pitch of the verifier's beeper. Higher pitches seem to sound louder. You can also turn off the tone. The default is 16. The range includes **Off** and 1 through 31.

## ***Extended Accuracy***

The Extended Accuracy setting is the number of scans of the same symbol, taken at the same path in the symbol, that yields the scan grade.

- With Extended Accuracy on, individual parameter measurements and results are averaged over successive scans of the symbol. Using the extended accuracy mode greatly reduces reading variability due to variations in scanning motion and minor scan path variations. When Extended Accuracy is on, you select the number of scans for the averaged result from 2 through 10, 12, 15, 20, 30, 50 and 100.
- When Extended Accuracy is off (set to one), each scan of the symbol gives the measured results. The default is Extended Accuracy turned off.

When you scan a symbol with Extended Accuracy on, a numeric counter appears on the display telling you how many additional scans of the same path you must obtain. After you satisfy the setting, the scan grade appears. If you do not scan the same symbol within five seconds, the unit assumes you do not want to satisfy the Extended Accuracy setting you chose and displays the scan results from that individual scan. If you scan a different symbol after your first scan, the Extended Accuracy counter resets.

For further discussion and comparison of scan grade to symbol grade, refer to *Chapter 4, Reviewing Scan Data*.

## ***Decode Direction***

You can set the Quick Check 600/800 Verifier to read bar code symbols from left-to-right, called "forward only," or from either direction, called "Both Ways." The BothWays setting (default) makes scanning easier and more flexible than forward-only scanning.

### **◆ To change the scanning options:**

1. Display the menu that begins with Print Results (press **POWER** and **SELECT**).
2. Set the cursor on the asterisk next to Change Settings and then press **SELECT**.  
A menu that begins with Specifications appears.

- 
3. Set the cursor on the asterisk next to Scanning Options and then press **SELECT**.  
A menu that begins with Beeper Pitch appears.
  4. To make any necessary changes:
    - **To change the beeper pitch**, set the cursor on the asterisk next to Beeper and then press **SELECT** or →. The cursor moves to the right of the term Pitch. Press ↑ and ↓ until you hear the beeper pitch you want. To save the selection, press **SELECT** or ←. The cursor moves back to the asterisk next to Beeper.
    - **To change the Extended Accuracy setting**, set the cursor on the asterisk next to Extended Accur and press **SELECT** or →. The cursor moves to the right of Accur. Press ↑ and ↓ until the number of scans you want for the average appears. To save the selection, press **SELECT** or ←. The cursor moves to the asterisk next to Extended.
    - **To change the decoding direction setting**, set the cursor on the asterisk next to Decoding and then press **SELECT** or →. The setting changes between BothWays and FwdOnly!.
    - When you exit any menu, all the displayed parameter choices are saved.
  5. **To return to the previous menu**, press **POWER**.  
**To scan a symbol**, set the wand on the symbol's quiet zone.

## *Changing the Output Options*

The output options include the display options and the print options.

### *Display Options*

The display options include:

- Upper Parameter Result Line display
- Lower Parameter Result Line display
- Error Override display
- LEDs either display ISO/IEC Grade or indicate bar growth or loss

The display options allow you to set the two types of results that are most important to you in the upper and lower parameter result lines so they appear immediately after a scan. (The upper parameter result line is the third line of the display and the lower line is the fourth or bottom line of the display.) Then, by pressing a few buttons, you can review all the other results.

### *Parameter Result Lines*

On the parameter lines, you can display either the result defaults set at the factory, or results you select.

- For traditional pass/fail criteria, the factory-set defaults are PCS and AvgBar.
- For ISO/IEC criteria, the factory-set defaults are Decodability and Modulation.

---

Additional results you can display and the criteria used include:

- Symbol type
- Wide-to-narrow ratio (traditional)
- Light reflectance (traditional and ISO/IEC)
- Dark reflectance (traditional and ISO/IEC)
- Symbol contrast (ISO/IEC)
- Reflectance minimum/maximum (ISO/IEC)
- Edge contrast minimum (ISO/IEC)
- Defects (ISO/IEC)
- Message length
- Bar growth (traditional)

Error override allows you to set the verifier to replace the default or user-selected Upper and Lower Parameter Result lines with any error information or messages that might result from the bar code scan analysis. If more than two errors result from a scan, the first two appear on the display and you can scroll the display to view the other errors. The default for Error Override is **NO**.

When you select ISO/IEC criteria, you can use the LED's display feature to set the LEDs to indicate bar growth/loss or pass/fail grade and result grade. In addition, when you select ISO/IEC criteria, the five multi-colored LEDs normally indicate symbol pass or fail based on the ISO/IEC criteria. With the LED feature set to Bar Growth, the LEDs provide information on bar growth or loss, just as they would if you selected traditional pass/fail test criteria.

## *Print Options*

The print options allow you to select:

- Printer type (QCP or QCHSP)
- Printout form (long or short)
- Automatic options — automatically print data when the unit is connected to a printer and turned on, automatically store data when the unit is not connected to a printer
- Auto Print/Store with or without Profile

You can use any one of the three optional accessory hardcopy printers, but you need to select the printer before you try to print. Supported printers include:

- QCP (standard printer)
- QCHSP (High-Speed Printer)

Refer to *Chapter 5, Saving and Printing* for more information about these printers.

## *AutoPrint/Store*

The AutoPrint/Store option automatically prints or stores your data:

- When you have the AutoPrint/Store feature turned on and a printer connected to your verifier and turned on, your scan results print automatically. You cannot store results when a printer is connected and turned on.

- 
- When you have the AutoPrint/Store feature turned on, but no printer is connected to your verifier, or your printer is connected, but is turned off, your scan results are automatically stored in the verifier's memory.
  - When you have the AutoPrint/Store feature turned off, after each scan you need to instruct the verifier to print your data (if a printer is connected and turned on) or to store your data (if a printer is not connected or is turned off).

The default is setting for AutoPrint/Store is **ON**.

## *Scan Profile*

The Quick Check 600/800 Verifier allows you to print the scan profile which is a record of the reflectance values seen by a scanner as it moves across a symbol. The scan profile is the basis of ISO/IEC evaluation and is usually presented in a graphic form.

- When you use the AutoPrint/Store feature with Profile, you can choose to have the scan results stored so you can later print a graphic scan profile on a printout.
- When you use AutoPrint/Store without Profile, the raw data is not stored.

### ◆ **To change the output options:**

1. Display the menu that begins with Print Results (press **POWER** and then **SELECT**).
2. Set the cursor on the asterisk next to Change Settings and then press **SELECT**. A menu that begins with Specifications appears.
3. Set the cursor on the asterisk next to Output Options and then press **SELECT**. A menu that contains Display Options and Printout Options appears.

### 4. **To change the display options:**

- To change the display options, set the cursor on the asterisk next to Display Options and then press **SELECT**. A menu with four display options selections appears.
- To change the data displayed in the upper (3rd line) or the lower (4th line) parameter result line, set the cursor on the asterisk next to UpperLine and then press **SELECT** or **→**. The cursor moves to the right of the term. Press **↑** and **↓** until the name of the data that you want to show up on the parameter result line appears. To save the selection, press **SELECT** or **←**. The cursor moves back to the asterisk next to the term.
- To change the error override feature, set the cursor on the asterisk next to Error Override and then press **SELECT** or **→** until the setting you want, YES (Y) or NO (N), appears.
- To change what the LEDs indicate, set the cursor on the asterisk next to LEDs and then press **SELECT** or **→** until the setting you want, P/F Criteria or Bar Growth!, appears.
- Press **POWER** to return to the menu that contains Display Options and Printout Options.

---

## 5. To change the printout options:

- To change the printout options, set the cursor on the asterisk next to Printout Options and then press **SELECT**. A menu with the printout options selections appears.
- To change the printer type, set the cursor on the asterisk next to Printer Type and then press **SELECT** or → until the setting you want, QCP or QCHSP, appears.
- To change the printout form, set the cursor on the asterisk next to Printout and then press **SELECT** or → until the setting you want, Long or Short, appears.
- To change the AutoPrint and Store setting, set the cursor on the asterisk next to AutoPrint/Store and then press **SELECT** or → until the setting you want, On or Off appears. If you set the AutoPrint and Store setting On, you may want to use it with or without Profile. To change the Profile settings, set the cursor on the asterisk next to w/Profile?. Press **SELECT** or → until the setting you want, Yes or No, appears.

## 6. To return to the previous menu, press **POWER**.

To scan a symbol, set the wand on the symbol's quiet zone.

## *Resetting the Default Settings*

If you make changes to your Quick Check 600/800 Verifier's settings, you can easily reset them to the factory installed defaults.

### ◆ To reset a unit:

1. Scan the special "Reset All Options" code located in *Chapter 12, Special Codes*. The unit reinstalls the factory default settings.
2. Recalibrate the unit.  
Refer to *Chapter 2, Quick Start Guide* for instructions.

## *Locking the Settings*

After you set all the options (specifications, test criteria, scanning options and output options) on the Quick Check 600/800 Verifier, you can "lock" the unit so that you or others cannot accidentally change the settings during routine use. If you lock the unit, you must unlock it to change any settings. Use the Special Codes provided in the back of this manual to lock and unlock the unit. The verifier is shipped in the unlocked mode.

### ◆ To lock the unit:

1. Customize your verifier by setting all the options the way you want them.
2. Scan the "Lock Specs and Tests" Special Code.  
The unit is now locked. You cannot change any option settings unless you unlock the unit or scan "Reset All Options" which sets the unit to its factory defaults.

---

◆ **To unlock the unit:**

1. Scan the “Unlock Specs and Tests” Special Code.  
The unit is now unlocked. You can now change any option setting.

## *Using a Command Code*

A Command Code is a bar code symbol that allows you to customize the Quick Check 600/800 Verifier for your use. It is especially useful when you have one or two setups and you frequently switch between them. After you turn on the unit or when you want to change setups, just scan your customized Command Code for that type of operation and then begin your work.

## *About Command Codes*

There are two different types of Command Codes — Command- (Minus) Codes and Command+ (Plus) Codes. These codes differ in the type of information they store.

- Command+ Codes let you store all the settings on the “Command Code Selections Lists” below.
- Command- Codes allows you to store all the settings listed on the Command Code selection list except the beeper pitch, the decode direction and the output option settings (printer type, printout form and the AutoPrint/Store setting).

### **Command Code Selections List**

#### **Test Criteria**

Passing grade: (Choose One)

Traditional or ISO/IEC “A,” ISO/IEC “B,” ISO/IEC “C,” ISO/IEC “D”

Decodability: Avg or ISO/IEC

Grades: Letters or Numbers

Number or scans/symbol: (Choose one)

2, 3, 4, 5, 6, 7, 8, 9, 10, 12, 15, 20, 30, 50, 100, Var

#### **Scanning Options**

Beeper Pitch: (Choose One)

Off or value between 1 and 31

Extended Accuracy: (Choose One)

Off, 2, 3, 4, 5, 6, 7, 8, 9, 10, 12, 15, 20, 30, 50, 100, Var

Decoding Direction: BothWays or Forward Only

#### **Output Options**

Display Options

UpperLine: (Choose One)

Default or Average Bar Error, W/N Ratio, Decodability,

RI & RD, P.C.S., Symbol Contrast, Rmin/Rmax, Modulation,

EC(min), Defects, Message Type, Message Length or Check Character

LowerLine: (Choose One)

Default or Average Bar Error, W/N Ratio, Decodability,



---

RI & RD, P.C.S., Symbol Contrast, Rmin/Rmax, Modulation, EC(min),  
Defects, Message Type, Message Length or Check Character

Error Override: Yes or No

LEDs: P/F Criteria or Bar Growth

Output Options

Printer Type: (Choose One)

QCP, HSP, SSP

Printout: Long form or short form

AutoPrint/Store: On or Off

With profile: Yes or No

### **Generic Code Selections**

U.P.C./EAN/JAN

Enable: On or Off

Magnification Factor? (Choose One)

080/085/095/100/105/110/115/120/125/130/140/150/160/180/200

Expand UPC-EO: Yes or No

Code 39

Enable: On or Off

Character Check: None or Checked

Fixed W/N: None or select value between 1.4 and  $3.9 \pm 0.2$

Fixed message length: None or select value between 1 and 49  
characters

Interleaved 2 of 5

Enable: On or Off

Character Digit: None or Checked

Fixed W/N: None or select value between 1.4 and  $3.9 \pm 0.2$

Fixed message length: None or select value between 2 and 78 digits

Code 128

Enable: On or Off

Modes Shown: Yes or No

Fixed message length: None or select value between 1 and 70  
characters

Code 93

Enable: On or Off

Fixed message length: None or select value between 1 and 80  
characters (from Code 39 set)

Codabar

Enable: On or Off

Character Font and Tolerances: (Choose one)

Trad'l, "USS" or ISO/IEC '83

Fixed W/N: None or select value between 1.4 and  $3.9 \pm 0.2$

Fixed message length: None or select value between 1 and 61 digits

Code 11

Enable: On or Off

---

Check digits: 1 or 2  
Fixed message length: None or select value between 1 and 80 digits  
Code 16K  
Enable: On or Off  
Modes Shown: Yes or No  
Fixed message length: None or up to 154 characters, full symbol  
Code 49  
Enable: On or Off  
Fixed message length: None or up to 49 alpha (81 numeric)  
characters, full symbol  
MSI code  
Enable: On or Off  
Character Digit: None or Mod10 or Mod 11  
Fixed message length: None or select value between 1 and 50 digits  
IATA 2 of 5  
Enable: Yes or No  
Regular 2 of 5  
Enable: Yes or No  
Check Digit: Yes or None

## ***Choosing a Command Code***

You may want to use a Command- Code rather than a Command+ Code if you often use the same setup on two units with different printers. With the Command- Code, you can easily change the setups for the units without changing the printer types, which may be more confusing because all the other settings on these two Command Codes would be identical.

## ***Customized Command Codes***

Creating your own Command Code requires a Quick Check 600/800 Verifier printer. If you do not have a printer, you can request a Command Code from Hand Held Products.

You can use your Quick Check 600/800 Verifier printer to produce your own Command Code using the Special Codes in [Chapter 11](#). These four Special Codes are labeled “Command- Code (Locked),” “Command Code- (Unlocked),” “Command+ Code (Locked)” and Command+ Code (Unlocked)”.

The locked codes have an additional setting which locks the changes into the unit after the Command Code is scanned. The lock prevents accidental reprogramming during routine use. The lock can only be removed by scanning another, previously prepared, Command Code that does not include the lock, such as an unlocked code. When shipped to you, the Quick Check 600/800 Verifier settings are unlocked.

If you do not have a Quick Check 600/800 Verifier printer or if you want to have a sharper, more durable Command Code, Hand Held Products can prepare a customized code for you.

---

◆ **To use a customized Command Code:**

1. Scan the Command Code for the type of work you will be doing. The settings stored in that Command Code are now set in your unit.

◆ **To create a customized Command Code:**

1. Connect the Quick Check 600/800 Verifier to a printer and turn on both units. Refer to *Chapter 5, Saving and Printing* for instructions on connecting the unit and the printer. If you locked your unit by scanning a Locked Command Code, you must scan an Unlocked Code before you can make any changes.
2. Make any settings changes on the unit that you want to save on your Command Code. If you want to prevent others or yourself from making accidental or intentional changes to the verifier settings, scan a locked Code. (Remember, if you later decide to make changes, you must scan an unlocked code.) Your Command Code begins printing.
3. Label your customized printed Command Code on the line provided with a description of the code. You may also want to indicate if it is a Command- or Command+ Code.
4. To improve the bar code quality, make a copy of it on an office copier. Making a “reduced size” copy may also improve the quality.
5. If you want to change any of the settings, make sure your unit is unlocked, and repeat steps 2 through 4.

◆ **To request a Command Code from Hand Held Products:**

You can have Hand Held Products create your customized Command Code by mailing or faxing Hand Held Products a copy of the Customized Command Code Selections List with all of the options you want on the Code indicated. Be sure to keep the original list with your Command Code selections for your future reference. Mail your completed list to the Hand Held Products' office nearest you (see *Chapter 14, Customer Support*).



### Reviewing Scan Results

After you customize the verifier settings for your use, you are ready to scan bar code symbols. The verifier acquires and analyzes data using the ScanProfile Methodology specified in ISO/IEC's *Bar Code Print Quality Guideline* (ANS X3, 182). After a scan, the audio signal and the LEDs provide auditory and visual information about the symbol. The verifier provides results using either traditional print quality parameters to make a pass/fail judgement about the symbol or the ISO/IEC methods to judge a symbol and report an ISO/IEC scan grade. You can also review specific traditional or ISO/IEC parameters (dimensional, reflectance and format parameters). Each parameter is described later in this section. The flow chart in *Chapter 10, Flow Charts* displays all the scan data you can review and how to access each item using the menus.

### Scan Grades

The scan grade is also known as the "Scan Profile Grade." You can think of the scan grade as the grade resulting from a single scan across the symbol, for example, at exactly three millimeters from the top of the symbol. The scan grade is the lowest grade received by one of the following parameters after a specified number of scans (you specify the number of scans using the Extended Accuracy setting):

- Edge determination
- Rmin/Rmax
- Symbol contrast
- Minimum edge contrast
- Modulation
- Decodability
- Defects

The scan grade must also comply with any additional requirements imposed by the appropriate industry application standard, symbology specification or both for each scan. For example, if you set the passing option test criteria to traditional, the scan grade is a pass/fail judgement. However, if you set the passing option to ISO/IEC, the scan grade is a letter or number grade.

Using the Extended Accuracy mode greatly reduces reading variability due to variations in scanning motion and minor scan path variations. The Extended Accuracy settings you can specify to calculate the scan grade include off (1), 2 through 10, 12, 15, 20, 30, 50 and 100.

---

## *ISO/IEC Symbol Grade*

The ISO/IEC Symbol Grade is the average of the scan grades resulting from scans you take from different paths across the symbol. The ISO/IEC Symbol Grade is also referred to as the overall or final symbol grade. You can obtain a symbol grade only if the passing option test criteria is set to an ISO/IEC grade (not to traditional).

You use the #Scans/Symbol setting to specify the number of individual scan grades that you want the verifier to use to calculate the symbol grade. The available settings are 1 through 10, 12, 15, 20, 30, 50, 100 and Var. The default setting for #Scans/Symbol is 10.

The ISO/IEC standard requires you obtain ten scans of each symbol. For example, you might sample the symbol at ten different places in the symbol — four in the upper portion, two in the middle and four in the lower portion. Multiple scans of the same symbol across different scan paths take advantage of the vertical redundancy of bar codes and give you a more accurate value of the symbol's overall print quality. The flow chart shown on [page 4-3](#) explains how the ISO/IEC Symbol grade is determined.

## Determining the ISO/IEC Symbol Grade

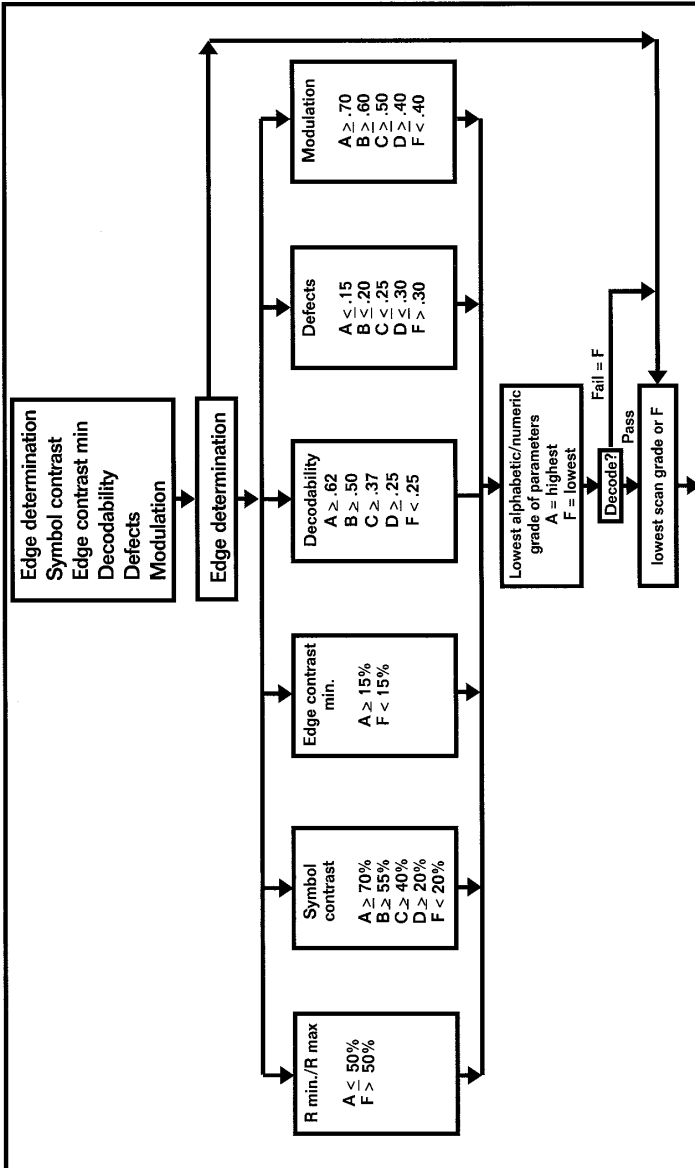

## Determining the ISO/IEC Symbol Grade (continued)

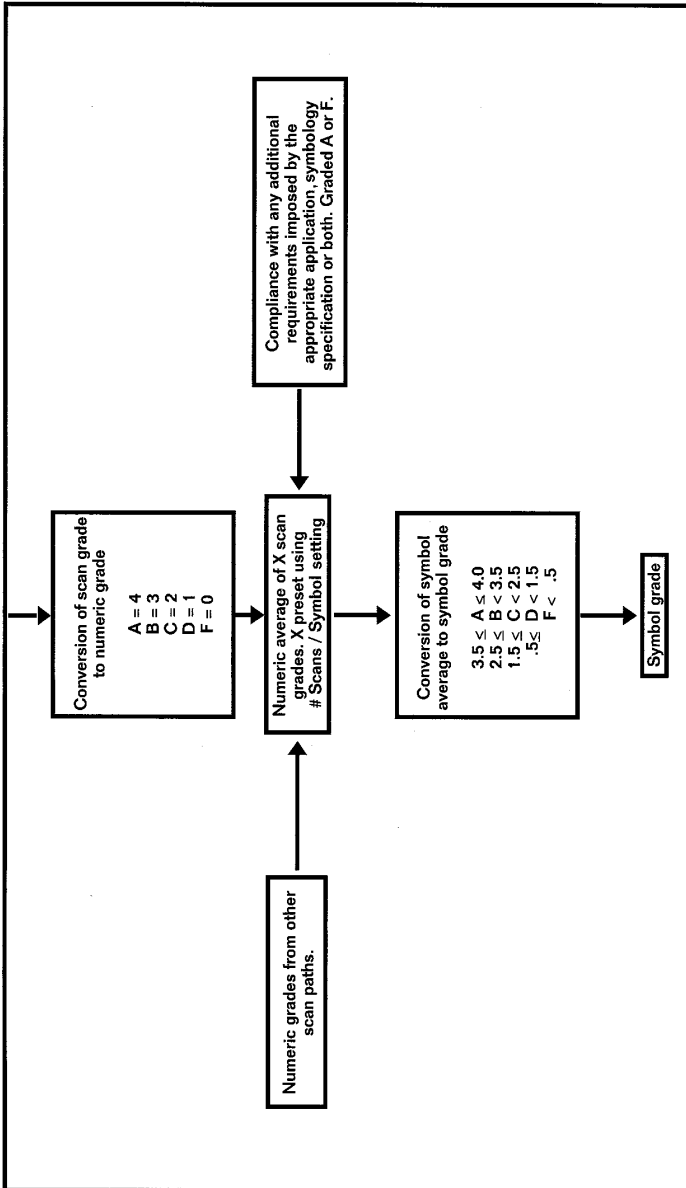



---

## Reviewing a Scan Example

To clarify the difference between a scan grade and a symbol grade, this section presents an example of how you might set up your verifier, scan the symbols and review the results. In this example, we change the verifier settings and see how they affect the results.

1. To begin, we set up the verifier with the following settings:
  - Test Criteria Passing Option set to ISO/IEC/ISO/IEC; the letter grade selected does not matter
  - Scanning Options Extended Accuracy set to 3; note that this setting affects the scan grade.
2. Scan a bar code symbol.  
After the first scan, a message appears stating we have two more scans to go (of the same scan path or line across the symbol) to satisfy the preset Extended Accuracy setting of 3.
3. Continue to scan the same line of the symbol for a total of three scans.  
After the third scan, the scan grade appears on the display (the scan grade is the lowest of the grades of all of the parameters, in this case, averaged for the three scans).  
We now have the scan grade for a specific path across the symbol.
4. Scan another line or path of the symbol three times to obtain a second scan grade.  
After the third scan of the second set, a different display appears. This display is the value we set for the #Scans/Symbol (2) and the number of scan grades used to determine the symbol grade.

*Note: If you set the Test Criteria Passing to traditional rather than to ISO/IEC grade, the scan grade is reported as Pass or Fail. The verifier does not report an ISO/IEC symbol grade when you select "traditional."*

### ◆ To obtain the scan grade and ISO/IEC Symbol grade:

1. Enter the Scanning Options Extended Accuracy setting you want. This setting determines the number of scans of the same path you want used to calculate the scan grade.  
If you set the Test Criteria Passing setting to ISO/IEC, you can obtain the ISO/IEC symbol grade:
  - Enter the Test Criteria Passing setting to an ISO/IEC grade
  - Set the Test Criteria #Scans/Symbol setting to the value you want. This setting determines the number of scans grades you want to use to calculate the final symbol grade.  
Refer to *Chapter 3, Changing the Settings* for instructions on changing the settings.
2. Scan the bar code symbol.  
The first line of this display provides the symbol or application name and the encoded scan data. If the first line of scan data exceeds 16 characters in length, a right arrowhead appears as the rightmost character of the display. Press → on the verifier to review all the decoded data. A left arrowhead

---

appears at the beginning of the decoded data to indicate there is more data to the left. Press ← to review the beginning of the message. The text on the other lines of the display depends on the Extended Accuracy option setting.

- If the Extended Accuracy setting is off, the scan grade display appears after a single scan of a symbol.
- If the Extended Accuracy setting is set to any value except off, a display appears with the term Extended Accuracy and the number of scans remaining to satisfy this setting.

3. To satisfy the Extended Accuracy setting, scan the same bar code symbol on the same path for the displayed number of times.
  - If you do not scan the same symbol within five seconds, the unit assumes you do not want to satisfy the Extended Accuracy setting you chose and displays the scan grade from that individual scan. If, after your first scan, you scan a different symbol type or a differently encoded symbol, the Extended Accuracy counter resets.
  - When you satisfy the Extended Accuracy setting, the scan grade display appears.
  - The second line of the scan grade display lists the three types of parameters, Dim (dimensional), Ref (reflectance) and Fmt (format). If an error exists in any of the parameters, that parameter name appears in all capital letters with a left and right caret pointing to it, for example, >DIM<.
  - The third and fourth lines of the scan grade display contain either ISO/IEC or traditional measurement results (parameters) depending on how you set the Test Criteria setting. Refer to later sections in this chapter for information about each parameter. You can review all the scan results using the arrow keys on the unit or use the SSTR (Single Scan to Result) codes described later in this section to review most of the scan results. For additional scan results, the LEDs light and/or flash, depending on how you set them up.
  - The large letter or number on the right of the display is the scan grade. If you set the verifier to use ISO/IEC criteria to test symbols, you can display the scan grade as a letter (A, B, C, D, or F) or as a number (4, 3, 2, 1, 0) using the Test Criteria Grades setting. If you set the unit to use traditional criteria to test symbols, a P or F appears for test pass or fail.

*Note: You may want to print each scan grade result. The printout you obtain after the verifier calculates the final symbol grade shows the symbol grade and the results of the last scan grade only, but does not show each scan grade averaged to calculate the final symbol grade. The results of each scan grade may be helpful if you are trying to determine if particular paths (upper versus middle versus lower) consistently provide different results.*

4. If you set the Test Criteria Passing setting to an ISO/IEC grade and you set the #Scans/Symbol setting to any value except 1, press ↑ to display the running symbol grade. To review the scan grade display, press ↓. Press ↑ to return to the symbol grade display.

---

*Note: If you set the Test Criteria Passing parameter to an ISO/IEC grade and you set the #Scans/Symbol parameter to 1, the scan grade is the same as the ISO/IEC symbol grade.*

- The first line of the symbol grade display provides the symbol or application name, the same as the first line of the scan grade display.
  - The second line of this display indicates this data is a final symbol grade, that is, it is an average of the scan grades you have obtained.
  - The third line provides a variety of information. The first of the three terms refers to the current average grade the symbol received. The subsequent terms, for example 06/660, refer to the wand aperture and the wavelength. These values are used to determine the symbol grade. Refer to ["If the unit was set to use the database feature before being turned off, the bottom line shows the term DATABASE." on page 1-9](#) for additional information.
  - The last line lets you check your status in relation to the symbol grade. The first value in this line tells you how many scan grades were used to calculate the displayed symbol grade. The second value tells you the number of scan grades required to calculate the final symbol grade.
  - The large letter or number on the right of the display is the symbol grade. The verifier can display the symbol grade either as letter (A, B, C, D, F) or as a number (4, 3, 2, 1, 0), depending on how you set the Test Criteria Grades parameter.
5. To obtain the final symbol grade, you must satisfy the #Scans/Symbol setting. Repeat steps 2 through 4, scanning the same bar symbol at different paths within the symbol.
- When you satisfy the #Scans/Symbol setting, the final symbol grade display appears.  
To review the scan grade display, press ↓. Press ↑ to return to the final symbol grade display.  
The types of data provided in the final symbol grade display are the same as those in the symbol grade display.

◆ **To review data from the last scan:**

1. If the Quick Check Verifier is turned off, turn it on.  
The opening display appears.
2. Press ←.  
The results from the last scan appear.

## ***LED Display***

The light-emitting diodes (LEDs) can indicate either bar growth and shrinkage based on traditional test criteria or a pass/fail grade result based on ISO/IEC grade criteria. You set the type of test criteria. Refer to ["Changing the Test Criteria" on page 3-8](#) for additional information.

---

For your convenience, the display option feature called “LEDs” allows you to select ISO/IEC test criteria yet have the LEDs display bar growth rather than ISO/IEC pass/fail grade. Refer to ["Changing the Output Options" on page 3-12](#) for additional information.

If you set the verifier to use traditional pass/fail test criteria, the color of each LEDs is always the same (first is red, second is yellow, third is green, fourth is yellow, fifth is red). After a scan, one or two of the LEDs flash to indicate the amount of growth or shrinkage. The following table correlates the LED color and the percent tolerance used.

<b>LED lit</b>	<b>% of bar growth tolerance used</b>	<b>LCD bar growth indication</b>
Green	0% to 25%	OK!
Green and yellow	25% to 50%	OK!
Yellow	50% to 75%	OK-, OK+
Yellow and red	75% to 100%	OK-, OK+
Red	>100%	LO!, HI!

For example, if you scan a UPC symbol at 100% magnification and the yellow LED on the left center flashes, it indicates that the tested symbol has used approximately 2 mil (2.0 to 3.0 mil [0.002” to 0.003”]) of the total tolerance ( $\pm$  4 mil [0.004”]) and that the symbol’s bars are too narrow.

If you set the verifier to use ISO/IEC methods to calculate the grade, the color of the LEDs will vary. After a scan, one of the LEDs flashes to indicate the scan grade (ISO/IEC Grade A, B, C or D). For example, if you selected ISO/IEC Grade C as passing and obtained a scan grade of A, the A LED flashes to indicate the scan grade the symbol received. In this case, the A, B and C LEDs will be green to indicate that all three grades are acceptable.

## *Audio Sounds*

The audio signal sounds to indicate the bar code symbol’s status to a battery of tests:

- One long beep followed by one short beep indicates a passing grade.
- One long beep followed by three short beeps indicates a failing grade.

You can easily and quickly perform pass/fail testing by scanning symbols and listening for a set of triple beeps to indicate failure and then review the display for specific information.

## Reviewing the Dimensional Parameters

The following table lists the dimensional parameters and summarizes their results. Descriptions of the parameters follow the tables.

Parameter	Trad'l	ISO/IEC
Average Bar Error (Avg Bar Err)	√	
Wide-to-narrow ratio (Wide/Nar Ratio)	√	
Decodability*		√

\* The method you select (Avg Decode or ISO/IEC) determines the scan and symbol grades.

Parameter	Result
Avg Bar Err	Compared against traditional print tolerance criteria set by symbology or application OK if within criteria Fail if outside criteria
Wide/Narrow Ratio	Compared against generic or user set limits for the symbology or application OK if within limits Fail if outside limits
Decodability	A if $\geq .62$ B if $\geq .50$ C if $\geq .37$ D if $\geq .25$ F if $< .25$

## Errors in Dimensional Parameters

If, after a scan, the abbreviation for dimensional appears as >DIM<, an error exists in one or more of the dimensional parameters. If there is an error, use the arrow buttons to review each parameter to identify the problem. If the abbreviation for dimensional appears as Dim, the symbol has no dimensional errors.

### Average Bar

The average bar print error (AvgBar) value is the amount of average bar growth or loss in the measured symbol relative to its "X" dimension. This value is compared against traditional print tolerance criteria and rated. If the AvgBar is within these limits, it is rated OK! or pass. If the AvgBar is outside these limits, this test fails.

---

## W/N Ratio

The wide-to-narrow ratio (W/N) applies to symbologies with two element widths including Code 39, Interleaved 2 of 5 and USS-Codabar. W/N is not meaningful for the other symbologies and is not displayed. When measured, the W/N value is compared against generic or user-specified limits appropriate for the symbology. If the W/N Ratio is within these limits, it is rated OK! or pass. If the W/N Ratio is outside these limits (HI! or LO!) this test fails.

## Decodability

Decodability is the percentage of the symbology's safe decoding margin available for the scanner after printing errors. Lower margin values and corresponding lower grades indicate an increased susceptibility to decoding failure due to scanning errors.

Scanning variations such as acceleration can cause bar or space deviations due to uneven, too fast or too slow scanning and provide lower margin values. You can set the type of decodability in the test criteria options to either ISO/IEC Decodability or character averaged decodability (Avg). With either calculation method, the decodability is rated A if  $\geq .62$ , B if  $\geq .50$ , C if  $\geq .37$ , D if  $\geq .25$  or F if  $< .25$ .

- ISO/IEC Decodability is a graded measure of how close a given scan comes to reference decode failure due to variations in bar and/or space widths.
- Character averaged decodability is also called "D margin."

### ◆ To review the dimensional parameters:

1. Scan a symbol.
2. If the cursor is not next to Dim, use the arrows to place it there.  
The first two dimensional parameters appear in the results line.
3. To view other dimensional parameters, press ↓.  
The names of the dimensional parameters and their results scroll.
4. To review other types of data (Ref or Fmt), press →.  
OR
5. To resume scanning, start at the quiet zone and scan the symbol.

## Calculating X

The total shown as the dimensional parameter is the total symbol width in "X" dimension terms. Formally, a bar code symbol's width includes the quiet zones. The value presented as total is a calculated count of the number of "X" dimensions from the starting bar through the ending bar of the scanned symbol. You can use this value and manually measure the symbol's actual width to calculate "X."

1. Press **SELECT** to display the menu with the term Print Results on top.
2. Press ↓ to move the cursor next to Calculate "X".

3. Press **SELECT**. The term Symbol Measures 00.00 Inches appears. The cursor appears in the whole number position. If you want to enter the symbol length in metric units (centimeters), enter the numeric value and then press → to move the cursor to Inches. Press ↑. The term changes to Centim.
4. Use the supplied ruler to measure the symbol length in decimal inches. Measure from the left edge of the first bar to the right edge of the last bar.
5. Press ↑ or ↓ repeatedly until you display the whole number of the symbol length. Press → to move the cursor to the tenths decimal place. Again, press ↑ or ↓ repeatedly until you display the value you want. In the same manner, enter the hundredths and thousandths values.
6. If you entered the symbol length in inches, continue with step 7. If you entered the symbol length in centimeters, press → to move the cursor to Inches. Press ↑. The term changes to Centim. Continue with step 7.
7. Press **SELECT**. The X value and the AvgBar value are calculated and displayed. If you entered 00.00, the X value is not calculated.
8. If you want to recalculate the X value using a different value for the symbol length, press ← to move the cursor to the left. The two lower lines of text disappear. Now press ↑ or ↓ repeatedly until you display the new value. Press **SELECT**. The X value and the AvgBar value are recalculated and displayed.

## *Reviewing the Reflectance Parameters*

The following table lists the reflectance parameters and summarizes their results. Descriptions of the parameters follow these tables.

<b>Parameter</b>	<b>Trad'l</b>	<b>ISO/IEC</b>
Print Contrast Signal(Prnt Contr Sig)	√	
Reflectance (Light) (Reflect (Light))	√	√
Reflectance (Dark)(Reflect (Dark))	√	√
Symbol Contrast (SymCntr)		√
Reflectance min/max (Rmin/Rmax)		√
Modulation		√
Edge contrast min (EdgeContr (min))		√
Defects		√

Parameter	Result
PCS	Pass if $PCS \geq 75\%$ , $RI \geq 25\%$ and $RD \leq 30\%$ Fail if not satisfied
RI/Rd	Pass if $Rd/RI \leq 50\%$ Fail if $Rd/RI > 50\%$
SymCont	A if $\geq 70\%$ B if $\geq 55\%$ C if $\geq 40\%$ D if $\geq 20\%$ F if $< 20\%$
Edge contrast (min)	A if $\geq 15\%$ F if $< 15\%$
Modulation	A if $\geq .70$ B if $\geq .60$ C if $\geq .50$ D if $\geq .40$ F if $< .40$
Defects	A if $\leq .15$ B if $\leq .20$ C if $\leq .25$ D if $\leq .30$ F if $> .35$

\* For UPC, the minimum P.C.S. varies depending on the measured R-Max.

## ***Errors in Reflectance Parameters***

If, after a scan, the abbreviation for Reflectance appears as >REF<, an error exists in one or more of the reflectance parameters. If so, you should use the arrow buttons to review each parameter. If the abbreviation for Reflectance appears as Ref, the symbol has no reflectance errors.

## **Print Contrast Signal, Light and Dark Reflectance**

During a scan, the Quick Check Verifier obtains the maximum light reflectance from spaces (Rmax or RI) and minimum dark reflectance from bars (Rmin or Rd). The print contrast signal, "P.C.S.," is a traditional measure of print contrast.  $PCS = (R[L] - R[D]) / R[L]$ . The traditional pass/fail criteria are PCS, 75% with RI  $\geq 25\%$  and Rd  $\leq 30\%$ .

The traditional parameters are rated OK! or pass if the PCS, RI and Rd meet these criteria. If a value does not meet the criteria, the Ref parameters fail (LO!). If the PCS, RI or Rd values appears on the display or on a printout as "XX" or "—", the reading is out-of-range. You should recalibrate the unit and then rescan the symbol.



---

*Note: Certain high reflectance materials may always read "XX" or "— —." You should repeat the calibration.*

The ratio of Rd/RI (Rmin/Rmax) must be less than 50% to pass this test. Alternately, you can consider  $R_d \leq 50\% R_I$ . RI may be rated LO!, but it is never rated HI!, while Rd may be rated HI! but is never rated LO!.

## **Symbol Contrast, Minimum and Maximum Reflectance**

Symbol contrast, SymContr, is a graded measure of the difference between the highest reflectance value R (max) and the lowest reflectance value, R (min), obtained during a scan.  $SC = R(\max) - R(\min)$ . Symbol contrast is rated A if  $\geq 70\%$ , B if  $\geq 55\%$ , C if  $\geq 40\%$ , D if  $\geq 20\%$  and F if  $< 20\%$ .

## **Edge Contrast**

Edge Contrast minimum is the smallest edge contrast or "edge transition" in a scan reflectance profile. The edge contrast is the difference between the reflectance of an adjacent bar and space. EC (min) is the minimum value of the edge contrast obtained during a scan. The criteria that edge contrast must be  $\geq 15\%$  must be met. The EC (min) is rated A if  $\geq$  than 15% or F  $< 15\%$ .

## **Modulation**

Modulation is a ratio of the edge contrast minimum value divided by the symbol contrast (EC (min)/SC). Modulation is rated A if  $\geq .70$ , B  $\geq .60$ , C if  $\geq .50$ , D if  $\geq .40$  and F if  $< .40$ .

## **Defects**

Defects is the graded measure of the maximum element reflectance non uniformity (noise within any element due to spots, voids, etc.), normalized to symbol contrast. High readings are caused by print defects found:

- in the symbol
- adjacent to the quiet zone
- at the transition of the label's edge when a label which may have a marginal or inadequate quiet zone is laid on top of another material.

Defects are rated A if  $\leq .15$ , B if  $\leq .20$ , C if  $\leq .25$ , D if  $\leq .30$  and F if  $> .30$ .

### **◆ To review the reflectance parameters:**

1. Scan a symbol.
2. If the cursor is not next to Ref, use the arrows to place it there. The first two reflectance parameters appear in the results line.
3. To view other reflectance parameters, press  $\uparrow$  or  $\downarrow$ . The names of the reflectance parameters and their results scroll.
4. To review other types of data (dimensional or format), press  $\rightarrow$  or  $\leftarrow$ .  
OR

5. To resume scanning, start at the quiet zone and scan the symbol.

## ***Reviewing the Format Parameters***

The following tables list the format parameters and their results. Descriptions of the parameters follow the tables.

<b>Parameter</b>	<b>Trad'l</b>	<b>ISO/IEC</b>
Message Length	√	√
Check Character	√	√
Symbol type	√	√

<b>Parameter</b>	<b>Result</b>
Message length	Compared against the appropriate symbology, user or application specification - OK if it meets the specification - Fail if it does not meet the specification
Check Character	Compared against the appropriate symbology or application specification or set by user - CkChr Checks if it meets the specification - Check Character Fails if it does not meet the specification - No Check Character if you do not set the unit to test check characters

## ***Errors in Format Parameters***

If, after a scan, the abbreviation for format appears as >FMT<, an error exists in one or more of the format parameters. If so, use the arrow buttons to review each parameter. If the abbreviation for format appears as Fmt, the symbol has no format errors.

### **Message Length**

The length of an encoded message is the number of characters in the output less any of the following characters:

- Start and stop characters (for Codabar and Code 39)
- Any symbology-required check characters (for EAN/UPC and Code 128)
- Any function characters (for Code 128, 16K and Code 49)

---

## Check Character

A check character in a symbol may be mandated by a bar code symbology specification, by you, by both or not at all. The display reflects the requirement and the result, either CkChr Checks if it passes or Check Character Fails if it fails. If you do not set the unit to test for a check character, the message NO Check Character appears. If the check character is bad, a message indicating that appears.

## Symbol Type

The symbol type refers to differences in symbol formats used in various applications. That is, the same symbol used in different applications may have a different length or a unique data or application identifier.

When you set the verifier to an application, the unit attempts to identify the symbol type. For example, if an AIAG Code 39 symbol is six or fewer numeric characters with a data identifier of Q, it is a “quantity” symbol. If the symbol is nine or fewer alphanumeric characters with a data identifier of S, it is a “serial number” symbol.

*Chapter 8, Using a Quick Check 800 Verifier* lists the symbol types and error messages. If an application does not have a unique symbol format, the unit will simply display the symbology.

### ◆ To review the format procedures:

1. Scan a symbol.
2. If the cursor is not next to Fmt, use the arrows to place it there.  
The first two format parameters appear in the results line.
3. To view other format parameters, press ↑ and ↓.  
The names of the format parameters and their results scroll.
4. To review other types of data (dimensional or reflectance), press → or ←.  
OR
5. To resume scanning, start at the quiet zone and scan the symbol.

## Reviewing Messages

Errors can result from a variety of causes. They can result from errors in dimensional, reflectance or format parameters generically or based on an application. An example of a generic (symbology) error message that may appear after scanning a symbol is “BAD QuietZon.” This message indicates that there is insufficient quiet zone width. *Chapter 8, Using a Quick Check 800 Verifier* lists error, application and type messages.

## Using SSTR Codes to Review Data

A Single Scan to Result (SSTR) Code is a bar code symbol that tells the verifier to execute certain command functions. If you scan an SSTR Code, the unit displays the scan result parameter represented by that bar code symbol. After you scan a symbol, either the default results appear (listed below) or, if you changed the output display options, the results you specified appear.

### SSTR Codes

SSTR Code Type and Name	Type	Test Criteria and Notes
Parameter SSTR Codes		
Average Bar Error	Dim	traditional
W/N Ratio	Dim	traditional
Decodability	Dim	ISO/IEC
R(l) : R(d)	Ref	traditional and ISO/IEC
P.C.S.	Ref	traditional
Symbol Contrast	Ref	ISO/IEC
Rmin/Rmax	Ref	ISO/IEC
Modulation	Ref	ISO/IEC
Edge Contrast (Min)	Ref	ISO/IEC
Defects	Ref	ISO/IEC
Symbol Type	Fmt	traditional and ISO/IEC
Message Length	Fmt	traditional and ISO/IEC
Default	Dim/Ref	ISO/IEC Decodability & Modulation traditional Average Bar Error and P.C.S.
Install Upper Line	—	installs upper result line
Install Lower Line	—	installs lower result line
Save Settings	—	saves settings

To review results that are not on the display, use the arrow buttons or simply scan one of the parameter SSTR codes for the type result you want. The result appears on the verifier's lower display line. Use the arrow buttons to step through the verifier's menus (Dim, Ref and Fmt) to view these results. *Chapter 11, SSTR Codes* includes a list of SSTR Codes.

Use the other SSTR Codes (Default, Install Upper Line, Install Lower Line and Save Settings) to customize your verifier.

If you want to review one or two parameter results after each scan, you can customize the verifier so these results appear as the default first screen. For example, if you are most interested in the message length and symbol contrast data, you can set your unit to display the message length and symbol contrast results automatically after each scan.

---

If you save your customized default results, the unit automatically enters these changes in the Output Options, Display Options line. To change the upper and lower result lines using the Display Options menu, refer to "[Changing the Output Options](#)" on page 3-12.

If you customize the display, you can use the SSTR Codes to review the data quickly. You can also use the Default SSTR Code to return the display to its factory default settings.

◆ **To quickly review data using SSTR Codes:**

1. Scan a symbol
2. Scan the SSTR Code that contains the parameter result you want to review. The parameter result appears on the lower line of the display.  
To review scan results not available using a SSTR Code (check character, error messages and calculating X), use the verifier's arrow buttons to select them. Refer to "Reviewing Scan Results" on [page 4-1](#) for instructions on reviewing data manually.

◆ **To customize the result display:**

1. Scan the Install UpperLine SSTR Code.  
The message Upper Line Result—INSTALL— appears.
2. Scan the SSTR Code for the result that you want displayed on the upper line after a scan.
3. Scan the Install LowerLine SSTR Code.  
The message Lower Line Result—INSTALL— appears.
4. Scan the SSTR Code for the result that you want displayed on the lower line after a scan.
5. Scan the Save Settings SSTR Code twice.  
After you scan this code once, the message —CONFIRM— Scan Again for YES appears.  
To save the display results, rescan the Save Settings Code. If you don't want to save the results, scan any other code.

◆ **To return the customized display to the default display:**

1. Scan the Default SSTR Code.  
After you scan a symbol, the default display appears. If you set the test criteria option to ISO/IEC, it has the ISO/IEC defaults; if you set the test criteria to Traditional, it has the traditional defaults.

## *Using the Quick Check Verifier as a Reflectometer*

Your verifier is capable of functioning as a static reflectometer. This capability is especially useful to investigate the underlying reflectance characteristics of bar code symbols or for testing the reflectance of potential bar (for example, ink) and space (for example, substrate) components.

---

When using the reflectance mode, the reflectance “seen” by the unit is continuously shown on the verifier’s display as both a two-digit reflectance percentage (from 0% to 99%) and on a graphic bar graph (gas gauge). For meaningful and consistent static reflectance values, you must calibrate the unit and hold the wand at the proper scan angle with its “foot” just touching the symbol. For information on proper scan technique and calibration, see *Chapter 2, Quick Start Guide*.

◆ **To use the Quick Check Verifier as a static reflectometer:**

1. Recalibrate the Quick Check Verifier if the calibration has not been performed recently.
2. Press **SELECT** to display the menu with the term Print Results on top.
3. Press ↓ to move the cursor next to Reflectom’r.
4. Press **SELECT**.  
The display changes to show the percent reflectance in large letters on the left of the display. The term Reflectance appears below the reading and a bar graph appears on the right of the display.

### *Saving Data*

When you scan a bar code symbol and you do not have a printer connected to the Quick Check 600/800 Verifier, or a printer is connected but not turned on, you can store or save, the scan results in the verifier's print buffer. You can print the stored results at a later time. There are two ways to save data — using the AutoPrint/Store feature or through the Print Results menu.

◆ **To save scan data:**

1. Set the AutoPrint/Store feature to On.  
Refer to the instructions in *Chapter 3, Changing the Settings* for changing the settings.
2. Scan a bar code symbol.  
The verifier automatically saves the results in its print buffer.

OR

1. Scan a bar code symbol.
2. If the AutoPrint/Store feature is set to Off, press **SELECT** three times.
  - Pressing **SELECT** the first time displays a menu that begins with Print Results and the cursor is on the asterisk next to Print Results.
  - Pressing **SELECT** a second time displays a message stating that a printer is not attached and asks if you want to store the data.
  - Pressing **SELECT** a third time saves the data. The verifier saves the results in its print buffer.

### *Checking the Print Buffer During Operation*

When you turn on the Quick Check 600/800 Verifier, a message appears if there are records stored in its print buffer. You can also check the print buffer status during operation, called “on-demand checking.”

The print buffer display provides both the percent of the memory used for the stored records and the number of scan or profile records in the memory. The amount of data you can store in the buffer depends on the symbology type and the number of encoded data characters. In some cases when you are saving scan profile data, memory may be almost full with data from just a few scans. In other cases, the buffer may contain data from hundreds of scans, but only be 50% full. The unit can store approximately 2000 scans of U.P.C.-A code. When the buffer reaches capacity, a full buffer message appears.

---

◆ **To check the print buffer during operation:**

1. Display the menu that begins with Print Results.  
If scan results are displayed on the verifier, press **SELECT**.  
If a menu (for example, a change setting menu) is displayed on the verifier, press **POWER** repeatedly.
2. Press **POWER**.
3. Press **↑**.  
The on-demand print buffer display screen appears. The display provides the percent of the memory used for the stored records and the number of scan records in the memory. You can respond in one of three ways: a.) Cont., b.) Prnt or c.) Cir. The cursor is at the asterisk next to Continue.
  - 3.a **To continue obtaining scan results**, press **SELECT**. The opening display appears. You can then scan a symbol.
  - 3.b **To print the stored records**, press **→** to place the cursor on the asterisk next to Print. Then press **SELECT**. The stored records print. Once printed, the stored results are removed from the verifier's memory; however, the results from the last scan remain in the buffer. (Press **←** to display the last scan's results.)
  - 3.c **To clear (delete) the records stored in the memory**, press **→** twice to place the cursor on the asterisk next to Clear and then press **SELECT**. The stored results and the results from the last scan are deleted from the verifier's memory.

## *Printing Data*

When a printer is attached to the verifier and turned on, you can print the current scan results stored in the buffer. For this discussion, "current data" are data from a scan that you just took and whose results are on the verifier's display, or data from a scan that you will perform momentarily. "Stored data" are scan records stored or saved in the buffer. There are two ways to print current data — using the AutoPrint/Store feature or through the Print Results menu. There are also two methods to print stored data — through the Print Results menu or through the Print Buffer menu.

To print results, the Printer type (QCP or QCHSP) in the Printer Options menu must match the type of printer you have connected to the verifier. If the connected printer and the displayed printer abbreviation do not match, the printout will be illegible.

◆ **To print current data:**

1. Connect the verifier and the printer and turn on both units. Be sure the Printer type setting in the Output Options, Print Options menu matches the type of printer to which the verifier is connected. Refer to "[Changing the Output Options](#)" on page 3-12 for instructions.



- 
2. Scan a bar code symbol.
    - If the AutoPrint/Store feature is set to On, the results print.
    - If the AutoPrint/Store feature is set to Off, press **SELECT** twice. After you press **SELECT** the first time, a menu that begins with Print Results appears and the cursor is on the asterisk next to Print Results. After you press **SELECT** a second time, a message appears that asks if you want to print all the stored results, print just the results of the last scan or if you want to clear the buffer.
  3. Press ↓ to move the cursor next to Latest Result Only.
  4. Press **SELECT**.  
The data prints.

◆ **To print stored data:**

1. Connect the verifier and the printer and turn on both units. Be sure the Printer type setting in the Output Options, Print Options menu matches the type of printer the verifier is connected to. Refer to "[Changing the Output Options](#)" on page 3-12 for instructions.
2. With any data displayed on the verifier, press **SELECT** three times. After you press **SELECT** the first time, a menu that begins with Print Results appears and the cursor is on the asterisk next to Print Results. After you press **SELECT** a second time, a message appears that asks if you want to print out all the stored results, print just the results of the last scan or if you want to clear the buffer. The cursor appears next to All Stored Results. After you press **SELECT** the third time, the stored data prints.

OR

1. Display the print buffer message. Refer to "[Checking the Print Buffer During Operation](#)" on page 5-1 for instructions.
2. Use the arrow buttons to move the cursor to the asterisk next to Print.  
The stored data prints and clears the records from the buffer, but the data from the last scan remains in the verifier.

◆ **To stop printing:**

1. During printing, press and momentarily hold **POWER** on the verifier.  
Printing stops when the printer's internal buffer is clear.

OR

2. Wait until the printer stops automatically.

## *Deleting Stored Data*

You can delete stored data from the verifier's memory using the Print Buffer menu or the Print Results menu.

---

◆ **To delete stored data:**

1. Connect your printer to the verifier and turn on both units.  
The opening display appears.
2. A PRINT BUFFER message appears asking if you want to continue, print or clear.
3. Press ↓ and then → to move the cursor next to Clear.
4. Press **SELECT**.  
The results stored in the verifier and the data from the last scan are deleted.  
If you don't want to clear the stored results, move the cursor next to Cont and press **SELECT**.

OR

1. Connect your printer to the verifier and turn on both units.  
The opening display appears.
2. When you select the Print Results menu, a menu appears asking if you want to print All Stored Results, the Latest Stored Results Only or Clear Buffer!.
3. Press ↓ to move to select Clear Buffer!.
4. Press **SELECT**.  
The results stored in the verifier and the data from the last scan are deleted.  
If you don't want to clear the stored results, move the cursor next to Cont and press **SELECT**.

## *Interfacing With a Computer*

You can use the QCViewerII software and print to a local or network printer, or connect the verifier to an RS-232 serial communication device using the larger port on the back of the unit and a QCDB09F cable. If you have the appropriate computer software, you can display the verifier data on your computer. Contact Hand Held Products for additional information about connecting the verifier to a computer.

## *Reviewing the Printouts*

All the information presented on the printout is also available on the display after you scan a bar code symbol. Refer to *Chapter 4, Reviewing Scan Data* for information on displaying this data.

## QCP and QCHSP Printouts

\*\*\*Quick Check 600\*\*\*  
660 nm, 06 mil Scanner

Interleaved 2/5

123456

- Extended Accuracy! -

Avg Bar Err = -.05X	OK!
Wide/Nar Ratio = 2.5	OK!
Decodability = 53%	<B>
Symbol Total = 055"X"	
Prnt Contr Sig = 92%	OK!
Reflect(Light) = 86%	OK!
Reflect(Dark) = 05%	OK!
Symbol Contrst = 81%	<A>
R(min)/R(max) = 06%	<A>
Modulation = 91%	<A>
EdgeContr(min) = 73%	<A>
"Defects" = 05%	<A>
Message Length = 06	OK!

— No Check Character —

Bar Growth IN TOL

"P C S" OK

Traditional Tests -PASS-

Format Tests -PASS-

ISO/IEC Parameters	<B>
Add'l P/F Checks	<P>
Format Checks	<P>
Profile Quality Grade	<B>
Passing Level: ISO/IEC	<C>
==> ScanProfile PASSES	

Symbol Grade
Avg. 4.0 => A/06/660
After 002 of 010 Scans

Name:

Date:

---

## *Printing Guidelines*

The verifier supports two different Hand Held Products serial printers:

- Quick Check® Standard Speed Printer (QCP)
- Quick Check® High Speed Printer (QCHSP)

The QCP and QCHSP are both impact printers.

When you first receive your printer, you should unpack it carefully. Before attempting to use it, inspect the contents of the package for any shipping damage. If there is evidence of damage, please keep ALL packing materials and contact the delivery carrier **as soon as possible** for the claim procedure.

Confirm that you have the following items:

- Printer
- One roll of paper
- Power supply

For optimal printer performance, follow these general guidelines for any type of printer:

- Never place the printer where it is exposed to direct sunlight.
- Never apply power while you are plugging or unplugging an input connector.
- Do not print without paper or a ribbon because this may damage the print head.
- Do not subject the printer to temperatures below 5° C or above 40° C during operations or to a sudden change in temperature.
- Insert the connectors so that a slight pressure seats the cable properly. Never force the connectors because this could damage the cable.

## *Using the QCP or QCHSP*

The QCP and QCHSP models are shown on [page 5-7](#).

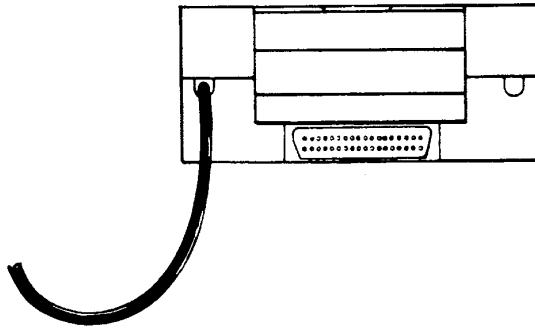
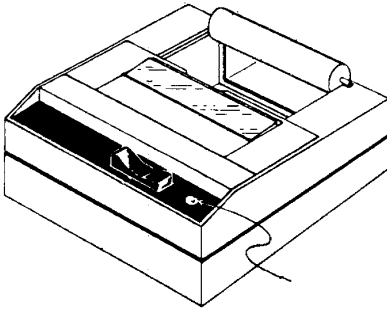

Quick Check Printer (QCP) and Quick Check High Speed Printer (QCHSP)  
 A three-position power switch on the printer's front panel determines its function:

Switch Position	Function
Down Left	Off
Center	On
Down Right	Paper Feed

A red light-emitting diode (LED) to the right of the power switch lights to indicate the On and Paper Feed states.

The printer has a VAC transformer with an 8-foot cord. The power transformer cord has a transformer on one end and has a mating connector to the printer on the other end.

An interface cable connects the printer directly to the verifier to provide easy exchange of scanning results. The connectors on each end of the cable are keyed so that they cannot be plugged in the wrong way.

---

The printer has a replaceable cartridge ribbon. Replace the paper roll when it is empty.

◆ **To turn on and off the QCP or QCHSP:**

1. To turn on the printer, press the power switch into the On (center) position.
2. To turn off the printer, press the power switch into the Off (down left) position. After you turn off the printer, wait at least three seconds to turn on the power for the proper initialization procedure.

◆ **To set up the QCP or QCHSP:**

1. Place the printer on a hard, flat surface such as a table or desk top.
2. Press the power switch into the Off (down left) position.
3. Plug the power connector from the transformer into the printer.
4. Plug the transformer into a VAC wall outlet.

◆ **To install or replace the QCP or QCHSP paper roll:**

1. Press the printer power switch to the Off (down left) position.
2. Remove the printer cover by locating the four small grooves embossed on each side of the printer cover and tilting the cover open by pushing down gently on both sets of these grooves.
3. If necessary, remove the empty roll. Press and hold the power switch in the Paper Feed (down right) position to advance the paper about one inch beyond the paper cutter. Lift the empty roll from the printer housing.



Do not pull paper out of the back of the printer as this will damage the mechanism.

**WARNING**

- 
4. Unroll several inches of paper from a new roll and cut a straight edge on the paper if it is jagged or wrinkled. (A straight edge helps guide the paper into the printer.)

- 
- Slide the paper's straight edge into the slot between the paper compartment and the printer compartment until about one-quarter of an inch is inserted.

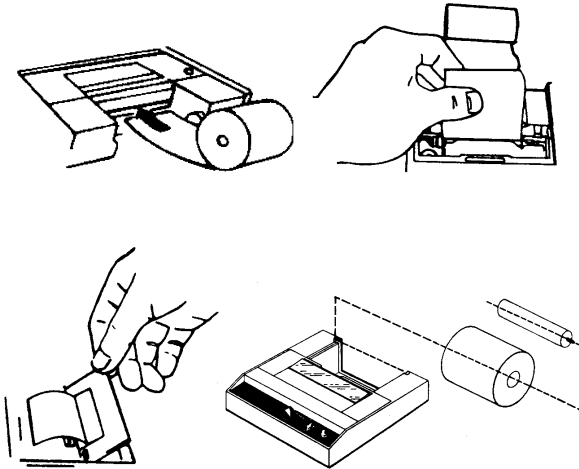

- Press the power switch to the center On position and wait a few seconds.
- While holding the paper in place, press and hold the power switch in the Paper Feed (down right) position until an inch of paper emerges from the printer and then release the switch.
- Pull the paper through the printer until several inches are exposed.
- Put the paper spindle into the paper roll and place the roll and spindle onto the grooves near the back of the printer.
- Roll the paper to take up any slack inside the printer.
- Ensure the roll turns freely. If the paper roll does not turn freely, the paper may jam and damage the mechanism.
- Slide the paper's straight edge through the slot in the printer cover.
- Replace the printer cover by pushing the back of it down into place and pressing the front down to lock it in place.

◆ **To remove the ribbon from the QCP or QCHSP:**

- Press the printer power switch to the Off (down left) position.
- Remove the printer cover by locating the four small grooves embossed on each side of the printer cover and tilting the cover open by pushing down gently on both sets of these grooves. The ribbon cartridge should be visible.
- Push down on the right side of the ribbon cartridge (marked PUSH) and remove the cartridge from the printer compartment.

- 
4. Slide the paper through the gap between the inked ribbon and the frame of the new ribbon cartridge.
  5. Set the new cartridge into the printer compartment and press both sides to secure it in place.  
The cartridge must be properly seated and aligned for the best print quality. If you get ribbon ink on the printer's plastic case, wipe it off immediately. Once the ink dries, it is difficult to remove.
  6. Replace the printer cover by pushing the back of it down into place and pressing the front down to lock it in place.
  7. Turn the cartridge ribbon advance knob (marked by an arrow on the cartridge) clockwise to remove slack from the ribbon.
  8. Replace the printer cover.

◆ **To connect the QCP or QCHSP to the Quick Check 600/800 Verifier:**

1. Press the printer power switch to the Off (down left) position.
2. Plug the transformer into a VAC outlet.
3. Plug the interface cable into the socket on the side of the verifier.
4. Connect the 25-pin connector of the interface cable into the rear of the printer. Secure the connector by tightening the screws on each side of the connector.
5. Press the power switch to the On (center) position.  
The red LED lights and a Ready message appears indicating that the printer's built-in microprocessor has verified its internal operation.

◆ **To perform a QCP or QCHSP self-test:**

The self-test tests the print head and ribbon.

1. Ensure the power switch is in the Off (down left) position and there is paper in the printer.
2. Plug the power source into the printer.
3. Press and hold down the power switch in the Paper Feed (down right) position until the LED lights and the printer starts to operate.
4. Release the power switch.  
The printer performs the self-test and prints its full set of characters.



---

## *Troubleshooting the QCP or QCHSP*

Printing difficulties may be caused by selecting the incorrect printer interface configuration for the type of printer you are using.

- For the QCP, select **QCP**.
- For the QCHSP, select **HSP**.

For instructions on selecting the printer interface setting, see *Chapter 3, Changing the Settings*.

If you use your printer infrequently, the print impression can become weak if the ribbon dries out. If the printed material is difficult to read and you suspect this is the cause of the problem, press the power switch to the Paper Feed position and advance to a properly inked portion of the ribbon.



### *General Bar Code Information*

Bar code technology allows you to get information into a computer much more accurately than keying. Quick Check 600/800 Verifiers measure the quality of the bar code symbols to ensure the proper information is encoded and can be read. This instrument is both a quick, easy-to-use pass/fail tester for bar code symbols and a powerful measuring tool for detailed testing of these same symbols. You can set your verifier to use either traditional or ISO/IEC parameters to analyze bar code symbols. The quality information from the verifier is presented through an easy-to-read liquid crystal display (LCD), light emitting diodes (LEDs), audible tones and printouts.

Bar code symbols consist of a series of parallel, adjacent bars and spaces. Data is encoded in the width patterns of the symbol. These patterns, when interfaced with computer software, provide a large amount of information. Bar code systems offer a high degree of confidence that data entry is accurate. The substitution error rate, the rate at which a character may contain an error, is very low. The first read rate, the probability (percentage) that an attempt to input data will result in data being captured on the first attempt, is very high.

Bar code technology dates back to the 1960s and early 1970s, but did not come into widespread use as we know it today until the later 1970s. Retail applications, primarily grocery stores, saw the need for automatic identification technology and pushed development ahead. As many other industries began to take advantage of bar code technology, they often needed to develop their own symbology, or type of bar code, with unique specifications and standards.

Depending on the data that needs to be recorded, several different symbologies can be used. Communication cannot occur unless the reading and printing tools use a compatible symbology.

The symbologies tested by the verifier include:

- EAN/UPC
- Code 39
- Interleaved 2 of 5
- Code 128
- Code 93
- Codabar
- Code 11
- Code 16K
- Code 49
- MSI Code

---

The industry standards (applications) tested by the verifier include:

- AIAG
- BOOKLAND
- CCBBA
- COMPTIA/CTIA
- HIBCC
- LOGMARS
- SCC (SCS/ITF, UCC/  
EAN-128)
- SISAC
- UPC Coupon Code

## *Symbology Specifications*

The reading and printing specifications for each symbology are defined by various organizations. The verifier uses these specifications to give you quantitative and qualitative information. You can set the verifier to provide different standards to suit your company's internal quality control guidelines.

## *Symbologies*

The following table lists the symbologies that your Quick Check 600/800 Verifier can verify, the major industries that use each symbology, and the organizations that hold the standards. Following the table is a list of the abbreviations for each organization, along with an address and phone number you can write or call for additional information.

<b>Symbology</b>	<b>Industries</b>	<b>Organization</b>
UPC	grocery, identifies product and manufacturer	GS1
Codabar & USS Codabar	blood banking, Library of Congress, photo finishing, air parcel delivery	CCBC AIM-USA
Code 39	automotive, health, industry, non-retail	DOD, AIAG, HIBCC, AIM-USA
Code 11	industrial	AIM-USA
Interleaved 2 of 5	shipping containers for grocery warehousing and distribution	GS1 AIM-USA
Code 16K	health, microcomputer serials industry, UCC shipping	HIBCC, ABCD AIM-USA
Code 128	containers, health, industry	SISAC, GS1,
Code 49	health, industrial	HIBCC
Code 93	industrial	AIM-USA
MSI Code	shelf marking	AIM-USA

---

**ABC (formerly CCBC)** - America's Blood Centers, 725 15th Street NW, Suite 700, Washington, DC 20005, Tel: (202) 393 5725, Fax: (202) 393 1282, <http://www.americasblood.org/>

**AIAG** - Automotive Industry Action Group, 26200 Lahser Rd., Suite 200, Southfield, MI 48033, Tel: (248) 358-3570, <http://www.aiag.org/Index.cfm>

**AIM North America** - A chapter organization of AIM, Inc., 125 Warrendale-Bayne Road, Warrendale, PA 15086, Tel: (724) 934 5688, Fax: (724) 934 4495, <http://www.aimusa.org/>

**BASIC** - Book and the Serial Industry Systems Advisory Committee, Sub-Committee of the Book Industry Study Group (BISG), 19 West 21st Street, Suite 905, New York, NY 10010, Tel: 646-336-7141, Fax: 646-336-6214, email: [info@bisg.org](mailto:info@bisg.org)

**Comp TIA** - Computing Technology Industry Association, 1815 S. Meyers Road, Suite 300, Oakbrook Terrace, IL 60181-5228, Tel: (630) 678 8300, Fax: (630) 678 8384, [http://www.comptia.org/association\\_home.aspx](http://www.comptia.org/association_home.aspx)

**DoD Logistics AIT Office** - Automatic Identification Technology, 8725 John J. Kingman Road, Fort Belvoir, VA 22060, Tel: (703) 767 6200, <http://www.dodait.com/>

**GS1 (formerly UCC and EAN)**

**Brussels** - Blue Tower, Avenue Louise, 326, BE 1050 Brussels Belgium, Tel: +32 2 788 7800, Fax: +32 2 788 7899

**GS1 US** - Princeton Pike Corporate Center, 1009 Lenox Drive, Suite 202, Lawrenceville, New Jersey, 08648 USA, Tel: (609) 620 0200, Fax: (609) 620 1200, E-mail: [info@gs1us.org](mailto:info@gs1us.org), <http://www.gs1us.org>

**HIBCC** - Health Industry Business Communications Council, 2525 E Arizona Biltmore Circle, Suite 127, Phoenix, AZ 85016, Tel: (602) 381 1091, Fax: (602) 381 1093, E-mail: [info@hibcc.org](mailto:info@hibcc.org), <http://www.hibcc.org/>

---

## Symbology Characteristics

Your Quick Check 600/800 Verifier can handle bar code symbologies with a variety of characteristics. To help understand symbologies, you should be familiar with the following commonly used terms:

- **Code** refers to the actual data contained in the bar code symbol, such as a part number, serial number, transaction code or other type of data.
- **Symbol** refers to the actual arrangement of parallel bars and spaces that encode the data.
- The **character set** describes the range of data characters that can be encoded in a given symbol. For example, UPC uses only numbers and is called a numeric symbology, whereas Code 39 uses alphabetical characters, numbers and special characters.
- There are two **symbology types**, discrete and continuous.
  - In a **discrete** code, each character stands alone and can be decoded. Between characters is a loosely tolerated intercharacter gap which contains no information. Every discrete character has a bar on each end. One example of a discrete code is Code 39.
  - In a **continuous** code, there are no intercharacter gaps. Every character begins with a bar and ends with a space. The end of one character is indicated by the start of the next character. An example of a continuous code is UPC.
  - The **bar and space widths** can vary within or between symbologies; those with only two-element widths (wide and narrow) versus those that use multiple widths.
  - **Two-width symbologies**, such as Code 39, have a ratio of wide to narrow typically between two and three.
  - **Multiple-width symbologies**, such as UPC, allow the bars and spaces to assume more than two different widths. Most multiple-width symbologies have characters whose length is subdivided into a predetermined number of modules. In addition, the width of each bar or space is always an integral number of modules.

Bar code symbologies vary on the amount of information that can be encoded in a given length. Usually, only characters have a specified **density**, since the overall length of a symbol must include other characters. These other characters may include a start/stop code and a check character.

- A **start** code is a pattern of bars and spaces that appears at the beginning of a symbol to inform the reading tool where the symbol begins.
- A **stop** code is a pattern placed at the end of a symbol for marking the end of the data characters. Sometimes the start and/or the stop characters also indicate the scanning direction.

**Quiet zones** are areas at the beginning and end of a bar code symbol that allow the optical equipment to differentiate a bar code from other printed material. Most of the symbologies in use today are **bidirectional**; this means that they can be read by a scanner either left-to-right or right-to-left without affecting the decoded data.

---

A **check character** is a character placed in a predetermined position in a symbol and whose value is based on some mathematical relationship of the other characters in the symbol. It is used by the scanner to validate that the correct data has been decoded. If a numeric symbology contains a check character, it is often called a **check digit**.

The following illustration shows many of these bar code parameters.

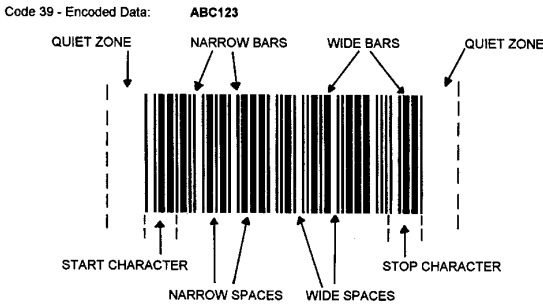

Bar code symbol parameters

The following table lists some characteristics of the nine bar code symbologies decoded by the Quick Check 600/800 Verifier.

<b>Symbology</b>	<b>Character Set</b>	<b>Element widths</b>
UPC	numeric	4 widths
EAN	numeric	4 widths
Codabar/USS Codabar	numeric with 6 special characters	2 widths
Code 39	alphanumeric, 26 uppercase letters, 10 digits, 7 special characters	2 widths
Code 11	numeric and ---	3 widths
Interleaved 2 of 5	numeric	2 widths
Code 16K	alphanumeric with all function codes and special characters (full ASCII set)	2 widths
Code 128	alphanumeric with all function codes and special characters (full ASCII set)	4 widths
Code 49	alphanumeric (all 128 ASCII characters)	6 widths (stacked symbology)
Code 93	alphanumeric (all 128 ASCII characters)	4 widths
MSI Code	numeric	4 widths

### *How a Bar Code Verifier Works*

A bar code reader or scanner extracts the information that is optically encoded in a bar code symbol and converts it into computer-compatible digital data.

Hand Held Products provides a variety of handheld wand or pen scanners with the verifier that are designed to minimize scratching the symbol. When you place the wand on a bar code symbol and move it across the symbol, electro-optical techniques read the symbol. All wands contain a light emitting diode (either visible or infrared light) which illuminates the symbol.

The area of the symbol that is actually being scanned at any given time is referred to as the “spot” and is defined by an aperture. The spot size varies depending on which wand is used. The spot is formed by flooding the symbol with light. A tightly focused aperture collects the light. The light reflected from the spot is directed to a photodiode detector which generates a small current



---

proportional to the amount of light returned. A symbol's spaces reflect more light than the bars. As the wand is moved across the bar code symbol, the analog voltage varies, creating a graphic scan profile. The scan profile is the basis for verifying the bar code symbol.

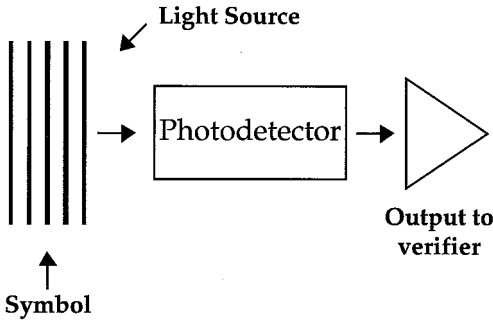

#### Scanner Illumination

It is important to have a uniform velocity when scanning bar code symbols because the relative widths of the actual bars and spaces are determined by measuring the time that the electrical signal from the scanner spends at the voltages that represent either black or white, respectively. The verifier will notify you if you scan too fast, too slow or unevenly.

Also, severe changes in ambient light may cause misleading scan profile or reflectance readings. Therefore, it is important to calibrate and use the verifier in the same general ambient light and, when in use, to minimize variation in the intensity of the ambient light.

Once collected by the electro-optical components, the data is transmitted to the computer in the verifier. The verifier assesses the data and determines the quality parameters.

### *Additional Information*

For additional information on bar code technology, you can refer to the associations and books listed below.

- **AIM North America** - A chapter organization of AIM, Inc., 125 Warrendale-Bayne Road, Warrendale, PA 15086, Tel: (724) 934 5688, Fax: (724) 934 4495, Email: Mary Lou Bosco, <http://www.aimusa.org/>
- **GS1** (formerly UCC and EAN)  
Brussels - Blue Tower, Avenue Louise, 326, BE 1050 Brussels  
Belgium, Tel: +32 2 788 7800, Fax: +32 2 788 7899
- **GS1 US** - Princeton Pike Corporate Center, 1009 Lenox Drive, Suite 202, Lawrenceville, New Jersey, 08648 USA, Tel: (609) 620 0200, Fax: (609) 620 1200, E-mail: info@gs1us.org, <http://www.gs1us.org>

- 
- **ANSI** - American National Standards Institute, 25 West 43rd Street, (between 5th and 6th Avenues), 4 floor, New York, NY 10036, Tel: (212) 642 4900, Fax: (212) 398 0023, <http://www.ansi.org/>
  - *The Bar Code Book-Reading, Printing and Specification of Bar Code Symbols*. Roger C. Palmer. Helmers Publishing, Inc., Fourth Edition. 2001, ISBN: 0911261133.
  - *Reading between the lines: an introduction to bar code technology*. Craig K. Harmon and Russ Adams, Helmers Publishing, Inc., Fourth Edition. 1989, ISBN: 0911261001.
  - *Revolution at the Checkout Counter : The Explosion of the Bar Code*. Stephen A. Brown, Harvard University Press 1997, ISBN: 0674767209.

### *Understanding the DataMatch Feature*

You can load a database into your Quick Check 600/800 Verifier. Then, when you scan a bar code symbol, you can review not only the scan results, but also any information contained in the database about that scanned symbol. The additional information may be, for example, the name of the product.

You can use the DataMatch feature in any of these ways:

- Display (append) the database information to the decoded data so both types of information appear on the first line of the verifier display.
- Replace the first line of the verifier display with the database information.
- Verify that the symbol is in the database.

If the verifier was set to use DataMatch before it was turned off, the term DataMatch appears on the last line of the opening display when you turn on the unit.

### *Downloading DataMatch*

DataMatch.EXE is a PC database compacting and downloading utility program available from [www.handheld.com](http://www.handheld.com). Select Services & Support - Download Software, and select the Quick Check 600/800 Verifier. You can also use the following link: [http://www.handheld.com/Site.aspx/na/en//developers/download\\_software/?product=2](http://www.handheld.com/Site.aspx/na/en//developers/download_software/?product=2).

### *Structuring and Loading the Database*

You must structure each record in your data file before you use this program to load the database. The data file structure must be:

*SYM*<TAB>DECODE<TAB>MATCH<CR><LF>

### **SYM**

SYM is a three character symbology identifier:

**SYM Identifier**

**Code**

---

---

UPC or upc	UPC Code
EAN or ean	European Article Number
CBR or cbr	Codabar
C39 or c39	Code 39
I25 or i25	Interleaved 2 of 5
C93 or c93	Code 93
128	Code 128
C11 or c11	Code 11
MSI or msi	MSI Code

---

***DECODE***

*DECODE* is the encoded information that appears on the verifier display in a “human readable format.” The following constraints apply to the format of *DECODE*:

- UPC and EAN must include the check digit and number system character or “flags” separated by “-”
  - UPC-A: X-XXXXXXXXXX-X
  - UPC-E: X-XXXXXX-X
  - EAN-8: X-XXXXXX-X
  - EAN-13: XX-XXXXXXXXXX-X
- If applicable, Code 39, Interleaved 2 of 5, Code 11 and MSI should include proper check digits in parentheses.
- Codabar and Code 39 should show applicable Start/Stop Characters. Codabar Start is represented by “A” and Stop by “B.” Code 39 Start and Stop are both represented by “\*.”

***MATCH***

*MATCH* is the alternate message or database descriptor for the symbol and its encoded data. It should be a maximum of forty (40) characters.

The length of *MATCH* will affect the number of records (or items) that you can store in the database section of your verifier. For example, with a 40-character *MATCH* per record maximum, you can store one thousand records or items.

You can name your database in any manner, adding the extension .dat to the filename.

- ◆ **To load the database into the verifier:**
  1. Structure your database as described above.
  2. Connect the verifier to your computer’s serial port using a PC Interface Cable (QCDB09F or QCDB25) and turn on the unit.

3. Open DataMatch (exe).

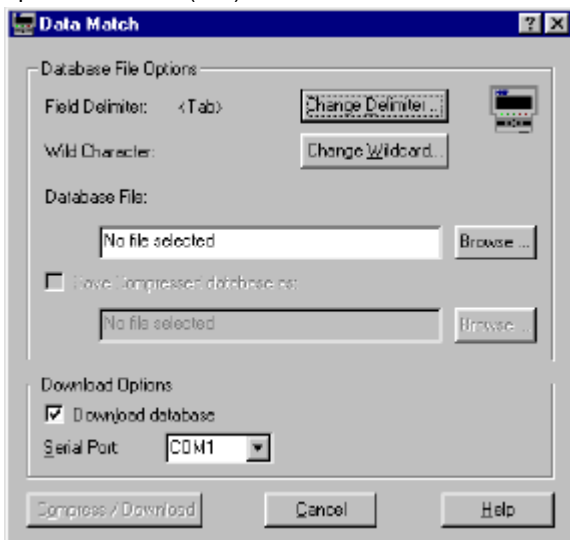

4. Select a database file.

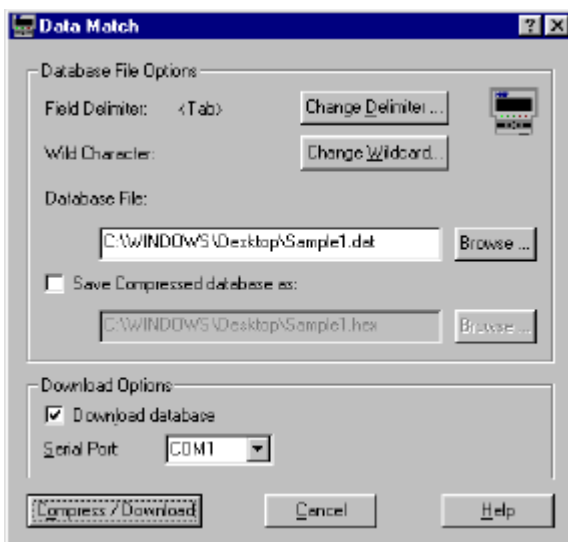

5. Select the "Compress/Download" button.

- The program walks you through the download steps and lets you know when the process is finished.

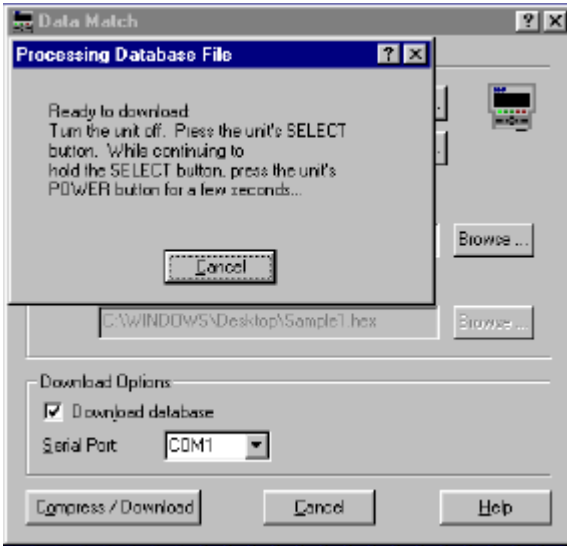

## Selecting the DataMatch Feature

You can enable the verifier to verify symbologies, an application or use DataMatch. You enable DataMatch using the same procedure as you would to select a symbology or an application.

### ◆ To select DataMatch:

- Download the database into your verifier.
- Press **SELECT** from the main menu.
- Set the cursor on the asterisk next to Change Settings and then press **SELECT**.  
A menu that begins with Specifications appears.
- With the cursor on the asterisk next to Specifications, press **SELECT**.  
A menu with a list of symbologies appears.
- Set the cursor on the asterisk next to DataMatch and press **SELECT**.  
The display shows:  
Select Option:  
\* Append DMatch Msg  
\* Xchange Msg wScan  
\* Verify Only  
Append DMatch Msg – includes Symbology type, encoded data and

---

database match description  
Xchange Msg wScan – includes just database Match description

See "[Reviewing DataMatch Results](#)" on page 7-5 for an explanation of the options.

6. To change the DataMatch option, press ↓ to move the cursor to the asterisk next to the option you want and then press **SELECT** until the database option you want appears.
7. Scan a symbol. If the DataMatch feature is turned on and information about the scanned symbol is in the database, it appears on the display.

## *Reviewing DataMatch Results*

After you scan a symbol, one of the following displays appears, depending on the DataMatch option you selected.

- If you selected `Append DMatch`, the information from the database appears on the first line of the verifier's display. It follows the scan's decode information. If there is no database information, a message to this effect appears.
- If you selected `XChange wScan`, the information from the database appears on the first line of the verifier's display. It replaces the scan's decode information.
- If you selected `Verify Only` and the scanned bar code symbol is contained in the database, the verifier display shows the scan result information depending on the settings you selected. If the scanned bar code symbol is not in the database, the message `DMATCH: BAD(F)` appears on the display.

Under FMT the message `DataMatch:OK` appears if the scanned symbol is in the database.





The Quick Check Series 800 Bar Code Verifier is a high performance, professional tool for verifying the readability and standards compliance of printed bar codes in non-contact mode. The Quick Check 800 Verifier units use a handheld linear imaging bar code reader for simple, convenient aim and shoot operation. The Series 800 verifiers are enhanced versions of Hand Held Products' Series 600 verifiers and are designed to not only provide the user with all the features of the Series 600 models, but also allow the ease of use of a non-contact device for certain verification tasks.

This chapter details where the operation of a Series 800 verifier differs from a Series 600 unit.

### *Using the Quick Check 800 Verifier with a QC3800V Linear Imager*

**WARNING**

**Only** the QC3800V can be used as the non-contact input device with a Series 800 unit. The QC3800V should not be used with any other decoder or terminal.

---

### *General Operation*

Scanning is initiated by depressing the trigger on the QC3800V after the Quick Check 800 Verifier has been turned on. When the unit starts scanning, it emits a single beep.

If the unit cannot decode a bar code after a trigger pull, it emits four beeps and returns to the main display.

After a successful decode, with a result that passes the minimum acceptable grade set point, the unit emits three beeps (one short, two long).

A decode that fails to receive a grade above the minimum requirement set causes the unit to emit five beeps (one short, one long, three short).

The optimum reading orientation for the QC3800V is 6 inches (152.4 mm) with an angle of incidence of 15° from perpendicular. At this orientation, the system performance approximates an average circular aperture size of .006 to .008 inches (.152 to .203 mm). Extreme variations from this orientation may affect the accuracy of some parameter results.

Battery life of the Quick Check 800 Verifier with the QC3800V attached will be shorter than when using the QC Mouse Wand or Pen Wand. To extend battery charge life, use the unit with the charger connected.

---

## ***Reflectance-Based Information***

When connected to a QC3800V, the Main display indicates the Series 800 verifier model, and the bottom line displays:

Linear Imager

Once a successful scan is performed, the Main display shows, for example:

```
C39:ABCD012345678
  Dim --- Fmt      ■ ■ ■
Decod'ty 75% <A>  ■ ■ ■
WN Ratio 2.3 OK!  ■ ■
```

Note that the second line, where the reflectance information would normally be displayed, shows ---, which indicates that the reflectance information is not measured. The reflectance information is measured and displayed when a Mouse Wand or Pen Wand is connected to the Series 800, but not when a QC3800V is used. No reflectance-based values are displayed or printed. This includes Rmin, Rmax, Print Contrast Signal, Symbol Contrast, Edge Contrast Minimum, Modulation, and Defects.

## ***ScanProfile Output***

No ScanProfile Output is available in either the Printer Output modes or the "PROF to PC" mode (as used by QCViewerII software).

## ***Percent Decoded/Scanned Mode***

No Reflectance Calibration is necessary when the QC3800V is connected. When a Mouse Wand or Pen Wand is reconnected, however, the reflectance calibration is necessary.

When using the QC3800V, a special Percent Decoded/Scanned Mode replaces the Reflectometer Mode found on a Series 600 verifier. When the QC3800V is connected, the second level (Print Results) menu changes from:

```
* Print Results
* Calculate "X"
* Reflectometer
* Change Settings
```

---

to:

```
* Print Results
* Calculate "X"
* % Decoded/Scanned
* Change Settings
```

When the new \* % Decoded/Scanned option is selected, this screen appears:

```
Symbol Grade: -----
---% Scans Decoded
---% Scans Passed
Decoded nnn of nnn
```

An example of this completed screen would be:

```
Symbol Grade: A-3.8
100% Scans Decoded
95% Scans Passed
Decoded 20 of 30
```

**Symbol Grade** is the running average grade of the symbol being tested based upon the average of the individual scan grades for the scans decoded within the total run of scans. The individual scan grades are weighted as shown below:

```
A = 4.0
B = 3.0
C = 2.0
D = 1.0
F = 0.0
```

The numeric average mapping to the displayed grade is shown below:

```
3.5 ≤ A ≤ 4.0
2.5 ≤ B ≤ 3.5
1.5 ≤ C ≤ 2.5
0.5 ≤ D ≤ 1.5
0.0 ≤ F ≤ 0.5
```

**% Scans Decoded** is the percent of scans successfully decoded out of the total number of scans that were made.

**% Scans Passed** is the percent of decoded scans that met or exceeded the minimum required ISO/IEC grade set in the unit.

**Decoded** is the total number of scans successfully decoded compared to the total number of scans made. The maximum number of scans that will be made is based on the number of scans set in the \* #Scans/Symbol: line option found in the menu chain:

- 
- \* Change Settings
  - \* Test Criteria
  - \* #Scans/Symbol: nnn

Since the Scan Profile output capability does not exist with the QC3800V connected, the Printer Output screen also changes. The program sequence for that display is:

- \* Change Settings
- \* Output Options
- \* Printout Options

<ul style="list-style-type: none"><li>* Printer Type: HSP</li><li>* Printout: Long</li><li>* AutoPrint/Stor On</li></ul>
--

## Error, Application, and Type Messages

Type	Display Message	Printout Message
GENERAL	BAD # System	BAD Number System
	BAD 2nd Chek	BAD 2nd Check Chr
	BAD Addm Chk	BAD Addendum Check
	BAD AlphaNum	BAD AlphanumericField
	BAD Char Seq	BAD Char Sequence
	BAD CheckChr	BAD Symbol Check Chr or Check Charctr Fails BAD or ModCheck Fails BAD
	BAD CtrGuard	BAD Center Guard Patrn
	BAD LH Guard	BAD Left Guard Pattern
	BAD Msg Chek	BAD Message Check
	BAD Numbers	BAD Numeric Field
	BAD RH Guard	BAD Right Guard Patrn
	BAD Separatr	BAD Separator
	BAD User Chk	BAD User Check Chr
	ILLEGAL Chr	ILLEGAL Character
	MISSING S/S	MISSING Start/Stop
	No Check Charctr	No Check Character
	OK Check Chr	Check Charctr Passes OK! or ModCheck Passes OK!
	SHORT LH Q-Z	BAD Left Quiet Zone
	SHORT RH Q-Z	BAD Right Quiet Zone
	UNRECOGNIZED	UNRECOGNIZED symbol- ogy
	WIDE I-C Gap	WIDE I-C Gaps
	% Mag Factor	U.P.C.:(or EAN:) xxx% Mag Factor

Type	Display Message	Printout Message
DATABASE	Match	Match
	NOT in DBase	NOT in Database
ABCD	AdvShipmnt	Adv Shipmnt Notice
	Authoriz #	Authorization #
	BAD ID Char.	BAD ID Character
	BAD UnitMeas	BAD Unit of Measure
	Bookland	Bookland
	DestPostCd	Dest. Postal code
	EAN ITF-14	EAN ITF-14
	EAN-13	EAN-13
	Package ID	Package ID
	Product ID	Product ID
	PurOrder #	Purchase Order #
	Qty/UofMes	Quantity/UofMeas
	SupID/Prt#	Supl ID / Part #
	SupID/Ser#	Supl ID / Serial#
	Supplier ID	ID Code (Supl)
	UCC/EAN128	UCC/EAN-128
	UPC-A	UPC-A
AIAG	Actual Wgt	Actual Weight
	BAD ID Char	BAD ID Character
	BAD Source	BAD Source Code
	BAD Trace Fd	BAD Trace Field
	Container	Container Type
	Cust Part #	Part # (Cust)
	CustmrDefn	Customer Defined
	CustOrder#	Order # (Cust)
	CustProdID	Product ID (Cust)
	CustTrace#	Trace # (Cust)

<b>Type</b>	<b>Display Message</b>	<b>Printout Message</b>
	ECV /VCVS	ECV /VCVS
	Emissn Test	Emissions Test
	Employee#	Employee Pass ID
	EngrChgLv1	Engr change Level
	Gross Amt.	Gross Amount
	HeatProcss	Heat/Process #
	Internal	Internal Only!
	Len /Weight	Length/theor.Wgt
	MastrSerl#	Serial # (Master)
	MixedSerl#	Serial # (MixedLd)
	Net Amount	Net Amount
	NO Separator	Missing Separator
	Part# cont	Part# (cont)
	Quantity	Quantity
	ReturnCode	Return Code
	Serl#(Itm)	Serial # (Item)
	Serl#Pkg	Serail # (Pack)
	Stock Locn	Stocking Location
	Supl Part#	Part# (Supl)
	Supl&Part#	Supplier .Part #
	SuplOrder#	Order # (Supl)
	SuplTrace#	Trace# (Supl)
	Suppl Defn	Supplier Defined
	Suppl (Cus)	Supplier (Cust)
	Suppl (Sup)	Supplier (Supl)
	Trans Defn	Transport Defined
	UnlistedID	Unlisted ID Char
	UofMeasure	Unit of Measure
	"VIN" #	Vehicle ID Number

Type	Display Message	Printout Message
BOOKLAND	Andorra	Andorra
	Argentna	Argentina
	BAD Publish #	BAD Publisher #
	Bangldsh	Bangladesh
	Botswana	Botswana
	Brazil	Brazil
	Bulgaria	Bulgaria
	Caribben	Caribbean
	Chile	Chile
	China	China
	Colombia	Colombia
	CostaRic	Costa Rica
	Croatia	Croatia
	Cuba	Cuba
	Cyprus	Cyprus
	Czechlov	Czechoslovakia
	Denmark	Denmark
	Egypt	Egypt
	EnglSpkg	English Speaking
	Equador	Equador
	Finland	Finland
	FrenSpkg	French Speaking
	Gambia	Gambia
	GermSpkg	German Speaking
	Ghana	Ghana
	Greece	Greece
	HongKong	Hong Kong
	Hungary	Hungary
	Iceland	Iceland



---

<b>Type</b>	<b>Display Message</b>	<b>Printout Message</b>
	India	India
	Indonesia	Indonesia
	Israel	Israel
	Italy	Italy
	Japan	Japan
	Kenya	Kenya
	Korea	Korea
	Lesotho	Lesotho
	Malawi	Malawi
	Malaysia	Malaysia
	Maldives	Maldives
	Malta	Malta
	Mauritis	Mauritius
	Mexico	Mexico
	Morocco	Morocco
	N.Antils	Neth.Antilles
	Namibia	Namibia
	Netherld	Netherlands
	Message on Display	Message on Printout
	Nigeria	Nigeria
	Norway	Norway
	NOT Bookland	NOT Bookland
	Pakistan	Pakistan
	PapNGuna	Papua N.Guinea
	Philppns	Philippines
	Poland	Poland
	Romania	Romania
	RussSpkg	Russian Speaking
	S.Pacific	S.Pacific

Type	Display Message	Printout Message
	Singapore	Singapore
	Slovinia	Slovinia
	Spain	Spain
	SriLanka	Sri Lanka
	Suriname	Suriname
	Sweden	Sweden
	Taiwan	Taiwan
	Tanzania	Tanznaia
	Thailand	Thailand
	Tunesia	Tunesia
	Turkey	Turkey
	Unesco	Unesco
	Uruguay	Uruguay
	Venezuela	Venezuela
	Yugoslav	Yugoslavia
	Zambia	Zambia
CCBBA	Attribute	Attribute
	Autol Use	AutologusUse Only
	BAD CtrlCode	BAD Control Code
	BAD GroupCod	BAD Grouping Code
	Biohazard	Biohazard
	BloodProd	Blood Product
	Dir Donor	Directed Donor
	Donation#	Donation #
	EmergyUse	Emergency Use Only
	ExpirDate	Expiration Date
	FDA Reg#	FDA Regis. #
	GroupLbl	Grouping Label
	Hold!	Hold for procsng

Type	Display Message	Printout Message
	Hospital#	Hospital #
	Irradiatd	Irradiated
	NegAntCMV	Neg for Anti-CMV
	NotTransf	Not For Transfn
	Obsolete Fmt	Obsolete Format
	PatientID	Pat ID (Blood Bg)
	PatientID	Pat ID (Sample)
	PatientID	Pat ID (Wrist)
	PersonIID	Personnel ID#
	PrimryBag	Primary Col Bag
	ThPhlebty	Frm TherPhlebtry
	TrnsfrBag	Transfer Bag
	Type A	Blood Type A
	Type A+	Blood Type A+
	Type A-	Blood Type A-
	Type AB	Blood Type AB
	Type AB+	Blood Type AB+
	Type AB-	Blood Type AB-
	Type B	Blood Type B
	Type B+	Blood Type B+
	Type B-	Blood Type B-
	Type O	Blood Type O
	Type O+	Blood Type O+
	Type O-	Blood Type O-
HIBCC	Alternat*	Alternate*
	Alternate	Alternate
	AltSecndry	Alter.Secondary
	BAD # System	BAD # System
	BAD Date	BAD Date

Type	Display Message	Printout Message
	BAD Descriptr	BAD Descriptor
	BAD Flags	BAD Flags
	BAD Indus.ID	BAD Industry ID
	BAD Quantity	BAD Quantity
	BAD UnitMeas	BAD Unit of Measure
	(EAN ITF)	(SCS /ITF)
	Prim/Sec*	Primary/Secondary*
	Prim/Secd	Primary/Secondary
	Primary	Primary
	Primary*	Primary*
	Provider	Provider
	Provider*	Provider*
	Secondary	Secondary
	Secondry*	Secondary*
	(UPC/EAN)	(UPC/EAN)
	Messages with an asterisk (*) indicate the symbol was created in Code 128.	
LOGMARS	LOGMARS:-OK!	LOGMARS:-OK!
SISAC	BAD Descripter	BAD Descriptor
	BAD ISSN	BAD "ISSN"
	BAD Version#	BAD Version #
	Ver 1 '92	Ver "1" (1992)
	Ver O '87	Ver "O" (1987)
UCC/EAN-ITF	BAD LogVarnt	BAD Logis. Variant
	BAD Prefix	BAD Prefix
	FixdCon	Fixed Content
	ITF-14	ITF-14
	ITF-16	ITF-16

Type	Display Message	Printout Message
	Suffix	Suffix
	VariCon	Variable Count
	Volume	Volume
	Width	Width
UCC/EAN-128	Area	Area
	BAD Appl.ID	BAD Appli.ID
	BAD Data Chk	BAD Data Checksum
	BAD Start CD	BAD Start Code
	Batch #	Batch #
	Bill To	Bill To
	Buy From	Buy From
	Cell.ESN	Cellular ESN
	Depth	Depth
	EAN SCS	EAN SCS
	FreeText	Free Text
	GrossVol	Gross Volume
	GrossWgt	Gross Weight
	HIBCC AS	HIBCC Alt Sec
	Internal	Internal
	Length	Length
	LONG Field	LONG Field
	Lot #	Lot #
	Max Date	Max Durable Date
	Min Date	Min Durable Date
	Multiple	Multiple
	Net Wgt.	Net Weight
	P.O. #	P.O.#
	Pkg Date	Package Date
	Prod Var	Product Variant

---

<b>Type</b>	<b>Display Message</b>	<b>Printout Message</b>
	ProdDate	Production Date
	Quantity	Quantity
	RollProd	Roll Product
	Serial#	Serial #
	Ship To	Ship To
	SHORT Field	SHORT Field
	Symbol LONG!	Symbol Too Long
	UCC Serl	UCC Serial SCS
	SHORT Field	SHORT Field
	Symbol LONG!	Symbol Too Long
	UCC Serl	UCC Serial SCS
	Volume	Volume
	Width	Width

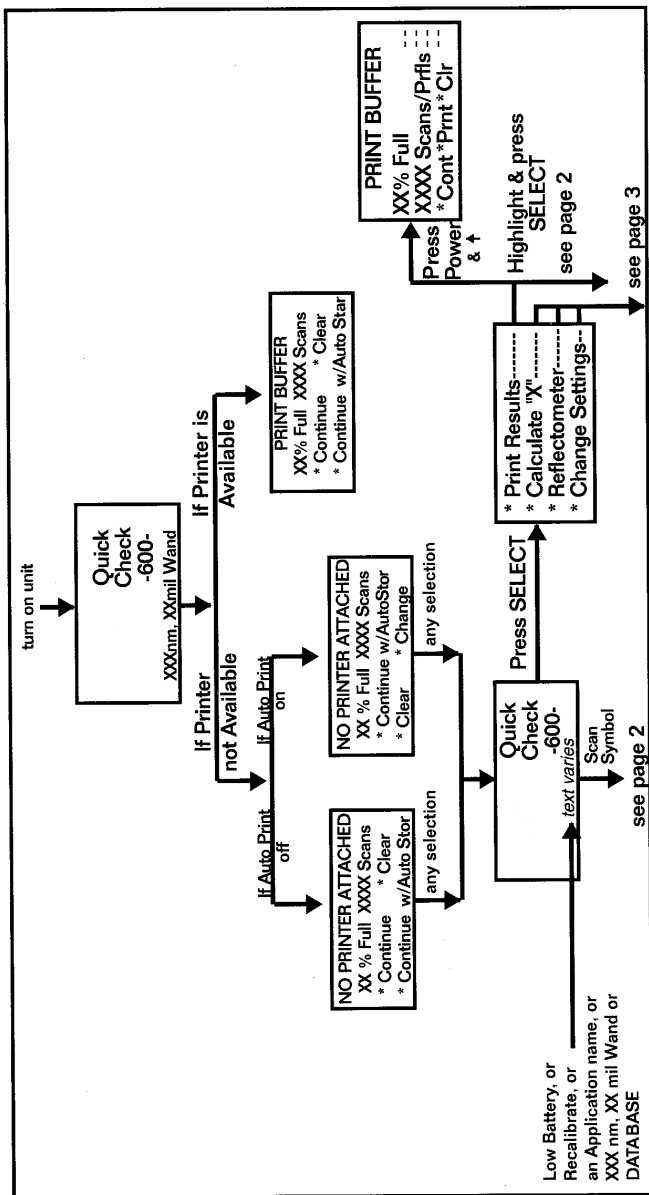

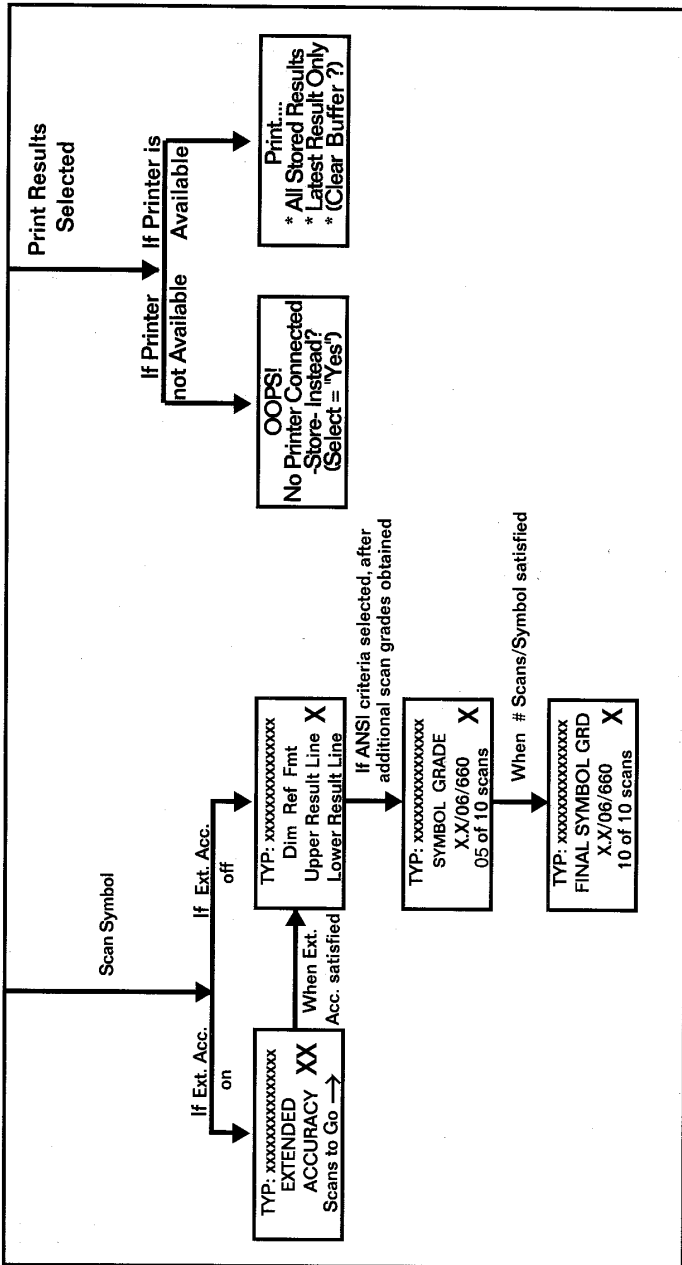



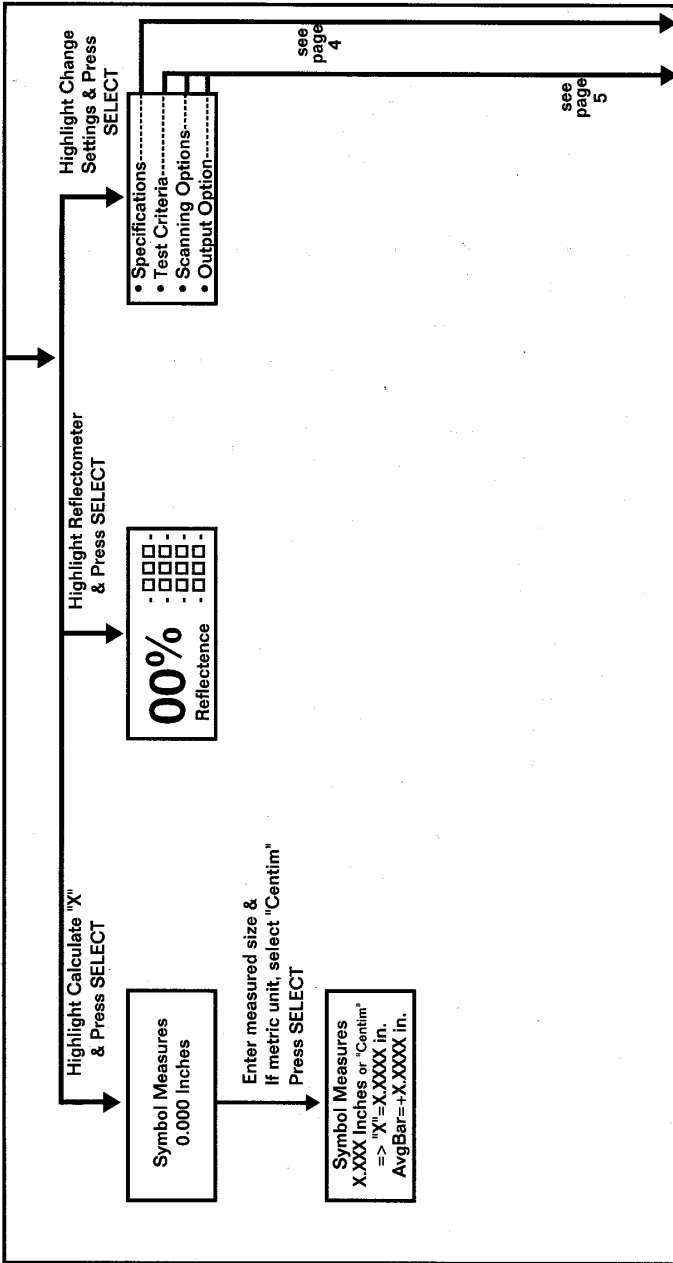

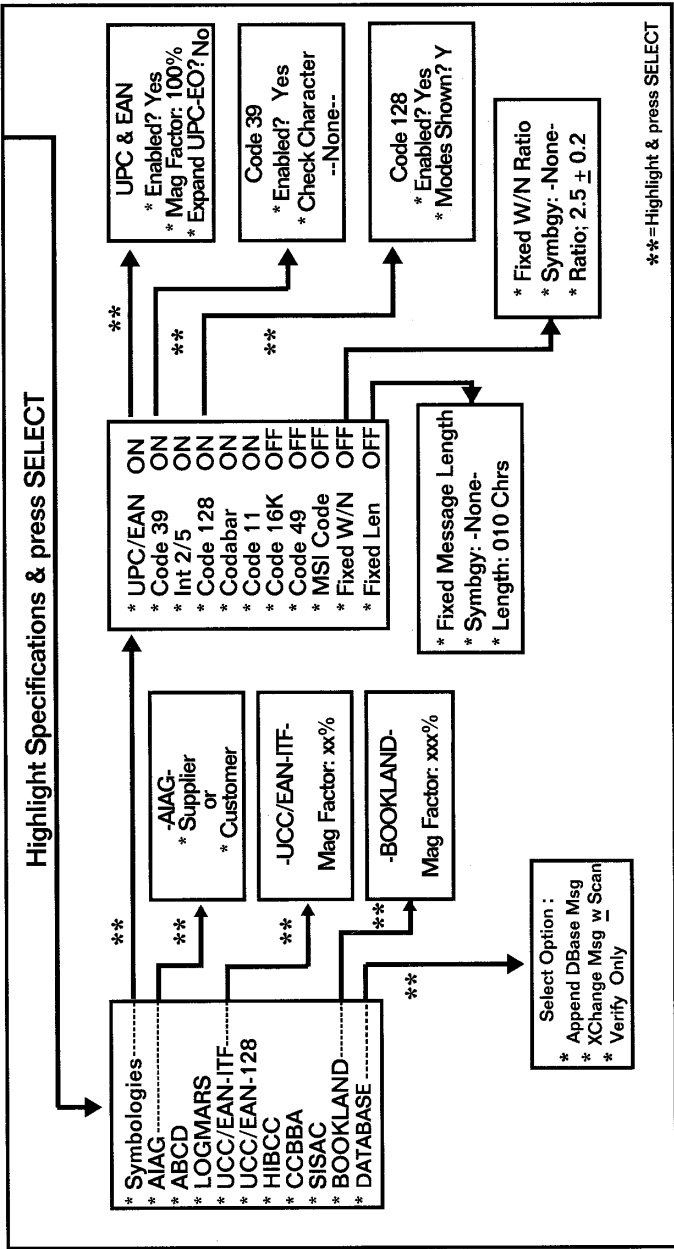

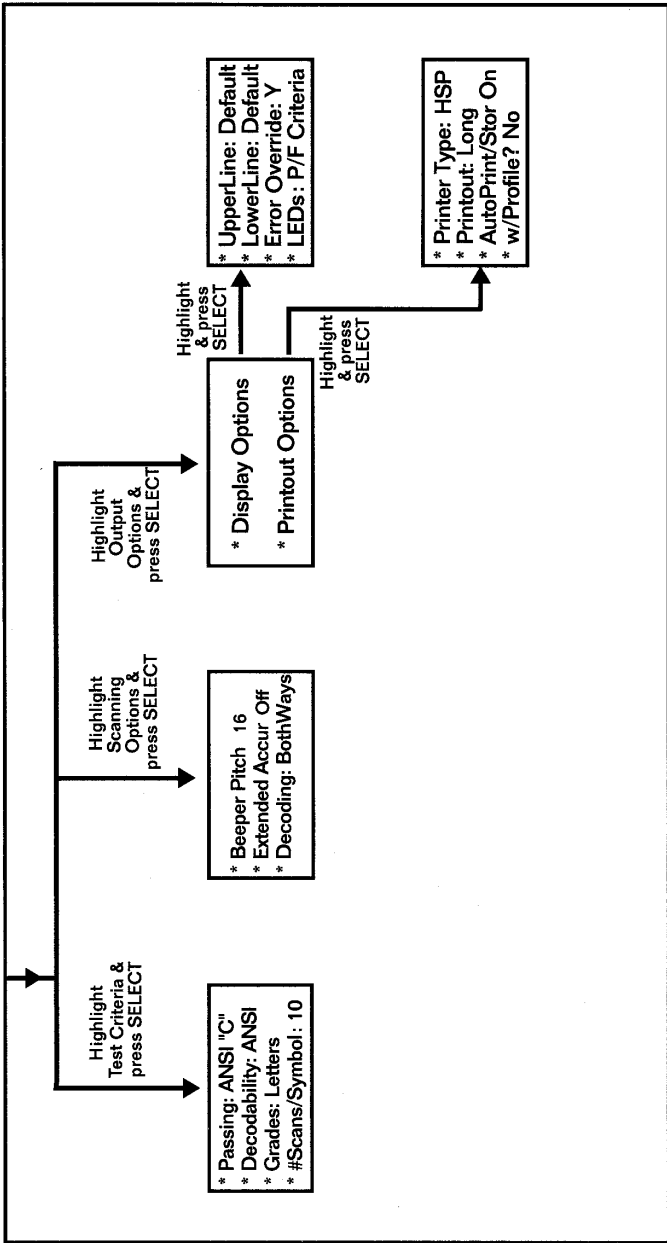



## Single-Scan-to-Result Codes (SSTR)

## Parameter SSTR Codes



Average Bar Error



W/N Ratio



Decodability



R(L):R(d)



P.C.S.



Symbol Contrast



Rmin/Rmax



Modulation



EC (min)



Defects



Symbol Type



Message Length

## Custom SSTR Codes



Default



Install Upper Line



Install Lower Line



Save Settings



## Special Codes

On Demand Lock  
  
 Specs & Tests

Command Code -  
  
 (Locked)

Command Code +  
  
 (Locked)

Factory Default  
  
 Reset All Options

On Demand Unlock  
  
 Specs & Tests

Command Code -  
  
 (Unlocked)

Command Code +  
  
 (Unlocked)





### *Unrecognized Symbols*

You can use the “Unrecognized symbology” feature to analyze certain characteristics of bar code symbols that would otherwise be “unreadable” by a bar code scanning system.

If the unit cannot decode a symbol, verify that the symbology type you are attempting to read has not been turned off (disabled) in the Settings/Codes menu. If the unit cannot decode the symbol and the symbology is turned on, use the “Unrecognizable symbology” feature. To activate this feature, scan the Control Code Below. To deactivate this feature, scan this code again.

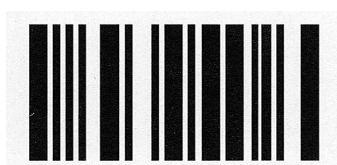

### *Notes:*

1. The “Unrecognizable symbology” feature is volatile. Turning the unit off and then on will also deactivate this feature.
2. When the “Unrecognizable symbology” feature is activated, the Quick Check 600/800 Verifier will attempt to analyze any group of 13 elements (7 bars) or more with the exception of SSTR Codes, Special Codes, Control Codes and Command Codes. Any printed pattern, including a partial scan of an otherwise “good” symbol may trigger analysis of a pattern, whether it is a readable symbol or not.
3. The “Unrecognized” report may display questionable scan results due to the loss of decode and symbol character structure information. Therefore, you should use extra care when analyzing results identified as “Unrecognized.”



## Troubleshooting

Check the version of the software installed in your Quick Check 600/800 Verifier if you need to contact us for technical assistance. The software version is defined by the check sum and letter.

### ◆ To check the software version:

1. Display the menu that begins with Print Results.
2. Press **POWER**.
3. The unit emits four quick beeps and displays the opening screen.
4. Press →.
5. The check sum and version letter appear. Write down this information and then contact Hand Held Products for assistance. (See "[Technical Assistance](#)" on page 14-1.)

In rare instances, the Quick Check 600/800 Verifier display may freeze; that is, nothing appears on the display when you turn on the unit. You can reset the unit and restore the display as described below.

### ◆ To restore the display:

1. Press and hold **POWER** down for about 60 seconds.
2. The display should clear.
3. Press **POWER** to turn the unit on.
4. If the unit does not respond, replace the batteries with fresh ones, and then turn on the unit. The display should reappear. If it does not, contact Hand Held Products. (See "[Technical Assistance](#)" on page 14-1.)

*Note:* After removing the batteries, you will need to recalibrate the unit as described in "[Calibrating the Quick Check 600/800 Verifier](#)" on page 1-12.

## Technical Assistance

If you need assistance installing or troubleshooting your imager, please call your Distributor or the nearest Hand Held Products technical support office:

### North America/Canada

Telephone: (800) 782-4263  
(8 a.m. to 6 p.m. EST)  
Fax number: (315) 554-6705  
E-mail: [natechsupport@handheld.com](mailto:natechsupport@handheld.com)

---

**Latin America**

Telephone: (803) 835-8000  
Telephone: (800) 782-4263  
E-mail: [ltechsupport@handheld.com](mailto:ltechsupport@handheld.com)

**Brazil**

Telephone: +55 (21) 2178-0500  
Fax: +55 (21) 2178-0505  
E-mail: [brsuporte@handheld.com](mailto:brsuporte@handheld.com)

**Mexico**

Telephone: (803) 835-8000  
E-mail: [ltechsupport@handheld.com](mailto:ltechsupport@handheld.com)

**Europe, Middle East, and Africa**

Telephone: +31 (0) 40 7999 393  
Fax: +31 (0) 40 2425 672  
E-mail: [eurosupport@handheld.com](mailto:eurosupport@handheld.com)

**Asia Pacific**

Telephone - Hong Kong: +852-3188-3485 or 2511-3050  
Telephone - China: +86 21 6361 3818  
E-mail: [aptechtupport@handheld.com](mailto:aptechtupport@handheld.com)

**Japan**

Telephone: +813 5770-6312  
E-mail: [aptechtupport@handheld.com](mailto:aptechtupport@handheld.com)

**Malaysia**

Telephone: +603-6201-7020  
E-mail: [aptechtupport@handheld.com](mailto:aptechtupport@handheld.com)

***Online Technical Assistance***

You can also access technical assistance online at [www.handheld.com](http://www.handheld.com).

***For Further Information***

To download the full User's Guide for these products, visit our website at [www.handheld.com](http://www.handheld.com).

***Product Service and Repair***

Hand Held Products provides service for all its products through service centers throughout the world. To obtain warranty or non-warranty service, return the unit to Hand Held Products (postage paid) with a copy of the dated purchase record attached. Contact the appropriate location below to obtain a Return Material Authorization number (RMA #) before returning the product.

**North America**

Telephone: (800) 782-4263  
Fax: (803) 835-8012  
E-mail: [naservice@handheld.com](mailto:naservice@handheld.com)

**Latin America**

Telephone: (803) 835-8000  
Telephone: (800) 782-4263  
Fax: (239) 263-9689  
E-mail: [laservice@handheld.com](mailto:laservice@handheld.com)

---

**Brazil**

Telephone: +55 (21) 2178-0500  
Fax: +55 (21) 2178-0505  
E-mail: [brservice@handheld.com](mailto:brservice@handheld.com)

**Mexico**

Telephone: +52 (55) 5203-2100  
Fax: +52 (55) 5531-3672  
E-mail: [mxservice@handheld.com](mailto:mxservice@handheld.com)

**Europe, Middle East, and Africa**

Telephone: +31 (0) 40 2901 633  
Fax: +31 (0) 40 2901 631  
E-mail: [euservice@handheld.com](mailto:euservice@handheld.com)

**Asia Pacific**

Telephone: +852-2511-3050  
Fax: +852-2511-3557  
E-mail: [apservice@handheld.com](mailto:apservice@handheld.com)

**Japan**

Telephone: +813-5770-6312  
Fax: +813-5770-6313  
E-mail: [apservice@handheld.com](mailto:apservice@handheld.com)

### *Online Product Service and Repair Assistance*

You can also access product service and repair assistance online at [www.handheld.com](http://www.handheld.com).

### *Limited Warranty*

Hand Held Products, Inc. ("Hand Held Products") warrants its products to be free from defects in materials and workmanship and to conform to Hand Held Products' published specifications applicable to the products purchased at the time of shipment. This warranty does not cover any Hand Held Products product which is (i) improperly installed or used; (ii) damaged by accident or negligence, including failure to follow the proper maintenance, service, and cleaning schedule; or (iii) damaged as a result of (A) modification or alteration by the purchaser or other party, (B) excessive voltage or current supplied to or drawn from the interface connections, (C) static electricity or electro-static discharge, (D) operation under conditions beyond the specified operating parameters, or (E) repair or service of the product by anyone other than Hand Held Products or its authorized representatives.

This warranty shall extend from the time of shipment for the duration published by Hand Held Products for the product at the time of purchase ("Warranty Period"). Any defective product must be returned (at purchaser's expense) during the Warranty Period to Hand Held Products' factory or authorized service center for inspection. No product will be accepted by Hand Held Products without a Return Materials Authorization, which may be obtained by contacting Hand Held Products. In the event that the product is returned to Hand Held Products or its authorized service center within the Warranty Period and Hand

---

Hand Held Products determines to its satisfaction that the product is defective due to defects in materials or workmanship, Hand Held Products, at its sole option, will either repair or replace the product without charge, except for return shipping to Hand Held Products.

EXCEPT AS MAY BE OTHERWISE PROVIDED BY APPLICABLE LAW, THE FOREGOING WARRANTY IS IN LIEU OF ALL OTHER COVENANTS OR WARRANTIES, EITHER EXPRESSED OR IMPLIED, ORAL OR WRITTEN, INCLUDING, WITHOUT LIMITATION, ANY IMPLIED WARRANTIES OF MERCHANTABILITY OR FITNESS FOR A PARTICULAR PURPOSE.

HAND HELD PRODUCTS' RESPONSIBILITY AND PURCHASER'S EXCLUSIVE REMEDY UNDER THIS WARRANTY IS LIMITED TO THE REPAIR OR REPLACEMENT OF THE DEFECTIVE PRODUCT. IN NO EVENT SHALL HAND HELD PRODUCTS BE LIABLE FOR INDIRECT, INCIDENTAL, OR CONSEQUENTIAL DAMAGES, AND, IN NO EVENT, SHALL ANY LIABILITY OF HAND HELD PRODUCTS ARISING IN CONNECTION WITH ANY PRODUCT SOLD HEREUNDER (WHETHER SUCH LIABILITY ARISES FROM A CLAIM BASED ON CONTRACT, WARRANTY, TORT, OR OTHERWISE) EXCEED THE ACTUAL AMOUNT PAID TO HAND HELD PRODUCTS FOR THE PRODUCT. THESE LIMITATIONS ON LIABILITY SHALL REMAIN IN FULL FORCE AND EFFECT EVEN WHEN HAND HELD PRODUCTS MAY HAVE BEEN ADVISED OF THE POSSIBILITY OF SUCH INJURIES, LOSSES, OR DAMAGES. SOME STATES, PROVINCES, OR COUNTRIES DO NOT ALLOW THE EXCLUSION OR LIMITATIONS OF INCIDENTAL OR CONSEQUENTIAL DAMAGES, SO THE ABOVE LIMITATION OR EXCLUSION MAY NOT APPLY TO YOU.

All provisions of this Limited Warranty are separate and severable, which means that if any provision is held invalid and unenforceable, such determination shall not affect the validity of enforceability of the other provisions hereof. Use of any peripherals not manufactured/sold by Hand Held Products voids the warranty. This includes but is not limited to: cables, power supplies, cradles, and docking stations. Hand Held Products, Inc. extends these warranties only to the first end-users of the products. These warranties are nontransferable.

The limited duration of the warranty for the Quick Check 600/800 Verifier is for two (2) years.



**Hand Held Products, Inc.**

700 Visions Drive

P.O. Box 208

Skaneateles Falls, NY 13153-0208