



User's Guide

All rights reserved. No part of this work may be reproduced, transmitted, or stored in any form or by any means without prior written consent, except by a reviewer, who may quote brief passages in a review, or as provided for in the Copyright Act of 1976.

Percon[®] is a registered trademark of Percon Incorporated. Falcon[™] is a trademark of Percon Incorporated.

Datalight[®] is a registered trademark of Datalight, Inc., and ROM-DOS[™] is a trademark of Datalight, Inc.

PhoenixCARD Manager Plus ©1993, 1994 Phoenix Technologies Ltd.

Windows[®] is a registered trademark of Microsoft Corporation.

Many of the designations used by manufacturers and sellers to distinguish their products are claimed as trademarks. Where these designations appear here and the authors were aware of a trademark claim, the designations have been printed with a trademark ([™]) symbol.

The information contained in this document is subject to change without notice.

About This Book

This book provides information about Falcon DOS portable data terminals for first-time users. Its focus is:

- initial use of the Falcon,
- entering data from the keypad and from bar codes, and
- utilizing the Falcon Dock and 4-Slot Dock.

For additional information about Falcon DOS portable terminals, including instructions on transferring files from a Falcon to a PC, see the *Falcon DOS Portable Terminals Advanced User's Guide*.

NOTE: When used in this book, the word "Falcon" generally refers to any or all of the DOS portable models identified on page 2. Where information applies to specific models, those models are clearly identified by their model number in the side column or in the text

310
315

320
325

330
335

Product Labeling and Safety Information

310
315
320
325

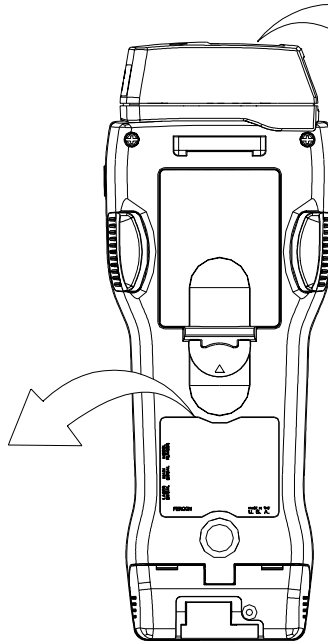



AVOID EXPOSURE - LASER LIGHT IS EMITTED FROM THIS APERTURE.
EVITER TOUTE EXPOSITION - LUMIERE LASER EMIS PAR CETTE OUVERTURE.

LASER LIGHT - DO NOT STARE INTO BEAM CLASS 2 LASER PRODUCT.
LUMIERE LASER - NE PAS REGARDER DANS LE FAISCEAU. APPAREIL A LASER DE CLASSE 2.
LASERSTRAHL - NICHT IN DEN STRAHL BLICKEN. LASERPRODUKT DER KLASSE 2.

1mw - 680nm - 100sec. IEC 825 - 1 : 1993 / EN60825 - 1 : 1994

330
335

AVOID EXPOSURE
LASER LIGHT IS EMITTED
FROM THIS APERTURE

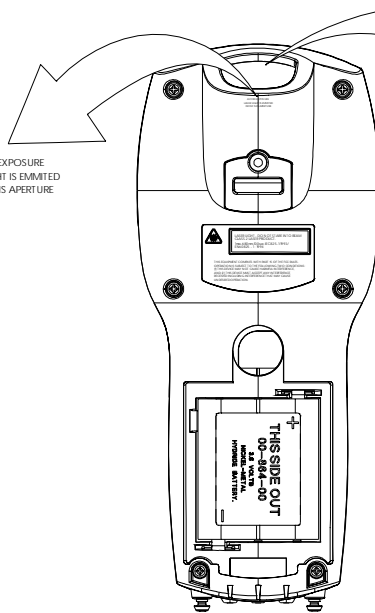



LASER LIGHT - DO NOT STARE INTO BEAM CLASS 2 LASER PRODUCT.
1mw-680nm 100sec. IEC 825-1:1993/ EN60825 - 1: 1994

THIS EQUIPMENT COMPLIES WITH PART 15 OF THE FCC RULES. OPERATION IS SUBJECT TO THE FOLLOWING TWO CONDITIONS:
(1) THIS DEVICE MAY NOT CAUSE HARMFUL INTERFERENCE, AND (2) THIS DEVICE MUST ACCEPT ANY INTERFERENCE RECEIVED INCLUDING INTERFERENCE THAT MAY CAUSE UNDESIRED OPERATION.

**Advisory
Statement**

CAUTION: Use of controls, adjustments, or performance of procedures other than those specified herein may result in hazardous visible or invisible laser light exposure.

FCC Information

This device complies with Part 15 of the FCC Rules. Operation is subject to the following two conditions: (1) this device may not cause harmful interference, and (2) this device must accept any interference received, including interference that may cause undesired operation.



Contents

<i>About This Book</i>	iii
<i>Getting Help</i>	iii
<i>Product Labeling and Safety Information</i>	iv

Chapter One:

<i>About Falcon DOS Terminals</i>	1
Overview	2
Model Numbers	2
Optional Accessories	2
Falcon Dock	2
Falcon 4-Slot Dock	3
Portable Battery Charger	3
Care and Cleaning	3

Chapter Two:

<i>Using the Falcon</i>	5
Turning the Unit On and Off	6
First-Time Use	6
“Please Wait” Messages	6
Batteries	7
Low-Battery Warning	7
Replacing the Batteries	7
Auto-Shutoff	10
The Keypad	10
Input Modes	14
Double Action Key Mode	16
Cursors and Icons	17
International Characters	18

Contents

Repeating Keystrokes	20
The Viewport.	21
Moving the Viewport Display	21
Adjusting the Contrast	23
Using the Backlight	24
The Falcon Laser	24
The Laser Triggers	25
Changing the Laser Module's Orientation.	25
Using the Long-Range Laser	26
Attaching a Bar Code Reader.	27
The Serial Port.	28
The Falcon Applications.	29

Chapter Three:

<i>The Falcon Dock</i>	31
About the Falcon Dock	32
Attaching the Falcon Dock to the Computer	33
The Power Adapter	33
Using the Falcon Dock.	34
Maintenance	35

Chapter Four:

<i>The Falcon 4-Slot Dock</i>	37
About the Falcon 4-Slot Dock	38
Front Panel	38
Back Panel.	39
Installation	40
Power Adapter	40
Cables.	40
Connecting the Dock to the Host	40
Creating a Dock Network	41
Using the 4-Slot Dock	41
Charging a Falcon's Batteries	41
Transferring Data	41
<i>Index</i>	43

>> Chapter One

About Falcon DOS Terminals

This chapter provides an overview of the Falcon line of DOS portable terminals. It identifies the various model configurations and accessories and describes some of the features of the Falcon models.

CHAPTER CONTENTS

<i>Overview</i>	<2>
<i>Model Numbers</i>	<2>
<i>Optional Accessories</i>	<2>
<i>Falcon Dock</i>	
<i>Falcon 4-Slot Dock</i>	
<i>Portable Battery Charger</i>	
<i>Care and Cleaning</i>	<3>

>> Overview

Falcon DOS portable data terminals are handheld computers designed for data collection. The Falcon DOS portable line includes 8-line and 16-line models.

Some Falcons have integrated laser scanners, making them high-performance bar code readers as well. Models without integrated lasers accept input from most industry-standard bar code readers.

Both the 8-line and the 16-line Falcon models are available in batch and wireless (radio frequency, or RF) configurations. Wireless models provide instant communication of data between the unit and a host computer.

>> Model Numbers

Table [1-1](#) lists the model numbers of the Falcon DOS portables and describes their configurations.

Table 1-1: Falcon Models

Model Number	8-Line	16-Line	Batch	RF
310	X		X	
315	X			X
320		X	X	
325		X		X
330		X	X	
335		X		X

>> Optional Accessories

Falcon Dock



The Falcon Dock is the docking station for the Falcon. It's two primary uses are:

- Recharging the Falcon's NiCD or NiMH battery pack.
- Providing a connection for serial communications between the Falcon and the host computer.

Review chapter [3](#) for more information about the Falcon Dock.

330
335

The Dock for the Falcon **330** and **335** uses a dual IR/hardwire interface to provide nearly transparent full duplex serial communications between the Falcon **330** and **335** and the host computer. For additional information, on communication limitations, review the Falcon DOS Portable Terminals **Advanced User's Guide**.

Falcon 4-Slot Dock

The Falcon 4-Slot Dock provides battery recharging and serial communications for up to four Falcon portables at a time.

Review chapter [4](#) for more information about the Falcon 4-Slot Dock.

NOTE: *There is no 4-slot dock for the Falcon **330** and **335**.*

Portable Battery Charger

When not using a Falcon Dock or a Falcon 4-Slot Dock, the optional portable battery charger can be used to recharge the Falcon's batteries. Rechargeable batteries that have lost all power can be fully recharged in about 2 hours.

NOTE: *To purchase accessories, or for additional information, contact a Percon representative, or visit the Percon Web site at www.percon.com.*

>> Care and Cleaning

With normal use, the Falcon DOS portable terminal requires no maintenance. If it gets dirty, wipe it with a damp cloth.

- Do not immerse the Falcon in liquid.
- Do not use any abrasive cleaners on the display screen.

>> Chapter Two

Using the Falcon

The Falcon is an enhanced DOS computer that provides the user unique functionality and flexibility. The Falcon unit can contain one or more specialized applications that collect bar code data or other information. This chapter will demonstrate how easy it is to use the Falcon.

Finding Out More: For more information (including instructions on transferring files to and from a Falcon), see the Falcon DOS Portable Terminals **Advanced User's Guide**.

CHAPTER CONTENTS

<i>Turning the Unit On and Off</i>	<6>
<i>First-Time Use</i>	
<i>"Please Wait" Messages</i>	
<i>Batteries</i>	<7>
<i>Low-Battery Warning</i>	
<i>Replacing the Batteries</i>	
<i>Auto-Shutoff</i>	
<i>The Keypad</i>	<10>
<i>Input Modes</i>	
<i>Double Action Key Mode</i>	
<i>Cursors and Icons</i>	
<i>International Characters</i>	
<i>Repeating Keystrokes</i>	
<i>The Viewport</i>	<21>
<i>Moving the Viewport Display</i>	
<i>Adjusting the Contrast</i>	
<i>Using the Backlight</i>	
<i>The Falcon Laser</i>	<24>
<i>The Laser Triggers</i>	
<i>Changing the Laser Module's Orientation</i>	
<i>Using the Long-Range Laser</i>	
<i>Attaching a Bar Code Reader</i>	<27>
<i>The Serial Port</i>	<28>
<i>The Falcon Applications</i>	<29>

>> Turning the Unit On and Off



Press the **Power** key to turn the unit on or off.

- The Power key for the Falcon 31x-32x is located at the top left of the keypad matrix.
- The Power key for the Falcon 33x is located at the bottom left of the keypad matrix.

First-Time Use

The first time the Falcon unit is turned on, the following message may be seen:

```
Initial power-up or  
critical data loss.  
Drive D formatted.  
Press any key...
```

This message appears with normal operation and does *not* indicate a problem. Press the **ENTER** key, and the Falcon will continue to boot up.

NOTE: *This message will also appear when new or recharged batteries are placed in the unit after the backup battery has been drained.*

“Please Wait” Messages

Depending upon the type of PC card installed, the Falcon will perform the various operations placed on the card.

- During these operations, the unit will display a message in reverse video indicating that it is powering on or off.
- When turning the unit on, wait until the message disappears before using the unit.
- When turning the unit off, to replace the batteries, wait until the message disappears before removing the batteries.

>> Batteries

Falcon batteries are available in rechargeable, easy-to-replace nickel cadmium (NiCD) or nickel metal-hydride (NiMH) battery packs.

- The Falcon **310** and **315** can use three standard AA alkaline batteries, NiCD, or NiMH battery packs.
- For models **320** and **325**, only NiMH battery packs are recommended.
- For the Falcon **330** and **335**, NiMH battery packs are recommended. Individual alkaline batteries are not compatible with these models.

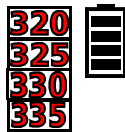

The Falcon also has a built-in lithium backup battery that temporarily saves data when the replaceable batteries lose their charge.

***NOTE:** A battery icon, shown at the left, is displayed at the top right corner of the viewport when the Falcon **320**, **325**, **330**, and **335** are running with a charged battery.*

Low-Battery Warning

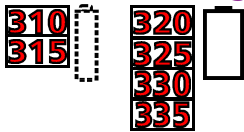

When the batteries have lost most of their charge, an icon of an “empty” battery appears at the top right corner of the Falcon screen. (See the icons at left.)

- The Falcon also can be programmed to emit a beep at intervals when the battery is low.
- The backup battery will protect all data in memory while the other batteries are out of the unit.

After recharging or replacing the batteries and turning the Falcon back on, the unit will return to the application operating when it was turned off.

Replacing the Batteries

When the empty-battery icon appears or the warning beep is heard, turn off the Falcon and recharge or replace the batteries as soon as possible. **Turn the Falcon off** before changing the batteries. Removing batteries while the unit is on can trigger a number of problems, including loss of stored data.

The Falcon’s batteries (except for the lithium backup battery) are located in a compartment on the back of the unit (see figure [2-1](#)). To replace the batteries, complete the following steps:

310
315
320
325

For Falcon models **310**, **315**, **320**, and **325**:

1. Turn the Falcon off.
2. Detach the elastic hand strap on the back of the Falcon by pulling its hook out of the holder near the base.
3. The battery-compartment cover has a tab located in the middle of the unit. Firmly press the tab up until the cover is released from the body of the unit. (A symbol on the body indicates the direction in which to press the tab.)
4. Pull the end of the exposed plastic ribbon in the battery compartment until the batteries pop out.

Figure 2-1: NiCD Battery Pack in Falcon **310**, **315**, **320**, or **325** Battery Compartment

310
315
320
325

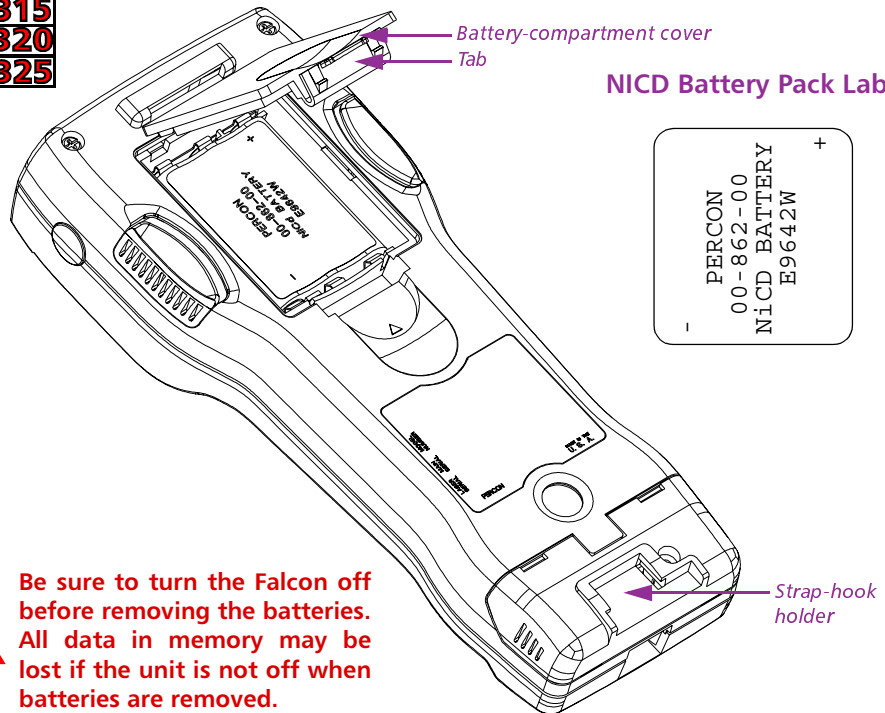

Be sure to turn the Falcon off before removing the batteries. All data in memory may be lost if the unit is not off when batteries are removed.

5. Lay the plastic ribbon along the bottom of the battery compartment with the end sticking out.
6. **Alkaline Batteries** Insert the batteries in the positions indicated by the diagram inside the compartment.

NiCD or NiMH Battery Pack Find the positive (+) and negative (-) symbols on the battery pack's label (see figure 2-1). With the label side out, tilt the positive end of the pack into the upper end of the battery compartment, and then firmly press the negative end until it is fully inserted into the battery compartment.

7. Replace the battery-compartment cover by sliding it into place. (Be sure the plastic ribbon is tucked underneath the cover.)

8. Replace the hand-strap hook in its holder.

NOTE: The Falcon will not function unless the battery-compartment cover is in place and securely latched.

330
335

For Falcon models **330** and **335**:

1. Turn the Falcon off.
2. Detach the elastic hand strap on the back of the Falcon by releasing its hook from the connection at the base of the unit.

Figure 2-2: NiMH Battery Pack in the Falcon **330** or **335** Battery Compartment

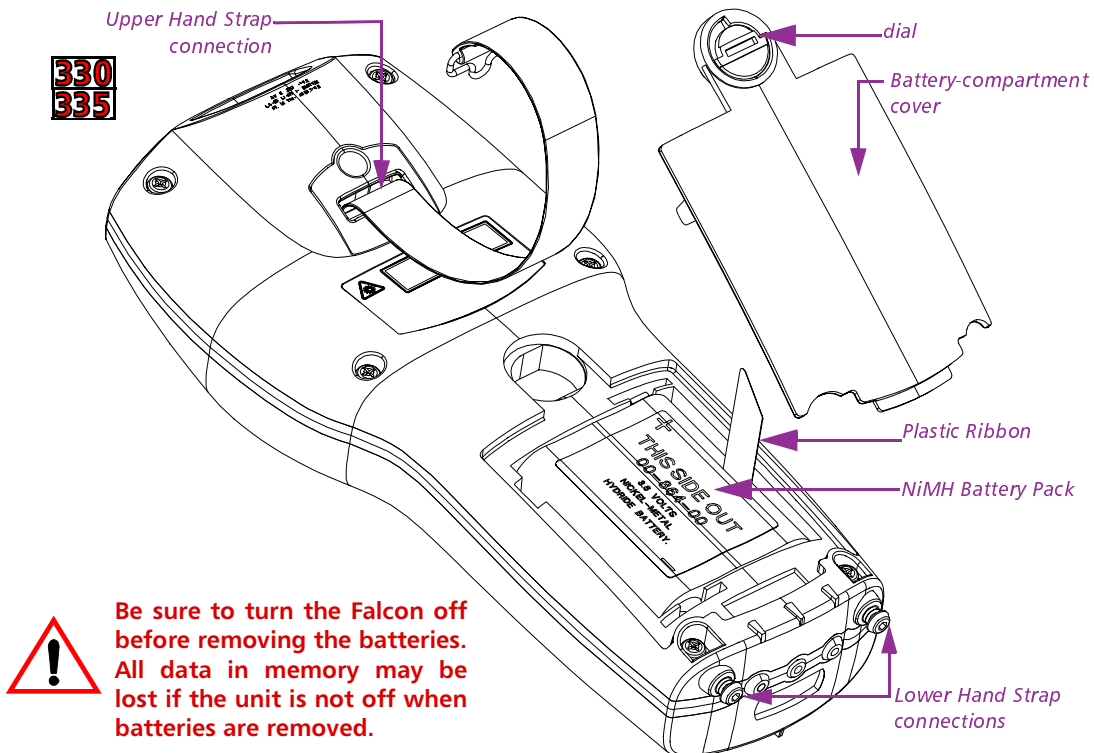

Be sure to turn the Falcon off before removing the batteries. All data in memory may be lost if the unit is not off when batteries are removed.

3. Turn the dial counter-clockwise to release the battery compartment cover.
4. Pull the end of the exposed plastic ribbon in the battery compartment until the batteries pop out.
5. Lay the plastic ribbon along the bottom of the battery compartment with the end sticking out.
6. **NiMH Battery Pack** Find the positive (+) and negative (-) symbols on the battery pack's label (see figure [2-2](#)). *With the label side out*, tilt the positive end of the pack into the upper end of the battery compartment, and then firmly press the negative end until it is fully inserted into the battery compartment.
7. Replace the battery-compartment cover by inserting the bottom tab into the slot and rotating the cover latch in a clockwise direction. (Be sure the plastic ribbon is tucked underneath the cover.)
8. Replace the hand-strap hook in the clip.



NOTE: *The battery pack should not be replaced in a dirty or harsh environment. When the battery compartment cover is off, any dust or moisture that enters the battery compartment can get into the main unit, potentially causing damage. The Falcon will not function unless the battery-compartment cover is in place and securely latched.*

Auto-Shutoff

The Falcon has an automatic-shutoff feature that helps conserve battery life while not in use.

- When a specified amount of time has passed since a key or a trigger has been pressed, the Falcon turns itself off.
- All data in memory is maintained.
- Press the power button to turn the unit back on.

>> The Keypad

Used individually or in combination, the keys of the Falcon keypad provide equivalents to almost all the keys found on a standard keyboard. The keypads are shown in figures [2-3](#) and [2-4](#).

- Falcon models **310** and **315** have 41 keys.
- Falcon models **320** and **325** have 57 keys.
- Falcon models **330** and **335** have 38 keys.

The following keys appear on a standard IBM compatible computer keyboard but are not used on the Falcon:

- | | | |
|------------|--|--|
| 310 | <input type="checkbox"/> F11 | <input type="checkbox"/> Caps Lock* |
| 315 | <input type="checkbox"/> F12 | <input type="checkbox"/> Scroll Lock |
| 320 | <input type="checkbox"/> Left Shift* | <input type="checkbox"/> Pause/Break |
| 325 | <input type="checkbox"/> Right Shift* | <input type="checkbox"/> Print Screen/SysReq |
| 330 | <input type="checkbox"/> Right Alt | <input type="checkbox"/> Num Lock |
| 335 | <input type="checkbox"/> Right Ctrl | <input type="checkbox"/> Numeric keypad keys |
| | | |
| 320 | <input type="checkbox"/> Pg Up | <input type="checkbox"/> Home |
| 325 | <input type="checkbox"/> Pg Down | <input type="checkbox"/> End |
| | | |
| 330 | <input type="checkbox"/> Right bracket] | <input type="checkbox"/> Left bracket [|
| 335 | | |

*The Falcon's Caps key provides the functions of these keys.

Figure 2-3: The Keypad for Falcon models **310**, **315**, **320**, and **325**.

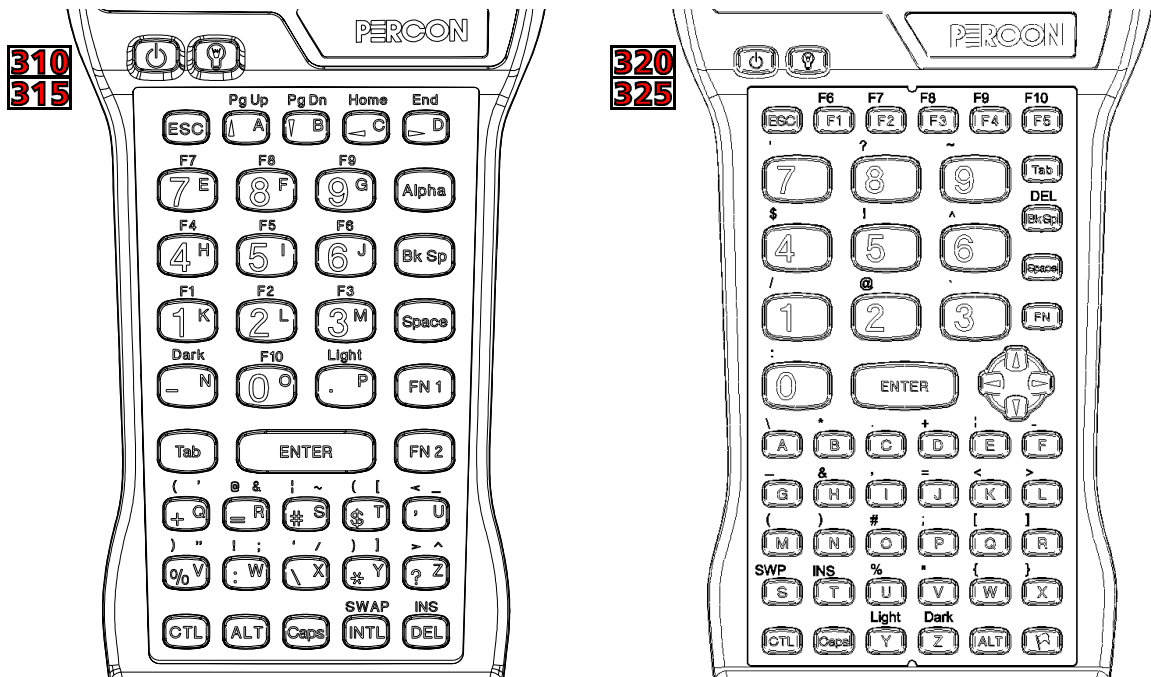

Figure 2-4: The Keypad for Falcon models **330** and **335**.



The Falcon has a few keys that are not found on a standard IBM compatible PC keyboard. These keys are shown in table [2-1](#). Page numbers indicate where to find more information about the keys.

Table 2-1: Falcon Keys Not Found on a Standard Keyboard







Models	Key	Default Use
310 315	Alpha	Toggles the Falcon between Alpha mode and Normal mode (p. 14)
	Caps	When pressed and released, toggles Caps mode on and off; when held down, acts equivalently to the Shift key on a standard computer keyboard (p. 14)
	Dark	Darkens the background of the viewport (p.23)
	FN 1	Outputs the blue symbol or activates the function (F1–F10) above the next key pressed (p. 14)
	FN 2	Outputs the black symbol above the next key pressed (p. 14)
	INTL	Outputs an international character generated by the combination of the next two keypresses (p. 18)
	Lamp ()	Turns the backlight on and off in the viewport (p. 24)
	Light	Lightens the background of the viewport (p. 23)
	Power ()	Turns the Falcon on and off (p. 6)
	Swap	Switches the assigned actions of the right and left laser triggers (p. 25)
	Left laser trigger	Operates the Falcon laser or an attached bar code reader; can be reprogrammed as a keypad key (p. 25)*
	Right laser trigger	Same as the Alpha key; can be reprogrammed as a laser trigger or a keypad key (p. 25)*
320 325	Caps	When pressed and released, toggles Caps mode on and off; when held down, acts equivalently to the Shift key on a standard computer keyboard (p. 14)
	FN	Outputs the symbol or activates the function (F6–F10) above the next key pressed (p. 14)
	Dark	Darkens the background of the viewport (p. 23)
	International ()	Outputs an international character generated by the combination of the next two keypresses (p. 18)
	Lamp ()	Turns the backlight on and off in the viewport (p. 24)
	Power ()	Turns the Falcon on and off (p. 6)
	SWP (Swap)	Switches the assigned actions of the right and left laser triggers (p. 25)
	Left laser trigger	Operates the Falcon laser or an attached bar code reader; can be reprogrammed as a keypad key (p. 25)*
	Right laser trigger	Same as the FN key; can be reprogrammed as a laser trigger or a keypad key (p. 25)*

Table continues

Models	Key	Default Use
	Caps	When pressed and released, toggles Caps mode on and off; when held down, acts equivalently to the Shift key on a standard computer keyboard (p. 14)
	Contrast (☾)	Activated by pressing Fn-Lamp; left and down arrow keys will decrease contrast; right and up arrow keys will increase contrast of the display.
	FN	Outputs the symbol or activates the function (F6–F10) above the next key pressed (p. 14)
	INTL	Outputs an international character generated by the combination of the next two keypresses (p. 18)
	Lamp (☀)	Turns the backlight on and off in the viewport (p. 24)
	Left Enter key	Operates as the standard Enter or Return key; either the Left or Right Enter key can be reprogrammed to be one of a set of other keypad keys (p. 25)*
	Power (⏻)	Turns the Falcon on and off (p. 6)
	Right Enter key	Operates as the standard Enter or Return key; either the Left or Right Enter key can be reprogrammed to be one of a set of other keypad key (p. 25)*
	Scan	Operates the Falcon laser (p. 25)*
Viewport Panning Mode	Fn-5 toggles the viewport panning mode on or off; the arrow keys can be used to effect panning (keys 2,4,6, and 8); use the panning toggle key (key 5) to exit panning mode and return the screen to cursor mode.	

*For information about reprogramming triggers, left, and right enter keys as keypad keys, see the Falcon DOS Portable Data Terminals Advanced User's Guide.

Input Modes

The current input mode determines key functions on the Falcon. The input modes are described in table 2-2.

Table 2-2: Keypad Input Modes

Models	Input Mode	Result of Keypress
310 315	Type 1—Remains in effect after each keypress until discontinued by user	
	Normal	Outputs the white number or symbol on the key, or performs an action (e.g., moves left)
	Alpha	Outputs the yellow letter on the key (lowercase unless used with Caps mode)
	Caps (used with Alpha mode)	Outputs the uppercase yellow letter on the key
	Type 2—Affects only a single keypress or combination of keypresses	
	Function 1	Outputs the blue symbol or function above the key
	Function 2	Outputs the black symbol above the key
	Control	Outputs the control meaning for alphanumeric or function keys
	Alternate	Outputs the alternate meaning for alphanumeric or function keys
	International	Outputs a character from the international character set (see page 18)
320 325 330 335	Type 1—Remains in effect after each keypress until discontinued by user	
	Normal	Outputs the letter (lowercase), number, or function on the key
	Caps	Outputs the uppercase letter on the key
	Type 2—Affects only a single keypress or combination of keypresses	
	Function (Fn)*	Outputs the symbol or function above the key
	Control (Ctrl)	Outputs the control meaning for alphanumeric or function keys
	Alternate (Alt)	Outputs the alternate meaning for alphanumeric or function keys
	International (Intl)	Outputs a character from the international character set (see page 18)

310
315

Working with Input Modes

NOTE: This section applies only to Falcon models **310** and **315**.

The color coding of the keys and characters on models **310** and **315** reflects input mode functions.

- The **yellow** Alpha key works with the **yellow** letters on the other keys.

- The **blue** FN 1 key works with the functions (F1–F10) and the **blue** characters printed above some of the keys.
- The **black** FN 2 key works with the **black** characters or operations printed above some of the keys.

For most applications, the letters and numbers are all that are needed.

- Input letters by pressing the Alpha key (to turn on Alpha mode) and pressing the keys for the letters.
- Press the Caps key with the Alpha key for uppercase letters.
- Press the Alpha key again to return to the normal mode.
- In normal mode, numbers and punctuation characters can be selected by pressing the appropriate key.

A type-1 mode can be temporarily overridden without actually changing the mode. For example, when entering numbers in Normal mode, to type a letter:

- Hold down the Alpha key while pressing the key for that letter.
- Release the Alpha key; the Falcon will still be in Normal mode.
- Use the Caps key the same way to enter an uppercase letter without changing to Caps mode.

NOTE: Because they have more keys, models **320** and **325** have fewer possible outputs from a single key and are easier for a beginner to use.

Double Action Key Mode

330
335

There are two additional modes of operation, which affect how alpha keys and the punctuation characters above the alpha keys are accessed. The Falcon **330** and **335** have only 38 keys.

- Thirteen of these keys are used for alpha keys (the letters A–Z).
- Each key has two letters on the key itself, and two punctuation characters above the key.
- Accessing the alpha character printed on the left side of the key (the “first” letter) is done as normal.
- Accessing the alpha character printed on the right side of the key (the “second” letter) depends upon the mode of operation.

Selecting Alpha Characters in Double Strike Mode

- Left character: Press the Alpha key once and release. After a predetermined time-out (the default is 330ms), the character will be displayed.
- Right character: Quickly press the Alpha key twice. The second key press must occur before the predetermined time-out (the default is 330ms).

This mode is called the *double strike* mode, because it requires two rapid presses on a key to access the second (the right-most) character.

Selecting Alpha Characters in Press and Wait Mode

- Left character: Press an Alpha key once and release
- Right character: Press the Alpha key and hold for a predetermined time-out (the default is 330ms).

This mode is called *press and wait* mode, because it requires pressing the key and holding it down for a certain amount of time to access the second (right-most) character.

The mode and time-out (for either mode) can be changed via the Falcon configuration driver, the Run-Time Library or by bar code scanning.

The second character can be accessed in this way regardless of other types of input modes the Falcon **330** and **335** is in. This includes Fn, Ctrl, and Alt key entries. To get the punctuation symbol above the B character:

- Press the Fn key
- Perform the action to select the second (right-most) character for the key the B is on (this depends upon the Double Action key mode of operation).

The exception to the above rule is during International key entry. See the section on International key entry for more details.

Cursors and Icons

310
315

The shape of the Falcon's cursor in the viewport is a key to the current input mode. Table [2-3](#) identifies the various input modes and the corresponding cursors.

320
325
330
335

Icons located along the right side of the viewport indicate the current input mode. Table [2-3](#) identifies the various input modes and the corresponding icons.

Table 2-3: Cursors, Icons, and Input Modes

Cursor	Icon	Input Mode
—	None	Normal
	N/A	Alpha
		Caps
N/A		Function
	N/A	Function 1
	N/A	Function 2
		Control
		Alternate
		International

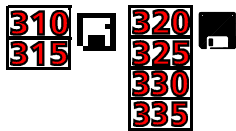

During operations that require use of a disk drive, a disk icon appears on the right side of the viewport. This indicates that the unit is busy. Wait until the icon disappears before continuing to use the unit. The icons are shown at the left.

International Characters



The international character set contains letters and symbols commonly used in Western European languages. Enter international characters by using the following key sequence:

Intl **accent** **letter**

- The **accent** is a character from the “Accent or Letter” column of table [2-4](#)
- The **letter** is a character from the “Letter” column in the same row.

NOTE: The Intl key () is orange with a white flag in Falcon models **320** and **325**.

Table 2-4: International Character Key Combinations for Falcon **310**, **315**, **320**, **325**.

Models	International Characters	Accent or Letter	Letter
310 315	á, é, í, ó, ú, É	' (apostrophe)	a, e, i, o, u, E
	à, è, ì, ò, ù	`	a, e, i, o, u
	â, ê, î, ô, û	^	a, e, i, o, u
	ä, ë, ï, ö, ü, ÿ, Ä, Ö, Ü	:	a, e, i, o, u, y, A, O, U
	å, Å	@	a, A
	ç or Ç	None	c or C
	ñ or Ñ	None	n or N
	ñ or Ñ	~	n or N
	ß	s	s
	æ	a	e
	Æ	A	E
	¿	?	?
	¡	!	!
	£	FN 1 + \$	None
	¥	FN 2 + \$	None
	ç or Ç	, (comma)	c or C
320 325	á, é, í, ó, ú, É	' (apostrophe)	a, e, i, o, u, E
	ç or Ç	' (apostrophe)	c or C
	à, è, ì, ò, ù	`	a, e, i, o, u
	â, ê, î, ô, û	^	a, e, i, o, u
	ä, ë, ï, ö, ü, ÿ, Ä, Ö, Ü	:	a, e, i, o, u, y, A, O, U
	å, Å	@	None
	ç or Ç	None	c or C
	ñ or Ñ	None	n or N
	ñ or Ñ	~	None
	ß	s	None
	¿	?	None
	¡	!	!
	ç, £, ¥	\$	c, l, y
æ or Æ	!	e or E	

330
335

To lessen the number of keystrokes required to enter an International key, the Falcon **330** and **335** keypad is designed according to the following guidelines:

- The Intl key is a combination of keystrokes (Fn-Alt).

- All accent characters are the first (left-most) character on a key. The **Double Action** key method is never used to access an accent characters.
- The format for entering an International key sequence remains the same.

The following table describes the key sequences for all International characters for the Falcon **330** and **335**:

Table 2-5: International Character Key Combinations for the Falcon **330** and **335**.

Models	International Characters	Accent or Letter	Letter
330 335	á, é, í, ó, ú, É	' (apostrophe)	a, e, i, o, u, E
	ç or Ç	' (apostrophe)	c or C
	à, è, ì, ò, ù	`	a, e, i, o, u
	â, ê, î, ô, û	^	a, e, i, o, u
	ã, ë, ï, õ, ü, ÿ, Ä, Ö, Ü	:	a, e, i, o, u, y, A, O, U
	ß	s	s
	å, Å	@	None
	ñ or Ñ	~	m, n, M, or N
	¿	?	None
	¡	!	!
	¢, £, ¥	\$	c, k, l, y
	æ or Æ	!	e or E

Repeating Keystrokes

320
325

The keypad for the Falcon models **320** and **325** (only) features support for repeating keystrokes:

- Press and hold the key to repeat a keystroke.
- After a brief pause, the keystroke will be automatically repeated until the key is released.

This feature can be particularly useful with such keys as **Bk Sp** and the cursor keys.

>> The Viewport

The Falcon's viewport is a backlit liquid crystal display of:

- 21 characters in 8 rows on models **310** and **315**
- 20 characters in 16 rows on models **320**, **325**, **330** and **335**.

When entering more than the maximum number of characters, the text in the viewport will scroll to the left to display the additional characters in the line.

Moving the Viewport Display

The viewport display can be moved to the left or right by half screens to view long lines of text.

Figure 2-5: Location of the Cursor Keys in the Falcon **310** and **315**

310
315

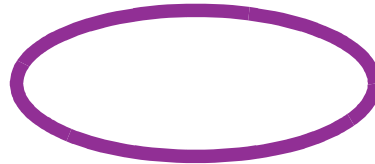



- Press and hold the FN | key. Use the cursor keys (see figure 2-5) to move the display up, down, to the left, or to the right.
- Release the FN | key to make the current cursor position visible.

It is also possible to press and release the FN | key and then move the viewport several times in one or more directions. When finished, press and release the FN | key again to return to the current cursor position.

Figure 2-6: Location of the Cursor Keys in the Falcon **320** and **325**

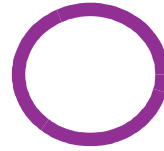
320
325



- ❑ Press and hold the **FN** key and use the cursor keys (see figure 2-6) to move the display up, down, to the left, or to the right.
- ❑ The viewport panning icon () will appear on the right side of the display.
- ❑ Release the **FN** key, to make the current cursor position visible.

It is also possible to press and release the **FN** key and then move the viewport several times in one or more directions. When finished, press and release the **FN** key again to return to the current cursor position.

Figure 2-7: Location of the Cursor Keys in the Falcon **330** and **335**

330
335

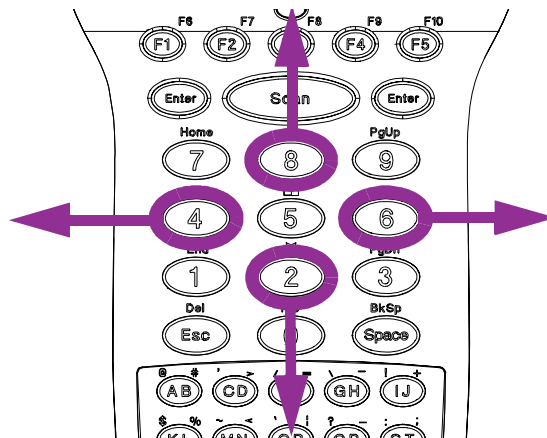

The key combination of **FN-5** toggles the view port panning mode on or off.

- Pressing the combination FN-5 the first time places the unit into panning mode, and the panning icon () will display along the right side of the LCD.
- Once in panning mode, the arrow keys (see figure 2-7) can be used to effect panning to move the display up, down, to the left, or to the right.
- The Panning toggle key (above the 5) can be used to exit panning mode and have the screen snap back to the cursor. In this case, no character is displayed.

It is not necessary to press Fn to activate the Panning Toggle key in order to exit the panning mode. Also, if any other key is pressed (besides an arrow key or the 5 key), the Falcon will exit panning mode, snap back to the cursor, and display the pressed character (if applicable).

NOTE: *There is a difference in the way the Falcon **320**, **325** and Falcon models **330**, **335** function when exiting panning mode. On the Falcons **330** and **335**, once the FN-5 combination is entered, the FN state is no longer active (but panning mode is), so pressing the "A" alpha key to exit panning mode will result in an "A" being displayed.*

Adjusting the Contrast

When working in dim or bright light, it is possible to adjust the contrast between the text and the background in the viewport.

310
315

- Press and release the FN 2 key
- Use the Light and Dark keys to adjust the contrast.
- When finished, press and release the FN 2 key again.

320
325

- Press and release the FN key.
- Use the Light and Dark keys to adjust the contrast.
- When finished, press and release the FN key again.

330
335

- Press the Fn-Lamp key to enter contrast adjust mode. To indicate the contrast mode is active, two dots to the right of the Fn Icon on the right-hand side of the display will toggle back and forth.
- The left and down arrow keys will decrease the contrast
- The right and up arrow keys will increase the contrast of the display.

Using the Backlight

When using the Falcon in dim light, the backlight can be turned on to improve viewport visibility.

Falcon models **310**, **315**, **320**, and **325**:

- Press the **Lamp** () key below the viewport to turn the backlight on or off.

On the Falcon model **330** and **335**:

- Press the **Lamp** () key in the middle of the bottom row of the keypad matrix to turn the backlight on or off.

To save battery power, the backlight will shut off automatically if no key is pressed within a certain amount of time. The backlight will turn back on when any keypad key is pressed.

>> The Falcon Laser

Some models of the Falcon come with a built-in high-performance laser scanner. To use this scanner, just point the laser window at a bar code and press the trigger that activates the laser. A red light-emitting diode (LED) on the scanner module indicates when the Falcon is scanning, and a green LED indicates when a scan is successful.

Some Falcon models are equipped with a long-range scanner. See page [26](#) for information on using the long-range scanner.

330
335

The Falcon **330** and **335** has a built-in front shooting laser.

- To use the laser, aim the top of the unit at a barcode and press the **Scan** key.
- The laser is not aimed straight from the unit, but angles down at approximately a 15 degree angle. This allows scanning barcodes with a more natural hand position (the unit rests more horizontally instead of angling down).
- A red LED directly below the LCD (above the **F3** key) indicates when the Falcon is scanning.
- This LED switches to green when a scan is successful.

The Laser Triggers

310
315
320
325

The left trigger (as seen from the front) is the default setting to operate the Falcon laser or another bar code reader attached to the Falcon, and the right trigger toggles the Falcon in and out of Alpha mode (models **310** and **315**) or Function mode (models **320** and **325**). The operation of these triggers can be switched. This will allow use of the right trigger as the laser trigger and the left trigger as the mode toggle. To swap the trigger operations:

310
315

- Press the **FN 2** key, and then press the **SWAP** key
- Repeat to return to the default settings.

320
325

- Press the **FN** key, and then press the **SWP** key
- Repeat to return to the default settings.

NOTE: Unlike the Falcon **320** and **325**, the Falcon **330** and **335** have only one laser scan key. It is the large elliptical key in the middle top of the keypad matrix. This key cannot be reprogrammed.

Changing the Laser Module's Orientation

Normally, the laser window faces the left side of the Falcon for easy right-handed scanning. To hold the Falcon in the left hand while scanning, the laser module can be rotated.

Figure 2-8: Rotating the Laser Module on the Falcon **310**, **315**, **320**, and **325**

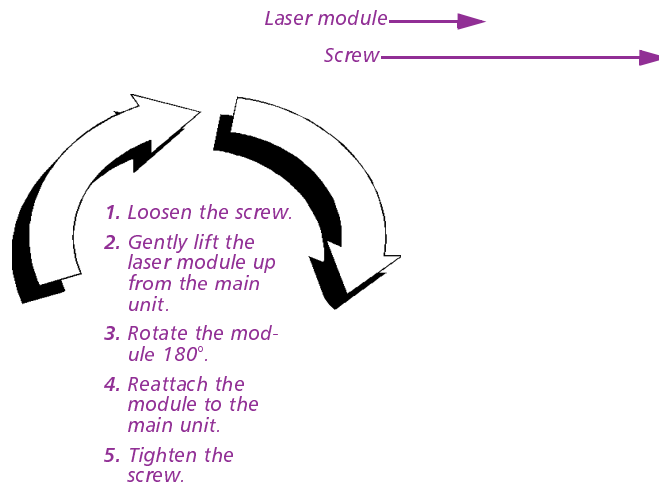

330
335

NOTE: The Falcon models **330** and **335** do not have a long range scanner option at this time.

310
315
320
325

To rotate the laser module, complete the following steps:

1. Loosen the screw that secures the module to the main part of the Falcon (see figure 2-8). Do not try to remove the screw.
2. Gently lift the laser module away from the top of the main part of the Falcon. The module will not completely separate from the rest of the Falcon. Do not try to force the units apart.
3. Swivel the module around until the laser window faces the opposite direction. The module can rotate in only one direction. Do not force it the other way.
4. Press the laser module back into the main part of the Falcon, and tighten the screw.

***NOTE:** After changing the laser module's orientation, it may be necessary to swap the operations of the triggers (see above).*

Using the Long-Range Laser

The Falcon's optional long-range integrated laser uses a spotting beam to scan bar code labels from a distance. With the spotting beam aimed at the center of the bar code, the Falcon unit is positioned to read the bar code with its scanning beam.

330
335

***NOTE:** The Falcon models **330** and **335** do not have a long range scanner option at this time.*

Figure 2-9: Long-Range Laser Operation in the Falcon **310**, **315**, **320**, and **325**



The long-range laser may be operated in either of two trigger modes:

- Spot Beam Time-out** This is the default mode of operation. When the laser trigger is pressed and held, the laser emits a spotting beam. Aim this beam at the center of the bar code. After a short time-out period (the default is one-half second), the laser switches to a full scanning beam and reads the bar code.

- Release Scan** This mode provides greater control over the spotting beam. When the laser trigger is pressed and held, the laser emits a spotting beam, as with the Spot Time-out mode. In Release Scan mode, the spotting beam stays on, for up to 5 seconds, until the trigger is released. Then the laser switches to a full scanning beam and reads the bar code. (Turn off the full scanning beam by pressing and releasing the trigger.)

To prevent accidental scanning, both modes require that the laser trigger is held down to activate the spotting beam.

>> Attaching a Bar Code Reader

310
315
320
325

If the Falcon does not have an integrated laser scanner, a bar code reader can be attached to the connector at the top. The reader's cable must have a standard nine-pin squeeze connector at the end.

To attach the bar code reader:

- Match the orientation of the holes on the squeeze connector with the pins on the Falcon's connector.
- Push the squeeze connector onto the Falcon's connector until it is firmly in place (see figure [2-10](#)).

Figure 2-10: Attaching a Percon SnapShot to a Falcon **310**, **315**, **320**, or **325**

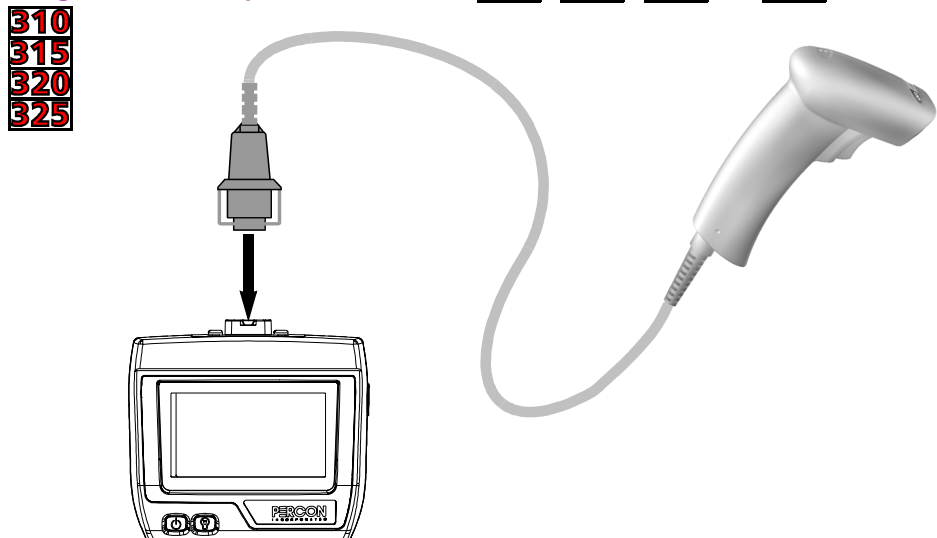

To disconnect the bar code reader from the Falcon:

- Press the sides of the squeeze connector
- Pull it away from the Falcon's connector.

330
335

*NOTE: The only option for scanning with the Falcon models **330** and **335** is with the internal laser. Due to sealing and environmental issues, no external port is available for external lasers, even if the Falcon **330** or **335** is ordered without an internal laser.*

>> The Serial Port

310
315
320
325

The Falcon **310**, **315**, **320**, and **325** have a port for serial communications with a PC. The port is located at the base of the Falcon unit (see figure 2-11). Designated as COM1, it is a 10-pin telephone-style jack providing a standard RS-232 connection.

With a serial cable connected to it, the port allows communications with a host computer or any serial device, such as a printer or modem. The serial port also provides a connection for communications and battery recharging in the Falcon Dock and Falcon 4-Slot Dock.

Figure 2-11: The Serial Port

310
315
320
325

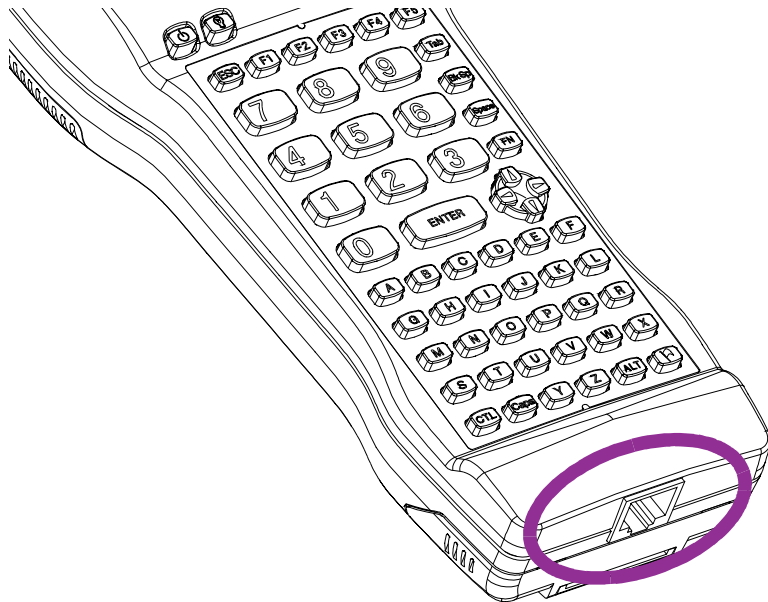

>> *The Falcon Applications*

310
315
320
325
330
335

When shipped from the factory, each Falcon unit is programmed with several applications collectively known as PAL2. If the Falcon has been customized, it may be programmed with other (or additional) applications.

For information on using PAL2, see the *Falcon Portable Applications Library User's Guide*. When using another application, contact the system administrator for instructions.

>> Chapter Three

The Falcon Dock

The Falcon Dock is specially designed for use with the Falcon DOS portable terminal. The dock provides a connection between the Falcon and a computer without sacrificing the convenience of portability. Instead of attaching a cable each time to transmit data to or from the Falcon, simply place the unit into the dock. To use the Falcon for data collection again, just remove it from the dock.

This chapter describes how to use the Falcon Dock.

CHAPTER CONTENTS

<i>About the Falcon Dock</i>	<32>
<i>Attaching the Falcon Dock to the Computer</i>	<33>
<i>The Power Adapter</i>	<33>
<i>Using the Falcon Dock</i>	<34>
<i>Maintenance</i>	<35>

>> *About the Falcon Dock*

The Falcon Dock is a handy docking station for the Falcon. It has two primary uses:

- Recharges the Falcon's NiCD or NiMH battery pack
- Provides a connection for serial communications between the Falcon and the host computer or another serial device, such as a printer or modem

Figure 3-1: The Falcon Dock

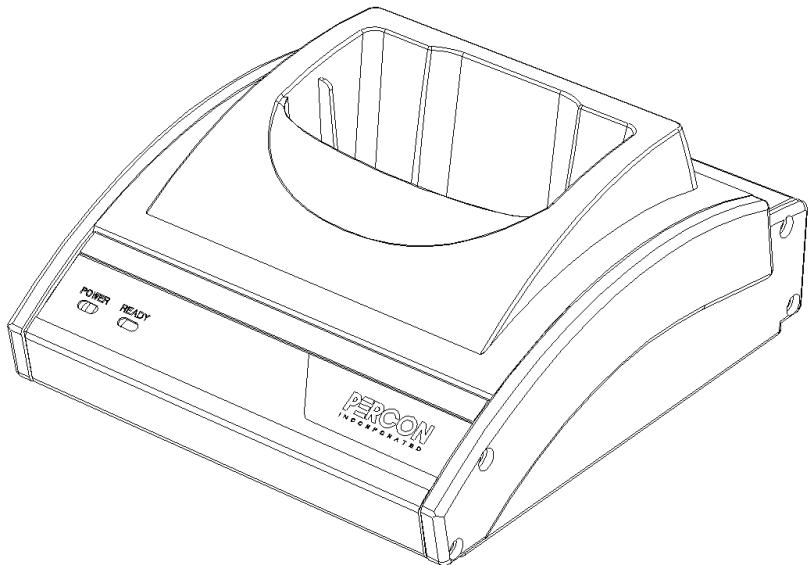

A cable and a power adapter for the Falcon Dock are available separately. To make cables, see the *Falcon DOS Portable Terminals Advanced User's Guide* for pin assignments.

>> Attaching the Falcon Dock to the Computer

Complete the following steps:

1. Attach the 25-pin end of the cable to the cable connector on the back of the Falcon Dock (see figure 3-2).
2. Attach the other end of the cable to a serial port on the selected computer.
3. If the optional power adapter was ordered, attach it to the Falcon Dock (see the next section).

Figure 3-2: Back Panel of the Falcon Dock

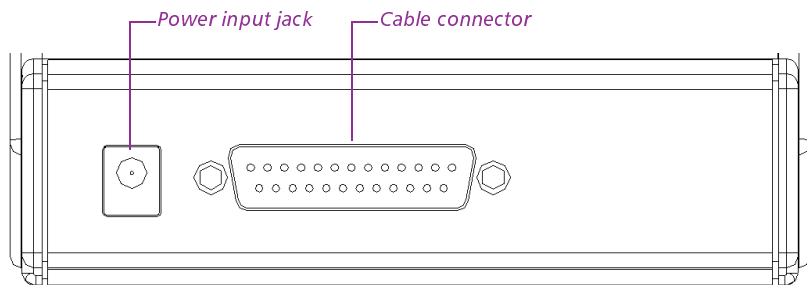

>> The Power Adapter

A 9-volt power adapter can be used with the Falcon Dock to recharge the NiCD or NiMH batteries in the Falcon. Power adapters are available from a Percon dealer.

Attach the small, round plug of the power adapter to the power input jack on the back of the Falcon Dock (see figure 3-2). Plug the other end into an outlet or power strip. The red light-emitting diode (LED) labeled POWER on the front panel of the Falcon Dock should light up.

The power adapter is used only to recharge the batteries in the Falcon **310**, **315**, **320**, or **325**. However, if it is not used, the LED indicators on the Falcon Dock will not light up. (The READY light indicates that the Falcon is properly inserted in the dock. The READY light will appear red when charging and green when fully charged.)

In the Falcon **330** and **335**, the dock's power must be on for serial communication to occur.

NOTE: *If alkaline batteries are being used in the Falcon, do not connect a power adapter to the dock. Attempting to recharge alkaline batteries may cause battery leakage. Use only a 9-volt power adapter supplied by a Percon dealer. Using another adapter can damage the dock.*

>> Using the Falcon Dock

Set up the Falcon Dock as described in the preceding sections. Place the Falcon into the dock, with the keypad facing the front. If a power adapter is being used, the green LED labeled **READY** on the front panel of the Falcon Dock should light up.

NOTE: *If the **READY** light does not come on:*

- Make sure the **POWER** light is on
- The Falcon is fully inserted into the dock, with the keypad facing out

*If the **READY** light still does not come on:*

- Make sure the Falcon Dock adapter is securely attached to the Falcon
- The contacts in the dock are clean. (If a power adapter is not being used, the light will not come on.)

If alkaline batteries are being used in the Falcon, do not connect a power adapter. Serial communications will operate normally even though the indicator LEDs will remain dark without the adapter.

While the Falcon is in the Falcon Dock, programs can be downloaded into the Falcon or data returned from it just as if it were connected directly to the computer. The Falcon can be left in the dock while using an attached bar code reader.

If utilizing a nickel-cadmium (NiCad) or nickel metal hydride (NiMH) battery pack in the Falcon, the Falcon Dock can be used to recharge the batteries. Simply leave the battery pack in the Falcon when placing it in the dock. The battery pack and the lithium backup battery will be recharged while the **READY** light is on. The charging time is 8 to 15 hours, depending on the type of battery pack and the current charging level.

330
335

NOTE: Communications between Falcon models **330** or **335** and the host are exactly the same as a Falcon **320**, or **325** dock or a hardwire connection with the following exceptions:

- The Falcon **330** and **335** uses IR for data transmission. The dock will not propagate other RS-232 control signals (such as RTS and CTS).
- These signals are loopbacked on the dock (CTS <-> RTS, etc.). Applications that expect these signals will need to be modified.
- Even though the Falcon **330** and **335** are IR, the dock allows full duplex communications between the Falcon and host.

>> Maintenance

With normal use, the Falcon Dock should require no maintenance.

>> Chapter Four

The Falcon 4-Slot Dock

310
315
320
325

The Falcon 4-Slot Dock is specially designed for use with Falcon DOS portable terminals. It provides serial communications capabilities and convenient battery recharging for one to four Falcons. This chapter describes how to set up and use the Falcon 4-Slot Dock.

Finding Out More: See *the Falcon DOS Portable Terminals Advanced User's Guide*.

330
335

NOTE: There is no 4-Slot Dock for the Falcon **330** and **335** at this time.

CHAPTER CONTENTS

About the Falcon 4-Slot Dock	<38>
<i>Front Panel</i>	
<i>Back Panel</i>	
Installation	<40>
<i>Power Adapter</i>	
<i>Cables</i>	
<i>Connecting the Dock to the Host</i>	
<i>Creating a Dock Network</i>	
Using the 4-Slot Dock	<41>
<i>Charging a Falcon's Batteries</i>	
<i>Transferring Data</i>	

>> About the Falcon 4-Slot Dock

Use the Falcon 4-Slot Dock to:

- Provide a connection for serial communications between one to four Falcons and a host computer.
- Recharge the Falcon's nickel cadmium (NiCD) or nickel metal-hydride (NiMH) battery pack.

A dock network can be used by connecting two or more 4-Slot Docks to each other and connecting just one dock to the host. A Falcon in any slot on any dock in the network can exchange data with the host. While a slot is busy, all other slots in the network must wait for that one to become free.

Front Panel

The front panel of the 4-Slot Dock has two light-emitting diodes (LEDs) that indicate conditions for the entire 4-Slot Dock unit (see figure 4-1).

POWER Green indicates that the dock is receiving electricity through the power adapter.

BUSY Red indicates that another 4-Slot Dock in the network is communicating with the host.

Figure 4-1: LEDs for Status of Falcon 4-Slot Dock

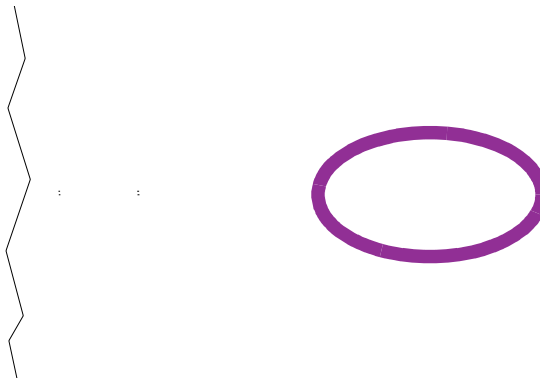

Two LEDs for each slot (see figure 4-2) show the status of the Falcon portable in that slot.

COM Green indicates that the Falcon has control of the communications line to the host.

CHARGE Red indicates that the Falcon's batteries are being charged. Green indicates that the batteries are fully charged.

Figure 4-2: LEDs for Status of Falcon in Slot



BACK PANEL The back panel of the 4-Slot Dock has cable jacks for connections to the host computer and other 4-Slot Docks (see figure 4-3). The power input jack is also located there. (For information about connecting docks, see "[Creating a Dock Network](#)" on page 41).

Figure 4-3: The Back Panel on the Falcon 4-Slot Dock

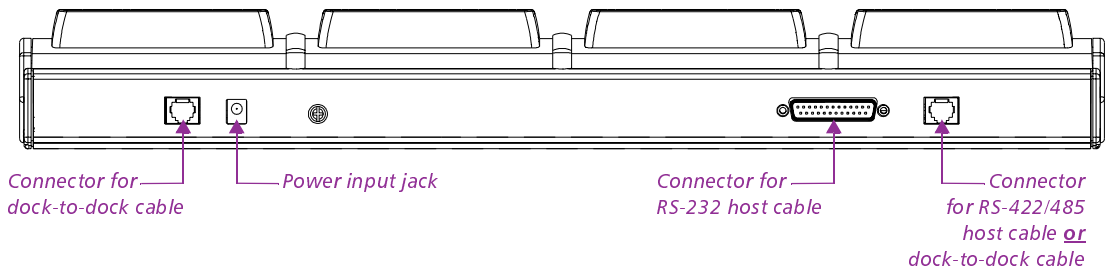

>> *Installation*

Power Adapter

Use one of the following:

- US:** US style 110VAC plug (Percon part number 00-850-00)
- International:** 100–250VAC 47–63Hz input with IEC320 (part number 00-851-00; includes power cord)

Cables

To connect the 4-Slot Dock to a host computer, use one of the following:

- RS-232 cable** (Percon part number 00-884-32)
- RS-422/485 cable** (custom-built for the application)

To form a network of multiple 4-Slot Docks, connect the docks to each other with either of the following Percon cables:

- 2-foot cable** (00-884-36)
- 10-foot cable** (00-884-37)

NOTE: See the *Falcon DOS Portable Terminals Advanced User's Guide* for pin assignments.

Connecting the Dock to the Host

To connect the Falcon 4-Slot Dock to a computer, complete the following steps:

1. Plug one end of the serial cable into the appropriate connector on the back of the 4-Slot Dock.
2. Attach the other end of the cable to an available serial port on the computer.
3. Attach the power adapter cord to the power input jack on the back of the dock. (If using the international power adapter, plug one end of the power cord into the power adapter.)
4. Plug the power cord into an outlet or power strip (preferably one that has surge protection). The **POWER LED** on the front panel of the dock should light up.

Creating a Dock Network

Figure 4-4 shows the back of two docks in a network. The dock on the left is connected to a third dock (which may be connected to another dock). The dock on the right is connected to the host computer with an RS-232 cable. (To use an RS-422/485 connection to the host, use the telephone-style jack at the far right. The RS-232 connector would not be used.)

Each 4-Slot Dock unit in the network must be connected to a power supply.

Figure 4-4: Connections for Falcon 4-Slot Docks in a Network

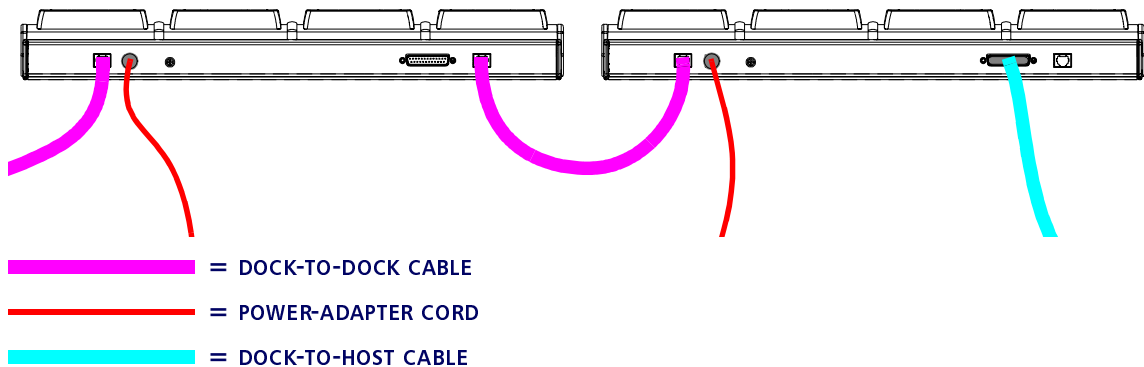

>> Using the 4-Slot Dock

Charging a Falcon's Batteries

To charge the rechargeable batteries in a Falcon, place the Falcon into any slot of a 4-Slot Dock that is connected to a power supply. The dock does not need to be connected to a computer.

NOTE: Only Falcons equipped with rechargeable NiCD or NiMH batteries should be used with the Falcon 4-Slot Dock. Using Alkaline batteries can cause battery leakage and possible damage to the Falcon.

Transferring Data

To transfer programs or data files between a Falcon and a computer through a 4-Slot Dock, a Percon's XFER utility can be used, the Falcon Configuration Utility, or any standard serial-transfer program.

NOTE: For information about using XFER or the Falcon Configuration Utility, see the Falcon DOS Portable Terminals **Advanced User's Guide**.

Index

4-Slot Dock [3](#), [37–41](#)

A

accessories [2](#)
applications [29](#)
auto-shutoff feature [10](#)

B

backlight [24](#)
backup battery [7](#)
bar code reader, attaching to Falcon [27](#)
batteries
 charging [2](#), [3](#)
 low-battery warning [7](#)
 types [7](#)
battery charger [3](#)
battery icon [7](#)

C

care and cleaning [3](#)
character set, international [18](#)
charging batteries [2](#), [3](#)
communications, serial
 port [28](#)
contacting Percon [iii](#)
contrast (viewport) [23](#)
cursor keys [21](#), [22](#)
cursors [16](#), [17](#)

D

disk icon [18](#)
display see [viewport](#)
dock
 Falcon 4-Slot Dock [3](#), [37–41](#)
 Falcon Dock [2](#), [31–35](#)

E

e-mail address for Percon [iii](#)

F

Falcon
 4-Slot Dock [3](#), [37–41](#)
 accessories for [2](#)
 applications [29](#)
 attaching scanner to [27](#)
 automatic shutoff [10](#)
 batteries [7](#)
 charging [2](#), [3](#)
 care and cleaning of [3](#)
 communications port [28](#)
 dock [2](#), [31–35](#)
 keypad [10–20](#)
 labeling [iv](#)
 laser [24–27](#)
 changing orientation [25](#)
 long-range [26](#)
 triggers [25](#)
 PAL [29](#)

safety information [iv](#)
serial port [28](#)
turning on and off [6](#)
viewport [21–24](#)
FCC information [v](#)
4-Slot Dock [3](#), [37–41](#)

G

getting help [iii](#)

H

help [iii](#)

I

icons [16](#), [17](#)
 battery [7](#)
input modes [14](#)
integrated laser see [laser](#)
international character set [18](#)

K

keypad [10–20](#)
 cursor keys [21](#), [22](#)
 input modes [14](#)
 international characters [18](#)
 repeating keystrokes [20](#)
keystrokes, repeating [20](#)

L

labels on Falcon [iv](#)
laser [24–27](#)
 long-range [26](#)
 module, changing orientation of [25](#)
 triggers [25](#)
light (viewport) [24](#)

lithium battery [7](#)
long-range laser [26](#)
low-battery warning [7](#)

M

modes, input [14](#)
moving the viewport display [21](#)

O

on/off key [11](#), [12](#), [21](#), [22](#)
orientation of laser module, changing [25](#)

P

PAL [29](#)
Percon, contacting [iii](#)
port, serial [28](#)
position of laser module [25](#)
power key [6](#), [11](#), [12](#), [21](#), [22](#)
power management [10](#)
product labeling [iv](#)
purchasing accessories [3](#)

R

repeating keystrokes [20](#)

S

safety information [iv](#)
scanner, attaching to Falcon [27](#)
 see also [laser](#)
serial communications
 port [28](#)
serial port [28](#)
shutoff, automatic [10](#)
support [iii](#)

T

technical support [iii](#)
timer, auto-shutoff [10](#)
triggers, laser [25](#)

V

viewport [21–24](#)
 backlight [24](#)
 contrast [23](#)
 cursors in [16](#), [17](#)
 icons in [16](#), [17](#)

W

web site, Percon [iii](#)
window see [viewport](#)

