

***DENSO***

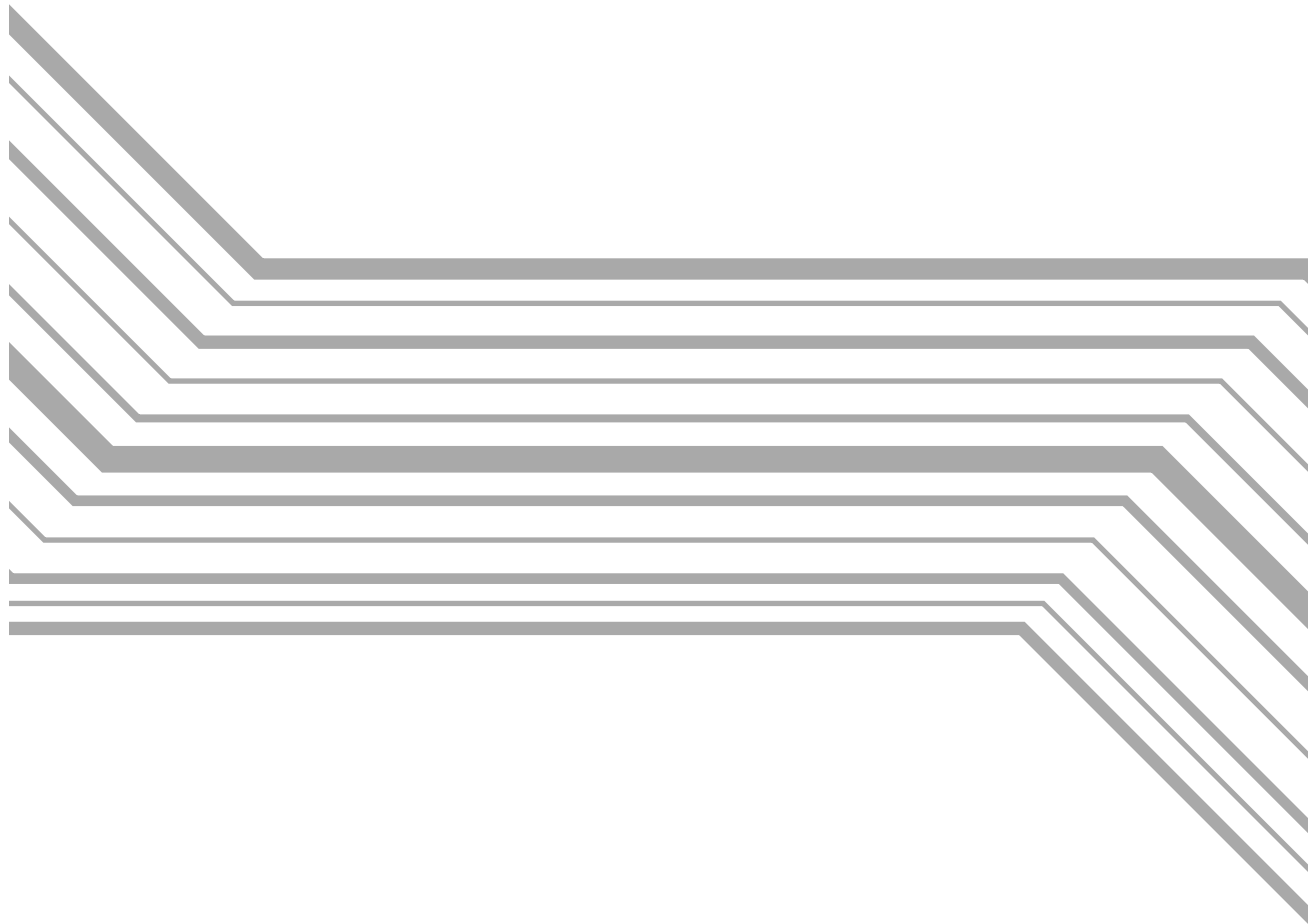

Bar Code Handy Terminal

**BHT-6000**

---

**User's Manual**

Copyright © DENSO, 1997

All rights reserved. No part of this publication may be reproduced in any form or by any means without permission in writing from the publisher.

Specifications are subject to change without prior notice.

Microsoft®, MS-DOS®, and QuickBASIC® are registered trademarks of Microsoft Corporation.

IBM®, PC/AT®, and PS/2® are registered trademarks of International Business Machines Corporation.

BHT, CU, BHT-protocol, BHT-Ir protocol, and BHT-BASIC 3.0 are trademarks of DENSO CORPORATION.

# Preface

Please READ through these operating instructions carefully. It will enable you to operate your BHT-6000 correctly.

After you have finished reading the instructions, keep this manual handy for speedy reference.

The BHT-6000 series is available in two types: the normal-range type and long-range type (BHT-6000D). In this manual, both types are called the BHT-6000 unless otherwise specified.

# **How this book is organized**

This manual is made up of five chapters and appendices.

## **Chapter 1. Quick Guide**

Describes the basic operating method of the BHT-6000 and the related notes.

## **Chapter 2. Getting Started the BHT-6000 and System Mode**

Summarizes the BHT-6000 system configuration and describes the operation including preparation and System Mode (which is required for the efficient use of application programs).

## **Chapter 3. Communications Operations of BHT-6000**

Describes the communications operations of the BHT-6000--the RS-232C interface specifications, the basic communications specifications, and the communications protocols--for data transmission with the host computer or other devices.

## **Chapter 4. Error Messages**

Lists the error messages which will appear on the LCD if some error occurs in the BHT-6000.

## **Chapter 5. Handling the CU-6000 (Option)**

Describes the handling procedure of the CU-6000, the interfacing with the host computer, and the charging of the Ni-MH battery cartridge.

## **Appendix A: Specifications**

## **Appendix B: A Typical Basic Operation**

## **Appendix C: Alphabet Input Procedure**

## ■ Related Publications

BHT-BASIC 3.0 Programmer's Manual

Transfer Utility Guide

Ir-Transfer Utility C Guide

## ■ Screen Indication

The lettering in the screens in this manual is a little different from that in the actual screens. File names used are only for description purpose, so they will not appear if you have not set files having those names.

# SAFETY PRECAUTIONS

**Be sure to observe all these safety precautions.**

- Please READ through this manual carefully. It will enable you to use the BHT-6000 and CU-6000 correctly.
- Always keep this manual nearby for speedy reference.

Strict observance of these warning and caution indications are a MUST for preventing accidents which could result in bodily injury and substantial property damage. Make sure you fully understand all definitions of these terms and related symbols given below, before you proceed to the text itself.



## **WARNING**

Alerts you to those conditions which could cause serious bodily injury or death if the instructions are not followed correctly.



## **CAUTION**

Alerts you to those conditions which could cause minor bodily injury or substantial property damage if the instructions are not followed correctly.

## **Meaning of Symbols**



A triangle (  $\triangle$  ) with a picture inside alerts you to a warning of danger. Here you see the warning for electrical shock.



A diagonal line through a circle (  $\otimes$  ) alerts you to something you should not do; it may or may not have a picture inside. Here you see a screwdriver inside the circle, meaning that you should not disassemble.



A black circle (  $\bullet$  ) with a picture inside alerts you to something you MUST do. This example shows that you MUST unplug the power cord.

## WARNING

### Handling the battery cartridge

- Never disassemble or heat the battery cartridge, nor put it into fire or water; doing so could cause battery-rupture or leakage of battery fluid, resulting in a fire or bodily injury.



- Do not carry or store the battery cartridge together with metallic ball-point pens, necklaces, coins, hairpins, etc. Doing so could short-circuit the terminal pins, causing the batteries to rupture or the battery fluid to leak, resulting in a fire or bodily injury.

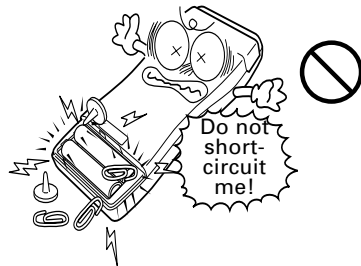

- Avoid dropping the battery cartridge or letting it undergo any shock or impact. Doing so could cause the batteries to break, generate heat, rupture or burn.



- Only use the dedicated charger (CU-6001 or C-600) for charging the Ni-MH battery cartridge. Using a different type of charger could cause battery-rupture or leakage of battery fluid and result in a fire, bodily injury, or serious damage to property.

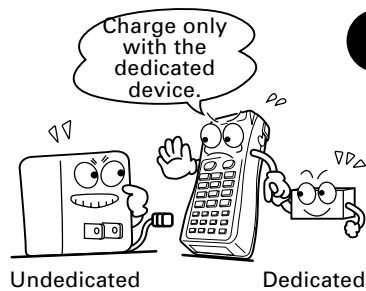

- Never charge the Ni-MH battery cartridge where any inflammable gases may be emitted; doing so could cause fire.



## WARNING

### Handling the CU

- If smoke, abnormal odors or noises come from the CU, immediately turn off the power, unplug the AC adapter from the wall socket, and contact your nearest dealer.

Failure to do so could cause fire or electrical shock.



- If foreign material or water gets into the CU, immediately turn off the power, unplug the AC adapter from the wall socket, and contact your nearest dealer.

Failure to do so could cause fire or electrical shock.



- If you drop the CU so as to damage its housing, immediately turn off the power, unplug the AC adapter from the wall socket, and contact your nearest dealer.

Failure to do so could cause fire or electrical shock.



- Never use the CU for charging anything other than the specified battery cartridges.

Doing so could cause heat, battery-rupture, or fire.



- Never bring any metals into contact with the output terminals.

Doing so could produce a large current through the CU, resulting in heat or fire, as well as damage to the CU.



- Use the furnished AC adapter only. Failure to do so could result in fire.

- Never use the CU on the line voltage other than the specified level. Doing so could cause the CU to break or burn.



- If the power cord of the AC adapter is damaged (e.g., exposed or broken lead wires), stop using it and contact your nearest dealer.

Failure to do so could result in a fire or electrical shock.





## CAUTION

### Basic handling tips

- Never put the BHT in places where there are excessively high temperatures, such as inside closed-up automobiles, or in places exposed to direct sunlight.

Doing so could affect the housing or parts, resulting in a fire.

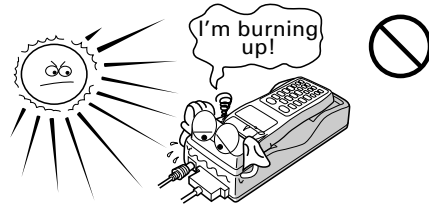

- Avoid using the BHT in extremely humid or dusty areas, or where there are drastic temperature changes.

Moisture or dust will get into the BHT, resulting in malfunction, fire or electrical shock.

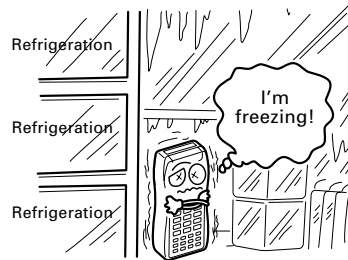
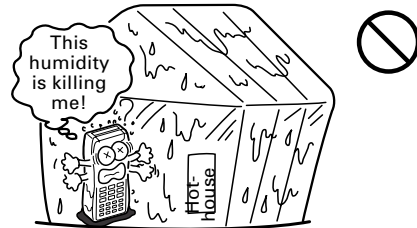

- Never disassemble or modify the BHT; doing so could result in an accident such as break or fire.



### Handling the Ni-MH battery cartridge

- Never charge a wet or damp Ni-MH battery cartridge.

Doing so could cause the batteries to break, generate heat, rupture, or burn.

### Handling the BHT

- If smoke, abnormal odors or noises come from the BHT, immediately turn off the power, pull out the dry batteries or the battery cartridge, and contact your nearest dealer.



Failure to do so could cause smoke or fire.

- If foreign material or water gets into the BHT, immediately turn off the power, pull out the dry batteries or the battery cartridge, and contact your nearest dealer.

Failure to do so could cause smoke or fire.



## CAUTION

- If you drop the BHT so as to damage its housing, immediately turn off the power, pull out the dry batteries or the battery cartridge, and contact your nearest dealer.

Failure to do so could cause smoke or fire.



- For those machines using dry batteries, do not mistake the plus and minus marks when loading dry batteries into the BHT.

Failure to do so could cause battery-rupture or leakage of battery fluid, resulting in bodily injury, fire, or property damage.



- For those machines using dry batteries, do not use anything other than the specified type of batteries, nor use new and old batteries together.

Doing so could cause battery-rupture or leakage of battery fluid, resulting in bodily injury, fire, or property damage.



- Do not use batteries or power sources other than the specified ones; doing so could generate heat or cause malfunction.



### Handling the CU

- If you will not be using the CU for a long time, be sure to unplug the AC adapter from the wall socket for safety.

Failure to do so could result in a fire.



- When caring for the CU, unplug the AC adapter from the wall socket for safety.

Failure to do so could result in an electrical shock.



- Never cover or wrap up the CU or AC adapter in a cloth or blanket.

Doing so could cause the unit to heat up inside, deforming its housing, resulting in a fire.





Always use the CU and AC adapter in a well-ventilated area.

- Do not place the CU anywhere where it may be subjected to oily smoke or steam, e.g., near a cooking range or humidifier.

Doing so could result in a fire or electrical shock.



 **CAUTION**

- Keep the power cord away from any heating equipment.  
Failure to do so could melt the sheathing, resulting in a fire or electrical shock. 
- Do not insert or drop foreign materials such as metals or anything inflammable through the openings (vents or battery cartridge slot) into the CU.   
Doing so could result in a fire or electrical shock.

- DENSO WAVE INCORPORATED does not assume any product liability arising out of, or in connection with, the application or use of any product, circuit, or application described herein.

- Intellectual Property Precaution

DENSO WAVE INCORPORATED ("DENSO WAVE") takes reasonable precautions to ensure its products do not infringe upon any patent or other intellectual property rights of other(s), but DENSO WAVE cannot be responsible for any patent or other intellectual property right infringement(s) or violation(s) which arise from (i) the use of DENSO WAVE's product(s) in connection or in combination with other component(s), product(s), data processing system(s) or equipment or software not supplied from DENSO WAVE; (ii) the use of DENSO WAVE's products in a manner for which the same were not intended nor designed; or (iii) any modification of DENSO WAVE's products by other(s) than DENSO WAVE.

## ■ Proper Care of the BHT and CU

Clean the housing, charge terminals, and battery cartridge terminals with a dry, soft cloth. (When taking care of the CU-6000, unplug the AC adapter from the wall socket for safety.)

- Never use benzene, alcohol, or other organic solvents. The housing may be marred or the paint may come off.
- Never rub or strike the liquid crystal display (LCD) with anything hard. The LCD surface will be easily scratched or broken.
- When cleaning the keypad, do not scrub the surface too hard, and do not pull on the keys. Doing so may break the keys or cause the keypad to dislocate.
- If the BHT or CU becomes smudged, moisten a soft cloth with neutral detergent and wring it out thoroughly. Wipe the BHT or CU with the cloth and then go over it again with a dry cloth.



Dust or dirt accumulating on the clear plate of the bar-code reading window will affect reading performance. If you use the BHT-6000 in dusty areas, therefore, periodically check the clear plate of the bar-code reading window and clean it if dusty.

- To clean the plate, first blow the dust away with an air brush. Then wipe the plate with a cotton swab or the similar soft one gently.
- If sand or hard particles have accumulated, never rub the plate; doing so will scratch or damage it. Blow the particles away with an air brush or a soft brush.

## ■ Limited Warranty on Software Products

In no event will DENSO WAVE be liable for direct, indirect, special, incidental, or consequential damages (including imaginary profits or damages resulting from interruption of operation or loss of business information) resulting from any defect in the software or its documentation or resulting from inability to apply the software or its documentation.

# Content Overviews

<b>Preface</b> .....	<b>i</b>
<b>How this book is organized</b> .....	<b>ii</b>
<b>SAFETY PRECAUTIONS</b> .....	<b>iv</b>
<b>Chapter 1. Quick Guide</b> .....	<b>1</b>
1.1 Reading Bar Codes .....	2
1.2 Using the Hand Strap and Clip .....	3
1.3 Setting the Backlight .....	4
1.4 Using the Keypad .....	5
1.5 Communicating via the Optical Interface .....	6
<b>Chapter 2. Getting Started the BHT-6000 and System Mode</b> .....	<b>7</b>
2.1 BHT-6000 System Configuration .....	8
2.2 Infrared Communications .....	13
2.3 Components and Functions .....	14
2.4 Preparation .....	16
2.4.1 Setting-up 1: Loading Dry Batteries or Battery Cartridge .....	16
2.4.2 Setting-up 2: Initializing the BHT-6000 and Setting the Calendar Clock .....	21
2.4.3 Adjusting the LCD Contrast & Beeper Volume, and Displaying the Battery Voltage Level .....	27
2.5 Operating in System Mode .....	29
2.5.1 Starting System Mode .....	29
2.5.2 Operating in System Mode .....	32
2.5.3 Detailed Description of the Functions in System Mode .....	34
<b>Chapter 3. Communications Operations of BHT-6000</b> .....	<b>81</b>
3.1 RS-232C Interface Specifications .....	82
3.2 Basic Communications Specifications and Parameters .....	84
3.2.1 Basic Communications Specifications .....	84
3.2.2 Communications Parameters .....	86
3.3 Communications Protocols .....	87
3.3.1 BHT-protocol .....	87
3.3.2 BHT-Ir Protocol .....	103

<b>Chapter 4. Error Messages</b> .....	<b>121</b>
4.1 System Errors .....	122
4.2 Errors in System Mode .....	126
<b>Chapter 5. Handling the CU-6000 (Option)</b> .....	<b>133</b>
5.1 Functions of the CU-6000 .....	134
5.2 Components and Functions .....	134
5.3 Applying Power to the CU-6001 .....	136
5.4 Communicating with the Host Computer.....	137
5.4.1 Setting the Transmission Speed of the CU-6000 .....	137
5.4.2 Interface Cable Connection .....	137
5.4.3 Interfacing with the Host Computer .....	138
5.5 Charging the Ni-MH Battery Cartridge (using the CU-6001) .....	139
5.5.1 Ni-MH Battery Cartridge Loaded in the BHT-6000 .....	139
5.5.2 Ni-MH Battery Cartridge Alone .....	141
5.6 RS-232C Interface Specifications .....	144
<b>Appendices</b> .....	<b>147</b>
Appendix A. Specifications .....	148
A.1 BHT-6000 .....	148
A.2 CU-6000 .....	154
Appendix B. A Typical Basic Operation .....	156
Appendix C. Alphabet Input Procedure .....	157
<b>Index</b> .....	<b>159</b>

**Chapter 1. Quick Guide**



**Chapter 2. Getting Started the BHT-6000 and System Mode**



**Chapter 3. Communications Operations of BHT-6000**



**Chapter 4. Error Messages**



**Chapter 5. Handling the CU-6000 (Option)**



**Appendices**

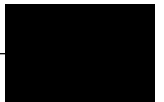

# Chapter 1

## Quick Guide

This chapter describes the basic operating method of the BHT-6000 and the related notes.

1.1	Reading Bar Codes .....	2
1.2	Using the Hand Strap and Clip .....	3
1.3	Setting the Backlight .....	4
1.4	Using the Keypad .....	5
1.5	Communicating via the Optical Interface .....	6



# 1.1 Reading Bar Codes

Turn on the BHT power, bring the bar-code reading window up to the bar code to be scanned, and press the **M1** or **M2** key (Magic key 1 or 2)\*. The BHT-6000 lights the illumination LED and reads the bar code.

When the BHT-6000 has read the bar code successfully, the reading confirmation LED will illuminate in green.

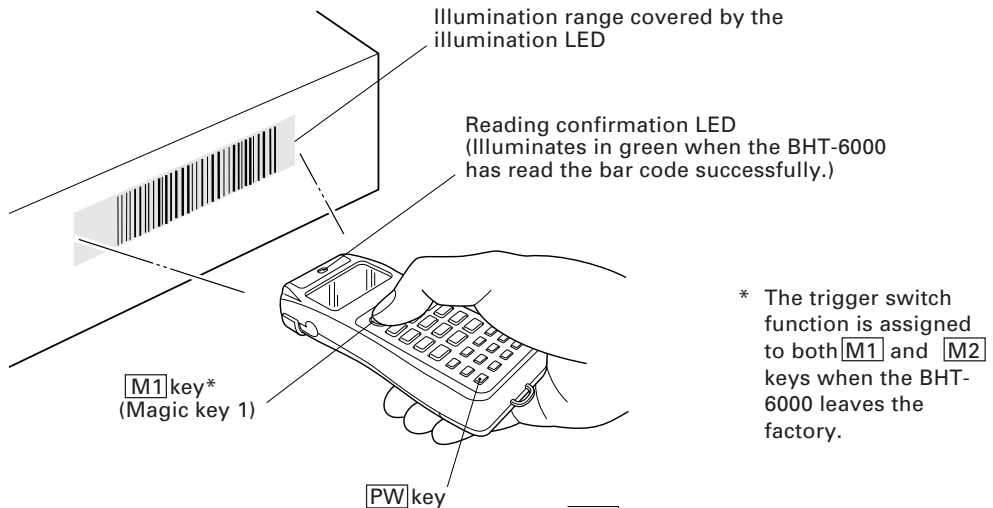

- When reading bar codes, slightly tilt the BHT-6000 down towards you relative to those codes, as illustrated at right.
- If the BHT-6000 fails to read, change the reading angle of the bar-code reading window or the distance from bar codes, and try it again.
- To read bar codes wider than the readable area of the bar-code reading window, pull the bar-code reading window away from bar codes for long-range scanning so that the entire bar code comes into the illumination range covered by the illumination LED. The BHT-6000 can read bar codes at a maximum distance of 24 cm (9.4") [35 cm (13.8")]\*\* from the bar-code reading window.

\*\* Under the following conditions:  
- Ambient illuminance: 500 lux (fluorescent lamp)  
- ITF conforming to the UPC Shipping Container Code  
- PCS value: 0.9 or more  
- Minimum narrow bar width: 1.2 mm min. (47.2 mils min.)

- The bar code reading procedure may differ depending upon the application used, so follow the application's manual.

## NOTE

- Before reading labels, clean them if stained.
- Avoid using the BHT-6000 in direct sunlight. The BHT-6000 might fail to read correctly.
- To read bar codes on curved surfaces, apply the bar-code reading window to the center of each bar code at a right angle.
- The further you pull the bar-code reading window away from bar codes, the wider the quiet zones required, in relation to bar code lengths in the illumination range covered by the illumination LED.

# 1.2 Using the Hand Strap and Clip

## ■ Using the hand strap

As shown below, set the hand strap, and then put your hand through the hand strap and hold the BHT-6000. This will prevent you from dropping the BHT-6000 accidentally.

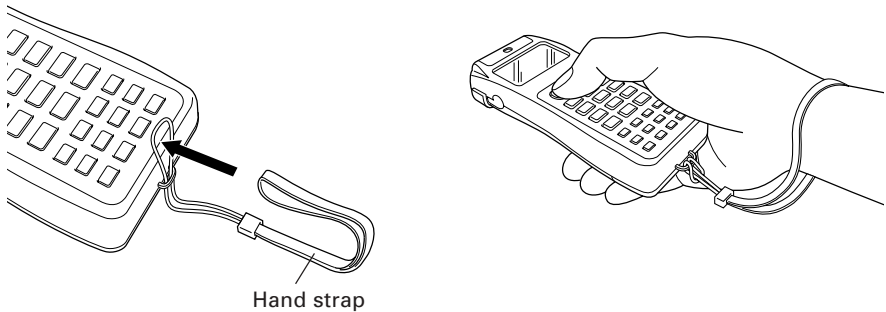

## ■ Using the clip

### Attaching the clip

As illustrated below, first fit the left (or right) tab of the clip into the matching groove of the BHT body and then snap the other tab into place.

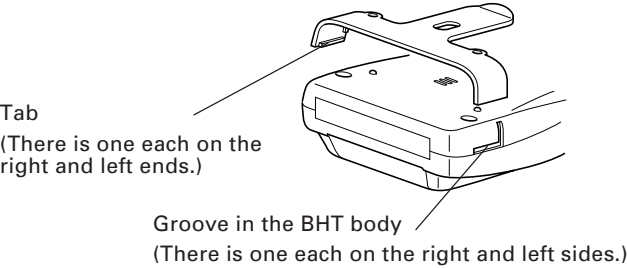

### Using the clip

With the clip, you can clip the BHT-6000 on your pocket.

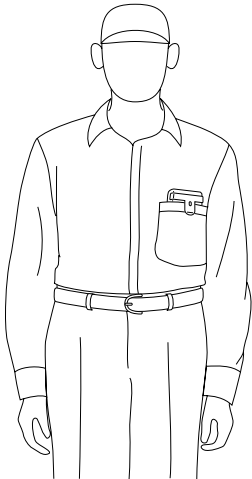

### Removing the clip

Insert the tip of a flat-head screwdriver between the clip and BHT body as shown below, and then twist the screwdriver to disengage the clip, taking care not to scratch the BHT.

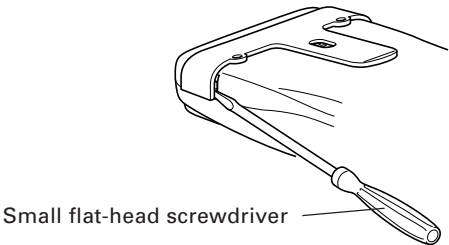

# 1.3 Setting the Backlight

Pressing the **M1** key while holding down **SF** (Shift) key activates or deactivates the backlight function.

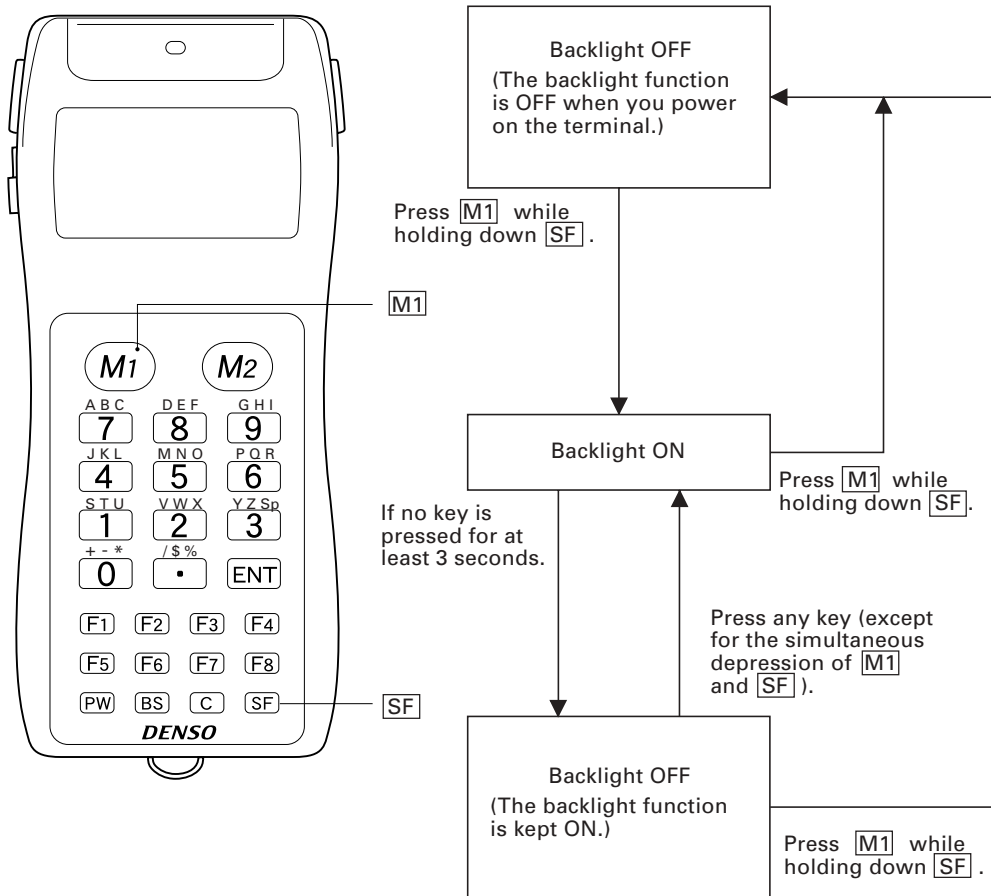

**NOTE**

In user programs, you can select the key to be used for activating or deactivating the backlight function (instead of the default: combination of **SF** and **M1**), as well as modifying the ON-duration of the backlight before the automatic turning-off.

## 1.4 Using the Keypad

### ■ Entering Numerical Data

To enter numerical data, e.g., the quantity of goods, use the ten numerical keys and the **ENT** key.

For example, to enter the number "120," press the **1**, **2** and **0** keys and then press the **ENT** key.

If you key in any wrong value, press the **C** key (or press the **C** key while holding down the **SF** key) and then enter the correct one.

### ■ Selecting Tasks

If the LCD shows the selection items (xxx) prefixed by numerals (e.g., 1: xxx, 2: xxx), use the numerical keys to select a desired item and press the **ENT** key to execute.

If a YES/NO screen (e.g., 1: YES, 2: NO) appears, press the **1** key for YES response and **2** key for NO response.

### ■ Entering Alphabetic Characters

The BHT-6000 supports the alphabet input function which allows you to enter alphabetic characters, space, and symbols from the keypad during execution of a user program. For the alphabet input procedure, refer to Appendix C.

# 1.5 Communicating via the Optical Interface

## ■ Optical Communications with the BHT-6000

The BHT-6000 communicates using an IR beam, so make sure that there is no obstruction in the light path between the BHT-6000 and any target stations.

In the IrDA communications mode, you need to keep the BHT-6000 and any target stations within the effective light emission range, usually 10 to 80 cm.

## ■ Communicating with the CU-6000

The optional CU-6000 is an IrDA-compliant communications unit. For optical communications, you may either keep the BHT-6000 and CU-6000 separated by 10 to 80 cm with their IR ports facing each other, or put the BHT-6000 directly on the CU-6000 as shown below.

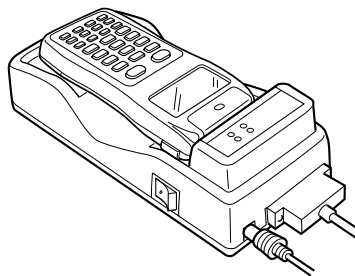

## ■ Communicating with other IrDA-compliant equipment

You can also have the BHT-6000 communicate with other IrDA-compliant equipment just by aligning their IR ports with each other. The effective IR range and IR port angle may differ depending upon the target equipment, so observe the instructions given in manuals furnished with such equipment.

If transfer using the BHT-6000 fails, bring it closer to the target station or change the IR port angle, and try again.

**NOTE**

Communications failures might be caused by highly intensive light emitted from ceiling (inverter-driven fluorescent) lamps or direct sunlight. Take care to prevent such interference light from coming into the IR ports of the BHT-6000 and IrDA-compliant equipment, including the CU-6000.

**NOTE**

Do not use any TV remote control in the vicinity of the IR communications system. Doing so may interfere with the communications.

# Chapter 2

## Getting Started the BHT-6000 and System Mode

This chapter summarizes the BHT-6000 system configuration and describes the operation including preparation and System Mode (which is required for the efficient use of application programs).

2.1	BHT-6000 System Configuration .....	8
2.2	Infrared Communications .....	13
2.3	Components and Functions .....	14
2.4	Preparation .....	16
2.4.1	Setting-up 1: Loading Dry Batteries or Battery Cartridge .....	16
2.4.2	Setting-up 2: Initializing the BHT-6000 and Setting the Calendar Clock .....	21
	[ 1 ] Initializing the BHT-6000 .....	21
	[ 2 ] Setting the Calendar Clock (date and time) .....	24
	[ 3 ] Deleting the JIS Font Files .....	26
2.4.3	Adjusting the LCD Contrast & Beeper Volume, and Displaying the Battery Voltage Level .....	27
	[ 1 ] Adjusting the LCD Contrast & Beeper Volume .....	27
	[ 2 ] Displaying the Battery Voltage Level .....	28
2.5	Operating in System Mode .....	29
2.5.1	Starting System Mode .....	29
2.5.2	Operating in System Mode .....	32
	[ 1 ] Calling up the desired set screen .....	32
	[ 2 ] Selecting a desired setting .....	33
2.5.3	Detailed Description of the Functions in System Mode .....	34
	[ 1 ] Program Execution .....	34
	[ 2 ] Downloading .....	35
	[ 3 ] Uploading .....	39
	[ 4 ] System Environment Setting .....	42
	[ 5 ] Testing .....	59
	[ 6 ] Version Indication .....	71
	[ 7 ] Deleting Files .....	71
	[ 8 ] Copying Files .....	73
	[ 9 ] Handling the JIS Font Files .....	75

## 2.1 BHT-6000 System Configuration

The BHT-6000 barcode data collection system requires the following hardware as well as the BHT-6000 Bar Code Handy Terminal (which reads bar codes and accepts keypad entry) as illustrated below:

- Host computer: Allows you to edit, manage and download programs and data, as well as downloading extension programs.

For host computers without IrDA interface ports, the optional CU-6000 optical communications unit and RS-232C interface cable are available.

- CU-6000 (option): Exchanges programs and data with the BHT-6000 optically and with the host computer via the RS-232C interface.
- RS-232C interface cable: Connects the CU-6000 and the host computer.

The basic software required for operating the BHT-6000 is "System Mode" which is resident in the flash ROM.

Optional software includes the BHT-BASIC 3.0 Extension Library, BHT-BASIC 3.0 Compiler, Ir-Transfer Utility C, and Transfer Utility. (Each software is provided in a floppy disk.)

### System Configuration

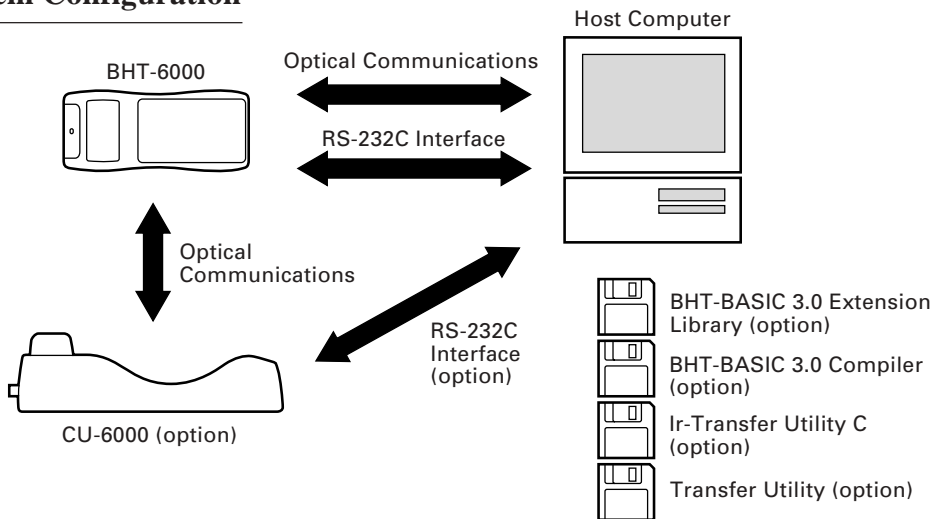

#### ■ Host Computer

OS: MS-DOS Ver. 3.1 or later

RAM: 640 kilobytes. At least 400-kilobyte area should be reserved as a work area.

Models: IBM PC/AT, PS/2

### ■ CU-6000 and RS-232C Interface Cable (option)

The CU-6000 is an IrDA-compliant communications unit which is required when your host computer is not equipped with an IrDA interface port. The CU-6000 exchanges data and programs with the BHT-6000 optically, and with the host computer via the RS-232C interface cable.

You may directly connect two BHT-6000s with each other by using a commercially available metal cable having 3-pole mini stereo plugs (as a direct-connect interface cable). You also connect the BHT-6000 directly with the host computer or with the modem by using the direct-connect interface cable compatible with the target equipment. (NOTE: The direct-connect interface port of the BHT-6000 is not designed to stand frequent connecting/disconnecting. You are, therefore, recommended to use the CU-6000 where you expect to do a lot of connecting and disconnecting of the BHT-6000 to/from a host computer.)

### ■ BHT-BASIC3.0 Extension Library (option)

This Extension Library enables the following functions which cannot be handled by the ordinary system:

- Displaying ruled lines on the BHT-6000's LCD
- Transmitting files by using the X-MODEM and Y-MODEM protocols.

These extension programs are stored in files named xxxx.FN3, in each file per function. You should download a xxxx.FN3 file containing the necessary function to the BHT-6000 by using Ir-Transfer Utility C or Transfer Utility.

### ■ BHT-BASIC 3.0 Compiler (option)

This Compiler compiles a source program written in BHT-BASIC 3.0 by an editor of the host computer running the MS-DOS, into the object program (user program) which can be used in the BHT-6000. The compiled program file is named "XXX.PD3." (XXX: File name you can set arbitrarily under the MS-DOS rules) You should download it to the BHT-6000 by using Ir-Transfer Utility C or Transfer Utility.

### ■ Ir-Transfer Utility C (option)

Running on the host computer, this utility transfers files between the BHT-6000 and the host computer. For its file transfer control procedure, the utility uses the BHT-Ir protocol which complies with the serial IR physical layer standards of IrDA Serial Infrared Data Link Standard, Version 1.0 (IrDA-SIR 1.0). (For the details about the BHT-Ir protocol, refer to Chapter 3, Subsection 3.3.2.)

To transfer files under any of the following conditions, use Ir-Transfer Utility C:

- At transmission speeds of 115200 or 57600 bps (This may be impossible depending upon the host computer type.)
- When the BHT-6000 is separated from the CU-6000
- When the BHT-6000 is placed on the CU-6000
- When transferring via the direct-connect interface of the BHT-6000 (Maximum transmission speed is 38400 bps.)



## ■ Transfer Utility (option)

Running on the host computer, this utility transfers files between the BHT-6000 and the host computer. It uses the BHT-protocol as a file transfer control procedure. (For the details about the BHT-protocol, refer to Chapter 3, Subsection 3.3.1.)

To transfer files under any of the following conditions, use Transfer Utility:

- When the BHT-6000 is placed on the CU-6000
- Via the direct-connect interface of the BHT-6000

---

## Flash ROM and RAM

A flash ROM and RAM are mounted on the BHT-6000.

The flash ROM stores factory-written System Program and JIS Level 1 & Level 2 fonts.

You can download extension programs, user programs, and user data to either or both of the flash ROM and RAM.

## ■ RAM

Programs and data stored in the RAM are backed up by a lithium battery integrated in the BHT-6000. If the battery voltage level drops below the specified level, the RAM cannot retain its contents so that the stored files may be damaged.

User programs can write data onto the RAM only.

In System Mode, the RAM is shown as "DRIVE A" or "A:" on the LCD. The names of those files stored in the RAM are prefixed by "A:."

## ■ Flash ROM

Unlike the RAM, the flash ROM retains the stored programs and data irrespective of the voltage level of the lithium battery. The flash ROM is limited in the frequency of rewriting operations; frequent file rewriting exceeding approx. 10,000 times will no longer allow rewriting. Do not rewrite the flash ROM basically more than one time a day.

You can write data onto the flash ROM according to any of the following:

- Downloading a file in System Mode
- Copying a file from the RAM in System Mode
- Downloading a file by using XFILE statement in BHT-BASIC 3.0.

You cannot write data scanned with the BHT-6000, onto the flash ROM.

In System Mode, the flash ROM is shown as "DRIVE B" or "B:" on the LCD. The names of those files stored in the flash ROM are prefixed by "B:."

## Software Structure

System Program and JIS Level 1 & Level 2 fonts are resident in the system area of the flash ROM.

To use extension programs and user programs, you should download the program files into the user area (of the flash ROM or RAM).

Before the execution of user programs, you need to prepare a data file. The data files will be stored in the user area (of the flash ROM or RAM).

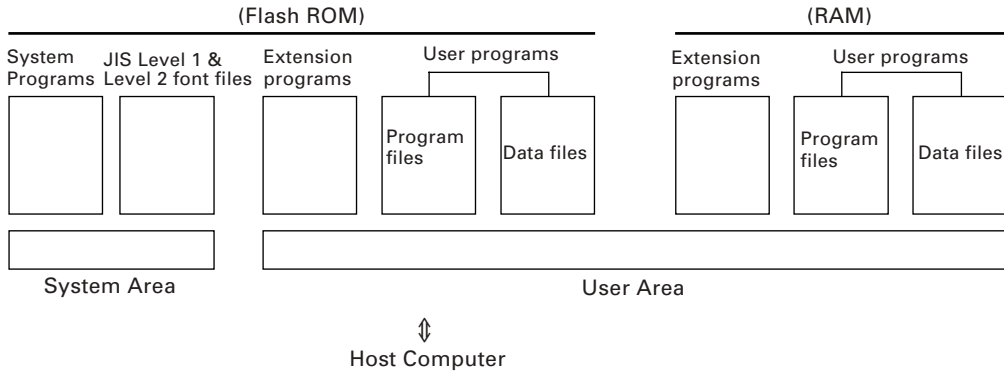

### ■ System Programs

The system programs include the following three sets of programs:

#### Drivers

Drivers is a set of programs that directly controls the BHT-6000 hardware. It may be called up by the BHT-BASIC 3.0 Interpreter or System Mode.

#### BHT-BASIC 3.0 Interpreter

The interpreter interprets and executes instructions in user programs written in BHT-BASIC 3.0.

#### System Mode

System Mode is a system program exclusively designed for the effective use of user programs in the BHT-6000. It sets up the execution environments for those programs; e.g., it prepares downloading/uploading conditions, sets the calendar clock, and tests the BHT-6000 components including the LCD, beeper, and keypad. Shown below is the System Mode menu (SYSTEM MENU).

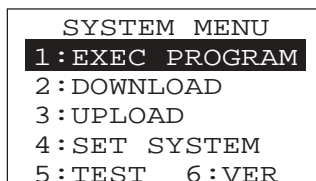

## ■ JIS Level 1 and Level 2 Font Files

These files contain font data required for displaying Kanji characters on the LCD.

The BHT-6000 has no Kanji ROM, so it stores Kanji fonts in the flash ROM.

The BHT-6000 can display not only the Kanji characters in the conventional standard-size font (16 dots wide by 16 dots high) but also them in the small-size font (12 dots wide by 12 dots high) in application programs.

## ■ Extension Programs

These programs extend the system programs by adding new functions which cannot be handled by the ordinary system.

To download desired extension programs in the BHT-BASIC Extension Library, you need to use Ir-Transfer Utility C or Transfer Utility.

## ■ User Programs

You can develop application programs to meet individual job requirements by using the BHT-BASIC 3.0 Compiler. To download those user programs to the BHT-6000, use Ir-Transfer Utility C or Transfer Utility.

## 2.2 Infrared Communications

The BHT-6000 has an integrated infrared (IR) communications device which enables wireless transfer of programs and data between the BHT-6000 and the host computer and between the BHT-6000s, instead of the conventional wire transfer.

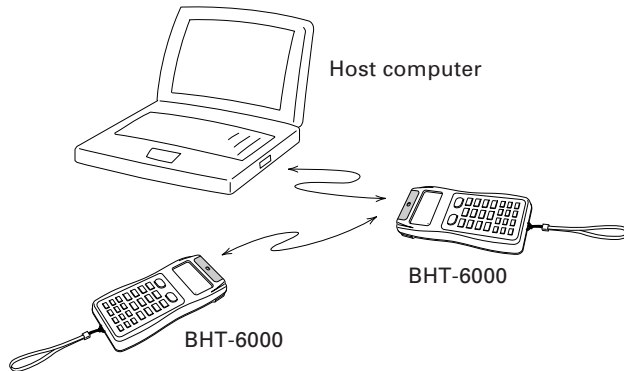

The IR communications device features the following:

- Wireless communications
- Small and lightweight design
- High transmission speed
- Freedom from the codes/regulations and licenses which differ from country to country, unlike radio devices

The BHT-6000's IR communications device is IrDA-compliant. IrDA stands for Infrared Data Association, which has defined hardware (IrDA Serial Infrared Physical Layer Link, IrDA-SIR) and communications protocols for IR communications.

The BHT-6000's physical layer complies with the IrDA-SIR 1.0, with a maximum transfer distance of 1 m and maximum transmission rate of 115.2 kbits per second.

The BHT-6000 adopts the exclusive BHT-Ir protocol which allows you to develop user programs for IR communications in BHT-BASIC 3.0, as can be done with conventional wire communications.

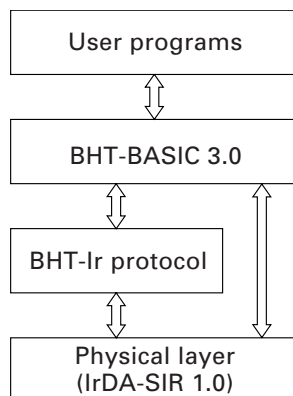

## 2.3 Components and Functions

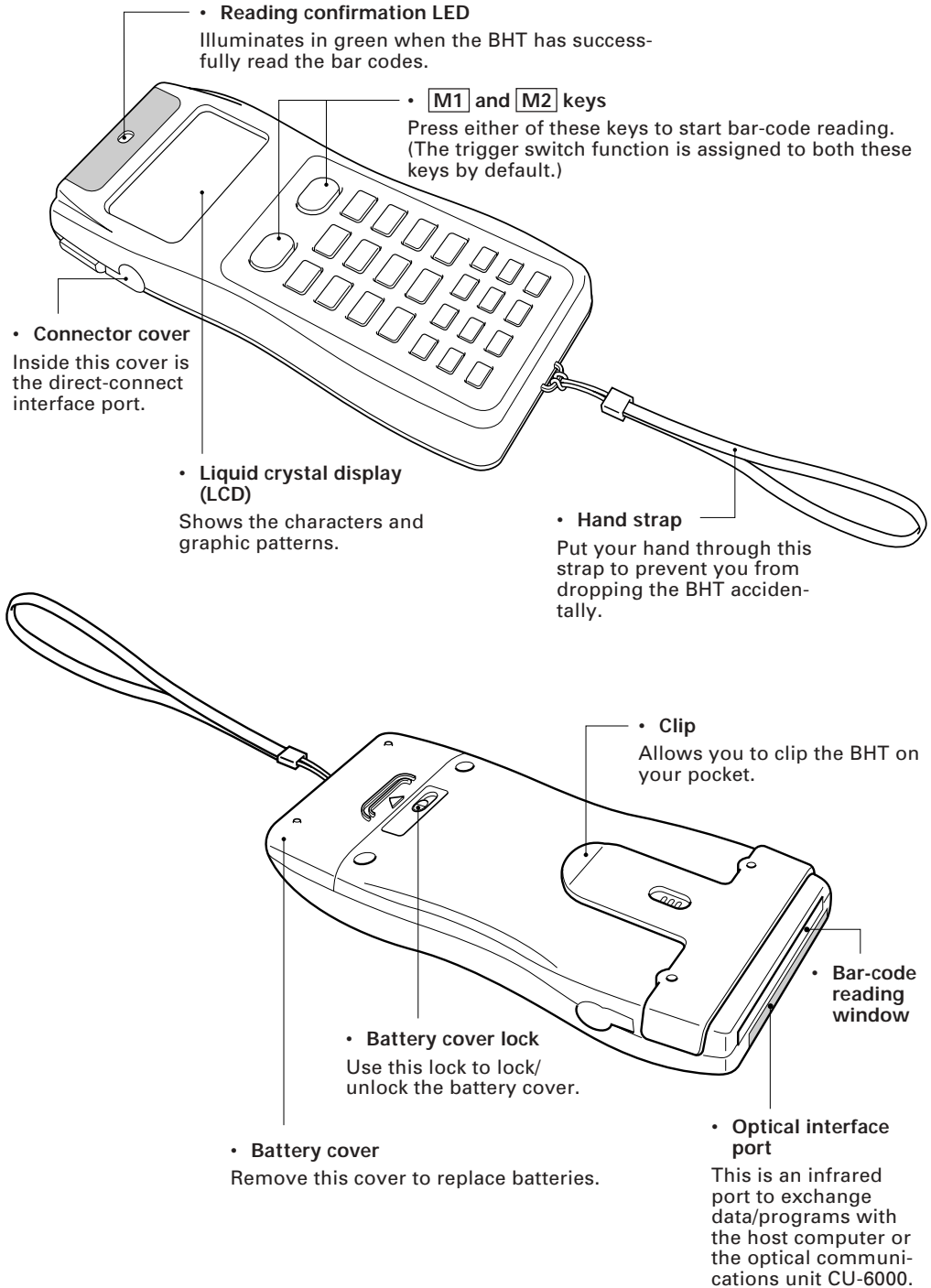

The functions of the keys may be set by user programs. Shown below is a set of sample functions.

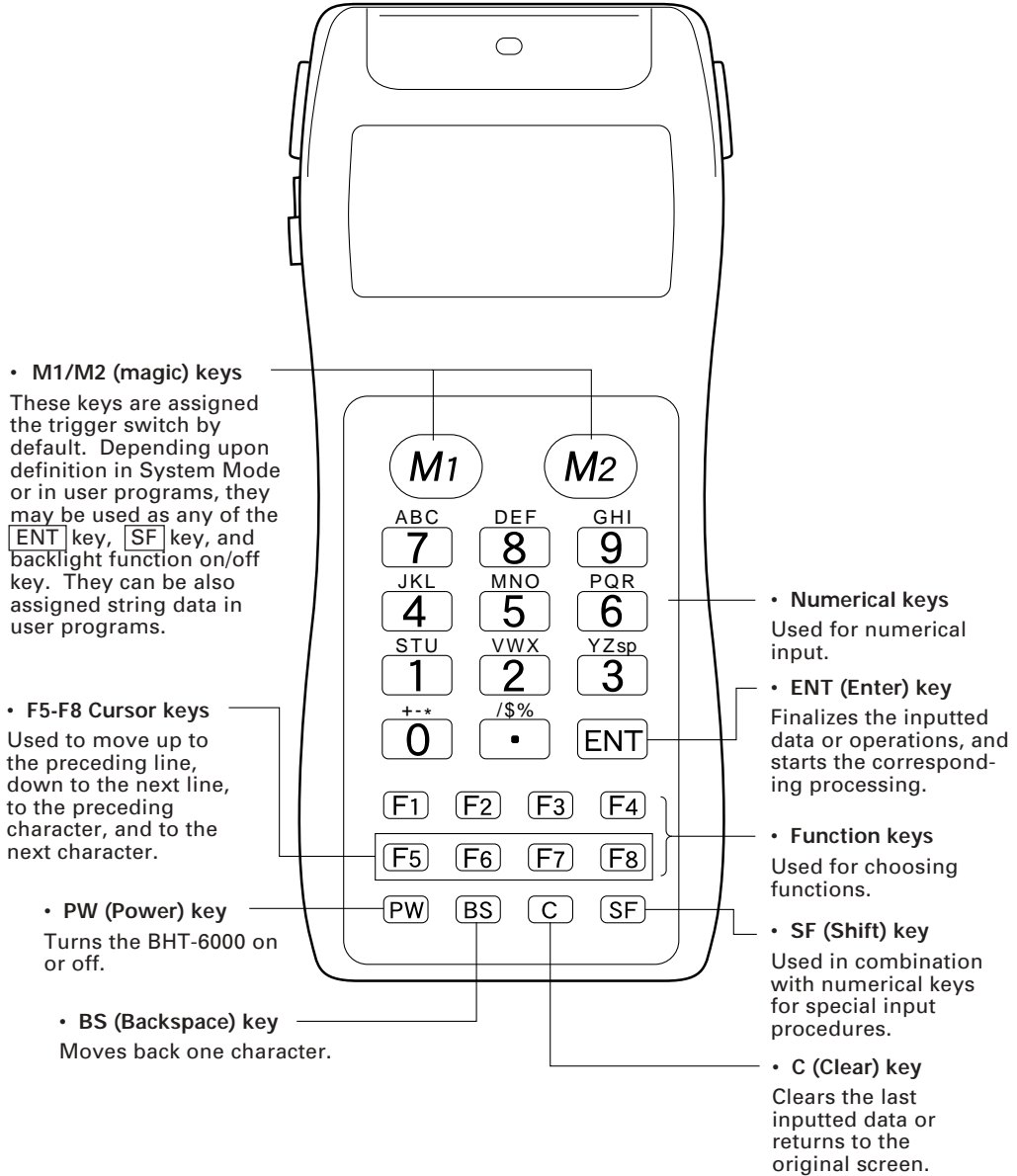

## 2.4 Preparation

### 2.4.1 Setting-up 1: Loading Dry Batteries or Battery Cartridge

Before the first use of the BHT-6000, be sure to load dry batteries or battery cartridge as shown below. Dry batteries or battery cartridge is not loaded in the BHT-6000 when shipped from the factory.

#### Loading dry batteries

- (1) Turn the BHT-6000 upside down.
- (2) As shown below, slide the battery cover lock in the direction of the arrow and remove the battery cover.
- (3) Check the polarity (positive and negative) of two new LR03 batteries and load them.
- (4) Put the battery cover back into place taking care not to pinch the battery pull strap between its cover and the bottom cover. Then, return the battery cover lock to its original position.

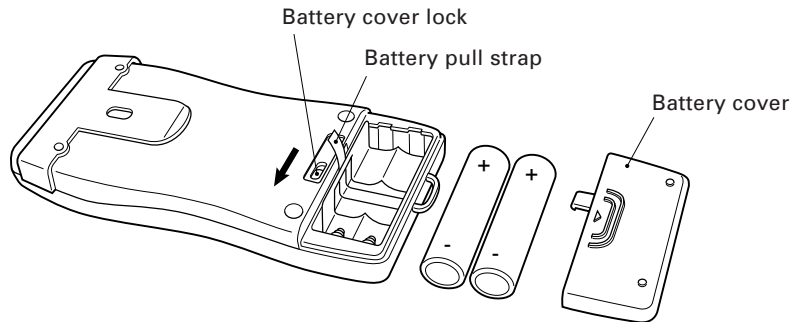

#### Loading the battery cartridge

**NOTE**

To use the battery cartridge, you need to remove the dry battery support from the BHT-6000 and replace the battery cover with the battery cartridge cover (sold separately). The battery cartridge cover has an opening for charge terminals.

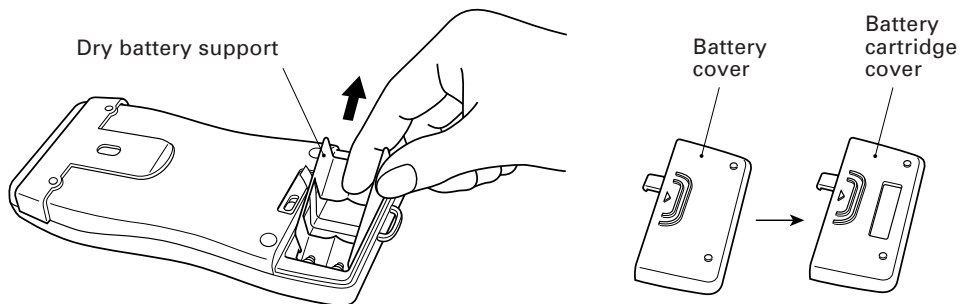

- (1) Charge the Ni-MH battery cartridge, referring to Section 5.5, "Charging the Ni-MH Battery Cartridge."
- (2) Turn the BHT-6000 upside down.

- (3) As shown below, slide the battery cover lock in the direction of the arrow and remove the battery cartridge cover.
- (4) Check the polarity (positive and negative) of the battery cartridge. Then, load it so that the end of the battery pull strap appears above the battery cartridge as shown below. This facilitates easy removal of the battery cartridge.
- (5) Put the battery cartridge cover back into place taking care not to pinch the battery pull strap between its cover and the bottom cover. Then, return the battery cover lock to its original position.

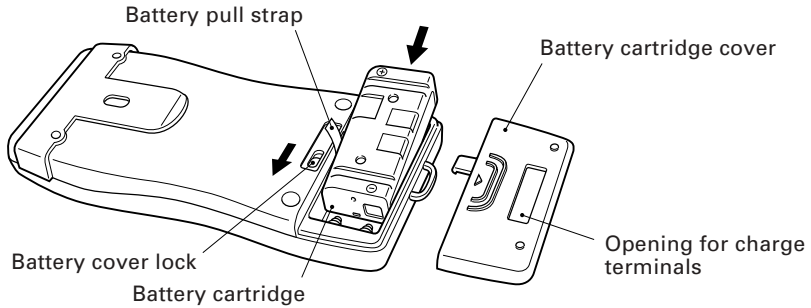

**NOTE**

The Ni-MH battery cartridge is sold either in a set with its cover or by itself. Purchase the set with the cover if this is the first time the battery is being used.

<p><b>⚠ WARNING</b></p>	<ul style="list-style-type: none"> <li>• Never disassemble or heat the battery cartridge, nor put it into fire or water; doing so could cause battery-rupture or leakage of battery fluid, resulting in a fire or bodily injury. <span style="float: right;">⊘</span></li> <li>• Do not carry or store the battery cartridge together with metallic ball-point pens, necklaces, coins, hairpins, etc. <span style="float: right;">⊘</span> Doing so could short-circuit the terminal pins, causing the batteries to rupture or the battery fluid to leak, resulting in a fire or bodily injury.</li> <li>• Avoid dropping the battery cartridge or letting it undergo any shock or impact. <span style="float: right;">⊘</span> Doing so could cause the batteries to break, generate heat, rupture or burn.</li> <li>• Never charge the Ni-MH battery cartridge where any inflammable gases may be emitted; doing so could cause fire. <span style="float: right;">⊘</span></li> </ul>
<p><b>⚠ CAUTION</b></p>	<ul style="list-style-type: none"> <li>• Do not use batteries or power sources other than the specified ones; doing so could generate heat or cause malfunction. <span style="float: right;">⊘</span></li> </ul>



NOTE

When you first load batteries (or battery cartridge) after purchase or you load them (it) after leaving the BHT-6000 unused for a long time, do not remove the batteries (battery cartridge) within 24 hours after that loading.

NOTE

Do not leave the BHT-6000 with no batteries or battery cartridge loaded for a long time. Doing so may cause loss of memory contents as well as a system error while showing the message "System error! Contact your administrator. Note the error drive. (DRIVE X)" on the LCD.

NOTE

When disposing of the battery cartridge, cover the terminal pins with vinyl tape to prevent short-circuit.

NOTE

An early upload of gathered data is recommended, since the data stored in the RAM might be affected by the so-called "soft error" or other environmental phenomena.

REFERENCE

The BHT-6000 has an integrated rechargeable lithium battery which backs up the memory in the BHT-6000 when no batteries or battery cartridge is loaded or the voltage level of the batteries or battery cartridge drops below the specified level. The lithium battery is automatically charged by the batteries or battery cartridge.

## ■ Checking the Battery Voltage Level

Pressing the **ENT** key while holding down the **SF** key displays the current voltage level of the batteries or battery cartridge as a bar indicator on the LCD. (Releasing those keys will erase the indication.)

For details, refer to Subsection 2.4.3, "Adjusting the LCD Contrast & Beeper Volume, and Displaying the Battery Voltage Level."

## ■ Low Battery Indication

If the battery voltage level drops below the specified level while the BHT-6000 is in operation, the BHT-6000 displays the following message on the LCD, beeps five times, and turns itself off automatically.

- When driven by dry batteries

A rectangular box representing an LCD screen. Inside the box, the text "Replace the batteries!" is displayed in a monospaced font, centered horizontally and vertically. The text is arranged in two lines: "Replace the" on the top line and "batteries!" on the bottom line.

If either of the above messages appears, immediately turn the power off and then replace the batteries.

### NOTE





- Before battery replacement, be sure to turn the power off. Within three minutes from the removal of batteries, you should load new batteries to avoid data loss. After replacement, turn the power on and check the operation.
- Be sure to put in two new alkaline manganese batteries (LR03).
- If the BHT-6000 is not to be used for one month or more, remove the batteries. Upload the data stored in the BHT-6000 memory to the host computer if necessary; otherwise, the stored data will be lost.

- When driven by the Ni-MH battery cartridge

Charge the  
battery!

If either of the above messages appears, immediately turn the power off, and then charge the Ni-MH battery cartridge or replace it with a fully charged one.

You may charge the Ni-MH battery cartridge with the optional CU-6001 communications unit or C-600 quick charger. For the charging procedure using the CU-6001, refer to Chapter 5. For that using the C-600, refer to the "C-600 User's Manual."

 <b>WARNING</b>	<p>Only use the dedicated charger (CU-6001 or C-600) for charging the Ni-MH battery cartridge.</p> 
 <b>CAUTION</b>	<p>Never charge a wet or damp Ni-MH battery cartridge.</p> <p>Doing so could cause the batteries to break, generate heat, rupture or burn.</p> 

## 2.4.2 Setting-up 2: Initializing the BHT-6000 and Setting the Calendar Clock

### [ 1 ] Initializing the BHT-6000

Power on the BHT-6000 by pressing the **PW** key.

Either of the following messages will appear, either in English or Japanese.

```
System error!  
Contact your  
  administrator.  
Note the  
  error drive.  
  (DRIVE A)
```

```
ファイルシステム  
の異常です。(A)  
管理者に連絡して  
ください。
```

```
System error!  
Contact your  
  administrator.  
Note the  
  error drive.  
  (DRIVE B)
```

```
ファイルシステム  
の異常です。(B)  
管理者に連絡して  
ください。
```

Proceed to the initialization procedure given on the following pages. The initialization procedure does not initialize the system area of the flash ROM.

In the following cases, one of the above messages will appear. In such instances, it is necessary to initialize the BHT-6000.

- The BHT-6000 is first powered on from the time of purchase.
- The BHT-6000 is powered on after being discharged completely.

(1) Selecting the memory area to be initialized

```
INITIALIZE
 1:ALL
 2:DRIVE A
 3:DRIVE B
```

Press the **PW** key while holding down the **SF**, **M1** and **0** keys together.

The screen shown at left will appear.

**1** ALL : Initializes both the flash ROM (except for its system area) and RAM. This should be chosen when you first power on the BHT-6000 from the time of purchase.

**2** DRIVE A : Initializes the RAM only.

**3** DRIVE B : Initializes the flash ROM only (except for its system area).

Select a desired item by using the numerical keys, then press the **ENT** key.

REFERENCE

If the message "System error! Contact your administrator. Note the error drive. (DRIVE A)" appears on the LCD, select "2: DRIVE A" to initialize the RAM.

If the message "System error! ..... (DRIVE B)" appears, select "3: DRIVE B" to initialize the flash ROM.

(2) Confirming the memory area selected for initialization

```
INITIALIZE
 (ALL)
OK ?
1:Yes 2:No
```

Selecting the memory area in step (1) above will call up the confirmation screen shown at left where you check the selected memory area on the 2nd line.

**1** Yes : Shifts to the message version selection screen before executing initialization.

**2** No : Cancels initialization and turns the power off.

Select a desired item by using the numerical keys, then press the **ENT** key.

To return to the previous screen, press the **C** key.

(3) Selecting the English or Japanese message version

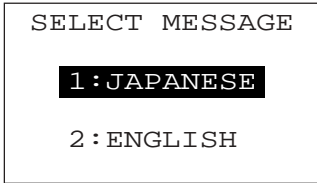

Preceding the execution of initialization, the message version selection screen will appear as shown at left.

[1] JAPANESE : Switches the message version to Japanese.

[2] ENGLISH : Switches the message version to English.

Select a desired item by using the numerical keys, then press the [ENT] key. The BHT-6000 starts initialization.

(4) During initialization

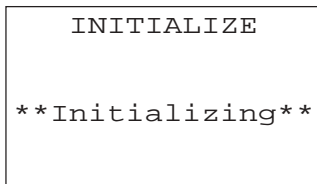

During initialization, the screen shown at left is displayed.

(5) Completion of initialization

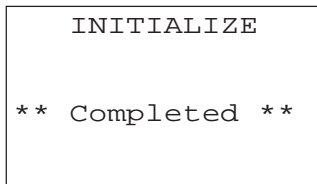

Upon completion of the initialization, the BHT-6000 displays the screen shown at left for a second and turns itself off automatically.

**NOTE** Do not power off the BHT-6000 until the above initialization completion screen appears. A too-early powering-off will interrupt initialization, requiring you to initialize the BHT-6000 again.

**NOTE** If the message "System error! Contact your administrator. Note the error drive. (DRIVE X)" appears as shown on page 20 although the initialization has completed, initialize the BHT-6000 again.

**NOTE** If you initialize the BHT-6000 after downloading user programs and data, all of those programs and data stored in the target memory area will be lost. Download them again if necessary.

**NOTE** Initialization will restore the LCD contrast level (refer to Subsection 2.4.3), communications conditions and other settings to the default values, so modify them if necessary. After initialization, be sure to set the calendar clock (refer to [ 2 ]).

## [ 2 ] Setting the Calendar Clock (date and time)

```
SYSTEM MENU
1:EXEC PROGRAM
2:DOWNLOAD
3:UPLOAD
4:SET SYSTEM
5:TEST 6:VER
```

```
SET SYSTEM
1:PROGRAM 6:COM
2:DISPLAY 7:KEY
3:DATE/TIME
4:BARCODE
5:RESUME
```

```
SET DATE/TIME
00/01/01 00:00
_ / / :
```

- (1) While holding down the **SF** and **1** keys, press the **PW** key to start System Mode. The SYSTEM MENU shown at left will appear.

- (2) Press the **4** key to select the "SET SYSTEM" on the SYSTEM MENU and then press the **ENT** key, and the screen shown at left will appear.

(To return to the immediately preceding screen during this setting procedure, press the **C** key.)

- (3) Press the **3** key on the SET SYSTEM screen to select the "DATE/TIME" and then press the **ENT** key, and the screen shown at left will appear.
- (4) Use the numerical keys to enter the year (only the last two digits), month, day, hour, and minute in this order. If the data is in one digit, add a 0 (zero) preceding the data.

**NOTE** For the year, be sure to enter the last two digits of the year. For the hour, enter it in the 24-hour format.

If any of the year, month, day, hour, and minute is not entered, the **ENT** key does not become operable.

If you make a wrong entry, press the **BS** key to delete it and then enter the correct data.

```
SET DATE/TIME
00/01/01 00:00
97/08/19 16:00_
```

[Example] To set 1997, August 19, at 4:00 p.m.

Press , , , , , , , , , and .

```
SET DATE/TIME
97/08/19 16:00
_ / / :
```

(5) Press the  key to register the above setting.

(6) Press the  key to return to the SET SYSTEM screen.



## [ 3 ] Deleting the JIS Font Files

The JIS Level 1 and Level 2 font files, which are resident in the flash ROM, contain font data for displaying Kanji characters on the LCD. If you do not need to display Kanji characters, you can delete those JIS font files according to the steps below. After deletion, the memory area which was occupied by those files can be used as a user area.

```
SYSTEM MENU
1:EXEC PROGRAM
2:DOWNLOAD
3:UPLOAD
4:SET SYSTEM
5:TEST 6:VER
```

- (1) While holding down the **[SF]** and **[1]** keys, press the **[PW]** key to start up System Mode.

The SYSTEM MENU screen shown at left will appear.

- (2) Press the **[2]** key while holding down the **[SF]** key.

JIS font menu

```
JIS 1/JIS 2
1:DELETE
2:DOWNLOAD
3:UPLOAD
```

The JIS 1/JIS 2 menu shown at left will appear.

(To return to the previous screen, press the **[C]** key.)

- (3) If the "1: DELETE" has not been selected, press the **[1]** key. Then, press the **[ENT]** key.

Deletion menu

```
DELETE
1:JIS 1
2:JIS 2
```

The screen shown at left will appear.

(To return to the previous screen, press the **[C]** key.)

- (4) Press the **[1]** key to delete the JIS Level 1 font file. (To delete the JIS Level 2 font file, press the **[2]** key.)

Confirmation screen

```
DELETE
JIS 1 DELETE
OK ?
1:Yes 2:No
```

The confirmation screen will appear.

- (5) Press the **[1]** key and then press the **[ENT]** key.

Deletion completion screen

```
DELETE
JIS 1 DELETE
** Completed **
```

The selected font file (the JIS Level 1 font file in this example) will be deleted and the screen shown at left will appear.

## 2.4.3 Adjusting the LCD Contrast & Beeper Volume, and Displaying the Battery Voltage Level

### [ 1 ] Adjusting the LCD Contrast & Beeper Volume

While holding down the **[M1]** key, press the **[PW]** key, and the following screen will appear on the LCD. This screen will disappear if no keys are pressed for five seconds.

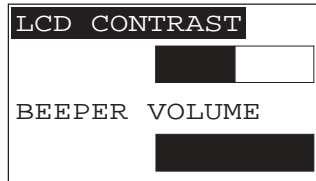

(The current selection is reverse-displayed.)

#### Adjusting the LCD contrast

You can adjust the LCD brightness to eight contrast levels.

- 1) Use the **[F5]** and **[F6]** keys to select the LCD CONTRAST line.
- 2) To decrease the contrast, press the **[F7]** key; to increase it, press the **[F8]** key.

#### Adjusting the beeper volume

You can adjust the beeper volume to four levels from OFF to MAX.

- 1) Use the **[F5]** and **[F6]** keys to select the BEEPER VOLUME line.
- 2) To turn down the volume, press the **[F7]** key; to turn it up, press the **[F8]** key.

After making the above setting, either press the **[ENT]** key or press no key for five seconds, and the new setting will be fixed and the above screen will disappear.

## [ 2 ] Displaying the Battery Voltage Level

On the SYSTEM MENU or during execution of user programs, press the **ENT** key while holding down the **SF** key for displaying the battery voltage level.

As long as you hold down those keys, the following screen is displayed.

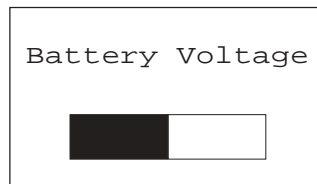

### REFERENCE

In user programs, you can select the key to be used for displaying the battery voltage level (instead of the default: combination of **SF** and **ENT** ).

The displayed battery level shows the terminal voltage of the battery, not how much power is left.

The battery voltage level varies depending upon the operation of the BHT-6000, so the displayed level also may vary by about 1 to 2 levels.

## 2.5 Operating in System Mode

System Mode is an operating software exclusively designed for the effective use of the BHT-6000, which includes various functions as shown on the following pages.

### 2.5.1 Starting System Mode

To start up System Mode, power on the BHT-6000 while holding down the **SF** and **1** keys. This operation calls up the SYSTEM MENU on the LCD as shown below.

SYSTEM MENU	
1	EXEC PROGRAM
2	DOWNLOAD
3	UPLOAD
4	SET SYSTEM
5	TEST 6:VER

The function selected is reverse-displayed (white-on-black) with the cursor. To select a desired item in System Mode, press the corresponding numerical key and then press the **ENT** key.

The keys below are so designed that the function of each key is consistent in every screen.

Numerical keys	Pressing a numerical key corresponding with a desired menu number selects the desired item displayed on the screen.
<b>ENT</b> key	Pressing this key registers the selected item and executes the corresponding function.
<b>F5</b> and <b>F6</b> keys	Pressing <b>F5</b> and <b>F6</b> moves the cursor up and down, respectively, to select a desired item.
<b>F7</b> and <b>F8</b> keys	Pressing <b>F7</b> and <b>F8</b> moves the cursor to the left and right, respectively, to select a desired setting.

The **C** key is inoperative on the SYSTEM MENU. On other screens, pressing the **C** key returns to the immediately preceding screen.

The power-on default is "EXEC PROGRAM" which is reverse-displayed. Once any other item is selected, the selected item will be reversed with the cursor when you turn back to the SYSTEM MENU.

## ■ Structure of System Mode

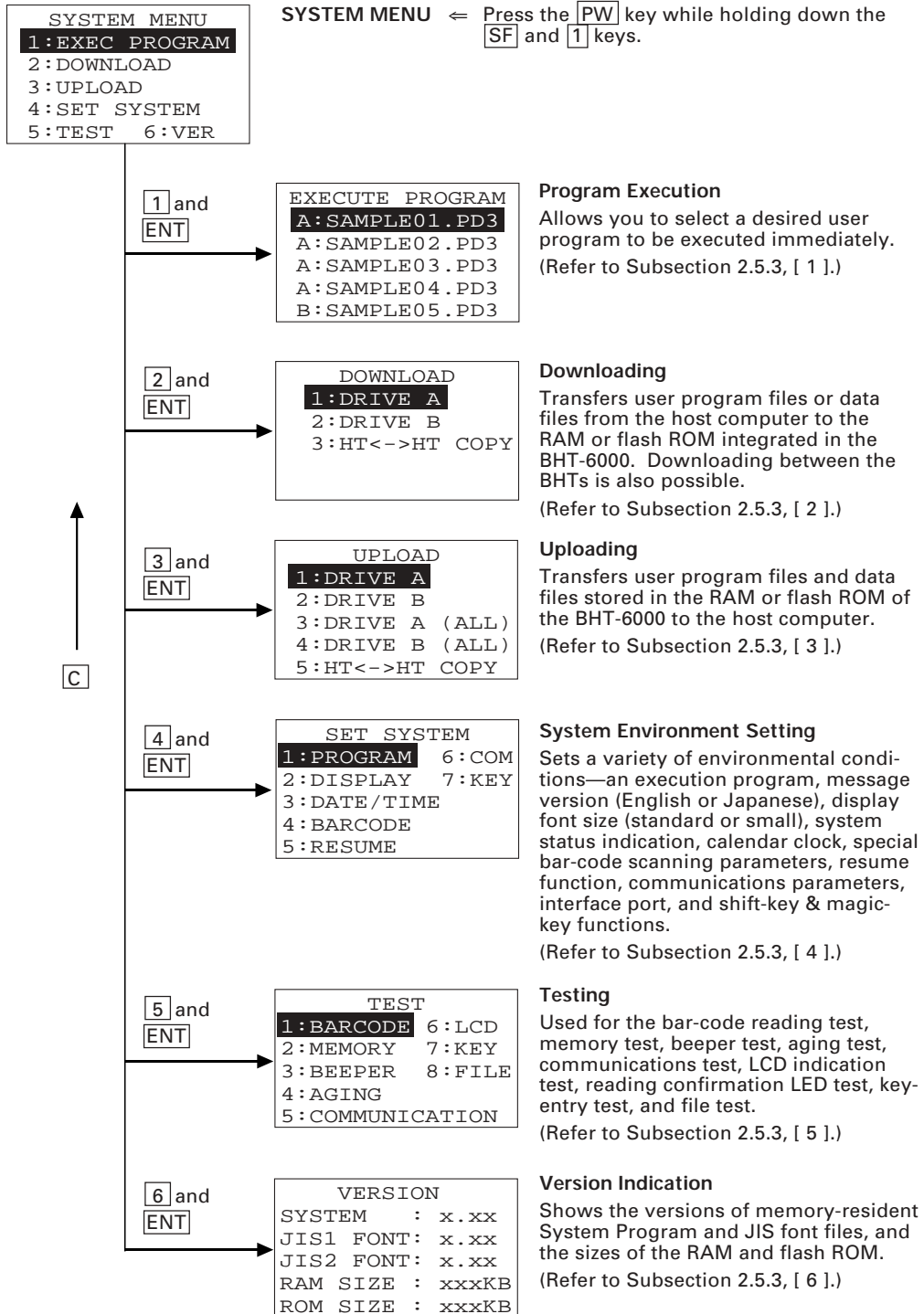

In addition to the functions given on the previous page, System Mode has these three functions: Deleting files, Copying files, and Handling the JIS font files.

To call up these functions, press the **[0]**, **[1]**, or **[2]** key, respectively, while holding down the **[SF]** key when the SYSTEM MENU is displayed.

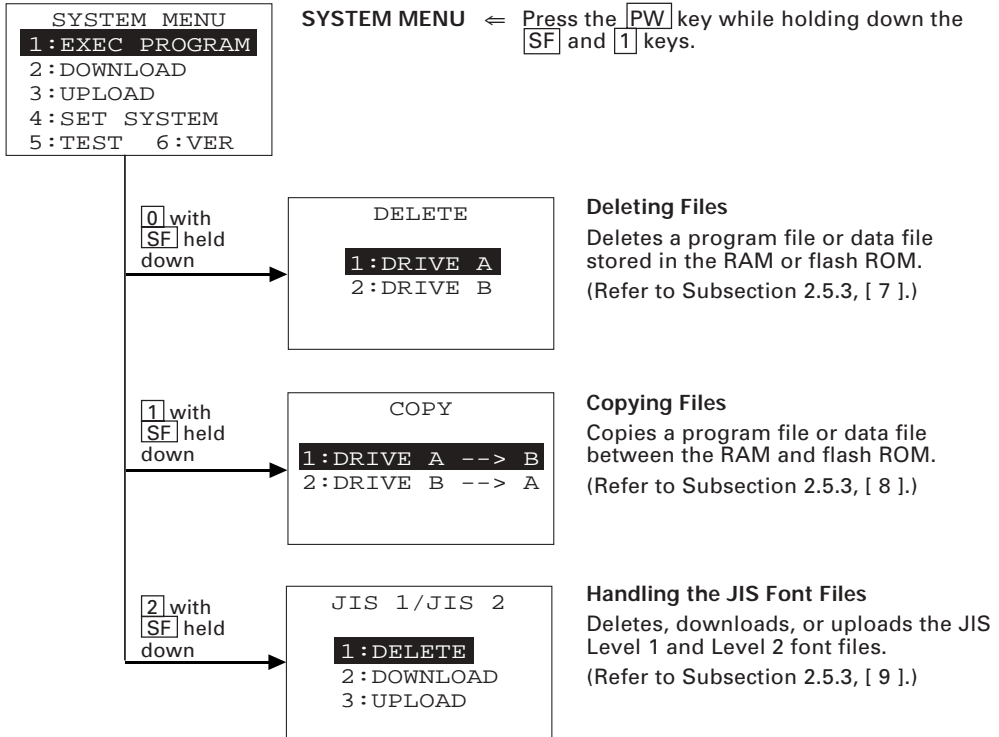

## 2.5.2 Operating in System Mode

Some functions in System Mode require several screens to be shifted, as shown in the example below.

### [ 1 ] Calling up the desired set screen

First, select a desired item on the current screen by using the numerical key or the cursor keys ( **F5** ) and ( **F6** ) so as to reverse-display the desired item.

Press the **ENT** key to establish the selected item and proceed to the subsequent screen.

To return to the preceding screen, press the **C** key.

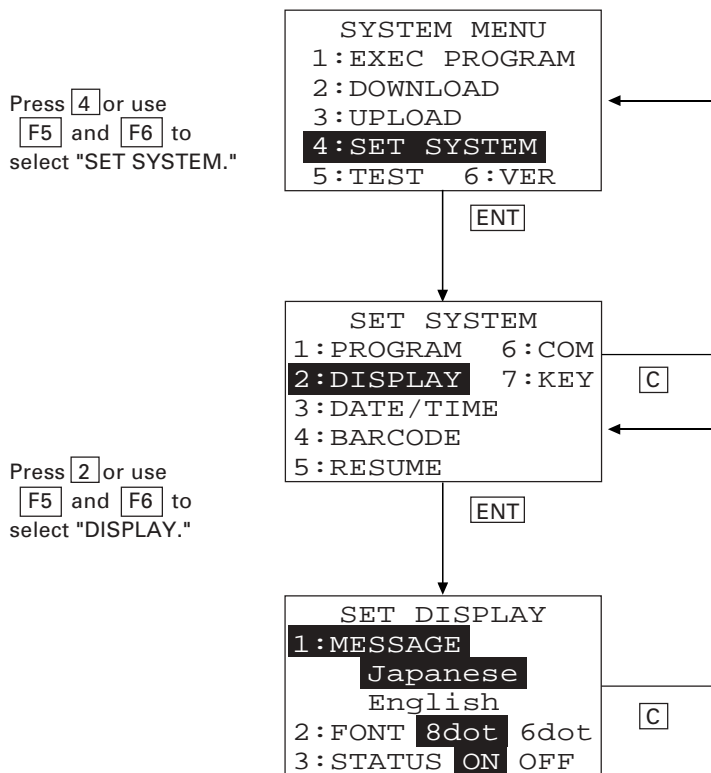

## [ 2 ] Selecting a desired setting

First, select a desired item on the current screen by using the numerical key or the cursor keys ( **F5** and **F6** ) so as to reverse-display the desired item.

Use the **F7** and **F8** keys to select a desired setting and then press the **ENT** key. The screen returns to the original selection screen.

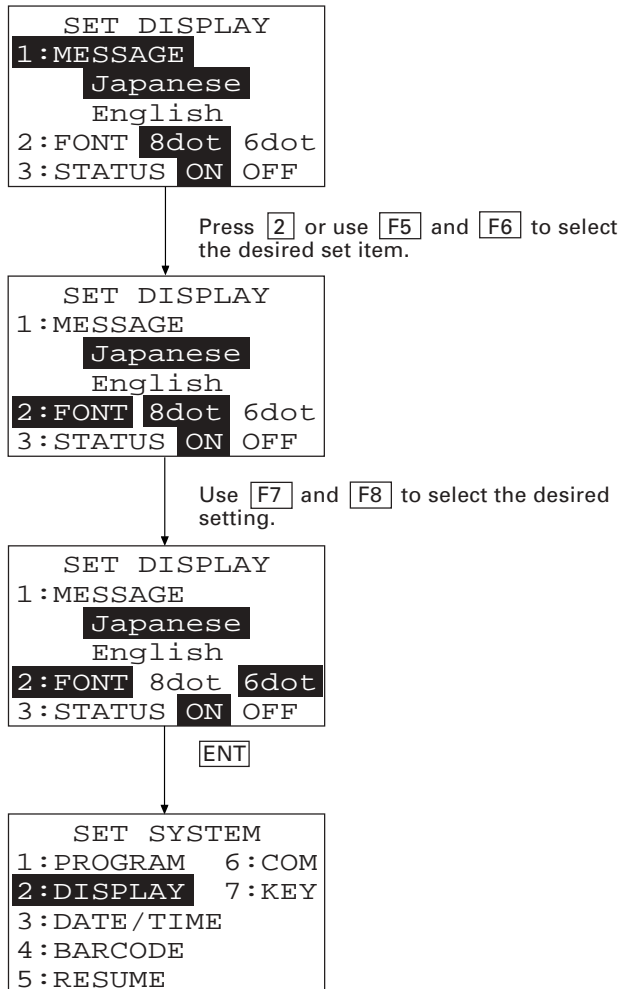



## 2.5.3 Detailed Description of the Functions in System Mode

### [ 1 ] Program Execution

```
EXECUTE PROGRAM
A: SAMPLE01.PD3
A: SAMPLE02.PD3
A: SAMPLE03.PD3
A: SAMPLE04.PD3
B: SAMPLE05.PD3
```

Selecting "1:EXEC PROGRAM" on the SYSTEM MENU shows the screen shown at left.

If more than one program has been downloaded to the user area of the target memory, use the **F5** and **F6** keys to move the cursor to a target program, and then press the **ENT** key.

The RAMed files are shown as "A:FILE NAME;" the flash-ROMed files are as "B:FILE NAME."

To return to the SYSTEM MENU, press the **C** key.

```
EXECUTE PROGRAM
A: SAMPLE01.PD3
A: SAMPLE02.PD3
A: SAMPLE03.PD3
A: SAMPLE04.PD3
B: SAMPLE05.PD3
```



```
EXECUTE PROGRAM
A: SAMPLE02.PD3
A: SAMPLE03.PD3
A: SAMPLE04.PD3
B: SAMPLE05.PD3
B: SAMPLE06.PD3
```

If more than five programs have been downloaded, you may need to scroll the screen with the **F6** key.



```
EXECUTE PROGRAM
A: SAMPLE04.PD3
B: SAMPLE05.PD3
B: SAMPLE06.PD3
B: SAMPLE07.PD3
B: SAMPLE08.PD3
```

In the example shown at left, eight programs are downloaded.

```
EXECUTE PROGRAM
*****
*NO FILE EXISTS*
*****
```

If no program file is downloaded, the message shown at left will appear.

To return to the SYSTEM MENU, press the **C** key.

## [ 2 ] Downloading

**NOTE**

If you download a file having the same name as one already used in the user area of the target memory in the BHT-6000, the newly downloaded file replaces the old one.

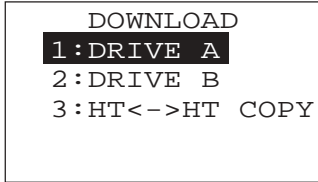

Selecting "2: DOWNLOAD" on the SYSTEM MENU calls up the screen shown at left.

- 1 DRIVE A : Downloads a user program file (object file compiled by the BHT-BASIC 3.0 Compiler) or data file *to the RAM*.
- 2 DRIVE B : Downloads a user program file (object file compiled by the BHT-BASIC 3.0 Compiler) or data file *to the flash ROM*.
- 3 HT<->HT COPY : Downloads all of the files, system parameters, and calendar clock data stored in the connected BHT-6000.

This function enables copying between the BHT-6000s.

For the preparation to be made preceding the start of this function, refer to **NOTE** below.

Select a desired item by using the numerical keys or **F5** and **F6** keys, and the selected item becomes reverse-displayed. Then press the **ENT** key.

To return to the SYSTEM MENU, press the **C** key.

**NOTE** Preparation for Copying between the BHTs

Before downloading to the BHT-6000 from another BHT-6000, make the following preparation:

- At each BHT-6000, set the interface port. The default is an optical interface (OPT).

Interface setting procedure: Starting on the SYSTEM MENU, select "4:SET SYSTEM," "6:COM," and "3:COM PORT." On the SET COM PORT screen, select the optical interface (OPT) or direct-connect interface (IFC) of "2:SYSTEM MODE."

- When using the direct-connect interface, pull out the connector cover on each BHT-6000 to expose the direct-connect interface port. Connect the BHT-6000s via those ports with the direct-connect interface cable (having 3-pole mini stereo plugs). For the details about the cable, refer to Chapter 3, Section 3.1.
- On the uploading BHT-6000, run System Mode and select "3:UPLOAD" and "5:HT<->HT COPY."

## Download screens

```
DOWNLOAD FILE
(A:)

** Waiting **
```



```
DOWNLOAD FILE
(A:)

** Loading **
```



```
DOWNLOAD FILE
(A:)
SAMPLE00.PD3
** Loading **
XXXXXX/YYYYY
```



```
DOWNLOAD FILE
(A:)
SAMPLE00.PD3
** Completed **
YYYYYY/YYYYYY
```

With this screen displayed, the BHT-6000 waits for a file to be downloaded.

In the center of the 2nd line appears the selected downloading type--(A:), (B:), or (HT<->HT) indicating the downloading to the RAM, to the flash ROM, or copying between the BHTs, respectively. The screen at left shows that "1: DRIVE A" has been selected.

Upon start of optional Ir-Transfer Utility C, Transfer Utility or equivalent program (upon receipt of an ENQ code from the host computer), the BHT-6000 displays the screen shown at left.

(Refer to the "Ir-Transfer Utility C Guide" or "Transfer Utility Guide.")

While the downloading operation is in progress, the screen shown at left is displayed indicating the file name and the number of received records/the total number of records.

To abort the downloading operation, press the  C key. The screen will switch back to the DOWNLOAD menu.

Upon completion of downloading, the number of received records becomes equal to the total number of records and the beeper beeps once. Press the  C key to return to the DOWNLOAD menu.

If the host computer downloads another new file (if the BHT-6000 receives an ENQ code) when this screen is displayed, the BHT-6000 starts receiving it.

(Refer to the "Ir-Transfer Utility C Guide" or "Transfer Utility Guide.")

If you have selected "3: HT<->HT COPY" on the DOWNLOAD menu, a sequence of the above screens will be repeated by the number of files to be downloaded.

### **If an error occurs during downloading**

If some error occurs during downloading, the BHT-6000 beeps three times and shows one of the following screens with the prompt "Retry?":

To retry the download, press the [1] and [ENT] keys; to abort it, press the [2] and [ENT] keys.

```
DOWNLOAD FILE
  (A:)
Out of memory !!
Retry? 1:Yes2:No
```

#### ■ Problem

The designated memory is insufficient for storing files to be downloaded.

#### ■ Solution

Press the [2] key to return to the SYSTEM MENU, then delete unnecessary files in the memory or decrease the size of the file to be downloaded. (Refer to Subsection 2.5.3, [ 7 ] and [ 2 ].)

```
DOWNLOAD FILE
  (A:)
File mismatch !!
Retry? 1:Yes2:No
```

#### ■ Problem

You attempted to download a JIS font file.

#### ■ Solution

Press the [2] key to return to the SYSTEM MENU and switch to the JIS 1/JIS 2 font menu, from which you download the JIS font file. (Refer to Subsection 2.5.3, [ 9 ].)

```
DOWNLOAD FILE
  (A:)
Too many files!!
Retry? 1:Yes2:No
```

#### ■ Problem

The current download will exceed the maximum of forty files in the memory.

#### ■ Solution

Press the [2] key to return to the SYSTEM MENU. If you attempted to download more than one file, delete unnecessary files in memory or decrease the number of files to be downloaded. (Refer to Subsection 2.5.3, [ 7 ] and [ 2 ].)

```
DOWNLOAD FILE
(A:)
XXXXXXXXX.XXX
Communication
error !!
Retry? 1:Yes2:No
```

```
DOWNLOAD FILE
(B:)
Drive A memory
short !!
Retry? 1:Yes2:No
```

#### ■ Problem

Downloading has failed.

#### ■ Solution

To retry downloading, press the **[1]** key.

To return to the SYSTEM MENU, press the **[2]** key. Check the interface port and communications parameters in the SET SYSTEM menu or perform the communications test in the TEST menu. (Refer to Subsection 2.5.3, [4.6] and [5.5].)

It is also necessary to check the communications parameters setup of the host computer.

#### ■ Problem

The RAM is insufficient for copying files stored in the flash ROM.

#### ■ Solution

Press the **[2]** key to return to the SYSTEM MENU, then delete unnecessary files in the RAM.

#### NOTE

When receiving downloaded files to the flash ROM, the BHT-6000 may copy the files stored in the flash ROM into the RAM. This requires an unused user area of 128 kilobytes in the RAM. If there is no area for copying in the RAM, the error message shown at left will appear.

## [ 3 ] Uploading

```

      UPLOAD
1:DRIVE A
2:DRIVE B
3:DRIVE A (ALL)
4:DRIVE B (ALL)
5:HT<->HT COPY
    
```



```

      UPLOAD FILE
      (A:)
SAMPLE01.PD3
SAMPLE02.PD3
SAMPLE03.PD3
SAMPLE04.PD3
    
```

Selecting "3: UPLOAD" on the SYSTEM MENU calls up the screen shown at left.

- 1] DRIVE A : Uploads a user program file or data file stored *in the RAM*.
- 2] DRIVE B : Uploads a user program file or data file stored *in the flash ROM*.
- 3] DRIVE A (ALL) : Uploads all of the files stored *in the RAM*.
- 4] DRIVE B (ALL) : Uploads all of the files stored *in the flash ROM*.
- 5] HT<->HT COPY : Uploads all of the files, system parameters, and calendar clock data stored in the BHT-6000, to another BHT-6000.

This function enables copying between the BHT-6000s. At the receiving BHT-6000, select "2: DOWNLOAD" and "3: HT<->HT COPY" in System Mode.

For the preparation to be made preceding the start of this function, refer to **NOTE** given on page 34.

Select a desired item by using the numerical keys or [F5] and [F6] keys, and the selected item becomes reverse-displayed. Then press the [ENT] key.

To return to the SYSTEM MENU, press the [C] key.

In the center of the 2nd line appears the selected uploading type--(A:), (B:), (A:ALL), (B:ALL) or (HT<->HT).

If you select "1: DRIVE A" or "2: DRIVE B," the screen shown at left will appear, showing all of the program files and data files stored in the selected memory. If you select any other items, this screen will be skipped.

The screen at left shows that "1: DRIVE A" has been selected.

Use the [F5] and [F6] keys to move the cursor to the file to be uploaded, then press the [ENT] key.

```

UPLOAD FILE
(A:)
*****
*NO FILE EXISTS*
*****

```

If you select any of the "1:DRIVE A" through "4:DRIVE B (ALL)" when no data files are stored in the specified memory, the message shown at left will appear.

Pressing the **C** key returns to the UPLOAD menu.

## Upload screens

```

UPLOAD FILE
(A:)

** Waiting **

```

If you select the "1:DRIVE A" or "2:DRIVE B" and choose a file to be uploaded or if you select any of the "3:DRIVE A (ALL)" through "5:HT<->HT COPY," then the screen shown at left will appear.

Showing this screen, the BHT-6000 waits for a file(s) to be uploaded.



```

UPLOAD FILE
(A:)

** Loading **

```

Upon start of optional Ir-Transfer Utility C, Transfer Utility or equivalent program (upon receipt of an ACK code from the host computer), the BHT-6000 displays the screen shown at left.

(Refer to the "Ir-Transfer Utility C Guide" or "Transfer Utility Guide.")



```

UPLOAD FILE
(A:)
SAMPLE00.PD3
** Loading **
XXXXX/YYYYY

```

While the uploading operation is in progress, the screen shown at left is displayed indicating the file name and the number of sent records/the total number of records.

To abort the uploading operation, press the **C** key. The screen will switch back to the UPLOAD menu.



```

UPLOAD FILE
(A:)
SAMPLE00.PD3
** Completed **
YYYYY/YYYYY

```

Upon completion of uploading, the number of sent records becomes equal to the total number of records and the beeper beeps once. Press the **C** key to return to the UPLOAD menu.

If you have selected "3: DRIVE A (ALL)," "4: DRIVE B (ALL)," or "5: HT<->HT COPY" on the UPLOAD menu, a sequence of the above screens will be repeated by the number of files to be uploaded.

### If an error occurs during uploading

If some error occurs during uploading, one of the following screens will appear and the beeper beeps three times.

To retry the uploading operation, press the **1** and **ENT** keys; to abort it, press the **2** and **ENT** keys.

```
UPLOAD FILE
(A:)
SAMPLE00.PD3
File error !!
Upload? 1:Yes2:No
```

#### ■ Problem

The file you attempted to upload is damaged.

#### ■ Solution

To upload the damaged file as is, press the **1** key.

```
UPLOAD FILE
(A:)
XXXXXXXXX.XXX
Communication
error !!
Retry? 1:Yes2:No
```

#### ■ Problem

Uploading has failed.

#### ■ Solution

To retry uploading, press the **1** key.

To return to the SYSTEM MENU, press the **2** key. Check the interface port and communications parameters in the SET SYSTEM menu or perform the communications test in the TEST menu. (Refer to Subsection 2.5.3, [4.6] and [5.5].)

It is also necessary to check the communications parameters setup of the host computer.



## [ 4 ] System Environment Setting

SET SYSTEM	
1 : PROGRAM	6 : COM
2 : DISPLAY	7 : KEY
3 : DATE/TIME	
4 : BARCODE	
5 : RESUME	

Selecting "4: SET SYSTEM" on the SYSTEM MENU calls up the screen shown at left.

- 1 PROGRAM : Sets an execution program to be run when the power is turned on.
- 2 DISPLAY : Sets the message version (English or Japanese), display font size (standard or small), and system status indication (shift-key icon).
- 3 DATE/TIME : Sets the calendar clock (date and time).
- 4 BARCODE : Sets the special bar-code scanning parameters (the black-and-white inverted label reading, the touch scanning/long-range scanning, and the decoding level).
- 5 RESUME : Sets the resume function.
- 6 COM : Sets the communications environments (interface port and communications parameters).
- 7 KEY : Defines the functions of the shift key and magic keys.

Select a desired item by using the numerical keys or **F5** and **F6** keys, and the selected item becomes reverse-displayed. Then press the **ENT** key.

Press the **C** key to return to the SYSTEM MENU.

## [4.1] Setting an execution program

```
SET EXEC PROGRAM
A: EASYPACK.PD3
A: SAMPLE1.PD3
A: SAMPLE2.PD3
B: SAMPLE3.PD3
B: SAMPLE4.PD3
```

Selecting "1: PROGRAM" on the SET SYSTEM menu calls up the screen shown at left.

Reversed is the current setting.

Use the **F5** and **F6** keys to move the cursor to a desired execution program to be run when the power is applied, and then press the **ENT** key.

To return to the SET SYSTEM menu, press the **C** key.

The RAMed files are shown as "A:FILE NAME;" the flash-ROMed files are as "B:FILE NAME."

```
SET EXEC PROGRAM
*****
*NO FILE EXISTS*
*****
```

If no files program are stored in the memories, the screen shown at left will appear.

To return to the SET SYSTEM menu, press the **C** key.

## [4.2] Setting the message version, display font size, and system status indication

```
SET DISPLAY
1: MESSAGE
   Japanese
   English
2: FONT  8dot 6dot
3: STATUS ON  OFF
```

Selecting "2: DISPLAY" on the SET SYSTEM menu calls up the screen shown at left.

Reversed is the current setting.

- 1 MESSAGE : Switches the message version to English or Japanese for the indications and messages on the self diagnosis, LCD contrast, beeper volume, and battery voltage level screens. (The default is the message version that you selected in the initializing sequence.)
- 2 FONT : Switches the display font size to be used in application programs to the standard (8-dot) or small (6-dot).
- 3 STATUS : Turns the system status indication on or off. If it is set to on, the shift-key icon appears as shown below.

Select a desired item by using the numerical keys or the **F5** and **F6** keys, then select a desired setting by using the **F7** and **F8** keys.

Press the **ENT** key.

To return to the SET SYSTEM menu, press the **C** key.

### REFERENCE

You may turn the system status indication on or off also by using the OUT statement in user programs. Refer to the "BHT-BASIC 3.0 Programmer's Manual."

## System Status Indication

Turning on the system status indication displays the following icon:

Indication	Icon	Description
Shift state of the keys on the keypad		Appears when the keys on the keypad are shifted.

### [4.3] Setting the calendar clock

```

SET DATE/TIME
00/01/01 00:00
_ / / :
    
```



```

SET DATE/TIME
00/01/01 00:00
97/08/19 16:00_
    
```



```

SET DATE/TIME
97/08/19 16:00
_ / / :
    
```

Selecting "3: DATE/TIME" on the SET SYSTEM menu calls up the screen shown at left.

Use the numerical keys to enter the year (only the last two digits), month, day, hour, and minute in this order, and then press the **[ENT]** key. If the data is in one digit, add a 0 (zero) preceding the data.

**NOTE**

For the year, be sure to enter the last two digits of the year. For the hour, enter it in the 24-hour format.

If any of the year, month, day, hour, and minute is not entered, the **[ENT]** key does not become operable.

If you make a wrong entry, press the **[BS]** key to delete it and then enter the correct data.

To return to the SET SYSTEM menu, press the **[C]** key.

[Example] To set 1997, August 19, at 4:00 p.m.

Press **[9]**, **[7]**, **[0]**, **[8]**, **[1]**, **[9]**, **[1]**, **[6]**, **[0]**, and **[0]**.

Press the **[ENT]** key to register the above setting.

## [4.4] Setting the special bar-code scanning parameters

SET BARCODE	
1 : INVERT	ON OFF
2 : TOUCH READ	ON OFF
3 : DECODE LEVEL	3

Selecting "4: BARCODE" on the SET SYSTEM menu calls up the screen shown at left.

Reversed is the current setting.

1 INVERT : Activates or deactivates the black-and-white inverted label reading function.

2 TOUCH READ : Switches to the touch scanning (ON) or long-range scanning (OFF).

3 DECODE LEVEL : Sets the decode level.

Select a desired item by using the numerical keys or [F5] and [F6] keys, and then select a desired setting by using the [F7] and [F8] keys.

To increase the decode level, press the [F8] key; to decrease it, press the [F7] key.

Press the [ENT] key.

To return to the SET SYSTEM menu, press the [C] key.

### Black-and-white inverted label reading function (INVERT)

This function makes it possible to read white bars on a black background.

**NOTE** Activating this function might increase the frequency of bar-code reading errors. This function can usually be set to OFF.

### Touch scanning/long-range scanning (TOUCH READ)

You may select touch scanning or long-range scanning. The touch scanning is a method in which you bring the bar-code reading window to a bar code to be scanned. The long-range scanning allows you to read bar codes wider than the readable area of the bar-code reading window by pulling the bar-code reading window away from bar codes.

If "TOUCH READ" is set to ON, the reading speed increases in touch scanning. In long-range scanning, however, this setting may decrease the reading speed and efficiency when the ambient illuminance is low or too high.

If "TOUCH READ" is set to OFF, the BHT-6000 can scan bar codes irrespective of the ambient illuminance. This setting, therefore, is suitable for long-range scanning. Note that the scanning speed will slightly decrease.

### Decode level (DECODE LEVEL)

You may set the recognition level. Decreasing the level value increases the bar-code reading efficiency, but the BHT-6000 might misread low-quality bar codes (split or stained). To the contrary, increasing the level value decreases the bar-code reading efficiency, but it precludes almost all possibilities of misreading.

The setting range of the level value is from 1 to 9 and the default is 3.

## [4.5] Setting the resume function

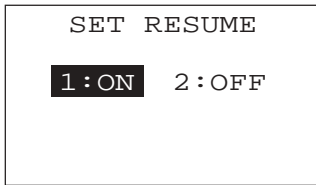

Selecting "5: RESUME" on the SET SYSTEM menu calls up the screen shown at left.

Reversed is the current setting.

**1** ON : Activates the resume function which resumes whatever display was shown before the power was turned off, when the BHT-6000 is powered up.

**2** OFF : Deactivates the resume function.

Select a desired item by using the numerical keys or **F5** and **F6** keys.

To return to the SET SYSTEM menu, press the **C** key.

## [4.6] Setting the communications environments

After the BHT-6000 is initialized, the interface port and communications parameters are set as listed in the default table below. Do not access them unless necessary.

Interface port	OPT (Optical interface port)
Communications protocol	BHT-protocol
Communications parameters for the optical interface port	Defaults
TRANSMIT SPEED	9600 bps
PULSE WIDTH (Output pulse width of IR beam)	1.63 $\mu$ s
PROTOCOL (Protocol options)	SERIAL No. ON: Adds serial numbers to data blocks. H. PARITY ON: Adds a horizontal parity. LINKUP TIME: 30 seconds FIELD SPACE: Ignore

Listed below are the default communications parameters for the direct-connect interface

Communications parameters for the direct-connect interface port	Defaults
TRANSMIT SPEED	19200 bps
PARITY BIT	None
DATA BIT (Character length)	8 bits
STOP BIT	1 bit
PROTOCOL (Protocol options)	SERIAL No. ON: Adds serial numbers to data blocks. H. PARITY ON: Adds a horizontal parity. LINKUP TIME: 30 seconds FIELD SPACE: Ignore

```
SET COM
1:OPTICAL
2:CONNECTOR
3:COM PORT
4:PROTOCOL TYPE
```

Selecting the "6: COM" on the SET SYSTEM menu calls up the screen shown at left.

- 1 OPTICAL: Switches to the communications parameters setting screen *for the optical interface*.
- 2 CONNECTOR: Switches to the communications parameters setting screen *for the direct-connect interface*.
- 3 COM PORT: Switches to the interface port setting screen.
- 4 PROTOCOL TYPE: Switches to the communications protocol type setting screen.

Select a desired screen by using the numerical keys or [F5] and [F6] keys, and then press the [ENT] key.

To return to the SET SYSTEM menu, press the [C] key.

#### [4.6-1] Setting the communications parameters for the optical interface

```
SET OPTICAL
1:TRANSMIT SPEED
2:PULSE WIDTH
3:PROTOCOL
```

Selecting "1:OPTICAL" on the SET COM menu calls up the screen shown at left.

- 1 TRANSMIT SPEED: Switches to the transmission speed screen.
- 2 PULSE WIDTH: Switches to the IR beam output pulse width screen.
- 3 PROTOCOL: Switches to the communications protocol option menu.

Select a desired screen by using the numerical keys or [F5] and [F6] keys, and then press the [ENT] key.

To return to the SET COM menu, press the [C] key.



(1) Transmission speed screen

```
SET SPEED
< OPTICAL >
1: 2400  4: 38400
2: 9600  5: 57600
3:19200  6:115200
```

Selecting "1:TRANSMIT SPEED" on the SET OPTICAL screen calls up the screen shown at left.

Select the desired transmission speed by using the numerical keys or **F5** and **F6** keys, and then press the **ENT** key.

To return to the SET OPTICAL screen, press the **C** key.

(2) IR beam output pulse width screen

```
SET PULSE WIDTH
< OPTICAL >
1:1.63us
2:3/16 Bit Time
```

Selecting the "2:PULSE WIDTH" on the SET OPTICAL screen calls up the screen shown at left.

- 1 1.63us:            1.63  $\mu$ s
- 2 3/16 Bit Time:    3/16 bit time

Select the desired pulse width by using the numerical keys or **F5** and **F6** keys, and then press the **ENT** key.

To return to the SET OPTICAL screen, press the **C** key.

(3) Communications protocol option menu

```
SET PROTOCOL
< OPTICAL >
1:SERIAL No.
2:H.PARITY
3:LINKUP TIME
4:FIELD SPACE
```

Selecting "3: PROTOCOL" on the SET OPTICAL screen calls up the screen shown at left.

- 1 SERIAL No.:        Switches to the serial number ON/OFF screen.
- 2 H. PARITY:         Switches to the horizontal parity ON/OFF screen.
- 3 LINKUP TIME:      Switches to the timeout length screen.
- 4 FIELD SPACE:      Switches to the space code handling screen.

Select a desired screen by using the numerical keys or **F5** and **F6** keys, and then press the **ENT** key.

To return to the SET OPTICAL screen, press the **C** key.

**NOTE** If the BHT-Ir protocol has been selected, the serial number and horizontal parity settings will be ignored.

```
SET SERIAL NO.  
< OPTICAL >  
  
1:ON  2:OFF
```

Selecting the "1:SERIAL No." on the SET PROTOCOL menu calls up the screen shown at left.

Select whether or not the system should add serial numbers to data blocks, by using the numerical keys or **F5** and **F6** keys. Then press the **ENT** key.

To return to the SET PROTOCOL menu, press the **C** key.

```
SET H. PARITY  
< OPTICAL >  
  
1:ON  2:OFF
```

Selecting the "2:H.PARITY" on the SET PROTOCOL menu calls up the screen shown at left.

Select whether or not the system should add a horizontal parity, by using the numerical keys or **F5** and **F6** keys. Then press the **ENT** key.

To return to the SET PROTOCOL menu, press the **C** key.

```
SET LINKUP TIME  
< OPTICAL >  
1:30  4:120  
2:60  5:None  
3:90
```

Selecting the "3:LINKUP TIME" on the SET PROTOCOL menu calls up the screen shown at left.

Select the timeout length (in seconds) to be applied when a link is to be established, by using the numerical keys or **F5** and **F6** keys. Then press the **ENT** key.

To return to the SET PROTOCOL menu, press the **C** key.

```
SET FIELD SPACE  
< OPTICAL >  
  
1:Ignore  
2:Data
```

Selecting the "4:FIELD SPACE" on the SET PROTOCOL menu calls up the screen shown at left.

Select whether space codes in the tail of a data field should be ignored or handled as data, by using the numerical keys or **F5** and **F6** keys. Then press the **ENT** key.

To return to the SET PROTOCOL menu, press the **C** key.

## [4.6-2] Setting the communications parameters for the direct-connect interface

```
SET CONNECTOR
1: TRANSMIT SPEED
2: PARITY BIT
3: DATA BIT
4: STOP BIT
5: PROTOCOL
```

Selecting "2:CONNECTOR" on the SET COM menu calls up the screen shown at left.

- 1 TRANSMIT SPEED: Switches to the transmission speed screen.
- 2 PARITY BIT: Switches to the parity setting screen.
- 3 DATA BIT: Switches to the character length screen.
- 4 STOP BIT: Switches to the stop bit length screen.
- 5 PROTOCOL: Switches to the communications protocol option menu.

Select a desired screen by using the numerical keys or **F5** and **F6** keys, and then press the **ENT** key.

To return to the SET COM menu, press the **C** key.

**NOTE** If the BHT-Ir protocol has been selected, the parity bit, character length, and stop bit length settings will be ignored.

### (1) Transmission speed screen

```
SET SPEED
< CONNECTOR >
1:1200 4: 9600
2:2400 5:19200
3:4800 6:38400
```

Selecting "1:TRANSMIT SPEED" on the SET CONNECTOR screen calls up the screen shown at left.

Select the desired transmission speed by using the numerical keys or **F5** and **F6** keys, and then press the **ENT** key.

To return to the SET CONNECTOR screen, press the **C** key.

### (2) Parity setting screen

```
SET PARITY BIT
< CONNECTOR >
1:None
2:Odd
3:Even
```

Selecting "2:PARITY BIT" on the SET CONNECTOR screen calls up the screen shown at left.

Select the parity: none, odd or even, by using the numerical keys or **F5** and **F6** keys, and then press the **ENT** key.

To return to the SET CONNECTOR screen, press the **C** key.

(3) Character length screen

```

SET DATA BIT
< CONNECTOR >

1:7 bits
2:8 bits
    
```

Selecting "3:DATA BIT" on the SET CONNECTOR screen calls up the screen shown at left.

Select the desired character length by using the numerical keys or **F5** and **F6** keys, and then press the **ENT** key.

To return to the SET CONNECTOR screen, press the **C** key.

(4) Stop bit length screen

```

SET STOP BIT
< CONNECTOR >

1:1 bit
2:2 bits
    
```

Selecting "4:STOP BIT" on the SET CONNECTOR screen calls up the screen shown at left.

Select the desired stop bit length by using the numerical keys or **F5** and **F6** keys, and then press the **ENT** key.

To return to the SET CONNECTOR screen, press the **C** key.

(5) Communications protocol option menu

```

SET PROTOCOL
< CONNECTOR >
1:SERIAL No.
2:H.PARITY
3:LINKUP TIME
4:FIELD SPACE
    
```

Selecting "5:PROTOCOL" on the SET CONNECTOR screen calls up the screen shown at left.

- 1** SERIAL No.: Switches to the serial number ON/OFF screen.
- 2** H. PARITY: Switches to the horizontal parity ON/OFF screen.
- 3** LINKUP TIME: Switches to the timeout length screen.
- 4** FIELD SPACE: Switches to the space code handling screen.

Select a desired screen by using the numerical keys or **F5** and **F6** keys, and then press the **ENT** key.

To return to the SET CONNECTOR screen, press the **C** key.

**NOTE** If the BHT-Ir protocol has been selected, the serial number and horizontal parity settings will be ignored.

```
SET SERIAL No.  
< CONNECTOR >  
  
1:ON  2:OFF
```

Selecting the "1:SERIAL No." on the SET PROTOCOL menu calls up the screen shown at left.

Select whether or not the system should add serial numbers to data blocks, by using the numerical keys or **F5** and **F6** keys. Then press the **ENT** key.

To return to the SET PROTOCOL menu, press the **C** key.

```
SET H.PARITY  
< CONNECTOR >  
  
1:ON  2:OFF
```

Selecting the "2:H.PARITY" on the SET PROTOCOL menu calls up the screen shown at left.

Select whether or not the system should add a horizontal parity, by using the numerical keys or **F5** and **F6** keys. Then press the **ENT** key.

To return to the SET PROTOCOL menu, press the **C** key.

```
SET LINKUP TIME  
< CONNECTOR >  
1:30  4:120  
2:60  5:None  
3:90
```

Selecting the "3:LINKUP TIME" on the SET PROTOCOL menu calls up the screen shown at left.

Select the timeout length (in seconds) to be applied when a link is to be established, by using the numerical keys or **F5** and **F6** keys. Then press the **ENT** key.

To return to the SET PROTOCOL menu, press the **C** key.

```
SET FIELD SPACE  
< CONNECTOR >  
  
1:Ignore  
2:Data
```

Selecting the "4:FIELD SPACE" on the SET PROTOCOL menu calls up the screen shown at left.

Select whether space codes in the tail of a data field should be ignored or handled as data, by using the numerical keys or **F5** and **F6** keys. Then press the **ENT** key.

To return to the SET PROTOCOL menu, press the **C** key.

### [4.6-3] Setting the interface port

```
SET COM PORT
1 : BASIC
   OPT IFC
2 : SYSTEM MODE
   OPT IFC
```

Selecting the "3:COM PORT" on the SET COM menu calls up the screen shown at left.

Reversed is the current setting.

- 1 BASIC: Selects the optical or direct-connect interface port to be used *for user programs written in BHT-BASIC 3.0 (OPEN "COM:" or XFILE statement).*
- 2 SYSTEM MODE: Selects the optical or direct-connect interface port to be used *for downloading or uploading files in System Mode.*

Select a desired item by using the numerical keys or **F5** and **F6** keys, and then select a desired setting by using the **F7** and **F8** keys.

To return to the SET COM menu, press the **C** key.

#### [4.6-4] Setting the communications protocol type

```
PROTOCOL TYPE
1:BHT Protocol
2:BHT IrProtocol
```

Selecting the "4:PROTOCOL TYPE" on the SET COM menu calls up the screen shown at left.

Reversed is the current setting.

**1** BHT Protocol: Selects the BHT-protocol for downloading or uploading files in System Mode or for the execution of XFILE statement in BHT-BASIC 3.0.

This protocol should be selected for file transmission with Transfer Utility.

**2** BHT IrProtocol: Selects the BHT-Ir protocol for downloading or uploading files in System Mode or for the execution of XFILE statement in BHT-BASIC 3.0.

This protocol should be selected for file transmission with Ir-Transfer Utility C.

Select a desired item by using the numerical keys or **F5** and **F6** keys, and then press the **ENT** key.

To return to the SET COM menu, press the **C** key.

```
SET ID
00001 >> _
```

Selecting the "2:BHT IrProtocol" on the PROTOCOL TYPE screen calls up the screen shown at left.

Enter the ID number of the BHT-6000 by using the numerical keys, and then press the **ENT** key. If you do not need to modify the current setting, press the **ENT** key only.

```
SET ID
00001 >> 65535_
```

**NOTE** An ID number should be five-digit decimal character string. The setting range is from 00001 to 65535. If the entered value is less than five digits, the **ENT** key does not become operable.

If you make a wrong entry, press the **BS** key to delete it and then enter the correct data.

To return to the SET COM menu, press the **C** key.

## [4.7] Defining the functions of the shift key and magic keys

```
SET KEY
1:SHIFT KEY
2:M1 KEY
3:M2 KEY
```

Selecting the "7:KEY" on the SET SYSTEM menu calls up the screen shown at left.

Reversed is the current setting.

- 1 SHIFT KEY: Switches to the shift key definition screen.
- 2 M1 KEY: Switches to the M1 key definition screen.
- 3 M2 KEY: Switches to the M2 key definition screen.

Select a desired screen by using the numerical keys or **F5** and **F6** keys, and then press the **ENT** key.

To return to the SET SYSTEM menu, press the **C** key.

### Defining the function of the shift key

```
SET SHIFT KEY
1:Nonlock
2:Onetime
```

Selecting the "1:SHIFT KEY" on the SET KEY menu calls up the screen shown at left.

Reversed is the current setting.

- 1 Nonlock: Shifts the keypad only when the **SF** key is held down.
- 2 Onetime: Shifts only one key pressed immediately after the **SF** key is pressed. (The following keys will not be shifted.)

Select a desired setting by using the numerical keys or **F5** and **F6** keys, and then press the **ENT** key. The screen returns to the SET KEY menu.



## Defining the function of **M1** or **M2** key

```
SET M1 KEY
1:Trigger Switch
2:Shift Key
3:Enter Key
4:Backlight Key
5:None
```

Selecting the "2:M1 KEY" or "3:M2 KEY" on the SET KEY menu calls up the screen as shown at left. (This example appears when the "2:M1 KEY.")

Reversed is the current setting.

The **M1** or **M2** key can function as listed below.

- |                          |                                       |
|--------------------------|---------------------------------------|
| <b>1</b> Trigger Switch: | As the trigger switch.                |
| <b>2</b> Shift Key:      | As the <b>SF</b> key.                 |
| <b>3</b> Enter Key:      | As the <b>ENT</b> key.                |
| <b>4</b> Backlight Key:  | As the backlight function on/off key. |
| <b>5</b> None:           | The key entry will be ignored.        |

Select a desired setting by using the numerical keys or **F5** and **F6** keys, and then press the **ENT** key. The screen returns to the SET KEY menu.

## Magic keys **M1** and **M2**

Both **M1** and **M2** keys are assigned the trigger switch function by default. You can make them function as the **SF** key, **ENT** key, or backlight function on/off key.

If you define the **M1** key as the backlight function on/off key, pressing the **M1** key activates or deactivates the backlight function.

In user programs, a string data also can be assigned to these magic keys.

### NOTE

Both of **M1** and **M2** keys cannot be assigned the backlight function on/off key. The key defined more recently will act as the backlight function on/off key and one defined earlier will be ignored.

That is, if you define the **M1** and **M2** keys as the backlight function on/off key in this order, the **M2** key will work as the backlight function on/off key and the **M1** key's entry will be ignored.

## [ 5 ] Testing

TEST	
1 : BARCODE	6 : LCD
2 : MEMORY	7 : KEY
3 : BEEPER	8 : FILE
4 : AGING	
5 : COMMUNICATION	

Selecting "5: TEST" on the SYSTEM MENU calls up the screen shown at left.

1 BARCODE : Selects the bar-code reading test.

2 MEMORY : Selects the RAM read/write test and the address test.

3 BEEPER : Selects the beeper scale test.

4 AGING : Selects the aging test.

5 COMMUNICATION : Selects the communications test.

6 LCD : Selects the LCD and reading confirmation LED tests.

7 KEY : Selects the key entry & beeper test.

8 FILE : Selects the file checksum test.

Select a desired setting by using the numerical keys or **F5** and **F6** keys, and then press the **ENT** key. The screen returns to the SYSTEM MENU.

Reversed is the current setting.

To return to the SYSTEM MENU, press the **C** key.

### NOTE

If an error occurs in any of the above tests, contact your nearest dealer.

## [5.1] Bar-code reading test

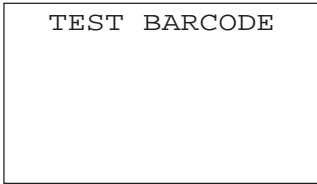

Selecting "1: BARCODE" on the TEST menu calls up the screen shown at left.

Actually read bar codes with the BHT-6000 and check the read data displayed on the LCD.

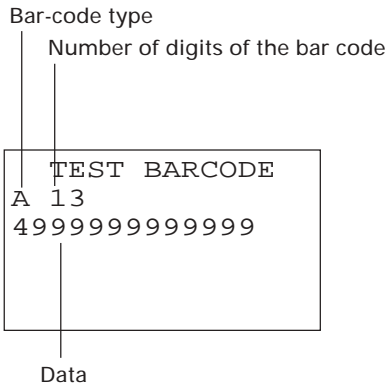

Upon completion of bar-code reading, the BHT-6000 beeps, turns on the reading confirmation LED in green, and displays the read data together with the bar-code type and the number of data digits.

Up to 64-digit data can be shown and the excess will be discarded.

To return to the TEST menu, press the  key.

Listed below is a table showing the relationship between the bar-code types and the identifier letters to be displayed on the LCD.

Bar-code Type	ID Letters
EAN-13, UPC-A	A
EAN-8	B
UPC-E	C
Standard 2 of 5 (STF)	H
Interleaved 2 of 5 (ITF)*	I
CODABAR (NW7)	N
CODE39	M
CODE93	L
CODE128	K

\* The BHT-6000 can read only those ITF bar codes having 4 digits or more in length.

## [5.2] Memory test

```
TEST MEMORY
** Testing **
XXXXX/YYYYY
```

Selecting "2:MEMORY" on the TEST menu calls up the screen shown at left, and then starts writing and reading onto/from all areas of the RAM as well as checking the address.

XXXXX: Tested RAM capacity (unit: kilobytes)

YYYYY: Total RAM capacity (unit: kilobytes)

```
TEST MEMORY
** Test NG **
XXXXX/YYYYY
Address:hhmll
Write:AA Read:BB
```

If any error is detected, the BHT-6000 beeps three times, shows the message as shown at left, and terminates the test.

Where,

hhmll: Address where an error has occurred.

AA: Data to write.

BB: Data read out from the RAM.

To return to the TEST menu, press the  key.

```
TEST MEMORY
** Test OK **
YYYYY/YYYYY
```

Upon normal completion of the RAM test, the BHT-6000 beeps once, shows the message as shown at left, and returns to the TEST menu.

### [5.3] Beeper scale test

```
TEST BEEPER
```

Selecting "3:BEEPER" on the TEST menu calls up the screen shown at left and makes the beeper sound at three octaves listed below.

Upon completion of this test, the BHT-6000 automatically returns to the TEST menu.

To stop this test while in progress, turn the power off and on.

Scale	Frequency (Hz)			
do	523	1046	2093	4186
re	587	1174	2349	-
mi	659	1318	2637	-
fa	698	1396	2793	-
sol	783	1567	3135	-
la	880	1760	3520	-
ti	987	1975	3951	-

### [5.4] Aging test

```
TEST AGING
DATE  97/01/21
TIME  15:30:00
```

Selecting "4:AGING" on the TEST menu proceeds to the aging test while showing the current date and time on the LCD. (This test is intended for personnel which check the BHT-6000 in the factory.)

#### NOTE

Once this test is selected, the automatic powering-off function becomes disabled. Be sure to turn the power off or press the **[C]** key to return to the TEST menu.

## [5.5] Communications test

In System Mode, you may test the optical interface port and direct-connect interface port.

### ■ Preparation for the optical interface test

Arrange two BHT-6000s, one as a master station and the other as a slave station (to be tested) with their IR ports facing each other as illustrated below. In this test, the slave BHT-6000 transmits data to the master BHT-6000 and receives the data sent back from the master BHT-6000.

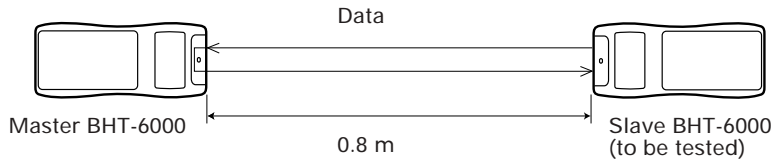

### ■ Preparation for the direct-connect interface test

Arrange the 3-pole mini stereo plug as illustrated below and connect it to the direct-connect interface port on the BHT-6000.

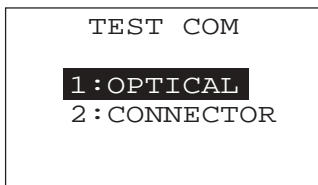

Selecting the "5:COMMUNICATION" on the TEST menu calls up the screen shown at left.

**1** OPTICAL : Switches to the MASTER/SLAVE selection screen for the optical interface test.

**2** CONNECTOR : Tests the direct-connect interface port.

## Testing the optical interface port

```
TEST COM
< OPTICAL >

1:SLAVE
2:MASTER
```

Selecting the "1:OPTICAL" on the TEST COM menu calls up the screen shown at left.

At the slave BHT-6000 to be tested, select the "1:SLAVE" and at the master BHT-6000, select the "2:MASTER."

```
TEST COM
< OPTICAL >

** Testing **
```

During the test, the screen shown at left is displayed.

```
TEST COM
< OPTICAL >

** Test NG **
(XX)
```

If any error occurs, the tested slave BHT-6000 beeps three times and shows the screen at left.

In parentheses are error codes which have the following meanings:

(X X)

- 1: The received data is different from the sent data.
- 2: A timeout has occurred during standby for data reception.

- 1: 2400 bps
- 2: 9600 bps
- 3: 115200 bps

Press the **C** key to return to the TEST COM menu.

The master BHT-6000 will automatically return to the TEST COM menu after 10 seconds from the occurrence of an error.

```
TEST COM
< OPTICAL >

** Test OK **
```

Upon normal completion of the test, the tested slave BHT-6000 beeps once and shows the screen at left.

Press the **C** key to return to the TEST COM menu.

The master BHT-6000 will automatically return to the TEST COM menu.

## Testing the direct-connect interface port

```
TEST COM
< CONNECTOR >

** Testing **
```

Selecting the "2:CONNECTOR" on the TEST COM menu displays the screen shown at left and then starts testing the direct-connect interface port.

```
TEST COM
< CONNECTOR >

** Test NG **
  (XX)
```

If any error occurs, the BHT-6000 beeps three times and shows the screen at left.

In parentheses are error codes which have the following meanings:

(X X)

- 1: The received data is different from the sent data.
- 2: A timeout has occurred during standby for data reception.

- 1: 300 bps
- 2: 38400 bps

Press the **C** key to return to the TEST COM menu.

```
TEST COM
< CONNECTOR >

** Test OK **
```

Upon normal completion of the test, the BHT-6000 beeps once and shows the screen at left.

Press the **C** key to return to the TEST COM menu.



## [5.6] LCD and reading confirmation LED tests



[BS] key ↑ ↓ [ENT] key

Selecting "6:LCD" on the TEST menu calls up the test pattern shown at left on the LCD and turns on the reading confirmation LED in green.

Each time the [ENT] key is pressed, the screen shifts to the next test pattern. To return to the previous screen, press the [BS] key.

To stop this test while in progress, press the [C] key.

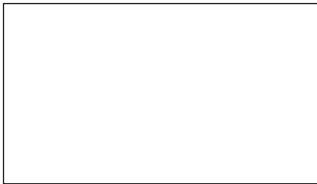

[BS] key ↑ ↓ [ENT] key

As shown at left, everything disappears and the reading confirmation LED lights in red.

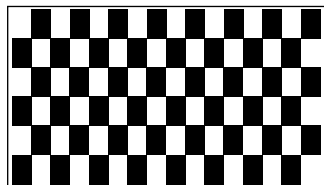

[BS] key ↑ ↓ [ENT] key

The checker pattern shown at left appears and the reading confirmation LED goes off.

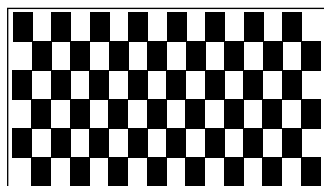

[BS] key ↑ ↓ [ENT] key

The checker pattern is reversed.

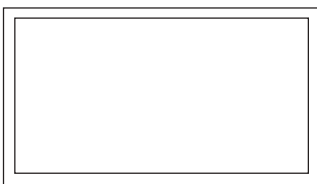

An outline with a width of one dot appears.

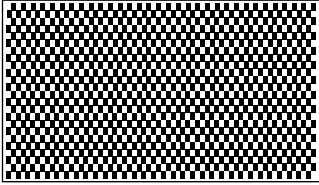

The fine checker pattern appears.

[BS] key ↑ ↓ [ENT] key

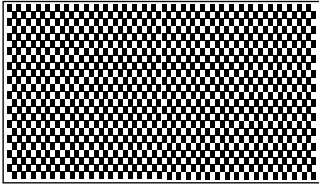

The fine checker pattern is reversed.

[BS] key ↑ ↓ [ENT] key

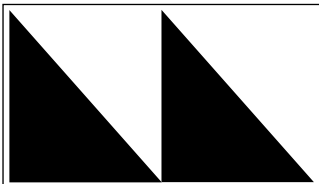

Two right-angled triangles appear.

[BS] key ↑ ↓ [ENT] key

```

! " # $ % & ' ( ) * + , - . /
0 1 2 3 4 5 6 7 8 9 : ; < = > ?
@ A B C D E F G H I J K L M N O
P Q R S T U V W X Y Z [ ¥ ] ^ _
` a b c d e f g h i j k l m n o
p q r s t u v w x y z { | }

```

After showing all of the test patterns, the screen automatically displays symbols, numerals, and alphabets.

The display font size (standard or small) depends upon the setting made in Subsection 2.5.3, [4.2].

⇓ After 0.5 second

```

亜 唾 娃 阿 哀 愛
挨 始 逢 葵 茜 穉
惡 握 渥 旭 葦 芦

```

If the JIS Level 1 font file is stored in the flash ROM, the Kanji characters will appear automatically. The display font size (standard or small) depends upon the setting made in Subsection 2.5.3, [4.2].

Upon completion of this test, the BHT-6000 beeps once and returns to the TEST menu.

## [5.7] Key entry & beeper test

```

TEST KEY

```

Selecting "7:KEY" on the TEST menu calls up the screen shown at left and makes the BHT-6000 ready for entry from the keypad.

Pressing individual keys displays the identifier letters in the positions preassigned to those keys on the LCD and sounds the beeper. (As long as the individual key is held down, the beeper continues beeping.)

Pressing the same key again erases the displayed letter.

The table below shows the relationship between the keys, the identifier letters to be displayed on the LCD, and the frequencies (Hz) of the beeper.

Key	Letter	Beeper (Hz)	Key	Letter	Beeper (Hz)	Key	Letter	Beeper (Hz)
M1	L	523	1	1	1174	F3	C	2637
M2	M	587	2	2	1318	F4	D	2793
7	7	659	3	3	1396	F5	E	3135
8	8	698	0	0	1567	F6	F	3520
9	9	783	.	.	1760	F7	G	3951
4	4	880	ENT	=	1975	F8	H	4186
5	5	987	F1	A	2093	BS	I	4699
6	6	1046	F2	B	2349	C	J	5274
						SF	K	5587

```

TEST KEY

LM
7894561230.=
ABCDEFGHIJK

```

After all keys are pressed and displayed on the LCD, this test automatically ends and the screen returns to the TEST menu.

## [5.8] File test

```

TEST FILE
*1:DRIVE A
 2:DRIVE B
  SIZE XXXX
  FREE XXXX
    
```

Selecting "8: FILE" on the TEST menu calls up the screen shown at left and tests all files stored in the RAM and flash ROM.

If the RAM and/or the flash ROM contain any defective file(s), an asterisk (\*) will be prefixed as "\*1: DRIVE A" or "\*2: DRIVE B," respectively. (This example at left shows that the RAM contains a defective file(s).)

To return to the TEST menu, press the **C** key.

Reversed is the current setting.

**1** DRIVE A: Tests all of the files stored in the RAM.

**2** DRIVE B: Tests all of the files stored in the flash ROM (except for the JIS font files).

SIZE: Shows the size of the user area used.

FREE: Shows the size of the unused user area.

```

TEST FILE
(A:)
SAMPLE01.PD3
*SAMPLE02.DAT
SAMPLE03.PD3
SAMPLE04.PD3
    
```

To find which file(s) is defective in the drive marked with an asterisk (\*), select the drive on the TEST FILE menu by using the numerical keys or **F5** and **F6** keys, then press the **ENT** key.

The file selection screen appears as shown at left, where defective files are prefixed by an asterisk (\*). (This example shows that the "1:DRIVE A" has been selected.)

If you select a desired file on this screen by using the **F5** and **F6** keys, the file size and the test result will appear as shown on the next page. When there are more than four files, the screen will scroll.

```
TEST FILE
(A:)
SAMPLE01.PD3
00004096 bytes
OK
```

The file name, file size, and test result (OK or NG) appear.

```
TEST FILE
(A:)
SAMPLE02.PD3
00004096 bytes
NG
```

Press the C key to return to the file selection screen.

**NOTE**

If a defective file is found, delete it or overwrite it with the same name file.

Even defective, the file can be uploaded on the UPLOAD menu. It is, therefore, recommended that important files be uploaded before deleted.

## [ 6 ] Version Indication

```

VERSION
SYSTEM   : x.xx
JIS1 FONT: x.xx
JIS2 FONT: x.xx
RAM SIZE : xxxKB
ROM SIZE : xxxKB
    
```

Selecting the “6:VER” on the SYSTEM MENU calls up the screen shown at left, indicating the versions of memory-resident System Program and JIS font files, and the sizes of the RAM and flash ROM.

Press the **[C]** key to return to the SYSTEM MENU.

```

VERSION
SYSTEM   : x.xx
JIS1 FONT: _._
JIS2 FONT: _._
RAM SIZE : xxxKB
ROM SIZE : xxxKB
    
```

If the JIS font files are not stored in the flash ROM, “\_.\_” appears.

## [ 7 ] Deleting Files

You can delete a program file or data file stored in the RAM or flash ROM.

File deletion menu

```

DELETE
1:DRIVE A
2:DRIVE B
    
```

Pressing the **[0]** key while holding down the **[SF]** key on the SYSTEM MENU calls up the screen shown at left.

**[1]** DRIVE A : Deletes the files stored in the RAM.

**[2]** DRIVE B : Deletes the files stored in the flash ROM.

Select a desired item by using the numerical keys or **[F5]** and **[F6]** keys, then press the **[ENT]** key.

Reversed is the current setting.

Press the **[C]** key to return to the SYSTEM MENU.

File selection screen

```
DELETE FILE
(A: )
SAMPLE01.PD3
SAMPLE02.PD3
SAMPLE03.PD3
SAMPLE04.PD3
```

In the center of the 2nd line appears the selected item--(A:) or (B:). This example shows that the "1: DRIVE A" has been selected.

Program files and/or data files stored in the user area of the RAM are displayed as shown at left.

Use the **F5** and **F6** keys to move the cursor to the file to be deleted, then press the **ENT** key.

```
DELETE FILE
(A: )
*****
*NO FILE EXISTS*
*****
```

If no file is resident in the selected drive, the message shown at left appears.

Press the **C** key to return to the file deletion menu.

Deletion confirmation screen

```
DELETE FILE
(A: )
SAMPLE01.PD3

Delete?
1:Yes 2:No
```

Selecting a file to be deleted and then pressing the **ENT** key calls up the confirmation screen shown at left.

- 1 Yes : Deletes the selected file.
- 2 No : Cancels deletion and returns to the previous file selection screen.

Select a desired item by using the numerical keys, then press the **ENT** key.

Deletion completion screen

```
DELETE FILE
(A: )
SAMPLE01.PD3

** Completed **
```

Upon completion of deletion, the screen shown at left appears.

Press the **C** key to return to the file selection screen.

## [ 8 ] Copying Files

You can copy a program file or data file from the RAM to the flash ROM, or vice versa.

File copy menu

```

COPY
1:DRIVE A --> B
2:DRIVE B --> A
    
```

Pressing the **1** key while holding down the **SF** key on the SYSTEM MENU calls up the screen shown at left.

**1** DRIVE A-->DRIVE B : Copies a file stored in the RAM, into the flash ROM.

**2** DRIVE B-->DRIVE A : Copies a file stored in the flash ROM, into the RAM.

Select a desired item by using the numerical keys or **F5** and **F6** keys, then press the **ENT** key.

Reversed is the current setting.

Press the **C** key to return to the SYSTEM MENU.

File selection screen

```

COPY FILE
(A->B)
SAMPLE01.PD3
SAMPLE02.PD3
SAMPLE03.PD3
SAMPLE04.PD3
    
```

In the center of the 2nd line appears the selected item--(A->B) or (B->A). This example shows that the "1: DRIVE A-->DRIVE B" has been selected.

Program files and/or data files stored in the user area of the RAM are displayed as shown at left.

Use the **F5** and **F6** keys to move the cursor to a file to be copied, then press the **ENT** key.

```

COPY FILE
(A->B)
*****
*NO FILE EXISTS*
*****
    
```

If no file is resident in the selected drive, the message shown at left appears.

Press the **C** key to return to the file copy menu.

Copy confirmation screen

```

COPY FILE
(A->B)
SAMPLE01.PD3
Copy?
1:Yes 2:No
    
```

Selecting a file to be copied and then pressing the **ENT** key calls up the confirmation screen shown at left.

**1** Yes : Copies the selected file.

**2** No : Cancels copying and returns to the previous file selection screen.

Select a desired item by using the numerical keys, then press the **ENT** key.



#### Copying screen

```
COPY FILE
(A->B)
SAMPLE01.PD3

XXXXXX/YYYYY
```

During copying, the screen shown at left is displayed indicating the number of copied records/ the total number of records in the target file.

#### Copy completion screen

```
COPY FILE
(A->B)
SAMPLE01.PD3

** Completed **
```

Upon completion of copying, the screen shown at left appears and the beeper beeps once.

Press the **C** key to return to the file selection screen.

### If an error occurs during file copying

If some error occurs during file copying, the BHT-6000 beeps three times and shows one of the following screens:

To return to the file selection screen, press the **C** key.

```
COPY FILE
(A->B)

Out of memory !!
```

#### ■ Problem

The target memory is insufficient for storing files to be copied.

#### ■ Solution

Press the **C** key to return to the SYSTEM MENU, then delete unnecessary files in the memory.

```
COPY FILE
(A->B)

Too many files!!
```

#### ■ Problem

The current copying will exceed the maximum of forty files in the memory.

#### ■ Solution

Press the **C** key to return to the SYSTEM MENU, then delete unnecessary files in the memory.

## [ 9 ] Handling the JIS Font Files

You can delete, download, or upload the JIS Level 1 and Level 2 font files.

JIS font menu



Pressing the **[2]** key while holding down the **[SF]** key on the SYSTEM MENU calls up the screen shown at left.

**[1] DELETE** : Switches to the JIS1/JIS2 font deletion menu.

**[2] DOWNLOAD** : Switches to the JIS1/JIS2 font file download menu.

**[3] UPLOAD** : Switches to the JIS1/JIS2 font file upload menu.

Select a desired item by using the numerical keys or **[F5]** and **[F6]** keys, then press the **[ENT]** key.

Press the **[C]** key to return to the SYSTEM MENU.

### [9.1] Deleting the JIS1/JIS2 font file

Deletion menu



Selecting the "1: DELETE" on the JIS font menu calls up the screen shown at left.

**[1] JIS 1** : Deletes the JIS Level 1 font file.

**[2] JIS 2** : Deletes the JIS Level 2 font file.

Select the font file to be deleted by using the numerical keys or **[F5]** and **[F6]** keys, then press the **[ENT]** key.

To return to the JIS font menu, press the **[C]** key.

#### Confirmation screen

```
DELETE
JIS 1 DELETE
OK ?
1:Yes 2:No
```

Selecting a font file to be deleted calls up the confirmation screen shown at left.

On the 3rd line appears the font file to be deleted. This example shows that the "1: JIS 1" has been selected.

- 1 Yes : Deletes the selected font file.
- 2 No : Cancels deleting and returns to the deletion menu.

Select a desired item by using the numerical keys, then press the **ENT** key.

#### Deletion completion screen

```
DELETE
JIS 1 DELETE
** Completed **
```

Upon completion of deleting, the screen shown at left appears.

Press the **C** key to return to the JIS font menu.

#### NOTE

Before deleting the JIS Level 1 or Level 2 font file, be sure to upload it to the host computer to save it for the future use.

If you attempt to display any deleted Kanji font in user programs, "□" will appear.

#### REFERENCE

After the JIS Level 1 or Level 2 font is deleted, the memory area which was occupied by that font in the flash ROM can be used as a user area.

## [9.2] Downloading the JIS1/JIS2 font file

JIS font file download menu

```

DOWNLOAD
 1:JIS 1
 2:JIS 2
    
```

Selecting the "2: DOWNLOAD" on the JIS font menu calls up the screen shown at left.

1 JIS 1: Downloads the JIS Level 1 font file.

2 JIS 2: Downloads the JIS Level 2 font file.

Select a font file to be downloaded by using the numerical keys or **F5** and **F6** keys, then press the **ENT** key.

To return to the JIS font menu, press the **C** key.

Standby screen

```

DOWNLOAD
      JIS 1
**  Waiting  **
    
```

On the 3rd line appears the font file to be downloaded. This example shows that the "1: JIS 1" has been selected.

The BHT-6000 is waiting for the selected file to be downloaded.

Download start screen

```

DOWNLOAD
      JIS 1
**  Loading  **
    
```

Upon start of optional Ir-Transfer Utility C, Transfer Utility or equivalent program (upon receipt of an ENQ code from the host computer), the BHT-6000 displays the screen shown at left.

This example shows that the "1: JIS 1" has been selected.

Downloading screen

```

DOWNLOAD
      JIS 1
**  Loading  **
XXXXX/YYYYY
    
```

While the downloading is in progress, the screen shown at left is displayed indicating the file name and the number of received records/the total number of records.

To abort the download, press the **C** key and the screen will switch back to the JIS font menu.

Download completion screen

```
DOWNLOAD

JIS 1
** Completed **
YYYYY/YYYYY
```

Upon completion of downloading, the number of received records becomes equal to the total number of records and the beeper beeps once.

Press the **[C]** key to return to the JIS font menu.

### NOTE

In the flash ROM, the address area for storing the JIS Level 1 and Level 2 font data is fixed. If that font area has been used as user area, no font download is possible. In such cases, temporarily upload all of the user files stored in the flash ROM to the host computer, delete those files in the flash ROM, and download the JIS Level 1 and/or Level 2 font files to the BHT-6000. After that, download all of the uploaded user files to the BHT-6000.

## If an error occurs during downloading of JIS1/JIS2 font file

If some error occurs during downloading of the JIS1/JIS2 font file, the BHT-6000 beeps three times and shows one of the following messages:

Press the **[C]** key to return to the JIS font file download menu.

```
DOWNLOAD

JIS 1
Memory used !!
```

### ■ Problem

The memory area for the JIS font (JIS Level 1 font in this screen) has been occupied by user programs.

### ■ Solution

Copy the files stored in the flash ROM onto the RAM, and then delete the ROMed files.

```
DOWNLOAD

JIS 1
File mismatch !!
```

### ■ Problem

The file type is mismatched.

(Examples)

- At the host computer, you attempted to download not the JIS1/JIS2 font file, but user programs.
- Although the JIS Level 1 font file was already selected on the BHT-6000, the host computer attempted to download the JIS Level 2 font file.

### ■ Solution

Press the **[C]** key to return to the SYSTEM MENU. (To download user programs, select the regular downloading menu.)

```
DOWNLOAD
      JIS 1
Communication
      error !!
Retry? 1:Yes2:No
```

■ **Problem**

Downloading has failed.

■ **Solution**

To retry downloading, press the **[1]** key.

To return to the SYSTEM MENU, press the **[2]** key. Check the interface port and communications parameters in the SET SYSTEM menu or perform the communications test in the TEST menu. (Refer to Subsection 2.5.3, [4.6] and [5.5].)

It is also necessary to check the communications parameters setup of the host computer.

### [9.3] Uploading the JIS1/JIS2 font file

JIS font file upload menu

```
UPLOAD
1:JIS 1
2:JIS 2
```

Selecting the "3: UPLOAD" on the JIS font menu calls up the screen shown at left.

**[1]** JIS 1 : Uploads the JIS Level 1 font file.

**[2]** JIS 2 : Uploads the JIS Level 2 font file.

Select the font file to be uploaded by using the numerical keys or **[F5]** and **[F6]** keys, then press the **[ENT]** key.

To return to the JIS font menu, press the **[C]** key.

Standby screen

```
UPLOAD
      JIS 1
** Waiting **
```

On the 3rd line appears the font to be uploaded. This example shows that the "1: JIS 1" has been selected.

The BHT-6000 is ready to upload the selected file.

### Upload start screen

```
      UPLOAD

      JIS 1
** Loading **
```

Upon start of optional Ir-Transfer Utility C, Transfer Utility or equivalent program (upon receipt of an ACK code from the host computer), the BHT-6000 displays the screen shown at left.

This example shows that the "1: JIS 1" has been selected.

### Uploading screen

```
      UPLOAD

      JIS 1
** Loading **
XXXXX/YYYYY
```

While the uploading is in progress, the screen shown at left is displayed indicating the file name and the number of sent records/the total number of records.

To abort uploading, press the  key and the screen will switch back to the JIS font menu.

### Upload completion screen

```
      UPLOAD

      JIS 1
** Completed **
YYYYY/YYYYY
```

Upon completion of uploading, the number of sent records becomes equal to the total number of records and the beeper beeps once. Press the  key to return to the JIS font menu.

The uploaded font files are named as follows:

```
JIS Level 1 font file  _JIS1.FN3
JIS Level 2 font file  _JIS2.FN3
```

## If an error occurs during uploading of JIS1/JIS2 font file

If some error occurs during uploading of the JIS1/JIS2 font file, the BHT-6000 beeps three times and shows one of the following messages:

Press the  key to return to the JIS font file upload menu.

```
      UPLOAD

      JIS 1
Communication
      error !!
Retry? 1:Yes2:No
```

### ■ Problem

Uploading has failed.

### ■ Solution

To retry uploading, press the  key.

To return to the SYSTEM MENU, press the  key. Check the interface port and communications parameters in the SET SYSTEM menu or perform the communications test in the TEST menu. (Refer to Subsection 2.5.3, [4.6] and [5.5].)

It is also necessary to check the communications parameters setup of the host computer.

# Chapter 3

## Communications Operations of BHT-6000

This chapter describes the communications operations of the BHT-6000--the RS-232C interface specifications, the basic communications specifications, and the communications protocols--for data transmission with the host computer or other devices.

3.1	RS-232C Interface Specifications .....	82
[ 1 ]	Interface Connector and Pin Assignment .....	82
[ 2 ]	Interface Cable Connection .....	83
3.2	Basic Communications Specifications and Parameters .....	84
3.2.1	Basic Communications Specifications .....	84
3.2.2	Communications Parameters .....	86
3.3	Communications Protocols .....	87
3.3.1	BHT-protocol .....	87
[ 1 ]	Overview .....	87
[ 2 ]	Control Characters .....	88
[ 3 ]	Basic Format of Transmission Messages .....	90
[ 4 ]	Transmission Control Sequences .....	91
[ 5 ]	Aborting Data Transmission .....	99
[ 6 ]	BCC for Horizontal Parity Checking .....	100
[ 7 ]	Text Format .....	101
3.3.2	BHT-Ir Protocol .....	103
[ 1 ]	Overview .....	103
[ 2 ]	Control Characters .....	104
[ 3 ]	Basic Format of Transmission Messages .....	106
[ 4 ]	Transmission Control Sequences .....	107
[ 5 ]	Aborting Data Transmission .....	116
[ 6 ]	CRC .....	117
[ 7 ]	ID .....	117
[ 8 ]	Text Format .....	118



# 3.1 RS-232C Interface Specifications

## [ 1 ] Interface Connector and Pin Assignment

The BHT-6000 has a direct-connect interface port which is connectable to the 3-pole mini stereo plug (ø2.5 mm or 0.1") and supports a subset of the RS-232C interface as shown below.

Using a direct-connect interface cable having the mini stereo plugs makes it possible to connect the BHT-6000 to a host computer (or another BHT-6000) directly without any routing through the CU-6000.

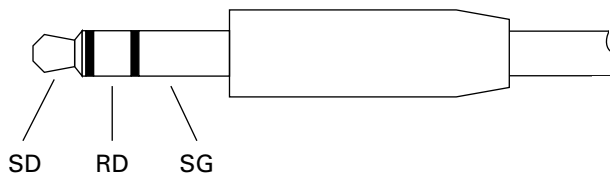

3-pole Mini Stereo Plug (ø2.5 mm or 0.1")

The poles of the plug are assigned as listed below.

Signal Name	Function	Signal Input/Output	
		BHT-6000	External device
SD	Send data	→	
RD	Receive data	←	
SG	Signal ground		

The input/output voltage threshold for the logical valued signal is listed below.

Logical Value	Input Voltage Threshold	Output Voltage Threshold
	(RD)	(SD)
0	3V min.	5V min.
1	-3V max.	-5V max.

**NOTE** The direct-connect interface port is not designed to stand frequent connecting/disconnecting. Do not plug and unplug basically more than one time a day; otherwise, the service life of the plug will shorten. To connect the BHT-6000 to a host computer (or another BHT-6000) frequently, use the CU-6000.

**NOTE** Allow the specified signals only to enter the direct-connect interface port. Entry of other signals will result in a failure or malfunction of the BHT-6000.

## [ 2 ] Interface Cable Connection

Connect the BHT-6000 directly to a host computer, a modem, or a printer with a direct-connect interface cable as illustrated below.

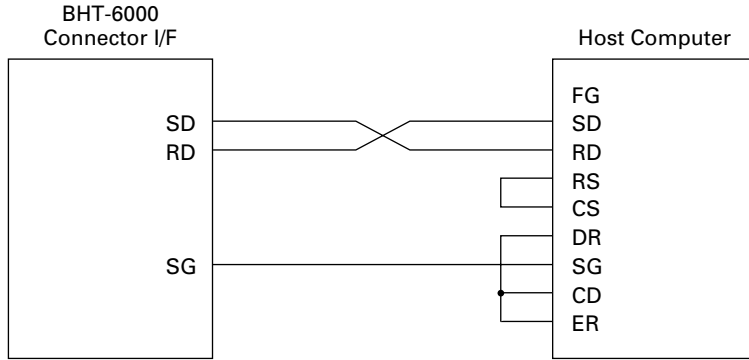

Cable Connection between BHT-6000 and Host Computer

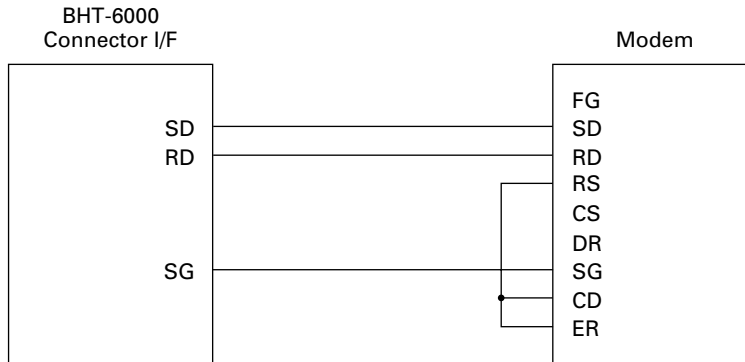

Cable Connection between BHT-6000 and Modem

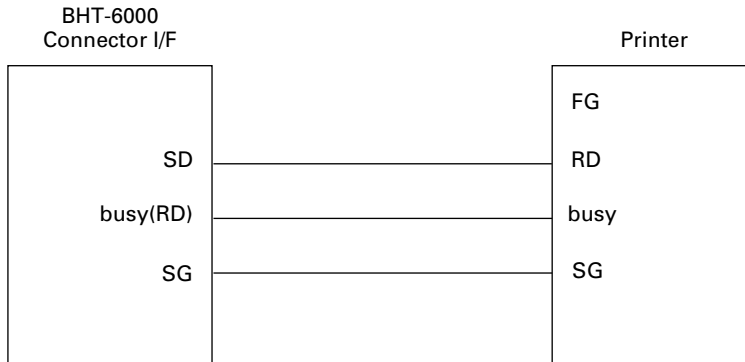

Cable Connection between BHT-6000 and Printer

## 3.2 Basic Communications Specifications and Parameters

### 3.2.1 Basic Communications Specifications

Listed below are the communications specifications when the BHT-6000 exchanges data with a host computer through the CU-6000 (optical interface) or direct-connect interface cable.

	Optical Interface	Direct-connect Interface
Synchronization	Start-stop	
Transmission Speed	2400, 9600, 19200, 38400, 57600, or 115200 bps	300, 600, 1200, 2400, 4800, 9600, 19200, or 38400 bps
Transmission Code	JIS 8-bit codes	JIS 7- or 8-bit codes
Transmission Bit Order	LSB (Least significant bit) first	
Response Method	ACK/NAK response	
Vertical Parity	None	Even, odd, or none
Transparency	Transparent or non-transparent mode	

#### ■ Synchronization

For accurate data transaction, it is very important to synchronize the transmission between the sender and receiver. To do this, it is required to previously define the bit order and position, the character length, and the beginning and end of the character to be transmitted.

The start-stop synchronization is an asynchronous system which synchronizes each character as a unit; that is, it externally adds start and stop bits to the leading and trailing bit positions of the character to be transmitted, respectively. A clock starts counting on receiving the start bit and it falls into a non-communication state on receiving the stop bit. The number of the stop bits is selectable (1 or 2 bits).

#### ■ Transmission Speed

Maximum number of bits to be transmitted per second. Expressed in bps (bits per second).

#### ■ Optical Interface Communications Range

The optical interface's maximum effective range is 80 cm with the IR beam within a 10° angle of divergence.

■ **Transmission Code and Bit Order**

All characters should be coded to 7- or 8-bit code for data transmission. The standard data exchange code of the BHT-6000 is JIS 7- or 8-bit code. The transmission bit order is LSB (Least significant bit) first.

What follows is an example for transmitting character A (41h, 01000001b) coded to JIS 8-level code with an even parity and a single bit each for start and stop bits.

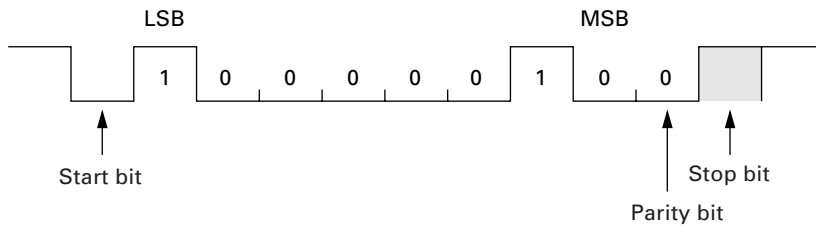

■ **Response Method**

When two devices initiate communications, they exchange signals for correct data transmission. This procedure is called "handshaking." The sender sends a control code ENQ (05h) to the receiver meaning "Are you ready to receive data?," and the receiver replies to it with a control code ACK (06h) or NAK (15h) meaning "Positive" or "Negative" for starting data transmission, respectively. This sequence is also called "data link establishment phase."

■ **Vertical Parity**

A vertical parity bit is a redundancy bit which is added to every character to be transmitted in order to check that data has been transmitted accurately. The parity bit should be set to "1" or "0" depending upon the parity parameter setting, to make the number of set bits in the character even or odd. The receiver counts the number of set bits in the transmitted character code to make sure that it has the selected number (even or odd) of set bits.

The vertical parity bit is positioned immediately following the MSB (Most significant bit) as shown below.

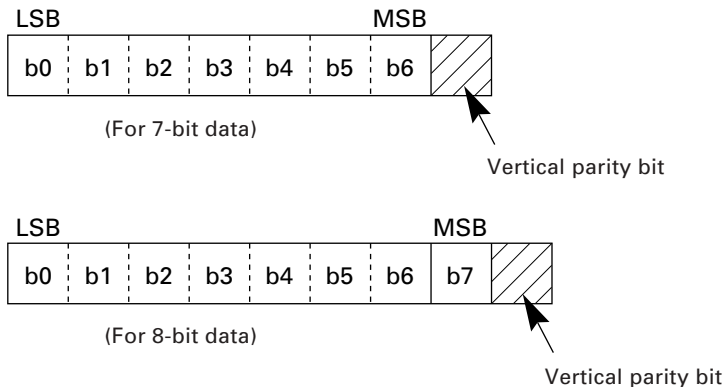

## 3.2.2 Communications Parameters

In System Mode and user programs written in BHT-BASIC 3.0, you may set the communications parameters listed below.

Communications Port	Optical interface	Direct-connect interface
Transmission Speed	2400, 9600, 19200, 38400, 57600, or 115200 bps	300*, 600*, 1200, 2400, 4800, 9600, 19200, or 38400 bps
Character Length	8 bits	7 or 8 bits
Vertical Parity	None	Odd, even, or none
Stop Bit Length	1 bit	1 or 2 bits

\* The 300 bps and 600 bps are not available in System Mode.

### In System Mode

Refer to Chapter 2, Subsection 2.5.3, "Detailed Description of the Functions in System Mode," [ 4.6 ] Setting the communications environments.

### In BHT-BASIC 3.0

To set the transmission speed, character length, vertical parity, and stop bit length (To set the transmission speed only for the optical interface), use the OPEN "COM:" statement in BHT-BASIC 3.0.

- OPEN "COM: ... "            Opens the interface port selected in System Mode.
- OPEN "COM1: ... "        Opens the optical interface port for data transmission routing through the CU-6000, irrespective of the setting in System Mode.
- OPEN "COM2: ... "        Opens the direct-connect interface port for data transmission, irrespective of the setting in System Mode.

Note that it is impossible to open both the optical interface port and the direct-connect interface port concurrently.

Through the interface port opened by the OPEN "COM:" statement, the XFILE statement transmits a designated file.

## 3.3 Communications Protocols

The BHT-6000 supports both the BHT-protocol and the BHT-Ir protocol for file transmission.

### 3.3.1 BHT-protocol

#### [ 1 ] Overview

The BHT-protocol is the communications procedure used to transmit files between the BHT-6000 and a host (or between the BHT-6000s). It adopts the response method using ACK/NAK codes.

The BHT-protocol is composed of a defined set of the control character sequences including the following three phases:

**Phase 1: Establishment of data link**

The sending station confirms that the receiving station is ready to receive data.

**Phase 2: Data transmission**

The sending station transmits data to the target receiving station.

**Phase 3: Release of data link**

The sending station confirms whether or not all of the transmitted data has been correctly received by the receiving station. If yes, the sending station terminates the data transmission and releases the data link.

## [ 2 ] Control Characters

The control characters are classified into two groups: transmission control characters and text control characters.

### (1) Transmission control characters

The transmission control characters listed below are used to compose transmission control sequences in phases 1 through 3.

Symbol	Value	Meaning	Function
EOT	04h	End Of Transmission	Releases a data link (Phase 3). Requests abort of transmission (Phase 2).
ENQ	05h	Enquiry	Requests establishment of a data link (Phase 1). Prompts the receiver to respond to the sent text (Phase 2).
ACK	06h	Acknowledge	Acknowledgment response to ENQ (Phase 1). Acknowledgment response to text (Phase 2). Acknowledgment response to EOT (Phase 3).
NAK	15h	Negative Acknowledge	Negative acknowledgment response to ENQ (Phase 1). Negative acknowledgment response to text (Phase 2).

### ■ Transparency

The BHT-6000 uses the non-transparent mode which handles the control characters and codes (e.g., STX, ETX, and SOH) as starting or ending markers and does not allow them to be transmitted as normal data in the transmission texts.

## (2) Text control characters

The text control characters are used to format transmission texts. In the BHT-protocol, they include the following headers and a terminator.

Symbol	Value	Meaning	Function
SOH	01h	Start Of Heading	Indicates the start of heading text (Phase 2).
STX	02h	Start Of Text	Indicates the start of data text (Phase 2).
ETX	03h	End Of Text	Indicates the end of data text (Phase 2).

You may designate headers and a terminator with the protocol functions in BHT-BASIC 3.0. If you designate none of them in a user program, the BHT-6000 may apply those as listed above. Refer to the "BHT-BASIC 3.0 Programmer's Manual."



### [ 3 ] Basic Format of Transmission Messages

Basically, the BHT-6000 transmits data as units of a file. First, it transmits a heading text which includes the attribute information of a file (e.g., file name and the number of data texts) to be transmitted. Following the heading text, it transmits the data text in the file. A heading text and data text comprise a text.

In actual text transmission, the text is divided into several blocks, then a header and terminator are added to each block. If the serial number management or error checking by BCC (Block Check Character) is required, the serial number or BCC is also added to each block, respectively. This procedure forms a transmission block. A set of transmission blocks makes up one transmission message.

Shown below is an example of a transmission message formed with the BHT-protocol.

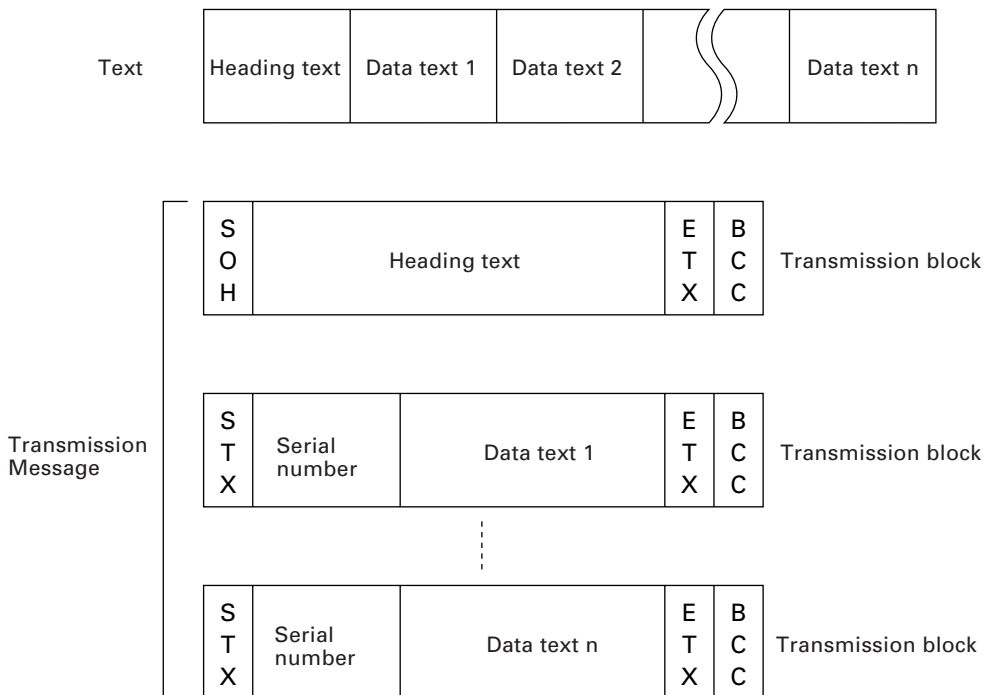

In the above figure, SOH, STX, and ETX are text control characters as described in [ 2 ] Control Characters. A serial number is expressed by a five-digit decimal number, starting from 00001 to 32767, and identifies transmitted data texts. For the BCC, refer to [ 6 ] BCC for Horizontal Parity Checking.

## [ 4 ] Transmission Control Sequences

Shown below is a typical message transmission sequence supported by the BHT-protocol. This sequence example does not include transmission errors or negative responses.

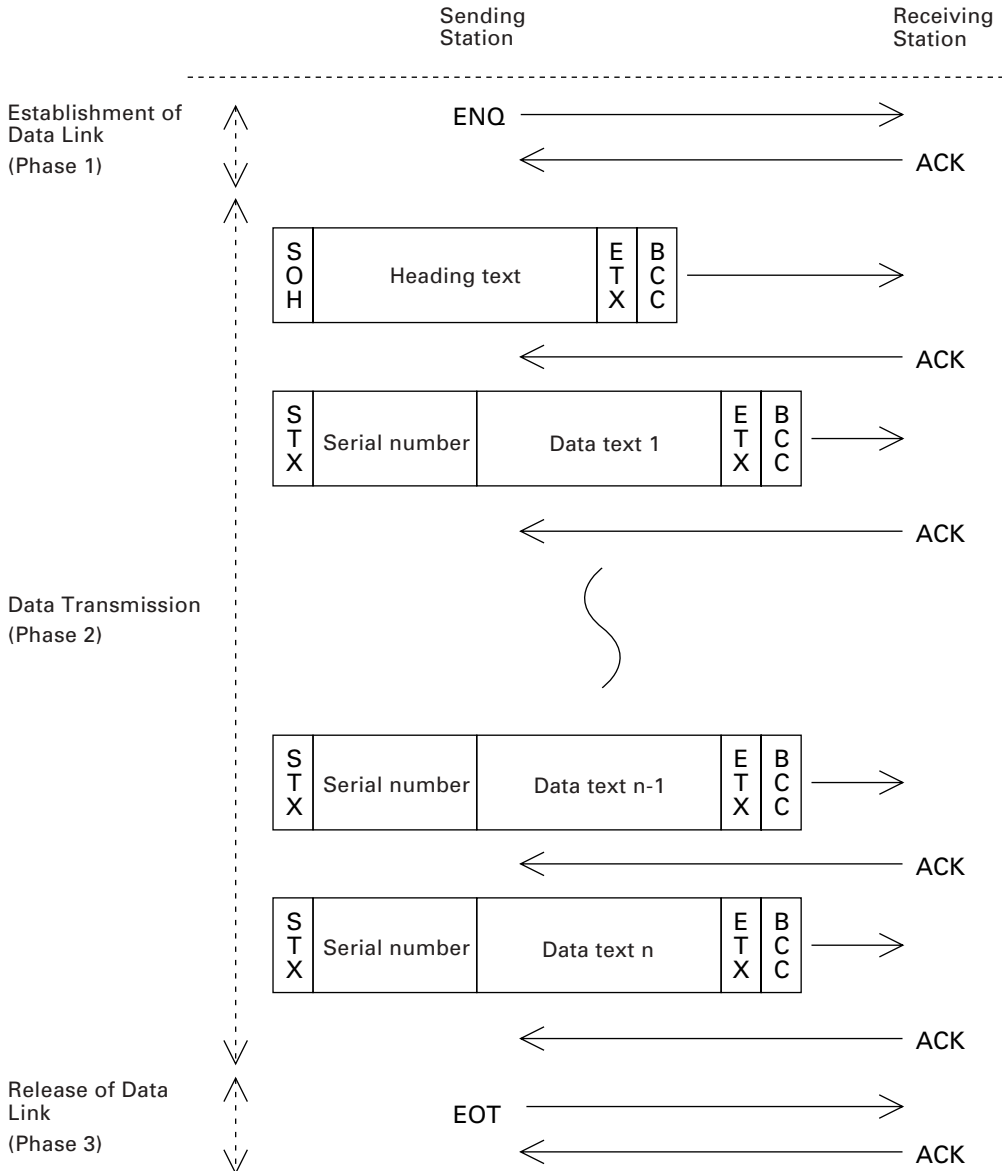

Data transmission may accidentally involve various types of errors. The BHT-protocol is designed to recover from those errors as frequently as possible. What follows is the BHT-protocol for phases 1 through 3.

### Phase 1: Establishment of Data Link

#### ■ Normal phase 1

The sending station transmits an ENQ to the receiving station. Upon receipt of an ACK from the receiving station, the sending station shifts to phase 2.

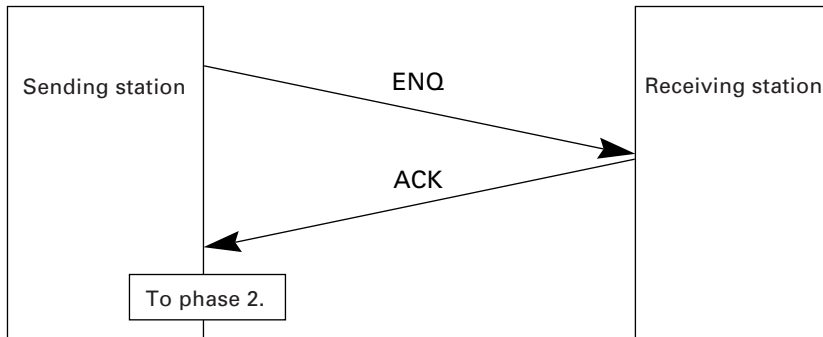

#### ■ Phase 1 with iterated ENQ transmission due to no response or invalid response

If the sending station receives no response or any invalid response from the receiving station in response to an ENQ sent, it iterates sending of an ENQ at three-second intervals up to 10 times.

If the sending station receives an ACK before sending an ENQ ten times, it shifts to phase 2.

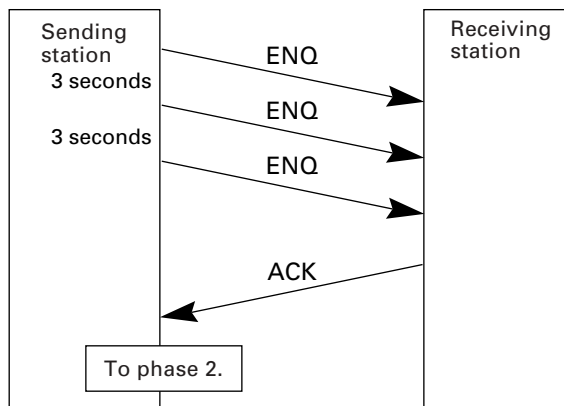

TIP

You may modify the number of ENQ iterations for the sending station. The default is 10 times at three-second intervals. For details, refer to the SET LINKUP TIME screen in System Mode (p. 51) and the XFILE statement given in "BHT-BASIC 3.0 Programmer's Manual."

### ■ Abnormal termination of phase 1 (Abort of phase 1)

If the sending station receives no ACK from the receiving station after sending an ENQ 10 times in succession, it sends an EOT to the receiving station after three seconds from the 10th ENQ to terminate the message transmission abnormally.

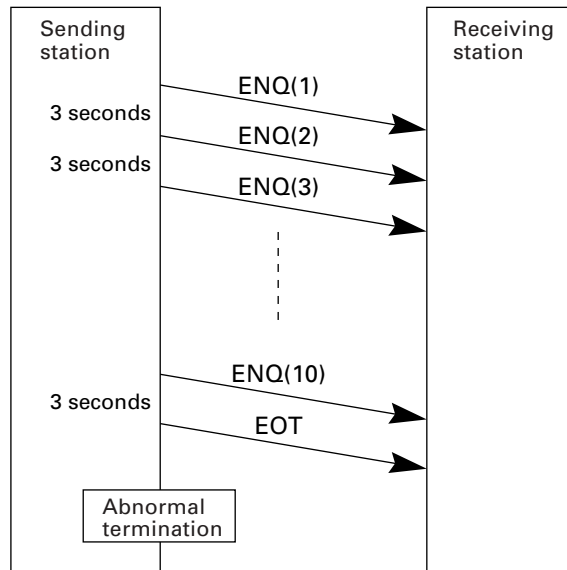

### TIP

The receiving station's default timeout is 30 seconds. You may modify the timeout length on the SET LINKUP TIME screen in System Mode (p. 51) or by using the XFILE statement (refer to the "BHT-BASIC 3.0 Programmer's Manual").

## Phase 2: Data Transmission

### ■ Normal phase 2

The sending station first sends a transmission block containing the heading text. Each time the sending station receives an ACK from the receiving station, it sends a transmission block containing the data texts as shown below. Upon receipt of an ACK in response to the last transmission block (data text n), the sending station shifts to phase 3.

If a transmission message contains no data text, the sending station transmits the heading text only.

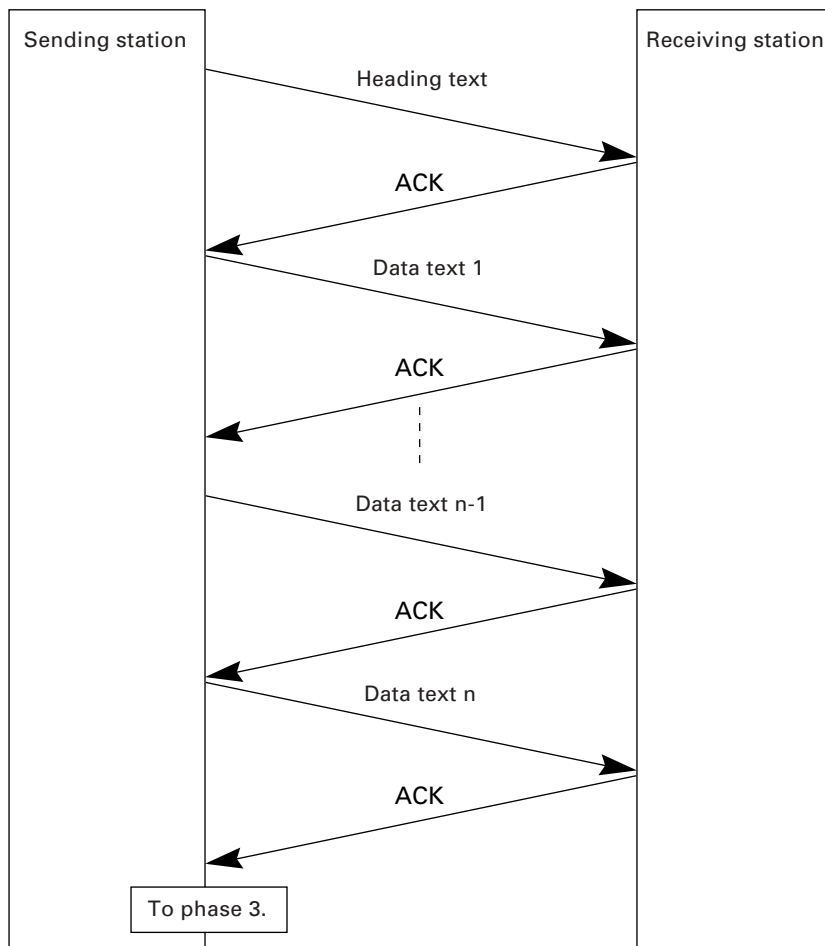

### ■ Phase 2 with NAK

If the sending station receives a NAK from the receiving station in response to a transmission block containing text data  $m$ , it sends that transmission block again immediately as shown below.

If the sending station receives an ACK before receiving a NAK 10 times in succession, it continues the subsequent message transmission.

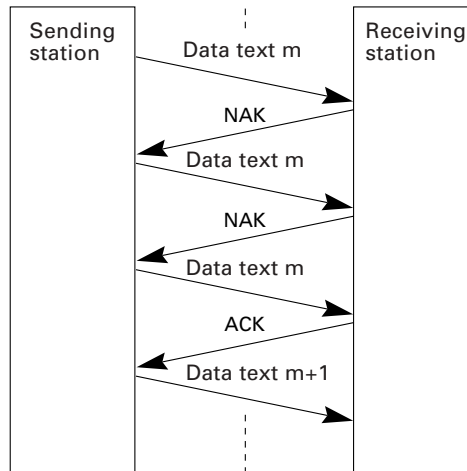

If the sending station receives a NAK 10 times in succession or it fails to send a same transmission block, it shifts to phase 3 to terminate the message transmission abnormally. Even if the phase 3 terminates normally, the transmission results in an abnormal end.

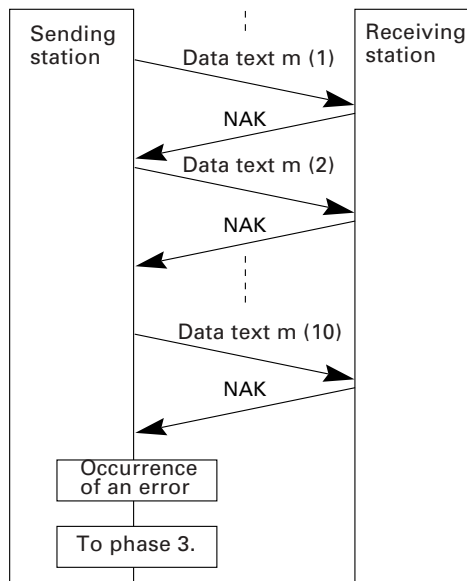

### ■ Phase 2 with EOT

If the sending station receives an EOT anytime during phase 2, it shifts to phase 3 to terminate the message transmission abnormally. Even if the phase 3 terminates normally, the transmission results in an abnormal end.

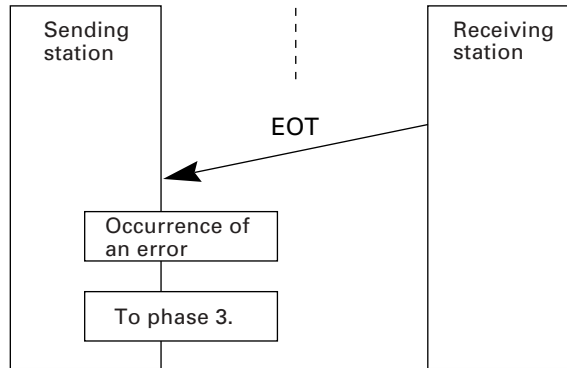

### ■ Phase 2 with iterated ENQ transmission due to no response or invalid response

If the sending station receives no response or any invalid response from the receiving station in response to a transmission block sent, it iterates sending of an ENQ at three-second intervals up to nine times.

If the sending station receives an ACK before sending an ENQ nine times, it continues the subsequent message transmission.

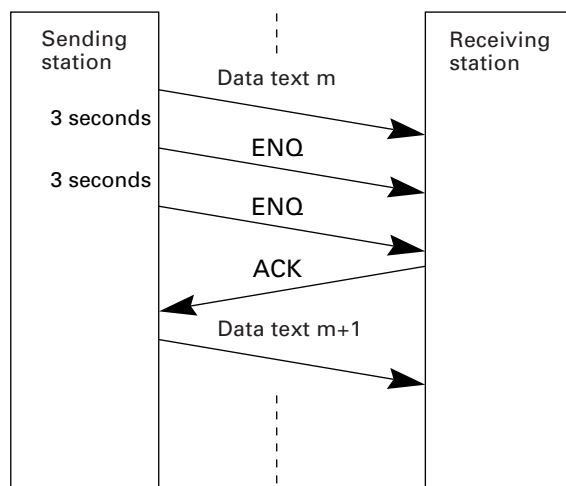

■ **Abnormal termination of phase 2 (Abort of phase 2)**

If the sending station receives no ACK from the receiving station after sending an ENQ nine times in succession, it sends an EOT to the receiving station after 3 seconds from the 9th ENQ to terminate this transmission sequence abnormally.

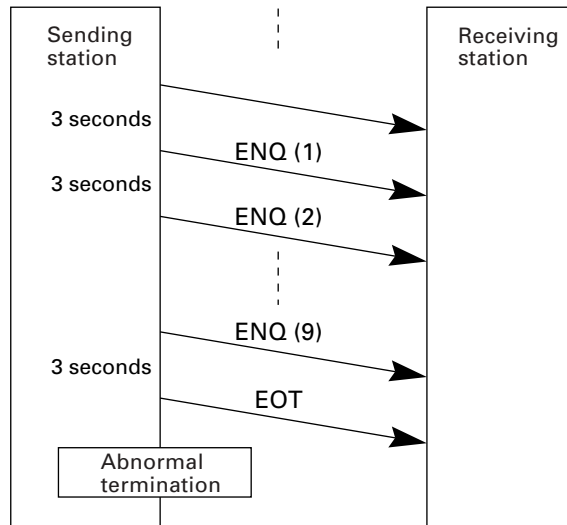

**Phase 3: Release of Data Link**

■ **Normal phase 3**

The sending station transmits an EOT to the receiving station. Upon receipt of an ACK from the receiving station, the sending station terminates the message transmission normally and releases the data link.

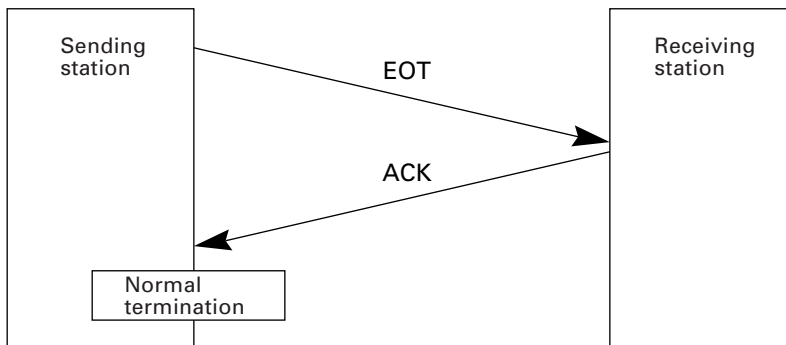



■ **Phase 3 with iterated EOT transmission due to no response or invalid response**

If the sending station receives no response or any invalid response from the receiving station in response to an EOT sent, it iterates sending of an EOT at three-second intervals up to ten times.

If the sending station receives an ACK before sending an EOT ten times, it terminates the message transmission normally and releases the data link.

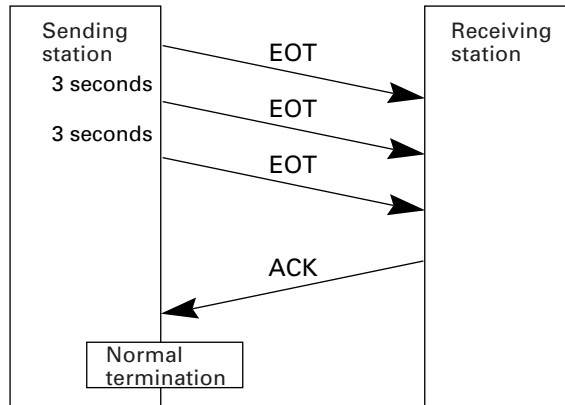

■ **Abnormal termination of phase 3**

If the sending station receives no ACK from the receiving station within three seconds from the 10th EOT, it terminates the message transmission abnormally and releases the data link.

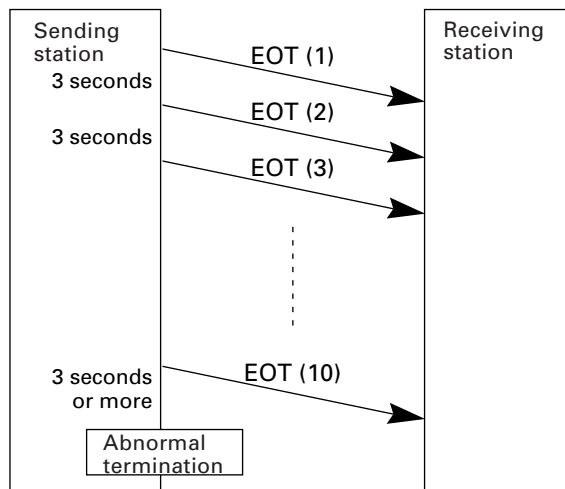

## [ 5 ] Aborting Data Transmission

Pressing the  C key aborts data transmission.

If the  C key is pressed during downloading, the BHT-6000 transmits an EOT and aborts the file transmission.

If it is pressed during uploading, the BHT-6000 transmits the current transmission block followed by EOT and then aborts the file transmission.

## [ 6 ] BCC for Horizontal Parity Checking

To check whether data has been transmitted accurately, the BHT-6000 supports horizontal parity checking for every transmission block.

In horizontal parity checking, a horizontal parity byte so called BCC (Block Check Character) is suffixed to an ETX of every transmission block.

In the BHT-protocol, every parity bit of BCC is set so that all set bits at the same bit level (including a parity bit) in the characters contained in the transmission block have an even number by binary addition, excluding SOH, STX, and functions SOH\$ and STX\$.

(For details about SOH\$ and STX\$ which are protocol functions unique to BHT-BASIC 3.0, refer to the "BHT-BASIC 3.0 Programmer's Manual.")

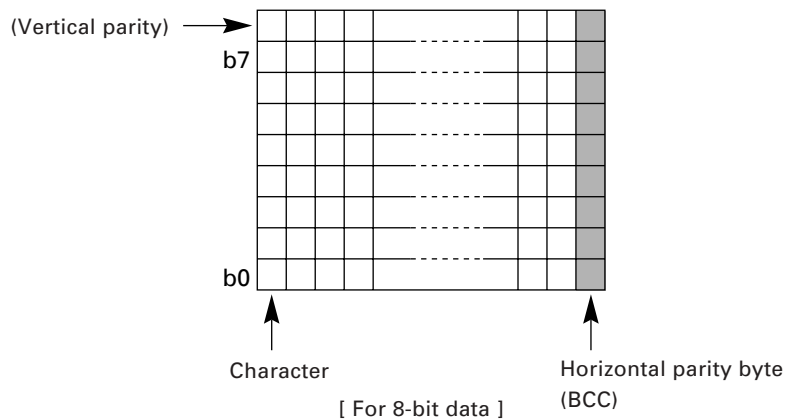

Shown below is a data text block indicating the bits to be added for horizontal parity checking.

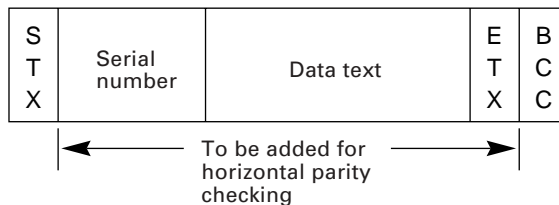

## [ 7 ] Text Format

Text should be formatted according to the standard of the BHT-protocol before transmission. Shown below are two types of the standard text formats for program files and data files.

### ■ Program Text Format

#### (1) Heading text

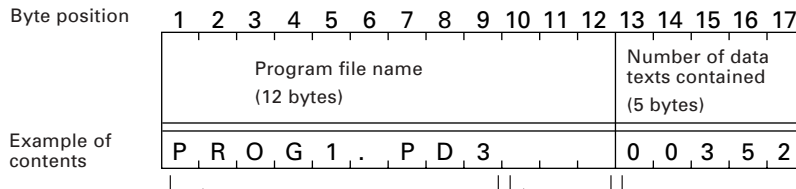

The program file name should be a maximum of 12 characters in length and it consists of FILE NAME and .EXTENSION. The FILE NAME should be 1 to 8 characters. The EXTENSION should be .PD3 (.FN3 and .EX3 may be available for future functional expansion).

If the program file name is less than 12 characters in length, the lower blank bytes will be filled with space characters.

The number of data texts should be 0 to 32767. If it is less than 5 digits, the upper blank bytes will be filled with zeros (0).

#### (2) Data text

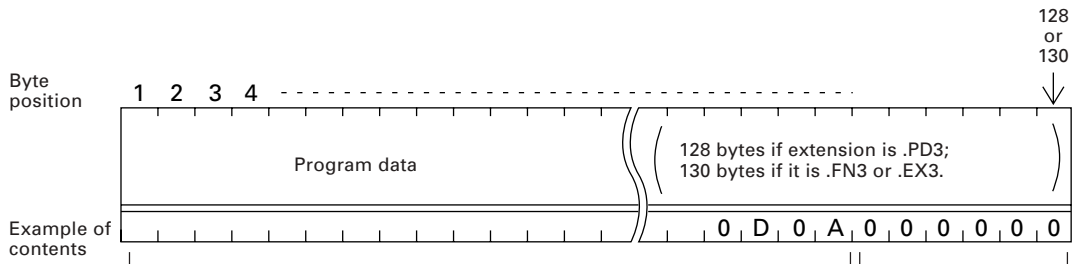

Object file (compiled from a source program file having one of the extensions .PD3, .FN3, and .EX3.)

If a program data field is less than the maximum digits in length, the lower blank bytes will be filled with zeros (0).

## ■ Data Text Format

### (1) Heading text

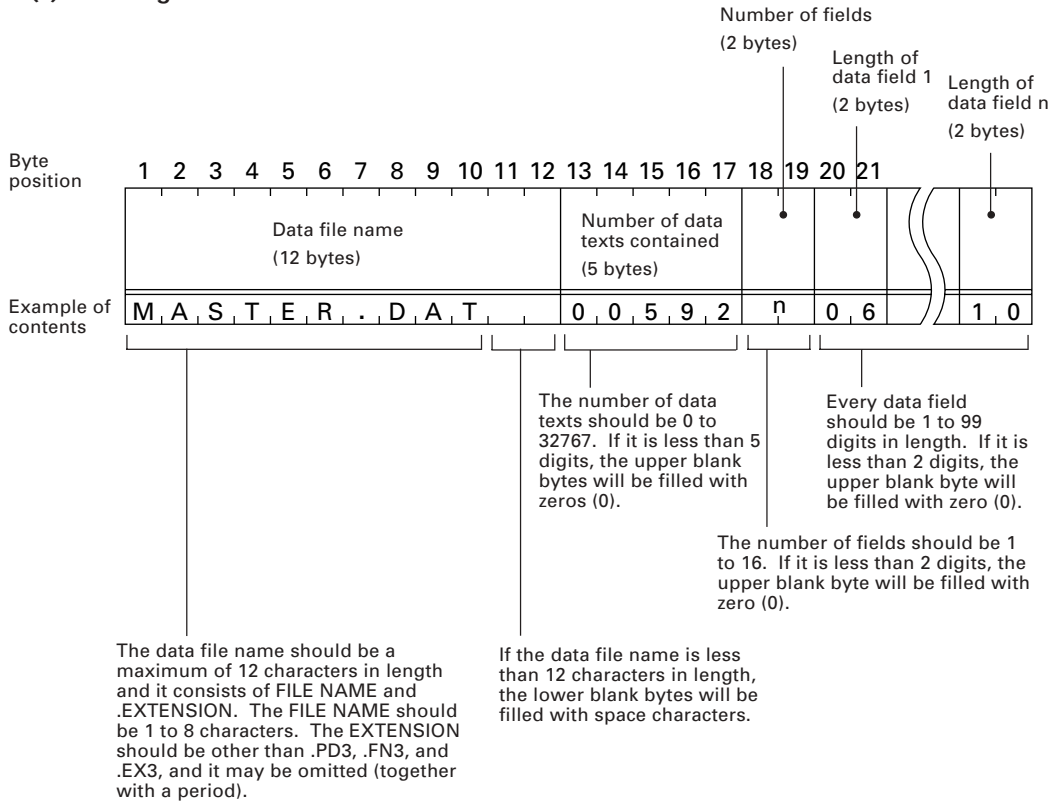

### (2) Data text

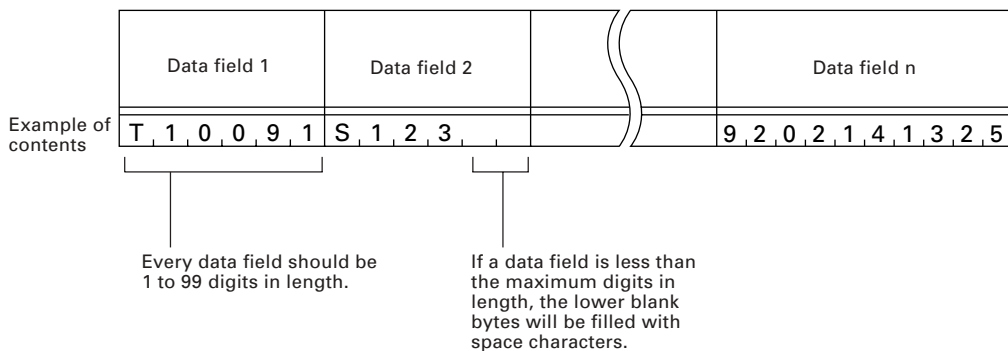

### NOTE

The total length of all data fields plus the number of the character count bytes (= the number of the fields) should be 255 bytes or less.

When you transfer five 50-digit (50-byte) fields, for example, the total length of all data fields is 250 (50 x 5) bytes and the number of the character count bytes is 5. Accordingly, the total is 255, so you can transfer the file.

## 3.3.2 BHT-Ir Protocol

### [ 1 ] Overview

The BHT-Ir protocol is the communications procedure for the serial infrared link, which is used to transmit files between the BHT-6000 and a host (or between the BHT-6000s). It adopts the response method using ACK/NAK codes. The BHT-Ir protocol can be used also for communications through the direct-connect interface.

The BHT-Ir protocol is composed of a defined set of the control character sequences including the following three phases:

**Phase 1: Establishment of data link**

The sending station confirms that the receiving station is ready to receive data.

**Phase 2: Data transmission**

The sending station transmits data to the target receiving station.

**Phase 3: Release of data link**

The sending station confirms whether or not all of the transmitted data has been correctly received by the receiving station. If yes, the sending station terminates the data transmission and releases the data link.

## [ 2 ] Control Characters

The control characters are classified into two groups: transmission control characters and text control characters.

### (1) Transmission control characters

The transmission control characters listed below are used to compose transmission control sequences in phases 1 through 3.

Symbol	Value	Meaning	Function
DLE EOT	1004h	End Of Transmission	Releases a data link (Phase 3). Requests abort of transmission (Phase 2).
DLE ENQ	1005h	Enquiry	Requests establishment of a data link (Phase 1). Prompts the receiver to respond to the sent text (Phase 2).
DLE ACK	1006h	Acknowledge	Acknowledgment response to DLE ENQ (Phase 1). Acknowledgment response to text (Phase 2). Acknowledgment response to DLE EOT (Phase 3).
DLE NAK	1015h	Negative Acknowledge	Negative acknowledgment response to DLE ENQ (Phase 1). Negative acknowledgment response to text (Phase 2).
WACK	103Bh	Wait for Acknowledge	Requests suspension of data reception during erasure of the flash ROM.

### ■ Transparency

The BHT-6000 uses the transparent mode which allows the control characters and codes (e.g., STX, ETX, SOH, and DLE) to be transmitted as normal data in the transmission texts.

To transmit a DLE as normal data, type DLE DLE per DLE.

## (2) Text control characters

The text control characters are used to format transmission texts. In the BHT-Ir protocol, they include the following headers and a terminator.

Symbol	Value	Meaning	Function
DLE SOH	1001h	Start Of Heading	Indicates the start of heading text (Phase 2).
DLE STX	1002h	Start Of Text	Indicates the start of data text (Phase 2).
DLE ETX	1003h	End Of Text	Indicates the end of data text (Phase 2).

In the BHT-Ir protocol, you cannot change the values of the headers and terminator with the protocol functions in BHT-BASIC 3.0.



### [ 3 ] Basic Format of Transmission Messages

Basically, the BHT-6000 transmits data as units of a file. First, it transmits a heading text which includes the attribute information of a file (e.g., file name and the number of data texts) to be transmitted. Following the heading text, it transmits the data text in the file. A heading text and data text comprise a text.

In actual text transmission, the text is divided into several blocks, then a header, terminator, serial number, receiver station's ID, and CRC-16 (Cyclic Redundancy Check) are added to each block. This procedure forms a transmission block. A set of transmission blocks makes up one transmission message.

Shown below is an example of a transmission message formed with the BHT-Ir protocol.

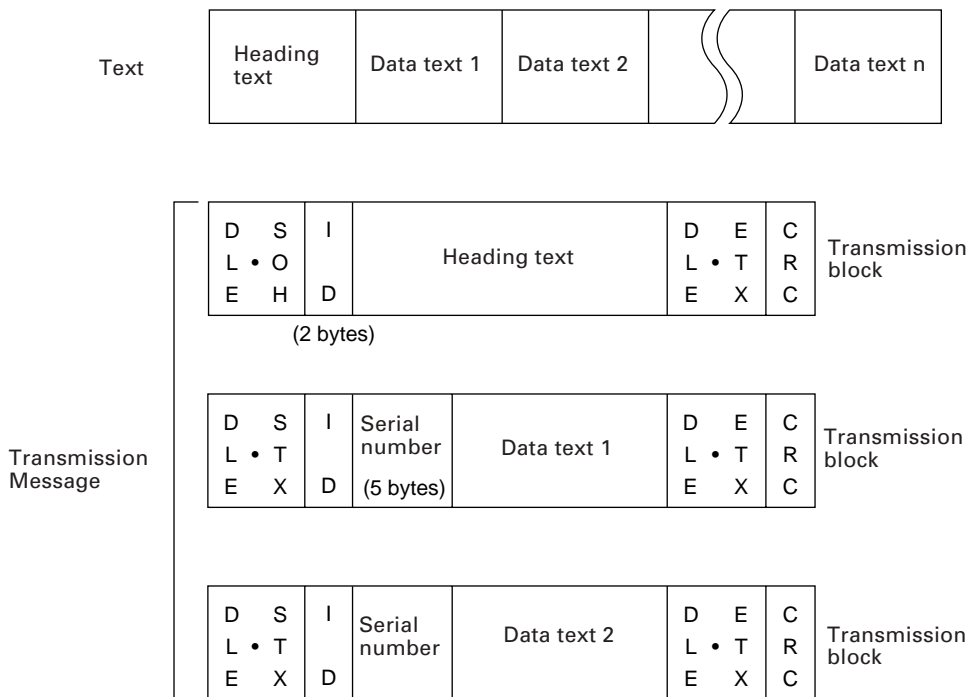

In the above figure, DLE SOH, DLE STX and DLE ETX are text control characters as described in [ 2 ] Control Characters. An ID denotes the ID number of the receiver station, expressed by two bytes. A serial number is expressed by a five-digit decimal number, starting from 00001 to 32767, and identifies data texts. For the CRC-16, refer to [ 6 ] CRC.

**TIP** You can use the control characters for expressing IDs serial numbers, or text data. For DLEs, type DLE DLE per DLE.

## [ 4 ] Transmission Control Sequences

Shown below is a typical message transmission sequence supported by the BHT-Ir protocol. This sequence example does not include transmission errors or negative responses.

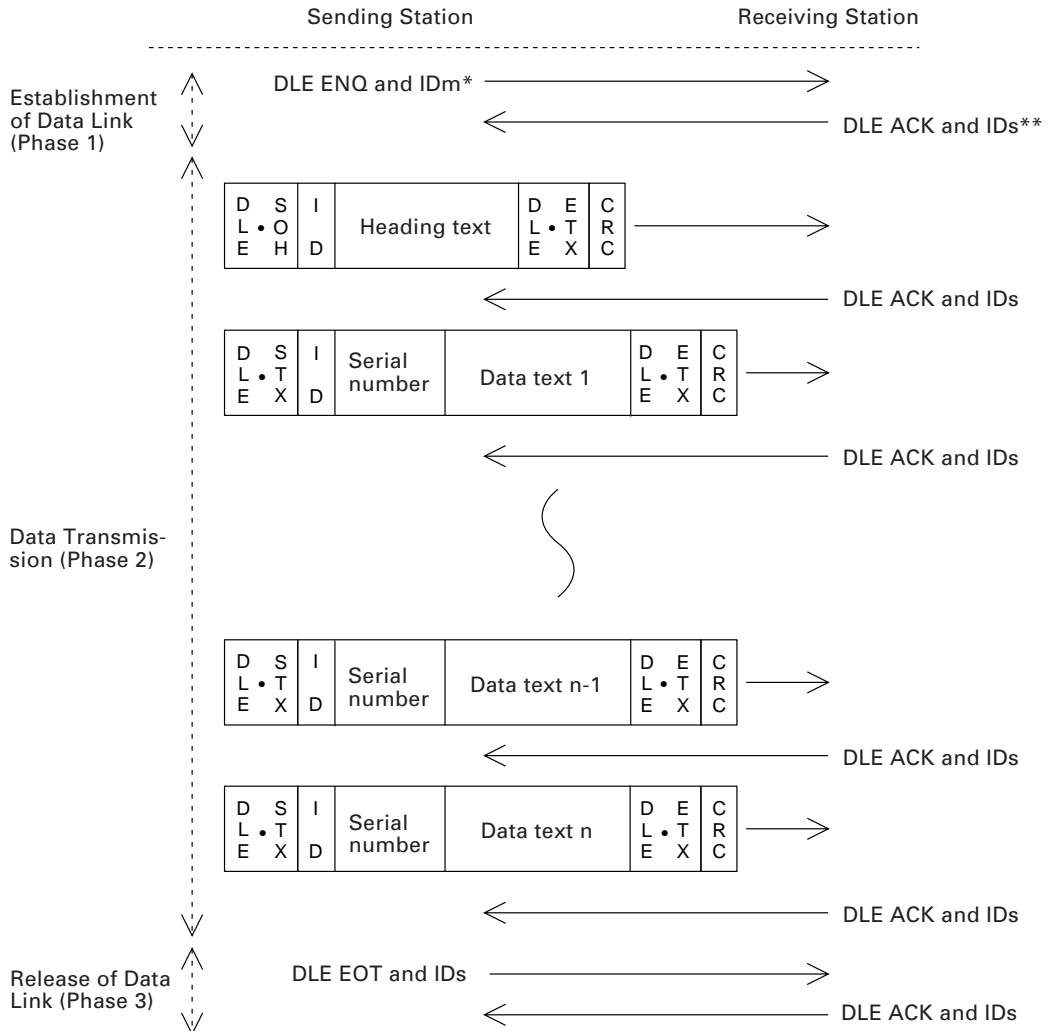

\*IDm: ID of sending station

\*\*IDs: ID of receiving station

Data transmission may accidentally involve various types of errors. The BHT-Ir protocol is designed to recover from those errors as frequently as possible. What follows is the BHT-Ir protocol for phases 1 through 3.

### Phase 1: Establishment of Data Link

#### ■ Normal phase 1

The sending station transmits a sequence of DLE ENQ and IDm (sending station's ID) to the receiving station. Upon receipt of a sequence of DLE ACK and IDr (receiving station's ID) from the receiving station, the sending station shifts to phase 2.

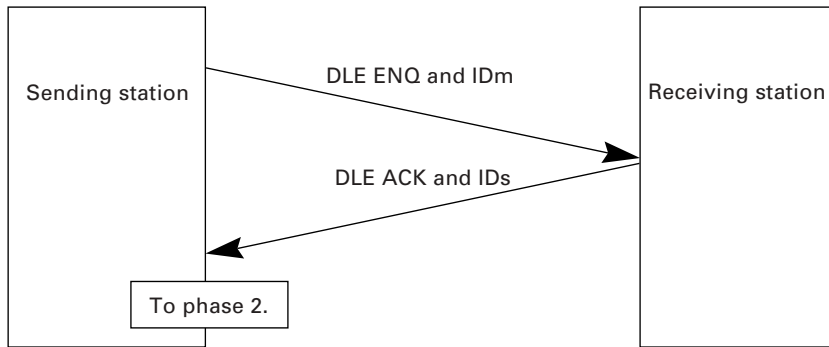

#### ■ Phase 1 with iterated transmission of DLE ENQ and IDm due to no response or invalid response

If the sending station receives no response or any invalid response from the receiving station in response to the sent sequence of DLE ENQ and IDm, it iterates sending of the sequence at 0.5-second intervals up to 60 times.

If the sending station receives a sequence of DLE ACK and IDr before sending the sequence of DLE ENQ and IDm 60 times, it shifts to phase 2.

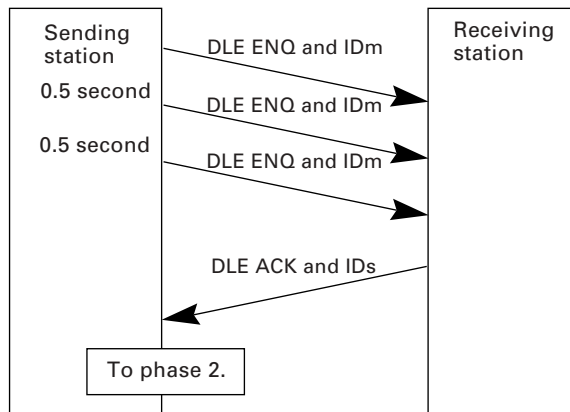

#### TIP

You may modify the number of iterations of a sequence of DLE ENQ and IDm for the sending station. The default is 60 times at 0.5-second intervals. For details, refer to the SET LINKUP TIME screen in System Mode (p. 51) and the XFILE statement given in "BHT-BASIC 3.0 Programmer's Manual."

■ **Abnormal termination of phase 1 (Abort of phase 1)**

If the sending station receives no sequence of DLE ACK and IDs from the receiving station after sending a sequence of DLE ENQ and IDm 60 times in succession, it sends a sequence of DLE EOT and IDm to the receiving station after 0.5 second from the 60th sequence of DLE ENQ and IDm, then aborts the message transmission abnormally.

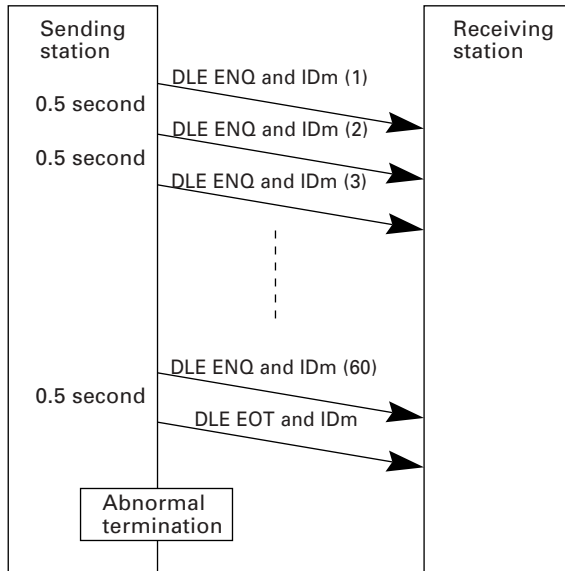

**TIP** The receiving station's default timeout is 30 seconds. You may modify the timeout length on the SET LINKUP TIME screen in System Mode (p. 51) or by using the XFILE statement (refer to the "BHT-BASIC 3.0 Programmer's Manual").

## Phase 2: Data Transmission

### ■ Normal phase 2

The sending station first sends a transmission block containing the heading text. Each time the sending station receives a sequence of DLE ACK and IDs from the receiving station, it sends a transmission block containing the data texts as shown below. Upon receipt of a sequence of DLE ACK and IDs in response to the last transmission block (data text n), the sending station shifts to phase 3.

If a transmission message contains no data text, the sending station transmits the heading text only.

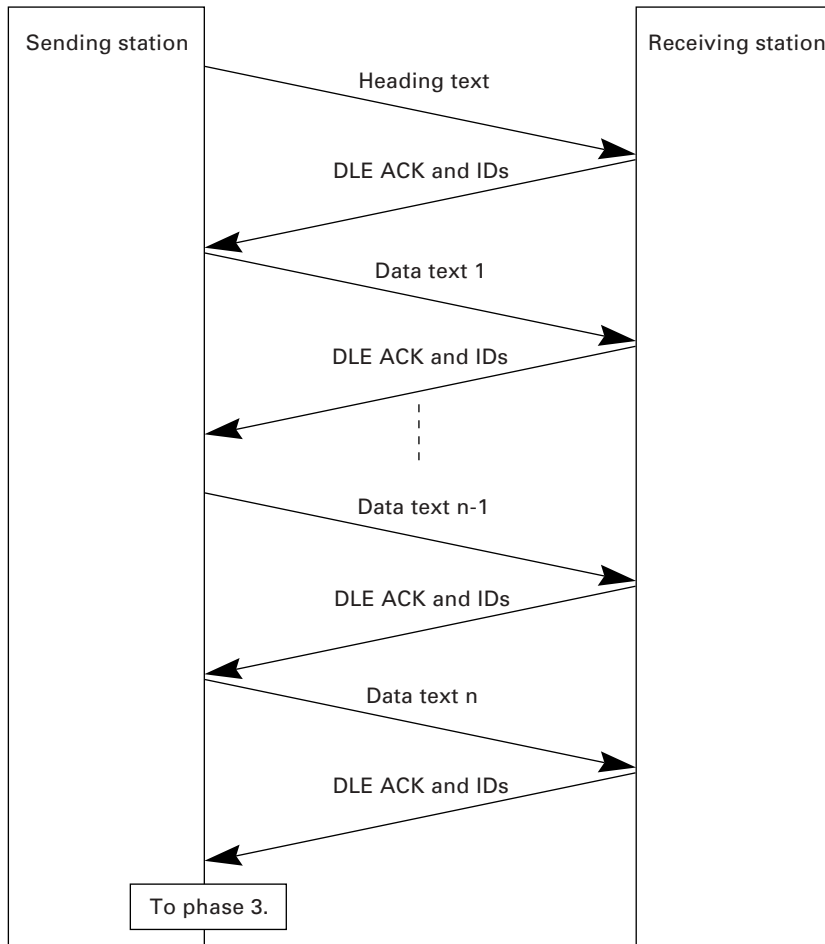

### ■ Phase 2 with suspension of data reception for erasure of the flash ROM

If the receiving BHT-6000 requires the flash ROM to be erased for receiving downloaded files, it sends a sequence of WACK and IDs to the sending station to suspend the data transmission.

Upon receipt of the sequence of WACK and IDs, the sending station stops the data transmission until any response comes from the receiving station for one minute. If no response comes within one minute, the sending station sends a sequence of DLE EOT and IDs and then aborts the current transmission.

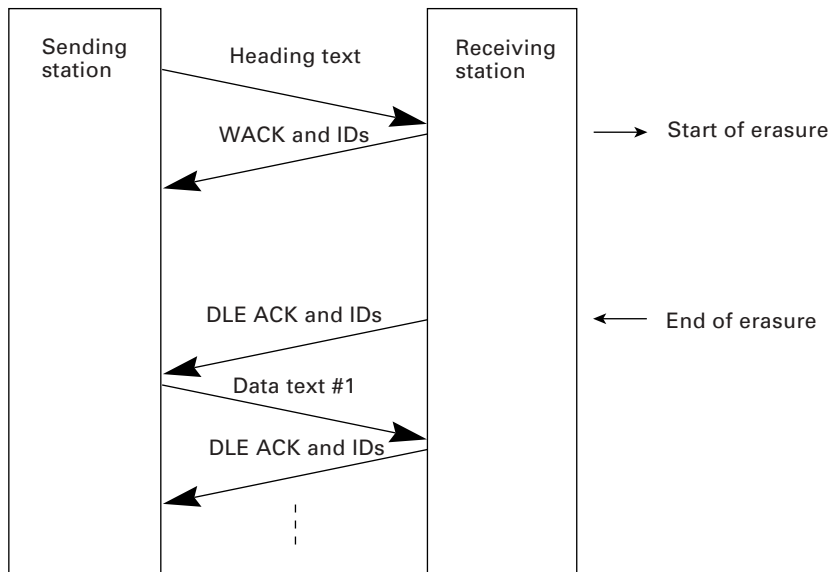

### ■ Phase 2 with a sequence of DLE NAK and IDs

If the sending station receives a sequence of DLE NAK and IDs from the receiving station in response to a transmission block containing text data  $m$ , it sends that transmission block again immediately as shown below.

If the sending station receives a sequence of DLE ACK and IDs before receiving the sequence of DLE NAK and IDs 10 times in succession, it continues the subsequent message transmission.

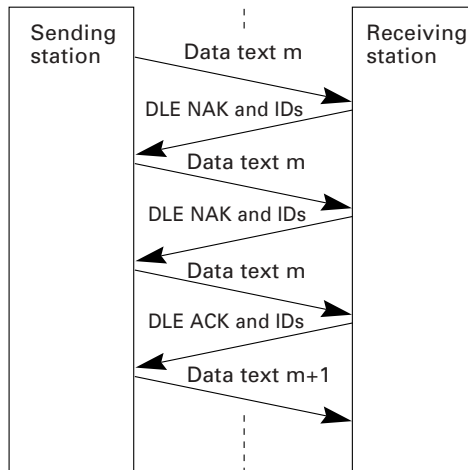

If the sending station receives a sequence of DLE NAK and IDs 10 times in succession or it fails to send a same transmission block, it shifts to phase 3 to terminate the message transmission abnormally. Even if the phase 3 terminates normally, the transmission results in an abnormal end.

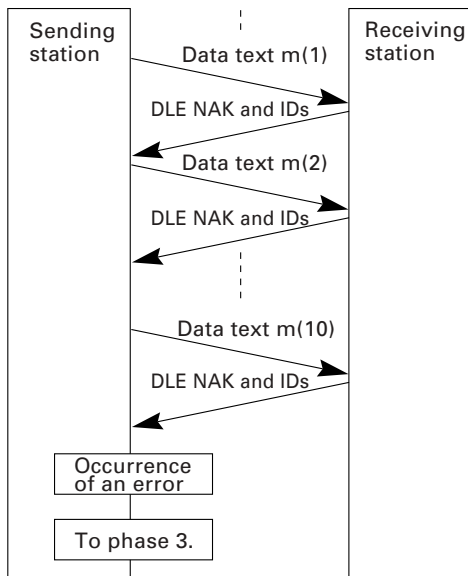

### ■ Phase 2 with a sequence of DLE EOT and IDs

If the sending station receives a sequence of DLE EOT and IDs anytime during phase 2, it shifts to phase 3 to terminate the message transmission abnormally. Even if the phase 3 terminates normally, the transmission results in an abnormal end.

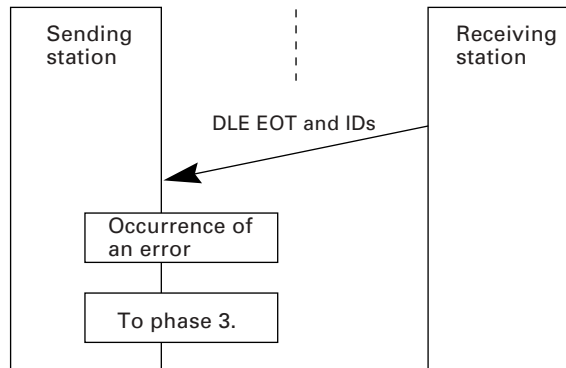

### ■ Phase 2 with iterated transmission of DLE ENQ and IDs due to no response or invalid response

If the sending station receives no response or any invalid response from the receiving station in response to a transmission block sent, it iterates sending of a sequence of DLE ENQ and IDs at 0.5-second intervals up to 59 times.

If the sending station receives a sequence of DLE ACK and IDs before sending the sequence of DLE ENQ and IDs 59 times, it continues the subsequent message transmission.

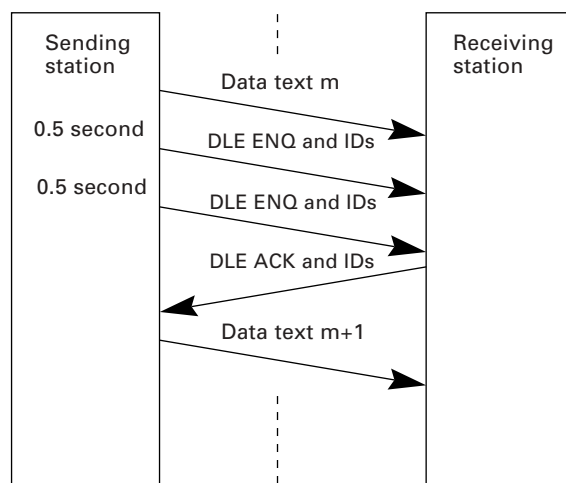



### ■ Abnormal termination of phase 2 (Abort of phase 2)

If the sending station receives no sequence of DLE ACK and IDs from the receiving station after sending a sequence of DLE ENQ and IDs 59 times in succession, it sends a sequence of DLE EOT and IDs to the receiving station after 0.5 second from the 59th sequence of DLE ENQ and IDs and then aborts this transmission abnormally.

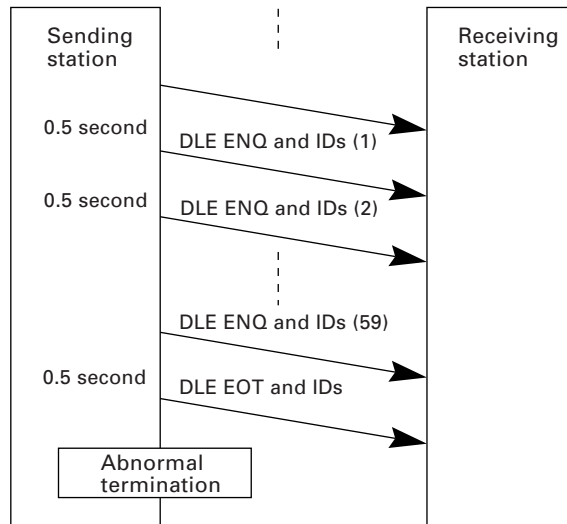

### Phase 3: Release of Data Link

#### ■ Normal phase 3

The sending station transmits a sequence of DLE EOT and IDs to the receiving station. Upon receipt of a sequence of DLE ACK and IDs from the receiving station, the sending station terminates the message transmission normally and releases the data link.

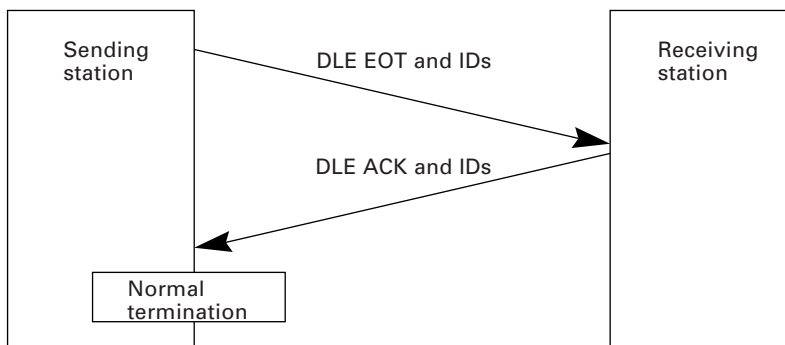

### ■ Phase 3 with iterated transmission of DLE EOT and IDs due to no response or invalid response

If the sending station receives no response or any invalid response from the receiving station in response to the sent sequence of DLE EOT and IDs, it iterates sending of the sequence at 0.5-second intervals up to 60 times.

If the sending station receives a sequence of DLE ACK and IDs before sending the sequence of DLE EOT and IDs 60 times, it terminates the message transmission normally and releases the data link.

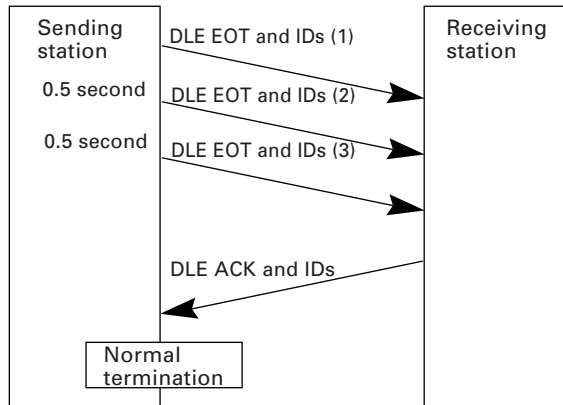

### ■ Abnormal termination of phase 3

If the sending station receives no sequence of DLE ACK and IDs from the receiving station within 0.5 second from the 60th sequence of DLE EOT and IDs, it aborts the message transmission abnormally and releases the data link.

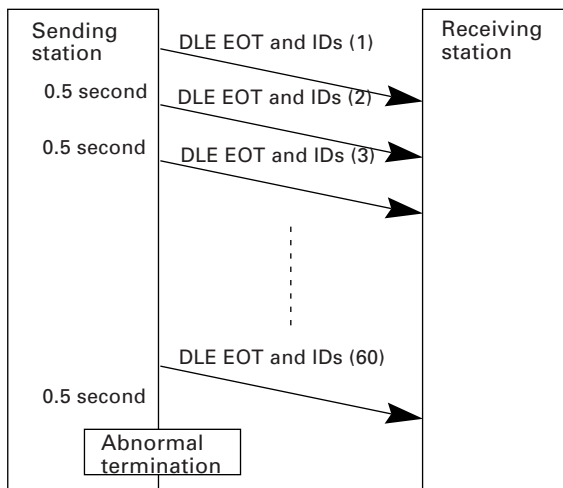

### ■ Phase 3 with timeout at the receiving station

If the receiving station receives no subsequent text or normal sequence of DLE EOT and IDs within 30 seconds after sending a sequence of DLE ACK and IDs, it sends a sequence of DLE EOT and IDs and aborts the transmission abnormally.

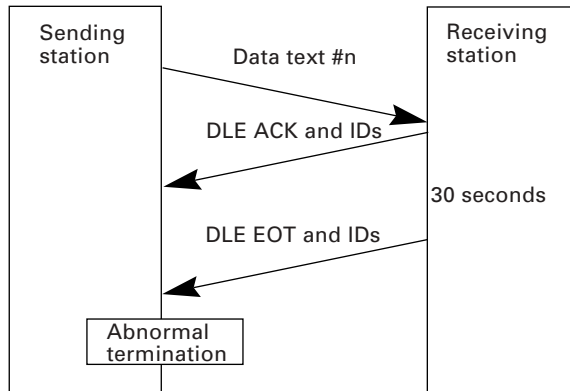

### [ 5 ] Aborting Data Transmission

Pressing the **C** key aborts data transmission.

If the **C** key is pressed during downloading, the BHT-6000 transmits a sequence of DLE EOT and IDs and aborts the file transmission.

If it is pressed during uploading, the BHT-6000 transmits the current transmission block followed by a sequence of DLE EOT and IDs and then aborts the file transmission.

## [ 6 ] CRC

To check whether data has been transmitted accurately, the BHT-Ir protocol supports CRC (Cyclic Redundancy Check) which employs the CRC-16 generating system. In CRC, a CRC character is suffixed to a sequence of DLE ETX of every transmission block.

### Operands for CRC-16

The CRC generates CRC-16 from all bytes of a transmission block excluding DLE SOH or DLE STX characters (which are at the head of a transmission block), DLE character of DLE ETX and DLE character of DLE DLE in the text.

### CRC operation

The CRC system generates CRC-16 as follows: It multiplies the polynomial formed by aligning all of the bits starting from the LSD of the first byte to the MSD of the last byte in a transmission block in descending order, by  $X^{16}$ . Next, divide the polynomial by the generative polynomial  $X^{16} + X^{15} + X^2 + 1$ . The remainder is the value of CRC-16.

Shown below is a data text transmission block and operands for CRC-16 generation.

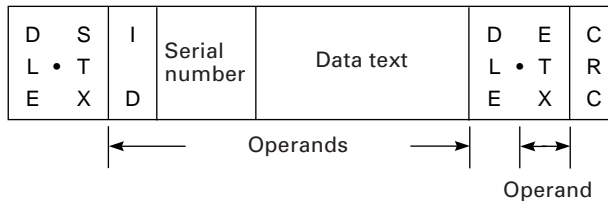

## [ 7 ] ID

ID is a 2-digit hexadecimal and designated in 0000h through FFFFh in (2 bytes). 0000h is assigned to the host computer. Any of 0001h through FFFFh is assigned to the BHT-6000 as follows.

- The system sets an ID when the BHT-6000 is initialized.
- You may set an arbitrary ID in System Mode or by using the OUT statement in BHT-BASIC 3.0.

## [ 8 ] Text Format

Text should be formatted according to the standard of the BHT-Ir protocol before transmission. Shown below are two types of the standard text formats for program files and data files.

### ■ Program Text Format

#### (1) Heading text

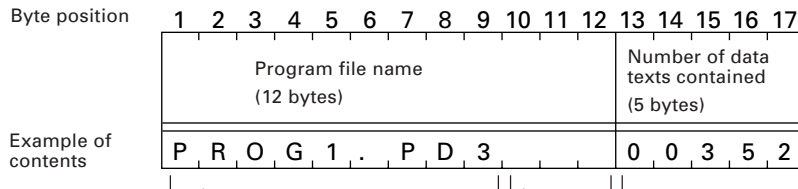

The program file name should be a maximum of 12 characters in length and it consists of FILE NAME and .EXTENSION. The FILE NAME should be 1 to 8 characters. The EXTENSION should be .PD3 or .FN3 (.EX3 may be available for future functional expansion).

If the program file name is less than 12 characters in length, the lower blank bytes will be filled with space characters.

The number of data texts should be 0 to 32767. If it is less than 5 digits, the upper blank bytes will be filled with zeros (0).

#### (2) Data text

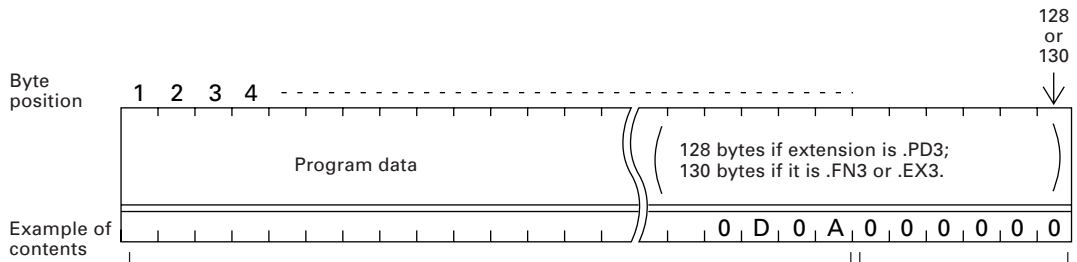

Object file (compiled from a source program file having one of the extensions .PD3, .FN3, and .EX3.)

If a program data field is less than the maximum digits in length, the lower blank bytes will be filled with zeros (0).

## ■ Data Text Format

### (1) Heading text

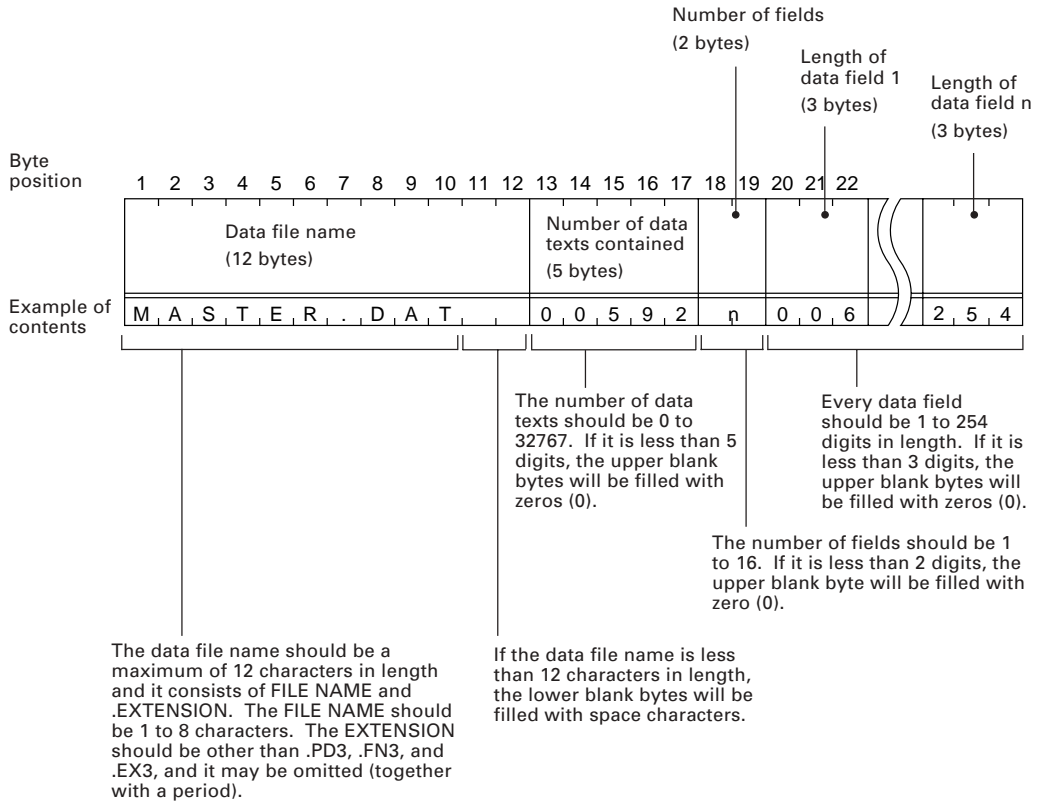

### (2) Data text

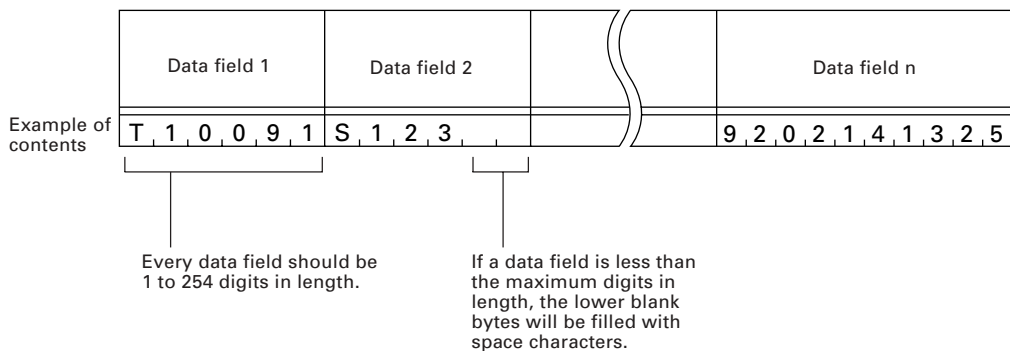

#### NOTE

The total length of all data fields plus the number of the character count bytes (= the number of the fields) should be 255 bytes or less.

When you transfer five 50-digit (50-byte) fields, for example, the total length of all data fields is 250 (50 x 5) bytes and the number of the character count bytes is 5. Accordingly, the total is 255, so you can transfer the file.



This chapter lists the error messages which will appear on the LCD if some error occurs in the BHT-6000.

4.1	System Errors .....	122
4.2	Errors in System Mode .....	126

# Chapter 4

## Error Messages



# 4.1 System Errors

If some error occurs when the power is turned on or during program execution, one of the following error messages will appear on the LCD.

```
*****  
** No System! **  
*****
```

## System Program error

### ■ Problem

A System Program error has occurred.

### ■ Solution

Contact your nearest dealer.

(When dry batteries are loaded)

```
Replace the  
batteries!
```

## Low battery indication

### ■ Problem

When the power is turned on or an application program is initiated, the battery voltage level has lowered.

### NOTE

If the battery output voltage level lowers during program execution, the BHT-6000 beeps five times (for 0.1 second per beep).

(When the Ni-MH battery cartridge is loaded)

```
Charge the  
battery!
```

### ■ Solution

If the BHT-6000 is loaded with dry batteries, immediately turn off the power and replace the batteries.

If the BHT-6000 is loaded with the Ni-MH battery cartridge, immediately turn off the power and then replace or charge the battery cartridge. (For the charging procedure, refer to Chapter 5, Section 5.5.)

```

Reload the
  battery
    to restart!
XXXXXXXX      01

```

### System Program malfunction

#### ■ Problem

During execution of System Program, the System Program has attempted to write onto the write-protected area of the RAM.

(xxxxxx: Error address)

#### ■ Solution

Unload and reload the dry batteries or the battery cartridge, then turn on the power.

```

Reload the
  battery
    to restart!
XXXXXXXX      02

```

#### ■ Problem

During execution of System Program, the System Program has received an invalid command code.

(xxxxxx: Error address)

#### ■ Solution

Unload and reload the dry batteries or the battery cartridge, then turn on the power.

```

Flash ROM error!
Contact your
  administrator.

```

### Flash ROM error

#### ■ Problem

The system has failed to write onto the flash ROM.

#### NOTE

If this error occurs, the BHT-6000 beeps five times (for 0.1 second per beep) and then turns itself off.

#### ■ Solution

Turn on the power again. If this error occurs frequently, contact your nearest dealer.

RTC error!  
Contact your  
administrator.

## RTC error

### ■ Problem

The system has failed to set the date & time to the real time clock RTC (the so-called "calendar clock") or has failed to read out from it.

#### NOTE

If this error occurs, the BHT-6000 beeps five times (for 0.1 second per beep) and then turns itself off.

### ■ Solution

Turn on the power again. If this error occurs frequently, contact your nearest dealer.

System error!  
Contact your  
administrator.  
Note the  
error drive.  
(DRIVE X)

## Memory backup test 1

### ■ Problem

An error is found in the system area of the RAM or flash ROM during the memory backup test activated when the power is turned on.

(This error message will appear also when the power is first applied from the time of purchase.)

#### NOTE

This error message will appear either in English or Japanese.

### ■ Solution

Initialize the BHT-6000. (For the initialization procedure, refer to Chapter 2, Subsection 2.4.2, [ 1 ].)

If the error persists even after initialization, contact your nearest dealer.

ファイルシステムの  
異常です。(X)  
管理者に連絡して  
ください。

## Memory backup test 2

### ■ Problem

An error is found in the user area of the RAM or flash ROM during the memory backup test activated when an application program is initiated.

### ■ Solution

Operate the BHT-6000 in System Mode and test files by executing "8: FILE" in the TEST menu. Download or delete defective files marked with an asterisk (\*), then run the application program again. (For details, refer to Subsection 2.5.3, [5.8].)

Application  
error!  
Contact your  
administrator.

```
No execution
program selected
Contact your
administrator.
```

### Execution program not selected

#### ■ Problem

No user program has been selected as an execution program to be run when the power is turned on.

#### ■ Solution

Operate the BHT-6000 in System Mode and select an execution program in the SET SYSTEM menu. (For the selecting procedure, refer to Chapter 2, Subsection 2.5.3, [4.1].)

```
Resume failure !
Program restarts
automatically.
```

### Resume data saving error

#### ■ Problem

When the power was turned off, the system failed to save resume data although the resume function had been set to ON.

#### NOTE

The BHT-6000 displays this error message for two seconds and automatically runs the execution program from the point of start-up.

## 4.2 Errors in System Mode

If some error occurs during operation in System Mode, one of the following error messages will appear on the LCD.

```
EXECUTE PROGRAM
*****
*NO FILE EXISTS*
*****
```

### When selecting a program file or data file

#### ■ Problem

You attempted to execute a user program in the EXECUTE PROGRAM menu, even though no user program files had been stored in the memories.

#### ■ Solution

Press the  key to return to the SYSTEM MENU screen, then download user programs. (Refer to Chapter 2, Subsection 2.5.3, [ 2 ].)

```
SET EXEC PROGRAM
*****
*NO FILE EXISTS*
*****
```

#### ■ Problem

In the SET SYSTEM menu, you attempted to select a user program file as an execution program to be run when the power is applied, even though no user program files had been stored in the memories.

#### ■ Solution

Press the  key to return to the SYSTEM MENU screen, then download user programs. (Refer to Chapter 2, Subsection 2.5.3, [ 2 ].)

```
UPLOAD FILE
(A:)
*****
*NO FILE EXISTS*
*****
```

#### ■ Problem

You attempted to select the RAM or flash ROM for uploading in the UPLOAD menu, even though no data files had been stored in the selected memory.

#### ■ Solution

Press the  key to return to the SYSTEM MENU screen.

```

DELETE FILE
(A:)
*****
*NO FILE EXISTS*
*****

```

#### ■ Problem

You have deleted all of the files stored in the designated memory in the DELETE menu.

#### ■ Solution

Press the C key to return to the SYSTEM MENU screen.

### During downloading of a program file or data file

```

DOWNLOAD FILE
(A:)

Out of memory !!

Retry? 1:Yes2:No

```

#### ■ Problem

The designated memory is insufficient for storing files to be downloaded.

#### ■ Solution

Press the 2 key to return to the SYSTEM MENU, then delete unnecessary files in the memory or decrease the size of the file to be downloaded. (Refer to Chapter 2, Subsection 2.5.3, [ 7 ] and [ 2 ].)

```

DOWNLOAD FILE
(A:)

File mismatch !!

Retry? 1:Yes2:No

```

#### ■ Problem

You attempted to download a JIS font file.

#### ■ Solution

Press the 2 key to return to the SYSTEM MENU and switch to the JIS 1/JIS 2 font menu, from which you download the JIS font file. (Refer to Chapter 2, Subsection 2.5.3, [ 9 ].)

```
DOWNLOAD FILE
(A:)
Too many files!!
Retry? 1:Yes2:No
```

#### ■ Problem

The current download will exceed the maximum of forty files in the memory.

#### ■ Solution

Press the **[2]** key to return to the SYSTEM MENU. If you attempted to download more than one file, delete unnecessary files in memory or decrease the number of files to be downloaded. (Refer to Chapter 2, Subsection 2.5.3, [ 7 ] and [ 2 ].)

```
DOWNLOAD FILE
(A:)
XXXXXXXXX.XXX
Communication
error !!
Retry? 1:Yes2:No
```

#### ■ Problem

Downloading has failed.

#### ■ Solution

To retry downloading, press the **[1]** key.

To return to the SYSTEM MENU, press the **[2]** key. Check the interface port and communications parameters in the SET SYSTEM menu or perform the communications test in the TEST menu. (Refer to Chapter 2, Subsection 2.5.3, [4.6] and [5.5].)

It is also necessary to check the communications parameters setup of the host computer.

```
DOWNLOAD FILE
(B:)
Drive A memory
short !!
Retry? 1:Yes2:No
```

#### ■ Problem

The RAM is insufficient for copying files stored in the flash ROM.

#### ■ Solution

Press the **[2]** key to return to the SYSTEM MENU, then delete unnecessary files in the RAM.

#### NOTE

When receiving downloaded files to the flash ROM, the BHT-6000 may copy the files stored in the flash ROM into the RAM. This requires an unused user area of 128 kilobytes in the RAM. If there is no area for copying in the RAM, the error message shown at left will appear.

```

DOWNLOAD

JIS 1
Memory used !!

```

#### ■ Problem

The memory area for the JIS font (JIS Level 1 font in this example) has been occupied by user programs.

#### ■ Solution

Copy the files stored in the flash ROM onto the RAM, and then delete the ROMed files.

```

DOWNLOAD

JIS 1
File mismatch !!

```

#### ■ Problem

The file type is mismatched.

(Examples)

- At the host computer, you attempted to download not the JIS1/JIS2 font file, but user programs.
- Although the JIS Level 1 font file was already selected on the BHT-6000, the host computer attempted to download the JIS Level 2 font file.

#### ■ Solution

Press the  key to return to the SYSTEM MENU. (To download user programs, select the regular downloading menu.)

```

DOWNLOAD

JIS 1
Communication
error !!
Retry? 1:Yes2:No

```

#### ■ Problem

Downloading has failed.

#### ■ Solution

To retry downloading, press the  key.

To return to the SYSTEM MENU, press the  key. Check the interface port and communications parameters in the SET SYSTEM menu or perform the communications test in the TEST menu. (Refer to Chapter 2, Subsection 2.5.3, [4.6] and [5.5].)

It is also necessary to check the communications parameters setup of the host computer.



## During uploading of a program file or data file

```
UPLOAD FILE
(A:)
SAMPLE00.PD3
File error !!
Upload? 1:Yes2:No
```

### ■ Problem

The file you attempted to upload is damaged.

### ■ Solution

To upload the damaged file as is, press the **[1]** key.

```
UPLOAD FILE
(A:)
XXXXXXXXXX.XXX
Communication
error !!
Retry? 1:Yes2:No
```

### ■ Problem

Uploading has failed.

### ■ Solution

To retry uploading, press the **[1]** key.

To return to the SYSTEM MENU, press the **[2]** key. Check the interface port and communications parameters in the SET SYSTEM menu or perform the communications test in the TEST menu. (Refer to Chapter 2, Subsection 2.5.3, [4.6] and [5.5].)

It is also necessary to check the communications parameters setup of the host computer.

## During uploading of JIS1/JIS2 font file

```
UPLOAD
JIS 1
Communication
error !!
Retry? 1:Yes2:No
```

### ■ Problem

Uploading has failed.

### ■ Solution

To retry uploading, press the **[1]** key.

To return to the SYSTEM MENU, press the **[2]** key. Check the interface port and communications parameters in the SET SYSTEM menu or perform the communications test in the TEST menu. (Refer to Chapter 2, Subsection 2.5.3, [4.6] and [5.5].)

It is also necessary to check the communications parameters setup of the host computer.

```
COPY FILE
(A->B)

Out of memory !!
```

```
COPY FILE
(A->B)

Too many files!!
```

### During file copying

#### ■ Problem

The target memory is insufficient for storing files to be copied.

#### ■ Solution

Press the **C** key to return to the SYSTEM MENU, then delete unnecessary files in the memory.

#### ■ Problem

The current copying will exceed the maximum of forty files in the memory.

#### ■ Solution

Press the **C** key to return to the SYSTEM MENU, then delete unnecessary files in the memory.



This chapter describes the handling procedure of the CU-6000, the interfacing with the host computer, and the charging of the Ni-MH battery cartridge.

5.1	Functions of the CU-6000 .....	134
5.2	Components and Functions .....	134
5.3	Applying Power to the CU-6000 .....	136
5.4	Communicating with the Host Computer .....	137
5.4.1	Setting the Transmission Speed of the CU-6000 .....	137
5.4.2	Interface Cable Connection .....	137
5.4.3	Interfacing with the Host Computer .....	138
5.5	Charging the Ni-MH Battery Cartridge (using the CU-6001) .....	139
5.5.1	Ni-MH Battery Cartridge Loaded in the BHT-6000 .....	139
5.5.2	Ni-MH Battery Cartridge Alone .....	141
	[ 1 ] Fully Discharging (Refresh) and then Charging .....	142
	[ 2 ] Charging Only .....	143
5.6	RS-232C Interface Specifications .....	144
	[ 1 ] Interface Connector and Pin Assignment .....	144
	[ 2 ] Interface Cable Connection .....	145

## Chapter 5

### Handling the CU-6000 (Option)

## 5.1 Functions of the CU-6000

The optical communications unit CU-6000 is available in two models: CU-6001 and CU-6002. The CU-6001 has both of functions (1) and (2) given below; the CU-6002 has only function (1).

### (1) Data exchange function

The CU-6001/CU-6002 exchanges data and programs between the BHT-6000 and the host computer. It interfaces with the BHT-6000 via the optical interface and with the host computer via the RS-232C interface.

### (2) Ni-MH battery cartridge charging function

The CU-6001 charges the Ni-MH battery cartridge.

## 5.2 Components and Functions

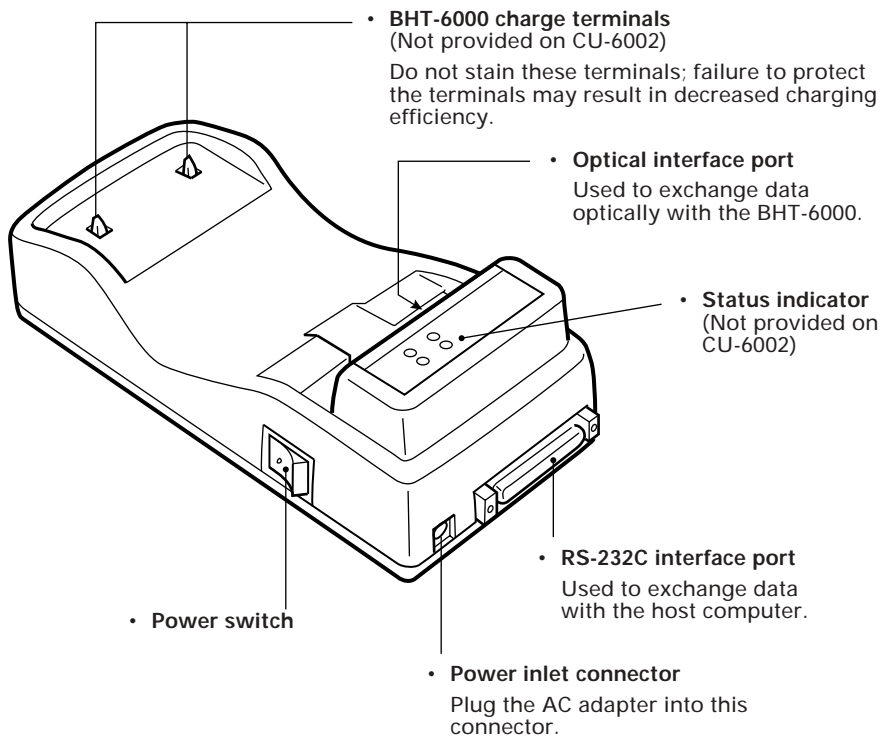

**Status indicator**

(Not provided on CU-6002)

Shows the status of the CU-6001.

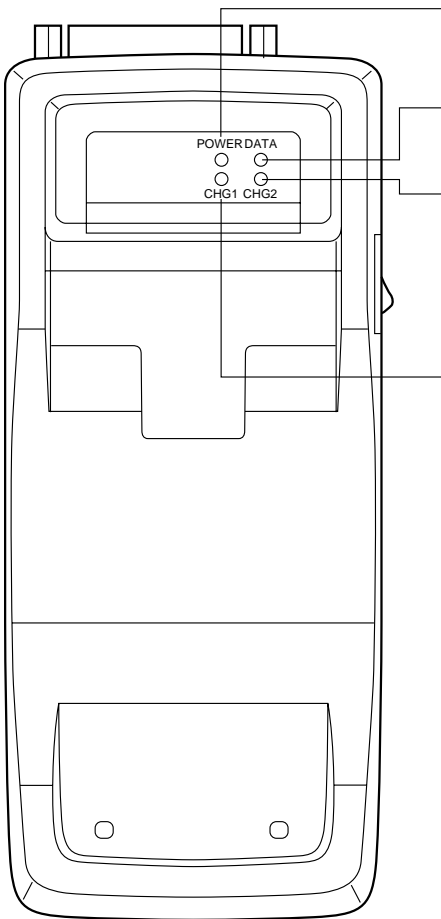

**POWER LED (green)**

Lights when the power is applied to the CU-6000.

**DATA communications LED (green)**

Lights when the BHT-6000 is communicating with the host computer.

**CHG2 LED (Battery cartridge charge lamp) (yellow)**

Lights when the CU-6001 is charging a Ni-MH battery cartridge all by itself. Upon completion of charging, this LED flashes at 2-second intervals.

During discharging of a Ni-MH battery cartridge, this LED flashes at 0.4-second intervals.

**CHG1 LED (BHT-6000 charge lamp) (yellow)**

Lights when the CU-6001 is charging a Ni-MH battery cartridge loaded in the BHT-6000. Upon completion of charging, this LED flashes at 2-second intervals.

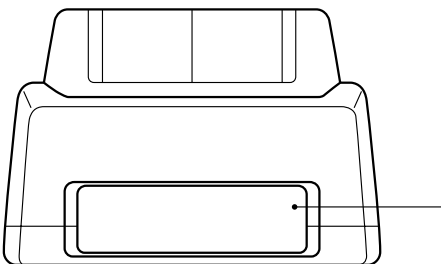

**Battery cartridge slot**

(Not provided on CU-6002)

To charge a Ni-MH battery cartridge all by itself, load it into this slot.





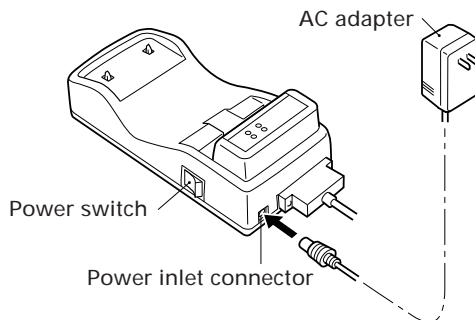

## 5.3 Applying Power to the CU-6000





Apply power to the CU-6000 by connecting it to the wall socket via the attached AC adapter according to the steps given below.

- (1) Make sure that the CU-6000 is turned off.
- (2) Connect the outlet plug of the AC adapter to the power inlet connector of the CU-6000, then plug the other end of the AC adapter into the wall socket.



- (3) Power on the CU-6000.

<p><b>⚠ WARNING</b></p>	<ul style="list-style-type: none"> <li>• If smoke, abnormal odors or noises come from the CU, immediately turn off the power, unplug the AC adapter from the wall socket, and contact your nearest dealer. Failure to do so could cause fire or electrical shock. </li> <li>• If foreign material or water gets into the CU, immediately turn off the power, unplug the AC adapter from the wall socket, and contact your nearest dealer. Failure to do so could cause fire or electrical shock. </li> <li>• If you drop the CU so as to damage its housing, immediately turn off the power, unplug the AC adapter from the wall socket, and contact your nearest dealer. Failure to do so could cause fire or electrical shock. </li> <li>• Use the furnished AC adapter only. Failure to do so could result in a fire. </li> <li>• Never use the CU on the line voltage other than the specified level. Doing so could cause the CU to break or burn. </li> <li>• If the power cord of the AC adapter is damaged (e.g., exposed or broken lead wires), stop using it and contact your nearest dealer. Failure to do so could result in a fire or electrical shock. </li> </ul>
-------------------------	---

<p><b>⚠ CAUTION</b></p>	<ul style="list-style-type: none"> <li>• If you are not using the CU for a long time, be sure to unplug the AC adapter from the wall socket for safety. Failure to do so could result in a fire. </li> <li>• When caring for the CU, unplug the AC adapter from the wall socket for safety. Failure to do so could result in an electrical shock. </li> <li>• Never cover or wrap up the CU or AC adapter in a cloth or blanket. Doing so could cause the unit to heat up inside, deforming its housing, resulting in a fire. Always use the CU and AC adapter in a well-ventilated area. </li> <li>• Keep the power cord away from any heating equipment. Failure to do so could melt the sheathing, resulting in a fire or electrical shock. </li> </ul>
-------------------------	--

## 5.4 Communicating with the Host Computer

### 5.4.1 Setting the Transmission Speed of the CU-6000

Set the transmission speed of the CU-6000 to the same value as that of the BHT-6000 and the host computer, by using the DIP switch provided on the bottom of the CU-6000.

- (1) Turn the CU-6000 upside down.
- (2) Remove the protection sheet of the DIP switch from the CU-6000.
- (3) Set the selectors of the DIP switch as shown below.

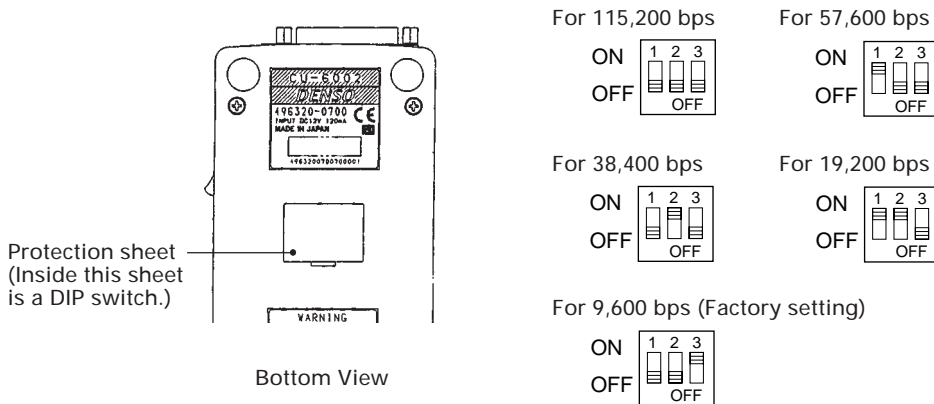

- (4) Reinstall the protection sheet.

**NOTE** Do not set the DIP switch to any configurations other than one of the five shown above.

### 5.4.2 Interface Cable Connection

- (1) Make sure that both the CU-6000 and the host computer are turned off.
- (2) Connect the 25-pin plug (Dsub-25P) of the interface cable to the RS-232C interface port of the CU-6000.

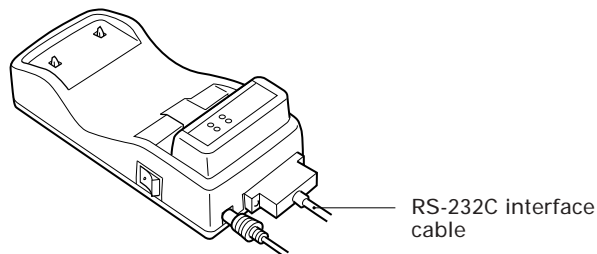

- (3) Connect the other end of the interface cable to the host computer.



### 5.4.3 Interfacing with the Host Computer

- (1) Power on the host computer and start up the MS-DOS.
- (2) Turn on the power switch of the CU-6000.
- (3) Make sure that the BHT-6000 is turned off, then put it on the CU-6000.

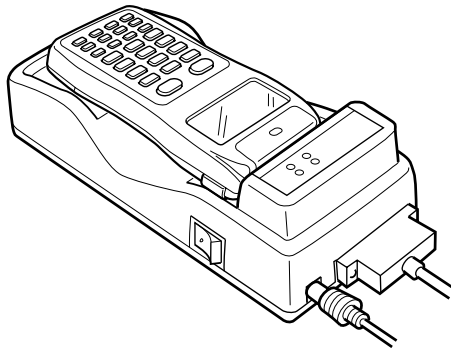

- (4) Power on the BHT-6000 and run System Mode. Set the communications environments (communications protocol, interface port, communications parameters, and protocol options).

Regarding the communications protocol: When using Ir-Transfer Utility C on the host computer, select the BHT-Ir protocol; when using Transfer Utility, select the BHT-protocol.

Regarding the interface port: Select the optical interface port.

- (5) On the host computer, initiate a communications program (e.g., Ir-Transfer Utility C, Transfer Utility, or equivalent).
- (6) To transfer data stored in the BHT-6000 to the host computer, select "3: UPLOAD" on the SYSTEM MENU in System Mode. To transfer data from the host computer to the BHT-6000, select "2: DOWNLOAD." (For details, refer to Chapter 2, Section 2.5.)

The BHT-6000 and the host computer will start communications with each other via the CU-6000. (On the CU-6001, the DATA LED will come on upon start of communications. After completion of communications, the LED will go off.)

- (7) Power off the BHT-6000, CU-6000, and the host computer.

## 5.5 Charging the Ni-MH Battery Cartridge (using the CU-6001)

You may charge Ni-MH battery cartridges either loaded in the BHT-6000 or all by themselves.

### NOTE

Service Life of Ni-MH Battery Cartridge:

Ni-MH batteries used in the battery cartridge will gradually deteriorate during the repeated cycles of charging and discharging due to its properties, even under normal use. When the battery service period becomes shortened due to its deterioration even if it has been charged for the specified hours, replace the battery cartridge with a new one. Generally, it is necessary to replace the battery cartridge after it has undergone approx. 200 cycles of charging and discharging operation.

Memory Effect:

If a Ni-MH battery undergoes many cycles of imperfect charging and discharging (e.g., one-hour recharge followed by one-hour use), the service period may become shortened before the service life is really expired, just as the battery memorizes the use conditions. It is called "Memory Effect." The memory effect can be avoided by discharging a Ni-MH battery fully before charging.

For the Ni-MH battery cartridge, use the CU-6001 or C-600 for fully discharging and recharging.

### 5.5.1 Ni-MH Battery Cartridge Loaded in the BHT-6000

- (1) Turn on the CU-6001.
- (2) Place the BHT-6000 loaded with a Ni-MH battery cartridge onto the CU-6001.

The CU-6001 lights the CHG1 LED and starts charging.

After approx. ten hours of charging, the CHG1 LED starts flashing at 2-second intervals, indicating that charging is completed.

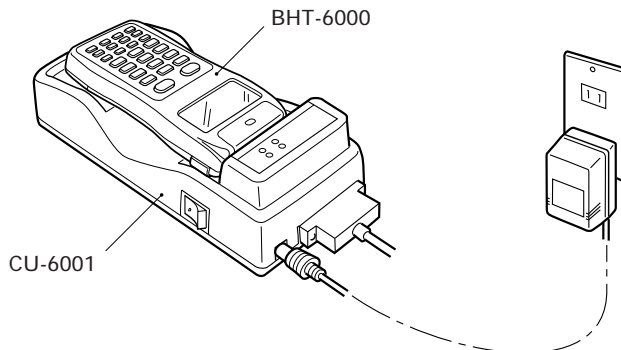

## ■ Charging Operation and LED Indication

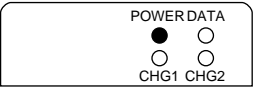
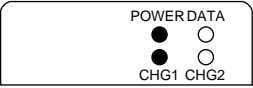
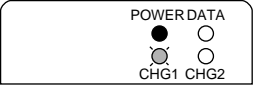
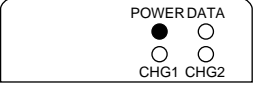
Operator's Action	CU-6001 Status	LED Indication
Power on the CU-6001. ↓	On standby ↓	ON 
Place the BHT-6000 on the CU-6001. ↓	Ordinary charging ↓	ON 
After approx. 10 hours ↓	Trickle charging* ↓	ON  Flashing at 2-second intervals
Remove the BHT-6000.	On standby	ON  OFF

\* "Trickle charging" is a slow continuous charge for a battery, which compensates for the slight amount of discharge happening even when batteries are not in use.

## 5.5.2 Ni-MH Battery Cartridge Alone

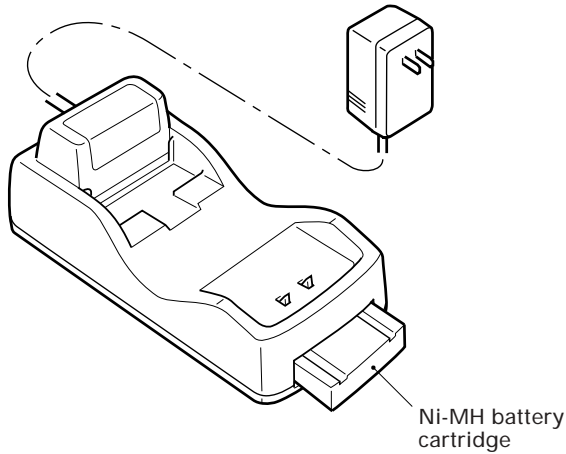

The CU-6001 can charge Ni-MH battery cartridges in either of the following two ways:

- Fully discharging and then charging\* [ 1 ]
- Charging only [ 2 ]

\* Fully discharging and then charging batteries can prevent "Memory Effect" as described at the beginning of Section 5.5.

To select [ 1 ], first power on the CU-6001 and then load a Ni-MH battery cartridge into it. To select [ 2 ], first load a Ni-MH battery cartridge into the CU-6001 and then power it on.

<p><b>⚠ WARNING</b></p>	<ul style="list-style-type: none"> <li>• Never use the CU-6001 for charging anything other than the specified battery cartridges. </li> <li>Doing so could cause heat, battery-rupture, or fire.</li> </ul>
<p><b>⚠ CAUTION</b></p>	<p><b>Handling the battery cartridge</b> </p> <ul style="list-style-type: none"> <li>• Never charge a wet or damp Ni-MH battery cartridge. Doing so could cause the batteries to break, generate heat, rupture, or burn.</li> <li>• Do not insert or drop foreign materials such as metals or anything inflammable through the openings (vents or battery cartridge slot) into the CU-6000. Doing so could result in a fire or electrical shock.</li> </ul>

## [ 1 ] Fully Discharging (Refresh) and then Charging

- (1) Power on the CU-6001. The POWER LED comes on.
- (2) Load a Ni-MH battery cartridge into the CU-6001 from the battery cartridge slot.

The CU-6001 flashes the CHG2 LED at 0.4-second intervals and starts discharging the cartridge. The discharging time differs depending upon the battery condition, but never more than three hours.

Upon completion of discharging, the CHG2 LED comes to stay on and the CU-6001 starts charging.

After approx. ten hours of charging, the CHG2 LED starts flashing at 2-second intervals, indicating that the charging is completed.

- (3) Take out the battery cartridge.

### ■ Discharging & Charging Operations and LED Indication

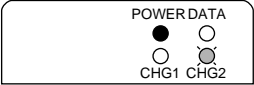
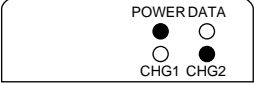
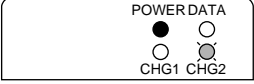
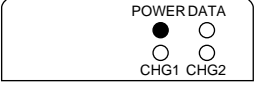
Operator's Action	CU-6001 Status	LED Indication
Power on the CU-6001.	On standby	ON 
⇓	⇓	
Load a battery cartridge into the CU-6001.	Discharging	ON  Flashing at 0.4-second intervals
⇓	⇓	
After discharging	Ordinary charging	ON  ON
⇓	⇓	
After approx. 10 hours	Trickle charging	ON  Flashing at 2-second intervals
⇓	⇓	
Take out the battery cartridge.	On standby	ON  OFF

## [ 2 ] Charging Only

- (1) Load a Ni-MH battery cartridge into the CU-6001 from the battery cartridge slot.
- (2) Power on the CU-6001.

The CU-6001 turns on the CHG2 LED and starts charging the cartridge.

After approx. ten hours of charging, the CHG2 LED starts flashing at 2-second intervals, indicating that the charging is completed.

- (3) Take out the battery cartridge.

### ■ Charging Operation and LED Indication

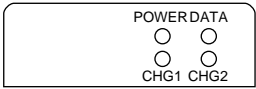
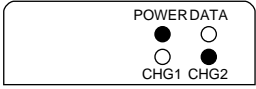
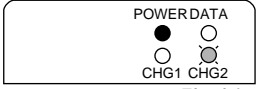
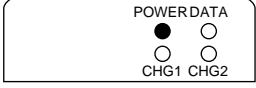
Operator's Action	CU-6001 Status	LED Indication
Load a battery cartridge into the CU-6001.	Powered OFF	
⇓	⇓	
Power on the CU-6001.	Ordinary charging	<p style="text-align: center;">ON</p>  <p style="text-align: center;">ON</p>
⇓	⇓	
After approx. 10 hours	Trickle charging	<p style="text-align: center;">ON</p>  <p style="text-align: center;">Flashing at 2-second intervals</p>
⇓	⇓	
Take out the battery cartridge.	On standby	<p style="text-align: center;">ON</p>  <p style="text-align: center;">OFF</p>

# 5.6 RS-232C Interface Specifications

## [ 1 ] Interface Connector and Pin Assignment

The CU-6000 has an RS-232C interface port (Dsub-25S).

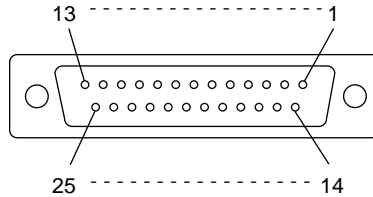

RS-232C interface port (Dsub-25S) on the CU-6000

Pin No.	Signal	Functions	Signal Input/Output	
			CU-6000	External device
1	FG	Frame ground	—	—
2	SD	Send data	→	—
3	RD	Receive data	←	—
4	RS	Request to send	—	—
5	CS	Ready to send	—	—
6	DR	Data set ready	—	—
7	SG	Signal ground	—	—
20	ER	Data terminal equipment ready	—	—

The input/output voltage threshold for the logical valued signal is listed below.

Logical Value	Input Voltage Threshold	Output Voltage Threshold
0	3V min.	5V min.
1	-3V max.	-5V max.

## [ 2 ] Interface Cable Connection

As illustrated below, connect the CU-6000 (which is joined with the BHT-6000) to a host computer with a cross-mode cable. To connect it to a modem, use a straight-mode cable.

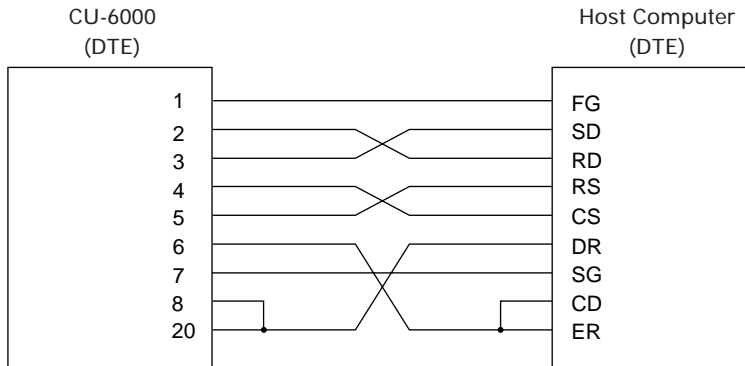

Cable Connection between CU-6000 and Host Computer

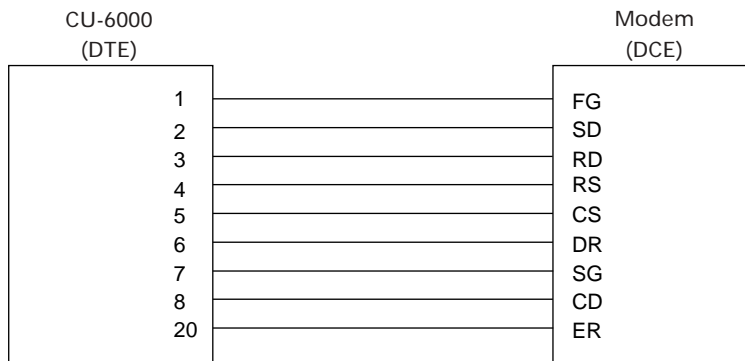

Cable Connection between CU-6000 and Modem

### **DTE and DCE**

In the RS-232C interface specifications, the DTEs (Data Terminal Equipment) shall be generally connected with each other by a cross-mode cable; the DTE and DCE (Data Circuit-terminating Equipment) shall be connected with each other by a straight-mode cable.

The DTE is one piece of equipment connected at both ends of a communications line as a sender or receiver of data (such as CU-6000 joined with the BHT-6000 and a host computer).

The DCE is one piece of equipment connected to the intermediate point between the DTE and the communications line. It terminates communications lines and exchanges information between those lines without any change in contents (such as modem).





Appendix A. Specifications .....	148
A.1 BHT-6000 .....	148
[ 1 ] Product Specifications .....	148
[ 2 ] Bar Code Specifications .....	149
[ 3 ] Interface Specifications .....	153
A.2 CU-6000 .....	154
[ 1 ] Product Specifications .....	154
[ 2 ] Charging/Discharging Requirements (CU-6001) .....	154
[ 3 ] Interface Specifications .....	155
Appendix B. A Typical Basic Operation .....	156
Appendix C. Alphabet Input Procedure .....	157

# Appendices

# Appendix A. Specifications

## A.1 BHT-6000

### [ 1 ] Product Specifications

<b>Power Source</b>	Main power	<ul style="list-style-type: none"> <li>• Two alkaline manganese batteries (LR03) or</li> <li>• Rechargeable Ni-MH battery cartridge (2.4 DVC)</li> </ul>																						
	Backup power	Integrated lithium battery, 3.0 VDC																						
<b>Dimensions</b> (W) x (L) x (H)		59 x 135 x 20 mm (2.3 x 5.3 x 0.8 inches)																						
<b>Weight</b>		Approx. 130 g (Approx. 4.6 oz.) including batteries																						
<b>Operating Ambient Temperature</b>		-5°C to 50°C (23°F to 122°F)																						
<b>Operating Humidity</b>		20% to 80% (with no dew condensation)																						
<b>Ambient Illuminance</b>		20 to 10,000 lux. (Depth of field: 160 mm, ITF: 1.0 magnification, PCS value: 0.9 min., Reflection intensity: 85% min. for white and 5% max. for black)																						
<b>Controller</b>		CPU: 16-bit CMOS RAM: 512KB Flash ROM: 512KB/1MB																						
<b>Keypad</b>		Function keys: 8 Magic keys: 2 Numerical keys and others: 16																						
<b>Display</b>		Type: Dot-matrix, FSTN liquid crystal display (LCD) with backlight Formation: 96 dots wide by 48 dots high																						
		<table border="1" style="width: 100%; border-collapse: collapse;"> <thead> <tr> <th>Screen mode</th> <th>Font size</th> <th>Chars x Lines</th> <th>Dots (W x H)</th> </tr> </thead> <tbody> <tr> <td rowspan="2">Single-byte ANK* mode</td> <td>Standard-size</td> <td>16 x 6</td> <td>6 x 8</td> </tr> <tr> <td>Small-size</td> <td>16 x 8</td> <td>6 x 6</td> </tr> <tr> <td rowspan="4">Two-byte Kanji mode</td> <td rowspan="2">Standard-size</td> <td>Full-width</td> <td>6 x 3</td> </tr> <tr> <td>Half-width</td> <td>12 x 3</td> </tr> <tr> <td rowspan="2">Small-size</td> <td>Full-width</td> <td>8 x 4</td> </tr> <tr> <td>Half-width</td> <td>16 x 4</td> </tr> </tbody> </table>	Screen mode	Font size	Chars x Lines	Dots (W x H)	Single-byte ANK* mode	Standard-size	16 x 6	6 x 8	Small-size	16 x 8	6 x 6	Two-byte Kanji mode	Standard-size	Full-width	6 x 3	Half-width	12 x 3	Small-size	Full-width	8 x 4	Half-width	16 x 4
Screen mode	Font size	Chars x Lines	Dots (W x H)																					
Single-byte ANK* mode	Standard-size	16 x 6	6 x 8																					
	Small-size	16 x 8	6 x 6																					
Two-byte Kanji mode	Standard-size	Full-width	6 x 3																					
		Half-width	12 x 3																					
	Small-size	Full-width	8 x 4																					
		Half-width	16 x 4																					
		*ANK: Alphanumerics and Katakana																						
<b>Calendar Clock</b>		Year, month, day, hour, minute, and second with compensation for leap years																						
<b>Reading Confirmation LED</b>		Colors: Red and green																						

## [ 2 ] Bar Code Specifications

### Normal-range Type

#### (1) Available Bar Code Types

Bar code type	Bar dimensions	Readable magnification							
Universal product codes									
EAN-13	0.26 to 0.33 mm (10.24 to 13.0 mils)	0.8 to 1.0 magnification							
EAN-8	0.26 to 0.46 mm (10.24 to 18.1 mils)	0.8 to 1.4 magnifications							
UPC-A	0.26 to 0.33 mm (10.24 to 13.0 mils)	0.8 to 1.0 magnification							
UPC-E	0.26 to 0.56 mm (10.24 to 22.0 mils)	0.8 to 1.7 magnifications							
EAN-13 with supplemental codes EAN-8 with supplemental codes UPC-A with supplemental codes UPC-E with supplemental codes									
	2-digit add-on	0.26 to 0.66 mm (10.24 to 26.0 mils)							
	5-digit add-on	0.26 to 0.66 mm (10.24 to 26.0 mils)							
		[Long-range scanning]							
Interleaved 2 of 5 (ITF)	<table border="0"> <tr> <td rowspan="4">}</td> <td>0.1 mm min. (3.94 mils min.)</td> </tr> <tr> <td>PCS value <math>\geq</math> 0.9</td> </tr> <tr> <td>Reflection intensity difference between white and black bars <math>\geq</math> 80%</td> </tr> <tr> <td>0.15 mm min. (5.91 mils min.)</td> </tr> <tr> <td></td> <td>(PCS value <math>\geq</math> 0.45)</td> </tr> </table>	}	0.1 mm min. (3.94 mils min.)	PCS value $\geq$ 0.9	Reflection intensity difference between white and black bars $\geq$ 80%	0.15 mm min. (5.91 mils min.)		(PCS value $\geq$ 0.45)	
}			0.1 mm min. (3.94 mils min.)						
			PCS value $\geq$ 0.9						
			Reflection intensity difference between white and black bars $\geq$ 80%						
	0.15 mm min. (5.91 mils min.)								
	(PCS value $\geq$ 0.45)								
Standard 2 of 5 (STF)									
CODABAR (NW7)									
CODE39									
CODE93	}	0.15 mm min. (5.91 mils min.)							
CODE128		(PCS value $\geq$ 0.45)							

\* The above values (except for those for bar codes with supplemental codes) are under the following conditions:

- Touch scanning
- Ambient illuminance: 500 to 3000 lux. (Xenon lamp)

#### (2) Optical Properties Required for Bar Code Labels

White bars:	Reflection intensity	45% min.
Black bars:	Reflection intensity	25% max.
	PCS value	0.45 min.

### (3) Bar Code Label Size

Recommended width: 10 mm min. (0.39 inch min.)

Length:	Depth of field (Distance from bar codes to the bar-code reading window)	Length of labels (including margins)
	0 mm	39 mm max. (1.54 inches max.) (Minimum narrow bar width: 0.1 mm min.)* <sup>1</sup>
	240 mm (9.45 inches)	235 mm max. (9.25 inches max.) (Minimum narrow bar width: 1.2 mm min.)* <sup>4</sup>

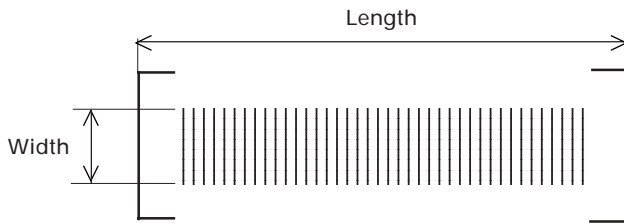

### (4) Thickness of Bars and Depth of Field

Minimum narrow bar width	Depth of field
0.15 mm (5.91 mils)	Up to 5 mm (0.19 inch) * <sup>2</sup>
0.26 mm (10.24 mils)	Up to 36 mm (1.42 inches) * <sup>3</sup>
0.33 mm (12.99 mils)	Up to 50 mm (1.97 inches) * <sup>3</sup>
0.64 mm (25.20 mils)	Up to 100 mm (3.94 inches) * <sup>4</sup>
1.0 mm (39.37 mils)	Up to 200 mm (7.87 inches) * <sup>4</sup>
1.2 mm (47.24 mils)	Up to 240 mm (9.45 inches) * <sup>4</sup>

- \*<sup>1</sup> Under the following conditions:
- Ambient illuminance: 500 to 3,000 lux. (Xenon lamp)
  - CODE39, ITF, NW7
  - PCS value: 0.9 min.  
Reflection intensity difference between white and black bars: 80% min.

- \*<sup>2</sup> Under the following conditions:
- Ambient illuminance: 500 lux. (Xenon lamp)
  - ITF 20 digits
  - Reflection intensity of white bars: 85% min.  
Reflection intensity of black bars: 5% max.

- \*<sup>3</sup> Under the following conditions:
- Ambient illuminance: 500 lux. (Xenon lamp)
  - EAN13
  - Reflection intensity of white bars: 85% min.  
Reflection intensity of black bars: 5% max.

- \*<sup>4</sup> Under the following conditions:
- Ambient illuminance: 500 lux. (Xenon lamp)
  - ITF conforming to the UPC Shipping Container Code
  - Reflection intensity of white bars: 85% min.  
Reflection intensity of black bars: 5% max.

## Long-range Type (BHT-6000D)

### (1) Available Bar Code Types

Bar code type	Bar dimensions	Readable magnification
Universal product codes		
EAN-13	0.26 to 0.66 mm (10.24 to 26.0 mils)	0.8 to 2.0 magnification
EAN-8	0.26 to 0.66 m (10.24 to 26.0 mils)	0.8 to 2.0 magnifications
UPC-A	0.26 to 0.66 mm (10.24 to 26.0 mils)	0.8 to 2.0 magnification
UPC-E	0.26 to 0.66 mm (10.24 to 26.0 mils)	0.8 to 2.0 magnifications
EAN-13 with supplemental codes EAN-8 with supplemental codes UPC-A with supplemental codes UPC-E with supplemental codes		
2-digit add-on	0.26 to 0.66 mm (10.24 to 26.0 mils)	0.8 to 2.0 magnifications
5-digit add-on	0.26 to 0.66 mm (10.24 to 26.0 mils)	0.8 to 2.0 magnifications
Interleaved 2 of 5 (ITF)	<div style="display: flex; align-items: center;"> <div style="font-size: 3em; margin-right: 5px;">}</div> <div style="border-left: 1px solid black; padding-left: 5px;">                     0.15 mm min. (5.9 mils min.)                      PCS value <math>\geq</math> 0.9                      Reflection intensity difference between white                      and black bars <math>\geq</math> 80%                 </div> <div style="font-size: 3em; margin-left: 5px;">}</div> </div>	
Standard 2 of 5 (STF)		
CODABAR (NW7)		
CODE39		
CODE93		
CODE128		
	0.19 mm min. (7.5 mils min.) (PCS value $\geq$ 0.45)	

- \* The all above values are under the following conditions:
- Depth of field: 68 mm (2.7")
  - Ambient illuminance: 500 to 3000 lux. (Xenon lamp)

### (2) Optical Properties Required for Bar Code Labels

White bars:	Reflection intensity	45% min.
Black bars:	Reflection intensity	25% max.
	PCS value	0.45 min.

### (3) Bar Code Label Size

Recommended width: 10 mm min. (0.39 inch min.)

Length:	Depth of field (Distance from bar codes to the bar-code reading window)	Length of labels (including margins)
	68 mm (2.7 inches)	95 mm max. (3.74 inches max.) (Minimum narrow bar width: 0.15 mm min.)* <sup>1</sup>
	350 mm (13.78 inches)	320 mm max. (12.60 inches max.) (Minimum narrow bar width: 1.2 mm min.)* <sup>4</sup>

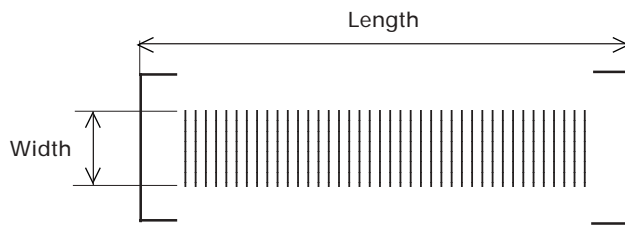

### (4) Thickness of Bars and Depth of Field

Minimum narrow bar width	Depth of field
0.15 mm (5.91 mils)	60 to 80 mm (2.36 to 3.15 inches) * <sup>2</sup>
0.26 mm (10.24 mils)	40 to 100 mm (1.57 to 3.94 inches) * <sup>3</sup>
0.33 mm (12.99 mils)	Up to 110 mm (4.33 inches) * <sup>3</sup>
0.64 mm (25.20 mils)	Up to 150 mm (5.91 inches) * <sup>4</sup>
1.0 mm (39.37 mils)	Up to 300 mm (11.81 inches) * <sup>4</sup>
1.2 mm (47.24 mils)	Up to 350 mm (13.78 inches) * <sup>4</sup>

- \*<sup>1</sup> Under the following conditions:
- Ambient illuminance: 500 to 3,000 lux. (Xenon lamp)
  - CODE39, ITF, NW7
  - PCS value: 0.9 min.  
Reflection intensity difference between white and black bars: 80% min.

- \*<sup>2</sup> Under the following conditions:
- Ambient illuminance: 500 lux. (Xenon lamp)
  - ITF 20 digits
  - Reflection intensity of white bars: 85% min.  
Reflection intensity of black bars: 5% max.

- \*<sup>3</sup> Under the following conditions:
- Ambient illuminance: 500 lux. (Xenon lamp)
  - EAN13
  - Reflection intensity of white bars: 85% min.  
Reflection intensity of black bars: 5% max.

- \*<sup>4</sup> Under the following conditions:
- Ambient illuminance: 500 lux. (Xenon lamp)
  - ITF conforming to the UPC Shipping Container Code
  - Reflection intensity of white bars: 85% min.  
Reflection intensity of black bars: 5% max.

### [ 3 ] Interface Specifications

#### Optical Interface

Synchronization: Start-stop  
 Input signals: RD  
 Output signals: SD  
 Transmission speed: 115200 bps max.

#### Direct-connect Interface

Synchronization: Start-stop  
 Transmission speed: 38400 bps max.  
 Signal level: Conforms to the RS-232C interface  
 Pin assignment: As shown below.

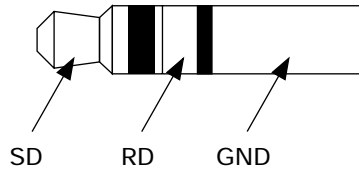

Pin No.	Signal	Functions	Signal Input/Output	
			BHT-6000	External device
1	SG (GND)	Ground for signals	—	—
2	SD	Send data	→	→
3	RD	Receive data	←	←



## A.2 CU-6000

### [ 1 ] Product Specifications

<b>Power Source</b>	12 VDC (via the AC adapter)
<b>Power Consumption</b>	2W
<b>Dimensions</b> (W) x (L) x (H)	82 x 190 x 57 mm (3.23 x 7.48 x 2.24 inches)
<b>Weight</b>	CU-6001: Approx. 240 g (Approx. 8.47 oz.) CU-6002: Approx. 180 g (Approx. 6.35 oz.)
<b>Operating Ambient Temperature</b>	0°C to 40°C (32°F to 104°F)
<b>Operating Humidity</b>	20% to 80% (with no dew condensation)

### [ 2 ] Charging/Discharging Requirements (CU-6001)

---

For charging a Ni-MH battery cartridge loaded in the BHT-6000

Charge current:	70 mA
Charge time:	Approx. 10 hours

---

For charging a Ni-MH battery cartridge all by itself

Charge current:	70 mA
Charge time:	Approx. 10 hours
Discharge current:	180 mA
Discharge time:	Approx. 3 hours

---

### [ 3 ] Interface Specifications

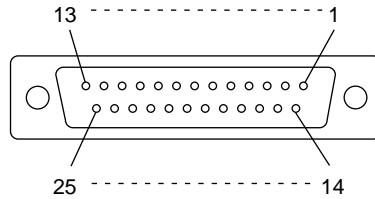

RS-232C Interface Port (Dsub-25S) on the CU-6000

Pin No.	Signal	Functions	Signal Input/Output	
			CU-6000	External device
1	FG	Frame ground	—	—
2	SD	Send data	→	←
3	RD	Receive data	←	→
4	RS	Request to send	—	—
5	CS	Ready to send	—	—
6	DR	Data set ready	—	—
7	SG	Signal ground	—	—
20	ER	Data terminal equipment ready	—	—

**NOTE** Shown below is a diagram of the internal connection in the CU-6000.

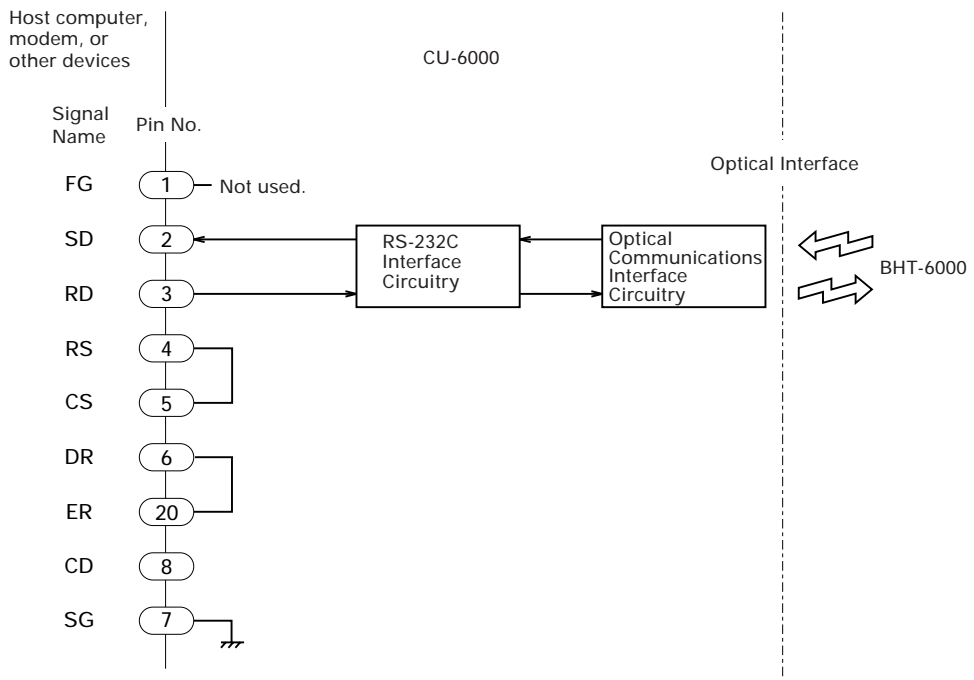

# Appendix B.

## A Typical Basic Operation

What follows is a typical basic operation which helps you instruct the hands-on user in practical bar-code reading operation.

Application type: Inventory

Operation: Power ON → Read the bar code on stock (A). → Key in the quantity.  
Read the bar code on stock (B). → Key in the quantity.  
⋮  
Repeat the above operation.

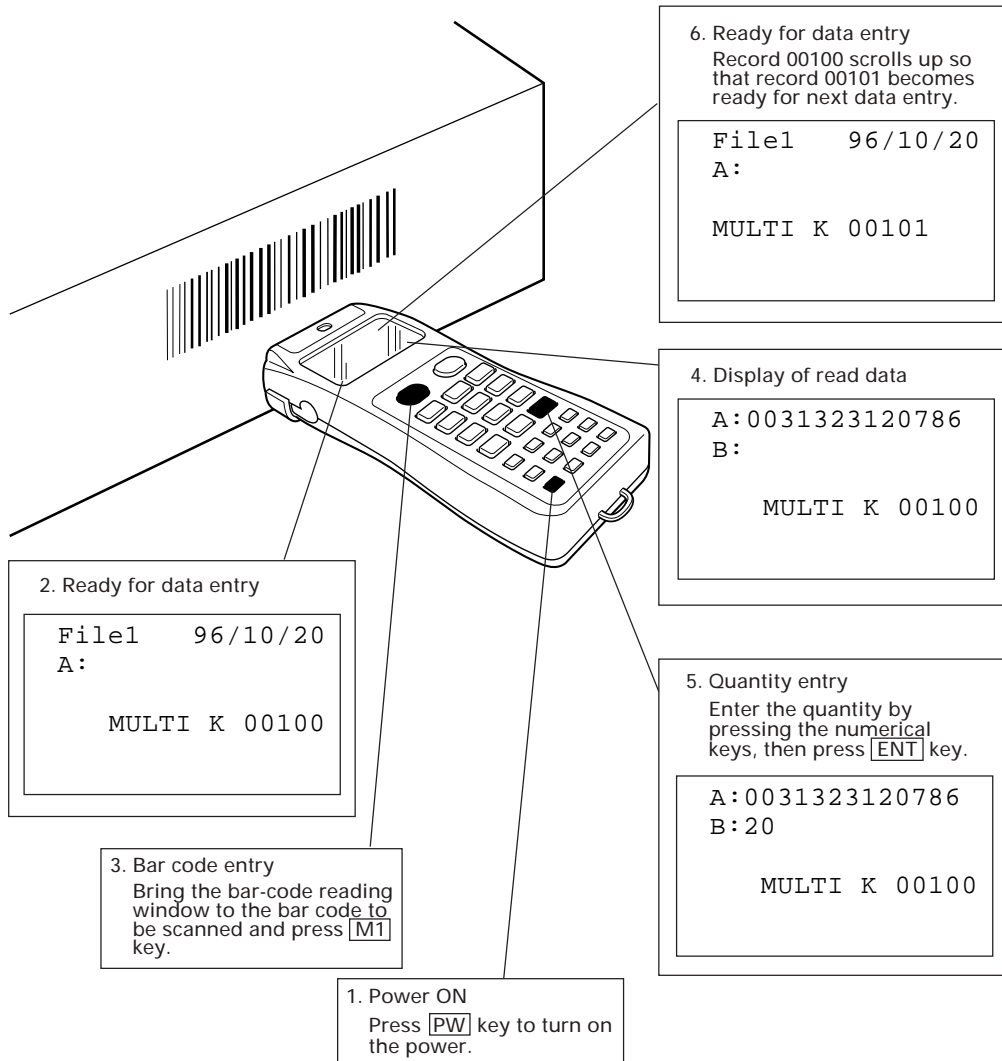

# Appendix C.

## Alphabet Input Procedure

To activated or deactivate the alphabet input function, issue OUT statement in a user program.

As shown at right, each of 0-9 numerical keys and period key is assigned three characters. For example, the **7** key is assigned A, B, and C.

To designate one of three assigned characters, use the **M1** or **M2** key. Note that the trigger switch function (default) or no function should be assigned to the **M1** or **M2** key to be used.

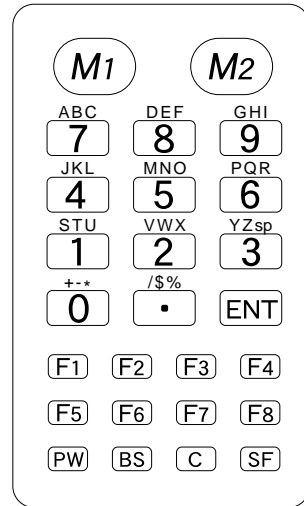

### Alphabet input procedure

#### (1) Activating the alphabet input function with OUT statement

In a user program, issue the OUT statement which sets 1 to bit 0 of port 5. (To deactivate the function, issue the OUT statement which sets 0 to bit 0 of port 5.)

To activate:     OUT 5, &h1

To deactivate:  OUT 5, &h0

The default setting of the alphabet input function is "deactivated."

#### (2) Entering alphabetic characters from the keypad

- 1) Find a target key which is assigned an alphabetic character to be inputted, and then check the position of the character (Left, Center, or Right) relative to the three characters assigned to the target key.
- 2) Designate the character position by using the **M1** or **M2** key and then press the target key.

How to use the **M1** or **M2** key

Pressing the **M1** or **M2** key cycles through the shift guidance blocks **Left**, **Center**, and **Right** on the LCD as shown below.

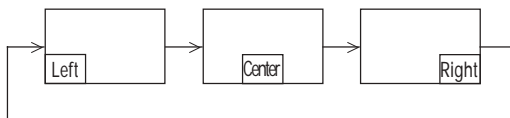

The shift guidance block will appear on the top or bottom line, depending upon the current cursor position. That is, if the cursor lies on any of the lower lines, the shift guidance block will appear on the top line; if it lies on any of the upper lines, the block will appear on the bottom line.

The shift guidance block appears only while the **[M1]** or **[M2]** key is held down. Therefore, you should press the target key while holding down the **[M1]** or **[M2]** key.

To enter an N character, for example, use the **[M1]** or **[M2]** key to display the **[Center]** on the LCD. While displaying the **[Center]**, press the **[5]** key.

#### NOTE

- During the alphabet input operation, you can use the **[BS]**, **[C]**, and numerical keys as usual.
- For displaying the shift guidance block **[Right]** when the status indication is set to ON, the BHT-6000 overwrites the status indication with the shift block.
- The activated or deactivated state of the alphabet input function will be resumed. The shift block will not be resumed.

# Index

---

## Symbols

---

25-pin plug (Dsub-25P) 137  
3-pole mini stereo plug 9, 35, 63, 82

---

## A

---

AC adapter vi, viii, ix, 134, 136, 154  
aging test 30, 59, 62

---

## B

---

backlight 4, 15, 58, 148  
backlight function 4, 15, 58  
backlight function on/off key 15, 58  
bar-code reading test 30, 59, 60  
batteries v, vii, viii, 14, 17, 18, 19, 20, 122, 123, 139, 140, 141, 148  
battery cartridge ii, v, vi, vii, viii, ix, 17, 18, 19, 20, 28, 122, 123, 133, 134, 135, 139, 141, 142, 143, 148, 154  
battery cartridge slot ix, 135, 141, 142, 143  
battery cover 14, 16, 17  
battery cover lock 14, 16, 17  
battery voltage level 10, 19, 27, 28, 44, 122  
beeper scale test 59, 62  
beeper test 30, 59, 68  
beeper volume 19, 27, 44  
BHT-BASIC 3.0 Compiler 8, 9, 12, 35  
BHT-BASIC 3.0 Extension Library 8, 9  
BHT-BASIC 3.0 Interpreter 11  
BHT-Ir protocol 9, 13, 50, 52, 53, 56, 87, 103, 105, 106, 107, 108, 117, 118, 138

BHT-protocol 10, 48, 56, 87, 89, 90, 91, 92, 100, 101, 138

bit time 50

black-and-white inverted label reading function 46

---

## C

---

C-600 v, 20, 139  
calendar clock 11, 21, 23, 24, 30, 35, 39, 42, 45, 124, 148  
character length 48, 52, 53, 84, 86  
CHG1 LED 135, 139  
CHG2 LED 135, 142, 143  
clip 3, 14  
CODABAR (NW7) 60, 149, 151  
CODE128 60, 149, 151  
CODE39 60, 149, 150, 151, 152  
CODE93 60, 149, 151  
communications parameter 30, 38, 41, 42, 48, 49, 52, 79, 80, 86, 128, 129, 130, 138  
communications protocol ii, 13, 48, 49, 50, 52, 53, 56, 81, 87, 138  
connector cover 14, 35  
control character 87, 88, 89, 90, 103, 104, 105, 106  
copying file 31, 38, 73, 128  
CU-6000 ii, iv, ix, 6, 8, 9, 10, 14, 82, 84, 86, 133, 134, 135, 136, 137, 138, 140, 141, 144, 145, 154, 155  
CU-6001 v, 20, 134, 135, 138, 139, 140, 141, 142, 143, 154  
CU-6002 134, 135, 154

---

## D

---

DATA communications LED 135  
DCE 145  
decode level 46  
defective file 69, 70, 124  
deleting file 31, 71  
DIP switch 137  
direct-connect interface, direct-connect interface port 9, 10, 14, 35, 48, 49, 52, 55, 63, 65, 82, 83, 84, 86, 103, 153  
download, downloading 8, 9, 10, 11, 12, 23, 30, 31, 35, 36, 37, 38, 39, 55, 56, 75, 77, 78, 79, 99, 111, 116, 124, 126, 127, 128, 129, 138  
DRIVE A 10, 22, 23, 35, 36, 39, 40, 69, 71, 72, 73  
DRIVE B 10, 22, 35, 39, 40, 69, 71, 73  
drivers 11  
DTE 145

---

## E

---

EAN-13 60, 149, 151  
EAN-8 60, 149, 151  
execution program 30, 42, 43, 125, 126  
extension programs 8, 9, 10, 11, 12

---

## F

---

flash ROM 8, 10, 11, 12, 21, 22, 26, 30, 31, 35, 36, 38, 39, 67, 69, 71, 73, 76, 78, 104, 111, 123, 124, 128, 129, 148  
flash ROM error 123  
font size 30, 42, 44, 67, 148

---

## H

---

hand strap 3, 14  
horizontal parity 48, 50, 51, 53, 54, 90, 100  
HT<->HT COPY 35, 36, 39, 40

---

## I

---

illumination LED 2  
initializing, initialization 21, 22, 23, 44, 124  
interface cable 137, 145  
interface port 8, 9, 14, 30, 35, 38, 41, 42, 48, 49, 55, 63, 64, 65, 79, 80, 82, 86, 128, 129, 130, 134, 137, 138, 144, 155  
interleaved 2 of 5 (ITF) 2, 60, 148, 149, 150, 151, 152  
IR beam 6, 48, 49, 50, 84  
IR beam output pulse width 49, 50  
IR physical layer standards 9  
IR port 6, 63  
Ir-Transfer Utility C iii, 8, 9, 12, 36, 40, 56, 77, 80, 138  
IrDA 6, 9, 13  
IrDA interface, IrDA interface port 8, 9  
IrDA Serial Infrared Data Link Standard 9  
IrDA-SIR 1.0 9, 13

---

## J

---

JIS font file 26, 30, 31, 37, 69, 71, 75, 127  
JIS Level 1 font, JIS1 font 26, 67, 75, 77, 78, 79, 80, 129, 130  
JIS Level 2 font, JIS2 font 26, 75, 77, 78, 79, 80, 129, 130

---

**K**

---

key entry & beeper test 59, 68

---

**L**

---

LCD and reading confirmation LED tests  
59, 66

LCD contrast 7, 19, 23, 27, 44

lithium battery 10, 18, 148

long-range scanning 2, 42, 46, 149

low battery indication 19, 122

---

**M**

---

M1 key 2, 4, 14, 15, 22, 27, 57, 58, 68,  
156, 157, 158

M2 key 2, 14, 15, 57, 58, 68, 157, 158

magic key 42, 148

memory backup test 1 124

memory backup test 2 124

memory test 30, 61

message version 22, 23, 30, 42, 44

---

**N**

---

Ni-MH battery cartridge ii, v, vii, 17,  
20, 122, 133, 134, 135, 139, 141,  
142, 143, 148, 154

nonlock 57

NW7 60, 149, 150, 151, 152

---

**O**

---

onetime 57

optical communications 6, 8, 14, 134,  
155

optical communications unit 8, 14,  
134

optical interface 6, 14, 35, 48, 49, 63,  
64, 84, 86, 134, 138, 153, 155

---

**P**

---

parity 48, 50, 51, 52, 53, 54, 84, 85, 86,  
90, 100

POWER LED 135, 142

program execution 30, 34, 122

protection sheet (of DIP switch) 137

protocol ii, 9, 10, 13, 48, 49, 50, 51, 52,  
53, 54, 56, 87, 89, 90, 91, 92, 100,  
101, 103, 105, 106, 107, 108, 117,  
118, 138

---

**R**

---

RAM 8, 10, 11, 18, 22, 30, 31, 34, 35,  
36, 38, 39, 43, 59, 61, 69, 71, 72,  
73, 78, 123, 124, 126, 128, 129,  
148

reading confirmation LED 2, 14, 30,  
59, 60, 66, 148

response method 84, 85, 87, 103

resume data saving error 125

resume function 30, 47

RS-232C ii, 8, 9, 81, 82, 134, 137, 144,  
145, 153, 155

RTC error 124

---

**S**

---

serial number 48, 50, 51, 53, 54, 90,  
91, 106, 107, 117

shift key 42, 57, 58

small-size font 12, 148

soft error 18

space code (handling), FIELD SPACE  
48, 50, 51, 53, 54

standard 2 of 5 (STF) 60, 149, 151



standard-size font 12, 148  
status indicator 134, 135  
STF 60  
stop bit length 52, 53, 86  
supplemental codes 149, 151  
system area 11, 21, 22, 124  
system mode ii, 7, 8, 10, 11, 15, 24, 26,  
29, 30, 31, 32, 34, 35, 39, 55, 56,  
63, 86, 92, 93, 108, 109, 117, 124,  
125, 126, 138  
system program malfunction 123  
system status indication 30, 42, 44

---

## T

---

timeout 50, 51, 53, 54, 64, 65, 93, 109,  
116  
touch scanning 42, 46  
Transfer Utility iii, 8, 9, 10, 12, 36, 40,  
56, 77, 80, 138  
transmission speed, transmit speed 9,  
13, 48, 49, 50, 52, 84, 86, 137, 153  
transparency 84, 88, 104  
trigger switch 2, 14, 15, 58, 157

---

## U

---

UPC-A 60, 149, 151  
UPC-E 60, 149, 151  
upload, uploading 11, 18, 19, 30, 31,  
35, 39, 40, 41, 55, 56, 75, 76, 78,  
79, 80, 99, 116, 126, 130, 138  
user area 11, 26, 34, 35, 38, 69, 72, 73,  
76, 78, 124, 128

---

## V

---

version indication 30, 71  
version indication (of JIS font files)  
30, 71  
version indication (of System Program)  
30, 71  
vertical parity, parity bit 48, 52, 84, 85,  
86, 100

---

## X

---

X-MODEM 9

---

## Y

---

Y-MODEM 9

# **Bar Code Handy Terminal BHT-6000**

---

## **User's Manual**

Second Edition, September 1997

DENSO WAVE INCORPORATED

---

The purpose of this manual is to provide accurate information in the handling and operating of the BHT-6000. Please feel free to send your comments regarding any errors or omissions you may have found, or any suggestions you may have for generally improving the manual.

In no event will DENSO WAVE be liable for any direct or indirect damages resulting from the application of the information in this manual.