

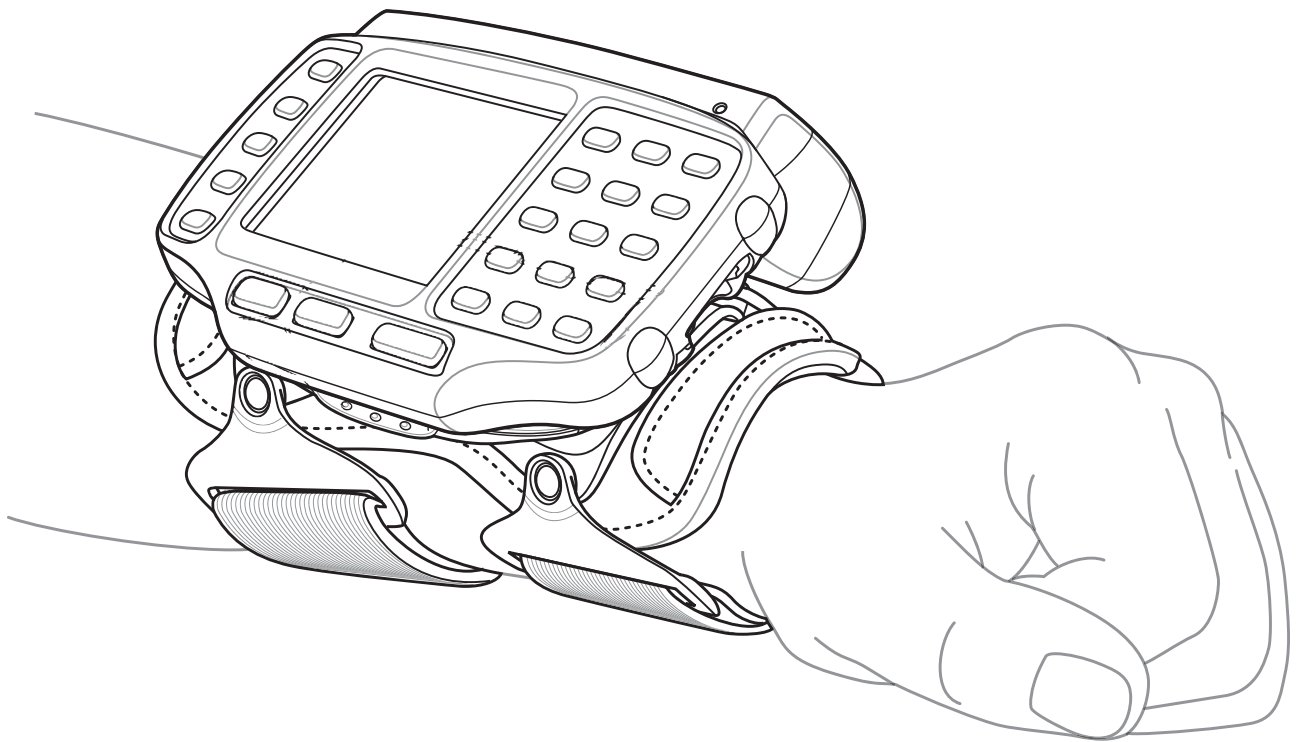

# WT4070/90 Wearable Terminal

## User Guide





# ***WT4070/90 Wearable Terminal***

## ***User Guide***

*72E-87633-03*

*Rev. A*

*May 2008*

© 2006-8 Motorola, Inc. All rights reserved.

No part of this publication may be reproduced or used in any form, or by any electrical or mechanical means, without permission in writing from Motorola. This includes electronic or mechanical means, such as photocopying, recording, or information storage and retrieval systems. The material in this manual is subject to change without notice.

The software is provided strictly on an “as is” basis. All software, including firmware, furnished to the user is on a licensed basis. Motorola grants to the user a non-transferable and non-exclusive license to use each software or firmware program delivered hereunder (licensed program). Except as noted below, such license may not be assigned, sublicensed, or otherwise transferred by the user without prior written consent of Motorola. No right to copy a licensed program in whole or in part is granted, except as permitted under copyright law. The user shall not modify, merge, or incorporate any form or portion of a licensed program with other program material, create a derivative work from a licensed program, or use a licensed program in a network without written permission from Motorola. The user agrees to maintain Motorola’s copyright notice on the licensed programs delivered hereunder, and to include the same on any authorized copies it makes, in whole or in part. The user agrees not to decompile, disassemble, decode, or reverse engineer any licensed program delivered to the user or any portion thereof.

Motorola reserves the right to make changes to any software or product to improve reliability, function, or design.

Motorola does not assume any product liability arising out of, or in connection with, the application or use of any product, circuit, or application described herein.

No license is granted, either expressly or by implication, estoppel, or otherwise under any Motorola, Inc., intellectual property rights. An implied license only exists for equipment, circuits, and subsystems contained in Motorola products.

MOTOROLA and the Stylized M Logo are registered in the US Patent & Trademark Office. Symbol is a registered trademark of Symbol Technologies, Inc. Bluetooth is a registered trademark of Bluetooth SIG. Microsoft, Windows and ActiveSync are either registered trademarks or trademarks of Microsoft Corporation. All other product or service names are the property of their respective owners.

Motorola, Inc.  
One Symbol Plaza  
Holtsville, New York 11742-1300  
<http://www.symbol.com>

---

## Patents

This product is covered by one or more of the patents listed on the website: [www.symbol.com/patents](http://www.symbol.com/patents)

---

## Revision History

Changes to the original manual are listed below:

Change	Date	Description
-01 Rev. A	09/25/2006	Initial Release
-02 Rev. A	02/22/2007	Add new start up windows, Fusion 2.5 information, 128 MB Flash configuration.
-03 Rev. A	05/06/2008	Add OEM version 05.30.000 information. Add freezer pouch information.



# Table of Contents

Patents.....	ii
Revision History.....	iii

## About This Guide

Introduction.....	ix
Documentation Set.....	ix
Configurations.....	x
Software Versions.....	xi
Chapter Descriptions.....	xii
Notational Conventions.....	xii
Related Documents and Software.....	xii
Service Information.....	xiii

## Chapter 1: Getting Started

Introduction.....	1-1
Unpacking the Wearable Terminal.....	1-2
Accessories.....	1-3
Getting Started.....	1-5
Installing and Removing the Main Battery.....	1-5
Installing the Main Battery.....	1-5
Charging the Battery.....	1-6
Charging the Main Battery and Memory Backup Battery.....	1-6
Charging Spare Batteries.....	1-7
Removing the Main Battery.....	1-7
Installing the Wrist Mount.....	1-8
Connecting a Scanner.....	1-10
Starting the Wearable Terminal.....	1-10

## Chapter 2: Using the Wearable Terminal

Introduction.....	2-1
Power Button.....	2-1
LED Indicators.....	2-2

Keypads .....	2-3
Two-color Alphanumeric Keypad .....	2-3
Triple-Tap Alphanumeric Keypad .....	2-5
Display .....	2-9
Start Up Window .....	2-9
Windows CE 5.0 Desktop .....	2-10
Status Icons .....	2-10
Using the Keypad to Navigate Applications .....	2-11
Key Combinations .....	2-11
Selecting Items .....	2-12
Navigating Menus .....	2-12
Navigating Tabs .....	2-12
Navigating Fields .....	2-13
Selecting Checkboxes and Radio Buttons .....	2-13
Selecting Items in a List .....	2-13
Resetting the Wearable Terminal .....	2-14
Performing a Warm Boot .....	2-14
Performing a Cold Boot .....	2-14
Data Capture .....	2-15
Laser Scanning .....	2-15
Scanning Considerations .....	2-15
Scanning Bar Codes .....	2-15
Scanning Tips .....	2-16
Scan LED Indicator .....	2-16
Waking the Wearable Terminal .....	2-17

### Chapter 3: Accessories

Introduction .....	3-1
Cradles .....	3-1
Scanners .....	3-1
Accessories .....	3-1
Single Slot USB Cradle .....	3-2
Battery Charging Indicators .....	3-3
Four Slot Ethernet Cradle .....	3-4
Battery Charging .....	3-5
LED Charge Indications .....	3-5
Speed LED .....	3-5
Link LED .....	3-5
Battery Charging Indicators .....	3-5
Four Slot Spare Battery Charger .....	3-6
Spare Battery Charging with the Four Slot Spare Battery Charger .....	3-6
Battery Charging Indicators .....	3-6
RS409 Scanner .....	3-7
RS309 Scanner .....	3-9
Hip Mount .....	3-11
Routing an Extended Cable Scanner .....	3-12
Freezer Pouch .....	3-14
Wired Headset .....	3-16



**Chapter 4: Maintenance & Troubleshooting**

Introduction .....	4-1
Maintaining the Wearable Terminal .....	4-1
Wrist Mount Cleaning Instructions .....	4-1
Battery Safety Guidelines .....	4-2
Troubleshooting .....	4-3
Wearable Terminal .....	4-3
Four Slot Ethernet Cradle .....	4-6
Four Slot Spare Battery Charger .....	4-7
Single Slot USB Cradle .....	4-8

**Appendix A: Specifications**

Technical Specifications .....	A-1
Wearable Terminal .....	A-1
RS309 Scanner .....	A-3
RS409 Scanner .....	A-4
Cradles .....	A-6

**Appendix B: Regulatory Information**

Introduction .....	B-1
Accessory Power Supply Regulatory Compliance .....	B-1



# About This Guide

---

## Introduction

This guide provides information about using the WT4070/90 family of mobile terminals and accessories.

✓ **NOTE** Screens and windows pictured in this guide are samples and can differ from actual screens.

## Documentation Set

The documentation set for the WT4070/90 is divided into guides that provide information for specific user needs.

- **Microsoft Application Guide** - describes how to use Microsoft developed applications.
- **Symbol Application Guide** - describes how to use Symbol developed applications.
- **WT4070/90 Wearable Terminal User Guide** - describes how to use the WT4070/90 wearable terminal.
- **WT4070/90 Wearable Terminal Integrator Guide** - describes how to set up the WT4070/90 wearable terminal and the accessories.
- **SMDK Help File** - provides API information for writing applications.

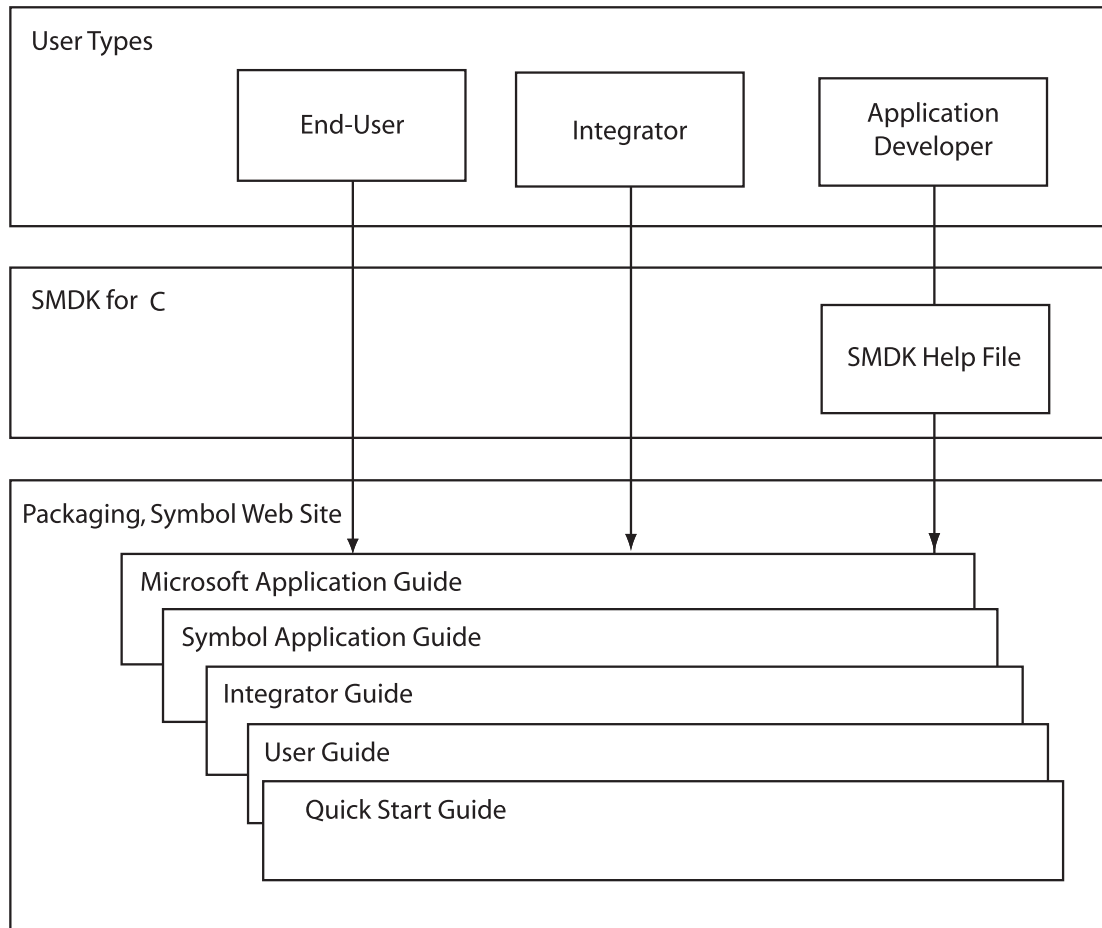

## Configurations

This guide covers the following configurations:

Configuration	Radios	Display	Memory	Data Capture	Operating System	Keypads
WT4070	WLAN: 802.11b/g WPAN: Bluetooth	2.8" QVGA Color	128 MB RAM/ 64 MB Flash	Optional accessory	Windows CE 5.0 Professional	Two-color or Triple-tap Alphanumeric Keypad
WT4090	WLAN: 802.11a/b/g WPAN: Bluetooth	2.8" QVGA Color	128 MB RAM/ 64 MB Flash or 128 MB RAM/ 128 MB Flash	Optional accessory	Windows CE 5.0 Professional	Two-color or Triple-tap Alphanumeric Keypad

## Software Versions

This guide covers various software configurations and references are made to operating system or software versions for:

- OEM version
- Fusion version.

### OEM Software

To determine the OEM software version:

1. Press **CTRL** and then **ESC** to open the **Start** menu.
2. Using the navigation keys, select **Settings**.
3. Press the Blue key and the down arrow to open the **Control Panel** sub-menu.
4. Press **ENTER** key to launch **Control Panel**.
5. Using the navigation keys, select the **System Information** icon.
6. Press **ENTER** key to launch **System Information** applet.

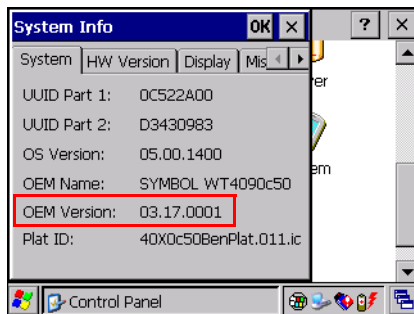

### Fusion Software

To determine the Fusion software version:

1. Press **ALT - w**. The **Wireless** menu appears.
2. Using the navigation keys, select **Wireless Status**.
3. Press **ENTER**. The **Wireless Status** window displays.
4. Press **5**. The **Versions** screen appears.

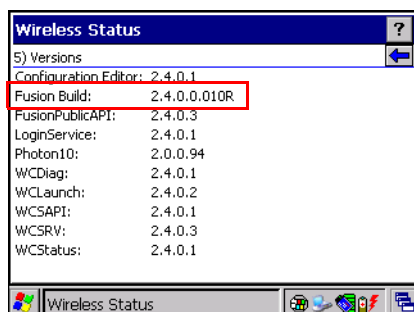

---

## Chapter Descriptions

Topics covered in this guide are as follows:

- *Chapter 1, Getting Started*, provides information on getting the wearable terminal up and running for the first time.
- *Chapter 2, Using the Wearable Terminal*, explains how to use the wearable terminal. This includes instructions for powering on and resetting the wearable terminal, entering and capturing data.
- *Chapter 3, Accessories*, describes the accessories available for the wearable terminal and how to use the accessories with the wearable terminal.
- *Chapter 4, Maintenance & Troubleshooting*, includes instructions on cleaning and storing the wearable terminal, and provides troubleshooting solutions for potential problems during wearable terminal operation.
- *Appendix A, Specifications*, includes a table listing the technical specifications for the wearable terminal.
- *Appendix B, Regulatory Information*, contains the accessory power supply regulatory compliance statements.

---

## Notational Conventions

The following conventions are used in this document:

- “Wearable terminal” refers to the WT4070/90 series of wearable terminals.
- *Italics* are used to highlight the following:
  - Chapters and sections in this guide
  - Related documents
- **Bold** text is used to highlight the following:
  - Dialog box, window and screen names
  - Drop-down list and list box names
  - Check box and radio button names
  - Icons on a screen
  - Key names on a keypad
  - Button names on a screen.
- Bullets (•) indicate:
  - Action items
  - Lists of alternatives
  - Lists of required steps that are not necessarily sequential.
- Sequential lists (e.g., those that describe step-by-step procedures) appear as numbered lists.

---

## Related Documents and Software

The following documents provide more information about the WT4090 wearable terminals.

- *WT4090 Quick Start Guide*, p/n 72-86717-xx

- *WT4090 Windows® CE 5.0 Regulatory Guide*, p/n 72-86718-xx
- *WT4090 Wearable Terminal Integrator Guide*, p/n 72E-87638-xx
- *RS309 Scanner Quick Reference Guide*, p/n 72-86011-xx
- *RS409 Scanner Quick Reference Guide*, p/n 72-86010-xx
- *Wireless Fusion Enterprise Mobility Suite User Guide for Version 2.XX*, p/n 72E-107170-xx
- *Symbol Application Guide for Symbol Devices*, p/n 72E-68901-xx
- *Microsoft Applications for Windows Mobile and CE 5.0 User Guide*, p/n 72E-78456-xx
- *Symbol Mobility Developer Kits*, available at: <http://support.symbol.com>.
- Device Configuration Package (DCP for WT4090c50) and Platform SDK (PSDK9090c50) for WT4090 with Windows CE 5.0, available at: <http://support.symbol.com>.
- ActiveSync software, available at: <http://www.microsoft.com>.

For the latest version of this guide and all guides, go to: <http://support.symbol.com>.

---

## Service Information

If you have a problem with your equipment, contact Motorola Enterprise Mobility support for your region. Contact information is available at: <http://www.symbol.com/contactsupport>.

When contacting Enterprise Mobility support, please have the following information available:

- Serial number of the unit
- Model number or product name
- Software type and version number

Motorola responds to calls by email, telephone or fax within the time limits set forth in support agreements.

If your problem cannot be solved by Motorola Enterprise Mobility Support, you may need to return your equipment for servicing and will be given specific directions. Motorola is not responsible for any damages incurred during shipment if the approved shipping container is not used. Shipping the units improperly can possibly void the warranty.

If you purchased your Enterprise Mobility business product from a Motorola business partner, contact that business partner for support.





# Chapter 1 Getting Started

## Introduction

This chapter lists the parts and accessories for the wearable terminal and explains how to install and charge the batteries and start the wearable terminal for the first time.

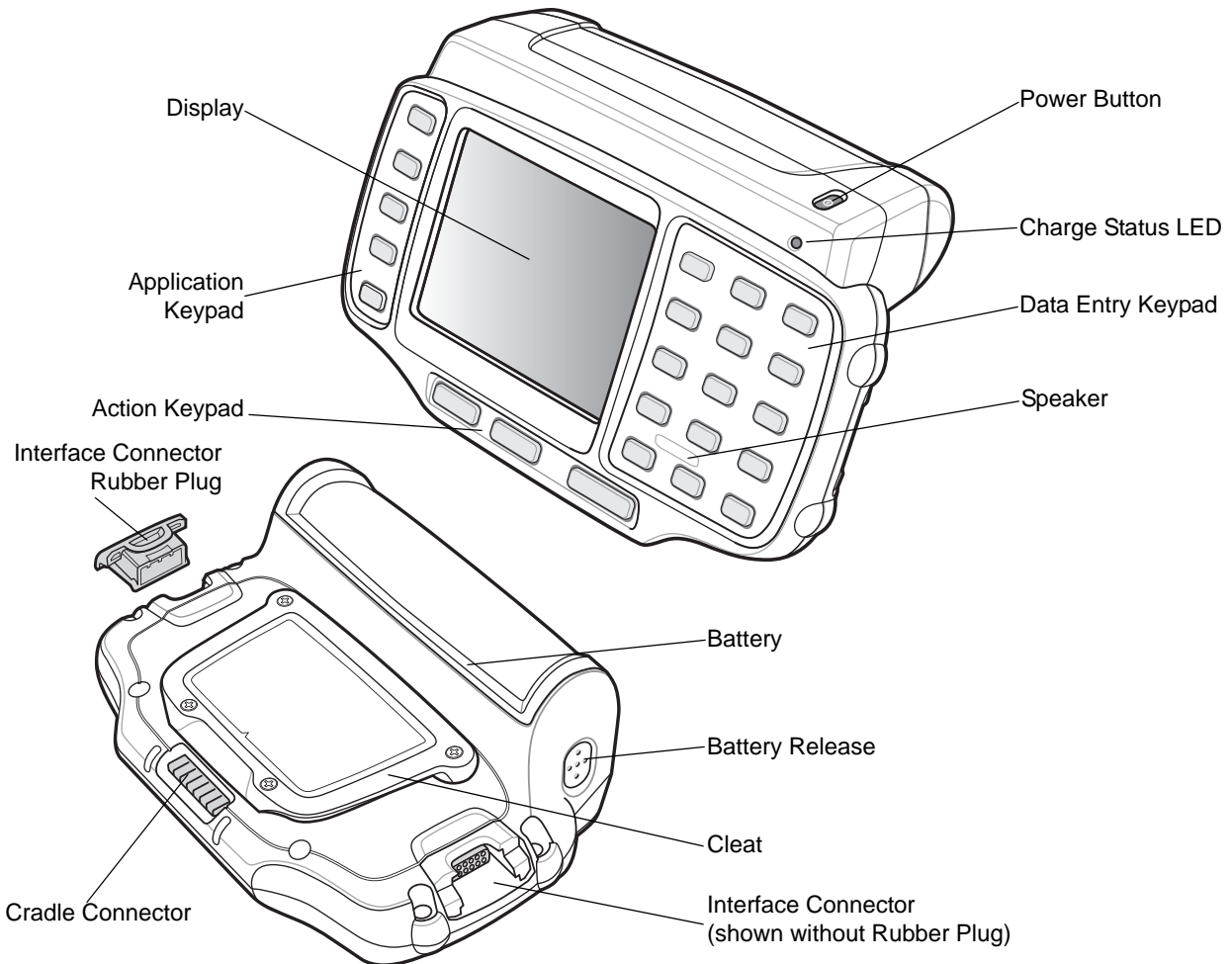

**Figure 1-1** WT4070/90 Wearable Terminal

**Table 1-1** *Parts of the WT4070/90*

Item	Description
Display	Displays the application and data stored on the device.
Power Button	Places the wearable terminal in to the suspend mode or resumes normal operation. Performs a warm boot when held down for five seconds. See <a href="#">Resetting the Wearable Terminal on page 2-14</a> for information about performing a warm boot.
Charge Status LED	Indicates the charging status of the battery.
Speaker	Provides audio playback.
Keypads	Enable user input.
Battery	Provides power to the wearable terminal.
Interface Connector	Provides electrical connection to an accessory, such as a scanner.
Cradle Connector	Provides electrical connection to a cradle.
Battery Release	Releases the battery for removal.
Cleat	Provides mounting for the wrist mount and cradles.

---

## Unpacking the Wearable Terminal

Carefully remove all protective material from around the wearable terminal and save the shipping container for later storage and shipping.

Verify that you received all equipment listed below:

- Wearable terminal
- Lithium-ion battery
- Regulatory Guide
- Quick Start Guide.

Inspect the equipment for damage. If you are missing any equipment or if you find any damaged equipment, contact the Symbol Global Interactive Center immediately. See [page xiii](#) for contact information.

## Accessories

Table 1-2 lists the major accessories available for the wearable terminal:

**Table 1-2** *Wearable Terminal Accessories*

Accessory	Description
Single Slot USB Cradle	Charges the wearable terminal main battery and a spare battery. It also synchronizes the wearable terminal with a host computer through a USB connection.
Four Slot Ethernet Cradle	Charges up to four wearable terminals (with main battery installed) and provides communication through an Ethernet connection.
Four Slot Spare Battery Charger	Charges up to four spare batteries.
RS409 Scanner	Provides scanning capability.
RS309 Scanner	Provides scanning capability.
Wrist Mount	Provides a means for wearing the wearable terminal on the arm for hands-free applications.
Hip Mount	Provides a means for wearing the wearable terminal on a belt for hands-free applications.
Headset	For audio playback/recording during voice-enabled applications.
Headset Adapter	Connects an optional headset with a barrel jack connector to the wearable terminal.
Replacement Batteries	Standard Capacity Battery: 2330 mAh
Software	<i>Symbol Mobility Developer Kits</i> available at: <a href="http://support.symbol.com">http://support.symbol.com</a> . Device Configuration Package (DCPforWT40x0c50) and Platform SDK (PSDK40x0c50) for WT40x0, available at: <a href="http://support.symbol.com">http://support.symbol.com</a> .

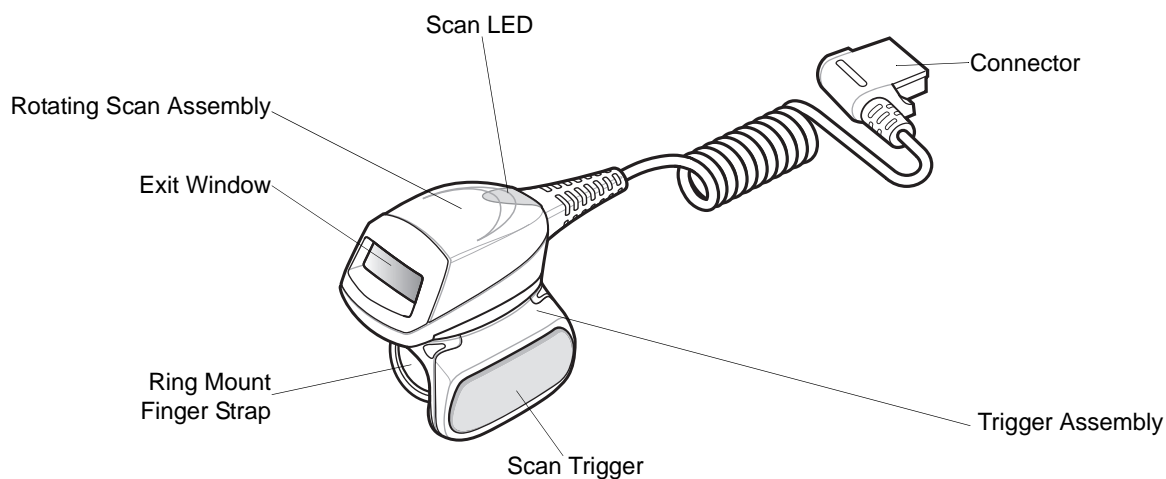

**Figure 1-2** *RS409 Scanner*

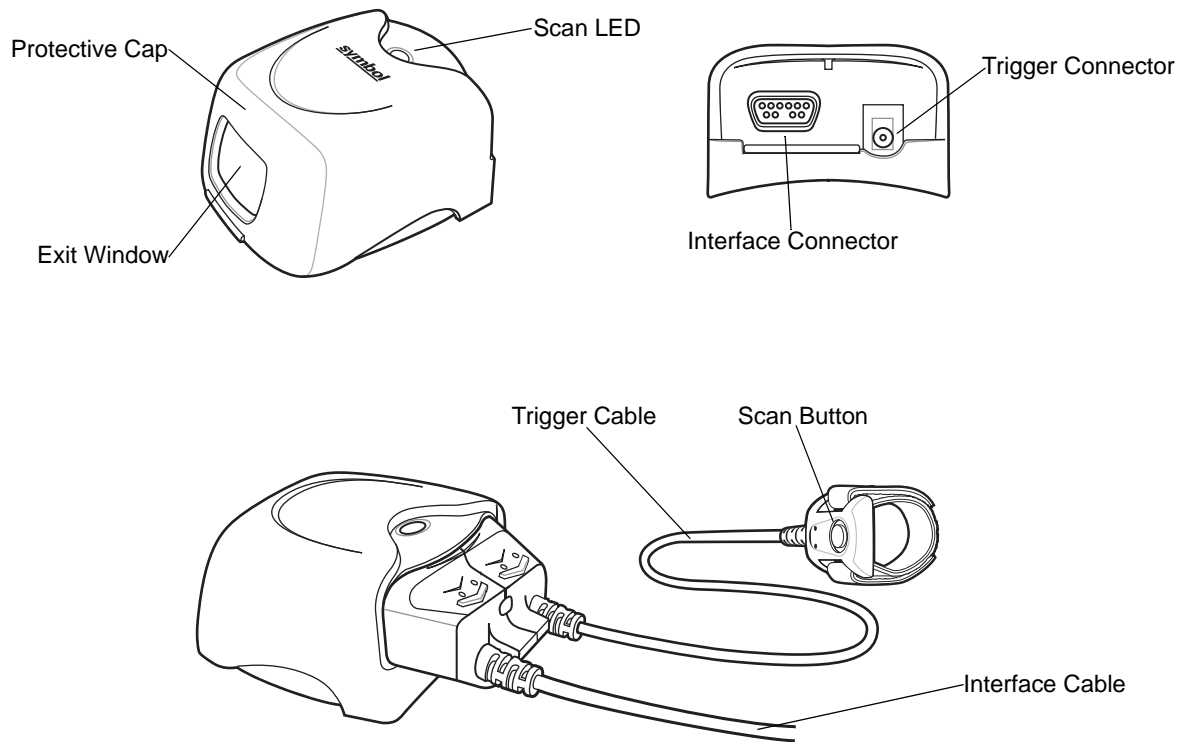

**Figure 1-3** RS309 Scanner

---

## Getting Started

In order to start using the wearable terminal for the first time:

- Install the main battery
- Charge the main battery and backup battery
- Install the wearable terminal onto the wrist mount
- Install an optional scanner
- Start the wearable terminal.

✓ **NOTE** The main battery can be charged before or after installation into the wearable terminal. Use the Single Slot USB cradle or Four Slot Spare Battery Charger to charge the main battery before installation, or the Single Slot USB cradle or Four Slot Ethernet cradle to charge the main battery after installation.

---

## Installing and Removing the Main Battery

### Installing the Main Battery

Before using the wearable terminal, install a lithium-ion (Li-ion) battery by placing the battery into the wearable terminal as shown in [Figure 1-4](#).

✓ **NOTE** Ensure the battery is fully inserted. An audible click can be heard as the battery is fully inserted. A partially inserted battery may result in unintentional data loss.

When a battery is installed in a wearable terminal for the first time the wearable terminal boots and powers on automatically.

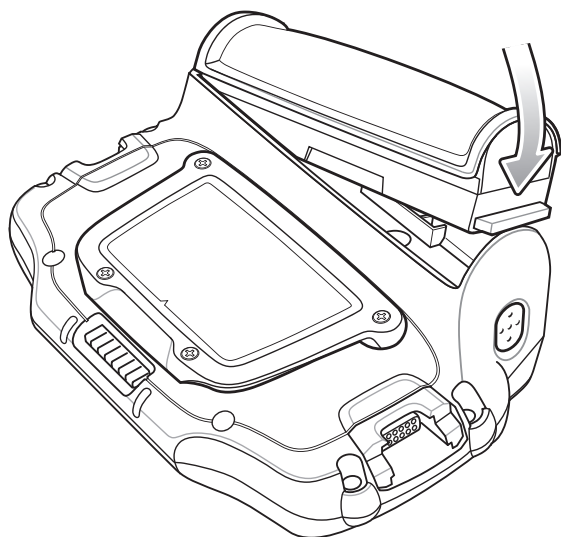

**Figure 1-4** *Installing the Main Battery*

## Charging the Battery



**CAUTION** Ensure that you follow the guidelines for battery safety described in [Battery Safety Guidelines on page 4-2](#).

### Charging the Main Battery and Memory Backup Battery

Before using the wearable terminal for the first time, charge the main battery until the amber Charge Status LED remains lit (see [Table 1-3 on page 1-6](#) for charge status indications).

The wearable terminal is equipped with a memory backup battery which automatically charges from the main battery whether or not the wearable terminal is operating or is in suspend mode. The memory backup battery retains data in memory for at least 30 minutes when the wearable terminal's main battery is removed or fully discharged. When the wearable terminal is used for the first time or after the memory backup battery has fully discharged, the memory backup battery requires approximately 15 hours to fully charge. Do not remove the main battery from the wearable terminal for 15 hours to ensure that the memory backup battery fully charges. If the main battery is removed from the wearable terminal or the main battery is fully discharged, the memory backup battery completely discharges in several hours.

When the wearable terminal reaches a very low battery state, the combination of main battery and backup battery retains data in memory for at least 24 hours.



**NOTE** Do not remove the main battery within the first 15 hours of use. If the main battery is removed before the backup battery is fully charged, data may be lost.

Charge the wearable terminal with an installed main battery using either the Single Slot USB cradle or the Four Slot Ethernet cradle.

To charge the main battery:

1. Ensure the cradle used to charge the main battery is connected to the appropriate power source.
2. Insert the wearable terminal into a cradle.
3. The wearable terminal starts to charge automatically. The amber Charge Status LED lights to indicate the charge status. See [Table 1-3](#) for charging indications. The standard capacity battery fully charges in less than four hours.

**Table 1-3** *Wearable Terminal LED Charge Indicators*

LED	Indication
Off	Wearable terminal is not in cradle. Wearable terminal not placed correctly. Charger is not powered.
Fast Blinking Amber	Charging error: <ul style="list-style-type: none"> <li>• Temperature is too low or too high.</li> <li>• Charging has gone on too long without completing (typically eight hours).</li> </ul>
Slow Blinking Amber	Wearable terminal is charging.
Solid Amber	Charging complete. Note: When the battery is initially inserted in the wearable terminal, the amber LED flashes once if the battery power is low or the battery is not fully inserted.

## Charging Spare Batteries

Use the following accessories to charge spare batteries:

- Single Slot USB Cradle
- Four Slot Spare Battery Charger.

To charge a spare battery:

1. Ensure the accessory used to charge the spare battery is connected to the appropriate power source.
2. Insert the spare battery into the accessory's spare battery charging slot with the charging contacts facing down (over the charging pins) and gently press down on the battery to ensure proper contact.
3. The battery starts to charge automatically. The amber charge LED on the accessory lights to show the charge status. See [Chapter 3, Accessories](#) for accessory charge LED indicator definitions.

The standard capacity battery fully charges in less than four hours.

## Removing the Main Battery

To remove the main battery:

1. Prior to removing the battery, ensure that the wearable terminal is in suspend mode. If the wearable terminal is not in suspend mode, press the Power button to place the wearable terminal in suspend mode.
2. Press the battery release button. The battery partially ejects from the wearable terminal.
3. Remove the battery from the wearable terminal.

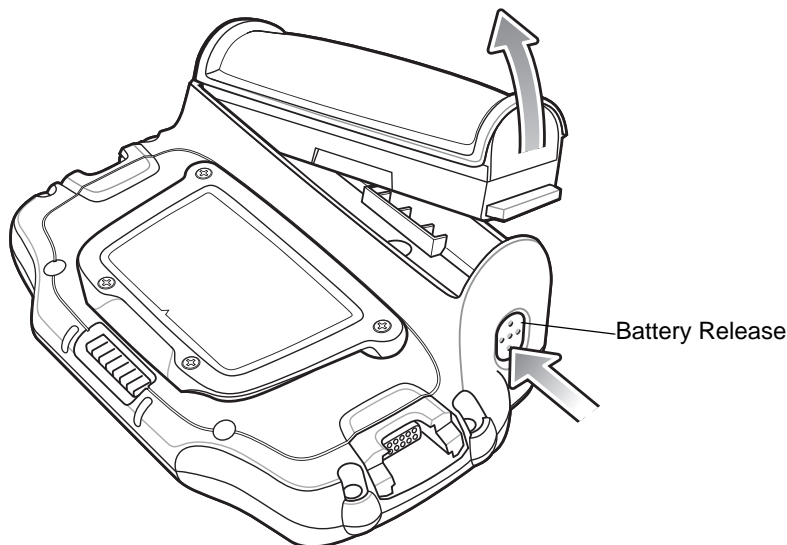

**Figure 1-5** *Removing the Main Battery*

## Installing the Wrist Mount

The wrist mount provides the mounting of the wearable terminal on the forearm for hands-free applications. Refer to the Wrist Mount Installation Guide for information on the wrist mount.

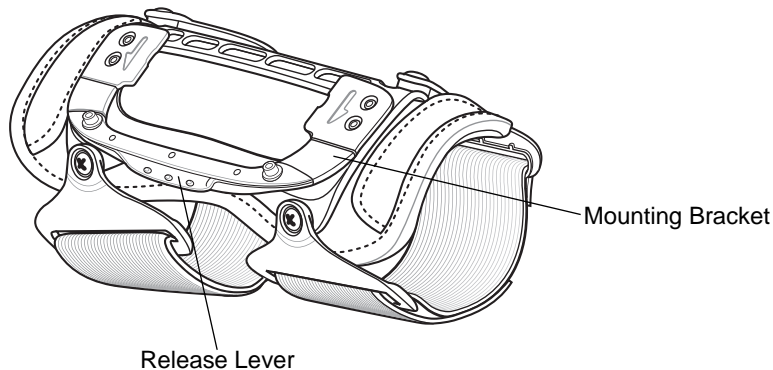

**Figure 1-6** *Wrist Mount*

To install the wrist mount:

1. Determine which arm the wrist mount will be used on.
2. Install the short strap on the end closest to the wrist.
3. Install the long strap on the other end.
4. Slide the hand into the wrist mount.
5. Tighten the straps.
6. Align the cleat on the back of the wearable terminal with the mounting bracket on the wrist mount.

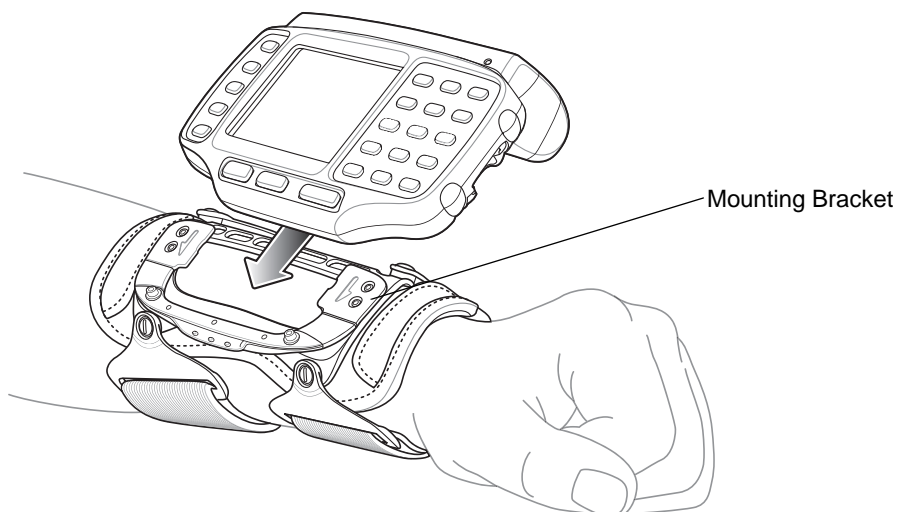

**Figure 1-7** *Aligning the Cleat*

7. Slide the wearable terminal onto the wrist mount until it clicks into place.
8. If necessary, loosen and re-tighten the straps.



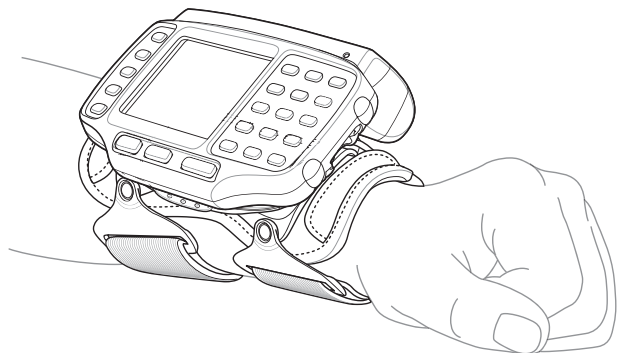

**Figure 1-8** *Wearable Terminal and Wrist Mount*

To remove the wearable terminal from the wrist mount, press down on the release lever and slide the wearable terminal out.

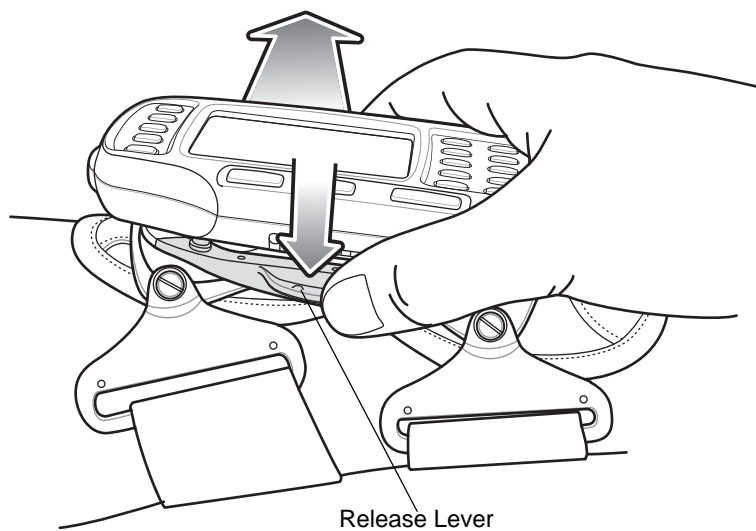

**Figure 1-9** *Wearable Terminal Removal*

## Connecting a Scanner

The RS309 and RS409 scanners can be used with the wearable terminal. Refer to [RS309 Scanner on page 3-9](#) and [RS409 Scanner on page 3-7](#) for procedures for connecting the scanner to the wearable terminal.

## Starting the Wearable Terminal

Press the Power button to turn on the wearable terminal. If the wearable terminal does not power on, perform a cold boot. See [Resetting the Wearable Terminal on page 2-14](#).

✓ **NOTE** When a battery is fully inserted in a wearable terminal for the first time, upon the wearable terminal's first power up, the device cold boots and powers on automatically.

When the wearable terminal is powered on for the first time, it initializes its system. The *Symbol* splash screen ([Figure 1-10](#)) appears for a short period of time followed by the Start Up window.

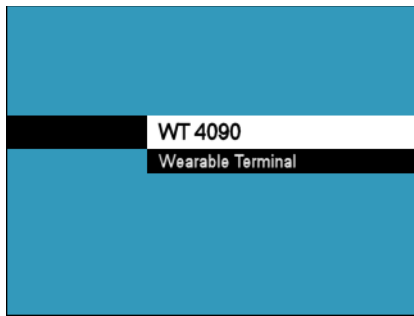
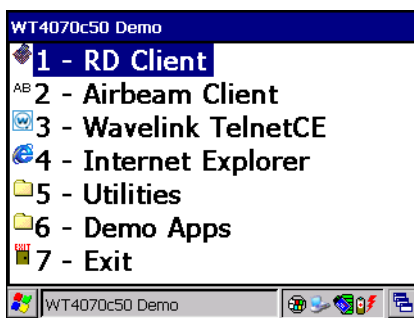

Figure 1-10 *Symbol Splash Screen*



OEM VERSION 02.17.0001



OEM VERSION 03.17.0001



OEM VERSION 04.20.0004 or 05.30.0001

Figure 1-11 *Start Up Window*

# Chapter 2 Using the Wearable Terminal

---

## Introduction

This chapter explains the physical buttons and controls on the wearable terminal, and provides basic instructions for using the wearable terminal, including powering on and resetting the wearable terminal, using a headset, entering information and scanning.

This chapter also details the operation of the Windows CE 5.0 operating system including the desktop, applications and settings. Depending upon the programs installed on the wearable terminal, some of these items may not be available.

---

## Power Button

Press the Power button to turn the wearable terminal screen on and off (suspend mode). The wearable terminal is on when the screen is on and the wearable terminal is in suspend mode when the screen is off. For more information, see [Starting the Wearable Terminal on page 1-10](#).

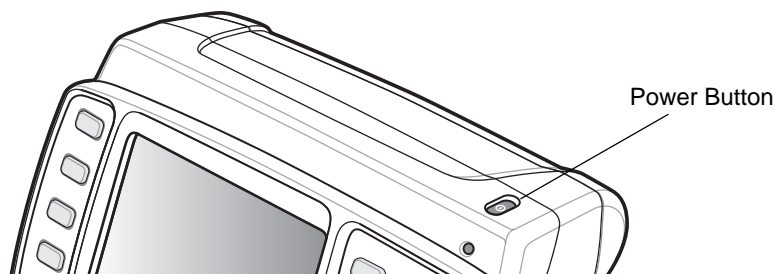

**Figure 2-1** Power Button

The Power button is also used to reset the wearable terminal by performing a warm or cold boot.

- Warm Boot (Soft Reset) - Resets the wearable terminal.
- Cold Boot (Hard Reset) - Resets the wearable terminal, removes all added applications and restores all factory default settings.

## LED Indicators

The Charge Status LED indicates the WT4090 charging status when the WT4090 is in a cradle. [Table 2-1](#) describes the Charge Status LED indications.

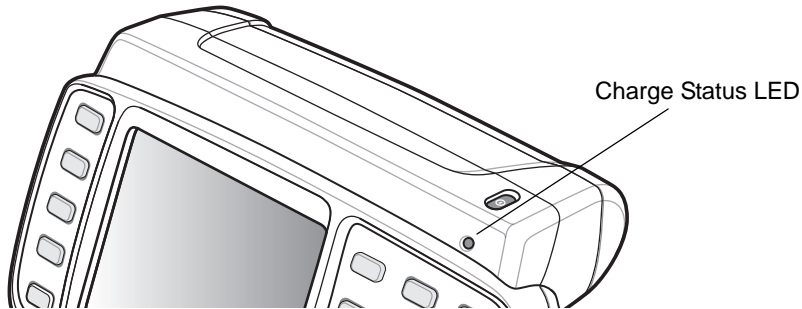

**Figure 2-2** Charge Status LED

**Table 2-1** Charge Status LED Indications

LED State	Indication
Off	Wearable terminal is not in cradle. Wearable terminal not placed correctly. Charger is not powered.
Slow Blinking Amber	Main battery in wearable terminal is charging.
Fast Blinking Amber	Charging error: <ul style="list-style-type: none"> <li>• Temperature is too low or too high.</li> <li>• Charging has gone on too long without completing (typically eight hours).</li> </ul>
Solid Amber	Charging complete. Note: When the battery is initially inserted in the wearable terminal, the amber LED flashes once if the battery power is low or the battery is not fully inserted.

## Keypads

The wearable terminal has the following keypads:

- Two-color alphanumeric keypad
- Triple-tap (cell phone like) alphanumeric keypad.

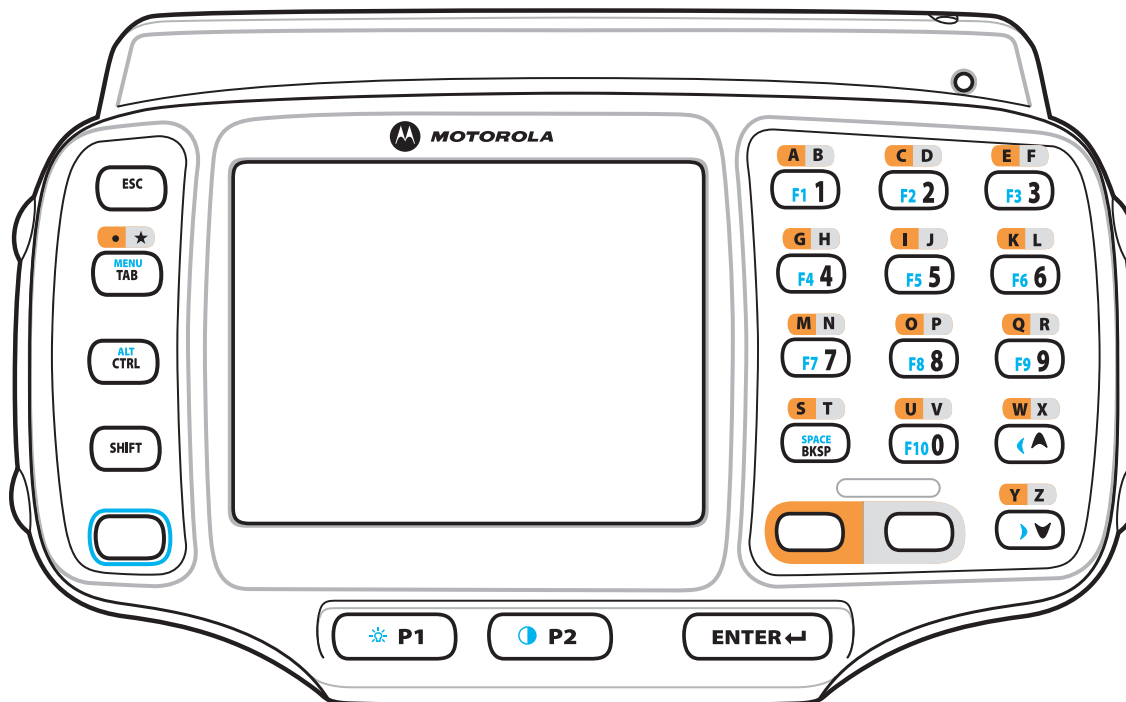

### Two-color Alphanumeric Keypad

The two-color alphanumeric keypad contains application keys, scroll keys and function keys. The keypad is color-coded to indicate the alternate function keys (blue, orange and gray). Note that keypad functions can be changed by an application so the wearable terminal's keypad may not function exactly as described. See [Table 2-2 on page 2-3](#) for key and button descriptions and [Table 2-4 on page 2-6](#) for the keypad's special functions.





**Figure 2-3** Two-color Alphanumeric Keypad

**Table 2-2** Two-color Alphanumeric Keypad Descriptions

Key	Description
Orange	Press and release the Orange key to activate alphabetic characters (shown on the keypad in orange). The  icon appears on the Windows CE desktop taskbar.
Gray	Press and release the Gray key to activate alphabetic characters (shown on the keypad in gray). The  icon appears on the Windows CE desktop taskbar.
Blue	Press and release the Blue key to activate the keypad alternate functions (shown on the keypad in blue). The  icon appears on the Windows CE desktop taskbar.

**Table 2-2** Two-color Alphanumeric Keypad Descriptions (Continued)

Key	Description
Scroll Keys	Moves up or down from one item to another or increases/decreases specified values. Moves left or right from one item to another when used with the Blue key. For each left or right scroll, the Blue key must be pressed first.
ESC	Exits the current operation.
Alphanumeric	In default state, produces the numeric value on the key. In Left Alpha state, produces the lower case alphabetic characters in the orange area. In Right Alpha state, produces the lower case alphabetic characters in the gray area. When the <b>SHIFT</b> key is pressed in the Alpha state, the upper case alphabetic characters on the key are produced. For example, press and release the Orange key, press and release the <b>SHIFT</b> key and then press the <b>4</b> key once to produce the letter 'G'.
BKSP	Backspace function. Space function when used with the Blue key.
CTRL (Control)	Press and release the CTRL key to activate the keypad alternate CTRL functions. The  icon appears on the Windows CE desktop taskbar. Press the Blue key followed by the CTRL key to activate the keypad alternate ALT functions. The  icon appears on the Windows CE desktop taskbar.
SHIFT	Press and release the SHIFT key to activate the keypad alternate SHIFT functions. The  icon appears on the Windows CE desktop taskbar.
ENTER	Executes a selected item or function.
TAB	Move the focus to the next field in a window.
P1	Programmable key. When used with the Blue key, toggles the keypad backlight on and off.
P2	Programmable key. When used with the Blue key, toggles the display backlight on and off.

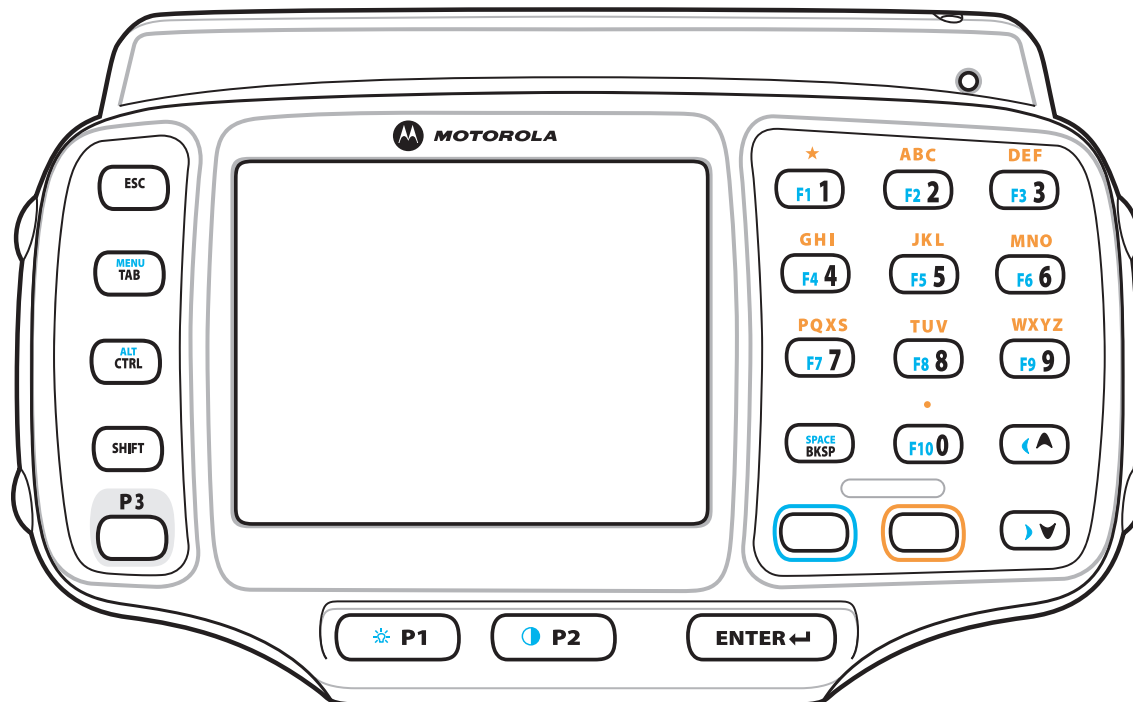

## Triple-Tap Alphanumeric Keypad

The triple-tap alphanumeric keypad contains application keys, scroll keys and function keys. The keypad is color-coded to indicate the alternate function keys (blue and orange). Note that keypad functions can be changed by an application so the wearable terminal's keypad may not function exactly as described. See [Table 2-3 on page 2-5](#) for key and button descriptions and [Table 2-4 on page 2-6](#) for the keypad's special functions.





**Figure 2-4** Triple-tap Alphanumeric Keypad

**Table 2-3** Triple-tap Alphanumeric Keypad Descriptions

Key	Description
Orange	Press and release the Orange key to activate alphabetic characters (shown on the keypad in orange). The  icon appears on the Windows CE desktop taskbar.
Blue	Press and release the Blue key to activate the keypad alternate functions (shown on the keypad in blue). The  icon appears on the Windows CE desktop taskbar.
Scroll Keys	Moves up or down from one item to another or increases/decreases specified values. Moves left or right from one item to another when used with the Blue key. For each left or right scroll, the Blue key must be pressed first.
ESC	Exits the current operation.

**Table 2-3** Triple-tap Alphanumeric Keypad Descriptions (Continued)

Key	Description
Alphanumeric	In default state, produces the numeric value on the key. In Alpha state, produces the lower case alphabetic characters shown in orange text. For example, press and release the Orange key and then press the 5 key twice to produce the lowercase letter 'k'. When the <b>SHIFT</b> key is pressed in Alpha state, the upper case alphabetic characters on the key are produced. For example, press and release the Orange key, press and release the <b>SHIFT</b> key and then press the 5 key twice to produce the uppercase letter 'K'.
BKSP	Backspace function. Space function when used with the Blue key.
CTRL (Control)	Press and release the CTRL key to activate the keypad alternate CTRL functions. The  icon appears on the Windows CE desktop taskbar. Press the Blue key followed by the CTRL key to activate the keypad alternate ALT functions. The  icon appears on the Windows CE desktop taskbar.
SHIFT	Press and release the SHIFT key to activate the keypad alternate SHIFT functions. The  icon appears on the Windows CE desktop taskbar.
ENTER	Executes a selected item or function.
TAB	Move the focus to the next field in a window.
P1	Programmable key. When used with the Blue key, toggles the keypad backlight on and off.
P2	Programmable key. When used with the Blue key, toggles the display backlight on and off.
P3	Programmable key.

The keypad is color-coded to indicate the alternate function key (blue) values and the alternate ALPHA key (orange) values. See [Table 2-4](#) for the special character generation.

**Table 2-4** Special Character Generation Map

Special Character	Two-color Keypad	Triple-tap Keypad
/ (forward slash)	Blue - Orange - 0	Blue - Orange - 0
[ (open square bracket)	Blue - Orange - 2	Blue - Orange - 2
] (close square bracket)	Blue - Orange - 3	Blue - Orange - 3
\ (Backslash)	Blue - Orange - 4	Blue - Orange - 4
' (apostrophe)	Blue - Orange - 5	Blue - Orange - 5
, (comma)	Blue - Orange - 6	Blue - Orange - 6



**Table 2-4** *Special Character Generation Map (Continued)*

<b>Special Character</b>	<b>Two-color Keypad</b>	<b>Triple-tap Keypad</b>
. (period)	Blue - Orange - 7 or Orange - <b>TAB</b>	Blue - Orange - 7
; (semi-colon)	Blue - Orange - 8	Blue - Orange - 8
= (equal sign)	Blue - Orange - 9	Blue - Orange - 9
- (dash)	Blue - Orange - <b>Tab</b>	Blue - Orange - <b>Tab</b>
! (exclamation point)	<b>Shift - 1</b>	<b>Shift - 1</b>
@ (at sign)	<b>Shift - 2</b>	<b>Shift - 2</b>
# (Pound sign)	<b>Shift - 3</b>	<b>Shift - 3</b>
\$ (dollar sign)	<b>Shift - 4</b>	<b>Shift - 4</b>
% (percent sign)	<b>Shift - 5</b>	<b>Shift - 5</b>
^ (carat)	<b>Shift - 6</b>	<b>Shift - 6</b>
& (ampersand)	<b>Shift - 7</b>	<b>Shift - 7</b>
* (asterisk)	<b>Shift - 8</b>	<b>Shift - 8</b>
( (open parenthesis)	<b>Shift - 9</b>	<b>Shift - 9</b>
) (close parenthesis)	<b>Shift - 0</b>	<b>Shift - 0</b>
' (single quote)	Blue - Orange - 1	Blue - Orange - 1
“ (double quote)	<b>Shift - Blue - Orange - 1</b>	<b>Shift - Blue - Orange - 1</b>
? (question mark)	<b>Shift - Blue - Orange - 0</b>	<b>Shift - Blue - Orange - 0</b>
{ (open curly bracket)	<b>Shift - Blue - Orange - 2</b>	<b>Shift - Blue - Orange - 2</b>

**Table 2-4** *Special Character Generation Map (Continued)*

<b>Special Character</b>	<b>Two-color Keypad</b>	<b>Triple-tap Keypad</b>
} (close curly bracket)	<b>Shift - Blue - Orange - 3</b>	<b>Shift - Blue - Orange - 3</b>
 (pipe)	<b>Shift - Blue - Orange - 4</b>	<b>Shift - Blue - Orange - 4</b>
~ (tilde)	<b>Shift - Blue - Orange - 5</b>	<b>Shift - Blue - Orange - 5</b>
< (less than sign)	<b>Shift - Blue - Orange - 6</b>	<b>Shift - Blue - Orange - 6</b>
> (greater than sign)	<b>Shift - Blue - Orange - 7</b>	<b>Shift - Blue - Orange - 7</b>
: (colon)	<b>Shift - Blue - Orange - 8</b>	<b>Shift - Blue - Orange - 8</b>
+ (plus sign)	<b>Shift - Blue - Orange - 9</b>	<b>Shift - Blue - Orange - 9</b>
_ (underscore)	<b>Shift - Blue - Orange - Tab</b>	<b>Shift - Blue - Orange - Tab</b>

## Display

The wearable terminal is factory installed with the Windows CE 5.0 operating system. When the wearable terminal starts, it automatically launches the Start Up application.

- ✓ **NOTE** A customer specific application can be configured to automatically start-up and the Windows CE 5.0 desktop and Start Up application might not be visible or accessible.

## Start Up Window

The **Start Up** window allows the user to launch specific applications by using the keypad. Either scroll up and down using the arrow keys and select **Enter** to select an item or press the numeric key associated with the item. If the **Start Up** window is closed, launch the **Start Up** window by selecting **OTL** on the desktop.



Figure 2-5 Start-up Window

Table 2-5 Start Up Item Descriptions

Item	Launch Number	Description
RD Client or Rapid Deployment Client	1	Launches the Rapid Deployment application. Refer to the <i>WT4070/90 Wearable Terminal Integrator Guide</i> for more information.
AirBEAM Client	2	Launches the AirBEAM Client application. Refer to the <i>WT4070/90 Wearable Terminal Integrator Guide</i> for more information.
Wavelink TelnetCE	3	Launches the Wavelink Client application.
Internet Explorer	4	Launches the Microsoft Pocket Internet Explorer application.
Utilities folder	5	Opens a sub-window that contains utilities, such as: Control Panel, File Explorer, BT HID Connect, BT Printer Connect and test applications. For more information on the Control Panel and File Explorer, refer to the <i>Symbol Application Guide for Symbol Devices</i> , p/n 72E-68901-xx.
Demo Apps	6	Opens a sub-window that contains sample demonstration applications.
Exit	7	Closes the Start Up window.

## Windows CE 5.0 Desktop

The following paragraphs describe the Windows CE 5.0 desktop. Depending upon the customer’s configuration of the wearable terminal, the desktop may not be available.

### Status Icons

The Taskbar at the bottom of the window displays the active programs, current time, battery status and communication status.

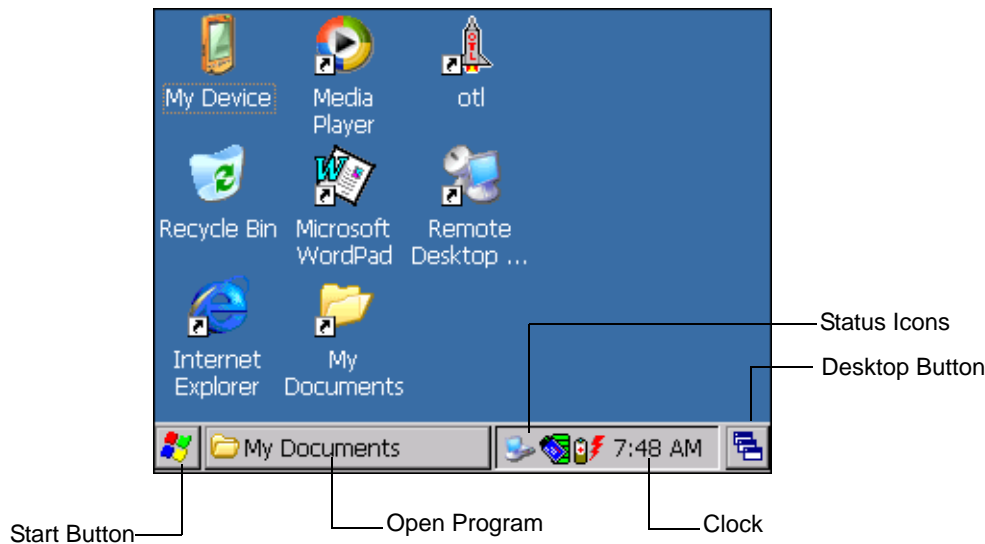









Figure 2-6 Taskbar

Status icons are shown in the taskbar to indicate present status of the wearable terminal.

Table 2-6 Status Icons

Status Icon	Description
	Indicates the current time. The clock can be toggled on and off. Select <b>Start &gt; Settings &gt; Control Panel &gt; Task and Start Menu</b> .
	This icon indicates that the main battery is charging or that the wearable terminal is operating on external power.
	Indicates that the battery is fully charged and the wearable terminal is running on external power.
	This icon is displayed when the memory backup battery level is low. Charge the battery.
	This icon indicates that the battery is fully charged (100% charged). The battery status icons provide the battery status in 10% increments from 10% to 100%.
	This displays when the terminal is connected to a host computer with ActiveSync.

**Table 2-6** *Status Icons (Continued)*

Status Icon	Description
	Wireless connection status icon. Indicates WLAN signal strength.
	Indicates that the <b>SHIFT</b> key is selected.
	Indicates that the Blue key is selected.
	Indicates that the <b>CTRL</b> key is selected.
	Indicates that the <b>ALT</b> key is selected.
	Indicates that the Orange key is selected.
	Indicates that the Gray key is selected.

## Using the Keypad to Navigate Applications

The wearable terminal does not have a touch screen and therefore navigation and control of an application is performed using the keypad.

### Key Combinations

The wearable terminal uses special key combinations to easily navigate applications. [Table 2-7](#) lists the key combinations required to perform various application navigation and control functions.

**Table 2-7** *Key Combinations*

Action Key	Combination
Access the Start menu on the taskbar	<b>CTRL - ESC</b>
Switch fields within an application	<b>TAB</b>
Close windows or cancel operations on some applications	<b>ESC</b> or <b>ALT - F4</b>
Access the Task Manager	<b>ALT - TAB</b>
Switches to the next window or desktop	<b>ALT - ESC</b>
Access a menu bar in an application	<b>ALT - ALT</b>
Press a button or select a check box in an application	<b>TAB</b> until the item is highlighted then <b>SPACE</b> .
Display a pop-up context menu	<b>ALT - ENTER</b>

Throughout this guide you will be instructed to select an item. You must use a key combination to select that item. For example:

To perform:

“Select **Start** > **Programs** > **Windows Explorer**”

1. Press **CTRL** and then **ESC** to open the **Start** menu.

2. Press the up arrow until the **Programs** item is highlighted.
3. Press the Blue key and the down arrow to open the **Programs** sub-menu.
4. Press the down arrow until **Windows Explorer** is highlighted.
5. Press **ENTER** key to launch **Windows Explorer**.

## Selecting Items

When using the navigation keys to perform tasks in an application, the active item is highlighted using either a color background and/or a dashed box.

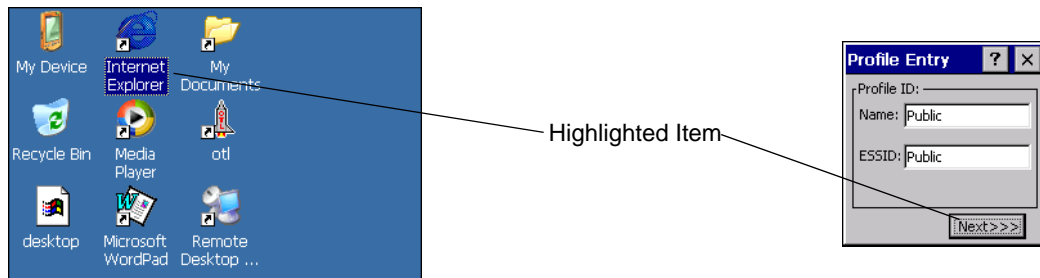

**Figure 2-7** *Highlighted Items*

## Navigating Menus

Most applications have drop-down menus to perform specific functions. Use the key combination **ALT - ALT** to open a menu. Once the menu is open, use the up and down navigation keys to move up and down the menu and use the left and right navigation keys to move to the next menu item or open a sub-menu. When moving through a menu, items are highlighted. Once an item is highlighted, press the **ENTER** key to select that item.

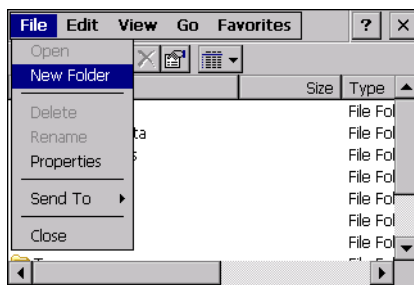

**Figure 2-8** *Navigating Menus*

## Navigating Tabs

Some applications contain multiple pages with tabs indicating each page. Use the **TAB** key to highlight the tab. A dashed box appears around the tab name. Use the left and right navigation keys to move to the next or previous tab.

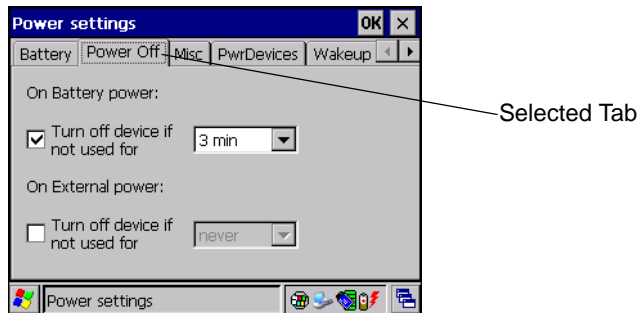

Figure 2-9 Navigating Tabs

## Navigating Fields

To navigate from one field to another, press the **TAB** key. Repeated pressing of the **TAB** key cycles the highlighted cursor through the fields in the window.

## Selecting Checkboxes and Radio Buttons

To select or deselect checkboxes and radio buttons press the **TAB** key until the field is highlighted. Press **ALT - BKSP** (**SPACE**) to select or deselect the checkbox or radio button.

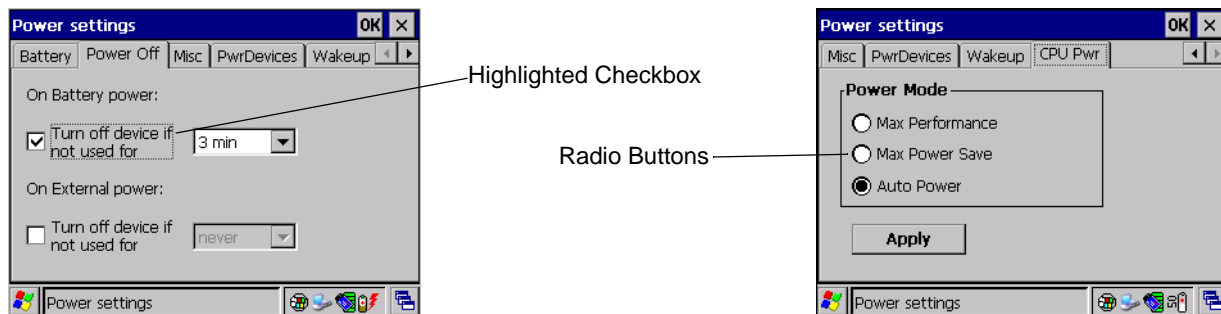

Figure 2-10 Selecting a Checkbox or Radio Button

## Selecting Items in a List

Use a combination of key sequences to select items in a folder or list.

To select continuous items in a folder or list:

1. Open the folder or list.
2. Use the scroll keys to move to the first item to select.
3. Press **SHIFT** - scroll key (either up or down) to select the next item.
4. Repeat the **SHIFT** - scroll key combination to select remaining items.
5. Perform the desired function.

To select multiple items in a folder or list:

1. Open the folder or list.
2. Use the scroll keys to move to the first item.
3. Press **CTRL** - scroll key to move within the list. The item name is outlined.

4. Repeat step 3 to move to the desired item.
5. Press **SPACE** to highlight the item.
6. Repeat steps 3 through 5 until all items are selected.
7. Perform the desired function.

---

## Resetting the Wearable Terminal

There are two types of resets, warm boot and cold boot. A warm boot restarts the wearable terminal by closing all running programs.

A cold boot also restarts the wearable terminal, but erases all stored records and entries in RAM. Data saved in flash memory or a memory card is not lost. In addition it returns formats, preferences and other settings to the factory default settings.

Perform a warm boot first. This restarts the wearable terminal and saves all *stored* records and entries. If the wearable terminal still does not respond, perform a cold boot.

### Performing a Warm Boot

Hold down the Power button for approximately five seconds. As soon as the wearable terminal starts to perform a warm boot release the Power button.

### Performing a Cold Boot

A cold boot restarts the wearable terminal and erases all user stored records and entries that are not saved in flash memory (Application and Platform folders). *Never perform a cold boot unless a warm boot does not solve the problem.*

✓ **NOTE** Any data previously synchronized with a computer can be restored during the next ActiveSync operation.

To perform a cold boot press and simultaneously hold the **1**, **9** and Power button. Do not hold down any other keys or buttons. The wearable terminal initializes.



---

## Data Capture

Wearable terminals used with an optional wearable laser scanner allow collection of data by scanning one dimensional bar codes.

### Laser Scanning

Wearable terminals with an optional wearable laser scanner have the following features:

- Reading of a variety of bar code symbologies, including the most popular linear, postal, and 1-D code types.
- Advanced intuitive laser aiming for easy point-and-shoot operation.

### Scanning Considerations

Typically, scanning is a simple matter of aim, scan/decode and a few quick trial efforts master it. However, two important considerations can be used to optimize any scanning performance:

- Range

Any scanning device decodes well over a particular working range — minimum and maximum distances from the bar code. This range varies according to bar code density and scanning device optics.

Scanning within range brings quick and constant decodes; scanning too close or too far away prevents decodes. Move the scanner closer and further away to find the right working range for the bar codes being scanned. However, the situation is complicated by the availability of various integrated scanning modules. The best way to specify the appropriate working range per bar code density is through a chart called a decode zone for each scan module. A decode zone simply plots working range as a function of minimum element widths of bar code symbols.

- Angle

Scanning angle is important for promoting quick decodes. When laser beams reflect directly back into the scanner from the bar code, this specular reflection can “blind” the scanner.

To avoid this, scan the bar code so that the beam does not bounce directly back. But don't scan at too sharp an angle; the scanner needs to collect scattered reflections from the scan to make a successful decode. Practice quickly shows what tolerances to work within.

✓ **NOTE** Contact the Symbol Support Center if chronic scanning difficulties develop. Decoding of properly printed bar codes should be quick and effortless.

### Scanning Bar Codes

1. Ensure that a scan enabled application is loaded on the wearable terminal.
2. Aim the scan exit window at the bar code.
3. Press the trigger.
  - Ensure the red scan beam covers the entire bar code. The red scan LED lights to indicate that the laser is on. The green scan LED lights. An audible beep might sound, if the application determines, to indicate the bar code was decoded successfully.



**Figure 2-11** Laser Scanner Aiming Pattern

4. Release the trigger.

### Scanning Tips

Optimal scanning distance varies with bar code density and scanner optics.

- Hold the scanner farther away for larger symbols.
- Move the scanner closer for symbols with bars that are close together.

✓ **NOTE** Scanning procedures depend on the application and wearable terminal configuration. An application may use different scanning procedures from the one listed above.

### Scan LED Indicator

The LED on the scanner provides a visual indication of the scan status.

**Table 2-8** Scan LED Indicators

LED Status	Indication
Off	Not scanning.
Solid Red	Laser enabled, scanning in process.
Solid Green	Successful decode.

## Waking the Wearable Terminal

The wake up conditions define what actions wake up the wearable terminal after it has gone into suspend mode. The wearable terminal can go into suspend mode by either pressing the Power button or automatically by control panel time-out settings. These settings are configurable and the factory default settings are shown in [Table 2-9](#).

**Table 2-9** *Wakeup Default Settings*

Condition for Wakeup	Power Button	Automatic Time-out
AC power is applied.	No	Yes
Wearable terminal is inserted into a cradle.	No	Yes
Wearable terminal is removed from a cradle.	No	Yes
Wearable terminal is connected to a serial device.	No	Yes
Wearable terminal is connected to a USB device.	No	Yes
Wearable terminal is disconnected from a USB device.	No	Yes
A key is pressed.	No	Yes
An attached scanner is triggered.	No	Yes
Wireless LAN activity is detected.	No	No
A headset is connected to the wearable terminal.	No	Yes

✓ **NOTE** If the battery is removed and replaced, the only way to wake up the terminal is by pressing the Power button.



# Chapter 3 Accessories

---

## Introduction

The wearable terminal accessories provide a variety of product support capabilities. Accessories include cradles, cables and scanners.

### Cradles

- Single Slot USB cradle charges the wearable terminal main battery and a spare battery. It also synchronizes the wearable terminal with a host computer through either a serial or a USB connection.
- Four Slot Ethernet cradle charges up to four wearable terminal batteries and synchronizes the wearable terminals with a host computer through an Ethernet connection.
- Four Slot Spare Battery Charger charges up to four wearable terminal spare batteries.

### Scanners

- RS309 scanner
- RS409 scanner.

### Accessories

- Headset
- Headset adapter
- Wrist Mount
- Hip Mount.

## Single Slot USB Cradle



**CAUTION** Ensure that you follow the guidelines for battery safety described in [Battery Safety Guidelines on page 4-2](#).

This section describes how to use a Single Slot USB cradle ([Figure 3-1](#)) with the wearable terminal. For USB communication setup procedures refer to the *WT4090 Integrator Guide*.

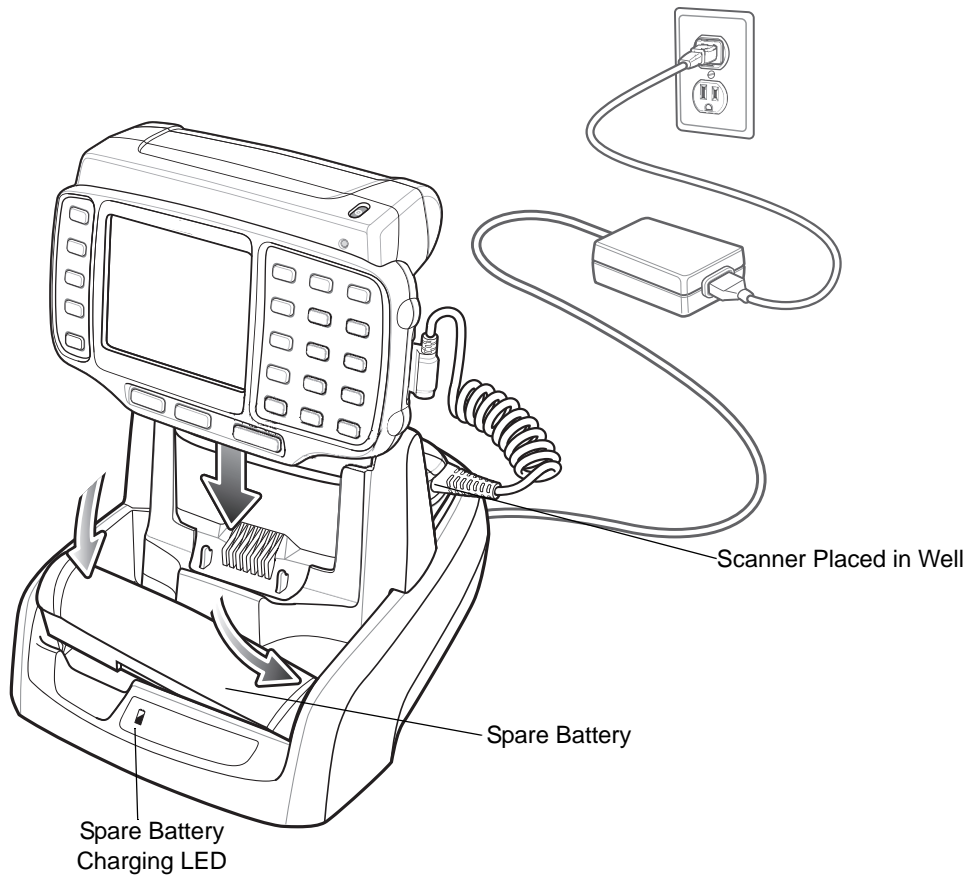

**Figure 3-1** Single Slot USB Cradle



**CAUTION** Use only a Symbol approved power supply output rated 12 VDC and minimum 3.3 A. Use of an alternative power supply will void the product warranty and may cause product damage. See [Appendix B, Regulatory Information](#) for the power supply regulatory compliance statement.

The Single Slot USB Cradle:

- Provides 5.4 VDC power for operating the wearable terminal.
- Provides USB port for data communication between the wearable terminal and a host computer or other serial devices (e.g., a printer).



**NOTE** The normal function of the product may be disturbed by Strong Electro Magnetic Interference (for example, static electricity). If so, simply remove and re-insert the terminal to resume normal operation. In case the function does not resume, please use the product in another location.

- Synchronizes information between the wearable terminal and a host computer. (With customized or third party software, it can also be used to synchronize the wearable terminal with corporate databases.)
- Charges the wearable terminal's battery and a spare battery.
- Provides a location for storing a scanner when a wearable terminal is docked in the cradle.

## Battery Charging Indicators

The Single Slot USB cradle can charge the wearable terminal's main battery and a spare battery simultaneously.

The wearable terminal's amber Charge Status LED indicates the status of the battery charging in the wearable terminal. See [Table 1-3 on page 1-6](#) for charging status indications.

The amber Spare Battery Charging LED on the cradle (see [Figure 3-1 on page 3-2](#)) indicates the status of the spare battery charging in the cradle. See [Table 3-1](#) for charging status indications. The standard capacity battery fully charges in less than four hours.

**Table 3-1** Spare Battery LED Charging Indicators

Spare Battery LED (on cradle)	Indication
Off	No spare battery in well; spare battery not placed correctly; cradle is not powered.
Fast Blinking Amber	Charging error: <ul style="list-style-type: none"> <li>• Temperature is too low or too high.</li> <li>• Charging has gone on too long without completing (typically eight hours).</li> </ul>
Slow Blinking Amber	Spare battery is charging.
Solid Amber	Charging complete.

## Four Slot Ethernet Cradle



**CAUTION** Ensure that you follow the guidelines for battery safety described in [Battery Safety Guidelines on page 4-2](#).

This section describes how to use a Four Slot Ethernet cradle ([Figure 3-2](#)) with the wearable terminal. For Ethernet communication setup procedures refer to the *WT4090 Integrator Guide*.

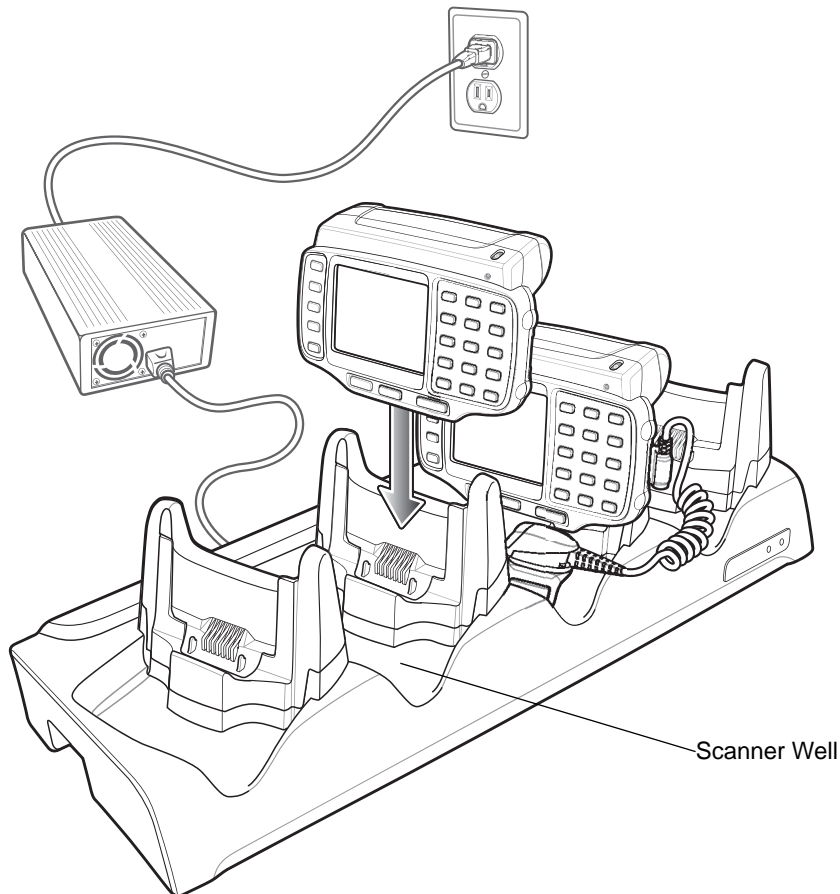

**Figure 3-2** *Four Slot Ethernet Cradle*

The Four Slot Ethernet cradle:

- Connects up to four wearable terminals to an Ethernet network.
- Provide 5.4 VDC power for operating the wearable terminal and charging the battery.
- Simultaneously charges up to four wearable terminals (with batteries installed).

You cannot ActiveSync using the Four Slot Ethernet cradle. To ActiveSync with a host computer use the Single Slot USB cradle.



**CAUTION** Use only a Symbol approved power supply output rated 12 VDC and minimum 9 A. Use of an alternative power supply will void the product warranty and may cause product damage. See [Appendix B, Regulatory Information](#) for the power supply regulatory compliance statement.



## Battery Charging

The four slot Ethernet cradle can charge up to four wearable terminals simultaneously. To charge the wearable terminal:

1. Slide the wearable terminal into the wearable terminal slot.
2. The wearable terminal amber Charge Status LED indicates the wearable terminal battery charging status. The Standard Battery usually charges in less than four hours. See [Table 3-1](#) for charging status indications.
3. When charging is complete, remove the wearable terminal from the cradle.

## LED Charge Indications

The Four Slot Ethernet cradle uses the wearable terminal amber Power LED to indicate the battery charging status. See [Table 3-1 on page 3-3](#) for charging status indications.

## Speed LED

The green Speed LED lights to indicate that the transfer rate is 100 Mbps. When it is not lit it indicates that the transfer rate is 10 Mbps.

## Link LED

The yellow Link LED blinks to indicate activity, or stays lit to indicate that a link is established. When it is not lit, it indicates that there is no link.

## Battery Charging Indicators

The wearable terminal's amber charge LED indicates the status of the battery charging in the wearable terminal. See [Table 1-3 on page 1-6](#) for charging status indications.

The standard capacity battery fully charges in less than four hours.

## Four Slot Spare Battery Charger



**CAUTION** Ensure that you follow the guidelines for battery safety described in [Battery Safety Guidelines on page 4-2](#).

This section describes how to use the Four Slot Spare Battery Charger to charge up to four wearable terminal spare batteries.

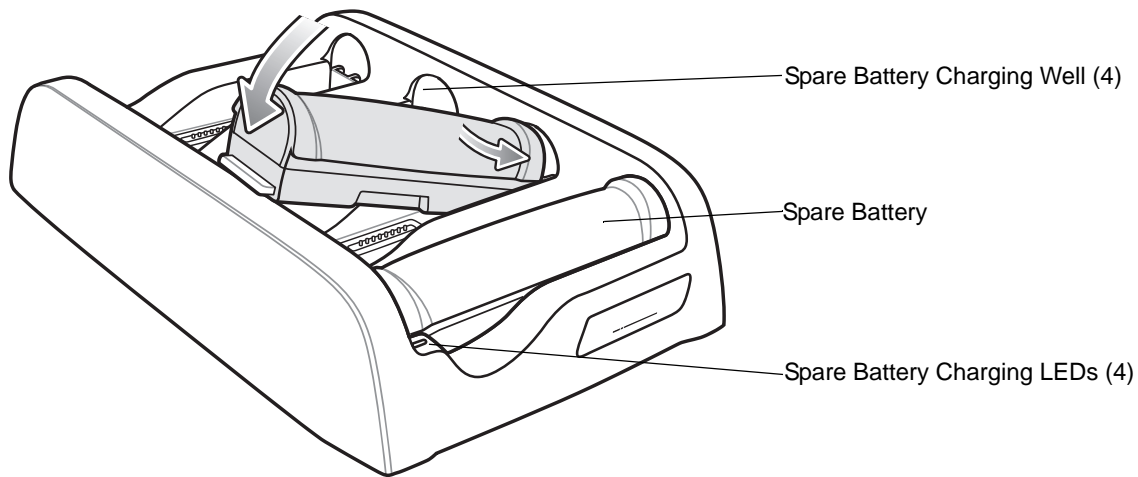

**Figure 3-3** Four Slot Spare Battery Charger



**CAUTION** Use only a Symbol approved power supply output rated 12 VDC and minimum 3.3 A. Use of an alternative power supply will void the product warranty and may cause product damage. See [Appendix B, Regulatory Information](#) for the power supply regulatory compliance statement.

## Spare Battery Charging with the Four Slot Spare Battery Charger

Insert the battery into a spare battery charging slot and gently press down on the battery to ensure proper contact.

## Battery Charging Indicators

An amber LED is provided on each battery charging well. See [Table 3-2](#) for charging status indications. The standard capacity battery usually charges in less than four hours.

**Table 3-2** Spare Battery LED Charging Indicators

LED	Indication
Off	No spare battery in slot; spare battery not placed correctly; cradle is not powered.
Fast Blinking Amber	Charging error: <ul style="list-style-type: none"> <li>• Temperature is too low or too high.</li> <li>• Charging has gone on too long without completing (typically eight hours).</li> </ul>
Slow Blinking Amber	Spare battery is charging.
Solid Amber	Charging complete.

## RS409 Scanner

To connect the RS409 scanner to the wearable terminal:

- ✓ **NOTE** There are two RS409 configurations available. The short cable configuration connects the RS409 to the wearable terminal mounted on the arm. The extended cable configuration connects the RS409 to the WT4090 mounted on the hip.

1. Remove the rubber plug from the wearable terminal interface connector.
2. Connect the RS409 interface cable to the wearable terminal interface connector. If the wearable terminal is mounted on the arm, connect the cable to the interface connector closest to the wrist.

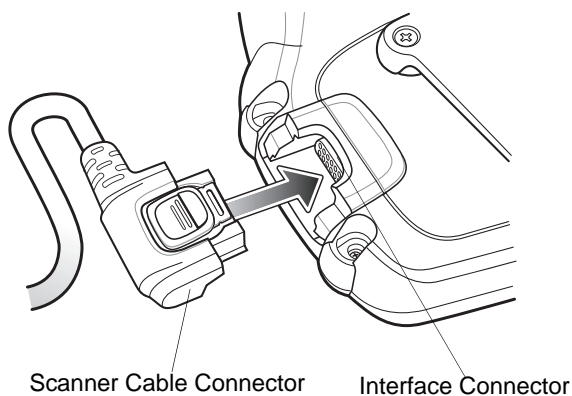

**Figure 3-4** Connecting RS409 to Wearable Terminal

3. If using the extended cable configuration, route the scanner cable up to the shoulder and down to the hand that the scanner mounts on. Attach two cable clips to clothing and secure cable to cable clip.

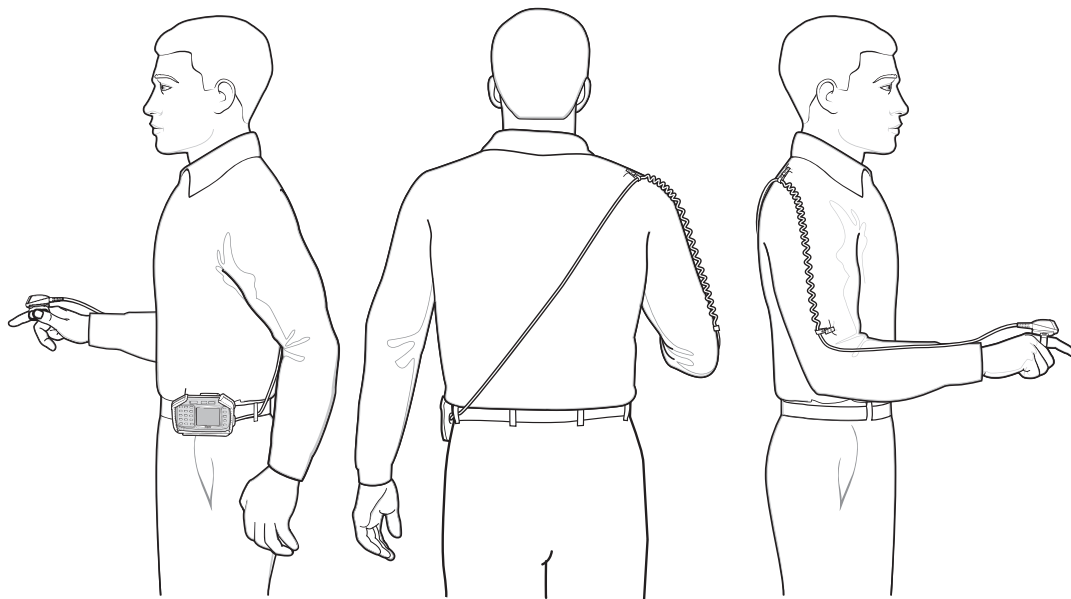

**Figure 3-5** Cable Clip Installation

4. Rotate the trigger assembly to the correct position for the hand that the scanner mounts to.

5. Slide the RS409 onto the index finger with the scan trigger next to the thumb.

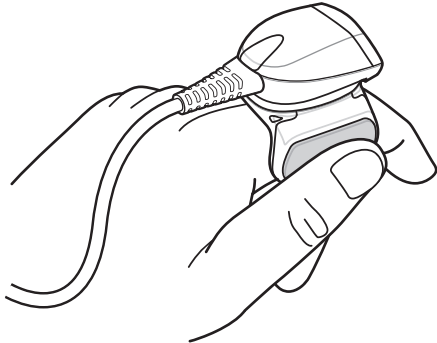

**Figure 3-6** *Place the RS409 on Index Finger*

6. Tighten the finger strap.

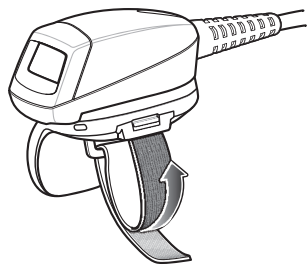

**Figure 3-7** *Tightening Straps*

7. If required, cut excess finger strap material.

After connecting the scanner, warm boot the wearable terminal. See [Resetting the Wearable Terminal on page 2-14](#) for information on performing a warm boot.

## RS309 Scanner

The RS309 connects to the wearable terminal and mounts on the back of either hand using the RS309 glove.

1. Remove the rubber plug from the wearable terminal interface connector.
2. Connect the RS309 trigger cable to the back of the RS309.

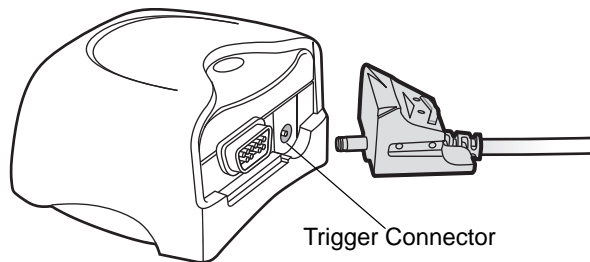

**Figure 3-8** Connecting Trigger Cable to RS309

- ✓ **NOTE** There are two interface cables available. The standard interface cable connects the RS309 to the wearable terminal mounted on the arm. The extended length interface cable connect the RS309 to the wearable terminal mounted on the hip.

3. Connect the end of the RS309 interface cable to the wearable terminal interface connector. If the wearable terminal is mounted on the arm, connect the cable to the interface connector closest to the wrist.
4. If using the extended length interface cable, route the interface cable up to the shoulder and down to the hand that the scanner mounts on. Attach two cable clips to clothing and secure cable to cable clip.

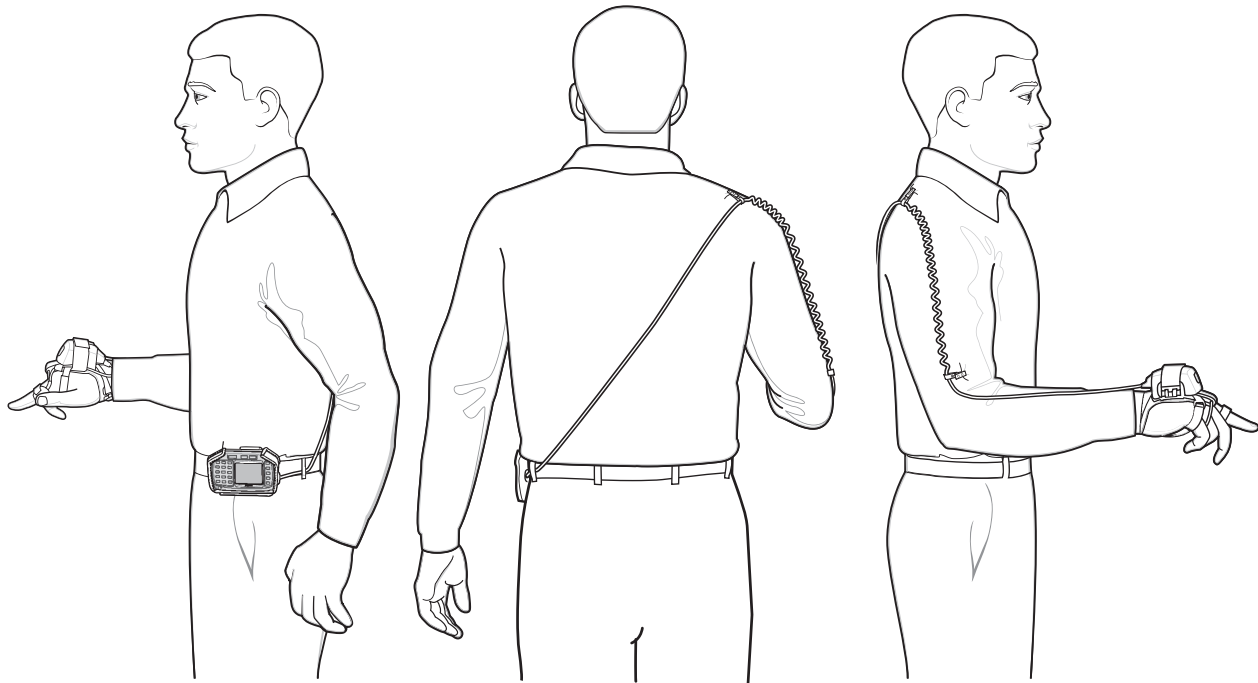

**Figure 3-9** Cable Clip Installation

5. Connect the RS309 interface cable to the back of the RS309.

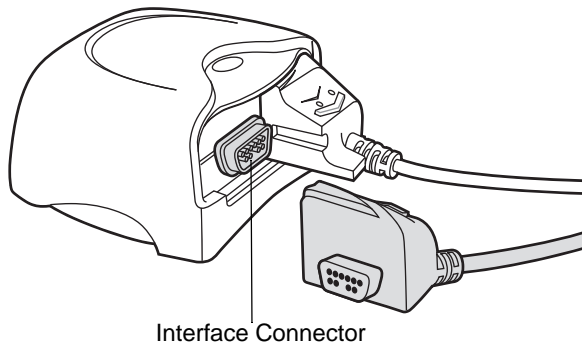

**Figure 3-10** *Connecting Interface Cable to RS309*

6. Mount the RS309 on the RS309 glove. Refer to the RS309 Glove Installation Guide for information on mounting the RS309.
7. Route the trigger cable around the side of the RS309, next to the index finger.
8. Slide the trigger mount on the index finger, with the button positioned next to the thumb, and adjust the velcro strap.

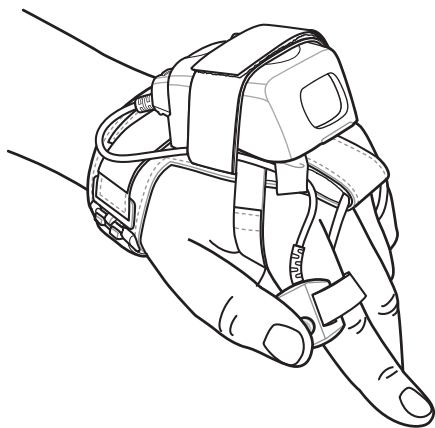

**Figure 3-11** *RS309 on Back of Hand*

After connecting the scanner, warm boot the wearable terminal. See [Resetting the Wearable Terminal on page 2-14](#) for information on performing a warm boot.

---

## Hip Mount

The hip mount allows the user to mount the wearable terminal on the hip for use in voice picking applications. An RS309 or RS409 scanner with an extended cable is required when using the hip mount.

Slide the wearable terminal into the hip mount.

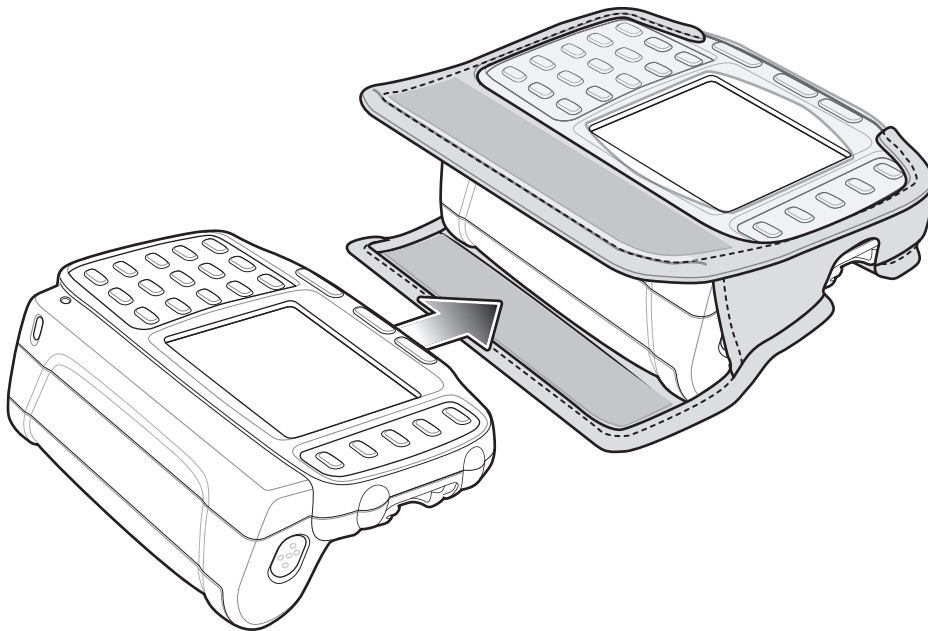

**Figure 3-12** *Insert Wearable Terminal into Hip Mount*

Close the front flap followed by the back flap.

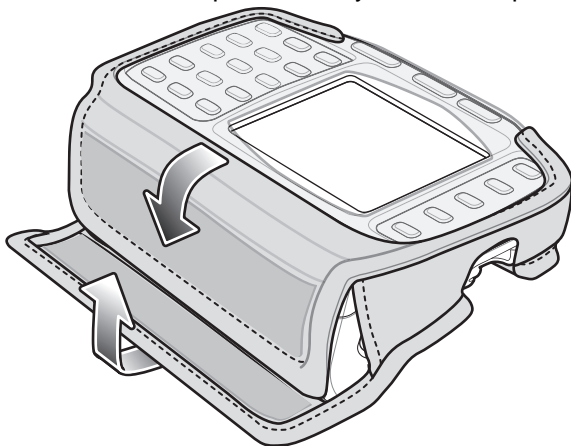

**Figure 3-13** *Close Hip Mount Flaps*

Slide a belt through the belt loop on the back of the hip mount. The wearable terminal can be mounted right-side up or up-side down depending upon user preference or application.

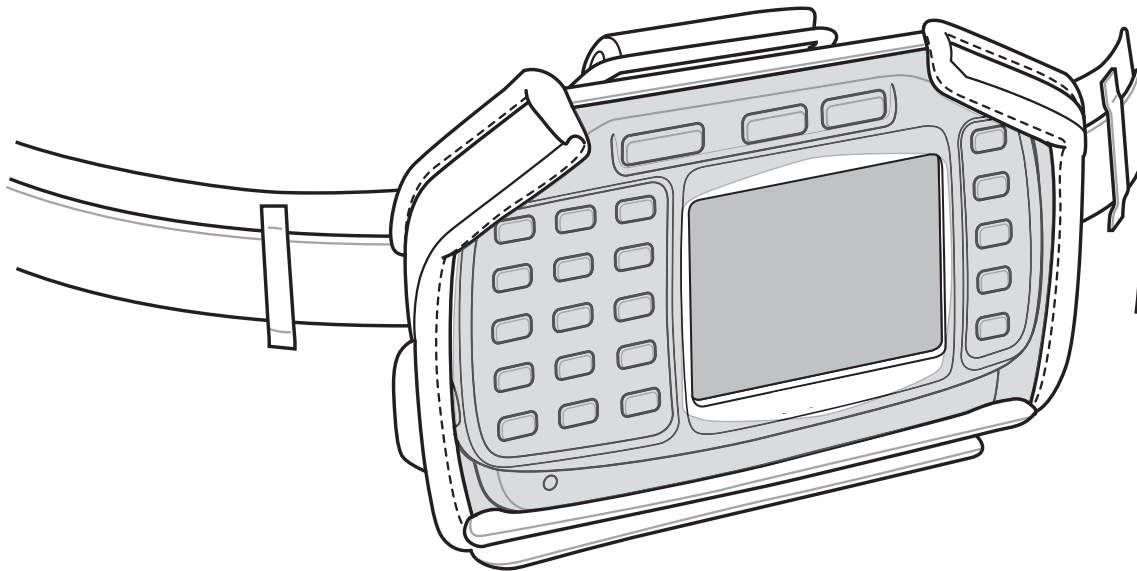

**Figure 3-14** *Hip Mount on Belt*

Connect accessories as required.

### **Routing an Extended Cable Scanner**

When using an RS309 or RS409 scanner with the wearable terminal mounted on the hip, the extended cable version is required.

Motorola offers for sale cable clips, which attach to clothing and hold the scanner cable so that the cable does not interfere with the user. The cable clips are similar to badge clips and can be purchased at any office supply store as well.

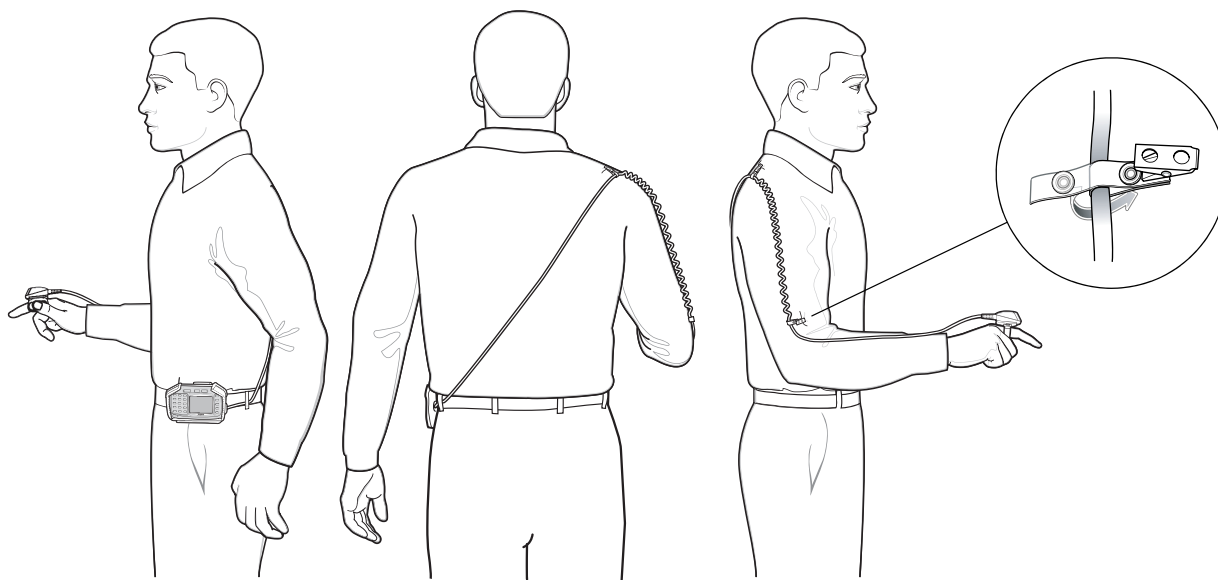

**Figure 3-15** *Routing RS409 Scanner Cable from Hip to Hand*



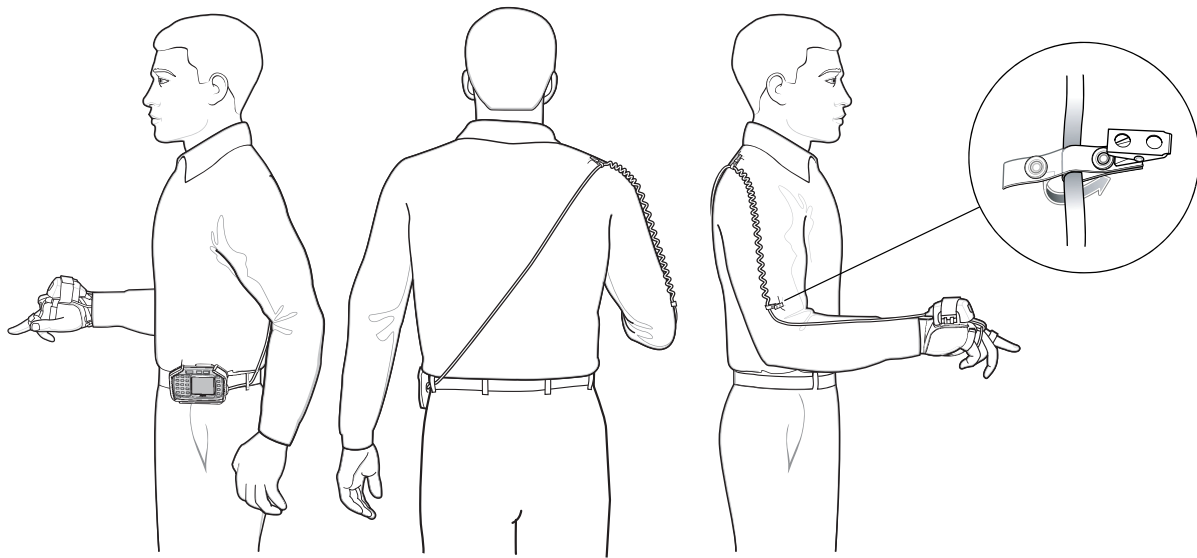

**Figure 3-16** *Routing RS309 Scanner Cable from Hip to Hand*

---

## Freezer Pouch

The freezer pouch allows the user to use the wearable terminal in a freezer environment on the hip or wrist for use in voice picking applications. An RS309 or RS409 scanner with an extended cable is required when mounting the freezer pouch on the hip mount, if scanning is also part of the application.

In order to keep the wearable terminal at a safe operating temperature in a meat or ice cream freezer, the freezer pouch insulates the wearable terminal to keep the heat generated by the wearable terminal within the pouch. The pouch is not heated. There are no batteries to worry about or electronics within the pouch.

The freezer pouch can be either hip-mounted or wrist-mounted. For hip-mounting, there is a belt loop on its back for attached a belt (sold separately). For wrist-mounting, customers can buy either a set of standard-length or longer-length wrist straps and use them with the pouch. The longer-length wrist straps are recommended for wrist-mounting over coats. The freezer pouch has openings on each side for wearable scanners and headset adapters.

While the freezer pouch is designed to allow workers to use the wearable terminal in meat and ice cream freezers, there are some very important limitations to follow:

- Do not use in environments that are below -30°C (-22°F).
- Do not allow the wearable terminal (with or without the freezer pouch) to remain in the suspend mode in environments below -20°C (-4°F) for more than 10 minutes. This prevents the wearable terminal from cooling down to the ambient freezer temperature. The pouch maintains the wearable terminal at a sufficient temperature while it is in use, but lengthy periods of inactivity brings the wearable terminal below its operating temperature.
- Do not store wearable terminals in the meat or ice cream freezer. As explained above, this would allow the wearable terminals to chill to the ambient freezer temperature, which is below their operating temperature. Furthermore, if batteries were left in wearable terminals stored in the freezer, the batteries themselves could freeze, which could damage them. At the least, they would not function while frozen.
- Batteries cannot be charged below 0°C (32°F). Motorola cradles and battery chargers have an automatic shut-off to insure this.
- If using wearable scanners with the wearable terminal in the meat or ice cream freezer for a shift, remember that the RS309 freezer configuration is the correct scanner to choose, due to its lower operating temperature range and its desiccant pack to remove condensation.

Slide the wearable terminal into the freezer pouch.

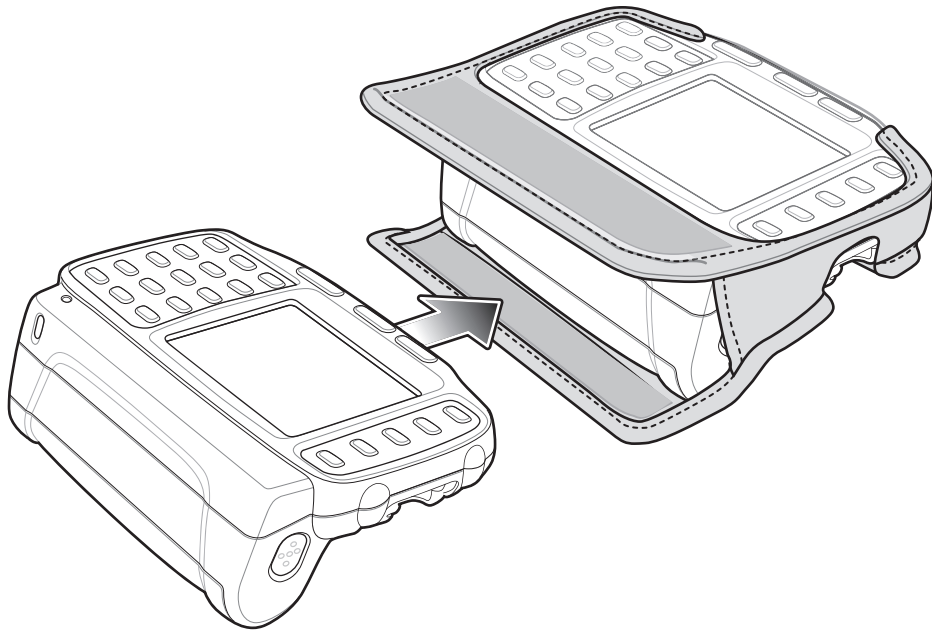

**Figure 3-17** *Insert Wearable Terminal into Freezer Pouch*

Close the front flap followed by the back flap.

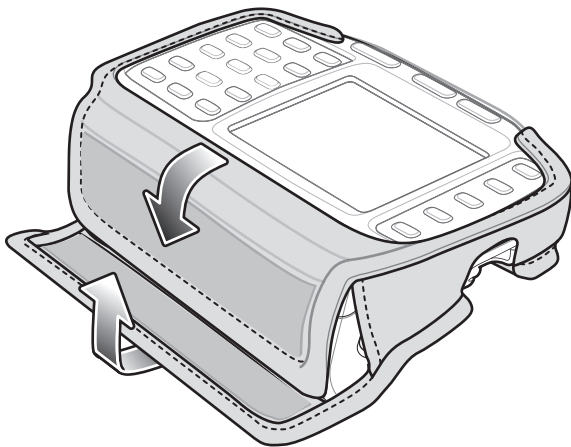

**Figure 3-18** *Close Freezer Pouch Flaps*

Slide a belt through the belt loop on the back of the freezer pouch. The wearable terminal can be mounted right-side up or up-side down depending upon user preference or application.

---

## Wired Headset

You can use a mono headset with a microphone for audio communication with an audio enabled application. The Headset Adapter is required to connect a headset with a standard 2.5 mm jack to the wearable terminal.

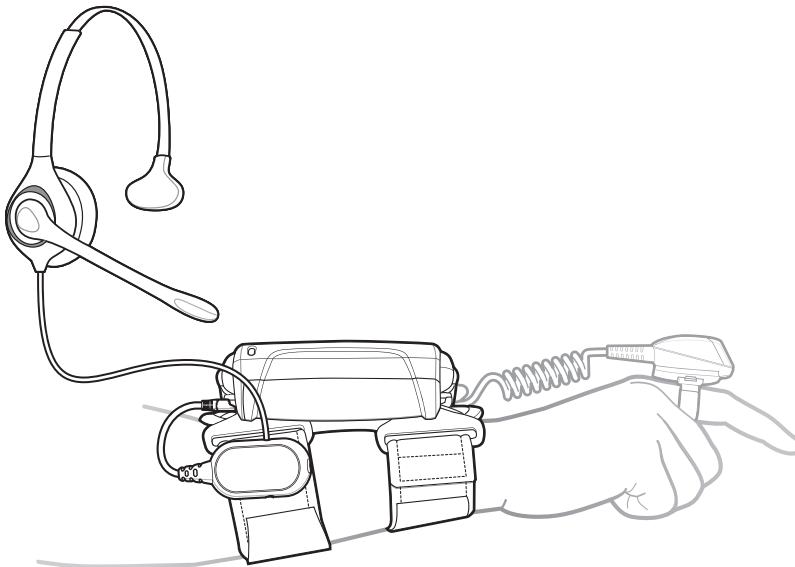

**Figure 3-19** *Typical Headset Connected to Headset Adapter*

Refer to the *WT4070/90 Integrator Guide* for instructions on assembling the headset and Headset Adapter.

The Headset Adapter has a clip for mounting onto the wrist mount or belt.

# Chapter 4 Maintenance & Troubleshooting

---

## Introduction

This chapter includes instructions on cleaning and storing the wearable terminal, and provides troubleshooting solutions for potential problems during wearable terminal operation.

---

## Maintaining the Wearable Terminal

For trouble-free service, observe the following tips when using the wearable terminal:

- Protect the wearable terminal from temperature extremes.
- Do not store or use the wearable terminal in any location that is extremely dusty, damp, or wet.
- Use a soft lens cloth to clean the wearable terminal. If the surface of the wearable terminal screen becomes soiled, clean it with a soft cloth moistened with a diluted window-cleaning solution.
- Periodically replace the rechargeable Li-ion battery to ensure maximum battery life and product performance. Battery life depends on individual usage patterns.
- Take care not to scratch the screen of the wearable terminal.
- The screen of the wearable terminal contains glass. Take care not to drop the wearable terminal or subject it to strong impact.
- Regularly replace all Velcro<sup>®</sup> straps on the wrist mount and wearable scanners, to ensure adequate adhesion of the Velcro.

## Wrist Mount Cleaning Instructions

It may be necessary to wash the wrist mount straps and replaceable pad when they become soiled.

Remove the straps and pad from the wrist mount. Hand wash in cold water with a mild detergent (such as Woolite<sup>®</sup>). Do not use bleach. Air dry. Do not use a dryer.

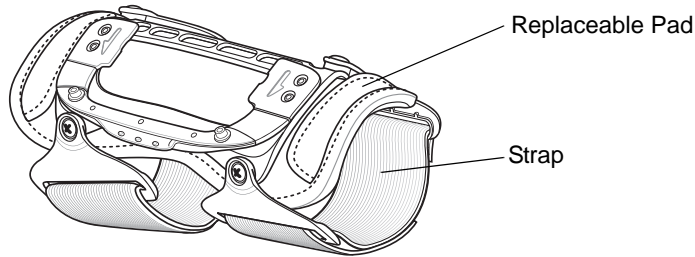

**Figure 4-1** *Wrist Mount Soft Goods*

---

## Battery Safety Guidelines

- The area in which the units are charged should be clear of debris and combustible materials or chemicals. Particular care should be taken where the device is charged in a non commercial environment.
- Improper battery use may result in a fire, explosion, or other hazard.
- To charge the mobile device battery, the battery and charger temperatures must be between 0 °C and +40 °C (+32 °F and +104 °F).
- Do not use incompatible batteries and chargers. Use of an incompatible battery or charger may present a risk of fire, explosion, leakage, or other hazard. If you have any questions about the compatibility of a battery or a charger, contact Motorola Enterprise Mobility support.
- Do not disassemble or open, crush, bend or deform, puncture, or shred.
- Severe impact from dropping any battery-operated device on a hard surface could cause the battery to overheat.
- Do not short circuit a battery or allow metallic or conductive objects to contact the battery terminals.
- Do not modify or remanufacture, attempt to insert foreign objects into the battery, immerse or expose to water or other liquids, or expose to fire, explosion, or other hazard.
- Do not leave or store the equipment in or near areas that might get very hot, such as in a parked vehicle or near a radiator or other heat source. Do not place battery into a microwave oven or dryer.
- Battery usage by children should be supervised.
- Please follow local regulations to promptly dispose of used re-chargeable batteries.
- Do not dispose of batteries in fire.
- Seek medical advice immediately if a battery has been swallowed.
- In the event of a battery leak, do not allow the liquid to come in contact with the skin or eyes. If contact has been made, wash the affected area with large amounts of water and seek medical advice.
- If you suspect damage to your equipment or battery, contact Motorola Enterprise Mobility support to arrange for inspection.

## Troubleshooting

### Wearable Terminal

**Table 4-1** *Troubleshooting the Wearable Terminal*

Problem	Cause	Solution
Wearable terminal does not turn on.	Lithium-ion battery not charged.	Charge or replace the lithium-ion battery in the wearable terminal.
	Lithium-ion battery not installed properly.	Ensure battery is installed properly. See <a href="#">Installing and Removing the Main Battery on page 1-5</a> .
	System crash.	Perform a warm boot. If the wearable terminal still does not turn on, perform a cold boot. See <a href="#">Resetting the Wearable Terminal on page 2-14</a> .
Rechargeable lithium-ion battery did not charge.	Battery failed.	Replace battery. If the wearable terminal still does not operate, try a warm boot, then a cold boot. See <a href="#">Resetting the Wearable Terminal on page 2-14</a> .
	Wearable terminal removed from cradle while battery was charging.	Insert wearable terminal in cradle and begin charging. The lithium-ion battery requires less than four hours to recharge fully.
	Ambient temperature of the cradle is too warm or too cold.	Move the cradle to an area where the ambient temperature is between 0 °C and 40 °C (32 °F and 104 °F).
Cannot see characters on display.	Wearable terminal not powered on.	Press the Power button.
During data communication, no data was transmitted, or transmitted data was incomplete.	Wearable terminal removed from cradle or unplugged from host computer during communication.	Replace the wearable terminal in the cradle, or reattach the Synchronization cable and re-transmit.
	Incorrect cable configuration.	See the System Administrator.
	Communication software was incorrectly installed or configured.	Perform setup. Refer to the <i>WT4090 Integrator Guide</i> for details. Ensure that Microsoft ActiveSync 4.1 or greater is installed on the host computer.
No sound is audible.	Volume setting is low or turned off.	Adjust volume. Change volume settings by selecting <b>Start &gt; Settings &gt; Control Panel &gt; Volume &amp; Sounds</b> icon > <b>Volume</b> tab. Move the slider to change the volume level.

**Table 4-1** *Troubleshooting the Wearable Terminal (Continued)*

<b>Problem</b>	<b>Cause</b>	<b>Solution</b>
Wearable terminal turns itself off.	Wearable terminal is inactive.	The wearable terminal turns off after a period of inactivity. If the wearable terminal is running on battery power, this period can be set to 30 sec., 1, 2, 3, 4, 5 or 6 minutes. If the wearable terminal is running on external power, this period can be set to 1, 2, 3, 5, 10, 15 and 30 minutes. Check the power settings by selecting <b>Start &gt; Settings &gt; Control Panel &gt; Power icon &gt; Power Off</b> tab. Change the setting if you need a longer delay before the automatic shutoff feature activates.
	Battery is depleted.	Replace the battery.
	Battery is not inserted properly.	Insert the battery properly (see <a href="#">Installing and Removing the Main Battery on page 1-5</a> ).
	The wearable terminal's battery is low and it powers down to protect memory content.	Recharge the battery.
A message appears stating that the wearable terminal memory is full.	Too many files stored on the wearable terminal.	Delete unused memos and records. You can save these records on the host computer.
	Too many applications installed on the wearable terminal.	If you have installed additional applications on the wearable terminal, remove them to recover memory. Select <b>Start &gt; Settings &gt; Control Panel &gt; Remove Programs</b> icon. Select the unused program and select <b>Remove</b> .



**Table 4-1** *Troubleshooting the Wearable Terminal (Continued)*

Problem	Cause	Solution
The wearable terminal does not accept scan input.	Scanning application is not loaded.	Verify that the unit is loaded with a scanning application. See the System Administrator.
	Unreadable bar code.	Ensure the symbol is not defaced.
	Distance between exit window and bar code is incorrect.	Ensure wearable terminal is within proper scanning range.
	Wearable terminal is not programmed for the bar code.	Ensure the wearable terminal is programmed to accept the type of bar code being scanned.
	Wearable terminal is not programmed to generate a beep.	If a beep on a good decode is expected and a beep is not heard, check that the application is set to generate a beep on good decode.
	Battery is low.	If the scanner stops emitting a laser beam when the trigger is pressed, check the battery level. When the battery is low, the scanner shuts off before the wearable terminal low battery condition notification. <b>Note:</b> If the scanner is still not reading symbols, contact the distributor or Motorola.
Wearable terminal goes into IPL mode after cold boot.	Headset adapter without a headset is connected to the wearable terminal during a cold boot.	Disconnect the headset adapter prior to performing a cold boot.
	Scanner trigger is held down during a cold boot.	Do not press trigger during a cold boot.
	P1 or P2 key is held down during a cold boot.	Do not press the P1 or P2 key during a cold boot.
WLAN connection is lost when the wearable terminal is connected to a host computer using ActiveSync.	Microsoft security feature prevents connection to two separate networks.	Disconnect from the WLAN network prior to connecting to a host computer using ActiveSync.

## Four Slot Ethernet Cradle

**Table 4-2** Troubleshooting the Four Slot Ethernet Cradle

Problem	Cause	Solution
Wearable terminal amber Charge Status LED does not light when wearable terminal inserted.	Cradle is not receiving power.	Ensure the power cable is connected securely to both the cradle and to AC power.
	Wearable terminal is not correctly seated.	Remove and re-insert the wearable terminal into the cradle, ensuring it is correctly seated.
Wearable terminal battery is not charging.	Wearable terminal was removed from cradle or cradle was unplugged from AC power too soon.	Ensure cradle is receiving power. Ensure the wearable terminal is seated correctly. If the wearable terminal battery is fully depleted, it can take up to four hours to fully recharge a Standard Battery and it can take up to six hours to fully recharge an Extended Life Battery.
	Battery is faulty.	Verify that other batteries charge properly. If so, replace the faulty battery.
	The wearable terminal is not fully seated in the cradle.	Remove and re-insert the wearable terminal into the cradle, ensuring it is correctly seated.
During data communication, no data was transmitted, or transmitted data was incomplete.	Wearable terminal removed from cradle during communication.	Replace wearable terminal in cradle and retransmit.
	Incorrect cable configuration.	See the system administrator or refer to the <i>WT4090 Integrator Guide</i> .
	Ethernet connection error. Link LED is not lit (see <a href="#">Link LED on page 3-5</a> ).	See the system administrator. Probable Ethernet connection error.
Wearable terminal's main batteries not charging.	Ambient temperature of the cradle is too warm or too cold.	Move the cradle to an area where the ambient temperature is between 0 °C and 40 °C (32 °F and 104 °F).

## Four Slot Spare Battery Charger

**Table 4-3** *Troubleshooting The Four Slot Spare Battery Charger*

Symptom	Possible Cause	Solution
Batteries not charging.	Battery was removed from the charger or charger was unplugged from AC power too soon.	Re-insert the battery in the charger or re-connect the charger's power supply.
	Battery is faulty.	Verify that other batteries charge properly. If so, replace the faulty battery.
	Battery contacts not connected to charger.	Verify that the battery is oriented properly and firmly seated in the battery well correctly with the contacts facing down. See <a href="#">Figure 3-3 on page 3-6</a> for proper battery orientation.
	Ambient temperature of the charger is too warm or too cold.	Move the charger to an area where the ambient temperature is between 0 °C and 40 °C (32 °F and 104 °F).

## Single Slot USB Cradle

**Table 4-4** Troubleshooting the Single Slot USB Cradle

Symptom	Possible Cause	Solution
Charge Status LEDs do not light when wearable terminal or spare battery is inserted.	Cradle is not receiving power.	Ensure the power cable is connected securely to both the cradle and to AC power.
	Wearable terminal is not seated firmly in the cradle.	Remove and re-insert the wearable terminal into the cradle, ensuring it is firmly seated.
	Spare battery is not seated firmly in the cradle.	Remove and re-insert the spare battery into the charging slot, ensuring it is firmly seated.
Wearable terminal battery is not charging.	Wearable terminal was removed from cradle or cradle was unplugged from AC power too soon.	Ensure cradle is receiving power. Ensure wearable terminal is seated correctly. Confirm main battery is charging. If a wearable terminal battery is fully depleted, it can take up to four hours to fully recharge a battery (if the wearable terminal is off, and longer if the wearable terminal is operating). View battery status by selecting <b>Start &gt; Settings &gt; Control Panel &gt; Power</b> icon.
	Battery is faulty.	Verify that other batteries charge properly. If so, replace the faulty battery.
	The wearable terminal is not fully seated in the cradle.	Remove and re-insert the wearable terminal into the cradle, ensuring it is firmly seated.
	Ambient temperature of the cradle is too warm or too cold.	Move the cradle to an area where the ambient temperature is between 0°C and 40°C (32°F and 104°F).
Spare battery is not charging.	Battery inserted incorrectly.	Verify that the battery is oriented properly and firmly seated in the battery well correctly with the contacts facing down. See <a href="#">Figure 3-3 on page 3-6</a> for proper battery orientation.
	Battery is faulty.	Verify that other batteries charge properly. If so, replace the faulty battery.
	Ambient temperature of the cradle is too warm or too cold.	Move the cradle to an area where the ambient temperature is between 0 °C and 40 °C (32 °F and 104 °F).

**Table 4-4** Troubleshooting the Single Slot USB Cradle (Continued)

Symptom	Possible Cause	Solution
During data communications, no data was transmitted, or transmitted data was incomplete.	Wearable terminal removed from cradle during communications.	Replace wearable terminal in cradle and retransmit.
	Incorrect cable configuration.	See the System Administrator.
	Communications software is not installed or configured properly.	Perform setup as described in the <i>WT4090 Integrator Guide</i> . Ensure that Microsoft ActiveSync 4.1 or greater is installed on the host computer.
Cannot ActiveSync with Host Computer	Wrong USB cable used.	Ensure that the cable has a USB A connector on one end and a USB mini B connector on the other end.
	Host computer not configured properly.	Ensure that ActiveSync on the host computer is set to allow USB connections.
	The wearable terminal is not fully seated in the cradle.	Remove and re-insert the wearable terminal into the cradle, ensuring it is firmly seated.



# Appendix A Specifications

## Technical Specifications

The following tables summarize the wearable terminal's intended operating environment and general technical hardware specifications.

### Wearable Terminal

The following table summarizes the wearable terminal's intended operating environment.

**Table A-1** *Technical Specifications*

Item	Description
<b>Physical and Environmental Characteristics</b>	
Dimensions	5.7 inches L x 3.7 inches W x 1.0 inch H (14.2 cm L x 9.3 cm H x 2.6 cm H)
Weight (including battery)	11.3 oz. (320 gm)
Keyboard	Two-color Alphanumeric Keypad or Triple-tap Alphanumeric Keypad
Display	Color 2.8 inch QVGA
Main Battery	Removable, rechargeable 3.7 VDC Lithium Ion battery. Standard capacity: 2330 mAh
Backup Battery	Two NiMH batteries (rechargeable) 15 mAh 2.4 VDC (not user accessible)
<b>Performance Characteristics</b>	
CPU	XScale PXA270 processor at 520 MHz
Operating System	Microsoft Windows CE 5.0 Professional
Memory	Windows CE: 64MB Flash/128MB RAM
Application Development	PSDK, DCP and SMDK available through Symbol Developer Zone web site
Data Capture Options	RS309 scanner RS409 scanner

**Table A-1** *Technical Specifications (Continued)*

Item	Description
<b>User Environment</b>	
Operating Temperature	-4 °F to 122°F (-20 °C to 50 °C)
Storage Temperature	-40 °F to 158 °F (-40 °C to 70 °C)
Battery Charging Temperature	32 °F to 104 °F (0 °C to +40 °C) ambient temperature range.
Humidity	5% to 95% non condensing
Drop Specification	Multiple 4 ft.(1.2 m) drops to concrete across operating temperature range
Tumble	500 half-meter tumbles at room temperature (1,000 drops)
Environmental Sealing	IP54 Category 2
ESD	± 15k VDC air discharge ± 8k VDC direct discharge ± 8k VDC indirect discharge
<b>WLAN Wireless Data Communications</b>	
WLAN radio	WT4070: Symbol 802.11b/g WT4090: Symbol 802.11a/b/g
Operating Channels	Channel 8 - 169 (5040 - 5845 MHz) (4920 - 4980 MHz) Japan only Channel 1 - 13 (2412 - 2472 MHz) Channel 14 (2484 MHz) Japan only Actual operating frequencies depend on regulatory rules and certification agency
Security	WPA2, WEP (40 or 128 bit), TKIP, TLS, TTLS (MS-CHAP), TTLS (MS-CHAP v2), TTLS (CHAP), TTLS-MD5, TTLS-PAP, PEAP-TLS, PEAP (MS-CHAP v2), AES, LEAP
Voice Communication	Runs voice recognition engines and text-to-speech engines for voice picking applications
Output Power	100 mW U.S. and International
Data Rate	802.11a: up to 54Mb per second 802.11b: up to 11Mb per second 802.11g: up to 54Mb per second
Frequency Range	802.11a: 5 GHz; country-dependent 802.11b: 2.4 GHz; country-dependent 802.11g: 2.4 GHz; country-dependent
Antenna	Internal
<b>WPAN Wireless Data Communications</b>	
Bluetooth	Bluetooth Version 1.2



**Table A-1** *Technical Specifications (Continued)*

Item	Description
<b>Peripherals and Accessories</b>	
Cradles	Single Slot USB Four Slot Ethernet
Printers	Supports extensive line of Symbol approved printers, cables and accessories
Charger	Four Slot Battery Charger
Other Accessories	Headset adapter to a 2.5 mm barrel jack headset connector
<b>Regulatory</b>	
Electrical Safety	Certified to UL60950-1, CSA C22.2 No. 60950-1, EN60950/IEC 60950-1 plus all national deviations
EMC	FCC Part 15 Subpart B, ICES-003 Class B, EN 60601-1-2, EN 61000-3-2, EN 61000-3-3, CISPR 22 Class B, CISPR 24
RF	FCC Parts 15.247, 15.407, 15.205, 15.207, 15.209, 15.203, EN 300 32, EN301 893, RSS-100, RSS-210, ARIB STD-66 & 33, ARIB STD-T70 & 71

## RS309 Scanner

**Table A-2** *RS309 Technical Specifications*

Item	Description
<b>Physical and Environmental Characteristics</b>	
Dimensions (standard version without cables attached)	2.7 inch L x 2.4 inch W x 1.5 inch H (6.8 cm L x 6.1 cm H x 3.8 cm)
Weight (standard version without cables attached)	3.525 oz. (98 gm)
Current	140 mA typical, 180 mA max
Standby Current	60 $\mu$ A max
Voltage	3.1 to 3.6 VDC
Vcc Noise Level	200 mV p-p max.
<b>Performance Characteristics</b>	
Light Source	650 nm LASER, 1.06 mW
Scan Rate	35 ( $\pm$ 5) scans/sec (bidirectional)
Nominal Working Distance	Density 5 mil    7.5 mil    13 mil    20 mil    55 mil Code Type 39    39    UPC    39    39 Far (inches) 7    9.75    20.25    29.25    54.5    (Guaranteed) Far (inches) 9.5    15.25    27.25    42.5    84.75    (Typical)
Yaw	$\pm$ 50 degrees from normal
Roll	$\pm$ 20 degrees from vertical

**Table A-2** RS309 Technical Specifications (Continued)

Item	Description
Pitch	± 65 degrees from normal
<b>User Environment</b>	
Operating Temperature	-22 °F to 122 °F (-30 °C to 50 °C)
Storage Temperature	-40 °F to 140 °F (-40 °C to 60 °C)
Humidity	5% to 95% non condensing
Drop Specification	4 ft.(1.8m) drop to concrete
Environmental Sealing	IP54 sealing
Ambient Light Immunity	Indoor: 450 foot-candles (4,844 lux) Outdoor: 8,000 foot-candles (86,111 lux)
<b>Regulatory</b>	
Electrical Safety	Certified to CSA C22.2 No. 60950-1, EN60950-1, IEC 60950-1
EMI/RFI	FCC Part 15 Class B, ICES-003 Class B, European Union EMC and R&TTE Directives, Australian AS/NZS 4268
Laser Safety	CDRH Class II, IEC 60825-1 Class 2
Laser Decode Capability	Code 39 Code 128 Code 93 Codabar Code 11 Discrete 2 of 5 Interleaved 2 of 5 EAN-8 EAN-13 MSIUPCA UPCE UPC/EAN supplementals Coupon Code Trioptic 39 Webcode Chinese 2 of 5 RSS

## RS409 Scanner

**Table A-3** RS409 Technical Specifications

Item	Description
<b>Physical and Environmental Characteristics</b>	
Dimensions	1.9 in. L x 1.4 in. W x 1.9 in. H (4.8 cm L x 3.6 cm H x 4.8 cm H)
Weight (standard version without cables attached)	2.0 oz. (56.7 gm)
Current	92 mA typical, 121 mA max
Standby Current	12µA typical/60 µA max
Voltage	3.1 to 3.6 VDC
Vcc Noise Level	100 mV p-p max.
<b>Performance Characteristics</b>	
Light Source	650 nm LASER, 1.55 mW

**Table A-3** RS409 Technical Specifications (Continued)

Item	Description
Scan Rate	104 ( $\pm$ 12) scans/sec (bidirectional)
Nominal Working Distance	Density 5 mil 7.5 mil 10 mil 13 mil 20 mil 40 mil 55 mil Code Type 39 39 39 UPC 39 39 39 Far (inches) 4.75 8.75 13.25 17.25 21.5 22.25 27 (Guaranteed) Far (inches) 8.75 14.25 24.25 35.75 50.5 (Typical)
Yaw	$\pm$ 50 degrees from normal
Roll	$\pm$ 35 degrees from vertical
Pitch	$\pm$ 65 degrees from normal
<b>User Environment</b>	
Operating Temperature	-4 °F to 122 °F (-20 °C to 50 °C)
Storage Temperature	-25 °F to 160 °F (-40 °C to 70 °C)
Humidity	5% to 95% non condensing
Drop Specification	4 ft.(1.8m) drop to concrete
Environmental Sealing	IP54 sealing
Ambient Light Immunity	Indoor: 450 foot-candles (4,844 lux) Outdoor: 8,000 foot-candles (86,111 lux)
<b>Regulatory</b>	
Electrical Safety	Certified to CSA C22.2 No. 60950-1, EN60950-1, IEC 60950-1
EMI/RFI	FCC Part 15 Class B, ICES-003 Class B, European Union EMC and R&TTE Directives, Australian AS/NZS 4268
Laser Safety	CDRH Class II, IEC 60825-1 Class 2
Laser Decode Capability	Code 39 Code 128 Code 93 Codabar Code 11 Discrete 2 of 5 Interleaved 2 of 5 EAN-8 EAN-13 MSI UPCA UPCE UPC/EAN supplementals Coupon Code Trioptic 39 Webcode Chinese 2 of 5 RSS

## Cradles

**Table A-4** *Accessory Specifications*

	Single Slot USB Cradle	Four Slot Ethernet Cradle	Four Slot Spare Battery Charger
Operating Temperature	32 °F to 122 °F (0 °C to +50 °C)		32 °F to 104 °F (0 °C to +40 °C)
Storage Temperature	-40 °F to 158 °F (-40 °C to 70 °C)		
Battery Charging Temperature	32 °F to 104 °F (0 °C to +40 °C) ambient temperature		
Humidity	5% to 95% non-condensing		
Size (L x W x H)	6.6 in. x 5.1 in. x 3.9 in. (16.8 cm x 13.0 cm x 9.9 cm)	6.7 in. x 18.9 in. x 4.5 in. (17.0 cm x 48.1 cm x 11.4 cm)	8.5 in. x 5.7 in. x 1.9 in. (21.5 cm x 14.5 cm x 4.9 cm)
Weight	12.1 oz. (344 gm)	45.9 oz. (1300 gm)	15.3 oz. (435 gm)
Power Supply	12 VDC, 3.3 A	12 VDC, 9 A	12 VDC, 3.3 A
Drop	30 inches (76.2 cm) to vinyl covered concrete		
Electrostatic Discharge (ESD)	±15 kV air discharge, ± 8 kV contact discharge		
Typical Power	20 W	60 W	25 W

# Appendix B Regulatory Information

## Introduction

This appendix contains the accessory power supply regulatory compliance statements.

## Accessory Power Supply Regulatory Compliance

**Table B-1** *Accessory Power Supplies, Regulatory Compliance Statements*

Accessory	Power Supplies Regulatory Compliance Statements
Single Slot USB Cradle Power Supply Four Slot Battery Charger Power Supply	<p>Use only a Symbol-approved power supply output rated 12 VDC and minimum 3.3 A. The power supply is certified to EN60950 with SELV outputs. Use of alternative power supply will invalidate any approval given to this device and may be dangerous.</p> <p>Benutzen Sie nur eine von Symbol Technologies genehmigte Stromversorgung mit einer Ausgangsleistung von 12 V (Gleichstrom) und mindestens 3.3 A. Die Stromversorgung ist nach EN60950 für die Verwendung in SELV-Stromkreisen zertifiziert. Bei Verwendung eines anderen Netzteils werden alle für das Gerät gewährten Genehmigungen außer Kraft gesetzt, und der Betrieb kann gefährlich sein.</p>
Four Slot Ethernet Cradle Power Supply	<p>Use only a Symbol-approved power supply output rated 12 VDC and minimum 9 A. The power supply is certified to EN60950 with SELV outputs. Use of alternative power supply will invalidate any approval given to this device and may be dangerous.</p> <p>Benutzen Sie nur eine von Symbol Technologies genehmigte Stromversorgung mit einer Ausgangsleistung von 12 V (Gleichstrom) und mindestens 9 A. Die Stromversorgung ist nach EN60950 für die Verwendung in SELV-Stromkreisen zertifiziert. Bei Verwendung eines anderen Netzteils werden alle für das Gerät gewährten Genehmigungen außer Kraft gesetzt, und der Betrieb kann gefährlich sein.</p>



# Glossary

---

## A

**API.** An interface by means of which one software component communicates with or controls another. Usually used to refer to services provided by one software component to another, usually via software interrupts or function calls

**Application Programming Interface.** See **API**.

**ANSI Terminal.** A display terminal that follows commands in the ANSI standard terminal language. For example, it uses escape sequences to control the cursor, clear the screen and set colors. Communications programs support the ANSI terminal mode and often default to this terminal emulation for dial-up connections to online services.

**ASCII.** American Standard Code for Information Interchange. A 7 bit-plus-parity code representing 128 letters, numerals, punctuation marks and control characters. It is a standard data transmission code in the U.S.

---

## B

**Bar.** The dark element in a printed bar code symbol.

**Bar Code.** A pattern of variable-width bars and spaces which represents numeric or alphanumeric data in machine-readable form. The general format of a bar code symbol consists of a leading margin, start character, data or message character, check character (if any), stop character, and trailing margin. Within this framework, each recognizable symbology uses its own unique format. See **Symbology**.

**Bit.** Binary digit. One bit is the basic unit of binary information. Generally, eight consecutive bits compose one byte of data. The pattern of 0 and 1 values within the byte determines its meaning.

**Bits per Second (bps).** Bits transmitted or received.

**Bit.** Binary digit. One bit is the basic unit of binary information. Generally, eight consecutive bits compose one byte of data. The pattern of 0 and 1 values within the byte determines its meaning.

**bps.** See **Bits Per Second**.

**Byte.** On an addressable boundary, eight adjacent binary digits (0 and 1) combined in a pattern to represent a specific character or numeric value. Bits are numbered from the right, 0 through 7, with bit 0 the low-order bit. One byte in memory is used to store one ASCII character.

**boot or boot-up.** The process a computer goes through when it starts. During boot-up, the computer can run self-diagnostic tests and configure hardware and software.

---

## C

**CDRH.** Center for Devices and Radiological Health. A federal agency responsible for regulating laser product safety. This agency specifies various laser operation classes based on power output during operation.

**CDRH Class 1.** This is the lowest power CDRH laser classification. This class is considered intrinsically safe, even if all laser output were directed into the eye's pupil. There are no special operating procedures for this class.

**CDRH Class 2.** No additional software mechanisms are needed to conform to this limit. Laser operation in this class poses no danger for unintentional direct human exposure.

**Character.** A pattern of bars and spaces which either directly represents data or indicates a control function, such as a number, letter, punctuation mark, or communications control contained in a message.

**Codabar.** A discrete self-checking code with a character set consisting of digits 0 to 9 and six additional characters: (-\$/,+).

**Code 128.** A high density symbology which allows the controller to encode all 128 ASCII characters without adding extra symbol elements.

**Code 3 of 9 (Code 39).** A versatile and widely used alphanumeric bar code symbology with a set of 43 character types, including all uppercase letters, numerals from 0 to 9 and 7 special characters (space, minus (-), plus (+), period (.), dollar sign (\$), slash (/), and percent (%)). The code name is derived from the fact that 3 of 9 elements representing a character are wide, while the remaining 6 are narrow.

**Code 93.** An industrial symbology compatible with Code 39 but offering a full character ASCII set and a higher coding density than Code 39.

**Cold Boot.** A cold boot restarts the wearable terminal and erases all user stored records and entries.

**COM port.** Communication port; ports are identified by number, e.g., COM1, COM2.

**Cradle.** A cradle is used for charging the terminal battery and for communicating with a host computer, and provides a storage place for the terminal when not in use.

---

## D

**DCP.** See **Device Configuration Package**.

**Decode.** To recognize a bar code symbology (e.g., UPC/EAN) and then analyze the content of the specific bar code scanned.



**Decode Algorithm.** A decoding scheme that converts pulse widths into data representation of the letters or numbers encoded within a bar code symbol.

**Decryption.** Decryption is the decoding and unscrambling of received encrypted data. Also see, **Encryption** and **Key**.

**Depth of Field.** The range between minimum and maximum distances at which a scanner can read a symbol with a certain minimum element width.

**Device Configuration Package.** The Symbol Device Configuration Package provides the Product Reference Guide (PRG), flash partitions, Terminal Configuration Manager (TCM) and the associated TCM scripts. With this package hex images that represent flash partitions can be created and downloaded to the wearable terminal.

**Discrete 2 of 5.** A binary bar code symbology representing each character by a group of five bars, two of which are wide. The location of wide bars in the group determines which character is encoded; spaces are insignificant. Only numeric characters (0 to 9) and START/STOP characters may be encoded.

---

## E

**EAN.** European Article Number. This European/International version of the UPC provides its own coding format and symbology standards. Element dimensions are specified metrically. EAN is used primarily in retail.

**ENQ (RS-232).** ENQ software handshaking is also supported for the data sent to the host.

**ESD.** Electro-Static Discharge

---

## F

**Flash Disk.** An additional megabyte of non-volatile memory for storing application and configuration files.

**Flash Memory.** Flash memory is nonvolatile, semi-permanent storage that can be electronically erased in the circuit and reprogrammed. Wearable terminals use Flash memory to store the operating system (ROM-DOS), the terminal emulators, and the Citrix ICA Client for DOS.

**File Transfer Protocol (FTP).** A TCP/IP application protocol governing file transfer via network or telephone lines. See **TCP/IP**.

**FTP.** See **File Transfer Protocol**.

**Flash Memory.** Flash memory is responsible for storing the system firmware and is non-volatile. If the system power is interrupted the data is not be lost.

---

## H

**Hard Reset.** See **Cold Boot**.

**Hz.** Hertz; A unit of frequency equal to one cycle per second.

**Host Computer.** A computer that serves other terminals in a network, providing such services as computation, database access, supervisory programs and network control.

---

## I

**IEC.** International Electrotechnical Commission. This international agency regulates laser safety by specifying various laser operation classes based on power output during operation.

**IEC (825) Class 1.** This is the lowest power IEC laser classification. Conformity is ensured through a software restriction of 120 seconds of laser operation within any 1000 second window and an automatic laser shutdown if the scanner's oscillating mirror fails.

**IEEE Address.** See **MAC Address**.

**Interleaved 2 of 5.** A binary bar code symbology representing character pairs in groups of five bars and five interleaved spaces. Interleaving provides for greater information density. The location of wide elements (bar/spaces) within each group determines which characters are encoded. This continuous code type uses no intercharacter spaces. Only numeric (0 to 9) and START/STOP characters may be encoded.

**IOCTL.** Input/Output Control.

**Interleaved Bar Code.** A bar code in which characters are paired together, using bars to represent the first character and the intervening spaces to represent the second.

**Interleaved 2 of 5.** A binary bar code symbology representing character pairs in groups of five bars and five interleaved spaces. Interleaving provides for greater information density. The location of wide elements (bar/spaces) within each group determines which characters are encoded. This continuous code type uses no intercharacter spaces. Only numeric (0 to 9) and START/STOP characters may be encoded.

**Internet Protocol Address.** See **IP**.

**I/O Ports.** interface The connection between two devices, defined by common physical characteristics, signal characteristics, and signal meanings. Types of interfaces include RS-232 and PCMCIA.

**Input/Output Ports.** I/O ports are primarily dedicated to passing information into or out of the terminal's memory. Wearable terminals include Serial and USB ports.

**IP.** Internet Protocol. The IP part of the TCP/IP communications protocol. IP implements the network layer (layer 3) of the protocol, which contains a network address and is used to route a message to a different network or subnetwork. IP accepts "packets" from the layer 4 transport protocol (TCP or UDP), adds its own header to it and delivers a "datagram" to the layer 2 data link protocol. It may also break the packet into fragments to support the maximum transmission unit (MTU) of the network.

**IP Address.** (Internet Protocol address) The address of a computer attached to an IP network. Every client and server station must have a unique IP address. A 32-bit address used by a computer on a IP network. Client workstations have either a permanent address or one that is dynamically assigned to them each session. IP addresses are written as four sets of numbers separated by periods; for example, 204.171.64.2.

**IPX/SPX.** Internet Package Exchange/Sequential Packet Exchange. A communications protocol for Novell. IPX is Novell's Layer 3 protocol, similar to XNS and IP, and used in NetWare networks. SPX is Novell's version of the Xerox SPP protocol.

**IS-95.** Interim Standard 95. The EIA/TIA standard that governs the operation of CDMA cellular service. Versions include IS-95A and IS-95B. See CDMA.

---

## K

**Key.** A key is the specific code used by the algorithm to encrypt or decrypt the data. Also see, **Encryption** and **Decrypting**.

---

## L

**laser scanner.** A type of bar code reader that uses a beam of laser light.

**LASER.** Light Amplification by Stimulated Emission of Radiation. The laser is an intense light source. Light from a laser is all the same frequency, unlike the output of an incandescent bulb. Laser light is typically coherent and has a high energy density.

**LCD.** See **Liquid Crystal Display**.

**LED Indicator.** A semiconductor diode (LED - Light Emitting Diode) used as an indicator, often in digital displays. The semiconductor uses applied voltage to produce light of a certain frequency determined by the semiconductor's particular chemical composition.

**Liquid Crystal Display (LCD).** A display that uses liquid crystal sealed between two glass plates. The crystals are excited by precise electrical charges, causing them to reflect light outside according to their bias. They use little electricity and react relatively quickly. They require external light to reflect their information to the user.

**Light Emitting Diode.** See **LED**.

---

## M

**MDN.** Mobile Directory Number. The directory listing telephone number that is dialed (generally using POTS) to reach a mobile unit. The MDN is usually associated with a MIN in a cellular telephone -- in the US and Canada, the MDN and MIN are the same value for voice cellular users. International roaming considerations often result in the MDN being different from the MIN.

**MIL.** 1 mil = 1 thousandth of an inch.

**MIN.** Mobile Identification Number. The unique account number associated with a cellular device. It is broadcast by the cellular device when accessing the cellular system.

---

## N

**Nominal.** The exact (or ideal) intended value for a specified parameter. Tolerances are specified as positive and negative deviations from this value.

---

## O

**Open Data-Link Interface (ODI).** Novell's driver specification for an interface between network hardware and higher-level protocols. It supports multiple protocols on a single NIC (Network Interface Controller). It is capable of understanding and translating any network information or request sent by any other ODI-compatible protocol into something a NetWare client can understand and process.

**Open System Authentication.** Open System authentication is a null authentication algorithm.

---

## P

**PAN .** Personal area network. Using Bluetooth wireless technology, PANs enable devices to communicate wirelessly. Generally, a wireless PAN consists of a dynamic group of less than 255 devices that communicate within about a 33-foot range. Only devices within this limited area typically participate in the network.

**Parameter.** A variable that can have different values assigned to it.

**PING.** (Packet Internet Groper) An Internet utility used to determine whether a particular IP address is online. It is used to test and debug a network by sending out a packet and waiting for a response.

**Print Contrast Signal (PCS).** Measurement of the contrast (brightness difference) between the bars and spaces of a symbol. A minimum PCS value is needed for a bar code symbol to be scannable.  $PCS = (RL - RD) / RL$ , where RL is the reflectance factor of the background and RD the reflectance factor of the dark bars.

---

## Q

**QWERTY.** A standard keyboard commonly used on North American and some European PC keyboards. "QWERTY" refers to the arrangement of keys on the left side of the third row of keys.

---

## R

**RAM.** Random Access Memory. Data in RAM can be accessed in random order, and quickly written and read.

**Resolution.** The narrowest element dimension which is distinguished by a particular reading device or printed with a particular device or method.

**RF.** Radio Frequency.

**ROM.** Read-Only Memory. Data stored in ROM cannot be changed or removed.

**Router.** A device that connects networks and supports the required protocols for packet filtering. Routers are typically used to extend the range of cabling and to organize the topology of a network into subnets. See **Subnet**.

**RS-232.** An Electronic Industries Association (EIA) standard that defines the connector, connector pins, and signals used to transfer data serially from one device to another.

---

## S

**Scan Area.** Area intended to contain a symbol.

**Scanner.** An electronic device used to scan bar code symbols and produce a digitized pattern that corresponds to the bars and spaces of the symbol. Its three main components are:

1. Light source (laser or photoelectric cell) - illuminates a bar code.
2. Photodetector - registers the difference in reflected light (more light reflected from spaces).
3. Signal conditioning circuit - transforms optical detector output into a digitized bar pattern.

**SDK.** Software Development Kit

**Secure Sockets Layer (SSL).** SSL is a commonly-used protocol for managing the security of a message transmission on the Internet. SSL uses a program layer located between the Internet's Hypertext Transfer Protocol (HTTP) and Transport Control Protocol (TCP) layers. SSL is included as part of both the Microsoft and Netscape browsers and most Web server products. Developed by Netscape, SSL also gained the support of Microsoft and other Internet client/server developers as well and became the de facto standard until evolving into Transport Layer Security. The "sockets" part of the term refers to the sockets method of passing data back and forth between a client and a server program in a network or between program layers in the same computer. SSL uses the public-and-private key encryption system from RSA, which also includes the use of a digital certificate.

**Shared Key.** Shared Key authentication is an algorithm where both the AP and the MU share an authentication key.

**SID.** System Identification code. An identifier issued by the FCC for each market. It is also broadcast by the cellular carriers to allow cellular devices to distinguish between the home and roaming service.

**SMDK.** Symbol Mobility Developer's Kit.

**Soft Reset.** See **Warm Boot**.

**Subnet.** A subset of nodes on a network that are serviced by the same router. See **Router**.

**Subnet Mask.** A 32-bit number used to separate the network and host sections of an IP address. A custom subnet mask subdivides an IP network into smaller subsections. The mask is a binary pattern that is matched up with the IP address to turn part of the host ID address field into a field for subnets. Default is often 255.255.255.0.

**Substrate.** A foundation material on which a substance or image is placed.

**Symbol.** A scannable unit that encodes data within the conventions of a certain symbology, usually including start/stop characters, quiet zones, data characters and check characters.

**Symbology.** The structural rules and conventions for representing data within a particular bar code type (e.g. UPC/EAN, Code 39, PDF417, etc.).

---

## T

**TCP/IP.** (Transmission Control Protocol/Internet Protocol) A communications protocol used to internetwork dissimilar systems. This standard is the protocol of the Internet and has become the global standard for communications. TCP provides transport functions, which ensures that the total amount of bytes sent is received correctly at the other end. UDP is an alternate transport that does not guarantee delivery. It is widely used for real-time voice and video transmissions where erroneous packets are not retransmitted. IP provides the routing mechanism. TCP/IP is a routable protocol, which means that all messages contain not only the address of the destination station, but the address of a destination network. This allows TCP/IP messages to be sent to multiple networks within an organization or around the world, hence its use in the worldwide Internet. Every client and server in a TCP/IP network requires an IP address, which is either permanently assigned or dynamically assigned at startup.

**Telnet.** A terminal emulation protocol commonly used on the Internet and TCP/IP-based networks. It allows a user at a terminal or computer to log onto a remote device and run a program.

**Terminal.** See Wearable Terminal.

**Terminal Emulation.** A “terminal emulation” emulates a character-based mainframe session on a remote non-mainframe terminal, including all display features, commands and function keys. The WT4090 Series supports Terminal Emulations in 3270, 5250 and VT220.

**TFTP.** (Trivial File Transfer Protocol) A version of the TCP/IP FTP (File Transfer Protocol) protocol that has no directory or password capability. It is the protocol used for upgrading firmware, downloading software and remote booting of diskless devices.

**Tolerance.** Allowable deviation from the nominal bar or space width.

**Transmission Control Protocol/Internet Protocol.** See **TCP/IP**.

**Transport Layer Security (TLS).** TLS is a protocol that ensures privacy between communicating applications and their users on the Internet. When a server and client communicate, TLS ensures that no third party may eavesdrop or tamper with any message. TLS is the successor to the Secure Sockets Layer (SSL).

**Trivial File Transfer Protocol.** See **TFTP**.

---

## U

**UPC.** Universal Product Code. A relatively complex numeric symbology. Each character consists of two bars and two spaces, each of which is any of four widths. The standard symbology for retail food packages in the United States.

**UDP.** User Datagram Protocol. A protocol within the IP protocol suite that is used in place of TCP when a reliable delivery is not required. For example, UDP is used for real-time audio and video traffic where lost packets are simply ignored, because there is no time to retransmit. If UDP is used and a reliable delivery is required, packet sequence checking and error notification must be written into the applications.

---

## U

**Visible Laser Diode (VLD).** A solid state device which produces visible laser light.

---

## W

**Warm Boot.** A warm boot restarts the wearable terminal by closing all running programs. All data that is not saved to flash memory is lost.

**Wearable Terminal.** In this text, wearable terminal refers to the Symbol WT4090 that can be set up to communicate with a network, using wireless radio technology.





# Index

## Numerics

- 1-D bar codes ..... 2-15
- 28-key keypad ..... 2-5

## A

- accessories ..... 1-3
  - four slot charge only cradle ..... 3-1
  - four slot cradles
    - battery charging ..... 3-5
  - four slot Ethernet cradle ..... 3-4
    - LED indicators ..... 3-5
  - four slot Ethernet/USB cradle ..... 1-3, 3-1
  - four slot spare battery charger ..... 1-3
  - serial/USB cradle ..... 1-3, 3-1
  - single slot serial/USB cradle ..... 3-2
    - LED indicators ..... 3-3, 3-6
  - SMDK ..... 1-3
  - spare battery charger ..... 3-6
    - power connection ..... 3-6

## B

- backup battery ..... 2-10
  - charging ..... 1-6
- bar codes
  - one dimensional ..... 2-15
- battery
  - backup charging ..... 1-6
  - charging ..... 1-6
    - temperature range ..... A-6
  - installing ..... 1-5
  - removing ..... 1-7
- battery charging
  - four slot cradles ..... 3-5
- battery charging temperature ..... A-2

- battery icon ..... 2-10
- battery status ..... 2-10
- boot
  - cold ..... 1-10, 2-1, 2-14
  - warm ..... 2-1, 2-14
- bullets ..... xii
- buttons
  - power ..... 2-1

## C

- characters, special ..... 2-6
- charging
  - spare batteries ..... 1-7
  - temperature range ..... A-6
- charging batteries ..... 1-6
- charging spare batteries ..... 1-7
- cleaning ..... 4-1
- cold boot ..... 1-10, 2-1, 2-14
- configuration ..... x
- configurations ..... x
- conventions
  - notational ..... xii
- CPU ..... A-1
- cradles
  - four slot charge only ..... 3-1
  - four slot cradles
    - battery charging ..... 3-5
  - four slot Ethernet ..... 3-4
  - four slot Ethernet cradle
    - LED indicators ..... 3-5
  - four slot Ethernet/USB ..... 1-3, 3-1
  - serial/USB ..... 1-3, 3-1
  - single slot ..... 3-2
    - LED indicators ..... 3-3, 3-6
  - spare battery charger ..... 3-6
    - power connection ..... 3-6

current time . . . . . 2-10

**D**

data capture . . . . . x, 2-15  
 adjusting the distance . . . . . 2-16  
 indicator . . . . . 2-16  
 laser scanning . . . . . 2-15  
 one dimensional bar codes . . . . . 2-15  
 scan angle . . . . . 2-15  
 scan range . . . . . 2-15  
 scanning . . . . . 2-15  
 date/time . . . . . 2-10  
 DCP for WT4090c50 . . . . . xiii  
 Device Configuration Package . . . . . 1-3  
 Device Configuration Package for WT4090c50 . . . . . xiii  
 dimensions . . . . . A-1, A-3, A-4  
 display . . . . . x, A-1  
 drop specification . . . . . A-2, A-4, A-5

**E**

electrical safety . . . . . A-3, A-4, A-5

**F**

four slot charge only . . . . . 3-1  
 four slot cradles  
     battery charging . . . . . 3-5  
 four slot Ethernet cradle . . . . . 3-4  
     LED indicators . . . . . 3-5  
 four slot Ethernet/USB . . . . . 1-3, 3-1  
 four slot spare battery charger . . . . . 1-3

**G**

getting started . . . . . 1-5

**H**

hard reset . . . . . 1-10, 2-1, 2-14  
 humidity . . . . . A-2, A-4, A-5

**I**

icon  
     battery status . . . . . 2-10  
 icons  
     alpha mode . . . . . 2-11  
     ALT . . . . . 2-11  
     CTRL . . . . . 2-11  
     function . . . . . 2-11  
     shift . . . . . 2-11  
 information, service . . . . . xiii

installing main battery . . . . . 1-5

**K**

key descriptions  
     two-color alphanumeric . . . . . 2-3, 2-5  
 keyboard . . . . . A-1  
 keypads . . . . . x  
     28-key . . . . . 2-5  
     double-tap . . . . . 2-3  
     types . . . . . 2-3

**L**

laser safety . . . . . A-4, A-5  
 laser scanning  
     See data capture . . . . . 2-15  
 LED . . . . . 2-2  
 lithium-ion battery . . . . . 1-2

**M**

main battery  
     charging . . . . . 1-5, 1-6  
         temperature range . . . . . A-6  
     installing . . . . . 1-5  
 maintenance . . . . . 4-1  
 memory . . . . . x, A-1

**O**

operating environment, wearable terminal . . . . . A-1  
 operating system . . . . . x, A-1  
 operating temperature . . . . . A-2, A-4, A-5

**P**

parts of the wearable terminal . . . . . 1-1, 1-3, 1-4  
 power . . . . . 2-2  
 power button . . . . . 2-1  
 power LED . . . . . 2-2  
 power supply regulatory compliance . . . . . B-1

**R**

radios . . . . . x  
 regulatory compliance, power supply . . . . . B-1  
 related documents . . . . . xii  
 related software . . . . . xii  
 removing main battery . . . . . 1-7  
 reset  
     hard . . . . . 1-10, 2-1, 2-14  
     soft . . . . . 2-1, 2-14  
 resetting . . . . . 2-14

**S**

- scan status ..... 2-16
- scan status *See also* data capture
- scanning
  - bar codes ..... 2-15
  - LED indicators ..... 2-16
  - See* data capture ..... 2-15
- screen
  - Symbol splash screen ..... 1-10
- serial/USB cradle ..... 1-3, 3-1
- service information ..... xiii
- single slot serial/USB cradle ..... 3-2
  - LED indicators ..... 3-3, 3-6
- SMDK for eVC4 ..... xiii
- soft reset ..... 2-1, 2-14
- spare batteries
  - charging ..... 1-7
- spare battery
  - charging ..... 1-7
- spare battery charger ..... 3-6
  - power connection ..... 3-6
- special characters ..... 2-6
- specifications ..... A-1
- starting the wearable terminal ..... 1-5, 1-10
- status ..... 2-10
- status icon ..... 2-10
- status icons
  - Windows CE 5.0 ..... 2-10
- storage temperature ..... A-2, A-4, A-5
- suspend ..... 1-7, 2-1
- Symbol Mobility Developer Kit
  - See* SMDK ..... 1-3
- Symbol Mobility Developer Kit for eVC4 ..... xiii

**T**

- taskbar ..... 2-10
- technical specifications, wearable terminal ..... A-1
- temperature
  - battery charging ..... A-6
- terminal
  - charging ..... 2-10
- terminal charging ..... 2-10
- troubleshooting ..... 4-3
  - four slot spare battery charger ..... 4-7
  - single slot serial/USB cradle ..... 4-8
  - wearable terminal ..... 4-3

**U**

- unpacking ..... 1-2

**W**

- warm boot ..... 2-1, 2-14
- wearable terminal
  - power on ..... 2-1
  - starting ..... 1-10
- weight ..... A-1, A-3, A-4
- wireless status icon ..... 2-11
- WLAN 802.11a/b/g ..... x
- WLAN status ..... 2-11
- WPAN Bluetooth ..... x







**MOTOROLA**

Motorola, Inc.  
One Motorola Plaza  
Holtsville, New York 11742, USA  
1-800-927-9626  
<http://www.symbol.com>

MOTOROLA and the Stylized M Logo and Symbol and the Symbol logo are registered in the U.S. Patent and Trademark Office.  
All other product or service names are the property of their registered owners.  
© Motorola, Inc. 2008