

**Monarch® 9406™  
Thermal Printer**

**Operator's Handbook**

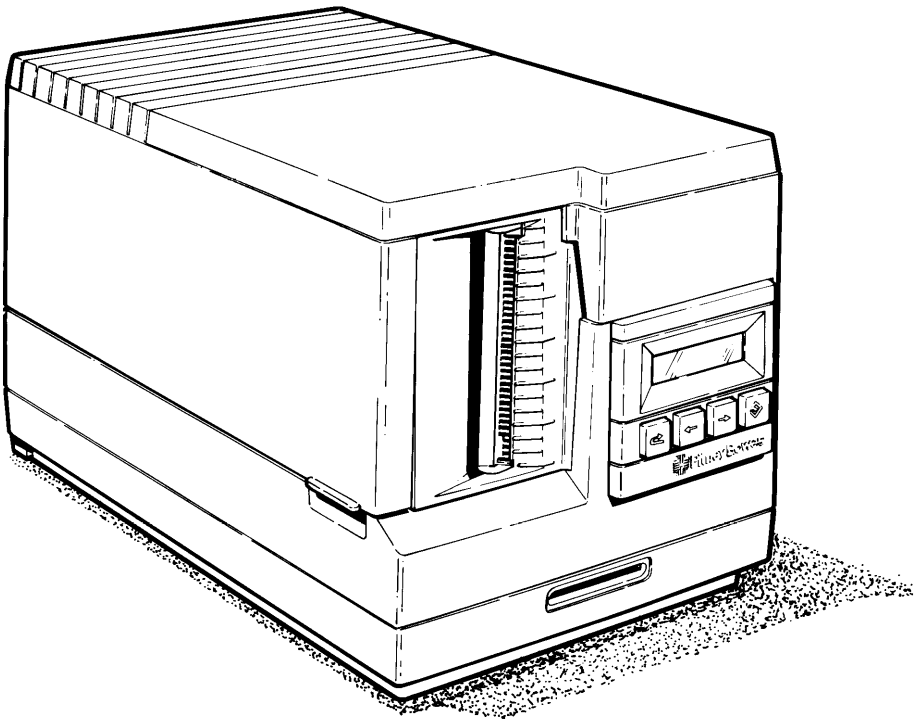

Each product and program carries a respective written warranty, the only warranty on which the customer can rely. Monarch reserves the right to make changes in the product and the programs and their availability at any time and without notice. Although Monarch has made every effort to provide complete and accurate information in this manual, Monarch shall not be liable for any omissions or inaccuracies. Any update will be incorporated in a later edition of this manual.

### **WARNING**

This equipment can interfere with radio communication if not installed and used in accordance with the instruction manual. It has been tested and found to comply with the limits for a Class A computing device pursuant to FCC Rules, Part 15, Subpart B, which provide reasonable protection against such interference when operated in a commercial environment. Operation in a residential area is likely to cause interference which the user must correct at their own expense.

### **CANADIAN D.O.C. WARNING**

This digital apparatus does not exceed the Class A limits for radio noise emissions from digital apparatus set out in the Radio Interference Regulations of the Canadian Department of Communications.

Le présent appareil numérique n'émet pas de bruits radioélectriques dépassant les limites applicables aux appareils numériques de la classe A prescrites dans le Règlement sur le brouillage radioélectrique édicté par le ministère des Communications du Canada.

### **Trademarks**

Monarch is a registered trademark and 9406 is a trademark of Monarch Marking Systems, Inc.

# Table of Contents

---

<b>1. Introduction</b> .....	1-1
About This Manual.....	1-1
Menu Charts.....	1-1
Other Documentation.....	1-2
Menu Structure.....	1-2
New 9406 Features.....	1-4
Terms You Should Know.....	1-5
<b>2. Getting Started</b> .....	2-1
Turning the Printer On.....	2-2
Using the Keypad.....	2-2
Control Keys.....	2-2
Start Up.....	2-3
Selecting a Function.....	2-3
Exiting an Option.....	2-4
<b>3. Setting Supply Options</b> .....	3-1
Finding the Supply Options.....	3-1
Ribbon.....	3-2
Supply Type.....	3-3
Dispense Mode.....	3-4
Continuous Mode Features.....	3-5
Print Position.....	3-6
Supply Position.....	3-8
Margin Position.....	3-9

<b>4. Setting Communication Values</b> .....	4-1
Finding Communication Value Options.....	4-1
Baud Rate .....	4-2
Word Length.....	4-3
Stop Bits .....	4-4
Parity .....	4-5
Flow Control .....	4-6
Reset to Default Values.....	4-7
<b>5. Setting the Contrast</b> .....	5-1
<b>6. Setting Defaults</b> .....	6-1
Finding Default Options.....	6-1
Monetary Sign .....	6-2
Secondary Sign.....	6-3
Decimal Places .....	6-5
<b>7. Printing Online</b> .....	7-1

# 1. Introduction

---

The 9406™ printer lets you print letters, numbers, bar codes, and graphics on labels. You can create and download formats from a host.

## About This Manual

This manual explains how to begin using the printer and print a batch. You can print online, sending data to the printer from a host.

## Menu Charts

Each section of the manual has one or more charts showing the printer's menu structure. The example below is the chart from "Setting the Contrast."

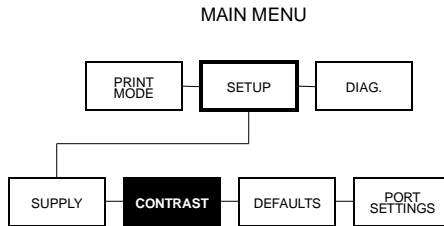

There are two styles of boxes with borders in the charts:

- Boxes with **heavy borders** (SETUP in the sample) show the selections you make to get to the function discussed in the section.
- Boxes with **reverse highlighting** (CONTRAST in the sample) show the functions discussed in the section.

## Other Documentation

Following are other manuals you might need:

<i>Equipment Manual</i>	Contains general set-up and maintenance procedures.
<i>System Administrator's Guide</i>	Explains communications and message structures for sending format and batch data streams online.
<i>Messages Manual</i>	Lists offline and online messages and what action you should take (if any).
<i>Graphics Manual</i>	Tells how to create and print graphics on your 9406 printer.

## Menu Structure

The diagram on the next page shows the structure of the 9406 menu system.



## New 9406 Features

With the latest release of the software, the 9406 printer:

- bases the dispense mechanism on the supply type and dispense mode (instead of only dispense mode). For example, an indexed supply in on-demand mode moves the label over the peel bar. A non-indexed supply in on-demand mode delivers the label under the tear bar. The printer memorizes the last dispense distance so that it can find the top of form position if you change the dispense mode between labels.
- handles non-indexed supplies the same way as indexed supplies. For example, you do not need to treat no-print zones and label lengths as variables. They are fixed, no matter what supply you use.
- displays error messages for five seconds. This change does not affect hard-coded messages or messages that require operator response.
- allows you to suspend a batch. After suspending it, you can cancel it or alter the printer setup and resume printing.
- creates Swedish characters that appear on the same base line as English characters (instead of below the base line).
- offers a new dot shifting algorithm, which shifts the bar code three dots on the left side and three dots on the right side of the bad dot element. After six shifts, if the dark modules of the barcode are not completely out of the bad dot elements, the printer:
  1. Prints a label replacing the bar code with a solid line .156 inches tall.
  2. Cancels the batch.
  3. Beeps and displays "Bad Dot On Bars."
  4. Waits for the operator to acknowledge the error by pressing the  key.



## Terms You Should Know

<b>batch</b>	A group of labels that contain the same data.
<b>batch separator</b>	An extra label between batches that shows where one batch ends and the next one begins.
<b>character</b>	A letter, number, or symbol.
<b>continuous</b>	Dispense mode in which the printer prints all the labels in a batch without stopping.
<b>cursor</b>	The underline symbol that shows where you are on the screen.
<b>digits</b>	Numbers only.
<b>field</b>	An area on the supply where data prints.
<b>format</b>	The arrangement of fields printed on the supply.
<b>enter</b>	Type data from the keypad.
<b>indexed supply</b>	Supplies with an aperture or black mark.
<b>non-indexed supply</b>	Supplies without marks indicating the specific length of the label.
<b>on-demand</b>	Dispense mode in which the printer stops after each label to allow the operator to remove it.
<b>online</b>	Entering data and printing batches by sending data from a host.
<b>queue</b>	Batches waiting to print (also includes the batch that is printing).
<b>supplies</b>	Labels used for printing.



## 2. Getting Started

---

Before you use the 9406 printer:

- Install the printer (refer to your *Equipment Manual*).
- Load supplies (refer to your *Equipment Manual*).
- Set the supply options (see Chapter 3, "Setting Supply Options").
- Set the communication values (see Chapter 4, "Setting Communication Values").
- Set the printer options (Monetary Sign, Secondary Sign, Ribbon, and Dispense Mode).

## Turning the Printer On

Refer to your *Equipment Manual* for information about installing the printer and loading supplies.



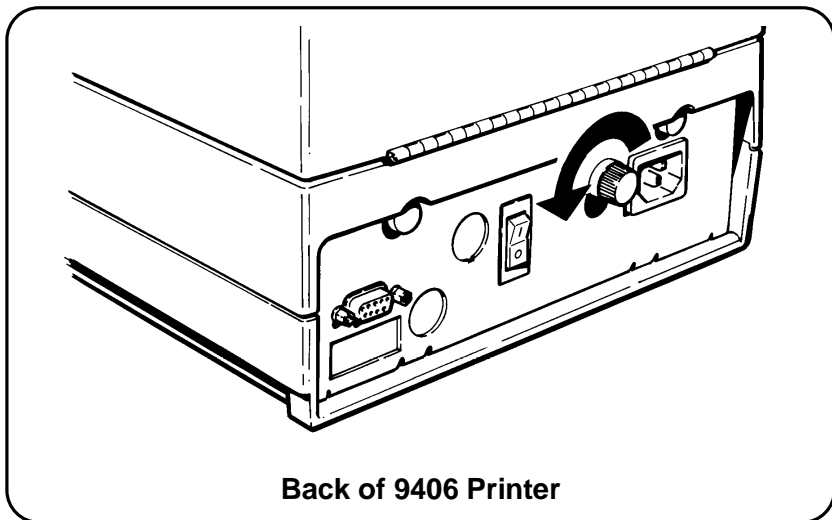

The power switch is on the back of the printer (see the figure below). To turn the printer on, press the top of the power switch.



## Using the Keypad

The printer keypad consists of four control keys for the printer functions.

### Control Keys

-  Returns the display to the next higher menu (when you press  once).
-  Displays the next menu item.
-  Displays the previous menu item.
-  Selects the displayed menu item.

## Start Up

When you turn the printer on, the printer displays copyright and format loading messages. Then you will see



Calibrating...

as the printer checks the supply. If the supply type is set to **Indexed** and indexed supplies are installed, the printer calibrates to determine the length of each label so the printed image is positioned correctly. If the supply type is set to **Non-Indexed** and non-indexed supplies are installed, the printer feeds out three inches of supply.

You will see another message as the printer loads formats. When the printer has completed the start up process, you will see



PRINT MODE  
Ready

**NOTE:** If you are using the printer for the first time, press  to display the Main Menu.

## Selecting a Function

### MAIN MENU



The Main Menu has several functions (operating modes). The Main Menu functions are shown in the chart below. Each operating mode has several other functions.

To display the menu options, press the arrow keys, as follows:

- When the screen displays a right arrow,



press  to display more options.

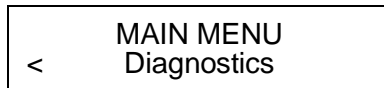

- When the screen displays a left arrow,



press  to display more options.

- When the screen displays a left arrow and a right arrow





press either  or  to display more options.

When you see the menu option you want, press  to select it. Use the arrow keys to display the operating mode options the same way you use them for the Main Menu.

## Exiting an Option

To exit an option, press  once. You will exit to the next higher menu.

**NOTE:** When you press , you lose any entries you have made since the last time you pressed .

# 3. Setting Supply Options

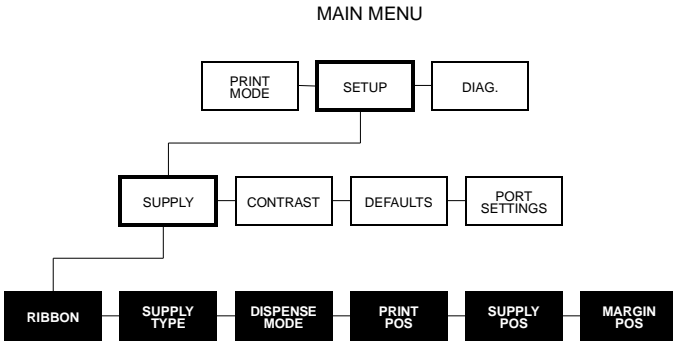

You may need to set supply options often to adjust for different supplies. The options are shown below with the default settings in bold.

- |                           |                   |                  |
|---------------------------|-------------------|------------------|
| 1. Ribbon Settings        | No                | <b>Yes</b>       |
| 2. Supply Type            | Non-indexed       | <b>Indexed</b>   |
| 3. Dispense Mode          | Continuous        | <b>On-demand</b> |
| 4. Adjust Print Position  | -999 to +999 dots | <b>+0</b>        |
| 5. Adjust Supply Position | -99 to +99 dots   | <b>+0</b>        |
| 6. Adjust Margin Position | -99 to +99 dots   | <b>+0</b>        |

## Finding the Supply Options

Follow these steps to position yourself in the menu system to be able to set supply options.

- From the Main Menu, press or until you see



2. Press . You will see



3. Press . You will see the first supply option.



To change one of these options, follow the instructions under the correct heading. To exit an option without changing the setting, press .



## Ribbon

You can print with or without a ribbon, but you have to tell the printer which option you want.

The default setting for ribbon is **Yes**. To change the setting, follow the steps under "Finding the Supply Options." Then follow the steps below.

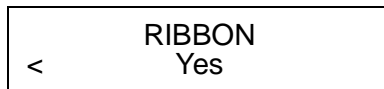
1. Press  to set the ribbon option. You will see the previous setting, for example



2. Press  or  until you see the option you want. Then press . You will see





3. Press  to exit to the Setup menu.

**NOTE:** If you set the Ribbon option to **Yes**, be sure you install a ribbon before printing.

4. Press  to exit to the Main Menu.

**NOTE:** After changing settings in the Setup Menu, always return to the Main Menu before turning your printer off. The printer will not save changes to these menus if you turn it off before returning to the Main Menu.

## Supply Type

You can use indexed or non-indexed supplies with the 9406 printer. These supplies are defined as follows:

- *Indexed supplies* have marks to indicate the specific length of each label. Supplies with an aperture or black mark are indexed supplies.
- *Non-indexed supplies* have no marks to indicate the specific length of the label.

The default setting for Supply Type is **Indexed**. To change the setting, follow steps listed under "Finding the Supply Options." Then follow the steps below.

1. Press  until you see





SUPPLY  
Supply Type

2. Press . You will see the previous setting, for example,





SUPPLY TYPE  
Indexed

3. Press  or  until you see the option you want. Then press . The printer calibrates to check the supply.

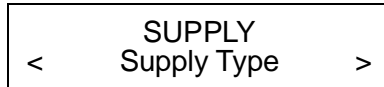
You will see



4. Press  to exit to the Setup menu.
5. Press  to exit to the Main Menu.

**NOTE:** After changing settings in the Setup Menu, always return to the Main Menu before turning your printer off. The printer will not save changes to these menus if you turn it off before returning to the Main Menu.

## Dispense Mode

You can print supplies in the following modes:

*On-demand*      Prints one label at a time.

*Continuous*      Prints one batch of labels at a time.

**NOTE:** The total print range (how close the printer starts from the top of the label) depends on the Dispense Mode you choose. For continuous printing, the total print range is plus or minus 45 mils (1 mil equals 1/1000 of an inch). For on-demand printing, it is plus or minus 65 mils.



The default setting for Dispense Mode is **On-demand**. To change the setting, follow steps listed under "Finding the Supply Options." Then follow the steps below.

1. Press  until you see



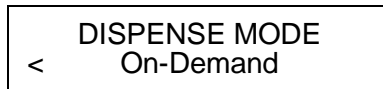

2. Press . You will see the previous setting, for example

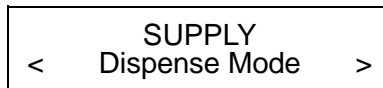

3. Press  or  until you see the option you want. Then press . You will see



4. Press  to exit to the Setup menu.
5. Press  to exit to the Main Menu.

**NOTE:** After changing settings in the Setup Menu, always return to the Main Menu before turning your printer off. The printer will not save changes to these menus if you turn it off before returning to the Main Menu.

### Continuous Mode Features

Regardless of the supply type, when you use continuous mode, the printer dispenses all but the last label or tag to the peel bar. The last one goes to the tear bar.

The printer does not stop between labels in continuous mode, but you can interrupt the batch. Press  in the middle of the batch to suspend printing and bring the printer to the Pause menu. Then, you can change the supply, printer values, etc. and resume printing (or cancel the batch). If you enter new values and resume printing, the printer finishes the current batch. It only uses the new values when you print another batch (unless described otherwise under that feature in this manual).

## Print Position

This function adjusts where data prints vertically on the supply. You can adjust the print if it is too close to the top or bottom of the supply, or goes over the pre-printed area ("MONARCH" in the sample below). The adjustments are in dots (0.0052 inch), which is the smallest measurement the printer recognizes. The range is from -999 to +999 (5.20 inches), and the default is 0.

**NOTE:** If you change this value in the middle of a batch, the change is immediate. It does *not* wait for the next batch to make the change. Alter the number as follows:

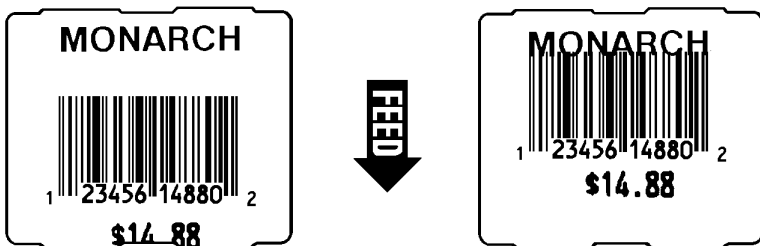

- If the data is too close to the *bottom* of the supply, increase the number.
- If the data is too close to the *top* of the supply, decrease the number.



The default setting for Print Position is **0**. To change the setting, follow the steps listed under "Finding the Supply Options." Then follow the steps below.

1. Press  until you see



SUPPLY  
Print Pos

2. Press . You will see the previous setting, for example

Enter print pos  
[+/-999]: +0

3. Use the arrow keys to change the print position. Pressing  increases the value (moves the image up);  decreases it (moves the image down).
4. Press  when the number you want is displayed. You will see

SUPPLY  
Print Pos

5. Press  to exit to the Setup menu.
6. Press  to exit to the Main Menu.

**NOTE:** After changing settings in the Setup Menu, always return to the Main Menu before turning your printer off. The printer will not save changes to these menus if you turn it off before returning to the Main Menu.

## Supply Position

This function adjusts how much supply feeds out of the exit chute. You may need to adjust the supply in or out to allow:

- Labels to be torn off
- Die cut labels to be removed easily, or to prevent them from falling off.

The range is -99 to +99, and the default is 0. The larger the number is, the more supply feeds out of the chute. The adjustments are in dots (0.0052 inch).

**NOTE:** If you change this value in the middle of a batch, the change is immediate. It does *not* wait for the next batch to make the change.



The default setting for Supply Position is **0**. To change the setting, follow the steps listed under "Finding the Supply Options." Then follow the steps below.

1. Press  until you see



<	SUPPLY Supply Pos	>
---	----------------------	---

2. Press . You will see the previous setting, for example

Enter supply pos [+/-99]: +0
---------------------------------

3. Use the arrow keys to change the supply position. Pressing  increases the value (feeds more supply);  decreases it (feeds less supply).
4. Press  when the number you want is displayed. You will see

<	SUPPLY Supply Pos	>
---	----------------------	---

5. Press  to exit to the Setup menu.
6. Press  to exit to the Main Menu.

**NOTE:** After changing settings in the Setup Menu, always return to the Main Menu before turning your printer off. The printer will not save changes to these menus if you turn it off before returning to the Main Menu.

## Margin Position

This function adjusts where the format prints horizontally on the supply. The adjustments are in dots (0.0052 inch), which is the smallest measurement the printer recognizes. The range is -99 to +99 (0.52 inches), and the default is 0.

**NOTE:** If you change the Margin position in the middle of the batch, the change does not occur until the next batch, except for variable data, such as incrementing or decrementing fields. The changes occur immediately in variable data fields.



**Print too far to the left.**

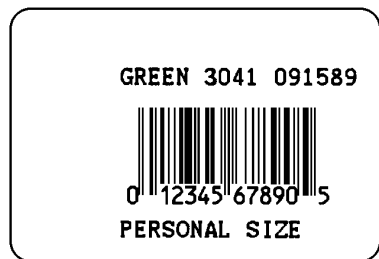

**Print too far to the right.**

Use the following rules of thumb as you set this position:

- If the data is too close to the *left* side of the supply, *increase* the number.
- If the data is too close to the *right* side of the supply, *decrease* the number.

The width of the print area is always four inches. When you move the image to the right or left on the supply, avoid moving the image outside the four inch print area.

As you move the format to the *right*, the fields that would move past the four inch location of the supply "wrap around" and appear on the left side. Other fields move the full length you specify. If your supply is less than 4 inches, fields might move off the supply and not print.

As you move the format to the *left*, fields that would move off the format stop at the 0.0" location of the supply. Other fields move the full length you specify. Making this change can alter the relative position of the fields.



The default setting for Margin Position is **0**. To change the setting, follow the steps listed under "Finding the Supply Options." Then follow the steps below.

1. Press  until you see

SUPPLY  
< Margin Pos



2. Press . You will see the previous setting, for example,

Enter margin pos  
[+/-99]: +0

3. Use the arrow keys to change the print position. Pressing  increases the value (moves the image toward the right side of the supply);  decreases it (moves the image toward the left side of the supply). Press the arrow key once to change by one number at a time.
4. Press  when the number you want is displayed. You will see

SUPPLY  
< Margin Pos



5. Press  to exit to the Setup menu.
6. Press  to exit to the Main Menu.

**NOTE:** After changing settings in the Setup Menu, always return to the Main Menu before turning your printer off. The printer will not save changes to these menus if you turn it off before returning to the Main Menu.



# 4. Setting Communication Values

---

You need to set the printer communication values to match your host's online communications. Before entering the communication values, see your System Administrator.

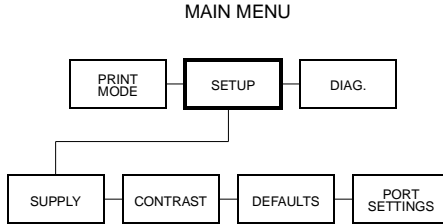

The communication values are shown below. The default values are in bold.

- Baud rate            1200, 2400, 4800, **9600**
- Word length        7 or **8**
- Stop bits            1 or 2
- Parity                Odd, Even, **None**
- Flow control        None, Xon/Xoff, **DTR**

## Finding Communication Value Options

Follow these steps to set communication values.

1. From the Main Menu, press  or  until you see



2. Press . You will see

SETUP Supply >
-------------------

3. Press  until you see

< SETUP Port Settings
--------------------------

4. Press . You will see the first communications option.

PORT SETTINGS Baud Rate >
------------------------------

To change one of these options, follow the instructions under the correct heading. To exit an option without changing the setting, press .

## Baud Rate



The default setting for Baud Rate is **9600**. To change the setting, follow the steps listed under "Finding Communication Value Options." Then follow the steps below.

1. Press  to set the baud rate. You will see the previous setting, for example



< BAUD RATE 2400 >
-----------------------

The options for baud rate are

1200  
2400  
4800  
9600

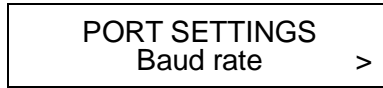
2. Press  or  to display the baud rate you need, then press . You will see



3. Press  to exit to the Setup menu.
4. Press  to exit to the Main Menu.

**NOTE:** After changing settings in the Setup Menu, always return to the Main Menu before turning your printer off. The printer will not save changes to these menus if you turn it off before returning to the Main Menu.

## Word Length

The default setting for Word Length is **8**. To change the setting, follow the steps listed under "Finding Communication Value Options." Then follow the steps below.

1. Press  until you see

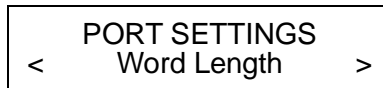

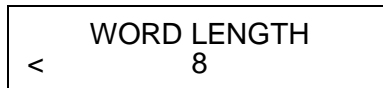

2. Press . You will see the previous setting, for example,





The options for Word Length are

7  
8

3. Press  or  to display the word length you need, then press . You will see



4. Press  to exit to the Setup menu.
5. Press  to exit to the Main Menu.

**NOTE:** After changing settings in the Setup Menu, always return to the Main Menu before turning your printer off. The printer will not save changes to these menus if you turn it off before returning to the Main Menu.

## Stop Bits

The default setting for Stop Bits is 1. To change the setting, follow the steps listed under "Finding Communication Value Options." Then follow the steps below.

1. Press  until you see

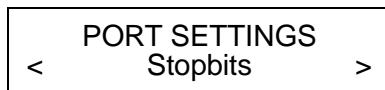



2. Press . You will see the previous setting, for example,





The options for Stop Bits are

- 1
- 2

3. Press  or  to display the number of stop bits you need, then press . You will see

PORT SETTINGS  
< Stopbits >

4. Press  to exit to the Setup menu.
5. Press  to exit to the Main Menu.

**NOTE:** After changing settings in the Setup Menu, always return to the Main Menu before turning your printer off. The printer will not save changes to these menus if you turn it off before returning to the Main Menu.

## Parity

The default setting for Parity is **None**. To change the setting, follow the steps listed under "Finding Communication Value Options." Then follow the steps below.

1. Press  until you see

PORT SETTINGS  
< Parity >

2. Press . You will see the previous setting, for example,



PARITY  
None >

The options for parity are

None  
Odd  
Even

3. Press  or  to display the parity you need, then press . You will see



4. Press  to exit to the Setup menu.
5. Press  to exit to the Main Menu.

**NOTE:** After changing settings in the Setup Menu, always return to the Main Menu before turning your printer off. The printer will not save changes to these menus if you turn it off before returning to the Main Menu.

## Flow Control

The default setting for Flow Control is **DTR**. To change the setting, follow the steps listed under "Finding Communication Value Options." Then follow the steps below.

1. Press  until you see





2. Press . You will see the previous setting, for example,



The options for flow control are

None  
XON/XOFF  
DTR





3. Press  or  to display the flow control you need, then press .

**NOTE:** The XON character is 17. The XOFF character is 19.

If you have an IBM personal computer, set flow control to DTR (unless you have XON/XOFF software).

You will see

PORT SETTINGS < Flow Control
---------------------------------

4. Press  to exit to the Setup menu.
5. Press  to exit to the Main Menu.

**NOTE:** After changing settings in the Setup Menu, always return to the Main Menu before turning your printer off. The printer will not save changes to these menus if you turn it off before returning to the Main Menu.

## Reset to Default Values

To reset the communication values to the defaults, follow the steps listed under "Finding Communication Value Options." Then follow the steps below.



1. Press  until you see

PORT SETTINGS < Reset
--------------------------

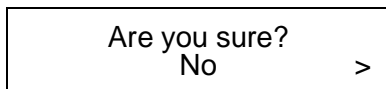
2. Press . You will see



3. You can:

- press  to exit without changing the values. You will return to the Port Setting menu.
- press  and then  to set the values to the defaults. You will see



4. Press  to exit to the Setup menu.

5. Press  to exit to the Main Menu.

**NOTE:** After changing settings in the Setup Menu, always return to the Main Menu before turning your printer off. The printer will not save changes to these menus if you turn it off before returning to the Main Menu.

6. Verify that the default settings are correct by printing Test Label 2 (the current communication parameters appear on the label). See "Printing a Test Label" in *Read This First*.

## 5. Setting the Contrast

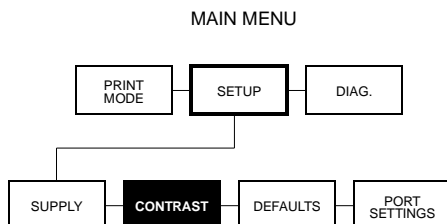

Contrast controls the darkness of the printing on your supply. The range is -50 to +50, and the default is 0. Use the following rules of thumb as you set the contrast:

- Darken the printing by *increasing* the number.
- Lighten the printing by *decreasing* the number.

Correct contrast setting is important because it affects how well your bar codes scan and how long your printhead lasts. To achieve maximum thermal printhead life, adjust the contrast setting for each printer and supply type when possible.

**NOTE:** If you change the contrast in the middle of a batch, the change occurs immediately. The printer will *not* wait until the next batch to make the change.

1. From the Main Menu, press  or  until you see



2. Press . You will see



3. Press  until you see

<          SETUP Contrast          >
---

4. Press . You will see the previous setting, for example

Enter contrast [+/-50]: +0
-------------------------------

5. Use the arrow keys to change the contrast. Pressing  *darkens* the print;  *lightens* the print.

6. Press  to select the displayed value. You will see

<          SETUP Contrast          >
---

7. Press  to exit to the Main Menu.

# 6. Setting Defaults

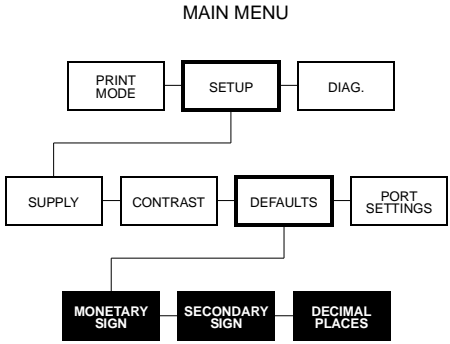

Some printer options can be set to fit your daily operation. The options are shown below. The factory setting is in bold.

- Monetary Sign    None, **USA**, UK, Japan, Germany, France, Spain, Italy, Sweden, Finland, Austria, India
- Secondary Sign    Yes, **No**
- Decimal Places    0, 1, **2**, 3

## Finding Default Options

Follow these steps to set the defaults.

1. From the Main Menu, press or until you see



2. Press . You will see

SETUP Supply >
-------------------

3. Press  until you see

< SETUP Defaults >
-----------------------

4. Press . You will see

< DEFAULTS Monetary Sign >
-------------------------------

To change one of these defaults, follow the instructions under the correct heading. To exit an option without changing the setting, press .

## Monetary Sign

Monetary signs are available for the following currencies:



USA	\$	(dollar)
UK	£	(pound)
Japan	¥	(yen)
Germany	DM	(Deutsche mark)
France	F	(franc)
Spain	Pta	(peseta)
Italy	£	(lira)
Sweden	Kr	(krona)
Finland	MK	(markka)
Austria	g	(schilling)
India	Rs	(rupee)

You can also select **None** if you do not want a monetary sign to print in price fields.



The default setting for Monetary Sign is **USA**. To change the setting, follow the steps listed under "Finding Default Options." Then follow the steps below.

1. Press . You will see the previous setting, for example

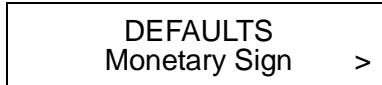

2. Press  or  until you see the country for the monetary sign you want.
3. Press . You will see



4. Press  to exit to the Setup menu.
5. Press  to exit to the Main Menu.

**NOTE:** After changing settings in the Setup Menu, always return to the Main Menu before turning your printer off. The printer will not save changes to these menus if you turn it off before returning to the Main Menu.

## Secondary Sign

If you select USA as the monetary sign, you can print amounts less than \$1.00 either by using a dollar sign and decimal (\$ .30) or by using a cent sign (30¢). Note the following facts:

- If you set the secondary sign option to *No*, prices under \$1.00 will print like this: \$ .45
- If you set the secondary sign option to *Yes*, prices under \$1.00 will print like this: 45¢

The same option applies to monetary signs other than USA.

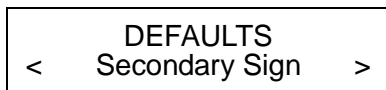

The default setting for Secondary Sign is **No**. To change the setting, follow the steps listed under "Finding Default Options." Then follow the steps below.

1. Press  until you see



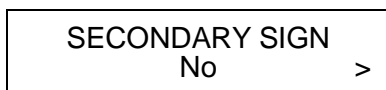

2. Press . You will see the previous setting, for example

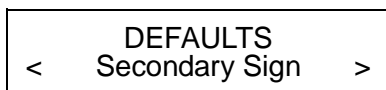

3. Press  or  until you see the option you want. Then press . You will see



4. Press  to exit to the Setup menu.
5. Press  to exit to the Main Menu.

**NOTE:** After changing settings in the Setup Menu, always return to the Main Menu before turning your printer off. The printer will not save changes to these menus if you turn it off before returning to the Main Menu.



## Decimal Places

You can set the printer for 0, 1, 2, or 3 places after the decimal in a price field. In U.S. currency, you might print prices like this

\$24.00 (2 decimal places)

or like this...

\$24 (0 decimal places)

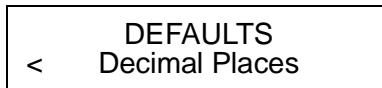

The default setting for Decimal Places is **2**. To change the setting, follow the steps listed under "Finding Default Options." Then follow the steps below.

1. Press  until you see



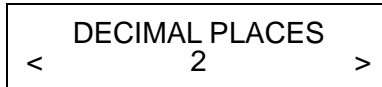

2. Press . You will see the previous setting, for example,

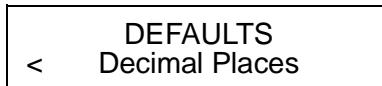

3. Press  or  until you see the option you want. Then press . You will see



4. Press  to exit to the Setup Menu.
5. Press  to exit to the Main Menu.

**NOTE:** After changing settings in the Setup Menu, always return to the Main Menu before turning your printer off. The printer will not save changes to these menus if you turn it off before returning to the Main Menu.



# 7. Printing Online

---

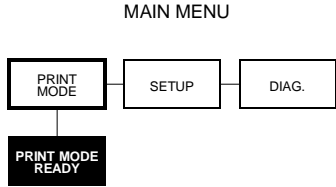

You can send format, batch, and graphic data streams to the printer from a host. When the printer receives the data, batches begin printing automatically. The *System Administrator's Guide* tells how to create, store, and download the data necessary to print batches.

Before you print online, you must:



- load the right supply (refer to your *Equipment Manual*)
- connect the host and printer
- set the communication values (see Chapter 4, "Setting the Communication Values")
- have format and batch data streams ready to download from the host (refer to the *System Administrator's Guide*).

Your printer is ready to receive and print batches as soon as you turn it on. You will see



Printing begins as soon as you download the format and batch data streams from the host.

If you have been using other printer functions, press  until you see the Main Menu. Then,

1. Press  or  until you see



2. Press  . You will see



Printing begins as soon as you download data from the host.

# Index

---

---

---

## A

---

Adjusting margin position 3-9  
Adjusting print position 3-6  
Adjusting supply position 3-8

---

## B

---

Baud rate 4-1

---

## C

---

Communication parameters  
    Baud rate 4-1  
    Parity 4-1  
    Start (Xon) character 4-1  
    Stop (Xoff) character 4-1  
    Stop bits 4-1  
    Word length 4-1  
Communications  
    Host port configuration 4-2  
    Resetting parameters 4-7  
    Resetting to defaults 4-7  
Continuous 3-4  
Contrast, setting 5-1  
Control keys 2-2

---

## D

---

Daily start up 2-3  
Decimal places, defining 6-4  
Defaults, printer 6-1, 6-3, 6-5

---

## E

---

Exiting an option 2-4

---

## F

---

Feed mode 3-4  
Function  
    selecting 2-4

---

## H

---

Host port configuration 4-2

---

## K

---

Keypad 2-2  
Keys  
    control 2-2

---

## M

---

Margin, adjusting 3-9  
Mode  
    Online 7-1  
Monetary sign, defining 6-2

---

## O

---

On-demand 3-4  
Online mode 7-1  
Option  
    Exiting 2-4  
    Selecting 2-4

---

## P

---

Parity 4-1  
Power switch 2-2  
Print  
    Online mode 7-1  
    Position, adjusting 3-6  
Print contrast, setting 5-1  
Print position, adjusting 3-6  
Printer defaults 6-1, 6-3, 6-5  
    Decimal places 6-4  
    Monetary sign 6-2  
    Ribbon 3-2 - 3-3  
    Secondary sign 6-3

---

## R

---

Resetting communications parameters 4-7  
Ribbon 3-2 - 3-3

---

---

## S

---

Secondary sign, using 6-3  
Selecting a function 2-4  
Setting communication parameters 4-1  
Setting supply options 3-1, 3-3, 3-5, 3-7, 3-9, 3-11  
Setting the contrast 5-1  
Setting the print contrast 5-1  
Start (XON) character 4-1  
Start Up 2-3  
Stop (XOFF) character 4-1  
Stop bits 4-1  
Supply  
    Position, adjusting 3-8  
Supply options  
    Adjust margin position 3-9  
    Adjust print position 3-6, 3-8  
    Setting 3-1, 3-3, 3-5, 3-7, 3-9, 3-11  
Supply position, adjusting 3-8

---

---

## W

---

Word length 4-1

---



For supplies, service, or assistance call:

**TOLL FREE:**

**1-800-543-6650 (In the U.S.A.)**

**1-800-263-4650 (In Canada)**