

MICROSCAN[®]

*MS-3000
Single Head Decoder
User's Manual*



Information and specifications in this manual are subject to change without notice.

Copyright © 1998

by Microscan Systems, Inc.,
1201 S.W. 7th Street, Renton, Washington, U.S.A. 98055
(425) 226-5700 FAX: (425) 226-8682

All rights reserved. The information contained herein is proprietary and is provided solely for the purpose of allowing customers to operate and/or service Microscan manufactured equipment and is not to be released, reproduced, or used for any other purpose without written permission of Microscan.

Throughout this manual, trademarked names might be used. Rather than put a trademark (™) symbol in every occurrence of a trademarked name, we state herein that we are using the names only in an editorial fashion, and to the benefit of the trademark owner, with no intention of infringement.

Microscan Limited Warranty Statement and Exclusions

What is Covered?

Microscan Systems Inc. warrants to the original purchaser that products manufactured by it will be free from defects in material and workmanship under normal use and service for a period of one year from the date of shipment. This warranty is specifically limited to, at Microscan's sole option, repair or replacement with a functionally equivalent unit and return without charge for service or return freight.

What is Excluded?

Any products or parts that have been subject to misuse, neglect, accident, unauthorized repair, improper installation, or abnormal conditions or operations. Any products or parts that have been transferred by the original purchaser. Customer mis-adjustment of settings contrary to the procedure described in the Microscan owners manual. Upgrading software versions at customer request unless required to meet specifications in effect at the time of purchase. Units returned and found to have no failure will be excluded. Claims for damage in transit are to be directed to the freight carrier upon receipt.

THIS EXPRESS WARRANTY EXCLUDES ALL OTHER WARRANTIES, EXPRESS OR IMPLIED, INCLUDING BUT NOT LIMITED TO, IMPLIED WARRANTIES OF MERCHANTABILITY AND FITNESS FOR PURPOSE. MICROSCAN SYSTEMS INC. SHALL NOT BE LIABLE FOR ANY SPECIAL, INCIDENTAL, OR CONSEQUENTIAL DAMAGES, WHETHER IN CONTRACT, TORT, OR OTHERWISE.

Some states do not allow the exclusion or limitation of incidental or consequential damages or limitations on an implied warranty, so the above limitation or exclusion may not apply to you. This warranty gives you specific legal rights, and you may also have other rights which may vary from state to state.

The buyer acknowledges that he/she is not relying on the seller's skill or judgment to select or furnish goods suitable for any particular purpose and that there are no warranties that extend beyond the description on the face hereof.

Before Requesting Service...

Please check the owners manual for proper setup and cabling procedures and any customer settings for mis-adjustment for your particular application. Correcting these may save you a service call.

To receive Warranty Service...

Contact your nearest Microscan Service Center at the address shown below for a Return Material Authorization (RMA) number before returning product. Receipt of an RMA number is not an admission of warranty status. All product must be returned freight prepaid to the location issuing the RMA number before the expiration of the warranty period.

Table of Contents

List of Illustrations	v
List of Tables.....	vi
About the MS-3000 Decoder	vi
About This Manual.....	vi
Keystroke Entries.....	vii
Approvals	vii
Warning and Caution Summary.....	vii
Safety Labels	viii
Chapter 1 Setup and Installation	
Step 1 - Plan Scanning System	1-2
Step 2 - Attach Cabling.....	1-3
Step 3 - Configure Decoder	1-10
Step 4 - Position Scan Head and Label.....	1-10
Step 5 - Do Read Rate Test.....	1-11
Step 6 - Install Decoder	1-12
Ground and Shield Considerations.....	1-14
Chapter 2 Menu Configuration	
Communications Menu	2-5
Operations Menu	2-13
Code Types Menu.....	2-22
User Outputs Menu.....	2-29
Raster Setup Menu.....	2-33
Chapter 3 Serial Configuration	
Summary of Serial Configuration Commands.....	3-2
Concatenating Serial Commands	3-4
Serial Command Status Request.....	3-4
Loss of Communications.....	3-4
Trigger Filter Timing Value.....	3-5
Communications Commands.....	3-6
Operations Commands.....	3-10
Code Types Commands	3-12
User Outputs Commands	3-14
Raster Setup Commands.....	3-17

Chapter 4	Profile Card Configuration	
	Summary of MS-3000 Modes.....	4-2
	Operating Instructions	4-3
	General Settings.....	4-4
	Communications Settings.....	4-6
	Operations Settings.....	4-8
	Code Types Settings	4-11
	User Outputs Settings	4-11
Chapter 5	Operational Commands	
	Summary of Operational Commands.....	5-2
	Program Management Commands	5-3
	Device Control Commands.....	5-3
	Code Type Commands.....	5-4
	Counter Commands	5-4
	Test Commands	5-5
	Status Commands.....	5-5
	Master Label Commands	5-5
Appendices		
	Appendix A — Decoder Specifications.....	A-2
	Appendix B — ASCII Table	A-3
	Appendix C — Defaulting the Decoder.....	A-4
	Appendix D — Troubleshooting.....	A-6
	Appendix E — Interfacing with the MS-90 Scan Head.....	A-9
	Appendix F — Bar Code Symbology.....	A-11
	Appendix G — Interface Standards.....	A-12
	Appendix H — Auxiliary Monitor.....	A-13
	Appendix I — Multidrop Communications.....	A-17
	Appendix J — Glossary of Terms.....	A-21

List of Illustrations

Figure 1-1 System Diagram	1-2
Figure 1-2 Front Panel	1-3
Figure 1-3 Trigger Connector Socket	1-4
Figure 1-4 Trigger Connector Wiring Diagram (untriggered)	1-5
Figure 1-5 Decoder to Scan Head	1-5
Figure 1-6 Rear Panel of MS-3000 Decoder	1-6
Figure 1-7 Power Connector Socket	1-6
Figure 1-8 LAN Connector	1-7
Figure 1-9 Host Connector	1-9
Figure 1-10 DTE and DCE Host Connections	1-9
Figure 1-11 Monitor Connector	1-9
Figure 1-12 Bottom Mounting Diagram (not full size)	1-12
Figure 1-13 Mounting Diagram (without housing, not full size)	1-13
Figure 1-14 Grounding Diagram, Decoder-Host	1-14
Figure 2-1 Configuration Program - Main Menu	2-2
Figure 2-2 Communications Menu Structure	2-5
Figure 2-3 Operations Menu Structure	2-13
Figure 2-4 External Level Trigger Signals	2-15
Figure 2-5 External Edge Trigger Signals	2-15
Figure 2-6 Match Code Logic Diagram	2-20
Figure 2-7 Code Types Menu Structure	2-22
Figure 2-8 User Outputs Menu Structure	2-29
Figure 2-9 Raster Setup Menu Structure	2-33
Figure 2-10 Raster Sweep Arc	2-33
Figure 4-1 Profile Card	4-3
Figure A-1 MS-2000	A-2
Figure A-2 MS-3000	A-2
Figure A-3 Profile Card Default Setting	A-4
Figure A-4 Host Connector Default Pins	A-5
Figure A-5 MS-90 User Outputs Menu (with Label Speed Option)	A-9
Figure A-6 Typical Multidrop Network	A-17
Figure A-7 Polling Sequence	A-18
Figure A-8 Select Sequence	A-19

List of Tables

Table 1-1 Cable Distances	1-3
Table 1-2 Trigger Connector Pin Assignments	1-4
Table 1-3 Power Connector Pin Assignments	1-6
Table 1-4 LAN Connector Pin Assignments	1-7
Table 1-5 Host Connector Pin Assignments	1-8
Table 1-6 Monitor Connector Pin Assignments	1-9
Table 2-1 Raster Settings	2-33
Table 3-1 Summary of Serial Configuration Commands	3-2
Table 3-2 Protocol Commands	3-7
Table 4-1 Profile Card Mode Descriptions	4-2
Table 4-2 Calculating Binary Conversion	4-13
Table 5-1 Summary of Operational Commands	5-2
Table A-1 Status Lights	A-2
Table A-2 ASCII Table with Control Characters	A-3
Table A-3 Troubleshooting Table	A-6
Table A-4 Label Speeds for Code 39 in Inches per Second	A-10
Table A-5 Label Speeds for Code 128 in Inches per Second	A-10
Table A-6 Multidrop Address Characters	A-20

About the MS-3000 Decoder

The MS-3000 single head decoder, companion to Microscan's MS-520 and MS-1200 scan heads, is designed to accept high speed bar code data from a scan head, translate that data into alphanumeric characters, and send that data to a host or other terminal.

About This Manual

This manual provides complete information on setting up and installing the MS-3000 decoder.

Chapter 1 provides overall step-by-step instructions for setting up and installing the MS-3000 decoder with specific "go to" references to other chapters and appendices.

Chapter 2 provides instructions for configuring the MS-3000 decoder by menu.

Chapter 3 provides instructions for configuring the MS-3000 decoder by serial command.

Chapter 4 describes serial operational commands that can be used by the host.

For specifications, see appendix A. The appendices also include reference tables, as well as other useful information relating to bar coding and the MS-3000 decoder.

Keystroke Entries

Keystrokes to be entered from your terminal are highlighted in bold, as in **<D>**, including a < left angle bracket symbol (unless redefined by Command Start Character command) and followed by a > right angle bracket symbol.

Approvals

- UL (Underwriters Laboratories, Inc.)
- CSA (Canadian Standards Association)
- TÜV (Technischer Überwachungs-Verein) European models must use a similarly rated Class 1 or Class 2 power supply that is certified with the standard for Safety EN 60950:1992 + A2:1993 or A3:1995.
- FCC (Federal Communication Commission)
- This Class A digital apparatus meets all requirements of the Canadian Interference-Causing Equipment Regulations.
Cet Appareil numérique de la classe A respecte toutes les exigences du Règlement sur le matériel brouilleur du Canada.

Warning and Caution Summary

Caution: *There are no user serviceable parts in the MS-3000 decoder. Opening the decoder voids the Microscan Systems warranty.*

Note: *The MS-520 and MS-1200 scan heads are designed to be connected to the MS-3000 decoder. When installed, direct current power for the scan head is provided by the decoder.*

Caution: *This equipment has been tested and found to comply with the limits for a Class B digital device, pursuant to part 15 of the FCC Rules. These limits are designed to provide reasonable protection against harmful interference when the equipment is operated in a commercial environment. This equipment generates, uses, and can radiate radio frequency energy, and, if not installed and used in accordance with the instruction manual, may cause harmful interference to radio communications. Operation of this equipment in a residential area is likely to cause interference in which case the user will be required to correct the interference at his or her own expense.*

Note: *For connection to a listed direct plug-in power unit marked Class 2 and rated at +12 VDC regulated @ 40 mA maximum, -12 VDC regulated @ 40 mA maximum, +5 VDC regulated @ 300 mA maximum.*

Safety Labels

The following labels are found on the bottom of the MS-3000:

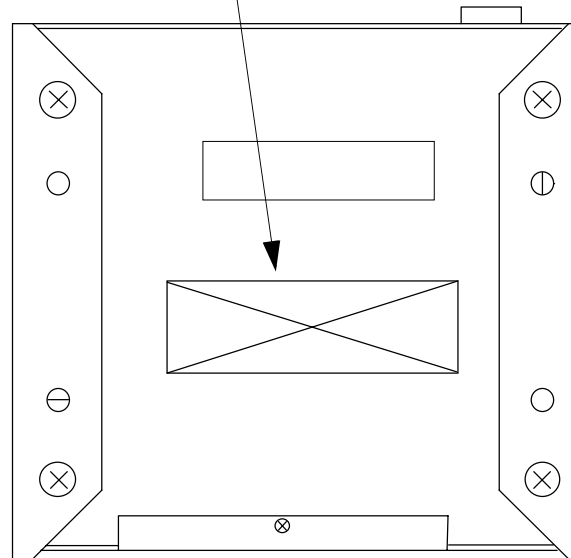
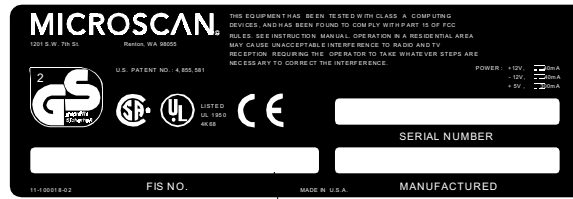

Chapter 1

Setup and Installation

Chapter Contents

Step 1 - Plan Scanning System.....	1-2
Step 2 - Attach Cabling	1-3
Step 3 - Configure Decoder.....	1-10
Step 4 - Position Scan Head and Label	1-10
Step 5 - Do Read Rate Test.....	1-11
Step 6 - Install Decoder.....	1-12
Ground and Shield Considerations	1-14

This chapter provides step-by-step instructions for setting up and installing the 3000 single head decoder.

Note: Bar code labels should meet minimum ANSI (American National Standards Institute) standards as specified in ANSI Bar Code Print Quality Guideline, X3.182-1990.

1 Plan Scanning System

Before installing the MS-3000 decoder you should sketch out a diagram of your scanning system, showing equipment, connector and cable types, and cable lengths.

Figure 1-1 shows a possible scanning system setup. There are six I/O connectors on the MS-3000 decoder: the 25-pin host connector (see figure 1-9 on page 1-9), a 6-pin trigger connector (see figure 1-4 on page 1-5), the 5-pin power connector (see figure 1-7 on page 1-6), the modular RJ-45 scan head connector (see figure 1-5 on page 1-5), the modular RJ-11 LAN connector (see figure 1-8 on page 1-7), and the 9-pin monitor connector (see figure 1-11 on page 1-9).

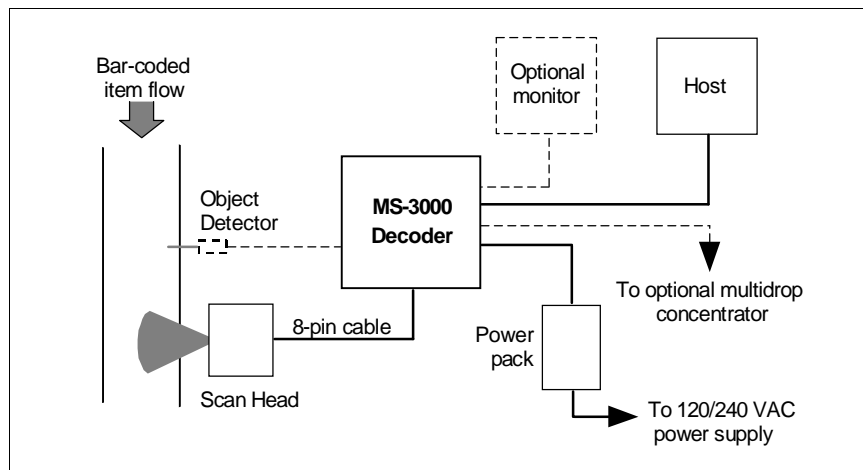

Figure 1-1 System Diagram

2 Attach Cabling

Under ideal conditions, maximum cable lengths can match the distances shown in table 1-1. However, since cable lengths and sizes are dictated by local conditions such as wire size, wire shape (flat or round), shielding, grounding, extraneous signal noise, etc., maximum cable distances will vary.

Table 1-1 Cable Distances

Cabling	Maximum Distance
RS-232 Decoder to Host	50 ft. (15.2 m)
RS-422 Decoder to Host	4000 ft. (1219 m)
Decoder to Scan Head	15 ft. (4.57 m)
RS-485 Multidrop Trunk	4000 ft. (1219 m)
RS-485 Multidrop Drop	10 ft. (3 m)

Front Panel Connectors

The MS-3000 decoder has six I/O connectors. On the front panel (figure 1-2) there are the following two connectors:

- Trigger (Microscan or other object detector) (6-pin DIN socket)
- Scan head (modular RJ-45)

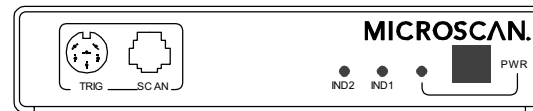

Figure 1-2 Front Panel

Trigger Connector

The trigger connector (TRIG) is a 6-pin DIN socket (figure 1-3) that mates with a 240 degree 6-pin DIN plug. Pin assignments are shown in table 1-2.

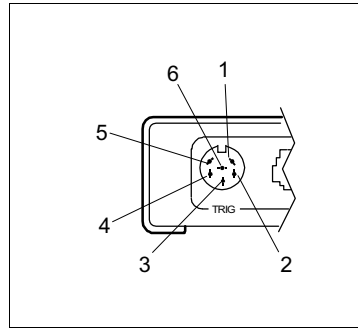

Figure 1-3 Trigger Connector Socket

Table 1-2 Trigger Connector Pin Assignments

Pin	Function
1	Trigger Input +3 VDC to + 24 VDC
2	TTL Relay driver output signal 5 VDC
3	+5 VDC
4	+12 VDC
5	Ground
6	Not used

Pin 1 is the input from the object detector. When operating the decoder in external trigger mode, a toggle at this pin causes the decoder to begin a read cycle.

Pin 2 of the trigger connector is a programmable relay driver. The MS-3000 software can be programmed to set this pin high or low upon a good read, a no read, a good match, or a mismatch. This pin can source or sink 4 mA (maximum) and can be used to drive a small relay to operate an alarm, diverter, etc.

Microscan offers an optical object detector (P/N 99-440001-03) that plugs directly into this connector and a user-customized trigger port connector (P/N 20-600090-02).¹

Figure 1-4 shows examples of positive and negative external trigger inputs that could be applied to the trigger connector. (Shown in untriggered state.)

1. Trigger sources other than the Microscan object detector can be used. Mechanical switches, relays, etc.—which tend to be slow and bouncy and produce multiple trigger signals—are not recommended unless equipped with optical sensors or filtered transitions (optical, Hall effect, or DC solid state relays).

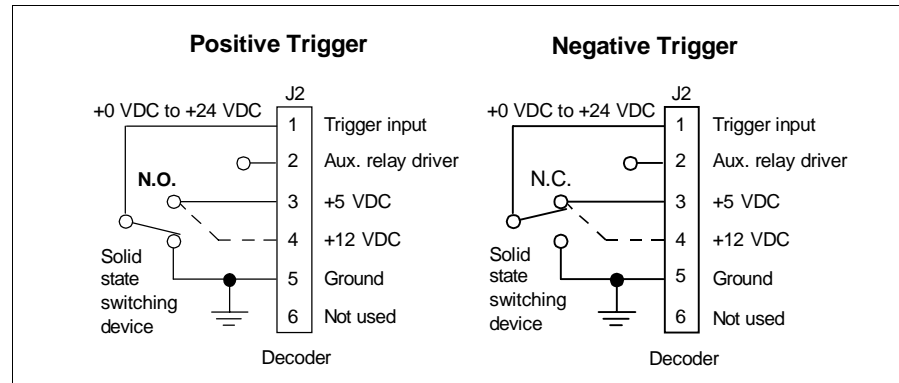

Figure 1-4 Trigger Connector Wiring Diagram (untriggered)

Scan Head Connector

To prevent voltage loss, cables between decoder and scan head should not exceed 15 feet (4.57 m) unless wire sizes exceed the minimum 26 AWG. Figure 1-5 shows a MS-3000 decoder connected to a Microscan MS-500 scan head.

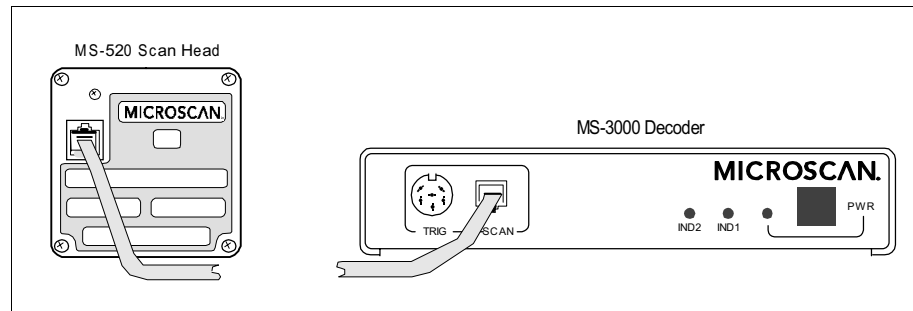

Figure 1-5 Decoder to Scan Head

Back Panel Connectors

On the rear panel (figure 1-6) there are the following four connectors:

- a. Power (5-pin DIN socket)
- b. LAN (modular RJ-11)
- c. Host (25-pin D-subminiature socket)
- d. Monitor (9-pin D-subminiature socket)

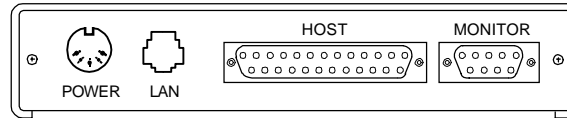

Figure 1-6 Rear Panel of MS-3000 Decoder

Power Connector

The power connector (figure 1-7) has a 5-pin DIN socket with pin assignments shown in table 1-3.

You may also supply the required DC voltages yourself. A mating connector (Switchcraft #05BL5M plug) is required.

Caution: Switching power supplies for Microscan equipment with a switching noise of 20 mV or greater with ± 12 VDC are not recommended due to excessive ripple characteristics.

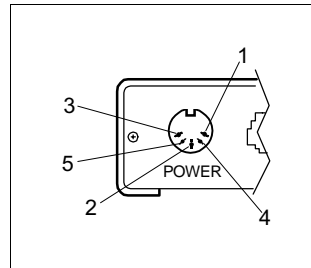

Figure 1-7 Power Connector Socket

Table 1-3 Power Connector Pin Assignments

Pin	Function
1	DC Ground
2	Chassis Ground
3	+5 VDC
4	-12 VDC
5	+12 VDC

LAN Connector

The Local Area Network (LAN) connector allows the MS-3000 decoder to communicate with a multidrop concentrator via a 4-wire cable (preferably shielded) with a 6-pin, 6-wire, RJ-11 type connector. Pin assignments are as shown in table 1-4. The LAN connector is used when a MS-3000 decoder is configured for RS-485 multidrop communications.

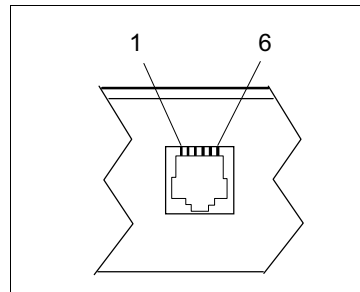

Figure 1-8 LAN Connector

Table 1-4 LAN Connector
Pin Assignments

Pin	Function
1	Ground
2	Receive Data (+)
3	Receive Data (-)
4	Transmit Data (+)
5	Transmit Data (-)

For proper operation of RS-485 multidrop communications, the main cable should not exceed 4000 feet, with each drop no more than 10 feet. The Microscan MS-5000 multidrop concentrator can support up to 50 decoders or other multidrop devices on one RS-485 line. Note that the last device must be terminated correctly. RS-485 pinouts are also available at the host connector.

Host Connector

The host connector (figure 1-9 on page 1-9), a 25-pin D-subminiature socket, allows the decoder to be connected to a host, a concentrator, or other communications device such as a PLC (programmable logic controller), a monitor, a PC, a relay, a diverter, an alarm, etc.

Note: All Microscan products are configured as DTE at the host connector when in RS-232 operation.

Caution: Do not use a host cable with more wires connected than are required for the application. The host connector of the decoder has many outputs that could cause damage or interfere with normal operation if connected and improperly used.

Table 1-5 Host Connector Pin Assignments^a

Pin	Function	Comment
1	Chassis ground	connected to dc ground
2	Transmit data	+12v data output from the decoder
3	Receive data	±12v signal indicating data from the host to the decoder
4	Request-to-send	±12v signal asserted high by the decoder when it has data to send to the host
5	Clear-to-send	±12v signal asserted low by the host to stop the decoder from sending data to it (data transmission will resume when the signal is asserted high.)
6	TTL 5V signal	indicates a good read
7	Signal Ground	connected to chassis ground
8	TTL 5V signal	indicates a noread
9	+5 VDC	auxiliary supply
10	Trigger input	+0 VDC to +24 VDC
11	Default (reset)	resets decoder to default configuration
12	Aux Input	(future use)
13	RXD +	RS-422/485
14	TXD –	RS-422/485
16	RXD –	RS-422/485
19	TXD +	RS-422/485
20	+12 VDC	data terminal ready (asserted high on power-up to indicate decoder is on)
21	Profile Card Input	
22	Signal Ground	
23	–12 VDC	
24	+12 VDC	
25	Match Code	next label read as master label, if enabled

a. The default communications mode does not support pin 4 (RTS). If RTS is not required by the host port, pin 4 should not be wired as the results will be unpredictable.

A good read will cause a 5V signal (high or low) to be output to pin 6. A noread will cause a 5V signal (high or low) to be output to pin 8.

Caution: There must be ±12V present before the decoder will transmit data to the host. However, the decoder can receive commands without the presence of either voltage.

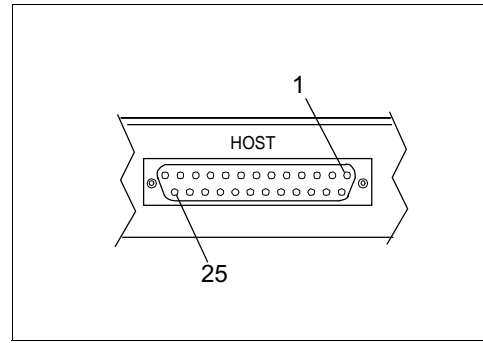

Figure 1-9 Host Connector

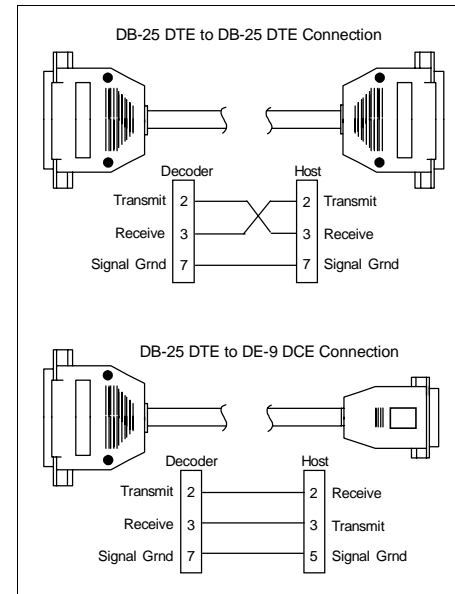

Figure 1-10 DTE and DCE Host Connections

Monitor Connector

The monitor connector (auxiliary terminal) connects the decoder to an auxiliary monitor via a 9-pin D-subminiature socket and cable. Table 1-6 shows auxiliary terminal pin assignments. Communication at this connector is RS-232 only.

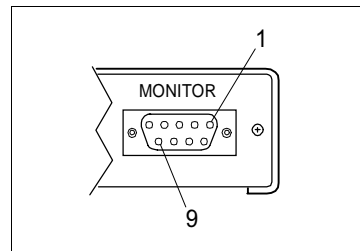

Figure 1-11 Monitor Connector

Table 1-6 Monitor Connector Pin Assignments

Pin	Function
2	Receive Data (in)
3	Transmit Data (out)
5	Signal Ground

3 Configure Decoder

Settings for Communications, Operations, Code Types, and User Outputs and Raster Setup are stored in non-volatile memory and can be configured by menu, serial command, or profile card commands.

For explanations of configuration settings, see Chapter 2, “Menu Configuration.”

To establish communications you will need to match the host's or auxiliary terminal's communication settings with your decoder's settings (see Communications Menu” on page 2-5). Also make certain that the code type enabled in the decoder matches that of the label being used (see Code Types Menu” on page 2-22).

Hint: Sending the <P> command will allow your scan head to read all of the listed code types.

Communicating with an ASCII Terminal

The MS-3000 decoder communicates in full duplex, terminal mode with no handshake. It also recognizes carriage returns and line feeds.

The host or ASCII terminal must match the following default settings before any communication can take place: **9600** Baud Rate, **Seven** Data Bits, **Even** Parity, and **One** Stop Bit.

A PC or Macintosh computer can be used as a dumb terminal if connected as shown in table 1-5 on page 1-8 and running a communications program set to the above defaults. See your computer user's manual for communication's port pinouts.

4 Position Scan Head and Label

Before testing, you will need to position the scan head and label in a manner that matches as nearly as possible the actual conditions of your application. Consult your scan head user's manual for important setup specifications.

5 Do Read Rate Test

This test calculates the percentage of scans decoded. It is useful during setup procedures to help optimize scan head-to-label orientation.

- a. Place the label used in your application in front of the scan head and within the desired read range.

Note: Ensure that the label being scanned is of a code type enabled in the decoder's software.

Hint: Read rates are easier to read on the screen if Postamble is enabled.

- b. Select from the ESP Utilities menu or send a <C> command to the decoder to start testing (see the "Enter Read Rate Test" command on page 5-5).

A percentage number from 0 to 100 will be displayed on the monitor in the read rate test indicating the ratio of good reads per total number of scans.

- c. Find the correct read rate area by moving the label in and out and right and left while observing read rate on the monitor.

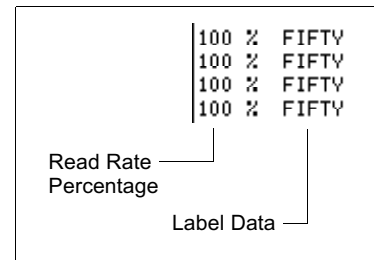

Avoid the specular reflection area (see scan head user's manual).

- d. Record the range area measurements and file the test results for future reference.

If the results are not satisfactory, reposition or re-configure the decoder or choose a different narrow-bar-width label size.

- e. Select from the ESP Utilities menu or send a <J> command to the decoder when testing is complete (see the "Exit Read Rate Test" command on page 5-5).

6 Install Decoder

The MS-3000 decoder can be mounted temporarily using the four rubber pads, or permanently, as follows:

- Position the decoder in a dry place.
- Before mounting, ensure that there is at least a 3 inch (76.2 mm) clearance at the rear and front of the decoder for the connectors and cables being used.
- Use the measurements provided in figure 1-12 to locate centers of mounting holes and drill four 5/32 inch or four 4 mm holes.
- Secure decoder with four 6-32 screws of the appropriate length.

Caution: Make certain that mounting screws do not penetrate into the decoder case more than .175 in. (4.4 mm) or damage to the decoder could result.

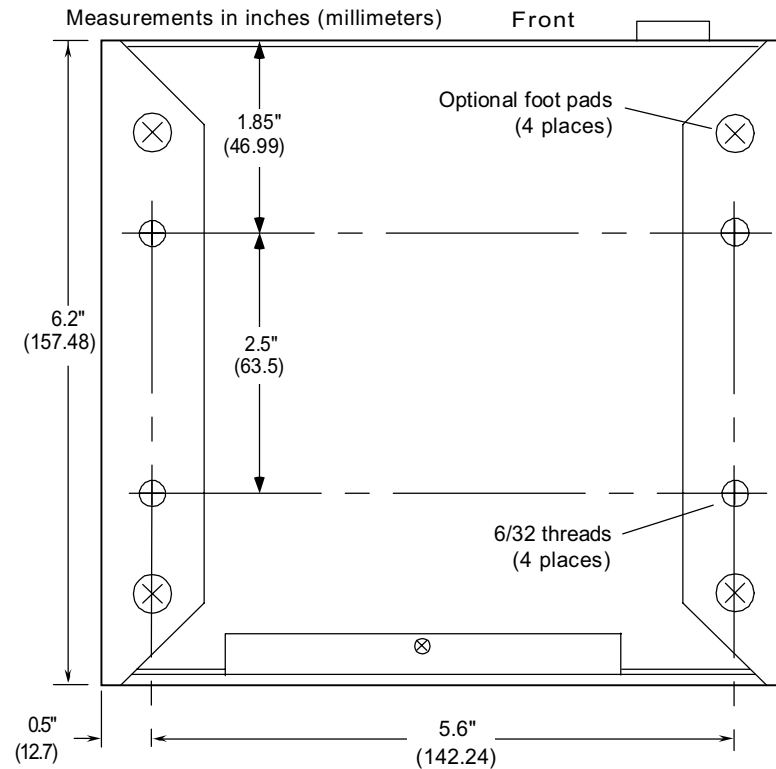

Figure 1-12 Bottom Mounting Diagram (not full size)

If the unit does not have housing, use the measurements provided in figure 1-13 to locate the centers of the mounting holes.

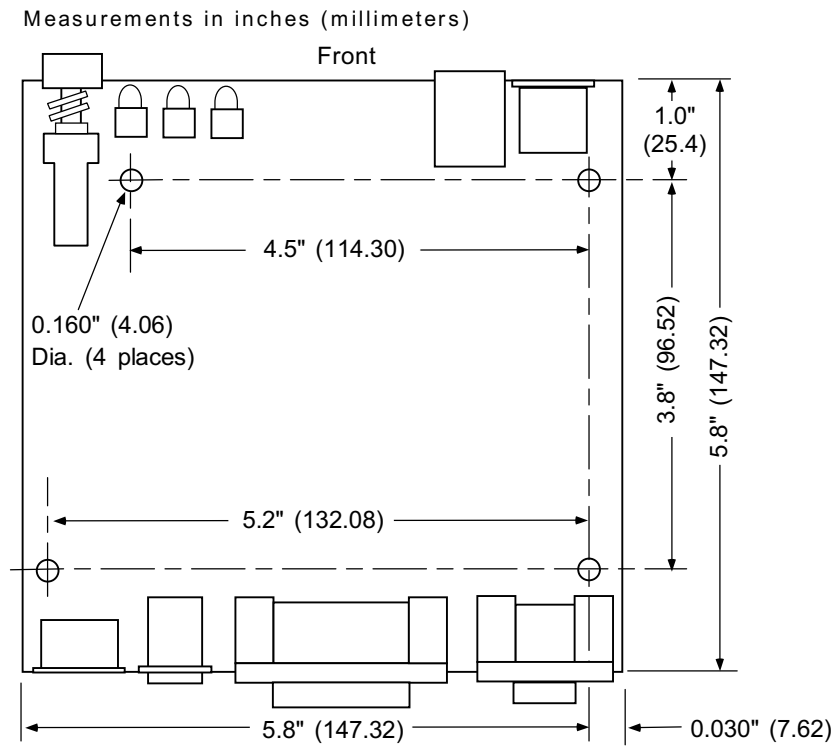

Figure 1-13 Mounting Diagram (without housing, not full size)

Ground and Shield Considerations

Proper grounding is necessary for operator safety, noise reduction, and the protection of equipment from voltage transients. Buildings—including any steelwork, all circuits, and all junction boxes—must be grounded directly to an earth ground in compliance with local and national electrical codes.

RS-232 signals have a common signal ground (pin 7 of the 25-pin connector). Pin 7 is normally connected to pin 1 (chassis ground) in the decoder; however, under certain conditions (e.g., when potential differences exist between power outlet grounds) signal and chassis grounds can be isolated from each other inside the decoder by Microscan technicians.

Any data line, as necessary, can be shielded. If shielding is used, isolate it from the decoder and ground only to the host earth ground.

Noise Interference

Noise interference can be minimized if cabling subject to noise interference is twisted and/or shielded or encased in grounded conduit, and the conduit or shielding (“drain” line) is grounded only to earth ground at the host, as shown in figure 1-14. You might need to examine and if necessary cut the shielding connection at or near the concentrator cable connector.

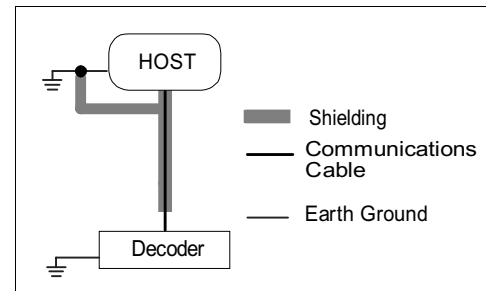

Figure 1-14 Grounding Diagram, Decoder-Host

Ground Loops

Ground loops, signal degradation due to different ground potentials in communicating devices, can be eliminated or minimized by ensuring that the host, concentrator, and their power supplies are connected to a common earth ground.

Chapter 2

Menu Configuration

Chapter Contents

Communications Menu	2-5
Operations Menu	2-13
Code Types Menu.....	2-22
User Outputs Menu.....	2-29
Raster Setup Menu.....	2-33

This chapter describes how to configure the MS-3000 decoder with on screen menu commands from a host or auxiliary terminal.

All keystrokes are in **bold** typeface.

Default parameters in the menu structures are also in **bold** typeface.

All of these parameters, with the exception of Full Screens, can also be changed by serial commands (see Chapter 3, "Serial Configuration").

In addition, most of these configuration parameters can also be changed with a Microscan profile card (P/N 99-500011-01), obtainable from your Microscan representative (see Chapter 4, "Profile Card Configuration").

Communicating with an ASCII Terminal

The MS-3000 decoder communicates in full duplex, terminal mode with no handshake. It also recognizes carriage returns and line feeds.

The host or ASCII terminal with must match the following default settings before any communication can take place: **9600** Baud Rate, **Seven** Data Bits, **Even** Parity, and **One** Stop Bit.

Entering the Menu Configuration Program

To see the Main menu (figure 2-1), from an ASCII terminal that is connected to the decoder, send the serial command **<D>** (enter the **< >** brackets as well as the upper case **D**).¹

2-Menu Config.

```
MICROSCAN SYSTEMS, INC.
CONFIGURATION PROGRAM
MAIN MENU
35-213001-XX
-----
TOPICS                DESCRIPTIONS
1) COMMUNICATIONS     HOST PROTOCOL, HOST PORT, AND AUX PORT.
2) OPERATIONS         TRIGGERING, TIMEOUTS, ETC.
3) CODE TYPES         CODE SELECTIONS, CODE LENGTHS, ETC.
4) USER OUTPUTS      BEEPER, DATA LINE POLARITY, ETC.
5) RASTER SETUP       RASTER TOP ANGLE, BOTTOM ANGLE AND SPEED.
-----
ESC = MAIN MENU OR EXIT  N = NEXT ITEM
M  = PREVIOUS MENU      SP = NEXT ITEM
B  = PREVIOUS ITEM      CR = THIS ITEM
-----
MAIN--> COMMUNICATIONS
```

Figure 2-1 Configuration Program - Main Menu²

If the menu does not appear, see Appendix D, “Troubleshooting,” on page A-6.

Using the Menu Configuration Program

The bottom line on the screen is called the command line. The command line identifies your place in the menu program, shows current status and allows you to review and change options. Use the designated keys³ to scroll to and select the parameter you wish to change; press **SP** (space bar key) or **N** to scroll ahead, **B** to scroll back, **CR** (carriage return key) to select, and **M** to return to the previous higher level menu. To return to the Main menu at any time, press **ESC** (escape key) and **M**.

1. Command start character by default is a left angle bracket, **<**. It may be redefined by menu or serial command. However, the end character, a right angle bracket, **>**, cannot be changed.
2. Item 5, Raster Setup, applies only to the MS-1280 raster scan head.
3. The menu navigational keys are displayed in each menu.

For example, to enable LRC (see figure 2-2, “Communications Menu Structure,” on page 2-5 and “Longitudinal Redundancy Check” on page 2-10), you would use the following command line path:

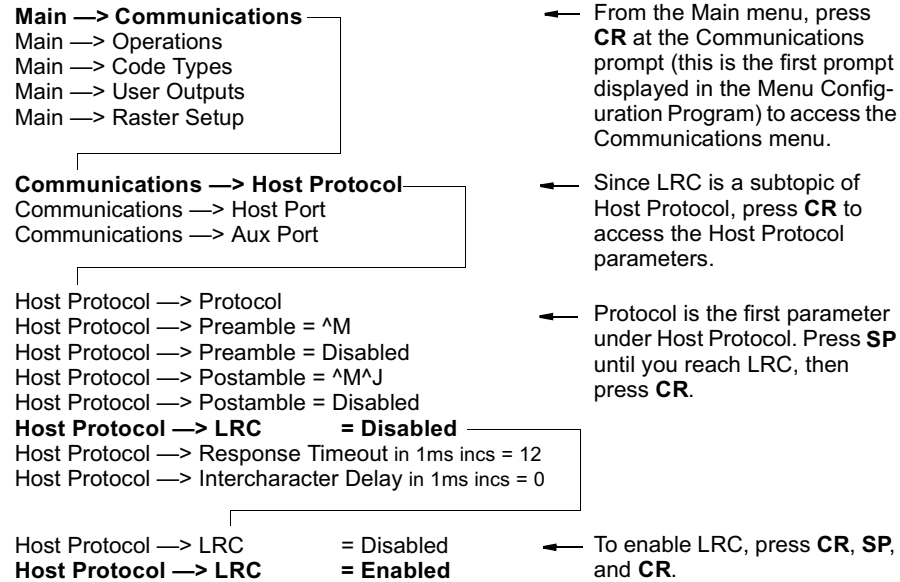

To view LRC’s new status in the menu, press **M** to refresh the screen. To return to the Main menu, press **M** again. You can make additional changes within another menu before exiting the program. Simply follow the same method of scrolling to and selecting each main topic, then its subtopics, until you reach the parameter you want to change. Remember, to return to the Main menu at any time, press **ESC** (escape key) and **M**.

Some parameters are user defined, in which case they prompt you with an arrow for data, such as:

```
OPERATIONS--> TIMEOUT in 10ms increments = 100 -->
```

At the prompt, redefine the parameter within the allowable range, and press **CR** to enable.

Saving Menu Changes

Press ESC (escape key) to see the following on the command line:

```
EXIT OR MAIN MENU (E,M)
```

Press M to return to the Main menu, or press E to exit the Menu Configuration program. If E is pressed, the following question will appear:

```
Do you want to save changes for power on ? (Y=yes N=no)
```

Press N to exit without saving changes, or press Y to retain the current settings to non-volatile RAM for power up. If Y is selected, a beep will indicate the save has been carried out.

Loss of Communications

Defaulting might be necessary if communications between the decoder and another device are interrupted or if using incompatible equipment (for example, a terminal is set to communicate at 9600 baud, but the decoder is configured at 38.4K baud). Communication can also be lost if an address has been assigned to the decoder.

To reset parameters to default values, see Appendix C, "Defaulting the Decoder," on page A-4.

Defining Special Characters

To define any control character from the ASCII table : Press **SP** once, then enter the control character by holding down the control key and simultaneously pressing the desired character. For example to define a line feed, press **SP**, then **Control** and **J** simultaneously. It is displayed as ^J on the command line and as <LF> in the menu when the screen is refreshed.

To define CR as a character: Press **SP**, then **CR**. It is displayed as ^M on the command line and as <CR> in the menu when the screen is refreshed.

To define a space as a character: Press **SP** twice. It is displayed as a blank space in the menu when the screen is refreshed. While it appears that nothing has been assigned, the hex value 20 will be sent during data transmission.

To select NUL as the character: Press **SP**, then a **0** (zero). It is displayed as <NUL> in the menu when the screen is refreshed.

Communications Menu

The Communications menu allows you to set the communication protocols between the decoder and the host.

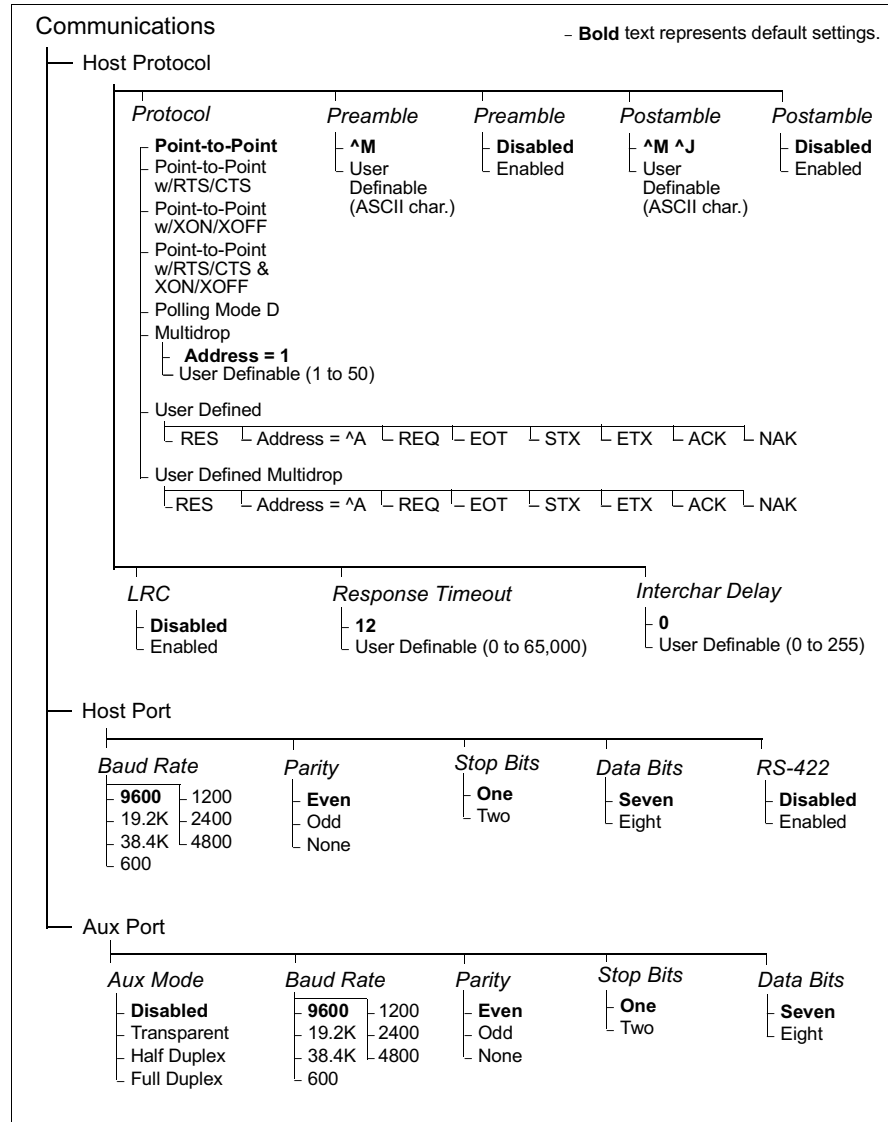

2-Menu Config.

Figure 2-2 Communications Menu Structure

There are three subtopics in this menu: Host Protocol, Host Port, and Aux Port. To help visualize the menu's organization and to locate the page number where each topic is described, see figure 2-2, "Communications Menu Structure," on page 2-5.

Note: Changes in Communications parameters or assigning an address to the decoder can cause loss of communications with the configuration terminal when you exit the menu program (whether or not changes are saved for power-on).

Host Protocol Parameters

Protocol

Default: Point-to-Point

Options: Point-to-Point, Point-to-Point with RTS and CTS, Point-to-Point with XON/XOFF, Point-to-Point with RTS/CTS and XON/XOFF, Polling Mode D, Multidrop, User Defined, User Defined Multidrop

Protocols define the sequence and format in which information is transferred between devices. Generally there are two basic protocol modes: unpolled and polled. In unpolled mode (all of the Point-to-Point protocols), a device sends information without being asked for by the host. In polled mode (Multidrop, Polling Mode D, and User Defined Multidrop), a device has an address and waits for a request from the host before sending data.

Note: User Defined and User Defined Multidrop have more options available to them. Selection instructions for these protocols are provided under each topic.

Selecting:	Has this effect:
Point-to-Point	Has no address and sends data to the host (RS-232) whenever it is available and without any request or handshake from the host.
Point-to-Point with RTS/CTS (Request-to-Send/Clear-to-Send)	Used only with RS-232. This is a simple handshaking protocol that allows a device to initiate data transfers to the host with an RTS (request-to-send) transmission. The host, when ready, responds with a CTS (clear-to-send) and the data is transmitted. RTS and CTS signals are transmitted over two dedicated wires (pins 4 and 5) as defined in the RS-232 standard.

<i>Selecting:</i>	<i>Has this effect:</i>
Point-to-Point with XON/XOFF (Transmitter On/Off)	Used only with RS-232 or RS-422. This selection enables the host to send a single byte transmission command of start (XON) or stop (XOFF). If an XOFF has been received from the host, data will not be sent to the host until the host sends an XON. During the XOFF phase, the host is free to carry on other chores and accept data from other devices.
Point-to-Point with RTS/CTS and XON/XOFF	Used only with RS-232. It is a combination of Point-to-Point with RTS/CTS and Point-to-Point with XON/XOFF.
Polling Mode D	Like Point-to-Point, Polling Mode D requires a separate connection to the host but unlike Point-to-Point, it requires the device to have an address and to wait for a poll from the host before sending data. When in Polling Mode D, an address 1 is automatically displayed on the configuration screen. However, during transmission, a 1C hex poll address (FS) and a 1D hex select address (GS) are substituted for the 1.
<p>Multidrop^a</p> <p>Note: <i>Decoders intended to link up to a MS-5000 multidrop concentrator can only be configured in standard Multidrop protocol.</i></p> <p>Hint: <i>Attach a tag to each decoder to identify its multidrop address.</i></p>	<p>Similar to Polling Mode D except that a unique poll address and select address are required for each multidrop device, and only one host port connection is needed for up to 50 devices. (For Multidrop poll and select characters, see Table A-6, "Multidrop Address Characters," on page A-20.)</p> <p>Requires a concentrator or controller using RS-485 communications. When Multidrop is selected, the protocol characters for RES, REQ, etc. are assigned automatically. (See "Appendix I — Multidrop Communications" on page A-17 for poll and select sequences.)</p>

<i>Selecting:</i>	<i>Has this effect:</i>
<p>User Defined</p> <p>Note: <i>A specific ASCII character must not be assigned more than once.</i></p>	<p>Used only with RS-232 or RS-422. ASCII characters can be assigned as an address and as protocol commands (RES, REQ, EOT, STX, ETX, ACK, and NAK). User Defined is necessary when a new protocol must be defined to match a specific host protocol. When User Defined is selected, the displayed protocol commands match those of the previously selected protocol. User Defined is considered to be in a polled mode only if an address has been assigned. The address can be any ASCII character from the ASCII in appendix B, except NUL.^b</p>
<p>User Defined Multidrop</p> <p>Note: <i>A specific ASCII character must not be assigned more than once.</i></p>	<p>Used when connecting to a concentrator or other device that does not match standard Multidrop protocol.</p> <p>Any single character (01 hex to 7E hex) in the ASCII table can be assigned as the address character. The character chosen is used as the poll character and the subsequent ASCII character becomes the select character. For example, if a ^A (01 hex) is selected as the address, ^B (02 hex) becomes the select address that the host will use in sending host select commands. (See Table A-1, "Multidrop Communications," on page A-17.)</p>

- a. Once the decoder is configured for Multidrop, a profile card, a terminal connected to the auxiliary RS-232 pins, or a default procedure must be used to access the configuration menus again (although serial commands will continue to function).
- b. For example a simple ACK/NAK protocol can be developed by first selecting Point-to-Point, then User Defined, and then assigning characters to ACK and NAK commands. First scroll to the following command:
 HOST PROTOCOL --> PROTOCOL --> USER DEFINED--> ACK = -->
 Enter a ^F by holding down the **Control** key while pressing the **F** key, and then press **CR** to see the following:
 HOST PROTOCOL --> PROTOCOL --> USER DEFINED--> ACK = ^F
 The mnemonics ACK and NAK replace the default NULs in the menu.

Note: *Definitions of commands in User Defined and User Defined Multidrop must be duplicated in host applications to enable poll and select sequences to execute correctly during transmission.*

Typically, parameters in User Defined Multidrop are defined by first enabling Multidrop, then enabling User Defined Multidrop. This pre-loads Multidrop characters into the parameters. You then change individual characters to match the host or other requirements.

Preamble

Default: *^M (and a null). Corresponds to <CR><NUL> (carriage return/null) displayed in the menu.*

Options: *Any ASCII character, including control characters. Control characters entered on the command line are displayed in the menu as mnemonic characters. See “Defining Special Characters,” on page 2-4 and table A-2 on page A-3.*

Allows you to define a one or two character data string that can be added to the front of the decoded data. For example, a carriage return and line feed would display each decoded message on its own line.

If User Defined, Polling Mode D, or Multidrop is enabled, the Preamble and Postamble characters are transmitted within the STX and ETX data block.

Preamble (enable/disable)

Default: *Disabled*

Options: *Disabled, Enabled (within any protocol)*

Allows you to enable or disable the preamble character(s).

Postamble

Default: *^M^J. Corresponds to <CR><LF> (carriage return/line feed) displayed in the menu.*

Options: *Any ASCII character, including control characters. Control characters entered on the command line are displayed in the menu as mnemonic characters. See “Defining Special Characters,” on page 2-4 and Table A-2, “ASCII Table with Control Characters,” on page A-3.*

Allows you to define a one or two character data string that can be added after the decoded message.

If User Defined, Polling Mode D, or Multidrop is enabled, the Postamble and Preamble characters are transmitted within the STX and ETX data block.

Postamble (enable/disable)

Default: *Disabled*

Options: *Disabled, Enabled (within any protocol)*

Allows you to enable or disable the Postamble character(s).

Longitudinal Redundancy Check

Default: Disabled (in unpolled mode), Enabled (in polled mode)

Options: Disabled, Enabled

An error-checking routine that verifies the accuracy of transmissions. It is the exclusive OR of all characters following the SOM (start of message) up to and including the EOM (end of message).

Response Timeout

Default: 12 ms

Options: 0 to 65,000 ms. A zero (0) causes an indefinite wait.

Allows you to set the time the decoder will wait before timing out if ACK, NAK, and ETX are enabled, and a host response is expected.

Intercharacter Delay

Default: 0. Corresponds to 0 ms displayed in the menu.

Options: 0 to 255. A zero (0) causes no delay between characters.

Allows you to set the time interval in milliseconds between individual characters transmitted from the decoder to the host. A high setting will significantly slow down communications. For example, a 200 setting will result in a 1/5 second delay between each character that is transmitted.

Host Port Parameters

Allows you to set parameters for host port communications.

Baud Rate

Default: 9600

Options: 9600, 19.2K, 38.4K, 600, 1200, 2400, 4800

Allows you to set the number of bits transmitted per second.

NOTE: Due to timing considerations, polled modes require 2400 baud or faster.

Parity

Default: Even

Options: Even, Odd, None

Allows you to select an error detection routine in which one data bit in each character is set to 1 or 0 so that the total number of 1 bits in the data field is even or odd.

Stop Bits

Default: One

Options: One, Two

Allows you to select the last one or two bits in each character to indicate the end of the character.

Data Bits

Default: Seven

Options: Seven, Eight

Allows you to establish the total number of bits in each character.

RS-422

Default: Disabled

Options: Disabled, Enabled

Note: *Used only in Point-to-Point protocol only, and not with RTS/CTS.*

Whenever RS-422 is disabled, RS-232 is enabled in the background.

However, when Multidrop is enabled, the functioning protocol is RS-485 regardless of the displayed status of RS-422 in the menus. Before enabling RS-422, first double-check that Multidrop is not enabled. (See "Protocol," on page 2-6.)

(See Appendix G, "Interface Standards," on page A-12 for additional information on RS-422.)

Aux Port Parameters

Aux Port (auxiliary port) allows you to set communications settings between the decoder and an auxiliary monitor. An auxiliary monitor can be used to configure the menus, send data to the host, and display data transmissions originating from the host or decoder.

Note: *Aux Port operates in RS-232 only. See Appendix H, "Auxiliary Monitor," on page A-13 for a full description of auxiliary port options.*

Aux Mode

Default: Disabled

Options: Disabled, Transparent, Half Duplex, Full Duplex

Aux Mode (auxiliary mode) allows you to select a communications mode for auxiliary operations (see Appendix H, “Auxiliary Monitor,” on page A-13).

Other Aux Port Parameters

The other Aux Port parameters—Baud Rate, Parity, Stop Bits, and Data Bits—are identical to the host port parameters and are changed in the same manner (see page 2-10).

Note: *The Aux Port baud rate should never exceed Host Port baud rate or auxiliary port data could be lost.*

Operations Menu

The Operations menu allows you to set the operations parameters for the decoder.

To help visualize the menu's organization and to locate the page number where each topic is described, see figure 2-3.

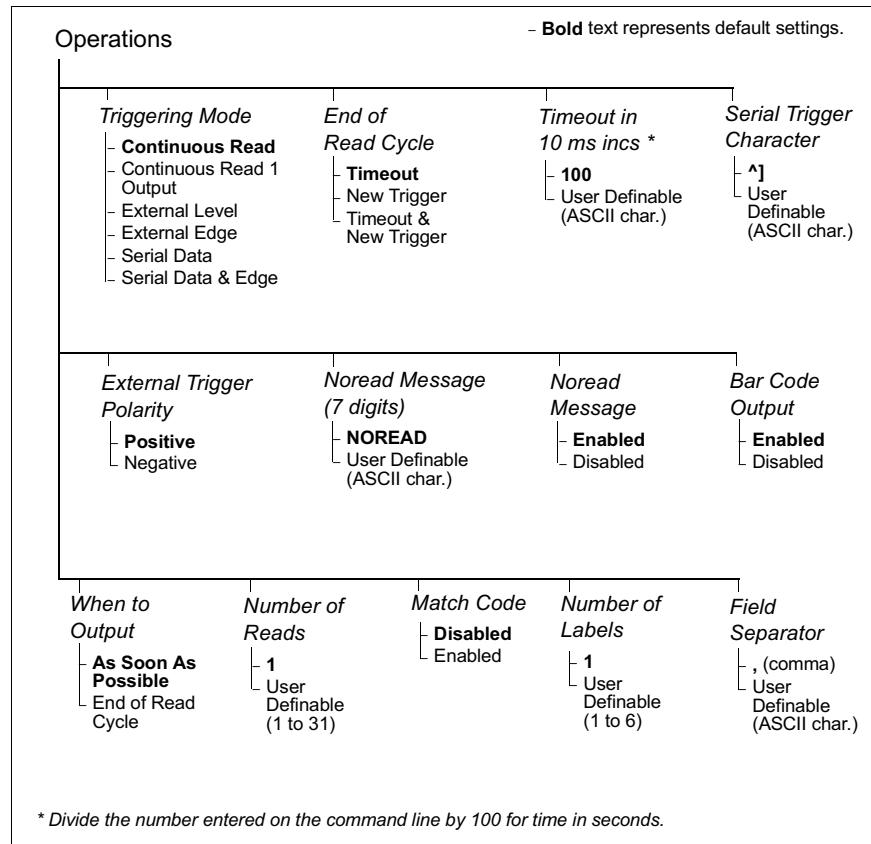

2-Menu Config.

Figure 2-3 Operations Menu Structure

Triggering Mode

Default: Continuous Read

Options: Continuous Read, Continuous Read 1 Output, External Level, External Edge, Serial Data, Serial Data & External Edge

Allows you to establish the type of trigger event that will initiate or end the read cycle. (See “End of Read Cycle” on page 2-16.)

<i>Selecting:</i>	<i>Has this effect:</i>
<p>Continuous Read</p> <p>NOTE: <i>If Continuous Read is enabled with Match Code, the decoder defaults to Continuous Read 1 Output mode.</i></p>	<p>Trigger input options are disabled and the decoder is always in the read cycle. Bar code data is decoded, and label information is transmitted repeatedly, as long as the label is in the range of the scan head. When To Output options have no affect on Continuous Read. Continuous Read is useful in testing label or scan head functions.</p>
<p>Continuous Read 1 Output^a</p> <p>NOTE: <i>Enabling Continuous Read 1 Output when Number of Labels (page 2-21) is set to any number greater than one will cause Number of Labels to default back to one.</i></p>	<p>Label data is immediately transmitted with Timeout enabled for End Of Read Cycle. If the label doesn't change, the decoder will repeat the output at the end of each subsequent timeout period. For example, if Timeout were set to one second, the decoder would output the label data immediately, and then repeat the output at intervals of one second, for as long as the label continued to be scanned.</p> <p>With Timeout disabled (that is, End Of Read Cycle set to New Trigger), the decoder will output the current label data immediately, but output it only once. A new label appearing at any time in the scan range will produce a new read output as long as the new label is not identical to the previous label.</p>
<p>External Level</p>	<p>Allows a read cycle to be initiated by a trigger signal from an object detector when an object appears within the detector's range. The read cycle endures until the object moves out of the detector's range (figure -4 on page -15), unless a timeout occurs and Timeout is enabled for End of Read Cycle (page 2-16).^b</p>

Selecting:	Has this effect:
External Edge	As with Level, Edge allows a read cycle to be initiated by a trigger signal from an object detector when it detects the appearance of an object (rising edge). But unlike Level mode, the removal of an object (falling edge) does not end the read cycle. With Edge enabled, the read cycle ends with a good read, a timeout, or a new trigger (figure -5).
Serial Data	The decoder accepts an ASCII character from the host or controlling device as a trigger to start a read cycle.
Serial Data & External Edge	The decoder accepts either an external trigger or a serial ASCII command to start a read cycle.

a. Continuous Read 1 Output will allow an output regardless of how Good Decode Read is set.
 b. *Level* and *Edge* apply to the active logic state (positive or negative) that exists while the object is in a read cycle, between the rising edge and falling edge. For the purpose of this discussion, *rising edge* is the trigger signal associated with the appearance of an object and *falling edge* is the trigger signal associated with the subsequent disappearance of the object.

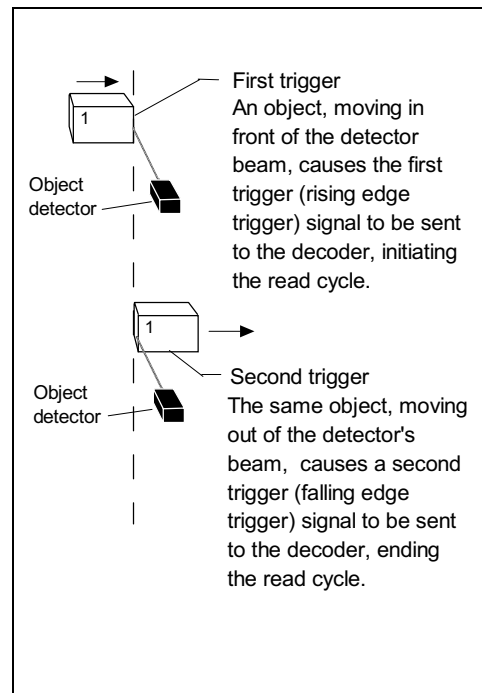

Figure 2-4 External Level Trigger Signals

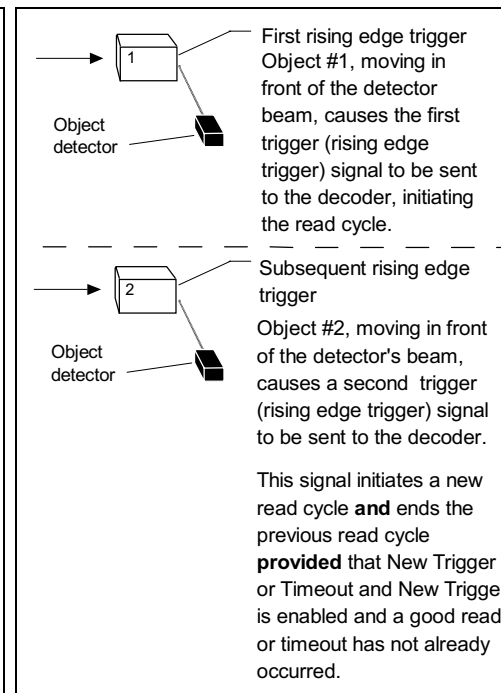

Figure 2-5 External Edge Trigger Signals

End of Read Cycle

Default: Timeout

Options: Timeout, New Trigger, Timeout & New Trigger

Allows you to choose the conditions that will end the read cycle. The read cycle is the time during which the decoder will receive and process label data. When the Triggering Mode option is set in an External or Serial mode of operation, the trigger event initiates the read cycle.

Note: *The Aux Port baud rate should never exceed Host Port baud rate or auxiliary port data could be lost.*

<i>Selecting:</i>	<i>Has this effect:</i>
Timeout	<p>Can end the read cycle after a specified period of time, and if no label has been read, causes a noread message, if enabled, to be transmitted.</p> <p>With either External Edge, Serial Data, or Serial Data & Edge enabled, a timeout ends the read cycle.</p> <p>With External Level enabled, the read cycle does not end until the falling edge trigger occurs, and the next read cycle does not begin until the next rising edge trigger.</p> <p>With Continuous Read 1 Output enabled, a timeout initiates a new read cycle and allows the same label to be read again.</p>
New Trigger	<p>Ends the read cycle at the occurrence of a new trigger event, and if no label has been read, causes a noread message, if enabled, to be transmitted at the occurrence of the new trigger event.</p> <p>With either External Edge, Serial Data, or Serial Data & Edge enabled, an edge or serial trigger ends a read cycle and initiates the next read cycle.</p> <p>With External Level enabled, a falling edge trigger ends a read cycle. However, the next read cycle does not begin until the occurrence of the next rising edge trigger.</p>

<i>Selecting:</i>	<i>Has this effect:</i>
Timeout & New Trigger	<p>Ends the read cycle after a specified period of time or at the occurrence of new trigger event, and if no label has been read, causes a noread message, if enabled, to be transmitted.</p> <p>With either External Edge, Serial Data, or Serial Data & Edge enabled, a timeout, or an edge or serial trigger, whichever comes first, ends the read cycle. An edge or serial trigger also initiates a new read cycle.</p> <p>With External Level enabled, the read cycle does not end until the occurrence of a falling edge, and the next read cycle does not begin until the next rising edge trigger.</p>

Timeout (in 10 ms incs)

Default: 100 (one second). Corresponds to 1000 ms displayed in the menu.

Options: 0 to 65535. Divide the number entered on the command line by 100 for time in seconds.

Note: Timeout or Timeout & New Trigger under End of Read Cycle (page 2-16) must be enabled for Timeout (in 10 ms incs) to take effect.

Allows you to define the duration of the timeout period.

Serial Trigger Character

Default: ^]. Corresponds to <GS> displayed in the menu.

Options: Any single ASCII character, including control characters, except a NUL (00H), an existing host command character,¹ or an on-line protocol character. Control characters entered on the command line are displayed in the menu as mnemonic characters. See “Defining Special Characters” on page 2-4 and Table A-2, “ASCII Table with Control Characters,” on page A-3.

Note: Serial Data (page 2-15) or Serial Data & Edge (page 2-15) must be enabled for Serial Trigger Character to take effect. “N/A” is displayed in the menu when all other triggering modes are enabled.

Allows you to define a single ASCII character as the host serial trigger character that initiates the read cycle. The serial trigger is considered an on-line host command and requires the same command format as all host commands (that is, to be entered within the < > brackets).

1. For example, assigning an upper case D would nullify the <D> (Enter Menu Configuration) command. For a list of operational commands used by the decoder, see table A-1 on page 5-2

External Trigger Polarity

Default: Positive

Options: Positive, Negative

Note: External Level (page 2-14), External Edge (page 2-15), or Serial Data & Edge (page 2-15) must be enabled for External Trigger Polarity to take effect. "N/A" is displayed in the menu when all other triggering modes are enabled.

Allows you to determine whether a positive or negative transition will initiate the read cycle.

Note: If using the Microscan object detector (P/N 99-440001-03), use positive trigger polarity.

Noread Message

Default: NOREAD

Options: Up to seven ASCII characters (except a NUL).

Allows you to define any combination of ASCII characters (except a NUL) up to seven characters as the noread message.

The noread message, if enabled and if no bar code label has been decoded, will be transmitted to the host at a timeout or the end of a read cycle.

Noread Message (enable/disable)

Default: Enabled

Options: Enabled, Disabled

Note: If Noread Output is enabled, the noread message will only output if Bar Code Output is also enabled.

Allows you to enable or disable the noread message.

Bar Code Output

Default: Enabled

Options: Enabled, Disabled

Allows you to choose whether or not to send label data (or noreads) to the host. When disabled, a label is decoded and the read cycle transpires as usual, but neither label data nor the noread message is transmitted to the host. All decoder counters are updated, and the number of good reads or noreads can be obtained via operational commands.

When to Output

Default: As Soon As Possible

Options: As Soon As Possible, End of Read Cycle

Allows you to choose when bar code data is sent to the host.

Selecting: Has this effect:

As Soon As Possible	Causes bar code data (good reads) to be transmitted immediately upon a good decode.
End of Read Cycle	Causes bar code data output to be delayed until the end of the read cycle.

Number of Reads Before a Good Decode

Default: 1

Options: 1 to 31

Allows you to select the number of good reads (from 1 to 31) required per label before a good decode output.

Note: Be sure to set the value within the determined scan rate for the scanning setup so that the decoder is capable of scanning a label the required number of times.

Match Code

Default: Disabled

Options: Disabled, Enabled

Note: A triggered mode (page 2-14 to page 2-15) must be enabled for Match Code to take effect.

Note: *If Match Code is enabled with Continuous Read, the decoder defaults to Continuous Read 1 Output mode, and the label data must change before the decoder will output data again, unless a timeout, if enabled, occurs.*

Note: *Enabling Match Code when Number of Labels is set to any number greater than one will cause Number of Labels to default back to one.*

Allows you to enter a master label into the decoder's memory to be compared with subsequently scanned labels.

2-Menu Config.

With Match Code enabled, a master label can be entered in three ways:

1. With New Master Pin enabled (see page 2-31), toggling pin 25 to ground (pin 7) enables the next good read to be the master label.
2. Sending serial command <G> enables the next good read to be the master label.
3. Sending serial command <)XXXX)> downloads data as master label. (Master label data is entered in place of the Xs.)

Figure 2-5 shows the sequence of operation (and reference) for setting up and entering master labels.

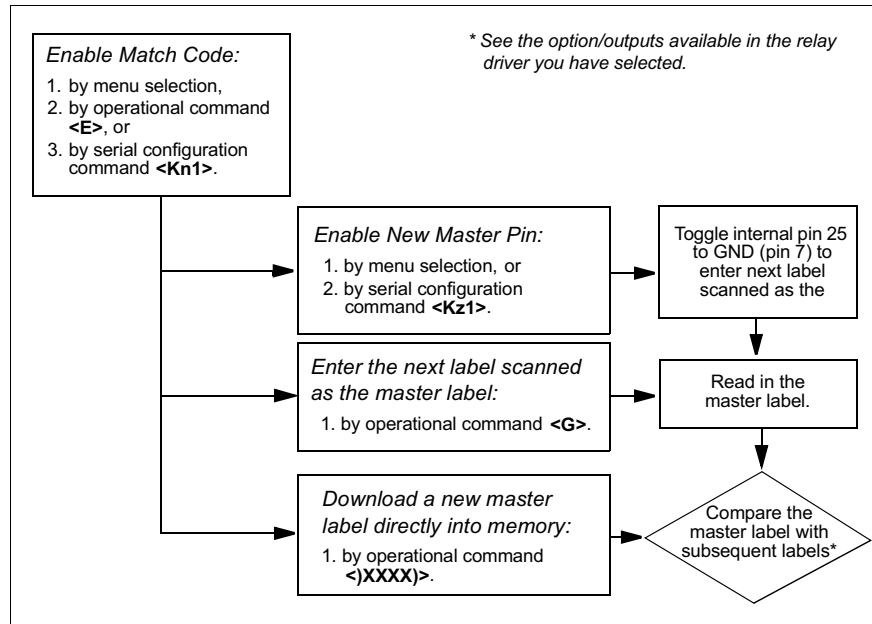

Figure 2-5 Match Code Logic Diagram

Number of Labels

Default: 1

Options: 1 to 6

Note: If Number of Labels is set to any number greater than one while Match Code or Continuous Read 1 Output is enabled, Number of Labels will default back to one.

Allows you to choose the number of different labels that will be read in a single trigger event. The labels can be a mix of any of the enabled bar code symbologies and more than one label can be decoded per scan line.

The following conditions apply:

1. Each label must be different to be read.
2. The maximum number of characters in any one label is 31.
3. The maximum number of characters in a single scan line is 62.
4. The maximum number of characters for all labels is 128, including preamble and postamble and all spaces and commas.
5. All noread messages are posted at the end of the data string.
6. If more than one label is within the scan beam at the same time, label data may not be displayed in the order of appearance.

Field Separator

Default: , (comma)

Options: Any available ASCII character, except NUL.

Allows you to choose the separator character to be inserted between labels.

Code Types Menu

The Code Types menu allows you to choose among five bar code types and define their parameters.

2-Menu Config.

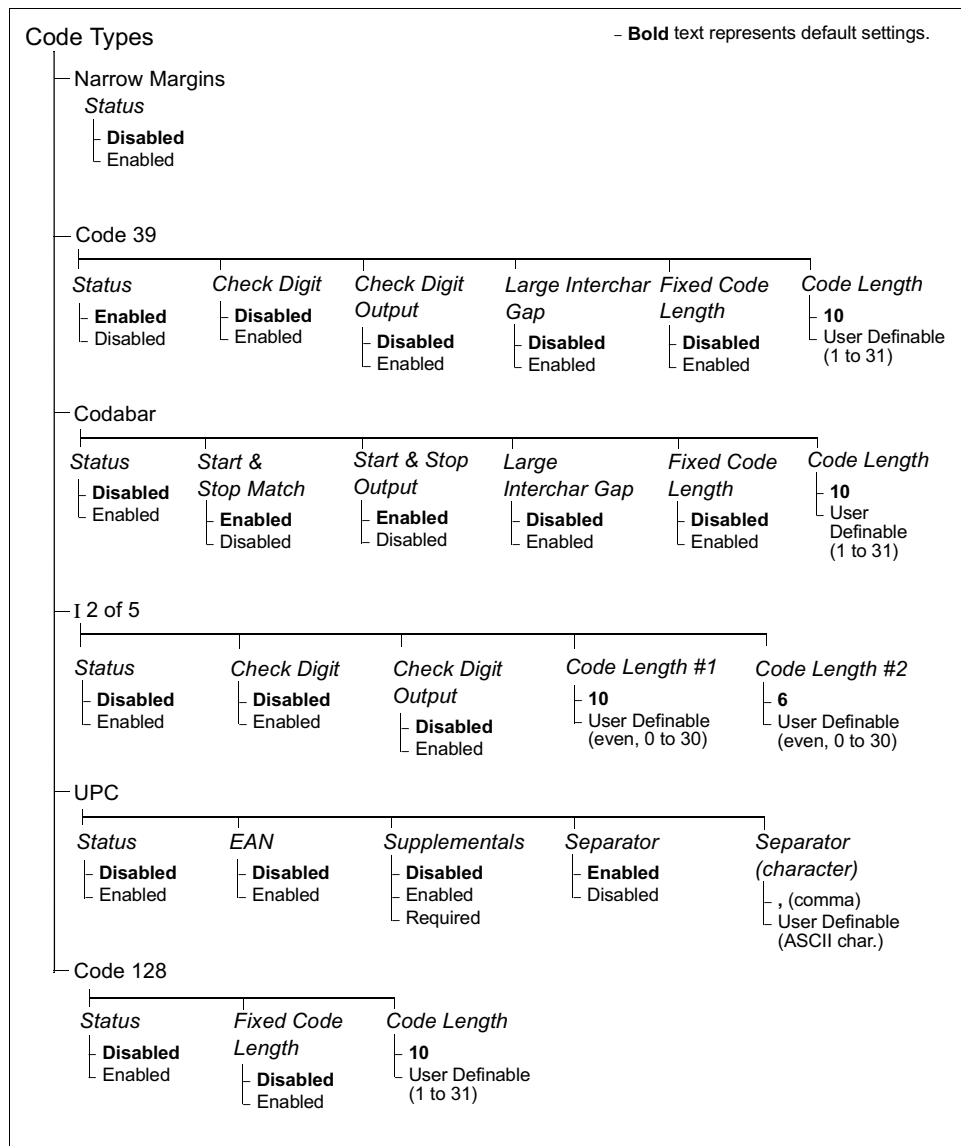

Figure 2-6 Code Types Menu Structure

Note: Options listed in the command line do not always appear in the same order as those posted in the first column of the menu.

Options can be defined for any bar code type whether or not the bar code itself is enabled at the time.

Narrow Margins

Status

Default: Disabled

Options: Disabled, Enabled

Allows the decoder to read bar codes with quiet zones less than 10 times the narrow-bar-width. Quiet zone is a term used to describe the minimum space at the leading and trailing ends of a label. Each quiet zone can be as small as five times the narrow bar element when Narrow Margins is enabled.

Code 39

Status

Default: Enabled

Options: Enabled, Disabled

Check Digit

Default: Disabled

Options: Disabled, Enabled

Code 39 is self-checking and does not normally require a check digit. However, for additional data integrity, a Modulus 43 check digit can be added to the bar code message. With Check Digit and an External or Serial trigger option enabled (see “Triggering Mode” on page 2-14), an invalid check digit calculation will cause a noread message to be transmitted at the end of the read cycle.

Check Digit Output

Default: Disabled

Options: Disabled, Enabled

When enabled, the check digit character is sent along with the label data. When disabled, label data is sent without the check digit.

Large Intercharacter Gap

Default: Disabled

Options: Disabled, Enabled

Allows the decoder to read labels with gaps between bar code characters exceeding three times the narrow element width.

Fixed Code Length

Default: Disabled

Options: Disabled, Enabled

Used to increase data integrity by ensuring that only one label length will be accepted.

Code Length

Default: 10

Options: 1 to 31

Note: Fixed Code Length (page 2-24) must be enabled for Code Length to take effect.

Allows you to specify the exact number of characters that the decoder will recognize (this does not include start and stop). The decoder will ignore any code not having the specified length.

Codabar

Status

Default: Disabled

Options: Disabled, Enabled

Start & Stop Match

Default: Enabled

Options: Enabled, Disabled

Requires the Codabar start and stop characters (a, b, c, or d) to match before a valid read can occur.

Start & Stop Output

Default: Enabled

Options: Enabled, Disabled

Allows the start and stop characters to be transmitted with bar code data.

Large Intercharacter Gap

Default: Disabled

Options: Disabled, Enabled

Allows the decoder to read labels with gaps between bar code characters exceeding three times the narrow element width.

Fixed Code Length

Default: Disabled

Options: Disabled, Enabled

Used to increase data integrity by ensuring that only label length will be accepted.

Code Length

Default: 10

Options: 1 to 31

Note: Fixed Code Length (page 2-25) must be enabled for Code Length to take effect.

Allows you to specify the exact number of characters that the decoder will recognize. The decoder will ignore any code not having the specified length.

Interleaved 2 of 5

Status

Default: Disabled

Options: Disabled, Enabled

Because I 2 of 5 is a continuous code, it is prone to substitution errors. Hence, a code length must be defined and a bar code label containing an even number of digits must be used. It is also recommended that a Modulus 10 check digit be used to ensure the best possible data integrity.

Check Digit

Default: Disabled

Options: Disabled, Enabled

I 2 of 5 uses a Modulus 10 check digit.

Check Digit Output

Default: Disabled

Options: Disabled, Enabled

When enabled, the check digit character is sent along with the label data.
When disabled, label data is sent without the check digit.

Code Length #1

Default: 10

Options: 0 to 30, even. If you enter an odd number the decoder will use the next lower number.

With I 2 of 5, two code lengths can be defined. When using only one label length in an application, we recommend setting Code Length #2 to 0 to ensure data integrity. If a check digit is used, it must be included in the code length count.

Code Length #2

Default: 6

Options: 0 to 30, even. If you enter an odd number the decoder will use the next lower number.

If using a second label, you may also specify a zero or any even code length from 2 to 30. If not using a second label, set Code Length #2 to 0 to ensure data integrity.

UPC

Status

Default: Disabled

Options: Disabled, Enabled

When enabled, the decoder will read UPC version A and UPC version E only.

EAN

Default: Disabled

Options: Disabled, Enabled

Note: UPC must be enabled for EAN to take effect.

When EAN is enabled, the decoder will read UPC version A, UPC version E, EAN 13, and EAN 8. It will also append a leading zero to UPC version A label information and transmit 13 digits. If you do not want to transmit 13 digits when reading UPC version A labels, disable EAN.

Supplementals

Default: Disabled

Options: Disabled, Enabled, Required

Note: Narrow Margins must be enabled if the gap between the standard code and the supplemental code is between 5:1 and 10:1 (in relation to narrow-bar-width).

Allows the decoder to read supplemental bar code data that has been appended to the standard UPC or EAN codes.

When set to Required, the decoder treats the supplemental data and the bar code label as a single label. Also, supplemental data must be found or a noread will result.

When set to Enabled, the decoder treats the supplemental data and the bar code label as separate labels.

Separator

Default: Enabled

Options: Enabled, Disabled

Allows you to insert a character between the standard UPC or EAN code and the supplemental code.

Separator (character)

Default: , (comma)

Options: Any ASCII character.

Allows you to change the separator character from a comma to a new value.

Code 128

Status

Default: Disabled

Options: Disabled, Enabled

Fixed Code Length

Default: Disabled

Options: Disabled, Enabled

Allows you to increase data integrity by ensuring that only one label length will be accepted.

Code Length

Default: 10

Options: 1 to 31

Note: Fixed Code Length must be enabled for Code Length to take effect.

Allows you to specify the exact number of characters that the decoder will recognize. The decoder will ignore any code not having the specified length.

User Outputs Menu

The User Outputs menu allows you to configure the decoder's output.

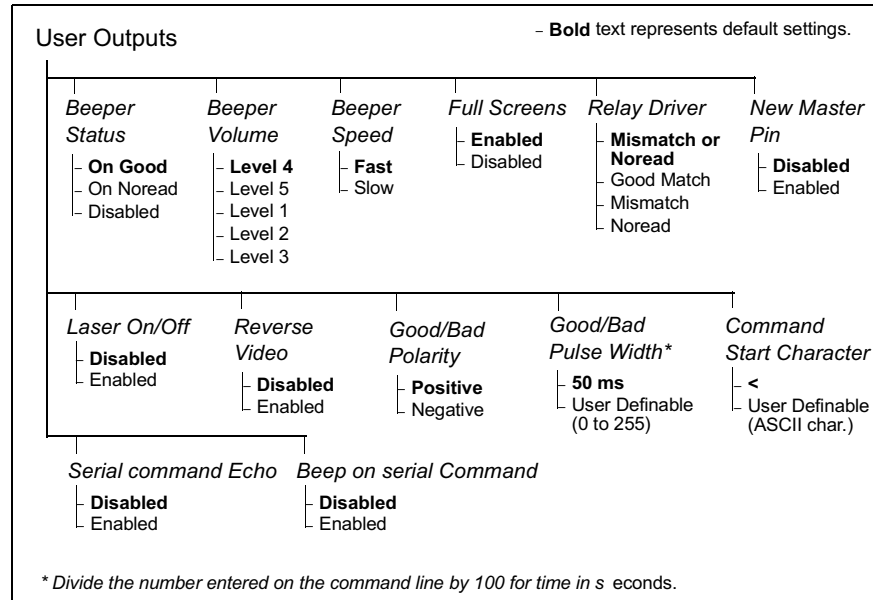

2-Menu Config.

Figure 2-7 User Outputs Menu Structure

Beeper

Default: On Good

Options: On Good, On Noread, Disabled

A beep is emitted either after each good read of a bar code label, after each noread, or not at all, according to the setting.

Note: The beep period will be short for triggered modes where a new trigger occurs immediately or the output is delayed to the end of the read cycle on edge and serial triggers.

Beeper Volume

Default: Level 4

Options: Level 4, Level 5, Level 1, Level 2, Level 3

Beeper Speed

Default: Fast

Options: Fast, Slow

Beeper Speed allows you to set the beeper to accommodate your application. The beeper takes approximately 80 ms to sound when Slow is enabled. If your application speed is faster than 80 ms (approximately), enable Fast.

Full Screens

Default: Enabled

Options: Enabled, Disabled

Allows you to display either the full menu screen or just the command line. When Full Screens is disabled, only the command line will be displayed.

Relay Driver

Default: Mismatch Or Noread

Options: Mismatch Or Noread, Good Match, Mismatch, Noread

Note: All options (except Noread) require that you enable Match Code (page 2-19) and download a master label into memory.

Allows you to determine the conditions under which a Relay Driver pulse of 5V is output. To see your options for enabling Match Code and downloading a master label into memory, see figure 2-5, “Match Code Logic Diagram,” on page 2-20.

Selecting: *Has this effect:*

Mismatch or Noread	Sends a pulse to pin 2 of the trigger connector when a label's data does not match that of the master label, or the label is not decoded before the end of the read cycle.
Good Match	Sends a pulse to pin 2 of the trigger connector when a label's data matches that of the master label.
Mismatch	Sends a pulse to pin 2 of the trigger connector when a label's data does not match that of the master label.
Noread	Sends a pulse to pin 2 of the trigger connector when no data is decoded before the end of the read cycle.

New Master Pin

Default: Disabled

Options: Disabled, Enabled

Note: Match Code (page 2-19) and a triggered mode (page 2-14) must be enabled for New Master Pin to take effect.

Allows you to externally toggle pin 25 to momentarily bring it to ground (pin 7). This clears any existing master label information from memory and records the next good read as the new master label information.

Laser On/Off

Default: Disabled

Options: Disabled, Enabled

Note: A serial or external trigger (see "Triggering Mode" on page 2-14) must be enabled for Laser On/Off to take effect.

When enabled, the laser is ON only during the read cycle. When disabled, the laser operates continuously.

Note: Laser On/Off does not relate to the <H> (Enable Laser Scanning) or <I> (Disable Laser Scanning) operational commands on page 5-3.

Reverse Video

Default: Disabled

Options: Disabled, Enabled

When enabled, the decoder will read bar code labels with bars that are lighter in color than their corresponding backgrounds.

Good/Bad Polarity

Default: Positive

Options: Positive, Negative

Allows you to choose between positive and negative output signals for pins 6 (good read) and 8 (nored) on the host connector and pin 2 on the trigger connector.

Good/Bad Pulse Width

Default: 5 (.05 seconds). Corresponds to 50 ms displayed in the menu.

Options: 0 to 255 (0 to 2.55 seconds). Divide the number entered on the command line by 100 for time in seconds.

Allows you to set the duration of the good read/no read output signals at host connector pins 6 and 8 by entering any number from 0 to 255.

Caution: Too long of a pulse width can cause missed labels, especially if Good/Bad Pulse Width exceeds End of Read Cycle Timeout (see page 2-16,).

Command Start Character

Default: <

Options: Any ASCII character.

Allows you to define a new ASCII start character in a serial command.

Serial Command Echo

Default: Disabled

Options: Disabled, Enabled

When enabled, serial configuration commands (“K” commands) will be processed and the new string for that command will be echoed back to the host. If an invalid command is sent to the host, the decoder will echo back the current setting of that command. For example, if the current Noread Message is “NOREAD” and <Kk1,NONSENSE> is entered, the decoder will echo back: <Kk1,NOREAD>. In this example the attempted entry “NONSENSE” exceeds the maximum allowable seven characters. Therefore it is rejected and the current NOREAD message is echoed back and remains the Noread Message.

Note: It is important to note that if a command with multiple fields is processed, some of the fields may have been processed properly following an “invalid” command. These changes will be in the string echoed back so that the user will know what did or did not change.

Beep on Serial Command

Default: Disabled

Options: Disabled, Enabled

When enabled, the decoder beeps once whenever a K command is entered to indicate that the command was accepted and processed. If an invalid command is entered, the decoder beeps 5 times to indicate an invalid entry. However, this does not necessarily mean that all data fields have been entered incorrectly. Only one bad field needs to be found in order to activate the 5 beep response.

Raster Setup Menu

Note: Raster Setup is applicable to the MS-1280 raster scan head only.

The Raster Setup menu allows you to set top and bottom offset values as well as the raster motor speed.

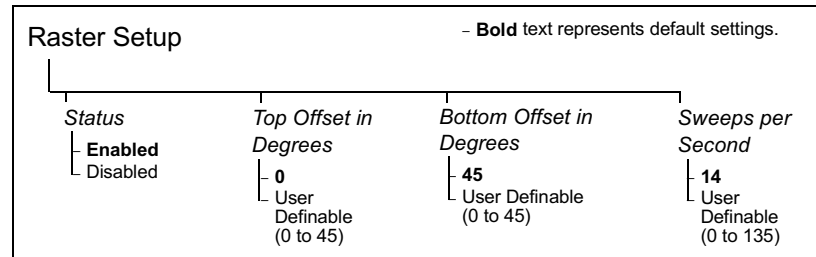

Figure 2-8 Raster Setup Menu Structure

2-Menu Config.

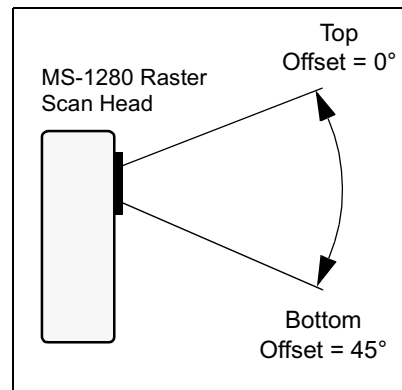

Figure 2-10 Raster Sweep Arc

Table 2-1 Raster Settings

Raster Arc	Sweeps per Second	
	Minimum	Maximum
1°	1	135
5°	1	75
10°	1	45
15°	1	35
20°	1	29
25°	1	23
30°	1	21
35°	1	19
40°	1	17
45°	1	14

Status

Default: Enabled

Options: Enabled, Disabled

For additional information on raster setup see the *MS-1280 Raster Scan Head User's Manual*.

Top Offset in Degrees

Default: 0 (degrees)

Options: 0 to 45 (in one-degree increments)

Note: The top offset must always be less than the bottom offset or the resulting arc will be 0 degrees.

Top Offset in Degrees, along with Bottom Offset in Degrees, allows you to set the raster sweep arc. See figure 2-10.

Bottom Offset in Degrees

Default: 45 (degrees)

Options: 0 to 45 (in one-degree increments)

Note: The bottom offset must always be greater than the top offset or the resulting arc will be 0 degrees.

Bottom Offset in Degrees, along with Top Offset in Degrees, allows you to set the raster sweep arc. See Figure figure 2-10 on page 2-33.

Sweeps per Second

Default: 14

Options: 0 to 135

Allows you to control the raster motor speed. A “sweep” is defined as a single pass, up or down, describing the raster image.

table A-1 on page 2-33 shows minimum and maximum possible sweep speeds at selected raster arcs. The minimum possible speed at any arc is always one sweep per second. Maximum sweep speeds are the maximums to which the scan head defaults—even when you enter higher speeds.

To maximize the number of scans a label will receive, select as few as possible sweeps per second. However, to ensure that the minimum required scan lines cross the bar code label, it is essential that at least **two full sweeps** occur during the time it takes for the label to pass through the readable scan width area.

For example, if the label is readable in the read range for only 1/10th of a second, then the number of sweeps per second should be at least 20. If readable for only 1 second, then sweeps per second (SPS) should be at least 2. To see the formula for calculating sweeps per second, see the *MS-1280 Raster Scan Head User's Manual*.

Chapter 3

Serial Configuration

Chapter Contents

Summary of Serial Configuration Commands.....	3-2
Concatenating Serial Commands.....	3-4
Serial Command Status Request.....	3-4
Loss of Communications.....	3-4
Trigger Filter Timing Value.....	3-5
Communications Commands.....	3-6
Operations Commands.....	3-10
Code Types Commands.....	3-12
User Outputs Commands.....	3-14
Raster Setup Commands.....	3-17

This chapter describes how to configure the MS-3000 single decoder by serial commands from a host.¹

All of the configuration parameters that can be changed in the menus with the exception of Full Screens, as described in Chapter 2, “Menu Configuration,” can also be changed by serial configuration commands.

All of the serial configuration parameters, with the exception of Trigger Filter Timing Value, also appear in the menus.

In addition, most of these configuration parameters can also be changed with a Microscan profile card (P/N 99-500011-01), obtainable from your Microscan representative. (See Chapter 4, “Profile Card Configuration.”)

1. The decoder communicates in full duplex, terminal mode with no handshake. It also recognizes carriage returns and line feeds. The host or ASCII terminal with must match the following default settings before any communication can take place: **9600** Baud Rate, **Seven** Data Bits, **Even** Parity, and **One** Stop Bit. If communicating from an auxiliary terminal via the auxiliary port (pins 18 and 19 of the 25 pin connector), the serial command <D> (Enter Menu Configuration Program) is the only command that the decoder will recognize.

Summary of Serial Configuration Commands

Table 3-1 Summary of Serial Configuration Commands

Function	Parameter	Command	Format
(Not in menu)	KF	Trigger Filter Timing Value	<KF?> (returns current value in milliseconds) <KFtime in 10 ms increments>
Host Protocol	Kf	Protocol	<Kfprotocol,data,...>
	Kd	Preamble	<Kdstatus,ASCII characters>
	Ke	Postamble	<Kestatus,ASCII characters>
	Kc	LRC	<Kcstatus>
	KA	Host Response Timeout	<KAnumber>
	KB	Intercharacter Delay	<KBnumber>
	KT	Host Protocol Status Request	<KT?>
	Kb	RS-422	<Kbstatus>
Host Port	Ka	Host Port	<Kabaud,parity,stop bits,data bits>
	Ky	Aux Mode	<Kymode>
	KU	Host Port Status Request	<KU?>
Operations	Kg	Triggering Mode	<Kgmode>
	Kh	End of Read Cycle	<Khmode,time>
	Ki	Serial Trigger Character	<Kicharacter>
	Kj	External Trigger Polarity	<Kjpolarity>
	Kk	Noread Message	<Kkstatus,noread message>
	Kl	Bar Code Output	<Klstatus,when to output>
	Km	Number of Reads	<Kmnumber>
	Kn	Match Code	<Knstatus>
	KL	Number of Labels	<KLnumber of labels,separator character>
	KV	Operations Status Request	<KV?>
Code Types	Ko	Narrow Margins	<Kostatus>
	Kp	Code 39	<Kpstatus,check digit,check digit output,large interchar. gap,fixed length,length>
	Kq	Codabar	<Kqstatus,S/S match,S/S output,large interchar gap,fixed length,length>
	Kr	Interleaved 2 of 5	<Krstatus,check digit,check digit output,length 1,length 2>
	Ks	UPC/EAN	<Ksstatus,EAN status,supplementals status,separator status,separator char.>
	Kt	Code 128	<Ktstatus,fixed length,length>
	KW	Code Types Status Request	<KW?>

Function	Parameter	Command	Format
User Outputs	Ku	Beeper	<K u beeper status,beeper volume,beeper speed>
	Kv	Relay Driver Usage	<K v mode>
	Kz	New Master Pin	<K z status>
	KC	Laser On/Off	<K C status>
	KD	Reverse Video	<K D status>
	Kw	Good/Bad Polarity	<K w polarity>
	Kx	Good/Bad Pulse Width	<K x number>
	KE	Command Start Character	<K E ASCII character>
	KS	Verification Serial Command	<K S serial command echo status,serial command beep status, control/hex output>
	KX	User Output Status Request	<K X ?>
Raster	KR	Raster Setup (1280 only)	<K R status,top offset,bottom offset,motor speed>

The format for a serial configuration command is,

<Kparameterdata,data,...etc.><initializing command>

Where:

- Less than < and greater than > symbols are included as part of the commands.¹
- “parameter,” as used here, are those character(s) that precede the data.
- The “initializing command” <A> or <Z> is sent after configuration is complete. <Z> resets and saves for power up. <A> initializes the change to RAM.² (For more information, see page 5-3.)

For example, the following command enables UPC and saves the change for power on: <K**s1**><Z>.

When using serial configuration commands, note also the following conventions:

- Parameters and data are “case sensitive.” That is, characters must be entered as upper or lower case, as specified.
- All data fields (except the last) must be followed by a comma (without a space).
- If there is no change in a given field, then commas can be entered alone, or with the existing data (for example, <K**a,,,0**> or <K**a4,1,0,0**>).

1. Command start character by default is a left angle bracket, <. It may be redefined by menu or serial command. However, the end character, a right angle bracket, >, cannot be changed.

2. See “Initializing serial configuration commands” on page 3-4 for definitions and examples.

- All fields preceding the modified field must be included. For example, in the RS-232 port, to change Data Bits to Eight without changing any other field, enter either: **<Ka,,,1>** or **<Ka4,1,0,1>**.
 - All fields following the modified field can be left out. For example, in the RS-232 port, to change Baud Rate to 4800, enter **<Ka3>**.
- (See examples on following pages.)

Initializing serial configuration commands

To ensure that a serial configuration command will take effect, you need to follow it with one of the operational commands below:

<A> To reset but not save changes for power on

<Z> To reset and save changes for power on

For example, to change Baud Rate and reset without saving changes for power-up, enter **<Ka3><A>**.

To change Baud Rate and reset, saving the changes to NOVRAM, enter **<Ka3><Z>**.

Concatenating Serial Commands

Commands can also be concatenated (added together) to a maximum of 64 characters in a single string or data block. Additional data blocks of 64 or less characters can be sent provided there is at least a 10 ms pause between blocks.¹

For example, the following command, **<Kc1><KA24><Ko1><A>** enables LRC, sets the Host Protocol Response Timeout to 24 ms, enables Narrow Margins and resets the data buffers (without saving the changes for power-on).

Serial Command Status Request

The status of serial commands can be requested by entering the command followed by a question mark. For example, enter **<Ke?>** to request the status of Postamble. Commands **KT?**, **KV?**, **KW?**, **KX?**, and **KU?** are used to request the status of groups of serial commands (see table 3-1 on page 3-2).

Loss of Communications

Assigning a multidrop address to a decoder or making changes to communications parameters such as Baud Rate, Parity, Stop Bits, LRC, etc. without corresponding changes in linked device(s) can result in the loss of menu access. If this should occur, try gaining access to the decoder by use of a pro-

1. Data in excess of 64 characters will reset the buffer, causing the first 64 characters of the string to be lost and indicator #1 to illuminate red 2 seconds after the end of each read cycle, until the decoder's memory is reset.

file card¹ or by entering a **<D>** command from an auxiliary terminal via the auxiliary RS-232 port. If neither of these methods is available, try defaulting the decoder. See Appendix C, “Defaulting the Decoder,” on page A-4.

Trigger Filter Timing Value

Format: **<KF?>**

Returns the current trigger filter timing value in milliseconds.

Format: **<KF*one tenth trigger filter timing value*>**

Allows you to set trigger filter timing. Divide the desired number of milliseconds by 10 and enter the quotient.

1. See mode 0 in Chapter 4, “Profile Card Configuration.”

Communications Commands

Note: Changes in Communications parameters or assigning an address to the decoder can cause loss of communications with the configuration terminal when you exit the menu program (whether or not changes are saved for power-on).

Protocol

If selecting one of the options from 0 to 4 (Point-to-Point, Point-to-Point with RTS/CTS, Point-to-Point with XON/XOFF, Point-to-Point with RTS/CTS and XON/XOFF, or Polling Mode D), use this format:

Format: **<Kfprotocol>**

<i>protocol:</i>	4 = Polling Mode D
0 = Point-to-Point	5 = Multidrop (requires address)
1 = Point-to-Point with RTS/CTS	6 = User Defined
2 = Point-to-Point with XON/XOFF	7 = User Defined Multidrop
3 = Point-to-Point with RTS/CTS & XON/XOFF	

Example: To change the Protocol to Polling Mode D, enter **<Kf4>**.

If selecting Multidrop (5), you must define an address and add it to the format (data B).

Format: **<Kfprotocol,address>**

<i>protocol:</i>	<i>address:</i>
5 = Multidrop (requires address)	Any number from 1 to 50.

Example: To change the Protocol to Multidrop with an address of 33, enter **<Kf5,33>**.

If selecting User Defined (6) or User Defined Multidrop (7), you must complete the format by either choosing new parameters or concatenating unchanged data fields (separate by commas).

Tip: For User Defined, you first select Point-to-Point **<Kf0>** and then User Defined **<Kf6...>**. For user Defined Multidrop, you first select Multidrop **<Kf5>**, then User Defined Multidrop **<Kf7...>**.

Format: **<Kfprotocol,RES,address,REQ,EOT,STX,ETX,ACK,NAK>**

Protocol:

6 = User Defined	7 = User Defined Multidrop
------------------	----------------------------

Example: To select an unpolled ACK/NAK User Defined protocol with LRC disabled, enter **<Kf0><Kf6,,,,,,^F,^U><Kc0>**.¹ ACK and NAK will be displayed in the menu.²

Note: Address can be assigned any ASCII character except a null. Control characters are used to define RES through NAK (except Address). Table 3-2 lists the control characters used for these data fields. (Refer to Table A-2, "ASCII Table with Control Characters," on page A-3 for more information.)

Table 3-2 Protocol Commands

Protocol Command (Mnemonic displayed on Microscan menu)	Control Characters (Entered in menu or serial command)	Effect of Command
RES	^D	Reset
REQ	^E	Request
EOT	^D	Reset
STX	^B	Start of Text
ETX	^C	End of Text
ACK	^F	Acknowledge
NAK	^U	Negative Acknowledge

Preamble

Format: <Kdstatus,preamble character(s)>

status:

0 = Disabled
1 = Enabled

preamble character(s):

Enter one or two preamble characters from table A-2 on page A-3, except a null (00H). Default is **^M**.

Example: To enable Preamble with just one character, an FF (form feed), enter <Kd1,^L>.

Postamble

Format: <Kestatus,postamble>

status:

0 = Disabled
1 = Enabled

postamble character(s):

Enter one or two postamble characters from table A-2 on page A-3, except a null (00H). Default characters are **^M^J**.

Example: To enable Postamble with an FF (form feed) and a **CR** (carriage return), enter <Ke1,^L^M>.

3-Serial Config.

1. <Kf0> nulls the address and <Kc0> disables LRC.
2. A control character, although conventionally represented here and in the ASCII table on page A-3 as two characters (^F or ^U, etc.), is actually a single ASCII character that is entered on the keyboard by holding down the control key while pressing the desired letter.

LRC

Format: <Kcstatus>

status:

0 = Disabled 1 = Enabled

Example: To enable LRC, enter <Kc1>.

Host Response Timeout

Format: <KAtimeout setting>

timeout setting:

Any number from 0 to 65,000 (a zero creates an indefinite wait).

Default is 12 (ms).

Example: To change Response Timeout to 30 ms, enter <KA30>.

Intercharacter Delay

Format: <KBtime interval>

time interval (in milliseconds between characters):

Any number from 0 to 255. Default is 0.

Example: To change Intercharacter Delay to 30 ms, enter <KB30>.

Host Port

Note: Changes made in the decoder's communications parameters such as baud rate, parity, stop bits, LRC, etc., must be matched in the other device(s) or communications will be lost. If this occurs, default the decoder as described in Appendix C — "Defaulting the Decoder."

Format: <Kabaud rate,parity,stop bits,data bits>

baud rate:

0 = 600 3 = 4800
1 = 1200 4 = 9600
2 = 2400 5 = 19.2K 6 = 38.4K

parity:

0 = None
1 = Even
2 = Odd

stop bits:

0 = One 1 = Two

data bits:

0 = Seven 1 = Eight

Example: To change the baud rate to 2400, enter <Ka2>.

To change Data Bits to Eight without changing any other fields, enter either: <Ka,,1> or <Ka4,1,0,1>.

RS-422

Format: <KbRS-422 status>

RS-422 status:

0 = Disabled 1 = Enabled

Example: To enable RS-422, enter <Kb1>.

This command assumes the decoder is in RS-232 before RS-422 is enabled. If a multidrop address has been already assigned, the decoder will be in RS-485 communications, regardless of RS-422 status.

Host Port Status Request

Format: <KU?>

Returns status of Host Port <Ka> and RS-422 <Kb>.

Auxiliary Port

Format: <Kystatus,baud rate,parity,stop bits,data bits>

status:

0 = Disabled
 1 = Transparent
 2 = Half Duplex
 3 = Full Duplex

baud rate:

0 = 600 3 = 4800
 1 = 1200 **4 = 9600**
 2 = 2400 5 = 19.2K 6 = 38.4K

parity:

0 = None
1 = Even 2 = Odd

stop bits:

0 = One
 1 = Two

data bits:

0 = Seven
 1 = Eight

Example: To enable Half Duplex and to change the baud rate to 2400, enter <Ky2,2>.

Communications Status Request

Format: <KT?>

Returns status of each command in the group.

3-Serial Config.

Operations Commands

Triggering Mode

Format: **<Kgmode>**

0 = Continuous Read	3 = External Edge
1 = Continuous Read 1 Output	4 = Serial Data
2 = External Level	5 = External and Serial

Example: To select External Edge, send: **<Kg3>**.

End of Read Cycle

Format: **<Khend of read cycle,timeout>**

end of read cycle: *timeout (in 10 millisecond increments):*

0= Timeout	Any number between 0 to 65,535.
1= New Trigger	Default is 100 (one seconds).
2= External and Serial	

Example: To select Timeout and change the timeout value to 6 seconds, enter **<Kh0,600>**.

Serial Trigger Character¹

Format: **<Kitrigger character>**

trigger character:

Enter any available ASCII character (see table A-1 on page A-3).
Default is **^]**.

Example: To define the Serial Trigger Character as a lowercase c, enter **<Kic>**.

External Trigger Polarity

Format: **<Kjpolarity>**

polarity:

0 = Negative	1 = Positive
--------------	---------------------

Example: To change External Trigger Polarity to Negative, enter **<Kj0>**.

1. Avoid selecting a serial trigger character that is also an operational command. For example, an uppercase C cannot be used as a serial trigger character because it is the operational command for Enter Read Rate Test. However, a lowercase c could be used without interfering with the read rate test.

Noread Message

Format: <**Kk**status,noread message>

<i>status:</i>	<i>noread message:</i>
0 = Disabled	Any ASCII string up to 7 digits.
1 = Enabled	Default is NOREAD

Example: To enable Noread Message and change noread message to "Fail," send: <**Kk1,Fail**>.

Bar Code Output

Format: <**Kl**status,when to output>

<i>status:</i>	<i>when to output:</i>
0 = Disabled	0 = As Soon As Possible
1 = Enabled	1 = End of Read Cycle

Example: To set Bar Code Output to End of Read Cycle, enter <**Kl1,1**>.

Number of Reads Before a Good Decode

Format: <**Km**number of reads>

number of reads:
Any number from 1 to 31.

Example: To change Number of Reads to 3, enter <**Km3**>.

Match Code

Format: <**Kn**status>

<i>status:</i>	
0 = Disabled	1 = Enabled

Example: To enable Match Code, enter <**Kb1**>.

Number of Labels

Format: <**KL**number of labels, field separator>

<i>number of labels:</i>	<i>field separator:</i>
0 = One label	3 = Four labels
1 = Two labels	4 = Five labels
2 = Three labels	5 = Six labels
	Any ASCII character except NUL.
	Default is a comma (,).

Example: To set Number of Labels to four with a dash (–) for a Field Separator, enter <**KL3,–**>.

Operations Status Request

Format: <**KV?**> Returns status of each command in the group.

Code Types Commands

Narrow Margins

Format: **<Kostatus>**

status:

0 = Disabled 1 = Enabled

Example: To enable Narrow Margins, enter **<Ko1>**.

Code 39

Format: **<Kpstatus,check digit status,check digit output,large interchar.
gap,fixed code length,code length>**

status:

0 = Disabled
1 = Enabled

check digit status:

0 = Disabled
1 = Enabled

check digit output status:

0 = Disabled
1 = Enabled

large interchar.

gap status:

0 = Disabled
1 = Enabled

fixed code length status: code length:

0 = Disabled
1 = Enabled

Any number from 1 to 31.
Default is **10**.

Example: To set Fixed Code Length to 30, enter **<Kp,,,1,30>** or
<Kp1,0,0,0,1,30>.

Codabar

Format: **<Kqstatus,start & stop match,start & stop output,large interchar.
gap,fixed code length,code length>**

status:

0 = Disabled
1 = Enabled

start & stop match status: start & stop output status:

0 = Disabled
1 = Enabled

0 = Disabled
1 = Enabled

large interchar. gap

status:

0 = Disabled
1 = Enabled

fixed code length status: code length:

0 = Disabled
1 = Enabled

Any number from 1 to 31.
Default is **10**.

Example: To enable Codabar and set Fixed Code Length to 9, enter
<Kq1,,,1,9> or **<Kq1,1,1,0,1,9>**.

I 2 of 5

Format: <Krstatus,check digit status,check digit output status,code length #1,code length #2>

status:	check digit status:	check digit output status:
0 = Disabled	0 = Disabled	0 = Disabled
1 = Enabled	1 = Enabled	1 = Enabled

code length #1:	code length #2:
Zero or any even number from 2 to 30. Default is 10 .	Zero or any even number from 2 to 30. Default is 6 .

Example: To enable I 2 of 5 and to set Fixed Code Length #1 to 8 and Fixed Code Length #2 to 4, enter <Kr1,,,8,4> or <Kr1,0,0,8,4>.

UPC/EAN

Format: <Ksstatus,EAN status,supplementals status,separator status,separator character>

status:	EAN status:	supplementals status:
0 = Disabled	0 = Disabled	0 = Disabled
1 = Enabled	1 = Enabled	1 = Enabled
	(UPC must also be enabled)	2 = Required

separator status:	separator character:
0 = Disabled	Any ASCII character (except NUL). Default is a comma (,).
1 = Enabled	

Example: To enable UPC and EAN, change supplementals to required, and change separator character to a dash (-), enter <Ks1,1,2,1,-> or <Ks1,1,2,,->.

Code 128

Format: <Ktstatus,fixed code length status,code length>

status:	fixed code length status:	code length:
0 = Disabled	0 = Disabled	Any number from 1 to 31.Default is 10 .
1 = Enabled	1 = Enabled	

Example: To enable Code 128, enable Fixed Code Length, and set Code Length to 9, enter <Kt1,1,9>.

Code Types Status Request

Format: <KW?>

Returns status of each command in the group.

User Outputs Commands

Beeper

Format: <K**u**beeper status,beeper volume,beeper speed>

<i>beeper status:</i>	<i>beeper volume:</i>	<i>beeper speed:</i>
0 = Disabled	0 = Level 1	0 = Fast
1 = On Good	1 = Level 2	1 = Slow
2 = On Noread	2 = Level 3	
	3 = Level 4	
	4 = Level 5	

Example: To enable the beeper for On Noread and set the beeper volume to Level 5, enter <K**u**2,4>.

Relay Driver

Format: <K**v**relay driver>

<i>relay driver:</i>	
0 = Good Match	2 = Noread
1 = Mismatch	3 = Mismatch or Noread

Example: To change Relay Driver to Noread, enter <K**v**2>.

New Master Pin

Format: <K**z**status>

<i>status:</i>	
0 = Disabled	1 = Enabled

Example: To enable New Master Pin, enter <K**z**1>.

Laser On/Off

Format: <K**C**status>

<i>status:</i>	
0 = Disabled	1 = Enabled

Example: To enable Laser On/Off, enter <K**C**1>.

Serial Command Verification

Format: **<KS**serial command echo status,serial command beep status,control/hex output>

serial command echo status:	serial command beep status:	control/hex output:
0 = Disabled 1 = Enabled	0 = Disabled 1 = Enabled	0 = Control 1 = Hex

Example: To enable Serial Command Echo Status and Beep Status, and Hex output, enter **<KS1,1,1>**

Serial Command Echo Status

When enabled, serial configuration commands (“K” commands) will be processed and the new string for that command will be echoed back to the host. (See “Serial Command Echo,” on page 2-32 for more details.)

Beep on Serial Command

When enabled, the decoder beeps once whenever a K command is entered to indicate that the command was accepted and processed. If an invalid command is entered, the decoder beeps 5 times to indicate an invalid entry. However, this does not necessarily mean that all data fields have been entered incorrectly. Only one bad field needs to be found in order to activate the 5 beep response.

Control/hex Output

Determines the echoed display of a serial status request when ASCII characters with control characters are entered in a serial configuration command. When set to Control, the echoed output includes a control character as shown in the “Ctrl” column of Table A-2, “ASCII Table with Control Characters,” on page A-3. When set to Hex, the output is the actual character entered, for example the preamble command **<Ke,,CR>** echoes back as **>Ke,,** because in Hex mode the carriage return key acts on the command. In Control mode **<Ke,,^M>** is returned.

User Output Status Request

Format: **<KX?>**

Returns status of each command in the User Output group.

Reverse Video

Format: **<KDstatus>**

status:

0 = Disabled **1 = Enabled**

Example: To enable Reverse Video, enter **<KD1>**.

Good/Bad Polarity

Format: **<Kwpolarity>**

polarity:

0 = Negative 1 = Positive

Pin 6 and 8 on host connector, and pin 2 on trigger connector.

Example: To change Good/Bad Polarity to Negative, enter **<Kw0>**.

Good/Bad Pulse Width

Format: **<Kxrelay pulse>**

duration of relay pulse:

Any number from 0 to 255. Default is **5** (50 ms).

Pin 6 and 8 on host connector, and pin 2 on trigger connector.

Example: To set Good/Bad Pulse Width to 600 ms, enter **<Kx60>**.

Command Start Character

Format: **<KEcommand start character>**

command start character:

Any ASCII character. Default is **<**.

Example: To change Command Start Character to a colon (:), enter **<KE:>**.

Note: Subsequent commands must start with a colon (:). For example, enter **:D>** to access the menu, or **:KE<>** to change back to the default character.

User Outputs Status Request

Format: **<KX?>**

Returns status of each command in the group.

Raster Setup Commands

Format: **<KR***status,top offset,bottom offset,motor speed***>**

status:

0 = Disabled

1 = Enabled

top offset in degrees:

Any number from 0 to 45.

Default is **0**.

bottom offset in degrees:

Any number from
0 to 45. Default is **45**.

motor speed (in sweeps per second):

Any number from 0 to 135. Default is **14**.

Example: To set the raster arc to 35° and the raster motor speed to 10 sweeps per second, enter **<KR1,5,40,10>**.

Chapter
4

Profile Card Configuration

Chapter Contents

Summary of MS-3000 Modes.....	4-2
Operating Instructions.....	4-3
General Settings.....	4-4
Communications Settings.....	4-6
Operations Settings.....	4-8
Code Types Settings.....	4-11
User Outputs Settings.....	4-11

Note: *Not all configuration changes that can be done by menu configuration can be done with the profile card.*

The profile card, available from Microscan as an accessory (P/N 99-500011-01), is not essential to the operation of the decoder. All configuration commands performed by the profile card can also be done by menu or serial command. However, a profile card can speed up configuration and is particularly useful for copying configuration from one decoder to another and for configuring devices that have been given multidrop addresses.

4-Profile Card.

Summary of MS-3000 Modes

Table 4-1 Profile Card Mode Descriptions

Mode	Parameter	Function
0	Write-to-Device Function	Downloads (copies) all of the configuration parameters from the profile card to the connected decoder.
	Read Function	Uploads configuration data from the volatile RAM of the decoder to the non-volatile RAM of the profile card.
	Default	Sets unit to the default configuration settings.
	Menu	Enters the menu program while decoder is in polled mode.
1	Write & Assign Address	Combines the write function from mode 0 with the address function of mode 2. Downloads a multidrop address as well as all of the configuration parameters in the profile card.
2	Assign Multidrop Address	Assigns user-selected multidrop address to the decoder by using data switches 1-6. Binary representation of the multidrop address is used (the range is 1 to 50).
3	Baud Rate	Defines Baud Rate for the host port.
	Parity	Defines Parity for the host port.
	Stop Bits	Defines Stop Bits for the host port.
	Data Bits	Defines Data Bits for the host port.
4	Preamble	Enables/disables Preamble.
	Postamble	Enables/disables Postamble.
5	Protocol	Defines the communications protocol.
	RS-422	Enables/disables RS-422.
6	Aux Port	Sets Aux. Port operation mode.
7	Triggering Mode	Defines Triggering Mode.
	End of Read Cycle	Defines End of Read Cycle.
8	Bar Code Output	Enables/disables Bar Code Output.
	When to Output	Defines the conditions for When to Output.
	External Trigger Polarity	Defines External Trigger Polarity (negative/positive).
	Match Code	Enables/disables Match Code.
9	Noread Message	Enables/disables Noread Message.
	Timeout in 10 ms inc.	Sets the trigger timeout value. The range is 1-255 for corresponding values of 0.1 to 25.5 seconds.
10	Serial Trigger Character	Assigns the Serial Trigger Character. (See the ASCII table on page A-3 for decimal values and corresponding characters.)
11	Number of Reads	Sets the number of reads for a good decode from 1-31.
12	Narrow Margins	Enables/disables Narrow Margins for all code types.
	Code Types	Enables individual bar code types or Autodiscriminate.
13	Beeper Volume	Sets the beeper volume.
	Beeper	Sets the conditions when the beeper is emitted.
14	Relay Driver	Defines the mode selection for programmable output.
	Full Screens	Enables/disables Full Screens.
	Good/Bad Polarity	Sets the Polarity of output pulses.
	New Master Pin	Enables/disables New Master Pin.
	Laser On/Off	Enables/disables Laser On/Off.
	Reverse Video	Enables/disables Reverse Video.

Operating Instructions

The profile card obtains all operating voltages from the decoder. Turn the decoder off before starting procedures.

1. With the decoder OFF, insert the end of the profile card which is labeled DECODER into the port labeled HOST on decoder.
2. Turn decoder ON.
3. Set the mode and data switches to the desired settings.

Data switches are on the left, mode switches on the right.

Note: Be sure all of the data switch settings are correct for the selected mode before pressing the load button.

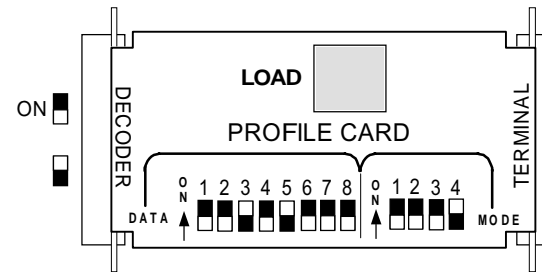

Figure 4-1 Profile Card

4. Press the LOAD button.
5. A beeper will sound. This initializes the change and saves it to non-volatile RAM for access on power-up.
6. When the configuration is complete, turn power OFF to the decoder and remove the profile card.

If using RS-232 (only) and communication between the host and the decoder is desired with the profile card, connect a cable to the profile card end labeled TERMINAL and connect it to the host.

General Settings

Mode 0: Write, Read, Default, Menu

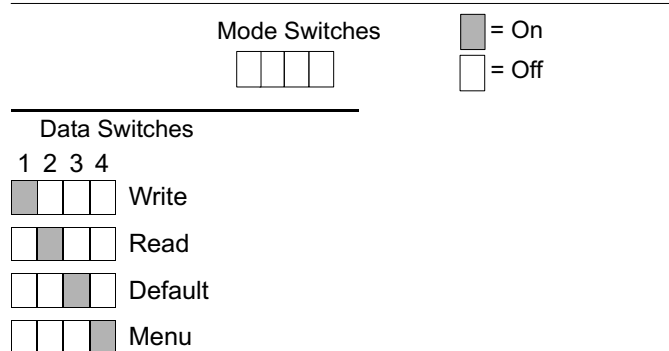

Note: Unintentional defaults may occur when using the profile card's write functions (modes 0 and 1) to copy configuration changes from versions **-26 and earlier** to versions **-27 and later** (and vice versa), and when copying from versions **-27 through -31** to versions **-32 and later** (and vice versa) of Microscan standard firmware.¹ To solve, you can change all EPROMs to the same firmware version, use a separate profile card for each version group, or use a single profile card to first make all configuration copy changes within one group (those with all earlier or all later versions) and then, after individually changing the settings in one decoder of the second group, copying them to the other decoders in that group.

1. The firmware number is 35-213001-XX for the MS-3000 single head decoder. The XX is substituted here for the version number. The firmware version can be found on a label on the EPROM, displayed in the heading of the Main menu in the Configuration program, or on later versions, displayed by invoking the <#> serial operational command. You can also call-in the serial numbers of the decoders to Microscan to get the firmware versions issued with those decoders.

Mode 1: Write Configuration and Assign Address

Mode Switches



= On
 = Off

Data Switches^a

Address						Address						Address						Address					
1	2	3	4	5	6	1	2	3	4	5	6	1	2	3	4	5	6	1	2	3	4	5	6
<input checked="" type="checkbox"/>	<input type="checkbox"/>	<input type="checkbox"/>	<input type="checkbox"/>	<input type="checkbox"/>	<input type="checkbox"/>	<input type="checkbox"/>	<input checked="" type="checkbox"/>	<input checked="" type="checkbox"/>	<input checked="" type="checkbox"/>	<input checked="" type="checkbox"/>	<input type="checkbox"/>	<input checked="" type="checkbox"/>	<input checked="" type="checkbox"/>	<input type="checkbox"/>	<input checked="" type="checkbox"/>	<input checked="" type="checkbox"/>	<input type="checkbox"/>	<input type="checkbox"/>	<input type="checkbox"/>	<input type="checkbox"/>	<input checked="" type="checkbox"/>	<input checked="" type="checkbox"/>	<input checked="" type="checkbox"/>
1						14						27						40					
<input type="checkbox"/>	<input checked="" type="checkbox"/>	<input type="checkbox"/>	<input type="checkbox"/>	<input type="checkbox"/>	<input type="checkbox"/>	<input checked="" type="checkbox"/>	<input checked="" type="checkbox"/>	<input checked="" type="checkbox"/>	<input checked="" type="checkbox"/>	<input checked="" type="checkbox"/>	<input type="checkbox"/>	<input type="checkbox"/>	<input type="checkbox"/>	<input checked="" type="checkbox"/>	<input checked="" type="checkbox"/>	<input checked="" type="checkbox"/>	<input type="checkbox"/>	<input checked="" type="checkbox"/>	<input type="checkbox"/>	<input checked="" type="checkbox"/>	<input checked="" type="checkbox"/>	<input checked="" type="checkbox"/>	<input type="checkbox"/>
2						15						28						41					
<input checked="" type="checkbox"/>	<input checked="" type="checkbox"/>	<input type="checkbox"/>	<input type="checkbox"/>	<input type="checkbox"/>	<input type="checkbox"/>	<input type="checkbox"/>	<input type="checkbox"/>	<input type="checkbox"/>	<input checked="" type="checkbox"/>	<input checked="" type="checkbox"/>	<input type="checkbox"/>	<input checked="" type="checkbox"/>	<input type="checkbox"/>	<input checked="" type="checkbox"/>	<input checked="" type="checkbox"/>	<input checked="" type="checkbox"/>	<input type="checkbox"/>	<input type="checkbox"/>	<input checked="" type="checkbox"/>	<input checked="" type="checkbox"/>	<input checked="" type="checkbox"/>	<input checked="" type="checkbox"/>	<input type="checkbox"/>
3						16						29						42					
<input type="checkbox"/>	<input type="checkbox"/>	<input checked="" type="checkbox"/>	<input type="checkbox"/>	<input type="checkbox"/>	<input type="checkbox"/>	<input checked="" type="checkbox"/>	<input type="checkbox"/>	<input type="checkbox"/>	<input type="checkbox"/>	<input checked="" type="checkbox"/>	<input checked="" type="checkbox"/>	<input type="checkbox"/>	<input checked="" type="checkbox"/>	<input checked="" type="checkbox"/>	<input checked="" type="checkbox"/>	<input checked="" type="checkbox"/>	<input type="checkbox"/>	<input checked="" type="checkbox"/>	<input type="checkbox"/>	<input checked="" type="checkbox"/>	<input checked="" type="checkbox"/>	<input checked="" type="checkbox"/>	<input type="checkbox"/>
4						17						30						43					
<input checked="" type="checkbox"/>	<input type="checkbox"/>	<input checked="" type="checkbox"/>	<input type="checkbox"/>	<input type="checkbox"/>	<input type="checkbox"/>	<input type="checkbox"/>	<input checked="" type="checkbox"/>	<input type="checkbox"/>	<input checked="" type="checkbox"/>	<input checked="" type="checkbox"/>	<input type="checkbox"/>	<input checked="" type="checkbox"/>	<input checked="" type="checkbox"/>	<input checked="" type="checkbox"/>	<input checked="" type="checkbox"/>	<input checked="" type="checkbox"/>	<input type="checkbox"/>	<input type="checkbox"/>	<input type="checkbox"/>	<input checked="" type="checkbox"/>	<input checked="" type="checkbox"/>	<input checked="" type="checkbox"/>	<input type="checkbox"/>
5						18						31						44					
<input type="checkbox"/>	<input checked="" type="checkbox"/>	<input checked="" type="checkbox"/>	<input type="checkbox"/>	<input type="checkbox"/>	<input type="checkbox"/>	<input checked="" type="checkbox"/>	<input checked="" type="checkbox"/>	<input type="checkbox"/>	<input checked="" type="checkbox"/>	<input checked="" type="checkbox"/>	<input type="checkbox"/>	<input type="checkbox"/>	<input type="checkbox"/>	<input type="checkbox"/>	<input type="checkbox"/>	<input checked="" type="checkbox"/>	<input type="checkbox"/>	<input checked="" type="checkbox"/>	<input type="checkbox"/>	<input checked="" type="checkbox"/>	<input checked="" type="checkbox"/>	<input checked="" type="checkbox"/>	<input type="checkbox"/>
6						19						32						45					
<input checked="" type="checkbox"/>	<input checked="" type="checkbox"/>	<input checked="" type="checkbox"/>	<input type="checkbox"/>	<input type="checkbox"/>	<input type="checkbox"/>	<input type="checkbox"/>	<input type="checkbox"/>	<input checked="" type="checkbox"/>	<input checked="" type="checkbox"/>	<input checked="" type="checkbox"/>	<input type="checkbox"/>	<input checked="" type="checkbox"/>	<input type="checkbox"/>	<input type="checkbox"/>	<input type="checkbox"/>	<input checked="" type="checkbox"/>	<input type="checkbox"/>	<input type="checkbox"/>	<input checked="" type="checkbox"/>	<input checked="" type="checkbox"/>	<input checked="" type="checkbox"/>	<input checked="" type="checkbox"/>	<input type="checkbox"/>
7						20						33						46					
<input type="checkbox"/>	<input type="checkbox"/>	<input type="checkbox"/>	<input checked="" type="checkbox"/>	<input type="checkbox"/>	<input type="checkbox"/>	<input checked="" type="checkbox"/>	<input checked="" type="checkbox"/>	<input checked="" type="checkbox"/>	<input checked="" type="checkbox"/>	<input checked="" type="checkbox"/>	<input type="checkbox"/>	<input type="checkbox"/>	<input checked="" type="checkbox"/>	<input type="checkbox"/>	<input type="checkbox"/>	<input checked="" type="checkbox"/>	<input type="checkbox"/>	<input checked="" type="checkbox"/>	<input type="checkbox"/>	<input checked="" type="checkbox"/>	<input checked="" type="checkbox"/>	<input checked="" type="checkbox"/>	<input type="checkbox"/>
8						21						34						47					
<input checked="" type="checkbox"/>	<input type="checkbox"/>	<input type="checkbox"/>	<input checked="" type="checkbox"/>	<input checked="" type="checkbox"/>	<input type="checkbox"/>	<input type="checkbox"/>	<input checked="" type="checkbox"/>	<input checked="" type="checkbox"/>	<input checked="" type="checkbox"/>	<input checked="" type="checkbox"/>	<input type="checkbox"/>	<input checked="" type="checkbox"/>	<input checked="" type="checkbox"/>	<input type="checkbox"/>	<input type="checkbox"/>	<input checked="" type="checkbox"/>	<input type="checkbox"/>	<input type="checkbox"/>	<input type="checkbox"/>	<input type="checkbox"/>	<input checked="" type="checkbox"/>	<input checked="" type="checkbox"/>	<input type="checkbox"/>
9						22						35						48					
<input type="checkbox"/>	<input checked="" type="checkbox"/>	<input checked="" type="checkbox"/>	<input checked="" type="checkbox"/>	<input type="checkbox"/>	<input type="checkbox"/>	<input checked="" type="checkbox"/>	<input checked="" type="checkbox"/>	<input checked="" type="checkbox"/>	<input checked="" type="checkbox"/>	<input checked="" type="checkbox"/>	<input type="checkbox"/>	<input type="checkbox"/>	<input type="checkbox"/>	<input checked="" type="checkbox"/>	<input type="checkbox"/>	<input checked="" type="checkbox"/>	<input type="checkbox"/>	<input checked="" type="checkbox"/>	<input type="checkbox"/>	<input type="checkbox"/>	<input checked="" type="checkbox"/>	<input checked="" type="checkbox"/>	<input type="checkbox"/>
10						23						36						49					
<input checked="" type="checkbox"/>	<input checked="" type="checkbox"/>	<input type="checkbox"/>	<input checked="" type="checkbox"/>	<input checked="" type="checkbox"/>	<input type="checkbox"/>	<input type="checkbox"/>	<input type="checkbox"/>	<input type="checkbox"/>	<input checked="" type="checkbox"/>	<input checked="" type="checkbox"/>	<input type="checkbox"/>	<input checked="" type="checkbox"/>	<input type="checkbox"/>	<input checked="" type="checkbox"/>	<input type="checkbox"/>	<input checked="" type="checkbox"/>	<input type="checkbox"/>	<input type="checkbox"/>	<input checked="" type="checkbox"/>	<input checked="" type="checkbox"/>	<input checked="" type="checkbox"/>	<input checked="" type="checkbox"/>	<input type="checkbox"/>
11						24						37						50					
<input type="checkbox"/>	<input type="checkbox"/>	<input checked="" type="checkbox"/>	<input checked="" type="checkbox"/>	<input type="checkbox"/>	<input type="checkbox"/>	<input checked="" type="checkbox"/>	<input type="checkbox"/>	<input type="checkbox"/>	<input checked="" type="checkbox"/>	<input checked="" type="checkbox"/>	<input type="checkbox"/>	<input type="checkbox"/>	<input checked="" type="checkbox"/>	<input checked="" type="checkbox"/>	<input checked="" type="checkbox"/>	<input checked="" type="checkbox"/>	<input type="checkbox"/>						
12						25						38											
<input checked="" type="checkbox"/>	<input type="checkbox"/>	<input checked="" type="checkbox"/>	<input checked="" type="checkbox"/>	<input type="checkbox"/>	<input type="checkbox"/>	<input type="checkbox"/>	<input checked="" type="checkbox"/>	<input type="checkbox"/>	<input checked="" type="checkbox"/>	<input checked="" type="checkbox"/>	<input type="checkbox"/>	<input checked="" type="checkbox"/>	<input checked="" type="checkbox"/>	<input type="checkbox"/>	<input type="checkbox"/>	<input checked="" type="checkbox"/>	<input type="checkbox"/>						
13						26						39											

a. Use these switch settings for mode 2, 9, 10, and 11.

4-Profile Card.

Communications Settings

Note: Changes in Communications parameters or assigning an address to the decoder can cause loss of communications with the configuration terminal when you exit the menu program (whether or not changes are saved for power-on).

Mode 2: Address

Mode Switches = On
 = Off

Address selection for mode 2 is identical to mode 1. See mode 1 for switch settings.

Mode 3: Host Port Baud Rate, Parity, Stop Bits, Data Bits

Mode Switches = On
 = Off

Data Switches

Baud Rate			Parity		Stop Bits		Data Bits	
1	2	3	4	5	6	7		
<input type="checkbox"/>	<input type="checkbox"/>	<input type="checkbox"/>	<input type="checkbox"/>	<input type="checkbox"/>	<input type="checkbox"/>	<input type="checkbox"/>		
600			None		One		Seven	
<input checked="" type="checkbox"/>	<input type="checkbox"/>	<input type="checkbox"/>	<input checked="" type="checkbox"/>	<input type="checkbox"/>	<input checked="" type="checkbox"/>	<input checked="" type="checkbox"/>		
1200			Even		Two		Eight	
<input type="checkbox"/>	<input checked="" type="checkbox"/>	<input type="checkbox"/>	<input type="checkbox"/>	<input checked="" type="checkbox"/>	Odd			
2400								
<input checked="" type="checkbox"/>	<input checked="" type="checkbox"/>	<input type="checkbox"/>						
4800								
<input type="checkbox"/>	<input type="checkbox"/>	<input checked="" type="checkbox"/>						
9600								
<input checked="" type="checkbox"/>	<input type="checkbox"/>	<input type="checkbox"/>						
19200								
<input type="checkbox"/>	<input checked="" type="checkbox"/>	<input checked="" type="checkbox"/>						
38400								

4-Profile Card.

Mode 4: Preamble, Postamble

Mode Switches



= On
 = Off

Data Switches

Preamble

Postamble

1

2

Disabled

Disabled

Enabled

Enabled

Mode 5: Protocol, Host Port RS-422

Mode Switches



= On
 = Off

Data Switches

Protocol

RS-422

1 2 3

4

Point-to-Point

Disabled

Point-to-Point with RTS/CTS

Enabled

Point-to-Point with XON/XOFF

Point-to-Point with RTS/CTS & XON/XOFF

Polling Mode D

Multidrop

User Defined

User Defined Multidrop

4-Profile Card.

Operations Settings

Mode 6: Aux Port

Mode Switches



= On

= Off

Data Switches

Aux port mode:

1 2

Disabled

Transparent

Half Duplex

Full Duplex

Mode 7: Triggering Mode, End of Read Cycle

Mode Switches



= On

= Off

Data Switches

Triggering Mode

1 2 3

Continuous Read

Continuous Read 1 Output

External Level

External Edge

Serial Data

Serial Data & Edge

End of Read Cycle

4 5

Timeout

New Trigger

Timeout & New Trigger

Mode 8: Bar Code Output, When to Output, External Trigger Polarity, Match Code, Noread Message

Mode Switches



= On

= Off

Data Switches

Bar Code Output	When to Output	External Trigger Polarity	Match Code	Noread Message
1	2	3	4	5
<input type="checkbox"/> Disabled	<input type="checkbox"/> As Soon as Possible	<input type="checkbox"/> Negative	<input type="checkbox"/> Disabled	<input type="checkbox"/> Disabled
<input checked="" type="checkbox"/> Enabled	<input checked="" type="checkbox"/> End of Read Cycle	<input checked="" type="checkbox"/> Positive	<input checked="" type="checkbox"/> Enabled	<input checked="" type="checkbox"/> Enabled

Mode 9: Timeout

Mode Switches



= On

= Off

Since the number of profile card settings is limited to 255, trigger timeouts entered from the profile card can only affect a range from 0.1 seconds to 25.5 seconds, in tenths of a second.

To set Timeout, multiply the desired number of seconds for timeout by 10 and enter the result in binary format.





See mode 1 for switch settings for timeout ranges from 0.1 seconds to 5 seconds. (Although not shown for mode 1, switches 7 and 8 are OFF for 1 through 50.) See “Binary Calculations” on page 4-13 for timeout ranges from 5.1 seconds to 25.5 seconds.

4-Profile Card.

Mode 10: Serial Trigger Character



You can define the Serial Trigger Character with an ASCII character of your choice, or you can use the samples provided below. To use other ASCII characters, see the ASCII table in appendix B for characters and their corresponding decimal values. See mode 1 for values from 1 to 50, or “Binary Calculations” on page 4-13 for decimal values from 51 to 255.

Data Switches	ASCII Decimal Number	Sample Serial Trigger ASCII Characters
1 2 3 4 5 6 7 8 	29	^]
	49	1
	65	A
	90	Z

Mode 11: Number of Reads Before a Good Decode



The range for Number of Reads before a Good Decode is 1-31. See mode 1 for switch settings.

4-Profile Card.

Code Types Settings

Mode 12: Code 39, Codabar, I 2 of 5, UPC, Code 128, Narrow Margins

Enabling data switches 1 through 5 will autodiscriminate for all code types.

Mode Switches



= On

= Off

Data Switches

Code 39	Codabar	I 2 of 5	UPC	Code 128	Narrow Margins
1	2	3	4	5	6
<input type="checkbox"/> Disabled	<input type="checkbox"/> Disabled	<input type="checkbox"/> Disabled	<input type="checkbox"/> Disabled	<input type="checkbox"/> Disabled	<input type="checkbox"/> Disabled
<input checked="" type="checkbox"/> Enabled	<input checked="" type="checkbox"/> Enabled	<input checked="" type="checkbox"/> Enabled	<input checked="" type="checkbox"/> Enabled	<input checked="" type="checkbox"/> Enabled	<input checked="" type="checkbox"/> Enabled

User Outputs Settings

Mode 13: Beeper Volume, Beeper Enable, Beeper Speed

Mode Switches



= On

= Off

Data Switches

Beeper Volume	Beeper Enable	Beeper Speed
1 2 3	4 5	6
<input type="checkbox"/> <input type="checkbox"/> <input type="checkbox"/> Level 1	<input type="checkbox"/> <input type="checkbox"/> Disabled	<input type="checkbox"/> Fast
<input checked="" type="checkbox"/> <input type="checkbox"/> <input type="checkbox"/> Level 2	<input checked="" type="checkbox"/> <input type="checkbox"/> On Good Read	<input checked="" type="checkbox"/> Slow
<input type="checkbox"/> <input checked="" type="checkbox"/> <input type="checkbox"/> Level 3	<input type="checkbox"/> <input checked="" type="checkbox"/> On Noread	
<input checked="" type="checkbox"/> <input checked="" type="checkbox"/> <input type="checkbox"/> Level 4		
<input type="checkbox"/> <input type="checkbox"/> <input checked="" type="checkbox"/> Level 5		

4-Profile Card.

**Mode 14: Relay Driver, Full Screens, Good/Bad Polarity,
New Master Pin, Laser On/Off, Reverse Video**

Mode Switches



= On

= Off

Data Switches

Relay Driver	Full Screens	Good/Bad Polarity	New Master Pin	Laser On/Off	Reverse Video
1 2	3	4	5	6	7
<input type="checkbox"/> <input type="checkbox"/> Good Match	<input type="checkbox"/> Disabled	<input type="checkbox"/> Negative	<input type="checkbox"/> Disabled	<input type="checkbox"/> Disabled	<input type="checkbox"/> Disabled
<input checked="" type="checkbox"/> <input type="checkbox"/> Mismatch	<input checked="" type="checkbox"/> Enabled	<input checked="" type="checkbox"/> Positive	<input type="checkbox"/> Enabled	<input checked="" type="checkbox"/> Enabled	<input checked="" type="checkbox"/> Enabled
<input type="checkbox"/> <input checked="" type="checkbox"/> Noread					
<input checked="" type="checkbox"/> <input checked="" type="checkbox"/> Mismatch or Noread					

4-Profile Card.

Binary Calculations

Data switch settings for values 51 to 255 must be determined by the user with binary calculation. (Specifically, the timeout values for 51 to 255 in mode 9 and various serial trigger character selections in mode 10.)

The eight data switches on the profile card represent the eight data bits that define any number from 0 to 255 in binary format. To convert a number to its binary equivalent:

1. Determine which decimal equivalent (1, 2, 4, 8, 16, 32, 64, 128) is the largest number not exceeding the number to convert.
2. Put a one (1) above that number to indicate an ON position.

For example, table 4-2 shows the calculation process for the number 250. The first one (1) is placed in the eighth bit column over the number 128, since that is the largest possible decimal equivalent to use.

Table 4-2 Calculating Binary Conversion

Data Switches								<input checked="" type="checkbox"/> = On	<input type="checkbox"/> = Off
1	2	3	4	5	6	7	8	Data Switches (bit representation)	
<input type="checkbox"/>	<input checked="" type="checkbox"/>	<input type="checkbox"/>	<input checked="" type="checkbox"/>	<input checked="" type="checkbox"/>	<input checked="" type="checkbox"/>	<input checked="" type="checkbox"/>	<input checked="" type="checkbox"/>	Data Switch Settings	
	1		1	1	1	1	1	Binary Code	
	2		10	26	58	122		Remainder Numbers	
							250	<--- Number to Convert	
1	2	4	8	16	32	64	128	Decimal Equivalent	

3. Subtract the decimal equivalent from the original number.
4. Place the remainder above the next largest decimal equivalent that does not exceed the remainder number.
5. Put a one (1) above that number.
6. Continue this process until the remainder equals zero (0), as follows:

$$250 - 128 = 122, -64 = 58, -32 = 26, -16 = 10, -8 = 2, -2 = 0$$

OFF positions on the data switches result from:

- Decimal equivalent numbers **passed over** because they are greater than the remainder (the third bit in table 4-2),
- Decimal equivalent numbers **not used** because the formula has terminated with a remainder of zero (0) (the first bit in table 4-2).

4-Profile Card.

Chapter 5

Operational Commands

Chapter Contents

Summary of Operational Commands	5-2
Program Management Commands.....	5-3
Device Control Commands.....	5-3
Code Type Commands.....	5-4
Counter Commands.....	5-4
Test Commands	5-5
Status Commands	5-5
Master Label Commands.....	5-5

This chapter describes of all serial operational commands and their functions. See table 5-1 on page 5-2 for quick reference.

On-line serial operational commands are sent from the host to the decoder to carry out routine operations “on the fly” as distinguished from serial configuration commands which are generally used in initial setup.¹

Operational commands are preceded by a < left angle bracket symbol (unless redefined by Command Start Character command) and followed by a > right angle bracket symbol.²

-
1. The decoder will only recognize a <D> serial command (Enter Menu Configuration Program) from an auxiliary terminal.
 2. Command start character by default is a left angle bracket, <. It may be redefined by menu or serial command. However, the end character, a right angle bracket, >, cannot be changed.

Summary of Operational Commands

Table 5-1 Summary of Operational Commands

Command Type	Command	Result
Program Management	<A>	Software Reset (does not save for power-on)
	<D>	Enter Configuration Mode
	<Z>	Save Configuration for Power-on
Device Control	<Bdata>	Echo Data to Aux Monitor
	<H>	Enable Laser Scanning
	<I>	Disable Laser Scanning
	<L>	Host Relay Driver
Code Types	<P>	Autodiscriminate All Codes
	<Q>	Enable Code 39 Only*
	<R>	Enable Codabar Only*
	<S>	Enable 1 2 Of 5 Only*
Counters	<N>	Noread Counter
	<O>	Noread Counter Reset
	<T>	Trigger Counter
	<U>	Trigger Counter Reset
	<V>	Match Code (or Good Read) Counter
	<W>	Match Code Counter Reset
	<X>	Mismatch Counter
	<Y>	Mismatch Counter Reset
Test	<C>	Enter Read Rate Test
	<m>	Enter Scan Rate Test
	<J>	Exit Read Rate or Scan Rate Test
Status	<#>	Display Software Part Number
	<!>	Display Checksum of EPROM
Master Label	<E>	Enable Match Code Option*
	<F>	Disable Match Code Option*
	<G>	Store Next Label Scanned as Master Label
	<)XXXX >	Download Master Label Information
	<) >	Request Master Label Information
	<)) >	Delete Master Label Information

* Can also be accomplished in configuration menu and serial configuration command.

Program Management Commands

<A> Software Reset. Initializes all serial configuration commands in RAM and resets all counters and operating parameters. Changes for Baud Rate, Stop Bits, Code Length, etc. do not take effect until this command is sent.

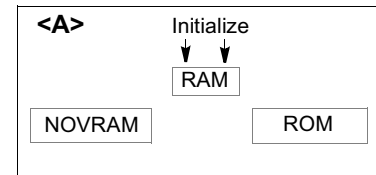

Note: Software Reset will cause the numeric counters in use to lose their count; record all data that you wish to save prior to sending this command.

<D> Enter Configuration Mode. Enters the menu configuration program. See Chapter 2, “Menu Configuration.”¹

<Z> Save Configuration for Power-on. Saves the current configuration to nonvolatile memory for availability on power-on. The values of numeric counters are not saved by this command.

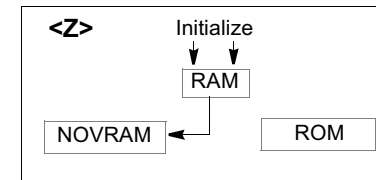

Note: The <Z> Save Configuration command can be executed 10,000 times. In normal usage this will exceed the life of the decoder. If frequent changes to the operating parameters are required, the <Z> command should be used only when the current configuration has been changed and the changes are to be permanent.

Device Control Commands

<Bdata> Echo Data to Aux Monitor. Echoes data from host to auxiliary monitor (see Appendix H, “Auxiliary Monitor,” on page A-13 for more detail).

<H> Enable Laser Scanning (Laser On).

<I> Disable Laser Scanning (Laser Off). This feature is useful during extended periods of time when no bar code labels are being scanned. Disabling laser scanning will not affect any downloaded commands to the decoder. The decoder remains active during this period.

<L> Host Relay Driver. Allows you to send a pulse (at any time regardless of Match Code or Relay Driver status) to pin 2 of the trigger connector.

Code Type Commands

<P> Autodiscriminate All Codes. Enables the decoder to decode all available bar code types without changing decoder configuration settings.

1. The <D> command is the only serial command that the MS-3000 decoder will recognize from an auxiliary terminal.

NOTE: For maximum scanning speed, enable only those bar code symbologies used in the application.

<Q> Enable Code 39 Only. Allows only Code 39 labels to be read.

<R> Enable Codabar Only. Allows only Codabar labels to be read.

<S> Enable I 2 of 5 Only. Allows only Interleaved 2 of 5 labels to be read.

Counter Commands

The Xs in all counter commands denote a numeric value from 00000 to 65,535. After reaching the maximum numeric limit of 65,535, you will receive an error message and the counter will automatically rollover and start counting again at 00000. To obtain the cumulative total of counts after the rollover has occurred, add 65,536 per each rollover (the decoder does not keep track of the number of rollovers) to the current count.

Note: *You will lose all counter values if power to the decoder is cycled, when sending the <A> command, or upon entering and exiting configuration setup menus.*

Note: *If you activate the counter command during a read cycle, the decoder will not output the count until the read cycle ends.*

<N> Noread Counter. The message N/XXXXX displays the total number of noreads that have occurred since power-on or the last Noread Counter Reset command.

<O> Noread Counter Reset. Sets Noread Counter to 00000.

<T> Trigger Counter. The message T/XXXXX displays the total number of triggers since power-on or the last Trigger Counter Reset command.

<U> Trigger Counter Reset. Sets the trigger counter to 00000.

<V> Match Counter (or Good Read Counter). The message V/XXXXX displays the total number of good reads matching the master label since power-on or the last Match Counter Reset command. This counter is always enabled, but will only work as a match count when Match Code option is enabled. If the Match Code option is not enabled, this counter adds the number of good reads, or decodes. This count can be requested at any time.¹

<W> Match Counter Reset. Sets the Match Counter to 00000.

<X> Mismatch Counter. The message X/XXXXX displays the number of labels successfully read that do not match the master label since power-on or the last Mismatch Counter command.

<Y> Mismatch Counter Reset. Sets the Mismatch Counter to zero.

1. Can also be used as a good read counter when Match Code is not enabled.

Test Commands

<C> Enter Read Rate Test. Instructs the decoder to output the percentage of scans decoded. The read rate can vary dramatically due to the angle and location of the label in relation to the scan beam. This test is very useful in aligning and positioning the scan head during installation.

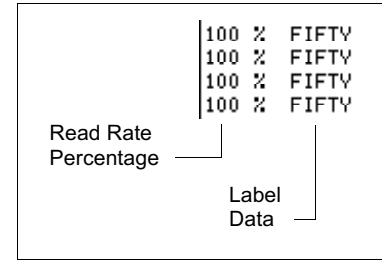

<m> Enter Scan Rate Test. Displays the current number of scans per second produced by the spinning mirror.

<J> Exit Read Rate or Scan Rate Test. Ends the read rate test or scan rate test and returns to read or ready mode.

Status Commands

<#> Display Software Part Number. Displays software part number.

<!> Display Checksum of EPROM. Displays a four-digit hex number (corresponding to a given firmware version) used to verify a decoder's EPROM.

Master Label Commands

<E> Enable Match Code Option. Identical to Match Code command on page 2-19.

Instructs the decoder to compare bar code labels being scanned with a master label that has been entered in nonvolatile or volatile RAM, and may under certain conditions send a relay driver signal to pin 2 of the trigger connector. If no master label has been entered, every decoded label will be a "mismatch" and will increment the mismatch counter by one.

Enable Match Code Option is intended for use when the decoder is in a triggered mode. If the Match Code option is enabled in the Continuous Read mode, the decoder defaults to Continuous Read 1 Output mode, and the label data must change before the decoder will output data again, unless a timeout, if enabled, occurs.

See "Match Code" on page 2-19 and "Relay Driver" on page 2-30.

<F> Disable Match Code Option. Disables Match Code.

<G> Store Next Label Scanned as Master Label. Causes the decoder to use the next bar code label read as the master label if Match Code option has been enabled. All subsequently decoded labels are compared against the master label information stored in RAM. (See "Match Code" on page 2-19.)

<)XXXX> Download Master Label Information. Downloads master label information from the host or a terminal. The master label information can be

downloaded at any time, and can be saved in nonvolatile memory with a <Z> command. A stored master label will not affect standard operation unless Match Code option is enabled.

The Xs denote alphanumeric data, from 1 to 31 characters.

<> Request Master Label Information. Immediately sends the master label information to the host. To prevent conflicts with outputting label data, first send the <I> command (Disable Laser Scanning (Laser Off)).

<))> Delete Master Label Information. Deletes master label information that has previously been loaded by either <)XXXX)> Download Master Label Information Command or <G> Store Next Label as Master Label command.

Note: *If the master label information has previously been stored in nonvolatile RAM (by a <Z> command), sending an <A> Reset or cycling the power will restore that information.*

Appendices

Contents

Appendix A — Decoder Specifications	A-2
Appendix B — ASCII Table.....	A-3
Appendix C — Defaulting the Decoder.....	A-4
Appendix D — Troubleshooting.....	A-6
Appendix E — Interfacing with the MS-90 Scan Head	A-9
Appendix F — Bar Code Symbology	A-11
Appendix G — Interface Standards	A-12
Appendix H — Auxiliary Monitor	A-13
Appendix I — Multidrop Communications.....	A-17
Appendix J — Glossary of Terms	A-21

Appendix A — Decoder Specifications

Mechanical (MS-2000)

Length: 5.8 in. (147.3 mm) Width: 5.8 in. (147.3 mm)
 Height: 1.0 in. (25.4 mm) Weight: 7.5 oz. (213 grams)

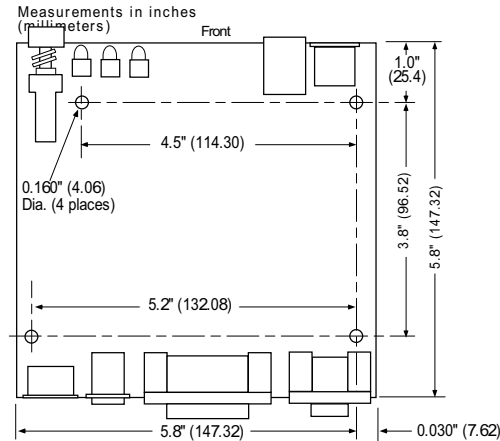

Figure A-1 MS-2000

Mechanical (MS-3000)

Length: 6.2 in. (157.5 mm) Width: 6.6 in. (167.6 mm)
 Height: 1.35 in. (34.3 mm) Weight: 16 oz. (453 grams)

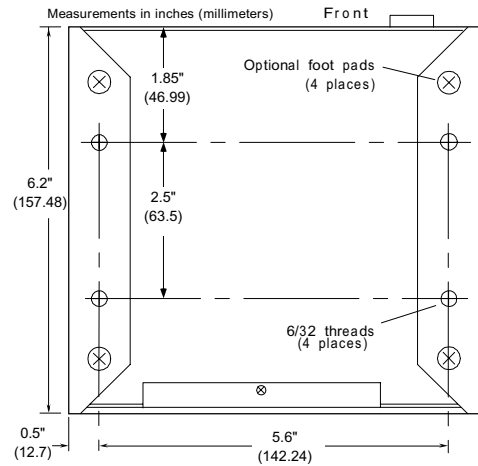

Figure A-2 MS-3000

Electrical Characteristics

Power Supply Requirements:
 +12 VDC regulated @ 40 mA maximum
 with 20 mV p-p max. ripple
 -12 VDC regulated @ 40 mA maximum
 with 20 mV p-p max. ripple
 +5 VDC regulated @ 300 mA maximum
 with 200 mV p-p max. ripple

Default Communications Settings

Baud Rate: 9600
 Parity: Even
 Stop Bits: One
 Data Bits: Seven

Environment

Operating Temperature: 32° to 113°F (0° to 45°C)
 Storage Temperature: -58° to 158°F (-50° to 70°C)
 Humidity: Up to 95% (non-condensing)

Status Lights

Table A-1 Status Lights

Mode	IND 1 (lighted) ^a	IND 2 (lighted) ^b
Continuous Read or Continuous Read 1 Output	Faintly flashes when a good read occurs.	Flashes when a good read occurs.
Triggered Mode (External or Serial Trigger)	Illuminates at the end of a read cycle and remains ON until a new trigger occurs.	Illuminates when a good read occurs and remains ON until a new trigger occurs.
Polled Mode (Multidrop, Polling Mode D, and User Defined Multidrop)	User defined.	Illuminates when a good read occurs and remains ON until the scanner's data is sent to the concentrator.

^a IND 1 LED indicates a good read. Illuminates red when a serial data overflow occurs and green when a bar code label is decoded.

^b IND 2 LED indicates a "ready" condition. Illuminates red at the end of a read cycle, indicating that the scanner is ready to accept a new trigger.

Appendix B — ASCII Table

Table A-2 ASCII Table with Control Characters

Dec	Hex	Mne	Ctrl	Dec	Hex	Ch	Dec	Hex	Ch	Dec	Hex	Ch
00	00	NUL	^@	32	20	SP	64	40	@	96	60	`
01	01	SOH	^A	33	21	!	65	41	A	97	61	a
02	02	STX	^B	34	22	"	66	42	B	98	62	b
03	03	ETX	^C	35	23	#	67	43	C	99	63	c
04	04	EOT	^D	36	24	\$	68	44	D	100	64	d
05	05	ENQ	^E	37	25	%	69	45	E	101	65	e
06	06	ACK	^F	38	26	&	70	46	F	102	66	f
07	07	BEL	^G	39	27	'	71	47	G	103	67	g
08	08	BS	^H	40	28	(72	48	H	104	68	h
09	09	HT	^I	41	29)	73	49	I	105	69	i
10	0A	LF	^J	42	2A	*	74	4A	J	106	6A	j
11	0B	VT	^K	43	2B	+	75	4B	K	107	6B	k
12	0C	FF	^L	44	2C	,	76	4C	L	108	6C	l
13	0D	CR	^M	45	2D	-	77	4D	M	109	6D	m
14	0E	SO	^N	46	2E	.	78	4E	N	110	6E	n
15	0F	SI	^O	47	2F	/	79	4F	O	111	6F	o
16	10	DLE	^P	48	30	0	80	50	P	112	70	p
17	11	DC1	^Q	49	31	1	81	51	Q	113	71	q
18	12	DC2	^R	50	32	2	82	52	R	114	72	r
19	13	DC3	^S	51	33	3	83	53	S	115	73	s
20	14	DC4	^T	52	34	4	84	54	T	116	74	t
21	15	NAK	^U	53	35	5	85	55	U	117	75	u
22	16	SYN	^V	54	36	6	86	56	V	118	76	v
23	17	ETB	^W	55	37	7	87	57	W	119	77	w
24	18	CAN	^X	56	38	8	88	58	X	120	78	x
25	19	EM	^Y	57	39	9	89	59	Y	121	79	y
26	1A	SUB	^Z	58	3A	:	90	5A	Z	122	7A	z
27	1B	ESC	^[59	3B	;	91	5B	[123	7B	{
28	1C	FS	^\	60	3C	<	92	5C	\	124	7C	
29	1D	GS	^]	61	3D	=	93	5D]	125	7D	}
30	1E	RS	^^	62	3E	>	94	5E	^	126	7E	~
31	1F	US	^_	63	3F	?	95	5F	_	127	7F	Δ

Appendix C — Defaulting the Decoder

Defaulting the decoder resets the decoder configuration parameters to their original default values.

Defaulting is necessary if:

- You wish to quickly restore default settings to the configuration program after making some temporary changes.¹
- Communications between the decoder and another device are interrupted because of incompatible settings (for example, a terminal is set to communicate at 9600 baud, but the decoder is configured at 38.4K baud).
- The decoder has been assigned a polling address and you wish to access the decoder's menu.

Access to the configuration menus of a decoder that is in a polled mode can be forced by use of a profile card (see mode 0 in Chapter 4, "Profile Card Configuration"), or by sending the **<D>** command from an auxiliary terminal via the auxiliary RS-232 port.

Using the Profile Card

Procedure:

1. Turn power to the decoder ON.
2. Connect end of the profile card labeled "DECODER" to the decoder's host connector.
3. Set all four "MODE" switches to OFF and set number 3 "DATA" switch to ON (as shown in figure A-3).
4. Press the "LOAD" button.
5. Listen for two beeps in succession (the second louder than the first). If the beeps do not occur as described, repeat the default procedure.

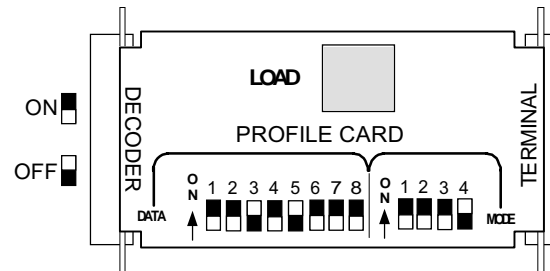

Figure A-3 Profile Card Default Setting

1. There are no menu options or host commands for resetting the configuration program.

Shorting Pins 7 and 11

If a profile card is not accessible, it is necessary to default the decoder by shorting pins 7 and 11.

Caution: Be certain that the correct pins are shorted. Shorting the wrong pins can cause serious damage to the unit.

Procedure:

1. Turn power to the decoder ON.
2. Locate pins 7 and 11 on the host connector (figure A-4) and mark with a pen.
(Use a small length of light wire approx. 4 inches, 18 to 26 gauge for shorting.)
3. Momentarily short pins 11 and 7. Listen for a series of short beeps.
Within 3 seconds, short pins 11 and 7 again. A longer beep should be heard. If not, repeat the process.

Note: Using switching power supplies as a power source is not recommended due to excessive ripple characteristics.

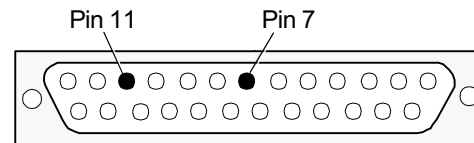

Figure A-4 Host Connector
Default Pins

Appendix D — Troubleshooting

The MS-3000 decoder, when used correctly with a properly adjusted scan head, should produce good reads (see scan head user's manual). If not, A-3 lists some of the more common problems associated with setting up and using the decoder. If you are unable to locate or correct the problem, call your Microscan representative.

Table A-3 Troubleshooting Table

Problem	Possible Cause	Solution
Power indicator does not illuminate when decoder is ON	Power supply problem	Have technician measure AC input voltage and power supply DC output voltages. Replace if power supply is not supplying correct voltages.
Menu does not display when configuration command is sent	Host cable defective or not wired properly	Check cable connections and wiring (see "Attach Cabling," on page 1-3).
	Wrong configuration command (or lower case d) sent	Verify that the <D> serial command (with an <i>upper case D</i>) is being sent.
	Decoder configuration settings do not match host's	Reset decoder to default and/or match host settings with decoder's.
Decoder does not transmit or decode labels (decoder indicator lights on but no data is displayed on screen)	Host cable defective	Ensure the cable is correctly wired (see table 1-5 on page 1-8).
	Wrong label type (different label type being scanned than that enabled in firmware)	Check label configuration settings to be certain that they match the label type being scanned. If label type is in doubt, enter <P> (the Autodiscriminate All Codes command). Ensure that Fixed Code Length and Checksums, if enabled, are set correctly.
	Poor label quality	Scan a label that is known to be good.
	Decoder not configured properly	Reset decoder to default and/or match host settings with decoder's.
	Excessive ambient light, sunlight, or strobes	Shield the bar code and/or scan head to verify that excessive light is not the problem.
	Faulty scan head	Try another scan head that is known to be good.
	Faulty cable to scan head	Try another scan head cable.

Table A-3 Troubleshooting Table (continued)

Problem	Possible Cause	Solution
Decoder does not transmit or decode labels (decoder indicator lights on but no data is displayed on screen)	Decoder is not triggered when in external mode.	Ensure trigger device is operating properly. Do Read Rate Test <C>. If it reads successfully, the problem is triggering.
	Decoder is not triggered when in serial mode.	Ensure serial trigger character is sent with start/stop characters (a left angle bracket < (unless redefined) and a right angle bracket >).
	Power supply problem	Have technician measure AC input voltage and power supply DC output voltages. Replace if power supply is not supplying correct voltages.
	External electrical noise	See "Ground and Shield Considerations," on page 1-14.
	Incorrect firmware for application	Some applications may require custom firmware. Call your Microscan representative.
Scan head motor does not rotate and laser is off (determine motor movement by feel or sound)	Scan head is not connected properly	Ensure that the modular cable is inserted into the modular connectors. Inspect cable for damage. If questionable, try another cable.
	Laser scanning disabled by the <I> serial command	Enable laser scanning with the <H> serial command
	Laser On/Off enabled	Disable Laser On/Off to make the laser operate continuously. Otherwise, decoder is operating correctly; Laser On/Off activates the laser during the read cycle only.
	Faulty scan head	Laser may not be functioning. If motor is not rotating and the laser is off, try another scan head
	Faulty cable to scan head	Try another scan head cable.
Getting only "hieroglyphics" or unintelligible code	Host and decoder baud rates or parity not matched	Check Baud Rate and Parity and change to match host's settings.
Getting only noread messages on the screen	Bar code label not readable	Try another label that is known to be readable. (Ensure that the new label is the same code type and density.)
	Incorrect label range	Refer to scan head range data in scan head manual to determine correct range. Reposition label and perform the read rate test.

Table A-3 Troubleshooting Table (continued)

Problem	Possible Cause	Solution
Getting only noread messages on the screen	Label misaligned or reflecting direct laser light	Ensure the label is not excessively skewed, tilted, or otherwise disoriented. Ensure the bar code is in the scan line when it is supposed to be. Ensure that the bar code is pitched so as to avoid specular light.
	Triggering/timeout out of sync	Review triggering and timing (chapter 2).
	Object detector or another scan head interfering with reads	Remedy by remounting, eliminating interference, or shielding. Many object detectors emit pulsed infrared signals that can seriously degrade the read rate if they shine into the scan head or onto the bar code label when it is being read.
	No signal received from the scan head	Check scan head/decoder cable, substitute another scan head, and/or see scan head troubleshooting table.
Previous label read, but subsequent label will not read	Decoder configured in Continuous One mode with New Trigger enabled	Scan a label that contains different data than that of one being read, or change End of Read Cycle to Timeout.
	Decoder in polled mode	Check communications protocol.
Decoder not communicating in polled mode.	LRC disabled	Enable LRC.
	Improper configuration	Check communications parameters (with Aux port, profile card or by defaulting unit and resetting).
	Faulty or improper cabling or ground	See "Attach Cabling," on page 1-3 for cabling advice or refer to multidrop manual.
Decoder not entering read cycle (trigger not working)	Proper trigger levels not enabled	Ensure that the trigger pulse and the trigger polarity settings are correct.
	Trigger circuit not correctly wired	Ensure that the trigger circuit wiring meets the decoder requirements (see "Attach Cabling," on page 1-3).
	Object detector inoperative	Check detector range and sensitivity. Try a detector that is known to be good.
Decoder not reading during the read cycle	Object detector not positioned properly	Ensure read cycle is active during the time the label is in the scan line.
	End of read cycle not properly defined for the application	Ensure that the proper end of read is defined in decoder configuration.

Appendix E — Interfacing with the MS-90 Scan Head

This appendix describes Label Speed, a User Outputs option (see figure A-5) that is exclusive to the MS-90 scan head.

When using a MS-90 scan head with an MS-2000/3000 decoder, it is necessary to install MS-90 firmware (35-213034-XX) that makes Label Speed available.¹

Other than the differences noted in this appendix, configuration for the MS-90 is identical to standard single scan head configuration described in this manual.

Label Speed

Default: Medium

Options: Medium, Fast, Slow

Allows you to select a response time to match a specific label speed. For information on navigating the menus, see “Using the Menu Configuration Program,” on page 2-2. The serial command format is explained below:

Format: <KYlabel speed>

label speed:

0 = Slow

1 = Medium

2 = Fast

Example: To set Label Speed to Fast, enter: <KY2>

Note: When Label Speed is set to Fast, the beeper must be disabled.

CURRENT SETTINGS FOR USER OUTPUTS	
BEEPER	= ON GOOD
BEEPER VOLUME	= LEVEL 4
LABEL SPEED	= MEDIUM
FULL SCREENS	= ENABLED
RELAY DRIVER	= MISMATCH OR NOREAD
NEW MASTER PIN	= DISABLED
GOOD/BAD POLARITY	= POSITIVE
GOOD/BAD PULSE WIDTH	= 50 ms

ESC = MAIN MENU OR EXIT	N = NEXT ITEM
M = PREVIOUS MENU	SP = NEXT ITEM
B = PREVIOUS ITEM	CR = THIS ITEM

USER OUTPUTS --> BEEPER = ON GOOD

Figure A-5 MS-90 User Outputs Menu (with Label Speed Option)

1. The MS-90 firmware does not support Aux Port, New Master Pin, Beeper Speed, or the Microscan profile card.

Appendices

Setting the correct label speed is important when using the MS-90 with the MS-3000 decoder. Tables A-6 and A-7 show label speeds in inches per second for Slow, Medium, and Fast menu label speeds for 2.5:1 ratio (as used in Code 39) and 4:1 ratio (as used in Code 128) respectively.

In general, the medium and fast settings will correspond with the high speed scan head and the slow setting will correspond with the low speed scan head (for more information, see the *MS-90 Scan Head User's Manual*).

Table A-4 Label Speeds for Code 39 in Inches per Second

Menu Setting	Narrow Bar Width Type (wide-to-narrow ratio of 2.5:1)					
	6 mil.	7.5 mil.	10 mil.	15 mil.	20 mil.	30 mil.
SLOW: <i>Min.</i>	0.4	0.5	0.7	1.0	1.4	2.1
<i>Max.</i>	10	12.9	17	25.9	34	52
MEDIUM: <i>Min.</i>	2.5	3.1	4.2	6.3	8.3	12.5
<i>Max.</i>	57	71	95	143	190	286
FAST: <i>Min.</i>	18	29	30	45.6	61	91
<i>Max.</i>	368	460	600	600	600	600

Table A-5 Label Speeds for Code 128 in Inches per Second

Menu Setting	Narrow Bar Width Type (wide-to-narrow ratio of 2.5:1)					
	6 mil.	7.5 mil.	10 mil.	15 mil.	20 mil.	30 mil.
SLOW: <i>Min.</i>	0.7	0.9	1.1	1.7	2.2	3.3
<i>Max.</i>	10	12.9	17	25.9	34	52
MEDIUM: <i>Min.</i>	4	5	6.7	10	13.3	20
<i>Max.</i>	57	71	95	143	190	286
FAST: <i>Min.</i>	29	36	48	73	97	146
<i>Max.</i>	368	460	600	600	600	600

Appendix F — Bar Code Symbology

Some factors to consider before choosing a bar code symbol are:¹

- the type of information to be scanned (numeric only, alphanumeric)
- the length of the messages to be encoded
- how and where labels are to be applied
- label printer capabilities
- scan speed
- beam width
- the space available on the object to be identified
- host software limitations
- range of the scan head
- the speed of the conveyor

Microscan standard decoder firmware supports the following five bar code symbologies. (Firmware can also be custom ordered to support other symbologies.)

Code 39. An alphanumeric code with unique start/stop code patterns, composed of 9 black and white elements per character, 3 of which are always wide.

Codabar. A 16-character set (0 through 9, and the characters \$, :, /, ., +, and –) with start/stop codes and 18 different bar widths.

I 2 of 5. Interleaved 2 of 5 is a high-density, continuous numeric symbology. I 2 of 5 encodes two digits: one in the bars, and one in the spaces. (A check digit is highly recommended.)

UPC and EAN. UPC (Universal Product Code) is a fixed length numeric, continuous symbology. The European Article Numbering system (EAN) is a well-known variation of UPC. Both UPC and EAN can have 2 or 5 digit supplemental bar code data following the normal code.

Code 128. A very high density alphanumeric symbology. Will encode all 128 ASCII characters, it is continuous, has variable length, and uses multiple element widths measured edge to edge.

1. For further information about symbology, see *The Bar Code Book*, by Roger C. Palmer, Helmers Publishing, Inc., 1989.

Appendix G — Interface Standards

Interface Standards, established by the Electronic Industries Association (EIA), specify such things as the signaling voltage levels, maximum cable lengths, and number of drivers. With Microscan devices, selection of interface is made by pin assignment and, in the case of the host communications, by software switching between RS-232 and RS-422. Microscan devices use RS-232, RS-422, and RS-485 multidrop.

RS-232

RS-232 defines an interface between two devices such as, for example, the decoder and host. It differs from the other interfaces by dedicating individual pins to specific functions and by requiring both devices to share a common ground line. Since both device chassis are connected to a common ground, a ground loop potential and the possibility of noise interference exists. Therefore cable lengths are limited to a maximum of 50 feet (15.2 m). Despite being the most limited, this interface is used frequently because of the large installed base of RS-232 equipment.

RS-422

RS-422, unlike RS-232, measures signals *differentially* that is, the receiver looks at the potentials between the two receive (or transmit) wires rather than the potential between signal and ground. As a result, cables, if shielded, can be up to 4000 feet (1219.2 m) in length. Like RS-232, RS-422 communication is designed for only two devices on a single line. It can be used wherever RS-232 is used.

RS-485

RS-485, like RS-422, can transmit up to 4000 feet (1219.2 m) using differential voltages but unlike RS-422, its transmitters are turned off until a request for data is received from the host. RS-485 is used exclusively in Multidrop protocol.

Note: See “Protocol,” on page 2-6 for additional information on standards.

Appendix H — Auxiliary Monitor

An auxiliary monitor, via a 9-pin cable connected to the decoder with a D-subminiature connector, can:

1. Echo data from the decoder or host.
2. Send data to the host.
3. Access and make changes to the decoder's configuration menus.

The monitor can be configured to operate in one of three modes:

- Transparent
- Non-Buffered Half Duplex
- Non-Buffered Full Duplex

Note: *Transparent can be used with all protocols. Full Duplex and Half Duplex operations can be used with any protocol except polled protocols. (Polling Mode D, Multidrop, User Defined, and User Defined Multidrop).*

Transparent Mode

Used to batch data from the monitor to the host. The decoder buffers data from the monitor and displays the keyed data on the monitor. The decoder transmits monitor data to the host when a label is scanned or a carriage return is entered from the monitor.

Data Initiated from the Monitor

- Monitor data is passed through to the host whenever a return key is pressed at the monitor or whenever bar code data is sent. If sent with bar code data, it is processed on a first-in/first-out basis.
- Monitor data to the host is always sent with a preamble and a postamble.
- If the decoder is in a polled mode to the host, monitor data will still pass through.
- A **<D>** command is the only command accepted by the decoder from the monitor. All other commands will pass through to the host.

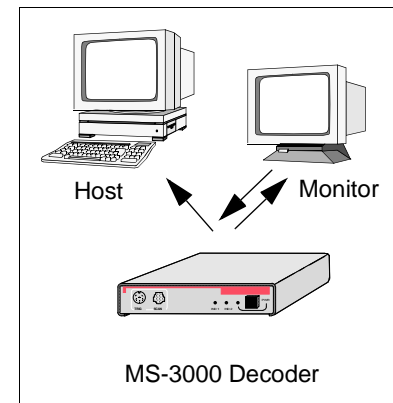

Data initiated from the Decoder

- Transmission to the monitor occurs immediately upon a good read.
- Scan data to the monitor does not include a preamble or a postamble.
- Communications with the monitor is always in Point-to-Point protocol, even if the host is in a polled protocol mode.

Data initiated from the Host

- In polled mode, data echoed from the host to the monitor must be in the format **<B ____>** (e.g., to send the word "LUNCH" to the monitor, it must be sent in the format **<BLUNCH>**).
- In unpolled mode, all host data is echoed to the monitor.

Half Duplex Mode

In half duplex mode all monitor data and bar code data is sent directly to the host. Bar code data is displayed on the monitor screen at the same time the data is sent to the host.

Data initiated from the Monitor

- Monitor data to the host is ignored if the decoder is in a polled mode.
- Monitor data or scanned data is sent to the host whenever it is received.
- Monitor data is not echoed.
- Monitor data to the host is always sent without a preamble or a postamble.

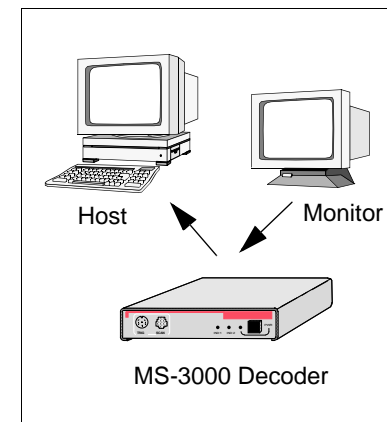
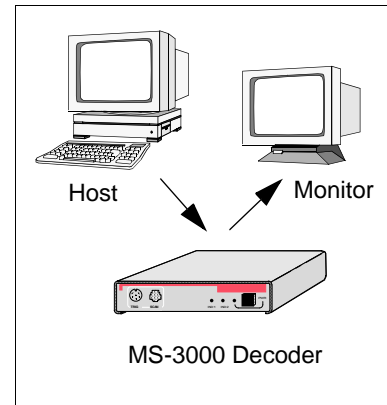
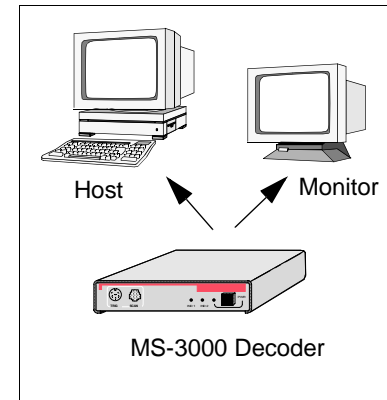

- **<D>** is the only command that is accepted by the decoder from the monitor. All other commands are passed through to the host.

Data initiated from the Decoder

- Scan data is transmitted to the monitor at the same time it is transmitted to the host.
- Data transmission conforms with all parameters specified in the configuration menu (e.g., Preamble, Postamble, End of Read Cycle).

Data is initiated from the Host

- In polled mode, data echoed from the host to the monitor must be in the format **<B____>** (i.e.: to send the word "LUNCH" to the terminal, it must be sent in the format **<BLUNCH>**).
- In unpolled mode, all host data is echoed to the monitor.

Note: For connection diagrams, see Chapter 1, "Setup and Installation."

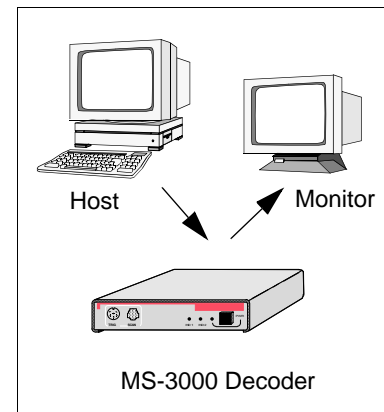
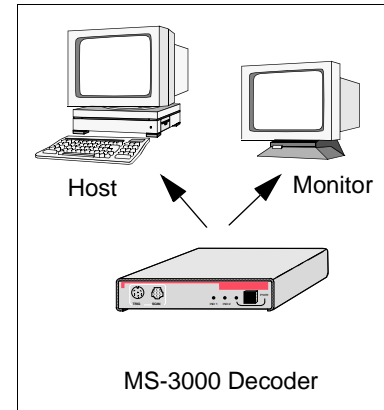

Full Duplex Mode

In full duplex mode, all monitor data and bar code data is sent directly to the host. Bar code data is not displayed on the monitor screen.

Data initiated from the Monitor

- Monitor data is passed directly through to the host whenever it is received by the MS-3000, unless the decoder is in a polled mode, in which case the data will be ignored.
- Monitor data is not echoed.
- Monitor data to the host will not have a preamble or a postamble.
- A <D> command is the only command accepted by the decoder from the monitor. All other commands will pass through to the host.

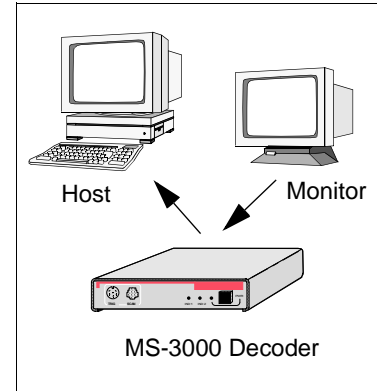

Data initiated from the Decoder

- Scan data is not sent to the monitor.

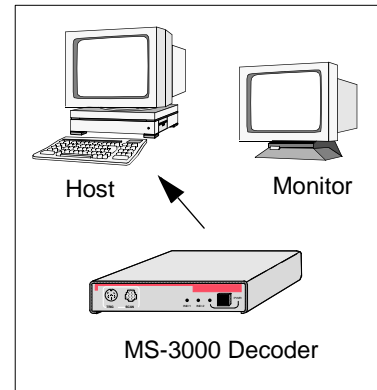

Data initiated from the Host

- In polled mode, data echoed from the host to the monitor must be in the format <B____> (for example, to send the word "LUNCH" to the terminal, it must be sent in the format <BLUNCH>).
- In unpolled mode, all host data is echoed to the monitor.

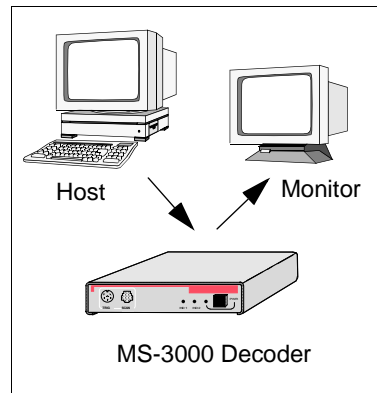

Appendix I — Multidrop Communications

This appendix describes the rules for setting up a concentrator or controller to communicate with a decoder in standard Multidrop protocol, as presented in “Protocol,” on page 2-6.

Figure A-6 shows a typical Multidrop network in which 1 to 50 scanners can communicate with a host via an intermediary device, a concentrator or a controller.

Multidrop Addresses

- No two decoder in the Multidrop Network can have the same address.
- Each decoder in the network must have an address (from 01 to 50) assigned in its configuration program.

Each address has its own separate poll and select address (from 1C to 7F hex as shown in table A-6 on page A-20).

For example, during a polling sequence, decoder 03 expects a 20 hex (“SP” ASCII poll character) from the concentrator. And during a select command, it looks for a select value 21 hex (“!” ASCII select character).

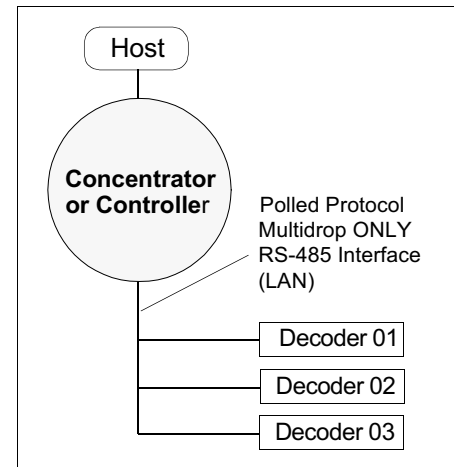

Figure A-6 Typical Multidrop Network

Polling Sequence

Data that is transmitted to the host (bar code data, noread messages, counters, etc.) via concentrators is solicited by poll requests from the host.

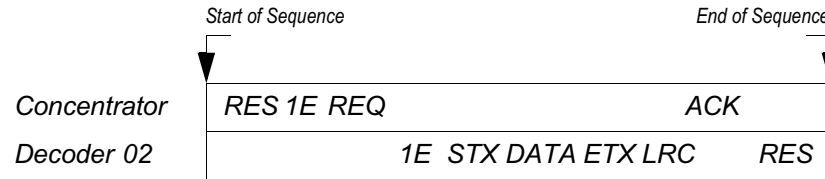

Figure A-7 Polling Sequence

The polling sequence example in figure A-7 begins with a RES (reset) from the concentrator followed by poll address 1E (ASCII hex value for Decoder 02) and a REQ (request). The decoder responds by first transmitting its own address, 1E, followed by a STX (start of text) character, and then the data. Next it transmits an ETX (end of text) character and an LRC (longitudinal redundancy check) character.

If the concentrator (or controller) receives the data from the decoder and is able to validate it with an LRC calculation, it responds with an ACK (acknowledgment). If the decoder in turn receives the ACK, the decoder ends this successful exchange with a RES (reset).

Polling Reset

- If the decoder has no information, it responds to a poll request by transmitting a RES (reset).
- If the decoder receives a NAK instead of the ACK after transmitting its data string, it will attempt to transmit the data string up to three times. If the decoder still does not receive an ACK, it will transmit a RES (reset) and discard the data in its buffers.
- If the DECODER transmits data to the concentrator and the concentrator responds with an ACK or NAK, but the decoder doesn't receive the concentrator's response, the decoder will timeout and transmit a REQ to the concentrator and request another response. If after three retries (the number of times it transmits a REQ to the concentrator) the decoder receives no response, it ends the transmission with a RES (reset).

Select Sequence

Unlike poll requests, select commands always originate from the host and consist of serial configuration or operation commands to devices that are configured in Multidrop. The decoder complies with the command when it is polled during the cycle.

Figure A-8 is an example of a select sequence.

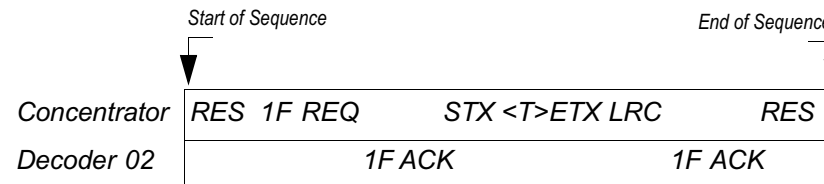

Figure A-8 Select Sequence

A RES (reset) is the first command in the select sequence. The 1F hex is the select address associated with Decoder 02 address (see table A-6 on page A-20). It is followed by a REQ (request). The decoder responds with its own select address, 1F hex, and an ACK (acknowledge). The concentrator then transmits an STX (start of text), the data (in this case a <T>), an ETX (end of text), and an LRC character.

The decoder replies by transmitting its own address, followed by an ACK, acknowledging receipt of the command. Upon receipt of an ACK, the concentrator concludes the successful exchange with a RES.

In the example above, the decoder only *acknowledges* a trigger counter request from the concentrator. It does not respond to the trigger counter request until a subsequent poll. For example, if the scanner's trigger count was 12 at the time the trigger counter request was received, on a subsequent poll it would transmit 02T/00012. (The 02 at the beginning of the string is the scanner's address.)

Select Reset

- If the decoder receives bad data from the concentrator, it transmits a SEL (its select address) and a NAK to the concentrator. The concentrator retransmits the data up to three times. The concentrator will end the sequence with a RES (reset) if no ACK is received.¹

1. For additional information on Multidrop, see the *MS-5000 Multidrop Concentrator User's Manual*.

Appendices

Table A-6 Multidrop Address Characters

Multidrop Address	Poll Character		Select Character		Multidrop Address	Poll Character		Select Character	
	ASCII	HEX	ASCII	HEX		ASCII	HEX	ASCII	HEX
01	^\ 	1C	^] 	1D	26	N	4E	O	4F
02	^^ 	1E	^- 	1F	27	P	50	Q	51
03	SP 	20	! 	21	28	R	52	S	53
04	" 	22	# 	23	29	T	54	U	55
05	\$ 	24	% 	25	30	V	56	W	57
06	& 	26	' 	27	31	X	58	Y	59
07	(28) 	29	32	Z	5A	[5B
08	* 	2A	+ 	2B	33	\	5C]	5D
09	, 	2C	- 	2D	34	^ 	5E	_	5F
10	. 	2E	/ 	2F	35	` 	60	a	61
11	0 	30	1 	31	36	b 	62	c	63
12	2 	32	3 	33	37	d 	64	e	65
13	4 	34	5 	35	38	f 	66	g	67
14	6 	36	7 	37	39	h 	68	i	69
15	8 	38	9 	39	40	j 	6A	k	6B
16	: 	3A	; 	3B	41	l 	6C	m	6D
17	< 	3C	= 	3D	42	n 	6E	o	6F
18	> 	3E	? 	3F	43	p 	70	q	71
19	@ 	40	A 	41	44	r 	72	s	73
20	B 	42	C 	43	45	t 	74	u	75
21	D 	44	E 	45	46	v 	76	w	77
22	F 	46	G 	47	47	x 	78	y	79
23	H 	48	I 	49	48	z 	7A	{	7B
24	J 	4A	K 	4B	49	 	7C	}	7D
25	L 	4C	M 	4D	50	~ 	7E	Δ	7F

Appendix J — Glossary of Terms

Autodiscriminate. The ability to decode various bar code symbologies without changing configuration.

AWG. Abbreviation for American Wire Gauge. This is a standard measuring system for wire sizes, listed from 0 (biggest) to 40 (smallest). A 26 AWG is equivalent to 0.0159 in. (0.405 mm) in diameter.

Bar Code. Data that has been encoded into an array of parallel bars and spaces of varying widths.

Bar Code Density. Number of characters per inch or other unit of measure.

Baud Rate. The term used to describe the number of discrete conditions or signal events per second. In RS-232 and RS-422/485 systems, baud rate is the same as bits per second (bps).

Blurring. Congestion of bars and spaces, typically occurring when scanning at severe angles and/or distances, to a point that the scan beam is distorted and individual bar code elements are not discerned.

Code 39. An alphanumeric bar code with a character set containing a start/stop character, 10 numbers, 26 letters, 6 symbols, and a space. This code is discrete, variable length, and self-checking.

Concentrator. Intermediary device which communicates with up to 50 other devices, and relays data from those devices to the host as well as commands from the host to the devices.

Configuration. The method used to change factory default settings for operational features to match a specific application. Configuration can be done through menu selection, with serial commands, or with a profile card.

Connector. Physical device (plug or socket) on unit to provide in/out connectivity for various circuits and pins.

Counter. Memory space provided to keep track of read cycle events.

Decoder. A device that analyzes digital input provided by the scan head and translates it into bar code information.

Depth of Field. The distance between the minimum and maximum range in which a scan head can read bar code labels.

EPROM. Erasable, programmable, read only memory. The EPROM stores the coded information that contains decoding algorithms and options that can be changed by the user.

End of Read Cycle. The time at which the decoder stops expecting label information to decode. This can be caused by a timeout, a trigger event, or a good read.

Focal Length. The distance measured from the scan head to the center of the depth of field, or *focal point*.

Good/Bad Pulses. TTL signals sent by the decoder to indicate to a controlling device that a good or bad read has occurred.

Good Match. The event occurring when a scanned bar code label matches the master label information that is stored in the memory of the decoder.

Good Read. The event occurring when a label's data is accurately scanned and decoded.

Intercharacter Gap. The extra space between the last element of one character and the first element of the adjacent character of a discrete bar code symbol.

Label Height. Regardless of orientation, the measurement taken along the length of a label's individual bars.

Label Length. Regardless of orientation, the measurement taken across the label's bars from one end to the other, including the quiet zone.

Label Speed. The rate in inches or centimeters per second that a label moves through the scan beam.

Ladder Label Orientation. A bar code label in which the bars are parallel to the direction of travel.

Match Code. The ability to compare bar code labels being scanned against a master label that is stored in the memory of the decoder.

Menu Configuration. The process of changing factory default settings via a sequence of menus displayed on a terminal monitor.

Mil. One thousandths of an inch or 0.0254 mm. In bar-coding, a measurement that identifies a bar code label by the width of its narrowest element.

Mismatch. An event that occurs when the scanned bar code label does not match the master label that is stored in the memory of the decoder.

Multidrop. A communications protocol for networking two or more decoders or other devices with a concentrator (or controller) and characterized by the use of individual device addresses and the RS-485 standard.

Narrow Bar Width. The width of the narrowest bar of a given label, expressed in thousands of an inch (or mils).

Noread. A non-read. A condition that occurs when the decoder is set up to decode labels, and no labels are scanned during the read cycle.

Number of Scans Calculation. The number of times a bar code label is scanned by the decoder during one pass through the laser beam.

Object Detector. A photo electric device used to sense to presence or absence of an object.

Operational Commands. Serial commands from the host to the decoder to control current operating parameters, counters, master label operations, and program management.

Oval Spot. An elongated laser beam involving custom optics that is designed to project lengthwise with the label's bars and spaces.

Picket Fence Label Orientation. A bar code label in which the bars are perpendicular to the direction of travel.

Pitch. Label (or scan head) rotation around the center line perpendicular to the label's bars.

Point-to-Point. A protocol consisting of a single communications event, typically used to connect a bar code reader to a CRT terminal or a host computer.

Polled Protocol. A protocol in which each decoder or other device has an assigned address which is used by the host when requesting data.

Port. Logical circuit for data entry and exit. (One or more ports may be included within a single connector.)

Protocol. The rules for communication between devices, providing a means to control the orderly communication of information between linked devices.

Quiet Zones. Specified "clear" (nonprinted) areas immediately before and after the bar code symbol. The area is usually white (for black and white bar code) and at least 10 times the width of the narrowest bar, as measured in thousands of an inch. The zones can be other than white as long as their densities remains consistent and they have the required contrast relative to the bars.

Read Cycle. A programmed period of time or condition during which the decoder will accept bar code label input.

Read Range. The distances in which a label can be reliably read, as measured from the front of the scan head. See "Depth of Field."

Read Rate. The percentage of reads decoded by the decoder.

Relay Driver. A TTL signal sent by the decoder. The output is determined by the relay driver selection during configuration.

Round Spot. The standard laser beam as it appears on the label being scanned, sometimes slightly ovalized.

Scanner. A scanning device which is comprised of a scan head and a decoder integrated in one package.

Scan Head. The module that projects laser light on bar code labels and receives reflected light back. This device changes the analog signal to a digital representation of the bar code and outputs it to a decoder.

Scan Width. The measurement (inches or centimeters) of the scan beam line at the readable scan range of a given application.

Serial Commands. On-line data strings (including configuration and operations) from a host or other terminal to the decoder, which are always preceded by a < left angle bracket symbol (unless redefined by Command Start Character command) and followed by a > right angle bracket symbol.

Skew. Label (or scan head) rotation around the center of the skew axis.

Specular Reflection. The direct, mirror-like reflection of laser light back to the scan head, causing over-light saturation.

Symbology. A set of bar code symbols, such as Code 39 or Code 128, which have special rules to define the widths and positions of bars and spaces to represent specific numeric or alphanumeric information.

Tilt. Label (or scan head) rotation around the centerline of the scan beam.

Timeout. A user-selected period of time that ends a decoder's read cycle.

Trigger. A signal, either external or serial, that initiates the read cycle and causes the decoder to expect label input.

TTL. Abbreviation for transistor-transistor logic, the standard for signal output.

Wide-to-narrow Ratio. The ratio of the width of the widest (or wider) bar to the narrowest bar of a given bar code symbology. For example, 2:1, 2.5:1, 3:1, and 4:1.

Index

A

- ACK-NAK Protocol 2-8
- Approvals vii
- As Soon As Possible
 - by menu selection 2-18
 - by profile card (mode 8) 4-9
 - by serial command 3-11
- ASCII
 - table (with control characters) A-3
 - terminal communications 1-10, 2-1
- Autodiscriminate (definition) A-21
- Autodiscriminate All Codes
 - operational command 5-3
- Aux Mode
 - by menu selection 2-12
 - by profile card (mode 6) 4-8
 - by serial command 3-9
- Aux Monitor Echo Data Command 5-3
- Aux Port Parameters
 - by menu selection 2-11–2-12
 - by profile card (mode 6) 4-8
 - by serial command 3-9
- Auxiliary Monitor A-13

B

- Bar Code Output
 - by menu selection 2-18
 - by profile card (mode 8, enable/disable only) 4-9
 - by serial command 3-11
- Bar Code Symbology A-10
- Baud Rate (aux port)
 - by menu selection 2-10, 2-12
 - by serial command 3-9
- Baud Rate (host port)
 - by menu selection 2-10
 - by profile card (mode 3) 4-6
 - by serial command 3-8
- Beep on Serial Command
 - by serial command 3-15
- Beep on Serial Command 2-32

- Beeper (options/volume/speed)
 - by menu selection 2-29–2-30
 - by profile card (mode 13) 4-11
 - by serial command 3-14
- Bottom Offset in Degrees
 - by menu selection 2-34
 - by serial command 3-17

C

- Cabling 1-3
- Carriage Returns (as characters) 2-4
- Check Digit
 - of code 39 (menu) 2-23
 - of code 39 (serial) 3-12
 - of interleaved 2 of 5 (menu) 2-25
 - of interleaved 2 of 5 (serial) 3-13
- Check Digit Output
 - of code 39 (menu) 2-23
 - of code 39 (serial) 3-12
 - of interleaved 2 of 5 (menu) 2-26
 - of interleaved 2 of 5 (serial) 3-13
- Checksum of EPROM (display)
 - operational command 5-5
- Clear-to-send 1-8
- Codabar
 - by menu selection 2-24–2-25
 - by profile card (mode 12, enable/disable only) 4-11
 - by serial command 3-12
 - definition A-11
 - operational command 5-4
 - See also Check Digit, Check Digit Output, Large Intercharacter Gap, Fixed Code Length, and Code Length
- Code 128
 - by menu selection 2-28
 - by profile card (mode 12, enable/disable only) 4-11
 - by serial command 3-13
 - definition A-11
- Code 39
 - by menu selection 2-23–2-24

Index

- by profile card (mode 12, enable/disable only)* 4-11
 - by serial command* 3-12
 - definition A-11
 - operational command* 5-4
 - See also *Check Digit, Check Digit Output, Large Intercharacter Gap, Fixed Code Length, and Code Length*
 - Code Length
 - of codabar (menu)* 2-25
 - of codabar (serial)* 3-12
 - of code 128 (menu)* 2-28
 - of code 128 (serial)* 3-13
 - of code 39 (menu)* 2-24
 - of code 39 (serial)* 3-12
 - Code Length #1 (1 2 of 5)
 - by menu selection* 2-26
 - by serial command* 3-13
 - Code Length #2 (1 2 of 5)
 - by menu selection* 2-26
 - by serial command* 3-13
 - Code Types
 - by menu selection* 2-22–2-28
 - by profile card* 4-11
 - by serial command* 3-12–3-13
 - See also *Narrow Margins, Code 39, Codabar, Interleaved 2 of 5, UPC/EAN, and Code 128*
 - Code Types Status Request
 - by serial command* 3-13
 - Command Start Character
 - by menu selection* 2-32
 - by serial command* 3-16
 - Communications
 - by menu selection* 2-5–2-12
 - by profile card* 4-6–4-8
 - by serial command* 3-6–3-9
 - default settings A-2
 - See also *Protocol, Preamble, Postamble, Longitudinal Redundancy Check, Response Timeout, Intercharacter Delay, Baud Rate, Parity, Stop Bits, Data Bits, RS-422, and Aux Mode*
 - Concentrator A-17, A-21
 - Configuration
 - entering configuration menus* 2-2, 5-3
 - saving menu changes for power-on* 2-4
 - saving profile card changes for power-on* 4-3
 - saving serial changes for power-on* 5-3
 - Connectors 1-3–1-9
 - Continuous Read
 - by menu selection* 2-14
 - by profile card (mode 7)* 4-8
 - Continuous Read 1 Output
 - by menu selection* 2-14
 - by profile card (mode 7)* 4-8
 - Control Character Output (Echo K)
 - by menu selection* 3-15
 - Controller A-17
- ## D
- Data Bits (aux port)
 - by menu selection* 2-11, 2-12
 - by serial command* 3-9
 - Data Bits (host port)
 - by menu selection* 2-11
 - by profile card (mode 3)* 4-6
 - by serial command* 3-8
 - DCE connector 1-9
 - Decoder Specifications A-2
 - Defaulting A-4–A-5
 - DTE connector 1-9
- ## E
- EAN. See *UPC/EAN*
 - Electrical Specifications A-2
 - Electronic Industries Association A-12
 - End of Read Cycle
 - by menu selection* 2-16–2-17
 - by profile card (mode 7)* 4-8
 - by serial command* 3-10
 - when to output option (menu)* 2-18
 - when to output option (profile card)* 4-9
 - when to output option (serial)* 3-11

- Environmental Specifications A-2
- EPROM A-21
- External Edge
 - by menu selection* 2-15
 - by profile card (mode 7)* 4-8
- External Level
 - by menu selection* 2-14
 - by profile card (mode 7)* 4-8
- External Trigger Polarity
 - by menu selection* 2-18
 - by profile card (mode 8)* 4-9
 - by serial command* 3-10
- F**
- Field Separator
 - by menu selection* 2-21
- Fixed Code Length
 - of codabar (menu)* 2-25
 - of codabar (serial)* 3-12
 - of code 128 (menu)* 2-28
 - of code 128 (serial)* 3-13
 - of code 39 (menu)* 2-24
 - of code 39 (serial)* 3-12
- Full Duplex Mode
 - by menu selection* 2-12
 - by profile card (mode 6)* 4-8
 - by serial command* 3-9
 - description* A-16
- Full Screens
 - by menu selection* 2-30
 - by profile card (mode 14)* 4-12
- G**
- Good Decode Reads. *See Number of Reads Before a Good Decode*
- Good Match
 - by menu selection* 2-30
 - by profile card (mode 14)* 4-12
 - by serial command* 3-14
- Good Read Counter
 - operational command* 5-4
- Good/Bad Polarity
 - by menu selection* 2-31
 - by profile card (mode 14)* 4-12
 - by serial command* 3-16
- Good/Bad Pulse Width
 - by menu selection* 2-32
 - by serial command* 3-16
- Ground and Shield Considerations 1-14
- Ground Loops 1-14
- H**
- Half Duplex Mode
 - by menu selection* 2-12
 - by profile card (mode 6)* 4-8
 - by serial command* 3-9
 - description* A-14–A-15
- Host Connector 1-7–1-9
- Host Port Parameters
 - by menu selection* 2-10–2-11
 - by profile card (mode 3)* 4-6
 - by serial command* 3-8
- Host Protocol Parameters
 - by menu selection* 2-6–2-10
 - by profile card* 4-7
 - by serial command* 3-6–3-9
- Host Relay Driver
 - operational command* 5-3
- I**
- I 2 of 5. *See Interleaved 2 of 5*
- Installation 1-12–1-13
- Intercharacter Delay
 - by menu selection* 2-10
 - by serial command* 3-8
- Intercharacter Gap A-22
- Interface Standards A-12
- Interleaved 2 of 5
 - by menu selection* 2-25–2-26
 - by profile card (mode 12, enable/disable only)* 4-11
 - by serial command* 3-13
 - definition* A-11
 - operational command* 5-4

Index

See also *Check Digit*, *Check Digit Output*, *Code Length #1*, and *Code Length #2*

L

Label Speed
MS-90 A-9

LAN Connector 1-7

Large Intercharacter Gap
of codabar (menu) 2-25
of codabar (serial) 3-12
of code 39 (menu) 2-24
of code 39 (serial) 3-12

Laser On/Off
by menu selection 2-31
by profile card (mode 14) 4-12
by serial command 3-14
operational command (enable and disable) 5-3

Longitudinal Redundancy Check
by menu selection 2-10
by serial command 3-8

LRC. See *Longitudinal Redundancy Check*

M

Master Label Commands 5-5–5-6

Match Code
by menu selection 2-19–2-20
by profile card (mode 8) 4-9
by serial command 3-11
definition A-22
operational command (enable and disable) 5-5

Match Counter Commands 5-4

Mechanical Specifications A-2

Menu Configuration Program
code types menu 2-22–2-28
communications menu 2-5–2-12
entering 5-3
how to use 2-2
loss of communications/when to default 2-4
operations menu 2-13–2-21

raster setup menu 2-33–2-34
regaining access 3-4
saving changes 2-4
user outputs menu 2-29–2-32

Mismatch

by menu selection 2-30
by profile card (mode 14) 4-12
by serial command 3-14

Mismatch Counter Commands
operational command 5-4

Mismatch or Noread

by menu selection 2-30
by profile card (mode 14) 4-12
by serial command 3-14

Modulus 43 2-23

Monitor Connector 1-9

Motor Speed. See *Sweeps per Second*

Mounting Diagrams 1-12–1-13

MS-90 Scan Head A-9

Multidrop

by menu selection 2-7
by profile card (mode 5) 4-7
by serial command 3-6
definition A-22

Multidrop Address A-20

Multidrop Address Characters A-20

Multidrop Communications A-17–A-20
multidrop addresses A-17
polling sequences A-18
select sequences A-19

N

Narrow Bar Width A-22

Narrow Margins

by menu selection 2-23
by profile card (mode 12) 4-11
by serial command 3-12

New Master Pin

by menu selection 2-31
by profile card (mode 14) 4-12
by serial command 3-14

New Trigger

- by menu selection* 2-16
- by profile card (mode 7)* 4-8
- Noise Interference 1-14, A-12
- Noread (relay driver option)
 - by menu selection* 2-30
 - by profile card (mode 14)* 4-12
 - by serial command* 3-14
- Noread Counter Commands
 - operational command* 5-4
- Noread Message
 - by menu selection* 2-18
 - by profile card (mode 8)* 4-9
 - by serial command* 3-11
- Nulls (as characters) 2-4
- Number of Labels
 - by menu selection* 2-21
 - by serial command* 3-11
- Number of Reads Before a Good Decode
 - by menu selection* 2-19
 - by profile card (mode 11)* 4-10
 - by serial command* 3-11

O

- Object detector 1-4
- Operational Commands Summary 5-2
- Operations
 - by menu selection* 2-13–2-21
 - by profile card* 4-8–4-10
 - by serial command* 3-10–3-11
 - See also *Triggering Mode, End of Read Cycle, Timeout, Serial Trigger Character, External Trigger Polarity, Noread Message, Bar Code Output, When to Output, Number of Reads, Match Code, Number of Labels, and Field Separator*
- Operations Status Request
 - by serial command* 3-11

P

- Parity (aux port)
 - by menu selection* 2-10, 2-12

- by serial command* 3-9
- Parity (host port)
 - by menu selection* 2-10
 - by profile card (mode 3)* 4-6
 - by serial command* 3-8
- PLC (programmable logic controller) 1-7
- Point-to-Point
 - by menu selection* 2-6
 - by profile card (mode 5)* 4-7
 - by serial command* 3-6
- Point-to-Point with RTS/CTS
 - by menu selection* 2-6
 - by profile card (mode 5)* 4-7
 - by serial command* 3-6
- Point-to-Point with RTS/CTS & XON/XOFF
 - by menu selection* 2-7
 - by profile card (mode 5)* 4-7
 - by serial command* 3-6
- Point-to-Point with XON/XOFF
 - by menu selection* 2-7
 - by profile card (mode 5)* 4-7
 - by serial command* 3-6
- Poll Character A-20
- Polling Mode D
 - by menu selection* 2-7
 - by profile card (mode 5)* 4-7
 - by serial command* 3-6
- Postamble
 - by menu selection* 2-9
 - by profile card (mode 4, enable/disable only)* 4-7
 - by serial command* 3-7
- Power Connector 1-6
- Preamble
 - by menu selection* 2-9
 - by profile card (mode 4, enable/disable only)* 4-7
 - by serial command* 3-7
- Product Approvals. See *Approvals*
- Profile Card
 - binary calculation* 4-13
 - defaulting* A-4

Index

summary of modes 4-2

Protocol

- by menu selection* 2-6
- by profile card (mode 5)* 4-7
- by serial command* 3-6

Q

Quiet Zones 2-23, A-23

R

Raster Setup

- by menu selection* 2-33–2-34
- by serial command* 3-17
- See also Top Offset in Degrees, Bottom Offset in Degrees, and Sweeps per Second*

Read Cycle A-23

Read Rate Test

- operational commands (enter and exit)* 5-5
- procedure* 1-11

Relay Driver

- by menu selection* 2-30
- by profile card (mode 14)* 4-12
- by serial command* 3-14

Relay driver 1-4

Request-to-send 1-8

Response Timeout

- by menu selection* 2-10
- by serial command* 3-8

Reverse Video

- by menu selection* 2-31
- by profile card (mode 14)* 4-12
- by serial command* 3-15

RJ-11 type connector 1-7

RS-232 A-12

RS-422 A-12

- by menu selection* 2-11
- by profile card (mode 5)* 4-7
- by serial command* 3-8

RS-422/485 1-8

RS-485 A-12

S

Safety Labels viii

Saving Configuration Changes. *See Configuration*

Scan Head Connector 1-5

Scans per Second

- operational command* 5-5

Select Character A-20

Separator

- by serial command* 3-11

Separator/Separator Character

- by menu selection* 2-27
- by serial command* 3-13

Serial Command Echo Status

- by serial command* 3-15

Serial Command Verification

- by serial command* 3-15

Serial Configuration Commands

- concatenating* 3-4
- format* 3-2
- initializing changes* 3-4
- loss of communications/defaulting* 3-4
- saving changes* 3-4
- summary* 3-2

Serial Data

- by menu selection* 2-15
- by profile card (mode 7)* 4-8

Serial Data & Edge

- by menu selection* 2-15
- by profile card (mode 7)* 4-8

Serial Trigger Character

- by menu selection* 2-17
- by profile card (mode 10)* 4-10
- by serial command* 3-10

Software Part Number (display)

- operational command* 5-5

Software Reset

- operational command* 5-3

Spaces (as characters) 2-4

Start & Stop Match

- by menu selection* 2-24
- by serial command* 3-12

Start & Stop Output
by menu selection 2-24
by serial command 3-12

Status Lights A-2

Stop Bits (aux port)
by menu selection 2-11, 2-12
by serial command 3-9

Stop Bits (host port)
by menu selection 2-11
by profile card (mode 3) 4-6
by serial command 3-8

Supplementals
by menu selection 2-27
by serial command 3-13

Sweeps per Second
by menu selection 2-34
by serial command 3-17

System Diagram 1-2

T

Terminal Communications 2-1

Timeout & New Trigger
by menu selection 2-17
by profile card (mode 7) 4-8

Timeout (end of read cycle option)
by menu selection 2-16
by profile card (mode 7) 4-8

Timeout in 10 ms incs
by menu selection 2-17
by profile card (mode 9) 4-9

Top Offset in Degrees
by menu selection 2-33
by serial command 3-17

Transparent Mode
by menu selection 2-12
by profile card (mode 6) 4-8
by serial command 3-9
description A-13–A-14

Trigger Connector 1-4

Trigger Counter Commands
operational command 5-4

Trigger Filter Timing Value 3-5

Triggering Mode
by menu selection 2-14–2-15
by profile card (mode 7) 4-8
by serial command 3-10

Troubleshooting Table A-6–A-8

TTL 1-8

U

UPC/EAN
by profile card (mode 12, enable/disable only) 4-11
by serial command 3-13
definition A-11
EAN (by menu selection) 2-22, 2-26
UPC (by menu selection) 2-22, 2-26–2-27

User Defined
by menu selection 2-8
by profile card (mode 5) 4-7

User Defined Multidrop
by menu selection 2-8
by profile card (mode 5) 4-7

User Output Status Request
by serial command 3-15

User Outputs
by menu selection 2-29–32
by profile card 4-11–4-12
by serial command 3-13

User Outputs Status Request
by serial command 3-16

W

Warning and Caution Summary vii

Warranty Statement ii

When to Output
by menu selection 2-18
by profile card (mode 8) 4-9
by serial command 3-11

