

MICROSCAN.

Mobile Hawk Handheld DPM Imager User Manual



P/N 84-100021 Rev C

Copyright and Disclaimer

Copyright ©2015
Microscan Systems, Inc.
Tel: +1.425.226.5700 / 800.762.1149
Fax: +1.425.226.8250

All rights reserved. The information contained herein is proprietary and is provided solely for the purpose of allowing customers to operate and/or service Microscan manufactured equipment and is not to be released, reproduced, or used for any other purpose without written permission of Microscan.

Throughout this manual, trademarked names might be used. We state herein that we are using the names to the benefit of the trademark owner, with no intention of infringement.

Disclaimer

The information and specifications described in this manual are subject to change without notice.

Latest Manual Version

For the latest version of this manual, see the Download Center on our web site at:
www.microscan.com.

Technical Support

For technical support, e-mail: helpdesk@microscan.com.

Warranty

For current warranty information, see: www.microscan.com/warranty.

Microscan Systems, Inc.

United States Corporate Headquarters

+1.425.226.5700 / 800.762.1149

United States Northeast Technology Center

+1.603.598.8400 / 800.468.9503

European Headquarters

+31.172.423360

Asia Pacific Headquarters

+65.6846.1214

Table of Contents

Chapter 1	Quick Start	
	Check Required Hardware	1-2
	USB Interface	1-3
	RS-232 Interface	1-4
	Install ESP	1-5
	Select Model	1-6
	Select Protocol and Connect to Imager	1-7
Chapter 2	Using ESP	
	EZ Mode	2-2
	Application Mode	2-4
	Tree Controls	2-5
	Menu Toolbar	2-6
	Send/Receive	2-16
Chapter 3	Basic Operations	
	Targeting and Decoding	3-2
	Scanning Guidelines	3-3
	Decode Zones and Lighting Zones	3-4
	Illumination System	3-7
	Illumination Sequence	3-9
Chapter 4	Communications	
	Communications by ESP	4-2
	Communications Overview	4-3
	USB Interface	4-4
	RS-232 Interface	4-5
	Preamble	4-7
	Postamble	4-9
	Preamble and Postamble by ESP	4-11
	Keyboard Mapping	4-12
	Text Commands	4-13
	Other Communications Settings in ESP	4-14
Chapter 5	Read Cycle	
	Read Cycle by ESP	5-2
	Button Stay-Down Time	5-3
	Ignore Duplicate Symbol Timeout	5-4
	Region of Interest	5-5
Chapter 6	Symbologies	
	Symbologies by ESP	6-2
	Aztec	6-3
	BC412	6-4
	Codabar	6-5
	Code 39	6-6
	Code 93	6-7

Table of Contents

Code 128	6-8
Composite	6-9
Data Matrix	6-10
GS1 DataBar	6-11
Interleaved 2 of 5	6-12
MicroPDF417	6-13
PDF417	6-14
Pharmacode	6-15
QR Code	6-17
UPC/EAN	6-18
Symbology Identifier	6-19
Chapter 7 I/O Parameters	
I/O Parameters by ESP	7-2
Operational Feedback	7-3
Gain Control	7-4
Exposure	7-5
Data Validation	7-6
Chapter 8 Advanced Operations	
Dot Peen Enhanced Illumination Settings	8-2
Illumination Settings by ESP	8-3
Lock Settings	8-6
Chapter 9 Terminal	
Terminal View	9-2
Find	9-3
Send	9-4
Macros	9-5
Terminal Right-Click Menu	9-6
Terminal Dropdown Menu	9-7
Chapter 10 Utilities	
Device Control	10-2
Differences from Default	10-3
Firmware	10-4
Advanced	10-6
Appendices	
Appendix A General Specifications	A-2
Appendix B Electrical Specifications	A-4
Appendix C Default/Reset Procedure	A-7
Appendix D Maintenance	A-8
Appendix E Troubleshooting	A-9

About the Mobile Hawk Handheld DPM Imager

The key features of the Mobile Hawk Handheld DPM Imager are:

- MAXlite™ illumination technology
- Best-in-class X-Mode DPM decode algorithms
- Image Enhance optimization for difficult-to-decode direct part marks
- LED targeting pattern
- USB and RS-232 interface options
- Fast processing
- Rugged design
- Sustains 50+ drops from six feet to concrete

About This Manual

This manual provides complete information on setting up, installing, and configuring the Mobile Hawk Handheld DPM Imager. The chapters are presented in the order in which the imager would be assembled, configured, and optimized.

Highlighting

Cross-references and web addresses are highlighted in **blue bold**.

References to **ESP**, its toolbar headings (Communications, Symbologies, I/O Parameters, etc.) and menu headings are highlighted in **Bold Initial Caps**.

Statement of Agency Compliance



The Mobile Hawk has been tested for compliance with FCC regulations and was found to be compliant with all applicable FCC Rules and Regulations.

IMPORTANT NOTE: To comply with FCC RF exposure compliance requirements, this device must not be co-located or operate in conjunction with any other antenna or transmitter.

CAUTION: Changes or modifications not expressly approved by the party responsible for compliance could void the user's authority to operate the equipment.



The Mobile Hawk has been tested for compliance to CE (Conformité Européenne) standards and guidelines and was found to conform to applicable CE standards, specifically the EMC requirements: EN 55024, ESD EN 61000-4-2, Radiated RF Immunity EN 61000-4-3, EFT EN 61000-4-4, Surge EN 61000-4-5, Conducted RF Immunity EN 61000-4-6, Magnetic Field Immunity EN 61000-4-8, Voltage Dips EN 61000-4-11, Emissions EN 55022, Class B Radiated Emissions, and Class B Conducted Emission, Current Harmonic Emissions IEC 61000-3-2, Voltage Fluctuation and Flicker IEC 61000-3-3 Class B.

Statement of RoHS Compliance

All Microscan readers with a 'G' suffix in the FIS number are RoHS-Compliant. All compliant readers were converted prior to March 1, 2007. All standard accessories in the Microscan Product Pricing Catalog are RoHS-Compliant except 20-500013-01 and 98-000039-02. These products meet all the requirements of "Directive 2002/95/EC" European Parliament and the Council of the European Union for RoHS compliance. In accordance with the latest requirements, our RoHS-Compliant products and packaging do not contain intentionally added Deca-BDE, Perfluorooctanes (PFOS) or Perfluorooctanic Acid (PFOA) compounds above the maximum trace levels. To view the document stating these requirements, please visit:

<http://eur-lex.europa.eu/LexUriServ/LexUriServ.do?uri=CELEX:32002L0095:EN:HTML>

and

<http://eur-lex.europa.eu/LexUriServ/LexUriServ.do?uri=OJ:L:2006:372:0032:0034:EN:PDF>

Please contact your sales manager for a complete list of Microscan's RoHS-Compliant products.

This declaration is based upon information obtained from sources which Microscan believes to be reliable, and from random sample testing; however, the information is provided without any representation of warranty, expressed or implied, regarding accuracy or correctness. Microscan does not specifically run any analysis on our raw materials or end product to measure for these substances.

The information provided in this certification notice is correct to the best of Microscan's knowledge at the date of publication. This notice is not to be considered a warranty or quality specification. Users are responsible for determining the applicability of any RoHS legislation or regulations based on their individual use of the product.

In regards to "RoHS Directive 2011_65_EU" Microscan produces Monitoring and Control Instruments as well as Industrial Monitoring & Control Instruments as defined within the directive. Microscan has developed and is implementing a RoHS2 compliance plan with the intention of bringing all active products listed in our current marketing literature within full compliance as per the directive deadlines.

Key milestones for the transition plan are as follows:

- Complete internal product audit by July 2014.
- Initial "Monitoring and Control Instruments" RoHS2 compliant products available by December 2014
- Initial "Industrial Monitoring & Control Instruments" RoHS2 compliant products available by July 2015
- All new products introduced in 2015 are expected to be WEEE & RoHS2 compliant.

Microscan will mark the products with the 'CE' marking that complies with the RoHS2 process to acquire 'CE' certification per the example given: Example >> Machinery directive + EMC directive + RoHS2 = Declaration of Conformity.



1 Quick Start

Contents

Check Required Hardware	1-2
USB Interface	1-3
RS-232 Interface	1-4
Install ESP	1-5
Select Model	1-6
Select Protocol and Connect to Imager	1-7

This section is designed to get your Mobile Hawk Handheld DPM Imager up and running quickly so you can get a sense of its capabilities and test sample symbols. Detailed setup information for configuring the imager for your specific application can be obtained in the subsequent sections.

Your interface type will determine how data is received by your host. When sending data by USB, you must open a text editor in your host computer. When sending data serially, you must use a terminal program such as HyperTerminal or **ESP's Terminal** view (RS-232 only).

Check Required Hardware

Parts List for USB Mobile Hawk:

- One Mobile Hawk Handheld DPM Imager
- One 12 ft. USB cable (pre-attached to imager)

Parts List for RS-232 Mobile Hawk:

- One Mobile Hawk Handheld DPM Imager
- Cable clip attachment
- Spacer
- Two threaded screws
- RS-232 Interface Kit
 - 8 ft. coiled R-232 cable
 - Power supply (U.S., Euro, or UK)

USB Interface

Note: The USB interface draws its power from the host.

USB Configuration

Item	Description	Part Number
1	Mobile Hawk Handheld DPM Imager	FIS-6170-0002G
2	USB Cable	Included

Installation Steps for USB

1. Connect the USB cable to the host.
2. Open any program in your host computer that can receive keyboard text, such as Notepad.
3. Read the **Reset to USB Factory Defaults** symbol below:



M049_03

**Reset to USB
Factory Defaults**

4. Read the **Save Settings** symbol.



M188_02

Save
Settings



Test Symbol
(ABCDEFGHIJKLMNOP)

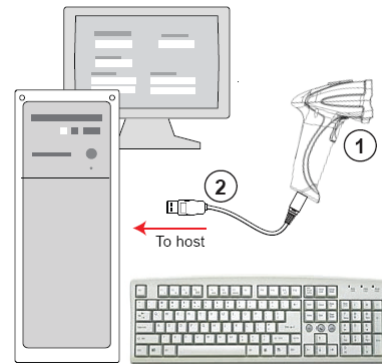

USB Configuration

RS-232 Interface

Note: Unlike USB, the RS-232 interface does not draw its power from the host computer.

RS-232 Configuration

Item	Description	Part Number
1	Mobile Hawk Handheld DPM Imager	FIS-6170-0002G
3	RS-232 Interface Kit (USA)	98-000074-04
	RS-232 Interface Kit (Europe)	98-000074-05
	RS-232 Interface Kit (UK)	98-000074-06

Installation Steps for RS-232

1. Power-off the host.
2. Connect the 8-pin mini-DIN on the cable to the Mobile Hawk.
3. Connect the 9-pin D-sub connector to the host computer's serial port.
4. Connect the cable to the power supply.
5. Plug in the power supply and power-on the host.
6. Start up a terminal program (such as **ESP's Terminal** view or HyperTerminal) and set to **57.6K** baud, **8** data bits, **none** parity, and **2** stop bits.
7. Read the **Reset to RS-232 Factory Defaults** symbol below.

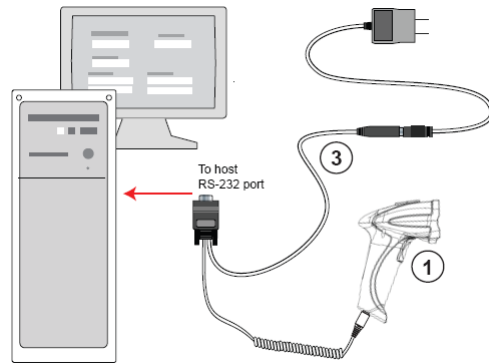

RS-232 Configuration



M418_02

**Reset to RS-232
Factory Defaults**

8. Read the **Save Settings** symbol.



M188_02

**Save
Settings**



Test Symbol
(ABCDEFGHIJKLMNOP)

Install ESP

ESP Software can be found on the Microscan Tools Drive that is packaged with the Mobile Hawk.

1. Follow the prompts to install ESP from the Tools Drive.
2. Click on the ESP icon to run the program.



Note: ESP can also be installed from the **Download Center** at www.microscan.com.

ESP System Requirements

- 233 MHz Pentium PC
- Windows 8, 7, Vista, or XP operating system (32-bit or 64-bit)
- Internet Explorer 6.0 or higher
- 128 MB RAM or greater
- 160 MB free disk space
- 800 x 600 256 color display (1024 x 768 32-bit color recommended)

Important: The imager must be in one of the modes below to communicate with **ESP**. Read the symbol below that corresponds with your communication interface, and then read the **Save Settings** symbol.

USB	USB Connect Mode	
RS-232	RS-232 Connect Mode	



Select Model

When you start **ESP**, the following menu will appear:

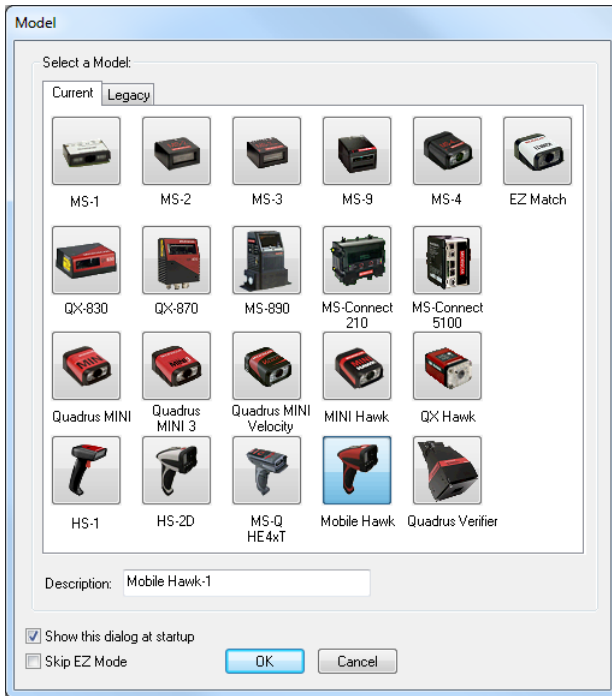

If you need to select another model later, click **Switch Model** at the top of the screen.

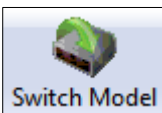

1. Click the Mobile Hawk button and then click **OK**. If you do not want to make this selection every time you start **ESP**, uncheck “Show this dialog at startup”.
2. Select the default reader name (**Mobile Hawk-1**), or type a name of your choice in the **Description** text field and click **OK**.
3. Click **Yes** when this dialog appears:

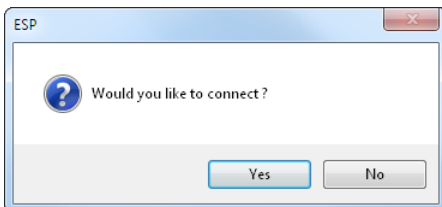

Select Interface and Connect to Imager

USB (Standard)

- In the **Select Protocol** dialog box, select the communications protocol you are using and click **Next**.

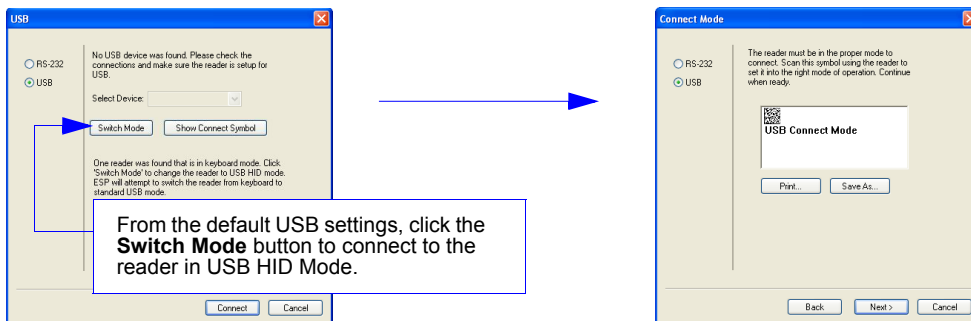

- Print the **USB Connect Mode** symbol (also shown in the **Install ESP** step) and decode it with the imager to ensure that you are in the correct communications mode. Keep the printed symbol in a convenient place for future use.
- Click **Next** when you are finished.

The USB **Select Device** dialog will then reappear:

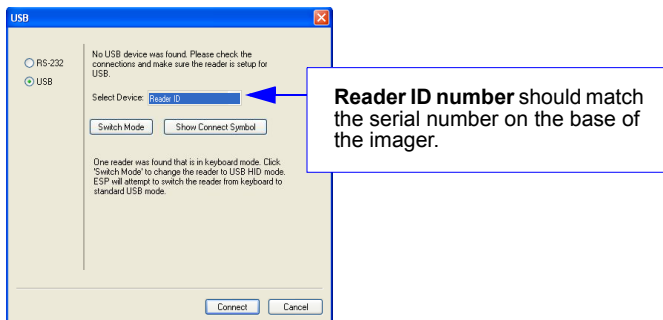

- You will see a “Reader ID” number in the USB **Select Device** field. Click **Connect**.
- When you are connected successfully, the **CONNECTED** message will appear in a green box in the status bar at the bottom right of the screen.



You are now ready to configure your imager using **ESP**. Subsequent sections provide more detailed information about **ESP**'s configuration options.

RS-232 Option

- Select **RS-232** and click the **Show Connect Symbol** button.

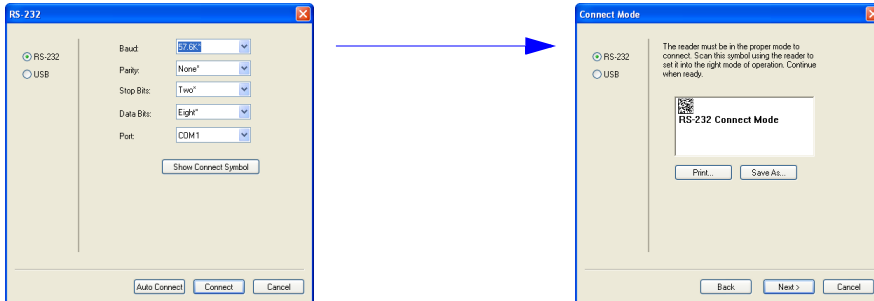

- Print the **RS-232 Connect Mode** symbol (also shown in the **Install ESP** step) and decode it to ensure that you are in the correct communications mode. Keep the printed symbol in a convenient place for future use.
- Click **Next** to return to the **RS-232** dialog.
- Configure RS-232 settings and COM port and click **Connect**.

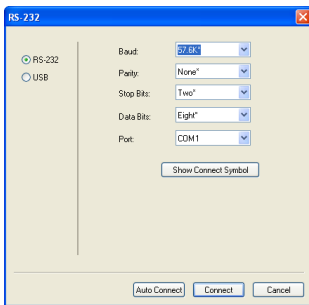

- When you are connected successfully, the **CONNECTED** message will appear in a green box in the status bar at the bottom right of the screen.

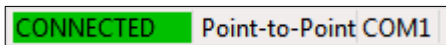

If the connection attempt fails, enable a different communications port, check your port connections, and try again.

You are now ready to configure your imager using **ESP**. Subsequent sections provide more detailed information about **ESP**'s configuration options.

2 Using ESP

EZ Mode	2-2
Application Mode	2-4
Tree Controls	2-5
Menu Toolbar	2-6
Send/Receive	2-16

This section is designed to help you understand the structure and application of **ESP**.

When you open **ESP**, unless otherwise specified in the **ESP Preferences** dialog accessible from the **Options** heading on the menu toolbar, you will enter **EZ Mode** for initial setup.

From there, you can enter **Application Mode (App Mode)** and access several configuration menus (**Communications**, **Read Cycle**, **Symbologies**, **I/O Parameters**, a **Terminal** interface, and a **Utilities** interface).

ESP can be used to configure the Mobile Hawk Handheld Imager in the following ways:

- **Tree Controls:** Each configuration menu contains a list of all option settings that pertain to that specific element of imager operation. For example, the **Communications** menu shows a **Communications Mode** command, and then the options **RS-232 Serial**, **USB Keyboard**, and **USB Native (HID)**, all of which are accessible from a dropdown menu.
- **Graphic User Interfaces:** Settings can be configured using such point-and-click tools as radio buttons, tabs, spin boxes, check boxes, and drag-and-drop functions.
- **Terminal:** **ESP**'s **Terminal** interface allows you to send configuration and utility commands directly to the imager by typing them in the provided text field.

EZ Mode

The **EZ Mode** screen is the first thing you will see when you start **ESP**. **EZ Mode** will help you get your imager up and running quickly, and will acquaint you with the **ESP** interface.

ESP - Untitled

File Model Options Connect Help

App Mode Connect Switch Model

Welcome to Easy Setup Program

Instructions:

1. Align targeting on the symbol.
2. Use the trigger button to initiate a decode sequence
3. Practice reading, ideally the imager will read best with the face of the imager parallel to the target and within contact to 2 inches.
4. The default imager settings is designed to read the broadest range of mark types. Switching to **Dot Peen Enhanced** mode enables additional image processing to read challenging marks.
5. Use the **Start/Stop** button to enable/disable capture of images. Moving the mouse over the image will display settings used to capture the image. A green box will indicate the decoded symbol location.
6. Click the **Save Image...** button to save the image.

The purpose of **Dot Peen Enhanced** in Illumination Quick Setup is to optimize settings for typical dot peen marks. Dot Peen Enhanced causes the imager to run a two step illumination sequence (Low Angle and then Red Dome) and matches the morphological operator (Grow Dark and Grow Light) to the expected dot peen response. The size of the morphological operator is selectable (Small, Medium, or Large). These settings can also be controlled by programming symbols (see [Dot Peen Enhanced Illumination Settings](#)).

Illumination Quick Setup

Default Dot Peen Enhanced

Small Medium Large

Start Upload Images

Save Image...

Illumination Type = Low Angle
Gain = 7
Low Resolution

Click **Start** to upload the most recent image acquired before releasing the trigger. When an image is captured, it is displayed here. Click **Save Image** to save it to a location of your choice. Good read images show a green border around the symbol. If you hover your cursor over the symbol, you will see the illumination, gain, and resolution settings that were used in capturing the image. Symbol data is displayed in the area under the **Save Image** button.

For Help, press F1. **CONNECTED**

Image Quality

The video view in **EZ Mode** (and also on the **Video** tab in **I/O Parameters**) allows you to capture images from the Mobile Hawk for further analysis. If **Upload Images** is checked and you click the **Start** button, image captures will be uploaded automatically for every good read. Images will also be uploaded for every no read, upon release of the imager's trigger.

You can right-click on a captured image to bring up the menu shown below. If you select **Store higher quality images**, you will see a dropdown menu with JPEG 60% quality (small size), JPEG 80% quality (full size), JPEG 100% quality (full size) and TIFF (full size).

The imager's illumination setup can be restored by clicking the **Default** box in the EZ Mode view. Refer to the **Basic Operations** section for more information about the Mobile Hawk's illumination capabilities.

Note: If you have difficulty viewing TIFF images with **Windows Photo Viewer**, it is recommended that you use **Paint** or viewer software that is optimized for TIFF files.

Note: TIFF images are large files and take significantly longer to download than JPEG images.

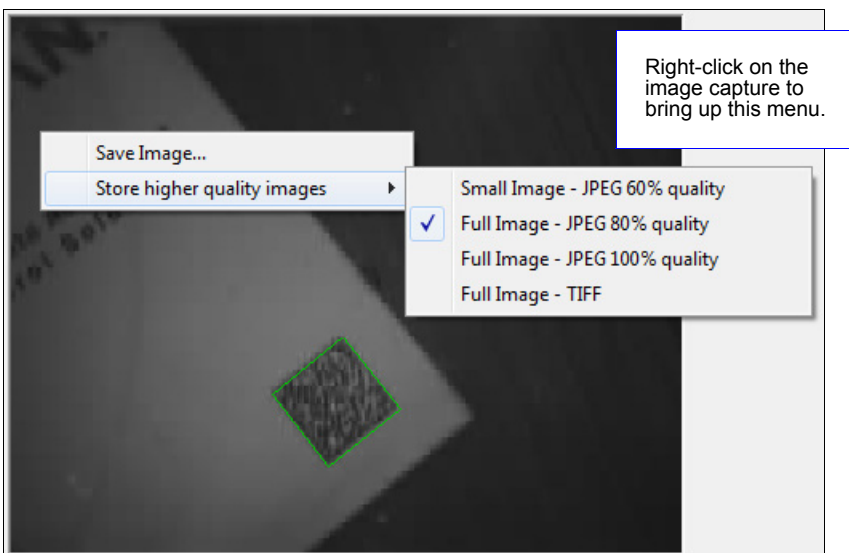

Note: Image size will vary depending on user settings for **Region of Interest**, and whether or not **Low Resolution Image** is checked in the **Illumination** dialog in ESP.

Image Save Mode	Region of Interest	Low Resolution	Final Image Size
Small Size (Displayed)	1280 x 1024	No	320 x 256
Small Size	1280 x 1024	Yes	320 x 256
Small Size	800 x 600	No	400 x 296
Small Size	800 x 600	Yes	400 x 296
Full Size	1280 x 1024	No	1280 x 1024
Full Size	1280 x 1024	Yes	640 x 512
Full Size	800 x 600	No	800 x 600
Full Size	800 x 600	Yes	400 x 296 (JPEG); 400 x 300 (TIFF)

Application Mode

Application Mode gives you access to a robust configuration environment, including tree controls that let you make precise changes to operation parameters, and graphic interfaces that make configuring your imager easy and intuitive.

The screenshot shows the Application Mode software interface. At the top is a menu bar with 'File', 'Model', 'Options', 'Connect', 'View', and 'Help'. Below the menu bar is an operations bar with icons for 'EZ Mode', 'Connect', 'Send/Recv', 'Switch Model', 'Parameters', 'Terminal', and 'Utilities'. Below the operations bar is a configuration bar with tabs for 'Communication', 'Read Cycle', 'Symbolologies', and 'I/O'. The main window is divided into two panes. The left pane shows a tree view of configuration parameters under 'Parameters' and 'ESP Values'. The right pane shows a form for configuring Preamble and Postamble characters, with buttons for 'Save As...', 'Send to Reader', and a grid of function keys for assignment.

Click here to return to **EZ Mode**.

Click on this icon to return to this view from **Utilities** or **Terminal**.

Menu toolbar

Click these buttons to Send and Receive commands or switch reader models.

Click here to open **Terminal**.

Click here for **Batch Files** and **Firmware**.

Click these tabs to access configuration tree controls.

Assign Preamble and Postamble characters using the simple interface shown above.

Note: For specific information on any of the icons shown above in the operations bar or configuration bar, see corresponding sections.

Tree Controls

To make changes to configuration settings in the tree controls:

The screenshot shows a tree view under 'Communications' with the following settings:

- Communications Mode: USB Keyboard
- Reader Packet Format: Raw
- Reader to Host Packet Size: 16384
- Expect Host Response: Disabled
- Reader Send Retry Count: 3
- Host Acknowledgement Timeout: 15
- Text Commands: Disabled; enable magic sequence
- USB Keyboard Rate: 5
- RS232:
 - Baud Rate: 57.6K
 - Parity: None
 - Stop Bits: Two
 - Data Bits: Eight
- Keyboard Inter Message Delay: 0
- Keyboard Mapping: US English (with leading 0 in alt-num)

Five callout boxes provide the following instructions:

- Left click** on the +/- to expand or collapse the tree.
- Double click** on the parameter and click once in the selection box to view options.
- Place your cursor in the selection box, scroll down to the setting you want to change and **click once** on the setting.
- Left click** again on the open screen to complete the selection.
- Right click** on the open screen and select **Save to Reader** to implement the command in the imager.

The imager must be in one of the modes below to communicate with **ESP**.

USB	USB Connect Mode 
RS-232	RS-232 Connect Mode 



Save Settings

M188_02

Menu Toolbar

File > New

Whenever **New** is selected from the **File** menu, the default configuration of **ESP** is loaded.

Open / Save

When **Save** or **Save As** is selected, the **ESP** configuration is saved to the host computer's hard drive and available whenever the same file is selected under **Open**.

When you save menu changes to your hard drive, these changes are not saved to your imager. The diagram below shows how settings can be saved and received between **ESP** and the imager, and **ESP** and the host hard drive.

File	
New	Ctrl+N
Open...	Ctrl+O
Save	Ctrl+S
Save As...	
<hr/>	
Print...	Ctrl+P
<hr/>	
Import...	
Export...	

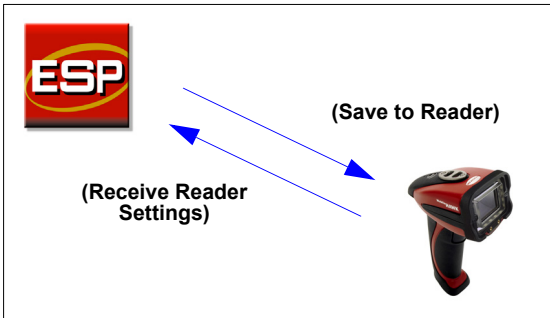

Import / Export

Import converts the ASCII settings from a text file to **ESP** configuration settings.

Export converts the active **ESP** configuration settings to an ASCII text file.

Model

The **Model** menu allows you to select between reader models. When you choose another model, the current connection with your present model will be terminated.

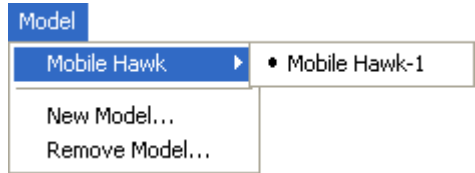

New Model

To connect to another model, select **New Model**, choose the model you want, and click **OK**. All models you have selected and enabled will continue to appear in the dropdown model menu. The **New Model** option is repeated when you click the **Switch Model** button on the top row of icons.

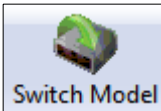

Options

You can use the **Options** menu to save memos and set up **ESP** preferences.

Preferences will be saved and loaded into **ESP** the next time **ESP** is opened, whether or not you save the **ESP** file to the host computer.

Preferences > General Tab

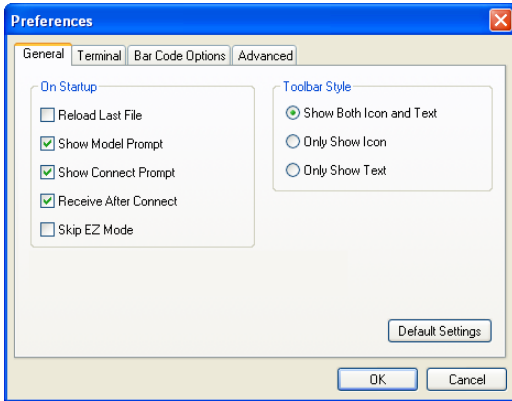

Reload Last File

At startup, reloads the last file saved to the computer.

Show Model Prompt

At startup, remembers the last connected model and displays it in the **Connecting...** dialog whenever you attempt to connect.

Show Connect Prompt

At startup, displays the **Would you like to connect...** prompt.

Receive After Connect

At startup, loads the imager's settings into **ESP**. (This is not recommended if you want to preserve your **ESP** settings for future use.)

Skip EZ Mode

At startup, skips **EZ Mode** and opens directly in **App Mode**.

Show Both Icon and Text

Sets the toolbar to display icons and names of all operations.

Only Show Icon

Sets the toolbar to display only icons representing operations, without text.

Only Show Text

Sets the toolbar to display names of operations only, without icons.

Terminal Tab

When **Show Non-Printable Characters** is checked, characters such as 'CRLF' will be displayed in the terminal window. When the **Enhanced Format** radio button is checked, subscript and superscript formatting is shown.

When **Display incoming data even when not in focus** is checked, data from the imager will continue to appear in the terminal even when **ESP** is not the top window on the host computer's screen.

When **Enable Echo** is checked, the terminal window displays user-entered data.

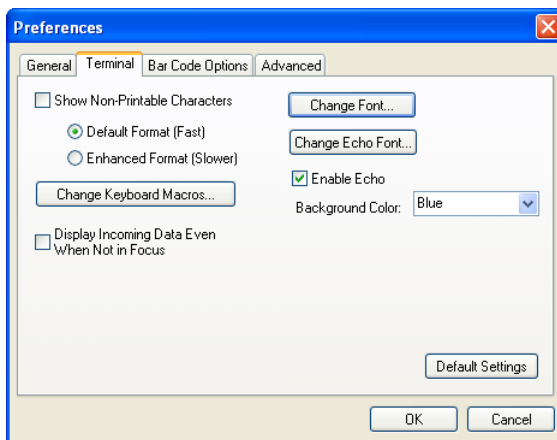

Change Keyboard Macros

Clicking the **Change Keyboard Macros** button brings up the **Function Keys** dialog. In this dialog you can select the desired function key and then enter your macro keystrokes in the associated key map. For example, to make **Ctrl-F2** the keystroke to send a trigger character, select **F2**, then in the **Ctrl** row, enter **<trigger character>** and click **OK**. Then whenever the **Ctrl-F2** keystroke is pressed, the trigger character will start the read cycle.

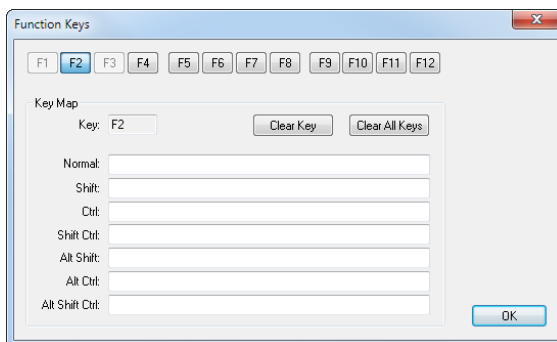

Note: The **F1** key is reserved for opening **ESP Help** and the **F3** key is reserved for the **Find Next** function.

Change Font

Sets the font characteristics for data received from the imager.

Change Echo Font

Sets the font characteristics of user-entered data.

Bar Code Options Tab

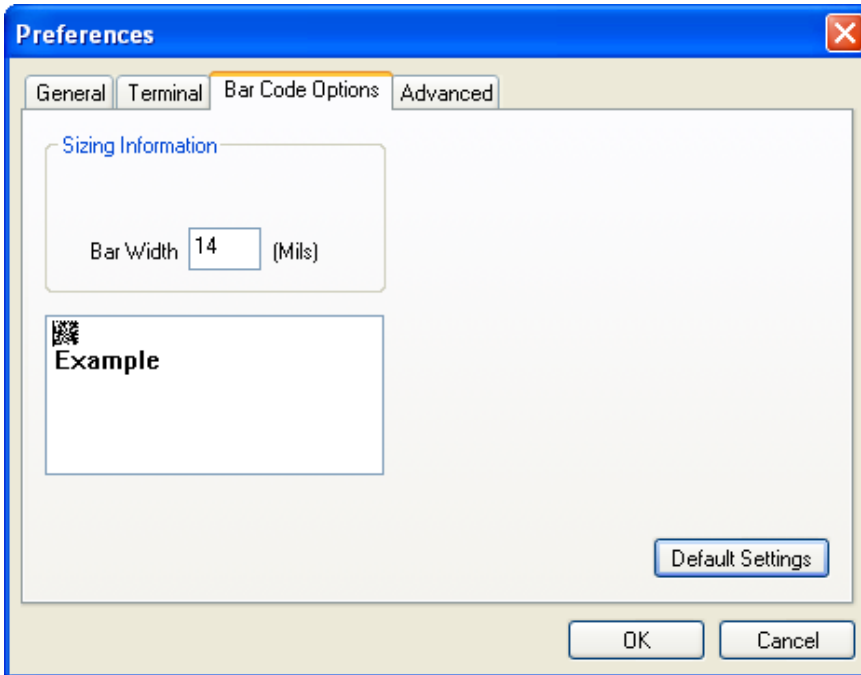

Sizing Information

Sets **Bar Width** (in mils) of symbols that can be created in ESP.

Advanced Tab

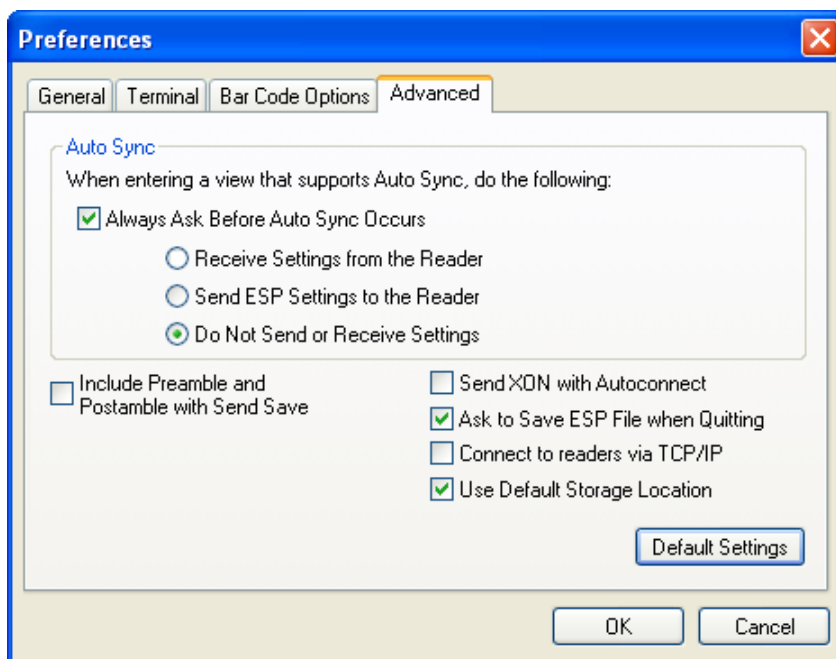

The Auto Sync dialog on the **Advanced** tab allows you to determine whether Auto Sync will be automatically enabled in sections of **ESP** where it is used, or if it will ask you before it enables Auto Sync functions.

Always Ask Before Auto Sync Occurs

If you check this option box, you are then able to determine what specific Auto Sync functions will be enabled. **Receive Settings from the Reader** will automatically send the imager's settings to **ESP** when Auto Sync is enabled. **Send ESP Settings to the Reader** will automatically send all imager configuration settings chosen in **ESP** to the imager. **Do Not Send or Receive Settings** creates a condition in which Auto Sync will not send imager settings to **ESP**, or send **ESP** settings to the imager.

Include Preamble and Postamble with Send Save

Sends Preamble and Postamble settings along with other settings when a **Send and Save** is performed.

Send XON with Auto-Connect

Sends an **XON (Begin Transmission)** command to the imager before starting the **Auto-Connect** routine.

Preferences > Advanced Tab (cont.)

Ask to Save ESP File when Quitting

When enabled, prompts the user to save a **.esp** file when ending a session.

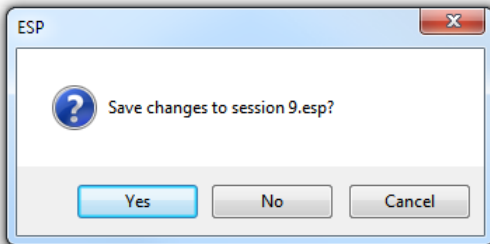

The **.esp** file will be saved in the location specified by the user.

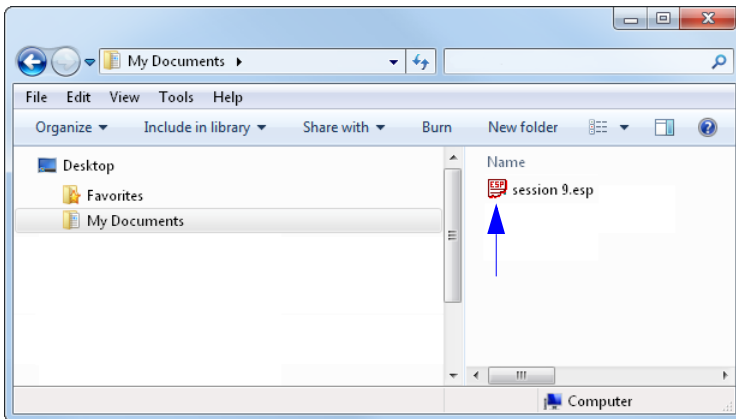

Connect to Readers via TCP/IP

When enabled, shows the **TCP/IP Connection Wizard** by default.

Use Default Storage Location

When enabled, automatically stores data in **ESP's** Application Data folder.

Document Memo

The information entered in the **Document Memo** field will appear in a context-sensitive text box whenever the cursor hovers over the **Document Memo** item on the **Options** menu.

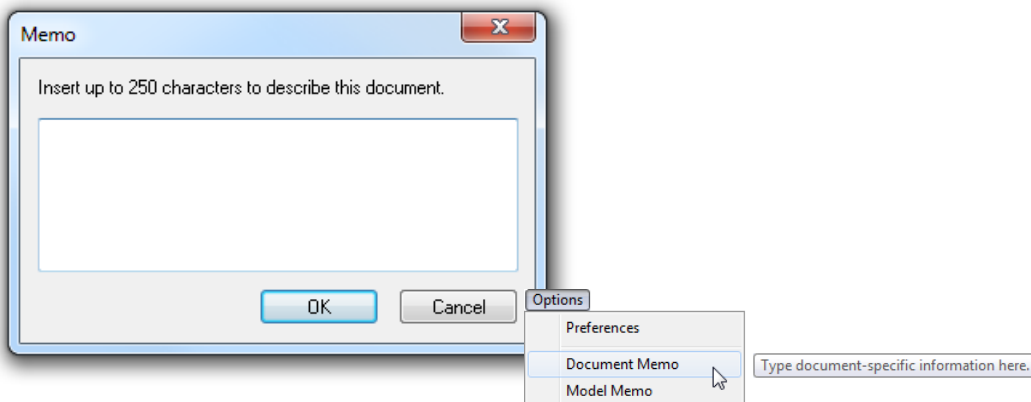

Model Memo

Similar to **Document Memo**, the information entered in the **Model Memo** field will appear in a context-sensitive text box whenever the cursor hovers over the **Model Memo** item on the **Options** menu. Memos created in **Model Memo** are specific to the model enabled when the message was created.

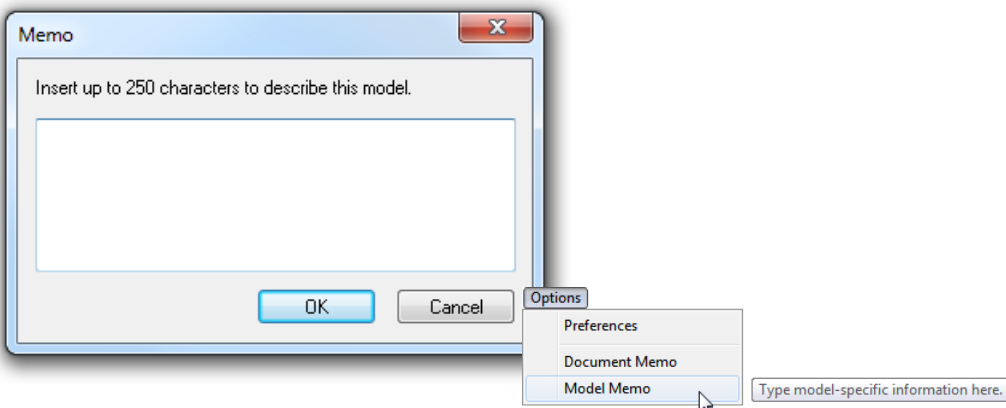

Note: Memos must be saved in a **.esp** file to make them available in the next session. If the current session is not saved, any memos that have been entered during the session will be discarded, and will be unavailable in the next session.

Connection Wizard

When you choose to connect to the imager via the **Connection Wizard**, you will first need to select the correct protocol (see [Select Protocol and Connect to Imager](#)).

When you have successfully connected to the imager you will see one of the two following displays in the status bar at the lower right of the screen:

RS-232:

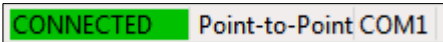

CONNECTED Point-to-Point COM1

USB:



CONNECTED USB HID

View

The options in the **View** menu correspond to icons on the operations toolbar (**Parameters**, **Setup**, **Terminal**, **Utilities**). Each option allows you to configure the imager or to perform various other functions in the chosen view.

The **View** menu also allows you to access the **Barcode Dialog**.



Bar Code Dialog

In the **Bar Code Dialog** you can directly type the text and commands you want to encode. This allows you to create configuration symbols that you can print and read with the imager.

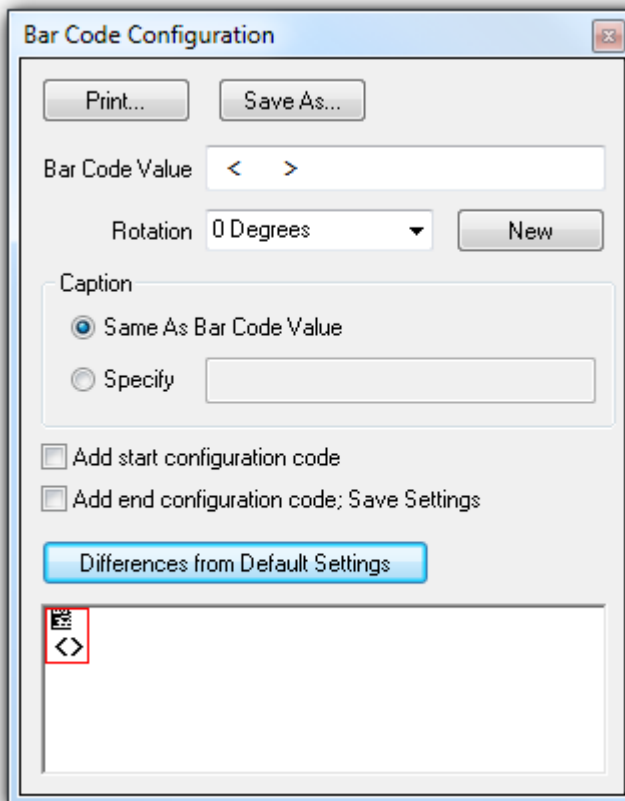

Send/Receive

To access **Receive**, **Save**, **Default**, and **Advanced** options, click the **Send/Recv** button.



You can also access these options by right-clicking in any of the configuration views.

Receive Reader Settings

From the **Send/Recv** menu, select **Receive Reader Settings**.

This option is useful if you want to receive the imager's settings and save them as a file for later retrieval. For example, if your imager has settings that you do not want to change, choosing **Receive Reader Settings** will allow you to load those settings to **ESP** and save them as an **ESP** file.

Receiving the imager's settings also assures that you will not subsequently save any unwanted configuration changes previously made in **ESP**.

Select this option if you want to upload the imager's settings to **ESP**. For example, if your **ESP** file has a number of custom settings that you want to maintain and download to the imager, you will lose those **ESP** settings if you choose to receive settings from the imager.

Save to Reader

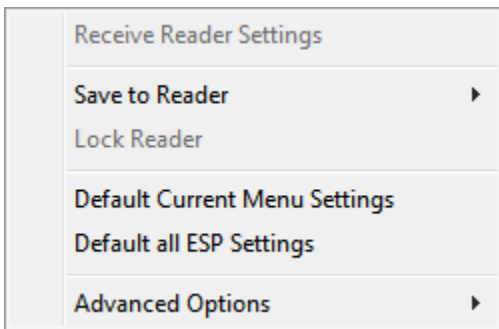

Send, No Save

This saves **ESP** settings to current memory.

Send and Save

This activates all changes in current memory *and* saves to the imager.

Default

When you select **Default Current Menu Settings** or **Default all ESP Settings** you are *only* defaulting settings in **ESP**. The imager is not affected unless you download new settings.

Advanced Options

Send Current View

This is the same as **Save to Reader > Send No Save** except that only the commands in the current menu tree are sent.

Send Current Command

This is the same as **Send Current View** above, but only saves the command that is currently selected.

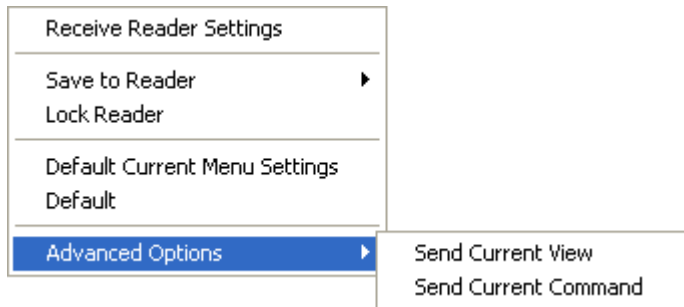

Send/Receive

3 Basic Operations

Contents

Targeting and Decoding	3-2
Scanning Guidelines.....	3-3
Decode Zones and Lighting Zones.....	3-4
Illumination System	3-7
Illumination Sequence	3-9

This section explains how to practice targeting and triggering, and how to begin configuring the imager.

Targeting and Decoding

The Mobile Hawk features simple blue targeting LEDs to indicate optimal read range.

1. Hold the imager about 6" from the mark and align the blue targeting pattern as shown below.



2. Move the front of the imager steadily downward toward the mark and parallel to the mark surface.

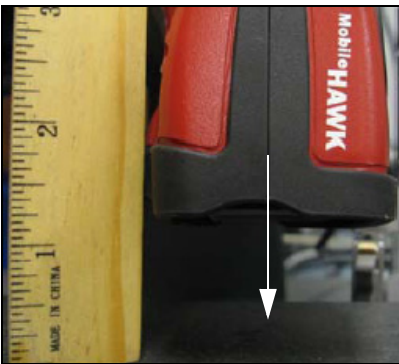

3. The imager will decode the mark at the optimal read distance – typically from the point of contact to .50" (contact – 12.70 mm).

Test Symbol



ABCDEFGHIJKLMNPO

Targeting LEDs

Read the configuration symbols below to enable or disable targeting LEDs.



M734_01

**Targeting
LED On**



M735_01

**Targeting
LED Off**



M188_02

**Save
Settings**

Scanning Guidelines

The Mobile Hawk makes reading the most difficult direct part marks easy. The following guidelines will help ensure optimal performance:

- In the default illumination setup, allow the Mobile Hawk to run through its illumination sequences before terminating the read cycle. The Mobile Hawk captures several images with each illumination zone, evaluating the optimum settings. If reading the same part or same part type, the Mobile Hawk always uses the most recent good read settings as a starting point so subsequent reads will be faster.
- Hold the Mobile Hawk still – *do not swipe or move the imager*. Pull the trigger and hold until a read is indicated by the green LED.
- Hold the Mobile Hawk such that its front surface is parallel to the mark surface, and the mark is centered. Unlike other readers that require a tilt to read, the Mobile Hawk is designed to operate this way.



Correct – Move in steadily with front of imager parallel to surface.



Incorrect – Too far away and off axis to target.

- The Mobile Hawk features omnidirectional decoding. Centering the mark within the field of view will yield the best decode performance.

Decode Zones and Lighting Zones

The following chart provides a guideline for overall read performance based on mark size. Actual range for direct part marks will vary based on mark parameters and the illumination zone required for readings. The chart below is intended as a guideline.

Decode Zones

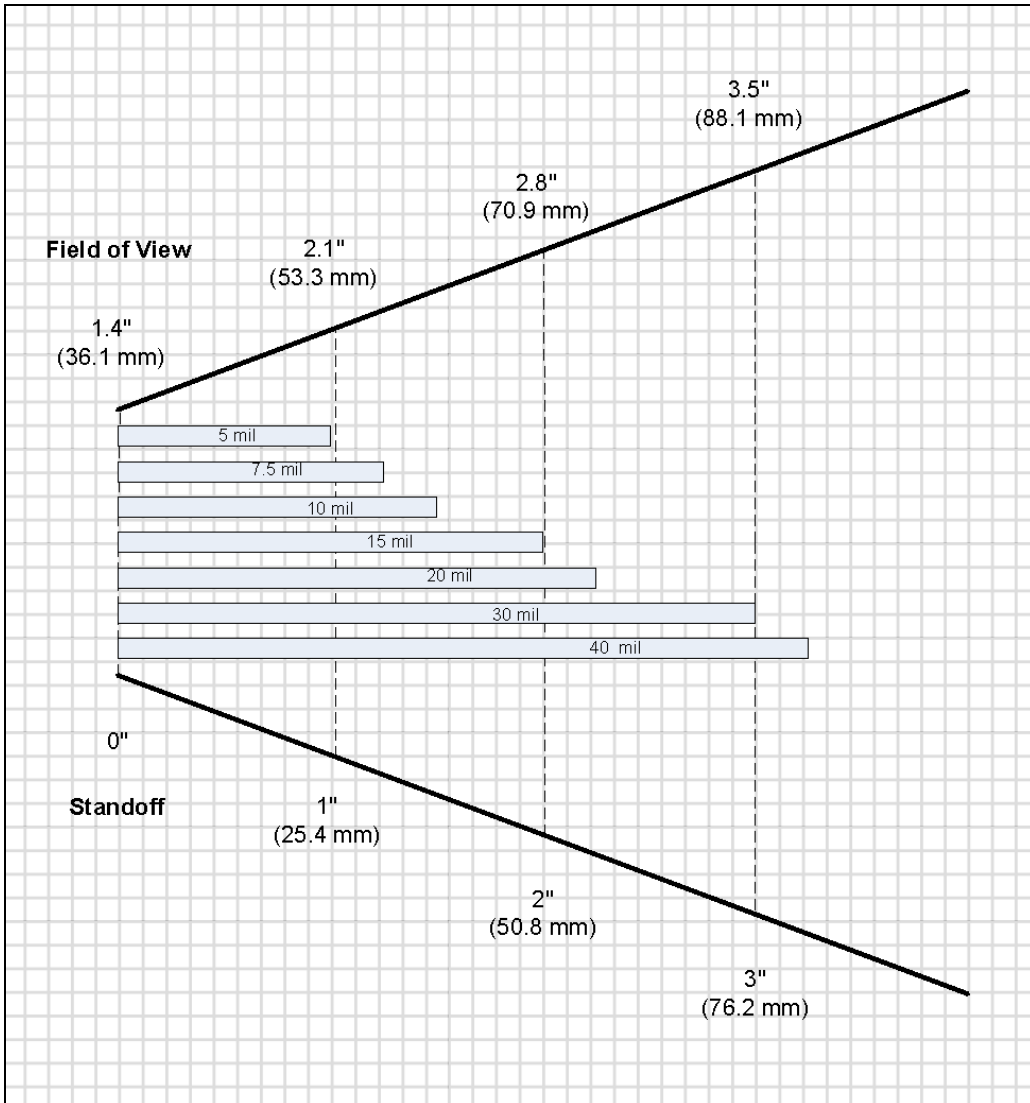

Lighting Zones

The following charts indicate the illumination zones based on the Mobile Hawk MAXlite design.

Dome Lighting Zone

Dome illumination de-emphasizes surface texture and elevation (curved surface).

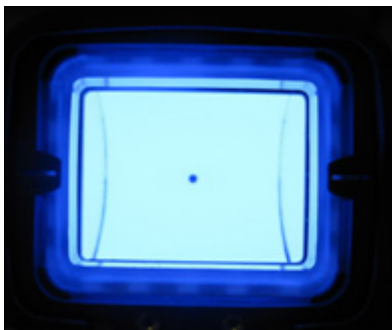
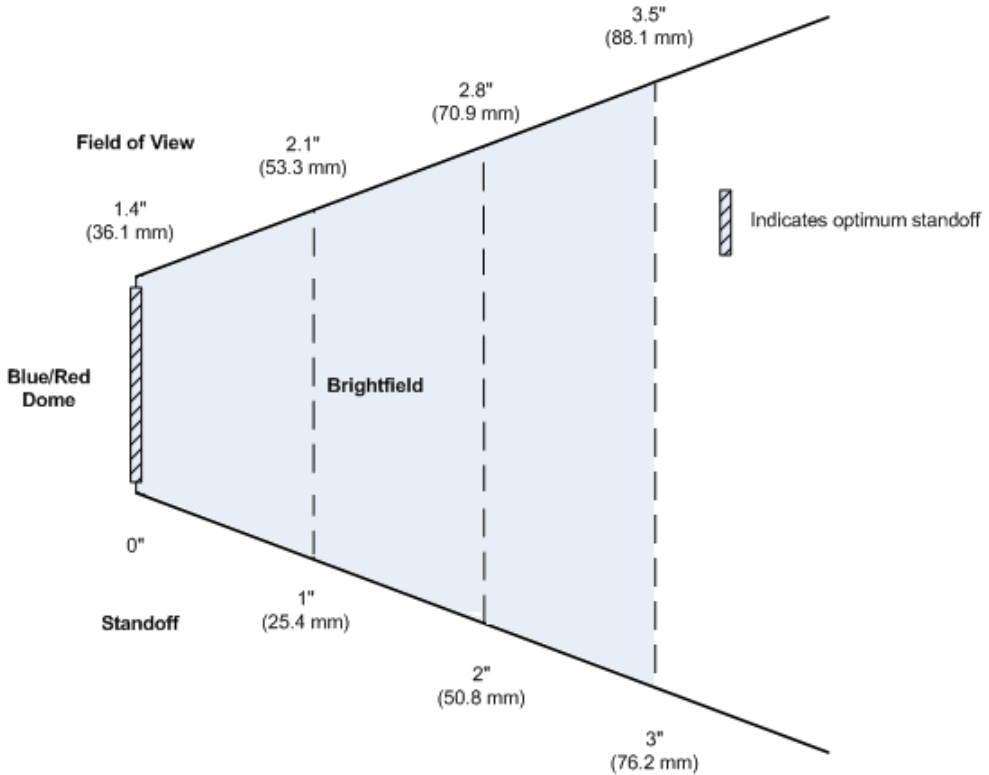

Dome Illumination

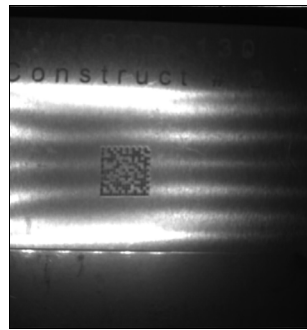

Texture and Elevation are De-Emphasized on the Mark's Surface

Low Angle Lighting Zone

Low Angle illumination emphasizes surfaces texture and elevation (curved surface).

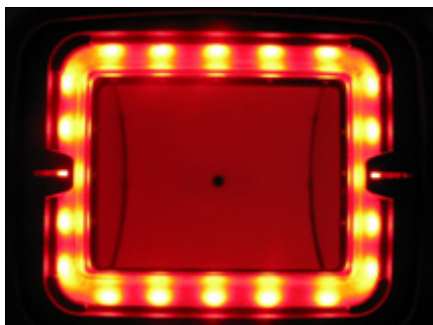
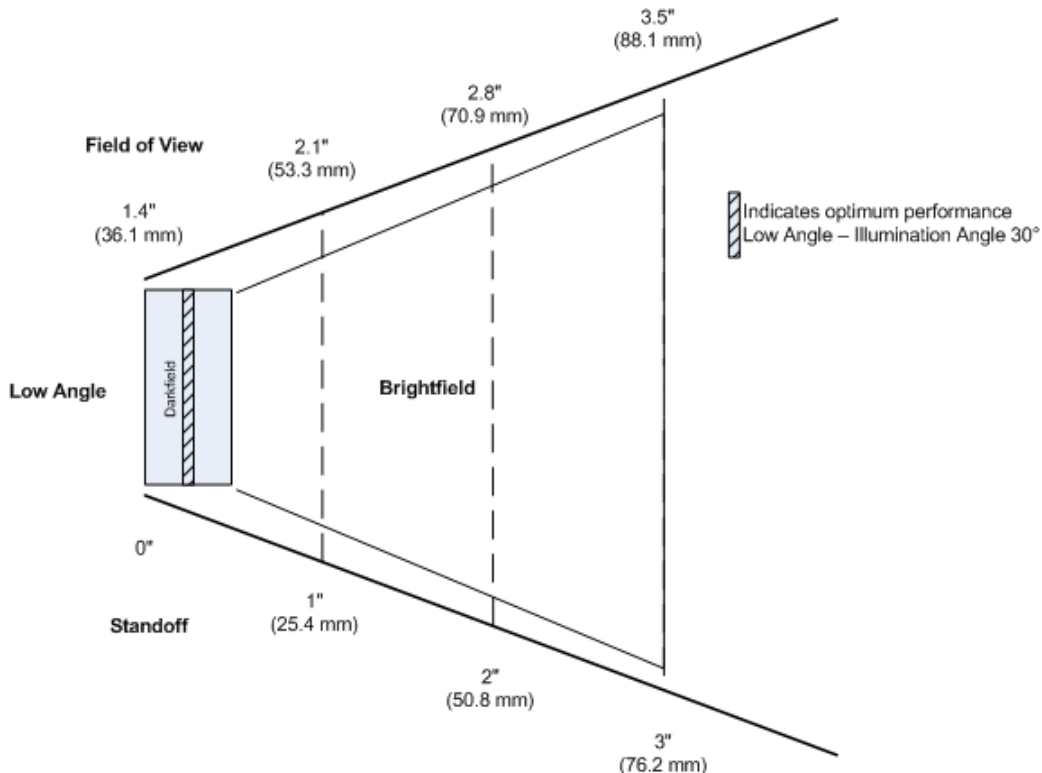

Low-Angle Illumination

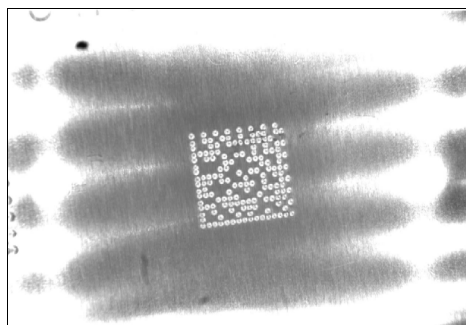

Texture and Elevation are Emphasized on the Mark's Surface

Illumination System

The Mobile Hawk incorporates the MAXlite (multi-axis lighting) illumination system, designed to ensure reliable decoding of the toughest direct part marks. Through an advanced combination of low angle (dark field) and multi-colored dome (bright field) illumination techniques, MAXlite provides even illumination of flat, shiny surfaces, enhancing embossed features, or differentiating features on curved surfaces.

Low Angle (Dark Field) Illumination

The low angle illumination zone provides what is called “dark field” illumination, ideal for very low-contrast marks such as laser-embossed or engraved marks. This zone is useful on both specular and non-specular surfaces and emphasizes surface texture. The optimum lighting angle for most marks is 30 degrees, which occurs when the Mobile Hawk is approximately 0.25” away from the target mark. This illumination zone actually directs light inward at an angle, which varies with the actual working distance and provides a good source of low angle illumination from contact (5 degrees) to about 0.5 inch (45 degrees). Beyond this working distance for low angle illumination the illumination zone converts to a general purpose illuminator due to a portion of the illumination passing straight through the prism. This can be useful in providing “bright field” illumination. This zone was designed for reading larger marks such as 1D symbols at longer working distances.

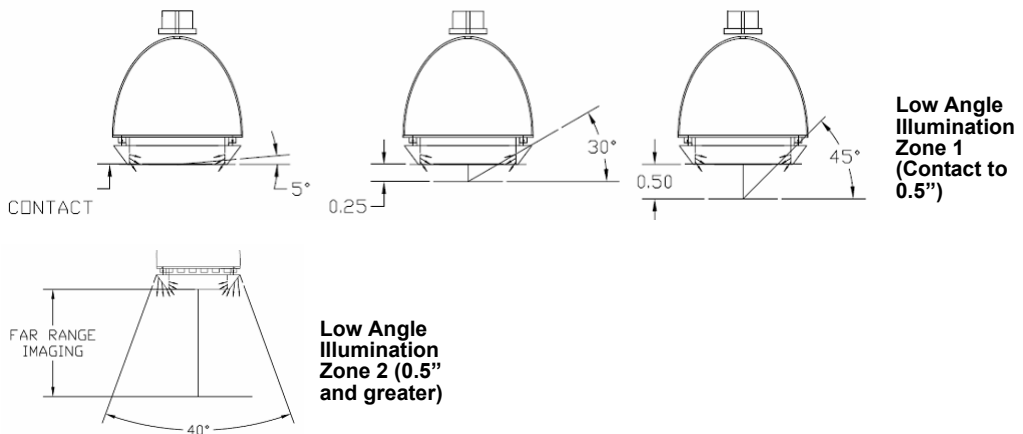

Dome Illumination

Dome illumination provides diffused, uniform light. The large, solid angle of illumination supports imaging of shiny flat surfaces or curved surfaces. This zone is useful on specular and non-specular surfaces, ideal for de-emphasizing surface texture and elevation (curves). The dome provides the widest area of coverage at close working distances. It is important to note that for marks that are a large percentage of the diameter of a curved surface, closer distances will provide the best performance. In addition to illuminating marks on curved surfaces, dome illumination also provides diffuse, even bright field illumination, which will provide thorough coverage on a wide variety of direct part marks.

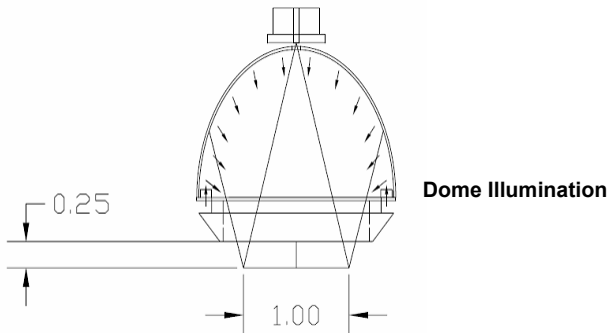

Blue Dome vs. Red Dome Illumination

The Mobile Hawk features two colors of dome illumination to add another dimension of decode optimization for direct part marks. Using the opposite light spectrum as a part's surface color will make the part feature appear darker. Using the same light spectrum will make the part feature appear lighter. The example below shows a green part surface with a laser-etched Data Matrix.



Blue Dome Illumination



Red Dome Illumination

Illumination Sequence

The Mobile Hawk is configured to provide the broadest reading capabilities “out of the box”. Just point and shoot to read most marks. This is achieved by combining the MAXlite illumination system with Microscan’s advanced X-Mode algorithms. The Mobile Hawk automatically cycles through a default combination of the MAXlite illumination zones each time the user pulls the trigger to decode a mark. The imager will then lock onto the settings used in the last good read and move those to the first step in the next sequence.

The Mobile Hawk has four steps defined in this default illumination sequence:

1. Low Angle Illumination with Low Resolution Image

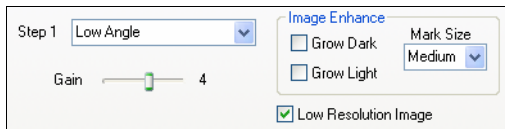

2. Low Angle Illumination with Full Resolution Image

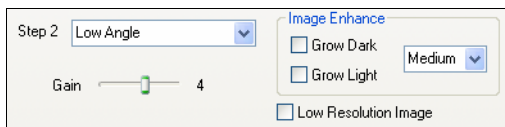

3. Blue Dome Illumination

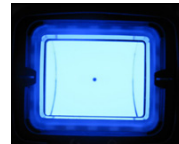
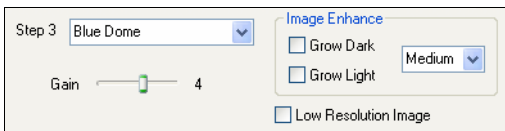

4. Red Dome Illumination

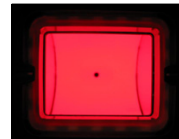
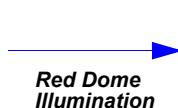
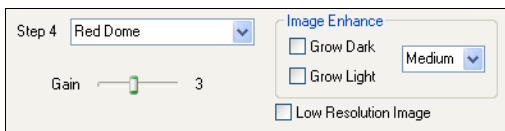

With ESP Software, the user can change this sequence or define a different sequence. It is possible to have one step to as many as eight steps defined. ESP allows the user to evaluate the best settings.

Note: Decode speed can be improved with fewer illumination steps.

Note: Hovering over an uploaded image in ESP with your cursor will display the settings used to capture the image.

In addition to the general purpose sequence, a special sequence has been defined for dot peen marks. This adds additional X-Mode pre-processing to the sequence steps, allowing you to read some of the most challenging direct part marks with ease.

4 *Communications*

Contents

Communications by ESP	4-2
Communications Overview	4-3
USB Interface	4-4
RS-232 Interface	4-5
Preamble	4-7
Postamble	4-9
Preamble and Postamble by ESP	4-11
Keyboard Mapping	4-12
Text Commands	4-13
Other Communications Settings in ESP	4-14

This section includes connection parameters and options for communicating with the Mobile Hawk Handheld DPM Imager in various interfaces.

Communications by ESP

To make changes to configuration settings in the **Communications** tree control:

Parameters	ESP Values
[-] Communications	
[-] Communications Mode	USB Keyboard
Reader Packet Format	Raw
Reader to Host Packet Size	16384
Expect Host Response	Disabled
Reader Send Retry Count	3
Host Acknowledgement Timeout	15
Text Commands	Disabled; enable magic sequence
USB Keyboard Rate	5
[-] RS232	
Batch Mode	Detect RS232*
Baud Rate	Detect RS232*
Parity	Assume Always Connected
Stop Bits	Two
Data Bits	Eight
Keyboard Inter Message Delay	0
Keyboard Mapping	US English (with leading 0 in alt-num)

1. **Left click** on the + to expand the tree.
2. **Double click** on the parameter and click once in the selection box to view options.
3. Place your cursor in the selection box, scroll down to the setting you want to change and **click once** on the setting.
4. **Left click** again on the open screen to complete the selection.
5. **Right click** on the open screen and select **Save to Reader** to implement the command in the imager.

Communications Overview

All Mobile Hawk Handheld DPM Imagers are shipped with a USB cable. You can also add RS-232 capabilities and configure your imager accordingly. Whenever you default the imager, it will return to the default settings of whichever interface you are using. Defaulting the imager does not remove preamble and postamble formatting.

Note: You must use **USB Connect Mode** or **RS-232 Connect Mode** to connect to **ESP**. Once the imager is connected to **ESP**, you can select your communications mode and set other communication parameters.

USB

With USB communications, the imager connects directly to the host's USB port from which it draws its power. Data is displayed by any open Windows-based program that can capture text in USB Keyboard Mode.

RS-232

With RS-232 communications the imager communicates with the host through a communications program such as HyperTerminal.

Default settings for establishing RS-232 communications are:

Baud =	57.6K
Stop Bits =	2
Data Bits =	8
Parity =	None

USB Interface

USB Keyboard is the default interface in which data is transferred to a Windows-based text program as keyboard data.

See [USB Interface](#) for detailed steps on setting up the USB Interface.

USB Keyboard Mode

Data is entered as keyboard sequences. You need to read this symbol whenever you are changing from a different interface to USB.



M134_02

USB Downloader Mode

This mode is the standard way of transferring unformatted, unpacked data to the imager through the USB port.



M133_01

USB Native Two-Way Mode

This mode is used when the user needs error-corrected communication between the Mobile Hawk and the USB port.



M135_04

USB Virtual COM Mode

This mode allows an Mobile Hawk in a USB configuration to function as a virtual serial COM port. This mode requires installation of a USB Virtual COM driver. The USB Virtual COM Port Driver can be found in the Download Center on the Microscan website.



M668_01



M188_02

**Save
Settings**

RS-232 Interface

Enabling either of these modes will disable USB communications and require you to default the imager or read the “USB Keyboard” symbol to return to USB.

See [RS-232 Interface](#) for detailed steps on setting up the RS-232 Interface.

RS-232 Default Settings

This mode is the standard way of transferring unformatted, unpacketized data through the RS-232 port.



M418_02

You will need to read this symbol whenever you set up RS-232 communications.

Baud Rate (RS-232)

Baud Rate is the rate at which the imager and host transfer data. It only needs to be changed if necessary to match the host setting.



M092_01

1200



M096_01

19.2K



M093_01

2400



M097_01

38.4K



M094_01

4800



M098_01

57.6K (Default)



M095_01

9600



M099_01

115.2K



M188_02

Save Settings

Parity (RS-232)

Parity is an error detection routine in which one data bit in each character is set to **1** or **0** so that the total number of 1 bits in the data field is even or odd. It only needs to be changed if necessary to match the host setting.



M103_01

None (Default)



M104_01

Odd



M102_01

Even

Stop Bits (RS-232)

Stop Bits are added to indicate the end of each character. This setting should only be changed if necessary to match the host setting.



M106_01

2 Stop Bits (Default)



M105_01

1 Stop Bit

Data Bits (RS-232)

Data Bits are the total number of bits in each character. This setting only needs to be changed if necessary to match the host setting.



M101_01

8 Data Bits (Default)



M100_01

7 Data Bits



M188_02

Save Settings

Preamble

A **preamble** is a character or series of characters that is added to the beginning of a decoded data string. Preamble characters will appear in the order that they are enabled (left to right). For example, if you enable a comma and then a space, and then decode a symbol containing the data 'ABC', your output will look like this:

, ABC

The only limit to the number of preambles enabled is the total memory size available.

Important: Be sure to save all settings before reading any of the following preamble symbols—otherwise your settings may be lost.



Save Settings

M188_02

Set the desired preamble by reading the appropriate symbol below.

Serial Preamble

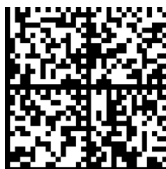

M159_02

Comma



M164_02

Space



M218_02

Tab



M214_02

**Carriage Return
Line Feed**



M404_01

**Erase All
Preamble Data**

Note: To erase all preamble and postamble data, read the symbol at right:



M406_02

**Erase Preamble
and Postamble
Data**

USB or PS/2 Keyboard Preamble



M159_02

Comma



M164_02

Space



M166_01

Tab



M404_01

**Erase All
Preamble Data**

Note: To erase all preamble *and* postamble data, read the symbol at right:



M406_02

**Erase Preamble
and Postamble
Data**

Postamble

A **postamble** is a character or series of characters that is added to the end of a decoded data string. Postamble characters will appear in the order that they are enabled (left to right). For example, if you enable a space and then a comma, and then decode a symbol containing the data 'ABC', your output will look like this:

ABC ,

The only limit to the number of postambles enabled is the total memory size available.

Important: Be sure to save all settings before reading any of the following postamble symbols—otherwise your settings may be lost.



M188_02

Save Settings

Set the desired postamble by reading the appropriate symbol below.

Serial Postamble



M160_04

Comma



M165_04

Space



M219_04

Tab



M168_04

Carriage Return



M169_04

Line Feed



M170_04

**Carriage Return
Line Feed**



M405_02

**Erase All
Postamble
Data**

Note: To erase all postamble and preamble data, read the symbol at right:



M406_02

**Erase Preamble
and Postamble
Data**

USB or PS/2 Keyboard Postamble



M160_04

Comma



M165_04

Space



M167_04

Tab



M161_04

Enter



M405_02

**Erase All
Postamble
Data**

Note: To erase all postamble and preamble data, read the symbol at right:



M406_02

**Erase Preamble
and Postamble
Data**

Preamble and Postamble by ESP

Characters can also be added to the beginning and end of data strings using **ESP**. There are a few different ways to do this, using the interface shown below.

You will see the Communications tree control on the left, and the Preamble/Postamble interface on the right.

When you type ASCII characters directly into the **Preamble** or **Postamble** text fields and then click **Send to Reader**, those preamble or postamble characters are enabled and will appear in data output.

The screenshot shows the Preamble/Postamble interface with the following elements and callouts:

- Preamble:** Text field containing a comma (`,`).
- Postamble:** Text field containing a carriage return and line feed (`/n`).
- Buttons:** "Save As...", "Send to Reader", "Insert", and a grid of preset buttons including Alt, Ctrl, Shift, Windows, Home, End, Enter, Escape, Page Up, Backspace, Page Down, Up, Left, Down, Right, Carriage Return (CR), % - Percent Sign Esc, 500 ms Delay, Tab - Keystroke/USB, Tab - Ascii, and / - Forward Slash Esc.
- Radio Buttons:** "Preamble" (unselected) and "Postamble" (selected).
- Dropdown Menu:** A dropdown menu showing "/n - Enter key".

Callout boxes provide the following instructions:

- Save pre- and postamble settings and send them to the imager. (Points to "Save As..." and "Send to Reader")
- Scroll through a list of all preamble and postamble options, and then click **Insert**. (Points to the dropdown menu and "Insert" button)
- In addition to typing directly in the text fields and selecting from the dropdown menu, you can also click any of these preset buttons to set a preamble or postamble. (Points to the grid of preset buttons)

Keyboard Mapping

The **Keyboard Mapping** feature provides alternatives for keyboards that do not conform to US English mapping.

Note: Universal Keyboard mapping is slightly slower than the other language-specific options, because it maps data by reference to the full set of ASCII characters. The advantage of Universal Keyboard mapping is that it allows any language and keyboard layout to be mapped.

Important: Keyboard Mapping is not to be confused with USB Keyboard Mode, which has an entirely different function—namely to enable USB cabled communications. (See [USB Interface](#)).



M172_01

US English, No Leading 0 for non-printable characters (Default)



M602_01

US English, Leading 0 for non-printable characters



M606_01

US English, Ctrl + char. for non-printable characters



M603_01

French



M604_01

German



M605_01

Japanese



M173_01

Universal Keyboard



M171_01

Custom Keyboard



M585_02

Enable Alternate OS (Windows CE/MAC/Unix/Linux)



M584_02

Disable Alternate OS



M188_02

Save Settings

Keyboard Mapping by ESP

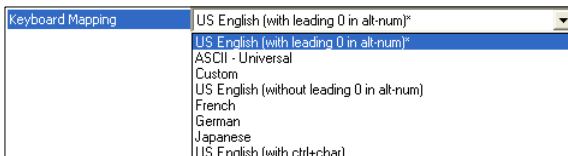

Text Commands

When the **Text Commands** feature is enabled, the Mobile Hawk can accept text commands via RS-232 connections and USB Virtual COM modes.

Note: **Text Commands** are not supported in USB HID Mode.



Enable Text Commands



Disable Text Commands (Default)



Save Settings

Text Commands by ESP

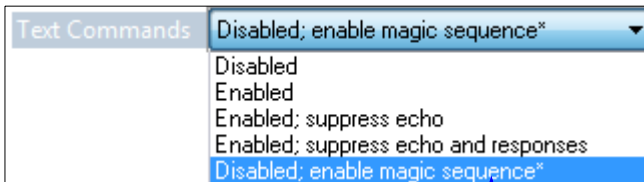

When **Text Commands** are set to **Enabled; Suppress Echo**, text that a user enters in the terminal will not be shown. When **Text Commands** are set to **Enabled; Suppress Echo and Responses**, neither user-entered data or imager responses will be shown, and only decoded symbol data will appear in the terminal.

See [Terminal Right-Click Menu](#) for a way to change Echo settings directly in the terminal view.

When **Magic Sequence** is enabled, it allows the user to enable **Text Commands** by entering a predetermined series of keystrokes.

Entering Magic Sequence

The magic sequence is `>PA` followed by a numeric value of **1**, **3**, or **7**.

- 1** = Enable Text Commands
- 3** = Enabled; Suppress Echo
- 7** = Enabled; Suppress Echo and Responses

In the example below, the magic sequence entered will Enable Text Commands and Suppress Echo and Responses.

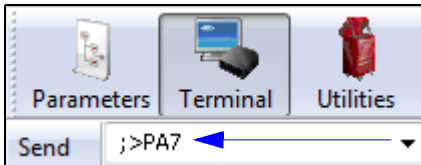

Enter the magic sequence in this text field and click **Send**.

Once the magic sequence has been sent, you can send text commands from the same text field.

Other Communications Settings in ESP

Some **ESP** Communications options are unique to the software, and do not have corresponding programming symbols. These options are explained below.

Reader Packet Format

Reader Packet Format	Packet Mode Version 0*
	Raw
	Packet
	Packet Mode Version 0*
	Reserved (Legacy Image Upload)

Data that is sent from the imager to the host in **Raw** format is sent without packet framing or check characters. **One-Way** communication is in a raw format, no response is expected from the host, and data is not resent.

Packetized data is sent with framing (a preamble communicating the amount of data to be transmitted, and a postamble containing error detection) and check characters, and a response is expected from the host. **Two-Way** communication is in packet format.

Reader to Host Packet Size

Reader to Host Packet Size	16384	(1 - 16384)
----------------------------	-------	-------------

The **Reader to Host Packet Size** is the amount of data (in bytes) that is sent to the host in packet format. This feature allows you to set the maximum allowable packet size.

Expect Host Response

Expect Host Response	Disabled*
	Disabled*
	Enabled

When **Expect Host Response** is enabled, the imager will re-transmit data if it doesn't receive acknowledgement from the host.

Reader Send Retry Count

Reader Send Retry Count	3	(1 - 255)
-------------------------	---	-----------

Reader Send Retry Count sets the number of times the imager will re-transmit data before abandoning further send attempts. The minimum retry count is **1**, which represents the initial transmission.

Host Acknowledgement Timeout

Host Acknowledgement Timeout	0.015	Seconds
------------------------------	-------	---------

The **Host Acknowledgement Timeout** is the amount of time (in seconds) that the imager will wait for an acknowledgement from the host before re-sending data.

USB Keyboard Rate

 1 - 255 (x 1ms)

Requests that the host polls the USB Mobile Hawk at the rate specified (**1** to **255** ms).

Keyboard Inter Message Delay

 (0 - 2147483647) ms

Places a delay between each character that is output by the imager when in Keyboard Mode. Useful for applications that require a slower output rate.

5 Read Cycle

Contents

Read Cycle by ESP.....	5-2
Button Stay-Down Time	5-3
Ignore Duplicate Symbol Timeout.....	5-4
Region of Interest.....	5-5

This section contains information on how to set your imager to the most efficient and effective parameters for your application.

Read Cycle by ESP

To make changes to configuration settings in the **Read Cycle** tree control:

1. **Left click** on the **+** to expand the tree.

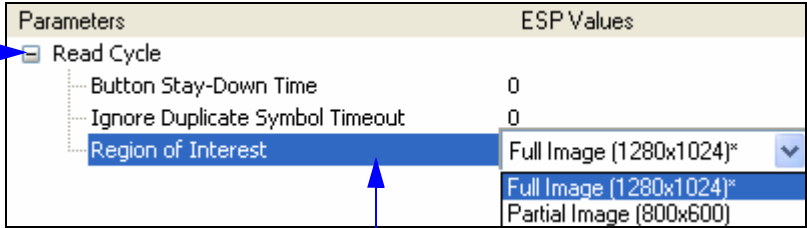

2. **Double click** on the parameter and click once in the selection box to view options.
3. Place your cursor in the selection box, scroll down to the setting you want to change and **click once** on the setting.

4. **Left click** again on the open screen to complete the selection.
5. **Right click** on the open screen and select **Save to Reader** to implement the command in the imager.

Button Stay-Down Time

Button Stay-Down Time sets the amount of time (in seconds) that the imager will continue to process the current “decode symbol” event. The imager will behave as if the trigger is being activated for this specified amount of time.

Button Stay-Down Time	0.000	↑ ↓	Seconds
-----------------------	-------	--------	---------

Ignore Duplicate Symbol Timeout

Ignore Duplicate Symbol Timeout sets the imager not to output the same symbol data multiple times within the time period designated.

Ignore Duplicate Symbol Timeout	0	↑ ↓	Seconds
---------------------------------	---	--------	---------

Region of Interest

Region of Interest allows the user to determine the size of the image window to be captured and decoded.

Note: Using a smaller Region of Interest, if possible, may enhance read cycle performance.

Full Image (1280 x 1024) (Default)



Partial Image (800 x 600)



Save Settings

Region of Interest by ESP

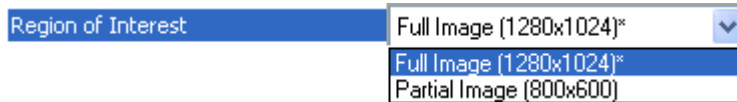

Region of Interest



6 Symbologies

Contents

- Symbologies by ESP 6-2
- Aztec..... 6-3
- BC412..... 6-4
- Codabar..... 6-5
- Code 39..... 6-6
- Code 93..... 6-7
- Code 128..... 6-8
- Composite 6-9
- Data Matrix 6-10
- GS1 DataBar 6-11
- Interleaved 2 of 5..... 6-12
- MicroPDF417..... 6-13
- PDF417 6-14
- Pharmacode 6-15
- QR Code..... 6-17
- UPC/EAN..... 6-18
- Symbology Identifier 6-19

This section describes the various symbol types that can be read and decoded by the imager.

Note: Disabling unused symbologies may substantially improve the Mobile Hawk’s decode speed.

Symbologies by ESP

To make changes to configuration settings in the **Symbologies** tree control:

1. **Left click** on the **+** to expand the tree.

2. **Double click** on the parameter and click once in the selection box to view options.

3. Place your cursor in the selection box, scroll down to the setting you want to change and **click once** on the setting.

Parameters	ESP Values
Symbologies	
2D Symbologies	
Data Matrix	Enabled
Data Matrix ECC 0 - 140	Enabled
QR Code	QR and Micro QR Code
Aztec Code	Disabled
1D Symbologies	
Code 39	Enabled
Checksum	Disabled
Extended Full ASCII	Disabled
Code 128	Enabled
BC412	Disabled
Code 93	Enabled
Codabar	Enabled
Checksum	Disabled
Interleaved 2 of 5	Enabled
Checksum	Disabled
Length	Disabled
UPC	Enabled
EAN Status	Enabled
Expansion	Enabled
Pharmacode	Disabled
Fixed Symbol Length Status	Disabled
Symbol Length	5
Minimum Bars	4
Bar Width Status	Mixed
Direction	Forward
Fixed Threshold Value	10
GS1 DataBar	Enabled (All)
Stacked Symbologies	
PDF417	Enabled
Micro PDF417	Disabled
Composite	Disabled
Symbology Identifier	Disabled*
	Disabled*
	Enabled

4. **Left click** again on the open screen to complete the selection.

5. **Right click** on the open screen and select **Save to Reader** to implement the command in the imager.

Aztec

Read the following symbols to enable/disable **Aztec** settings:

Aztec On



M273_01

Aztec Off (Default)



M272_01



M188_02

Save Settings

Aztec by ESP

Aztec Code	Disabled*	▼
	Disabled*	
	Enabled	

Sample Aztec Symbol



BC412

Read the following symbols to configure **BC412** settings:

BC412 Off (Default)



Q033_01

BC412 On



Q034_01

BC412 On, Remove Check Digit



Q035_01



M188_02

Save Settings

BC412 by ESP

BC412	Disabled* <input type="button" value="v"/>
	Disabled*
	Enabled
	Enabled - Remove Check Digit

Sample BC412 Symbol



123

Codabar

Read the following symbols to enable/disable **Codabar** settings:

Codabar On (Default)



M275_01

Codabar Off



M274_01



M188_02

Save Settings

Codabar by ESP

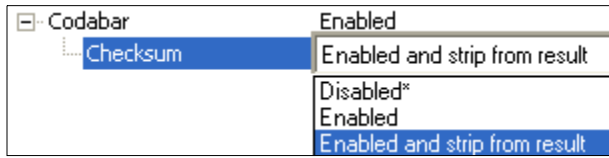

ESP allows you to enable a checksum, or to enable a check sum and remove it from the decode result.

Sample Codabar Symbol



A123456789A

Code 39

Read the following symbols to configure **Code 39** settings:

Code 39 On (Default)



M235_01

Code 39 Off



M234_01

Enable Checksum



M237_01

Disable Checksum (Default)



M236_01

Enable Checksum and Strip from Result



M238_01

Code 39 Extended Full ASCII On



M233_01

Code 39 Extended Full ASCII Off (Default)



M232_01



M188_02

Save Settings

Code 39 by ESP

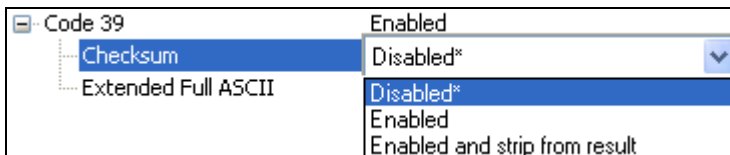

Sample Code 39 Symbol



123456

Code 93

Read the following symbols to enable/disable **Code 93** settings:

Code 93 On (Default)



M281_02

Code 93 Off



M280_01



M188_02

Save Settings

Code 93 by ESP

Code 93	Enabled*
	Disabled
	Enabled*

Sample Code 93 Symbol



123456789A

Code 128

Read the following symbols to enable/disable **Code 128** settings:

Code 128 On (Default)



M283_01

Code 128 Off



M282_01



M188_02

Save Settings

Code 128 by ESP

Code 128	Enabled*
	Disabled
	Enabled*

Sample Code 128 Symbol



123456789A

Composite

Composite consists of a 1D component associated with an adjacent 2D component. A successful decode is required for both the 1D and 2D components before the Mobile Hawk outputs a result. When Composite is enabled, the unit decodes the 1D component first.

Important: EAN-8, EAN-13, UPC-A, and UPC-E cannot be decoded individually when Composite is enabled.

Read the following symbols to enable or disable **Composite**:

Composite On



M285_02

Composite Off (Default)



M284_02



M188_02

Save Settings

Composite by ESP

Composite	Disabled*
	Disabled*
	Enabled

Sample Composite Symbol



Data Matrix

Read the following symbols to enable/disable **Data Matrix** settings:

Data Matrix ECC 0-140 On (Default)



Q005_01

Data Matrix ECC 0-140 Off



Q006_01



M188_02

Save Settings

Data Matrix by ESP

Data Matrix	Enabled*
Data Matrix ECC 0 - 140	Disabled
	Enabled*

Sample Data Matrix Symbol



GS1 DataBar

Read the following symbols to configure **GS1 DataBar** settings:

All DataBar On (Default)



All DataBar Off



DataBar Limited On



DataBar-14 and DataBar-14 Stacked On



DataBar Expanded On



Save Settings

GS1 DataBar by ESP

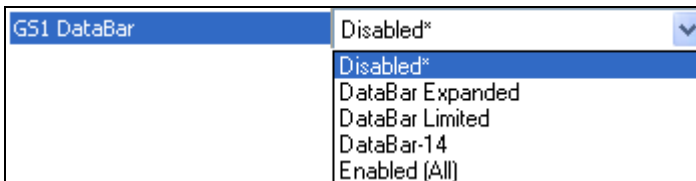

Sample DataBar-14 Limited Symbol



Sample DataBar-14 Stacked Symbol



Sample DataBar Expanded Symbol



Sample DataBar-14 Symbol



Interleaved 2 of 5

Read the following symbols to configure **Interleaved 2 of 5** settings:

Interleaved 2 of 5 On (Default)



M244_01

Interleaved 2 of 5 Off



M243_01

Interleaved 2 of 5 Two Digits On



M246_01

Interleaved 2 of 5 Two Digits Off



M245_02

Interleaved 2 of 5 Four Digits On



M248_01

Interleaved 2 of 5 Four Digits Off



M247_01

Interleaved 2 of 5 Checksum On



M250_01

Interleaved 2 of 5 Checksum Off



M249_01

Interleaved 2 of 5 Checksum On and Strip from Result



M251_01



M188_02

Save Settings

Interleaved 2 of 5 by ESP

☐ Interleaved 2 of 5	Enabled*	▼
└─ Checksum	Disabled	
└─ Length	Enabled*	

Sample Interleaved 2 of 5 Symbol



0123456789

MicroPDF417

Read the following symbols to enable/disable **MicroPDF417** settings:

MicroPDF417 On



M301_01

MicroPDF417 Off (Default)



M300_01



M188_02

Save Settings

MicroPDF417 by ESP

Micro PDF417	Disabled*
	Disabled*
	Enabled

Sample MicroPDF417 Symbol



PDF417

Read the following symbols to enable/disable **PDF417** settings:

PDF417 On (Default)



M293_01

PDF417 Off



M292_01



M188_02

Save Settings

PDF417 by ESP

PDF417	Enabled*	▼
	Disabled	
	Enabled*	

Sample PDF417 Symbol



Pharmacode

Read the following symbols to enable/disable **Pharmacode** settings:

Pharmacode Off (Default)



M408_01

Pharmacode On



M409_01



M188_02

Save Settings

Pharmacode by ESP

Pharmacode	Disabled*
Fixed Symbol Length Status	Disabled*
Symbol Length	Enabled
Minimum Bars	4
Bar Width Status	Mixed
Direction	Forward
Fixed Threshold Value	10

Fixed Symbol Length Status

When enabled, the imager will check the symbol length against the symbol length field. If disabled, any length will be considered valid.

Symbol Length

Specifies the exact number of bars that must be present for the imager to recognize and decode the Pharmacode symbol.

Minimum Bars

Sets the minimum number of bars that a Pharmacode symbol must have to be considered valid.

Bar Width Status

If set to **Mixed**, the imager will autodiscriminate between narrow bars and wide bars. If set to **All Narrow**, all bars will be considered as narrow bars. If set to **All Wide**, all bars will be considered as wide bars. If set to **Fixed Threshold**, it will use the fixed threshold value to determine whether the bars are narrow or wide. The **Bar Width Status** setting will be ignored when the imager is able to tell the difference between the narrow and the wide bars.

Pharmacode

Direction

Specifies the direction in which a symbol can be read.

Fixed Threshold Value

Used when **Bar Width Status** is set to **Fixed Threshold**. Defines the minimum difference in pixels that will distinguish a narrow bar from a wide bar.

Sample Pharmacode Symbol



QR Code

Read the following symbols to configure **QR Code** settings:

QR Code On



QR Code and Micro QR Code Off



Micro QR On



QR Code and Micro QR Code On (Default)



Save Settings

QR Code by ESP

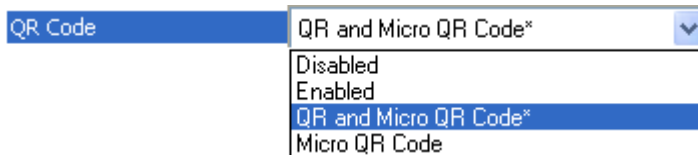

Sample QR Code Symbol



Sample Micro QR Code Symbol



UPC/EAN

Read the following symbols to configure **UPC/EAN** settings:

UPC On (Default)



M295_01

UPC Off



M294_01

UPC Expansion On (Default)



M297_01

UPC Expansion Off



M296_01

EAN On (Default)



Q037_01

EAN Off



Q036_01



M188_02

Save Settings

UPC/EAN by ESP

UPC	Enabled*
EAN Status	Disabled
Expansion	Enabled*

Sample UPC-E Symbol



Sample UPC-A Symbol



Symbology Identifier

When **Symbology Identifier** is enabled, an AIM (Association for Automatic Identification and Mobility) preamble is added to decoded data output (see the **AIM Symbology Identifiers** list). This preamble identifies what kind of symbology has been decoded.



M226_01

Symbology Identifier On



M225_01

Symbology Identifier Off (Default)



M188_02

Save Settings

Symbology Identifier by ESP

Symbology Identifier	Disabled*
	Disabled*
	Enabled

AIM Symbology Identifiers

- A** Code 39
- C** Code 128
- d** Data Matrix
- e** GS1 DataBar / Composite
- E** UPC/EAN
- F** Codabar
- G** Code 93
- I** Interleaved 2 of 5
- L** PDF417 / MicroPDF417
- Q** QR Code / Micro QR Code
- X** Other (Pharmacode)
- z** Aztec

7 I/O Parameters

Contents

I/O Parameters by ESP.....	7-2
Operational Feedback.....	7-3
Gain Control.....	7-4
Exposure.....	7-5
Data Validation.....	7-6

This section contains information on how to set your imager to the most efficient and effective parameters for your application.

I/O Parameters by ESP

To make changes to configuration settings in the **I/O Parameters** tree control:

1. **Left click** on the **+** to expand the tree.

The screenshot shows a tree control with a header 'Parameters' and 'ESP Values'. The 'I/O Parameters' folder is expanded. The 'Vibrate' parameter is selected, and its dropdown menu is open, showing 'Enabled*' as the selected option. A blue arrow points to the '+' icon next to 'I/O Parameters', and another blue arrow points to the 'Vibrate' parameter.

Parameters	ESP Values
I/O Parameters	
No Read Notification	Disabled
Targeting	Enabled
Beeper	
Volume	100
Duration	80
Separation	100
Beep/Vibrate on Good Read	Enabled
Vibrate	Enabled*
Text Command Timeout	Disabled
Data Validation	Enabled*
Gain Control	Adaptive
Exposure	2

2. **Double click** on the parameter and click once in the selection box to view options.
3. Place your cursor in the selection box, scroll down to the setting you want to change and **click once** on the setting.

4. **Left click** again on the open screen to complete the selection.
5. **Right click** on the open screen and select **Save to Reader** to implement the command in the imager.

Operational Feedback

Condition	Sound/Vibration	LED
Successful Power-On	1 Beep / Vibration	Sequence: AMBER GREEN AMBER
Successful Connection with Host via USB	1 Beep / Vibration	None
Successful Decode and Data Transfer to Host	1 Beep / Vibration	Flash GREEN
Configuration Symbol Successfully Decoded and Processed	2 Beeps / Vibrations separated by short pause	Flash GREEN

Beep and Vibration Modes

Read the following symbols to set beep and vibration modes.



M107_01

**Vibrate On /
Beep On
(Default)**



M109_01

**Vibrate On /
Beep Off**



M108_01

**Vibrate Off /
Beep On**



M188_02

Save Settings

Gain Control

Gain Control is a system that controls gain in the captured image—how bright or dark the resulting image will be. The higher the gain, the brighter the image.

When the Mobile Hawk is set to **Adaptive** mode, it will automatically maintain the proper setting for gain based on the captured image in order to produce the best setting to perform a decode. In the **Manual** setting the gain is fixed to whatever value is set by gain slider controls on the **Illumination** tab in **I/O Parameters**.

Gain Control	Adaptive*
Exposure	Manual
	Adaptive*

Exposure

The larger the **Exposure** value, the longer the pixels in the candidate image are exposed, allowing the imager to collect more light.

Note: A larger exposure value may cause blurred images.

Exposure

Data Validation

Data Validation is used to confirm that a decoded string from the imager has complied with a particular company, industry, or ISO standard. Mobile Hawk Data Validation is compliant with Department of Defense Unique Identification and ISO/IEC 15434 (Information Technology – Transfer Syntax for High-Capacity ADC Media) requirements.

Unique Identification

Unique Identification is a mandatory Department of Defense (DoD) requirement on all solicitations issued January 1, 2004 or later. This policy mandates the use of Unique Item Identifiers (UIIs) encoded within Data Matrix symbols on equipment and parts procured by DoD. The Mobile Hawk complies with Department of Defense Standard Practice Identification (MIL-STD-130).

Once the imager decodes the Data Matrix symbol, and if Unique Item Identifier (UII), Current Part Number (CPN), and Lot/Batch Number (LBN) are turned on, the Mobile Hawk checks the ISO/IEC 15434 syntax with ISO/IEC 15418 (ANSI MH10.8.2 – AI and DI) and ISO/IEC 21849 (ATA – TEI) semantics to construct the UII, CPN, and LBN.

Unique Identification Features

The following data output options are applicable to Data Matrix ECC 200 symbols only and have no effect on other symbologies.

<i>UII Enabled</i>	Allows the imager to read only message streams encoded in Data Matrix ECC 200 symbols, then to construct and output a UII string. The message streams include validation of Unique Item Identifier (UII), Current Part Number (CPN), and Lot/Batch Number (LBN) strings. When the imager decodes a symbol but the symbol data does not comply with UII format, it will stop capturing images and the green LED will illuminate without beeping, vibrating, or outputting the string.
<i>UII Enabled with Pass Through</i>	Allows the imager to read UII messages in Data Matrix ECC 200 symbols and non-UII messages in any type of symbols. The imager's behavior is the same as with UII Enabled.
<i>UII Enabled with Error Messages</i>	Allows the imager to read UII messages in Data Matrix ECC 200 symbols and output detailed information such as construction type, data components, or error messages. The imager's behavior is the same as with UII Enabled.
<i>Data Validation Disabled</i>	Disables both UII and ISO/IEC 15434 data validation.

Unique Identification Output Examples

UII Enabled

UII:UN123456789ABCDEFGH
CPN:87654321
LBN:87654321
UII:12345678 CPN:87654321
UII:12345678 LBN:87654321

UII Enabled with Pass Through

UII:UN123456789ABCDEFGH
CPN:87654321
LBN:87654321
UII:12345678 CPN:87654321
UII:12345678 LBN:87654321
DATA:Microscan Precision Data Acquisition and Control Solutions

UII Enabled with Error Messages

UII:UN123456789ABCDEFGH;Construct_1;25SUN123456789ABCDEFGH;;;;;
CPN:87654321;PNR;PNR 87654321;;;;;
LBN:87654321;30T;30T87654321;;;;;
UII:12345678 CPN:87654321;Construct_1_2/PNR;UID 12345678;PNR 87654321;;;;;
UII:12345678 LBN:87654321;Construct_1/30T;25S12345678;30T87654321;;;;;
(15434 ERROR: HEADER - 1ST POSITION);Microscan Precision Data Acquisition and
Control Solutions;;;;;

Data Validation Disabled

The imager will return to normal output behavior without performing data validation.

ISO/IEC 15434

ISO/IEC 15434 specifies a transfer structure, syntax, and coding of messages and data formats when using high capacity automatic data capture (ADC) technologies.

The following ISO/IEC 15434 data output options are applicable to Data Matrix ECC 200 symbols only and have no effect on other symbologies.

<i>ISO/IEC 15434 Enabled</i>	Allows the imager to read only ISO/IEC 15434-compliant message streams in Data Matrix ECC 200 symbols then output the ISO/IEC 15434 string. This implementation only checks the header/trailer format and proper format indicator (00-99 and DD). The output string has a prefix, a format indicator, and data components.
<i>ISO/IEC 15434 Enabled with Error Messages</i>	Allows the imager to read only ISO/IEC 15434-compliant messages in Data Matrix ECC 200 symbols and output detailed information such as prefix, format indicator, data components, or error messages.
<i>Data Validation Disabled</i>	Disables both Ull and ISO/IEC 15434 data validation.

ISO/IEC 15434 Output Examples

ISO/IEC 15434 Enabled

```
(15434);05;0100061414199999;211A0B9C3D6;;;;  
(15434);06;7L0A1B3C;1P4202435;S10936;;;;  
(15434);06;17V0A1B2;1P4202435;S10936;;;;
```

ISO/IEC 15434 Enabled with Error Messages

```
(15434);05;0100061414199999;211A0B9C3D6;;;;  
(15434);06;7L0A1B3C;1P4202435;S10936;;;;  
(15434);06;17V0A1B2;1P4202435;S10936;;;;  
(15434 ERROR: HEADER - 3RD POSITION);[< ▲ DD↔CAG 12345↔SER  
67890123 ▲ ◆;,,,,;  
(15434 ERROR: TRAILER - END OF TRANSMISSION);[> ▲ 12↔CAG 12345↔SER  
67890123 ▲ ♣;,,,,;  
(15434 ERROR: HEADER - GROUP SEPARATOR);[> ▲ 12 ▲ CAG 12345◆029SER  
67890123 ▲ ◆;,,,,;
```

Data Validation Disabled

The imager will return to normal output behavior without performing data validation.

Data Validation Settings

The following symbols control Data Validation functions:



Q048_01

***UII
Enabled***



Q049_01

***UII Enabled
with Pass Through***



Q050_01

***UII Enabled with
Error Messages***



Q051_01

***ISO/IEC 15434
Enabled***



Q052_01

***ISO/IEC 15434 Enabled
with Error Messages***



Q053_01

***Data Validation
Disabled (Default)***



M188_02

Save Settings

Data Validation by ESP

Each of the **Data Validation Settings** can also be enabled in **ESP's I/O Parameters** tree control.

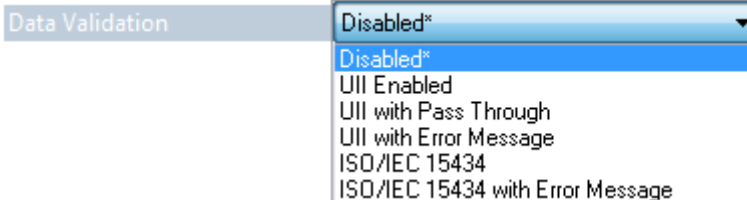

Detailed Output Format

The table below describes data validation output in detail.

Note: UII Enabled with Pass Through will add the prefix **DATA** to non-UII output for all symbologies.

Note: UII Enabled with Error Messages will output the following format: **UII/CPN/LBN; DF0; DF1; DF2; DF3; DF4; DF5; DF6; DF7**.

Note: When **ISO/IEC 15434** output is in compliance with the standard, the format is **(15434); DF0; DF1; DF2; DF3; DF4; DF5; DF6; DF7**. When it is not in compliance with the standard, the output is **(15434 ERROR: xxxx);;;;;;**, where DF0 is the format indicator showing which type of data qualifier is in use.

UII Enabled	
Content of Decoded Data Matrix Symbol	UII/CPN/LBN
Valid UII	UII:Uii_data Example: UII:12345678
Valid CPN Valid LBN	CPN:CPN_data Example: CPN:87654321 LBN:LBN_data Example: LBN:87654321
Valid UII and CPN Valid UII and LBN	UII:Uii_data CPN:CPN_data Example: UII:12345678 CPN:87654321 UII:Uii_data LBN:LBN_data Example: UII:12345678 LBN:87654321
Valid UII and Invalid CPN Valid UII and Invalid LBN	UII:Uii_data (CPN ERROR) Example: UII:12345678 (CPN ERROR) UII:Uii_data (LBN ERROR) Example: UII:12345678 (LBN ERROR)
Invalid UII and Valid CPN Invalid UII and Valid LBN	(UII ERROR) CPN:CPN_data Example: (UII ERROR) CPN:87654321 (UII ERROR) LBN:LBN_data Example: (UII ERROR) LBN:87654321
None of the above (Invalid UII; Invalid CPN; Invalid LBN; Invalid UII and Invalid CPN; Invalid UII and Invalid LBN)	No output data

UII Enabled with Error Messages		
Content of Decoded Data Matrix Symbol	UII/CPN/LBN	DFO
Valid UII	UII:UII_data <i>Example:</i> UII:12345678	Constructed UII type <i>Example:</i> Construct_1
Valid CPN Valid LBN	CPN:CPN_data <i>Example:</i> CPN:87654321 LBN:LBN_data <i>Example:</i> LBN:87654321	Constructed CPN type <i>Example:</i> PNR Constructed LBN type <i>Example:</i> 30T
Valid UII and CPN Valid UII and LBN	UII:UII_data CPN:CPN_data <i>Example:</i> UII:12345678 CPN:87654321 UII:UII_data LBN:LBN_data <i>Example:</i> UII:12345678 LBN:87654321	Constructed UII/CPN type <i>Example:</i> Construct_1/PNR Constructed UII/LBN type <i>Example:</i> Construct_1/30T
Valid UII and Invalid CPN Valid UII and Invalid LBN	UII:UII_data (30P ERROR: xxxx) UII:UII_data (PNR ERROR: xxxx) UII:UII_data (240 ERROR: xxxx) UII:UII_data (30T ERROR: xxxx)	Constructed UII type <i>Example:</i> Construct_1
Invalid UII and Valid CPN Invalid UII and Valid LBN	(UII ERROR: xxxx) CPN:CPN_data (UII ERROR: xxxx) LBN:LBN_data	Constructed CPN type: 30P, PNR, 240 Constructed LBN type: 30T
Invalid UII	(UII ERROR: xxxx) (15434 ERROR: xxxx) <i>Example:</i> (UII ERROR: DATA ELEMENT CHARACTER)	Original decoded data
Invalid CPN Invalid LBN	(30P ERROR:xxxx) (PNR ERROR:xxxx) (240 ERROR:xxxx) (30T ERROR:xxxx) (15434 ERROR: xxxx)	Original decoded data
Invalid UII and Invalid CPN Invalid UII and Invalid LBN	(UII ERROR: xxxx) (30P ERROR: xxxx) (UII ERROR: xxxx) (PNR ERROR: xxxx) (UII ERROR: xxxx) (240 ERROR: xxxx) (UII ERROR: xxxx) (30T ERROR: xxxx)	Original decoded data

Error Messages

The following is a list of potential error messages.

15434 ERROR: DATA ELEMENT SEPARATOR
15434 ERROR: DOUBLE TRAILER
15434 ERROR: FORMAT INDICATOR
15434 ERROR: HEADER - 1ST POSITION
15434 ERROR: HEADER - 2ND POSITION
15434 ERROR: HEADER - 3RD POSITION
15434 ERROR: HEADER - 4TH POSITION
15434 ERROR: HEADER - GROUP SEPARATOR
15434 ERROR: TRAILER - END OF TRANSMISSION
15434 ERROR: TRAILER - RECORD SEPARATOR
PNR ERROR: TOO LONG
PNR ERROR: TOO SHORT
PNR ERROR: CHARACTER
30P ERROR: TOO LONG
30P ERROR: TOO SHORT
30P ERROR: CHARACTER
240 ERROR: TOO LONG
240 ERROR: TOO SHORT
240 ERROR: CHARACTER
UII ERROR: DATA ELEMENT CHARACTER
UII ERROR: DATA ELEMENT TOO LONG
UII ERROR: DATA ELEMENT TOO SHORT
UII ERROR: LOWER CASE CHARACTER
UII ERROR: NEED UII ELEMENT FIRST
UII ERROR: SPACE AFTER TEI DATA QUALIFIER
UII ERROR: TEI DATA QUALIFIER
UII ERROR: UII ELEMENT INCOMPLETE
UII ERROR: WRONG FORMAT INDICATOR
UII ERROR: UII STRING TOO LONG

Additional Notes

- DF1 – DF7: If the UII/CPN field is “(15434 ERROR: xxxx)”, DF1 – DF7 are filled in with an empty string. Otherwise, the fields are used to display data elements. If there are fewer than seven data elements, an empty string is filled in at the end. If there are more than seven elements, only the first seven elements are displayed.
- There is a space between UII and CPN in both tables (UII:12345678 CPN:87654321).
- The constructed UII type can be Construct_1, Construct_2, Construct_1_2, or IUID_EQUIVALENT.
- The constructed CPN type can be PNR, 30P, or 240. The constructed LBN type can be 30T.

■ 8 *Advanced Operations*

Contents

Dot Peen Enhanced Illumination Settings	8-2
Illumination Settings by ESP	8-3
Lock Settings	8-6

This section introduces several settings that can be applied to speed up processing or improve readability in various circumstances.

Dot Peen Enhanced Illumination Settings

The Mobile Hawk's Dot Peen Enhanced illumination settings can be controlled using the configuration symbols shown here. They can also be controlled in ESP's **EZ Mode**.

Note: The illumination default mode will reset the imager's illumination settings to factory default.



Q044_01

***Illumination
Default Mode***



Q045_01

***Dot Peen Enhanced Illumination
Mode - Large Mark***



Q046_01

***Dot Peen Enhanced Illumination
Mode - Medium Mark***



Q047_01

***Dot Peen Enhanced Illumination
Mode - Small Mark***



M188_02

Save Settings

Illumination Settings by ESP

The Mobile Hawk's illumination settings can also be controlled using the graphic interface on the **Illumination** tab in ESP's **I/O Parameters** view.

Define how many illumination steps (1 - 8) the imager will cycle through during its sequence.

Click this button to default settings for the Mobile Hawk illumination sequence.

Click **Create Bar Code** to encode illumination settings in a programming symbol.

The screenshot shows the **Illumination** tab in the ESP interface. At the top, there are tabs for **Illumination** and **Video**. Below the tabs, there is a checkbox for **Auto Sync Illumination** (checked) and a **Sequence Steps** spinner set to 4. To the right are **Default** and **Create Bar Code...** buttons. Below this is a **Gain Control Manual** checkbox (unchecked). The main area contains four steps, each with a dropdown menu for the step name, a **Gain** slider, and an **Image Enhance** section. The **Image Enhance** section includes checkboxes for **Grow Dark** and **Grow Light**, and a **Mark Size** dropdown menu. A **Low Resolution Image** checkbox is also present for each step. Callouts provide additional information: one points to the **Sequence Steps** spinner, another to the **Default** button, a third to the **Create Bar Code...** button, a fourth to the **Low Resolution Image** checkbox for Step 1, a fifth to the **Gain** slider for Step 4, and a sixth to the **Image Enhance** section for Step 4.

Gain can be controlled using the sliders shown in each **Step** dialog when the **Gain Control Manual** box is checked.

Select **Low Resolution Image** for larger symbols.

Image Enhance features apply advanced image processing to improve the readability of the mark.

Image Enhance Settings

Image Enhance settings apply morphological pre-processing (erosion and dilation) to symbol cells to improve readability. Symbols that are under-marked or over-marked can benefit from Image Enhance settings. The **Grow Dark** and **Grow Light** checkboxes allow you to determine which cells will be enhanced (grown).

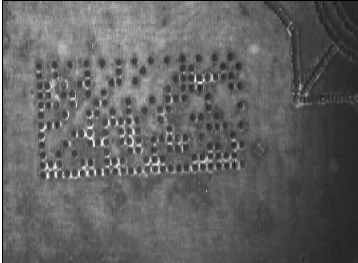

Red Dome Illumination Without Image Enhance

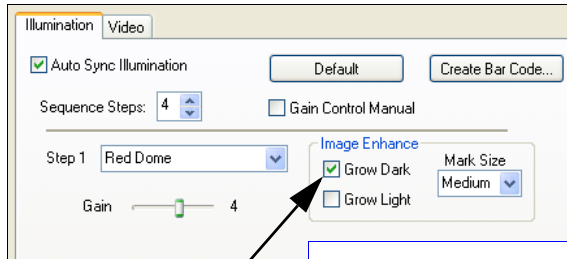

Click **Grow Dark** or **Grow Light** on the **Illumination** tab in **I/O Parameters** to improve decode performance on under-marked or over-marked direct part marks.

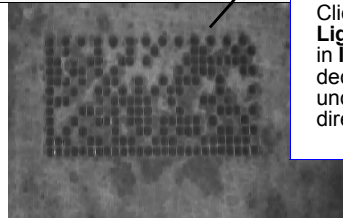

Red Dome Illumination With Image Enhance – Grow Dark (Medium Mark Size)

Grow Dark

Grow Dark enhances the symbol's dark cells.

Note: Grow Dark corresponds with the morphological process of erosion.

Grow Light

Grow Light enhances the symbol's light cells.

Note: Grow Light corresponds with the morphological process of dilation.

Low Resolution Image

Low Resolution Image reduces the number of pixels in the image by 50%, which is helpful when the symbol to be decoded has a large number of pixels per element (e.g. a large Data Matrix with a 100 mil cell size, or a 1D symbol with large bar widths). This feature improves processing speed, because the image sizes are smaller.

Note: Low Resolution with Low Angle is the first step in the Mobile Hawk's illumination sequence, because it covers the widest range of potential candidate symbols.

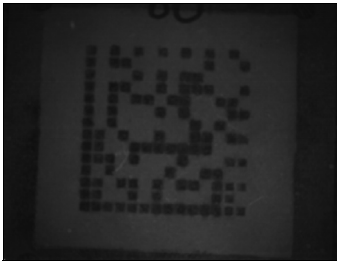

**14x14 – 1.5 in²
100 mil Cell Size
Without Low Resolution**

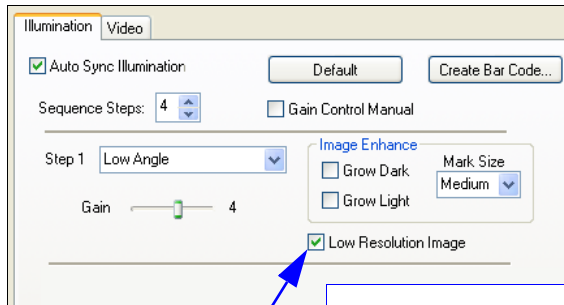

Click **Low Resolution Image** on the **Illumination** tab in **I/O Parameters** to speed up processing.



**14x14 – 1.5 in²
100 mil Cell Size
With Low Resolution**

Lock Settings

Read the symbols below to lock or unlock imager settings.

Note: This feature does not lock preamble and postamble programming symbols, Clear XML Rules, or postamble erase/none commands.



M429_01

***Lock Imager
Settings***



M428_01

***Unlock Imager
Settings***



M188_02

Save Settings



9 Terminal

Contents

- Terminal View..... 9-2
- Find 9-3
- Send 9-4
- Macros..... 9-5
- Terminal Right-Click Menu..... 9-6
- Terminal Dropdown Menu..... 9-7

This section describes the **Terminal** interface and macro functions in **ESP**.

Terminal View

Click the **Terminal** button.

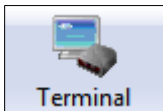

You will see the following view:

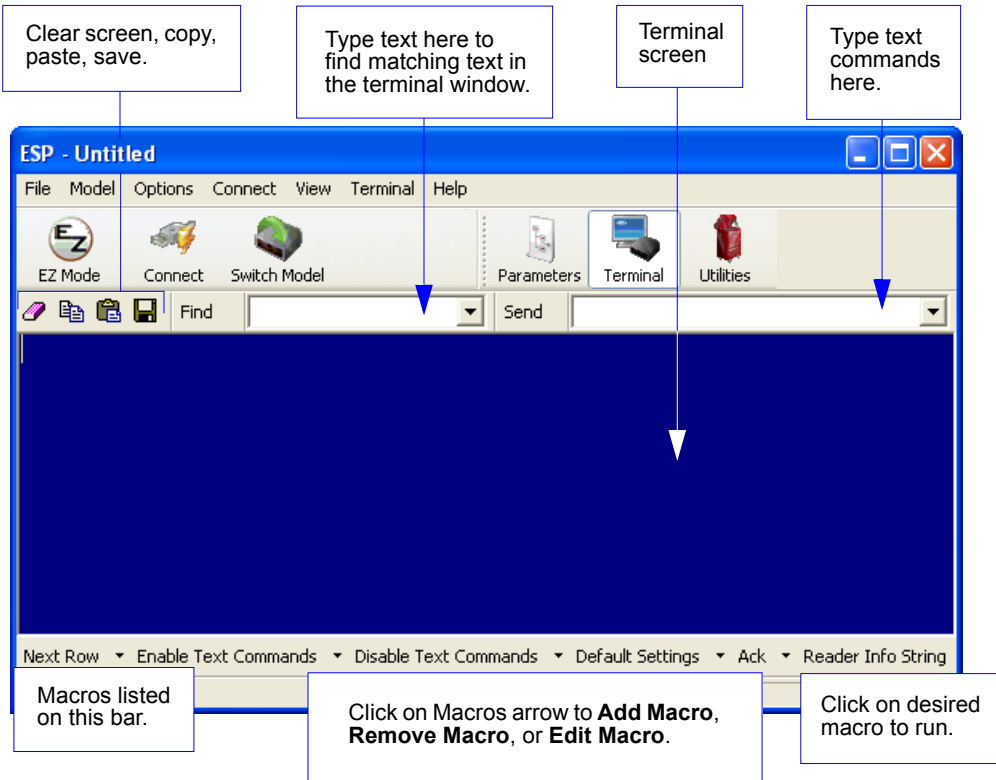

The screenshot shows the Terminal window titled "ESP - Untitled". The window has a menu bar with "File", "Model", "Options", "Connect", "View", "Terminal", and "Help". Below the menu bar is a toolbar with icons for "EZ Mode", "Connect", "Switch Model", "Parameters", "Terminal", and "Utilities". A "Find" field and a "Send" button are also present. The main area is a large blue terminal screen. At the bottom, there is a status bar with dropdown menus for "Next Row", "Enable Text Commands", "Disable Text Commands", "Default Settings", "Ack", and "Reader Info String".

Callout boxes provide the following instructions:

- Clear screen, copy, paste, save.
- Type text here to find matching text in the terminal window.
- Terminal screen
- Type text commands here.
- Macros listed on this bar.
- Click on Macros arrow to **Add Macro**, **Remove Macro**, or **Edit Macro**.
- Click on desired macro to run.

The Terminal interface allows you to send commands to the imager by using macros, by copying and pasting, or by typing commands in the **Send** text field.

The Terminal view also displays symbol data or information from the imager.

You can also right click on the Terminal screen to bring up a menu of further options.

Find

The **Find** function allows you to enter text strings to be searched for in the terminal window. For example, suppose a series of symbols have been scanned into the terminal view and you want to determine if a particular symbol whose data begins with “ABC” has been read.

1. Type “ABC” into the **Find** box.



2. Press **Enter**.

The first instance of “ABC” will be highlighted in the terminal window.

3. Click the **Find** button to the left of the text field to locate additional instances of “ABC”.

Send

The **Send** function allows you to enter text commands and then send them to the imager. (See **Text Commands**.)

For example, suppose you want to disable the vibrate function in the imager. To disable vibrate using a text command, you would enter "P%A10" (the command that disables vibrate) in the text field and click **Send**.

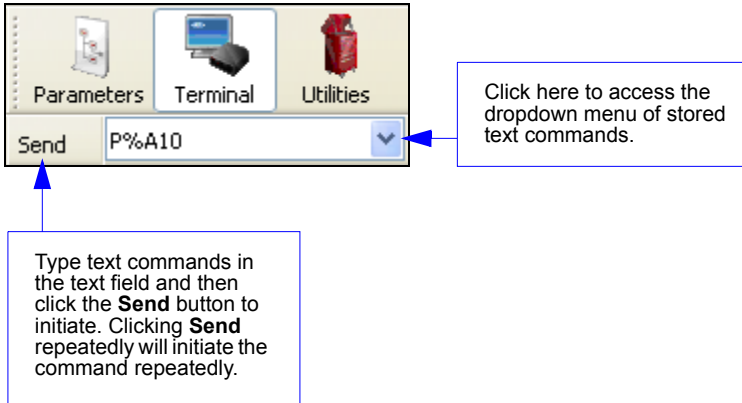

Once text commands are initiated, they are saved in a dropdown menu that can be accessed by clicking the arrow to the right of the text field.

You can also send the current command repeatedly by clicking the **Send** button repeatedly.

Macros

Macros can be stored in a macro selection bar, edited in a separate window, and executed by clicking on the macro name.

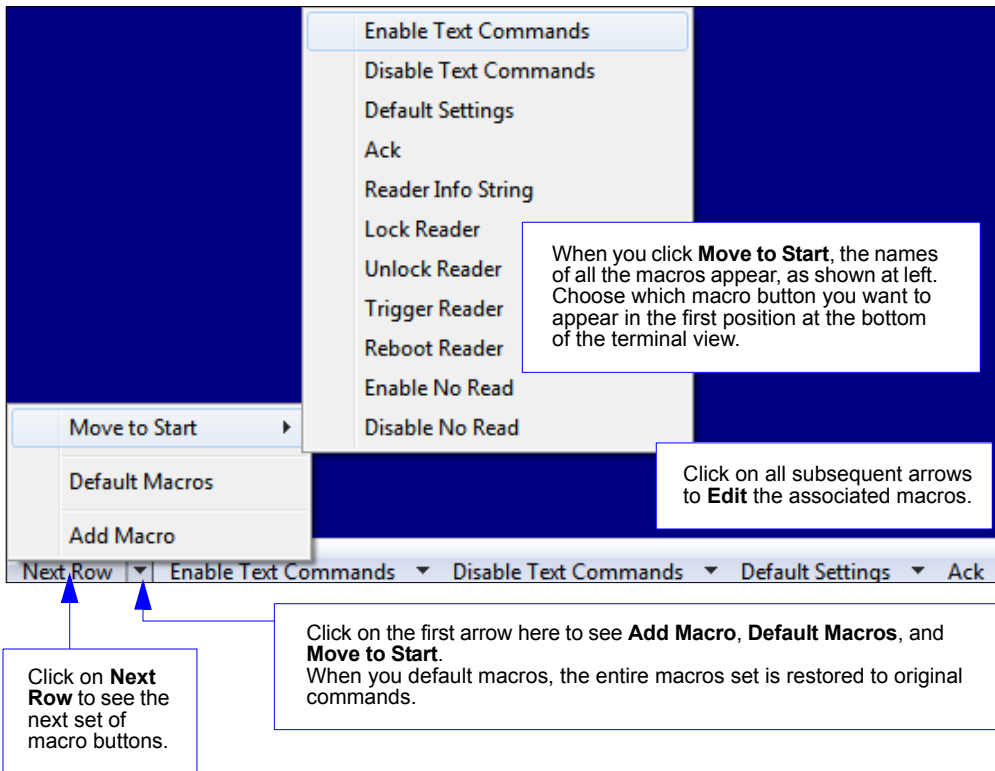

Clicking on a macro button executes the related command. The command is also sent to the imager at the same time it is displayed.

Editing a Macro

When you click the arrow next to a macro and select **Edit**, the following dialog appears:

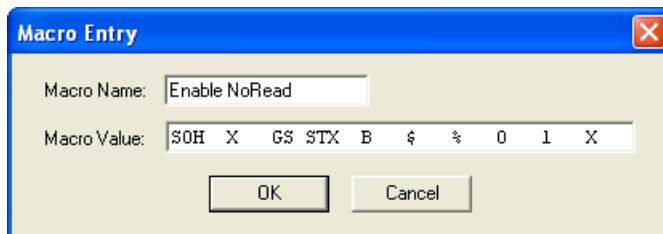

You can edit an existing macro or type in the **Macro Name** text field and define it in the **Macro Value** text field.

Terminal Right-Click Menu

Right click in the terminal window to display the following menu:

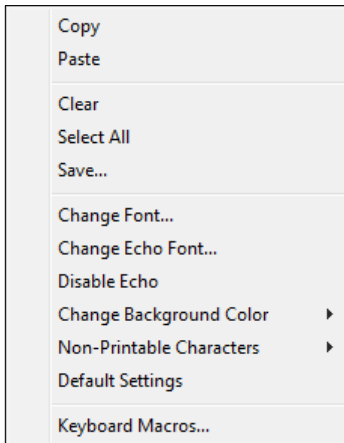

- **Copy** selected text to clipboard.
- **Paste** from terminal or other text.
- **Clear** all text in terminal window.
- **Select All** text in the terminal window.
- **Save...** incoming and outgoing data into a text file.
- **Change Font...** of data received from the imager.
- **Change Echo Font...** to change the appearance of user-entered data.
- **Disable Echo** to hide user-entered data.
- **Change Background Color** of the terminal window.
- **Non-Printable Characters** can be shown or hidden in the terminal view in **Standard** or **Enhanced** format.
- **Default Settings** to return all of the above to original settings.
- **Keyboard Macros** brings up the **Function Keys** dialog, which allows you to create customized macro functions.

Function Keys

The **Function Keys** dialog allows you to assign commands to specific function keys on a standard keyboard. Note that the **F1** key is reserved for opening **ESP Help**, and the **F3** key is reserved for the **Find Next** function.

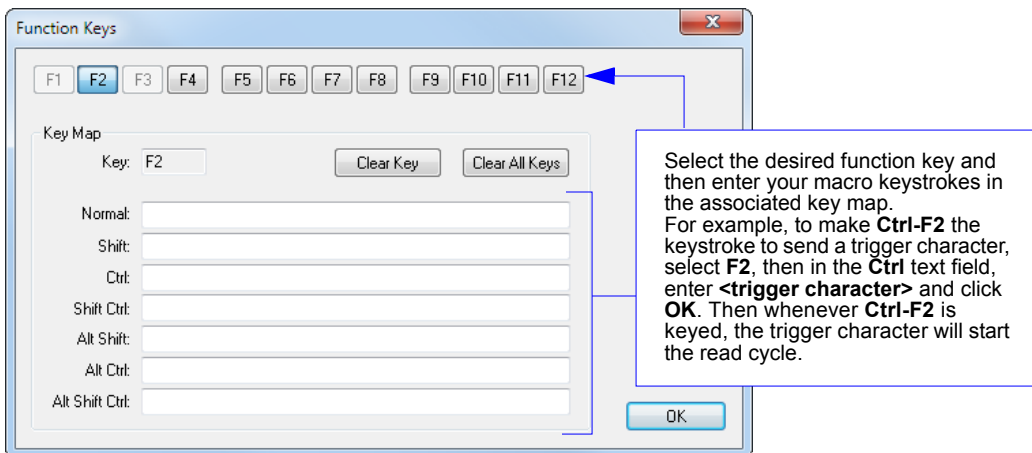

Note: This feature is also available from the **Terminal Dropdown Menu** and the **Terminal** tab of the **Preferences** dialog.

Terminal Dropdown Menu

The terminal dropdown menu allows you to capture and save current text, and it also includes the functions defined for the [Terminal Right-Click Menu](#).

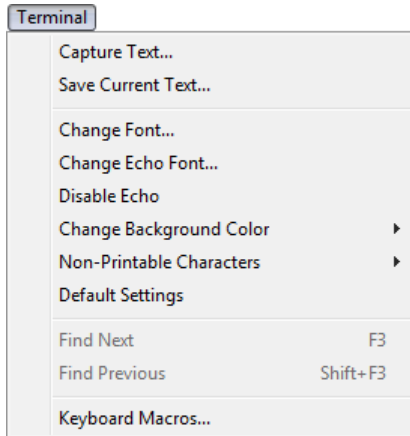

- **Capture Text...** lets you append data in real time to a text file of your choice. While in operation, the text file cannot be opened. You can select **Pause** to interrupt the capture flow or **Stop** to end the flow and open the file.
- **Save Current Text...** saves all text in the terminal window to a text file of your choice.
- **Find Next** locates the next instance of the specified data string in the terminal. This function can also be activated by pressing **F3**.
- **Find Previous** locates the most recently occurring instance of the specified data string in the terminal.
- **Keyboard Macros** brings up the **Function Keys** dialog, which allows you to create customized macro functions.

10 Utilities

Contents

Device Control.....	10-2
Differences from Default	10-3
Firmware	10-4
Advanced	10-6

This section explains **ESP's Utilities** features. These include **Device Control**, an interface that lets you perform major operations with one click; **Differences from Default**, which shows all currently enabled Mobile Hawk settings that are not default settings; **Firmware**, where you can update your imager's firmware; and **Advanced**, which allows you to collect batch files for customized imager configuration and optimization.

Device Control

This feature allows you to clear data stored in the imager's memory, to default the imager, to deactivate or clear XML rules, to upload or delete stored errors, to reboot the imager, and to delete stored results.

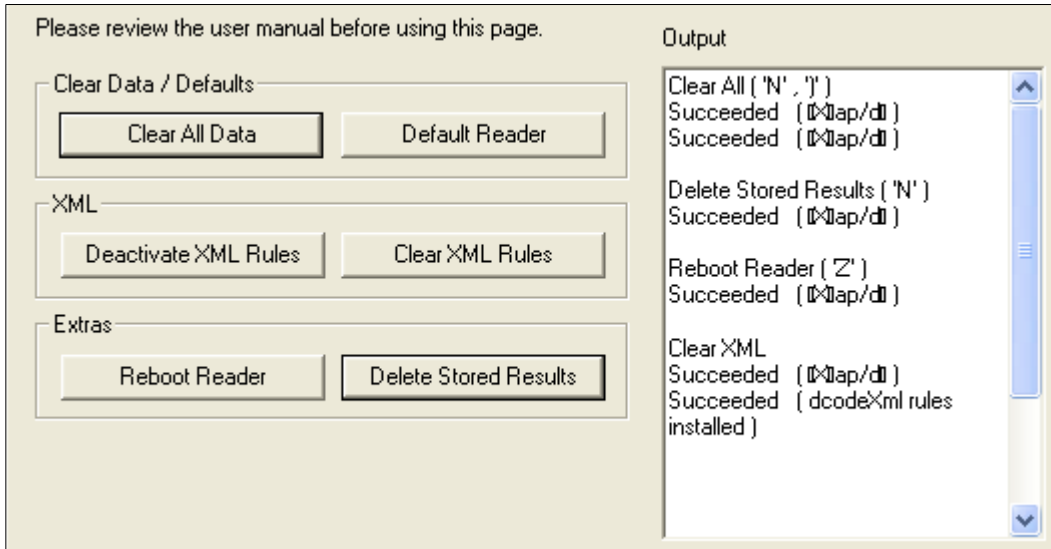

- **Clear All Data** removes decoded symbol data and commands in the imager's memory.
- **Default Reader** returns the imager to its default state, without any optimization or configuration.
- **Deactivate XML Rules** turns off, but does not erase, preambles, postambles, and XML commands.
- **Clear XML Rules** removes preambles, postambles, and other XML commands.
- **Reboot Reader** refreshes the imager's memory and functionality, returning it to the most recent configuration you have saved.
- **Delete Stored Results** erases logged data.

Differences from Default

Clicking the **Differences from Default** button will cause **ESP** to check all stored configuration settings and compare them to default settings. All settings that are different from default will appear in the left column (shown below), and descriptions of those settings will appear in the right column.

Click this button for a list of **ESP** configuration settings that are different from default settings.

Click **Generate Bar Code** to bring up the **Bar Code Configuration** dialog. Then create symbols containing the configuration commands of your choice.

Command	Description
!!!!Ft&32	Volume (50)

Send configuration settings to the imager without saving by clicking **Send to Reader**.

Click **Save As** to save the report as plain text or a tab-delimited text file.

Send configuration settings to the imager and save in **ESP** by clicking **Send and Save**.

- To create a symbol containing any of the command settings in the table, click **Generate Barcode**. This will bring up the **Bar Code Configuration** dialog.
- To save the **Differences from Default** report, either as plain text or as a tab-delimited text file, click **Save As**.
- Click **Send and Save** to send the settings to the imager and save them, or **Send to Reader** to send the settings without saving them.

Firmware

The **Firmware** view in **ESP Utilities** is a simple way to update and verify your imager's firmware and to update batch files.

Choose **App Code** from the **Firmware Update** dropdown menu and click **Start** to install new firmware in the Mobile Hawk.

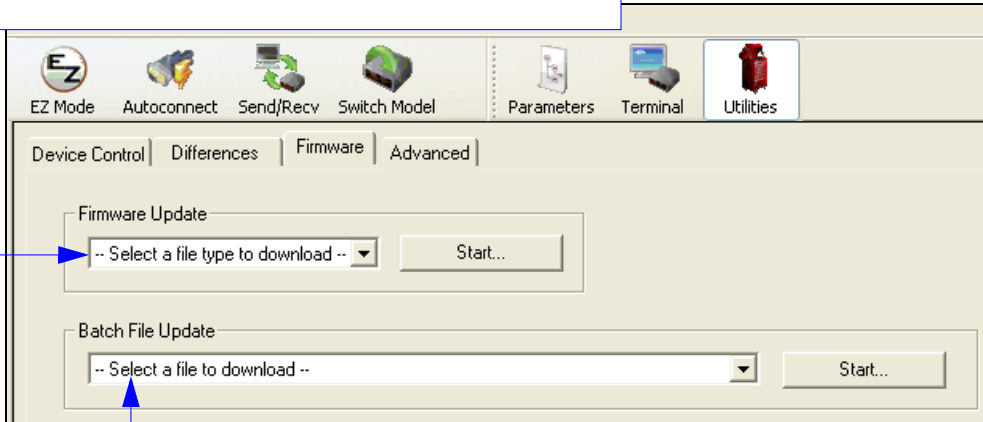

Use this dropdown menu to locate batch files in the host computer's file directory. Download the needed files directly to the imager by clicking the **Start** button.

The **Firmware Verification** tool sends a direct query to the imager for its Application Code Version, Firmware Version, Boot Code Version, and Radio Version.

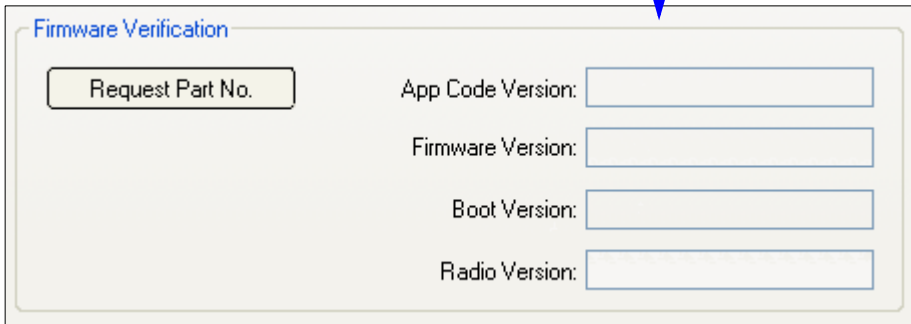

Note: To ensure correct operation, cycle power to the imager (turn the imager off and then on) after the firmware update is complete.

Imager ID

Another way to query the imager for its identifying information is by reading the following symbol:



Imager ID

M153_01



Save Settings

M188_02

The host's text program will output a data string containing the imager's identifying information in the following format:

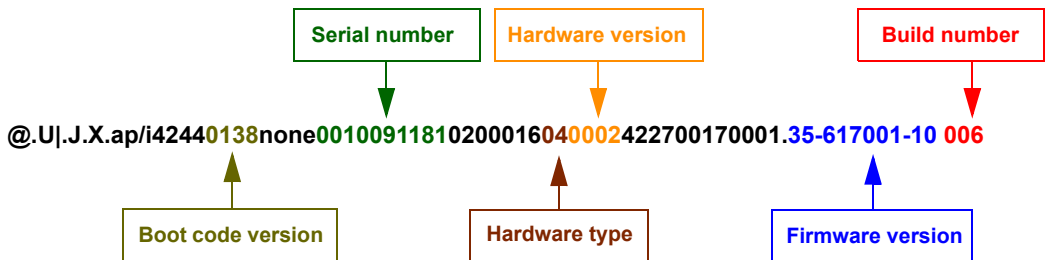

Advanced

The **Advanced** tab in **Utilities** features an archive of all batch files containing imager configuration commands. Each batch file's extension is .crb, and each file contains the fundamental code for programming the imager. Notice that the names of the batch files correspond with the numbers beneath all the Data Matrix configuration symbols.

This tool allows you to use the batch file data to create your own symbols, or to collect only the files that you use frequently to configure the imager for your application.

The screenshot shows the 'Advanced' tab in the 'Utilities' application. It features two main windows: 'Batch File Archive' and 'Batch File Collection'. The 'Batch File Archive' window contains a list of batch files with their descriptions. The 'Batch File Collection' window is currently empty. A 'Batch File Creator' dialog box is visible in the top right corner, containing buttons for 'Download Collection', 'Save Collection As...', 'Add Batch File Folder', and 'Browse...'. Two callout boxes provide instructions on how to use the 'Download Collection' and 'Save Collection As...' buttons, and how to scroll through the list of batch files and use the 'Add', 'Remove', and 'Remove' buttons.

The Download Collection and Save Collection As... buttons allow you to acquire the entire contents of the batch file archive and save the files in a location of your choice.

Scroll through the list of batch files in the archive and choose the ones you need. Move them to the collection window using the Add arrow. Files can also be transferred by clicking and dragging.

The single Remove arrow functions in the same way as the Add arrow, except that it transfers files back to the batch archive. The double Remove arrow allows you to transfer all files simultaneously.

Appendices

Appendix A General Specifications A-2
Appendix B Electrical Specifications A-4
Appendix C Default/Reset Procedure..... A-7
Appendix D Maintenance A-8
Appendix E Troubleshooting A-9

Appendix A — General Specifications

Mechanical

Height: 7" (180 mm)

Width: 2.5" (63 mm)

Depth: 4.5" (114 mm)

Weight: 7.2 oz. (204 g) (not including cable)

Environmental

Operating temperature: 0° to 50° C
(32° to 122° F)

Storage temperature: -20° to 65° C
(-4° to 150° F)

Humidity: 5 to 95% (non-condensing)

Shock: Withstands >50 drops of 6' (1.8 meters) to concrete

MAXlite Illumination

Combination Dome and Low Angle illumination system.

Dome: 2-color, 640nm (red) and 470nm (blue)

Low Angle: Quadrant 30°, 640nm (red)

Symbologies

Aztec, BC412, Codabar, Code 39, Code 93, Code 128, Data Matrix (ECC 0-200), GS1 DataBar, Interleaved 2 of 5, MicroPDF417, Micro QR Code, PDF417, Pharmacode QR Code, UPC/EAN

Image Collection Options

Sensor: CMOS

Sensor Array: 1280 x 1024

Communication Protocols

Standard Interface: USB, RS-232

Read Parameters

Rotational Tolerance: ±180°

Focal Range: 0 to 2" (0 to 50.8 mm)

Focal Point: Optimal at 0.25" (6.3 mm)

Field of View: Horiz. 1.59" (40.39 mm) x Vert. 1.27" (32.31 mm) at optimum focus

Print Contrast Resolution: 20% minimum contrast

Ambient Light Immunity: Sunlight: Up to 9,000 ft. candles, 96,890 lux

Indicators

Status Indicators: Vibration motor, audible tones, visual feedback with multi-color LED, blue-line targeting pattern

Image Output Options

Format: JPEG, TIFF

Electrical

Power Requirements: 5 VDC (mA)

Typical: 408mA **Peak:** 500mA **Idle:** 285mA

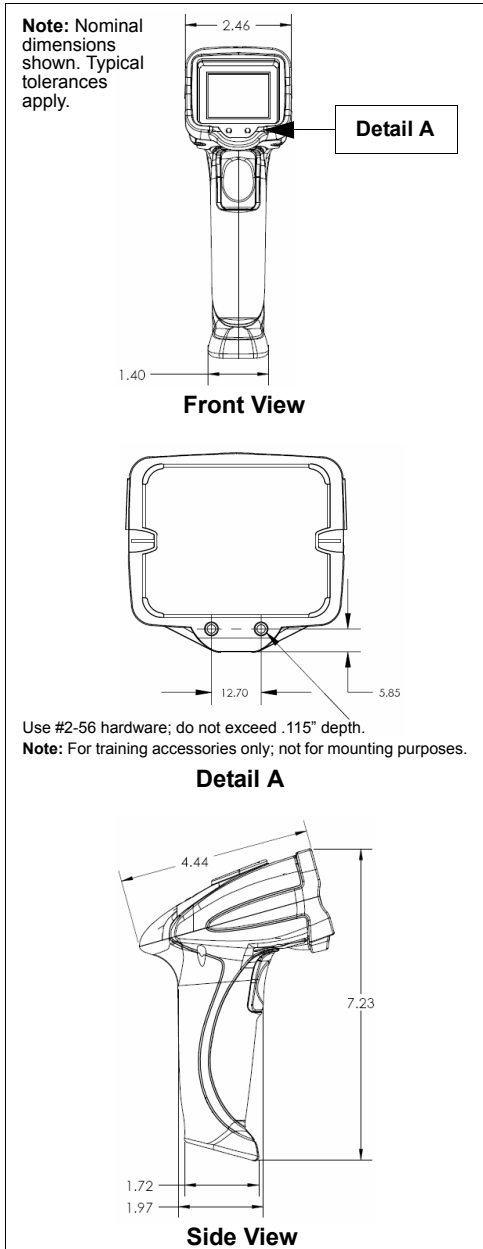

Mobile Hawk Dimensions

Safety Certifications

FCC, CE, RoHS/WEEE



Copyright ©2015
Microscan Systems, Inc.

All rights reserved. Specifications subject to change.
Product specifications are given for typical performance at 25°C (77°F) using grade A labels. Performance characteristics may vary at high temperatures or other environmental extremes. Standard Warranty—One-Year Limited Warranty on parts and labor. Extended 3-Year Warranty available.

Read Ranges

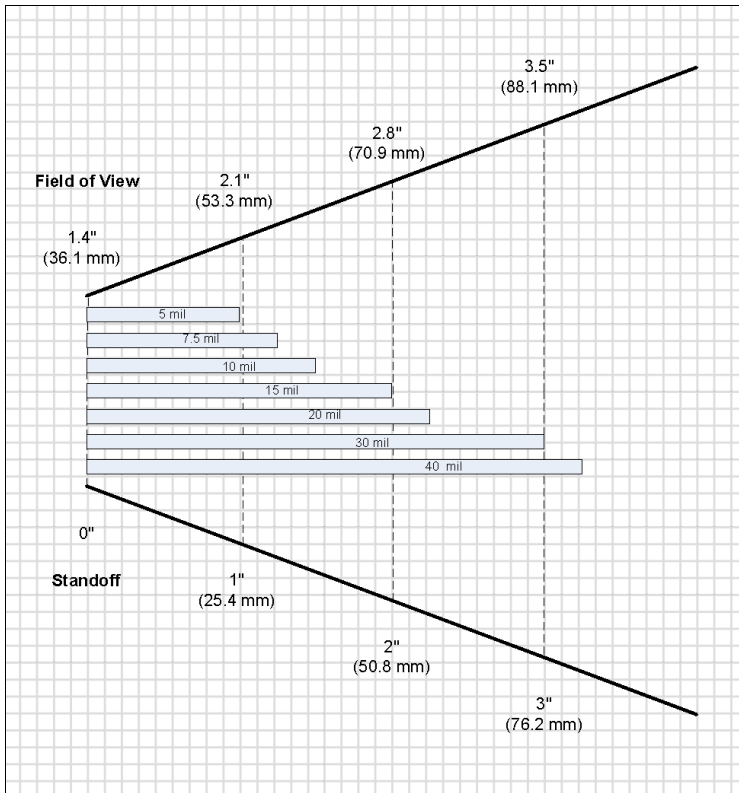

FIS Options

FIS-6170-0002G	Mobile Hawk Handheld DPM Imager, USB
----------------	--------------------------------------

Accessories

98-000074-04	Kit, RS-232 U.S. Power Supply
98-000074-05	Kit, RS-232 EU Power Supply
98-000074-06	Kit, RS-232, UK Power Supply

Appendix B — Electrical Specifications

Power Requirements: 5 VDC (mA)
Typical: 408mA; Peak: 500mA, Idle: 285mA

PIN 1	VIN- Input Voltage to the voltage regulators/battery charging IC
PIN 2	RS-232_TX - RS-232 level serial transmit signal
PIN 3	RS-232_RX - RS-232 level serial receive signal
PIN 4	PS/2_DATA_UART_RX_USB_DP - PS/2 clk to host/ UART transmit signal/ USB Data plus signal
PIN 5	PS/2_DATA_UART_RX_USB_DM - PS/2 data to host or keyboard/ UART receive signal/ USB Data minus signal
PIN 6	PS/2_CLK_KB - PS/2 clock signal to the keyboard
PIN 7	~TRIG - trigger from the handle
PIN 8	GND - signal ground
Shield	Shield Ground

USB Cable Pinouts

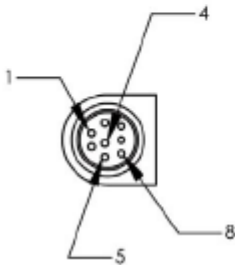
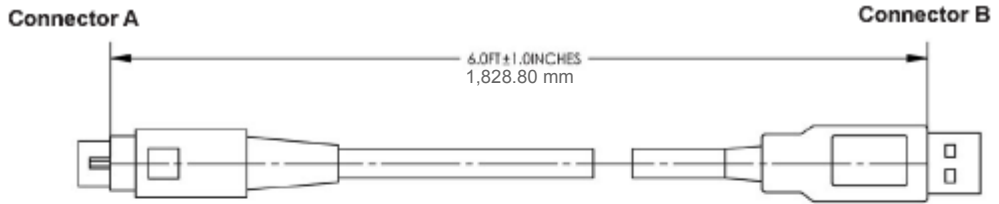

WIRING TABLE:

CONN A	NAME	WIRE	COLOR	CONN B
1	V+	24AWG	RED	1
2	NC			
3	NC			
4	D+	28AWG	GREEN (TWISTED)	3
5	D-	28AWG	WHITE (TWISTED)	2
6	NC			
7	NC			
8	GND	24AWG	BLACK	4
SHELL	—	DRAIN	BARE	SHELL

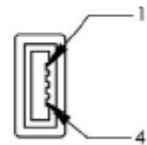

RS-232 Cable Pinouts

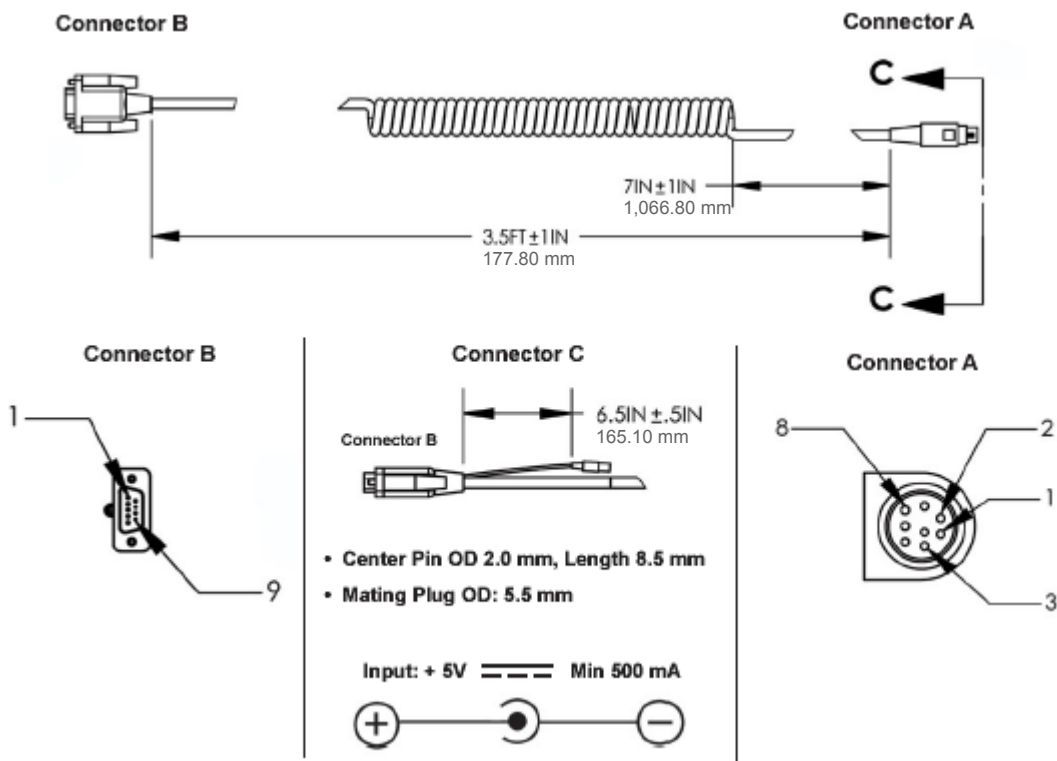

WIRING DIAGRAM:

CONN A	NAME	WIRE	COLOR	CONN B	WIRE	COLOR	CONN C
1	PWR	24AWG	RED	1	24AWG	RED	TIP
2	TX	28AWG	BROWN	2			
3	RX	28AWG	ORANGE	3			
4	NC						
5	NC						
6	NC						
7	NC						
8	GND	24AWG	BLACK	5	24AWG	BLACK	RING
9	NC						
SHELL	--	DRAIN	BARE	SHELL			

* SEE WIRING DIAGRAM BELOW FOR CONN A PIN 1, CONN B PIN 1 AND CONN C TIP

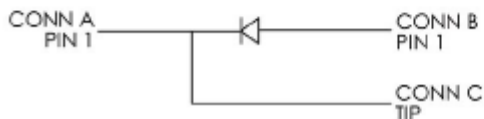

Appendix C — Default/Reset Procedure

If the Mobile Hawk locks up or becomes unresponsive, or if you would like to clear all configuration and programming from the imager, follow the procedure below.

Important: The following procedure will clear the buffer, default configuration, and XML programming, including Preamble and Postamble.

1. Unplug the Mobile Hawk from the PC.
2. While holding down the trigger, plug the reader into the USB port on the PC. You will hear five rapid beeps.
3. Let go of the trigger after the five rapid beeps. The imager is now in Boot Mode.
4. Hold down the trigger again for approximately five seconds until it reboots. The imager will vibrate first and then beep several times.
5. The imager should now operate in default mode. Save the default settings by reading this symbol:



M188_02

Appendix D — Maintenance

The Mobile Hawk provides reliable and efficient operation with a minimum of care. Although specific maintenance is not required, the following periodic checks ensure dependable operation.

Cleaning the Mobile Hawk Window

The Mobile Hawk has a clear, anti-reflective coated optical window that protects the Mobile Hawk illumination system and optics. The window should be clean to allow optimum performance. The Mobile Hawk uses technology that is much like a digital camera, and marks or debris on the window will interfere with image captures. Avoid touching the coated surface, as fingerprints may impede decode performance.

In many cases the window can be cleaned by wiping with a lint-free lens cloth to remove dust, debris, and fingerprints. Care should be taken not to apply too much pressure, as a trapped particle may scratch the window.

If cleaning of the window becomes necessary, follow this procedure:

- Use a minimal amount of Isopropyl Alcohol to dampen. Do not saturate the surface, as this may cause streaking.
- Drag the moistened cotton swab, cotton ball, or soft, clean cloth across the coated surface. Do not rub.
- Repeat this procedure until no contaminants remain.

Note: Many products designed for cleaning plastic lens eyewear, such as pre-moistened towelettes or lens cloths, can be used to clean the Mobile Hawk window.

Cleaning the Mobile Hawk Housing

If the housing becomes dirty, clean it with a soft, non-abrasive cloth that has been moistened with water. A mild detergent may be used to clean the housing, but the detergent should then be rinsed away with a water-moistened cloth.

Caution: Do not submerge the Mobile Hawk in water. The housing is not watertight. Do not use abrasive cloths or tissues on the Mobile Hawk window — abrasive cloths or tissues may scratch the window.

Appendix E — Troubleshooting

Problem: No Data Output.

When the trigger is pulled, the unit beeps and then triple-beeps, but does not output data.

Error Messages (String Output): None.

Possible Cause: Mobile Hawk is not connected (USB or Serial) to the PC.

Solution:

1. Check to make sure the PC supports “High Power Devices” (self-powered hubs, some laptops, etc.). Right-click on **My Computer** in the Windows **Start** menu, select **Properties**, click the **Device Manager** button on the **Hardware** tab, expand the **Universal Serial Bus controllers** menu item, right-click on **USB Root Hub**, select **Properties**, and then select the **Power** tab.

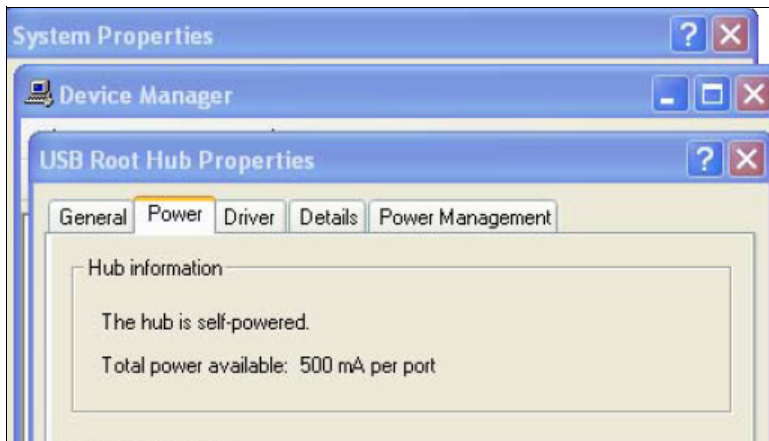

2. Make sure the PC is not allowed to power down the device. Follow the same path described above, but select the **Power Management** tab instead of the **Power** tab.

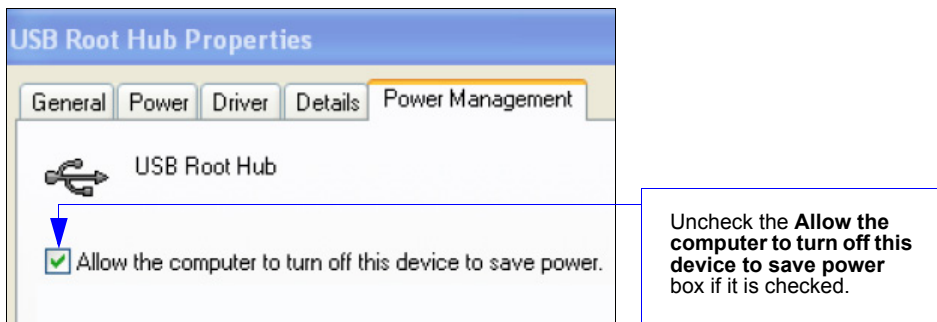

Problem: No Illumination – License Key Failed.

The unit is unable to decode, and it is not cycling through its illumination settings. (Targeting, if enabled, does appear when the trigger is pulled.)

Error Messages (String Output): “License Key Failed”

Possible Cause: The Mobile Hawk license has been deleted.

Solution: Request license file (2019_(serial number).crb) from Microscan customer support. Unit serial number and license must match.

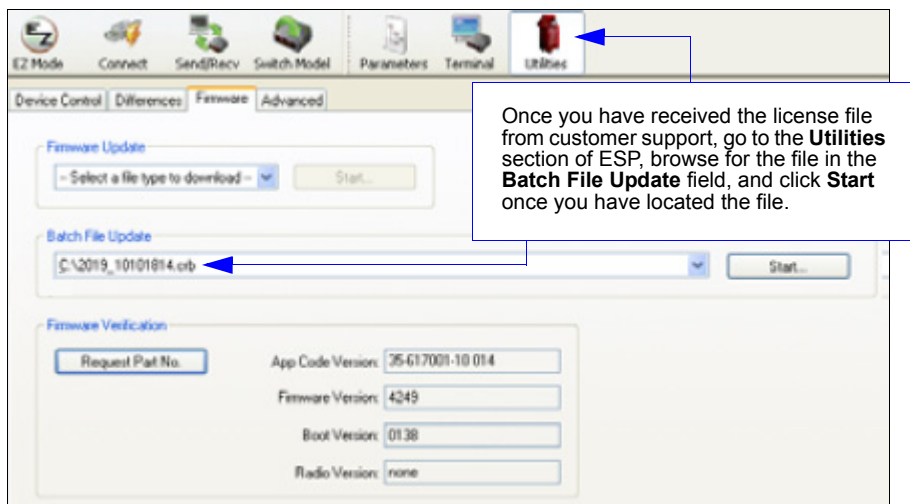

Problem: No Illumination – No Process Sequence Defined.

The unit is unable to decode, and it is not cycling through its illumination settings. (Targeting, if enabled, does appear when the trigger is pulled.)

Error Messages (String Output): “No Process Sequence Defined; Please Set the Unit to Default Settings”

Possible Cause: No illumination sequence has been defined for the Mobile Hawk.

Solution: Reset the default illumination sequence.

