

**MICROSCAN<sup>®</sup>**

*MS-710 Scanner  
User's Manual*



P/N 83-000700 REV I

## **Copyright © 2000**

by Microscan Systems, Inc.,  
1201 S.W. 7th Street, Renton, Washington, U.S.A. 98055  
(425) 226-5700 FAX: (425) 226-8682  
ISO 9001/Certification No. US96/0465

All rights reserved. The information contained herein is proprietary and is provided solely for the purpose of allowing customers to operate and/or service Microscan manufactured equipment and is not to be released, reproduced, or used for any other purpose without written permission of Microscan.

Throughout this manual, trademarked names might be used. Rather than put a trademark (™) symbol in every occurrence of a trademarked name, we state herein that we are using the names only in an editorial fashion, and to the benefit of the trademark owner, with no intention of infringement.

## **Warranty Information**

Microscan Systems, Inc. warrants products manufactured by it to be free from defects in material or workmanship under normal use and service for a period of one year from date of shipment.

This warranty is specifically limited to the replacement or repair of any such warrantable defects, without charge, when the complete product is returned to Microscan Systems, Inc., freight prepaid, at the address shown above. Contact the factory at the address above for a Return Material Authorization (RMA) number before returning the product.

Microscan Systems, Inc. shall be the sole judge of the warrantability of alleged product defects. Products that are returned for warranty examination and that are found to be non-warrantable are chargeable and are returned freight collect. A copy of a purchase order with the amount of the charge must be received by Microscan, either by mail or by FAX, before any equipment is returned. Warrantable products are repaired or replaced at no charge and returned freight prepaid.

THIS EXPRESS WARRANTY EXCLUDES ALL OTHER WARRANTIES, EXPRESS OR IMPLIED, INCLUDING, BUT NOT LIMITED TO, IMPLIED WARRANTIES OF MERCHANTABILITY AND FITNESS FOR PURPOSE. MICROSCAN SYSTEMS, INC., SHALL NOT BE LIABLE FOR WARRANTY IN ANY AMOUNT EXCEEDING THE PURCHASE PRICE OF THE GOODS. MICROSCAN SYSTEMS, INC., SHALL NOT BE LIABLE FOR ANY SPECIAL, INCIDENTAL, OR CONSEQUENTIAL DAMAGES, WHETHER IN CONTRACT, TORT, OR OTHERWISE.

The buyer acknowledges that he/she is not relying on the seller's skill or judgment to select or furnish goods suitable for any particular purpose and that there are no warranties that extend beyond the description on the face hereof.

This warranty extends only to the original purchaser, and shall not apply to any products or parts that have been subject to misuse, neglect, accident, or abnormal conditions or operations. Claims for damage in transit are directed to the freight carrier upon receipt.

## **Disclaimer**

The information and specifications described in this manual are subject to change without notice.

For the latest version of this manual, see the Download page on our web site at [www.microscan.com](http://www.microscan.com). For technical support email [helpdesk@microscan.com](mailto:helpdesk@microscan.com).

# Table of Contents

Table of Contents .....	iii
List of Illustrations .....	v
List of Tables .....	vi
About the MS-710 Scanner .....	vii
About This Manual .....	vii
Keystroke Entries .....	vii
Approvals .....	vii
Warning and Caution Summary .....	viii
Safety Labels .....	ix
Zulassungen .....	x
Sicherheitshinweis und Vorsichtsmaßnahmen .....	x
Achtung/Warnung: .....	xi
<b>Chapter 1 Setup and Installation</b>	
Step 1 - Plan Scanning System .....	1-2
Step 2 - Attach Cabling .....	1-3
Step 3 - Consider Read Range and Scan Width .....	1-4
Step 4 - Position Scanner .....	1-5
Step 5 - Mount Scanner .....	1-6
Step 6 - Establish Communications .....	1-7
Step 7 - Configure Scanner .....	1-8
Step 8 - Test Decode Rate with Static Label .....	1-9
Step 9 - Test Decode Rate with Moving Label .....	1-10
Step 10 - Increase the Number of Scans .....	1-11
<b>Chapter 2 Menu Configuration</b>	
About the Menu Configuration Program .....	2-2
Communications Menu .....	2-5
Protocol Menu .....	2-12
Operation Menu.....	2-16
Code Type Menu.....	2-25
Output Menu .....	2-32
Setup Menu .....	2-38
<b>Chapter 3 Serial Configuration</b>	
About Serial Configuration .....	3-3
Communications Port Commands .....	3-5
Protocol Commands .....	3-6
Operations Commands .....	3-10
Code Types Commands .....	3-13
Scanner Output Commands .....	3-15
Scanner Setup Commands .....	3-18

## Chapter 4 Operational Commands

Read Rate .....	4-3
Trigger.....	4-5
Scanner .....	4-6
Counters .....	4-7
Master Label .....	4-9
Reset.....	4-11
Checksum .....	4-13
Code Type Commands .....	4-15

## Appendices

Appendix A — Scanner Specifications .....	A-2
Appendix B — Electrical Specifications .....	A-5
Appendix C — ASCII Table .....	A-7
Appendix D — Orientation .....	A-8
Appendix E — Defaulting the Scanner .....	A-10
Appendix F — Number of Scans .....	A-11
Appendix G — Troubleshooting .....	A-14
Appendix H — Using the IB-105 .....	A-18
Appendix I — MS-Sensor .....	A-24
Appendix J — Bar Code Symbology .....	A-27
Appendix K — Interface Standards .....	A-28
Appendix L — Multidrop Communications .....	A-29
Appendix M — Glossary of Terms .....	A-32

Index	I-1
-------	-----

# List of Illustrations

Figure 1-1 Typical Setup (without IB-105)	1-2
Figure 1-2 Auxiliary Port Setup	1-2
Figure 1-3 Daisy Chain Setup	1-2
Figure 1-4 DTE Host Connection	1-3
Figure 1-5 MS-710 External 15-pin Connector	1-3
Figure 1-6 Read Range and Width	1-4
Figure 1-7 Tilt, Skew, and Pitch Axes	1-5
Figure 1-8 MS-710 Mounting Dimensions	1-6
Figure 2-1 Configuration Program - Main Menu	2-2
Figure 2-2 Communications Menu Structure	2-5
Figure 2-3 Protocol	2-12
Figure 2-4 Operation Menu Structure	2-16
Figure 2-5 External Level Trigger Signals	2-17
Figure 2-6 External Edge Trigger Signals	2-18
Figure 2-7 Match Code Type	2-22
Figure 2-8 Code Types Menu Structure	2-25
Figure 2-1 Symbology Identifier Option Values	2-25
Figure 2-2 Scanner Output Menu Structure	2-32
Figure 2-3 Setup Menu Structure	2-38
Figure A-1 MS-710 Dimensions	A-2
Figure A-2 Low Density and High Density Scan Range/Width Graph	A-3
Figure A-3 Right-angle Down Scan Range/Width Graph	A-3
Figure A-4 Grounding Diagram, Scanner-Host	A-6
Figure A-5 Ladder Orientation	A-8
Figure A-6 Picket Fence Orientation	A-8
Figure A-7 Angled Picket Fence Orientation	A-9
Figure A-8 Detector Orientation	A-9
Figure A-9 Ladder Orientation	A-11
Figure A-10 Picket Fence Orientation	A-11
Figure A-12 Label Dimensions	A-12
Figure A-11 Angled Picket Fence Orientation	A-12
Figure A-13 Front of IB-105	A-18
Figure A-14 Back of IB-105	A-18
Figure A-15 MS-sensor Range	A-25
Figure A-16 MS-sensor Flowchart	A-26

## List of Tables

Table 1-1 Read Ranges and Scan Widths .....	1-3
Table 1-2 RS-232 15-pin External Cable Connections .....	1-6
Table 1-3 RS-422/485 External 15-pin Cable Connections .....	1-6
Table 2-1 Symbology Identifier Option Values .....	2-31
Table 3-1 Summary of Serial Configuration Commands .....	3-2
Table 3-2 Protocol Commands .....	3-7
Table 4-1 Summary of Operational Commands.....	4-2
Table 4-2 Hex Value to Binary Conversion .....	4-7
Table 4-3 Finding Scanner Status from Binary Bit Digits .....	4-7
Table A-1 External 15-pin 12-conductor Cable Connections.....	A-3
Table A-2 Range Data .....	A-4
Table A-3 ASCII Table with Control Characters .....	A-5
Table A-4 Troubleshooting .....	A-9
Table A-5 6-pin Trigger Connector .....	A-13
Table A-6 15-pin Scanner Connector .....	A-13
Table A-7 5-pin Power Connector .....	A-13
Table A-8 25-pin D-sub Host Connector .....	A-13
Table A-9 6-pin LAN (RJ11) Connector .....	A-14
Table A-10 IB-105 Options .....	A-14
Table A-11 Multidrop Address Characters .....	A-23

## *About the MS-710 Scanner*

The MS-710 is a programmable, fixed-mount, high-speed scanner that reads and decodes a wide variety of bar code labels using a 10-sided spinning mirror to project laser beams over a wide scan angle.

## *About This Manual*

This manual provides complete information on setting up and installing the MS-710 scanner.

Chapter 1 provides overall step-by-step instructions for setting up and installing the MS-710 scanner with specific “go to” references to other chapters and appendices.

Chapter 2 provides instructions for configuring the MS-710 scanner by menu.

Chapter 3 provides instructions for configuring the MS-710 scanner by serial command.

Chapter 4 describes serial operational commands that can be used by the host.

For specifications, see appendix A. The appendices also include reference tables, as well as other useful information relating to bar coding and the MS-710 scanner.

## *Keystroke Entries*

Keystrokes to be entered from your terminal are highlighted, as in **<P>**.

Serial commands and operational commands start with a **<** left angle bracket and are followed by a **>** right angle bracket.

## *Approvals*

This equipment is approved for use by the following organizations:

- CDRH (Center for Devices & Radiological Health)
- UL (Underwriters Laboratories, Inc.)
- cUL (UL mark for Canada)
- TÜV (Technischer Überwachungs-Verein)
- FCC (Federal Communication Commission)
- CE Compliant

## Warning and Caution Summary

For connection to a UL Listed direct plug-in power unit marked Class II and rated at 5 VDC at 2 amps or greater.

European Models must use a similarly rated Class I or Class II power supply that is certified to comply with the standard for Safety EN 60950.

This equipment has been tested and found to comply with the limits for a Class B digital device, pursuant to part 15 of the FCC Rules. These limits are designed to provide reasonable protection against harmful interference in a residential installation. This equipment generates, uses, and can radiate radio frequency energy, and, if not installed and used in accordance with the instructions, may cause harmful interference to radio communications. However, there is no guarantee that interference will not occur in a particular installation. If this equipment does cause harmful interference to radio or television reception, which can be determined by turning the equipment off and on, the user is encouraged to try to correct the interference by one or more of the following measures:

- Reorient or relocate the receiving antenna
- Increase the separation between the equipment and receiver
- Connect the equipment into an outlet on a circuit different from that to which the receiver is connected
- Consult the dealer or an experienced radio/TV technician for help



### **WARNING**

*Use of controls, adjustments, or performance of procedures other than those specified herein may result in hazardous laser light radiation exposure.*



### **WARNING**

*There are no user serviceable parts in the MS-710 scanner. Opening the scan head voids the Microscan Systems warranty and could expose the user to laser diode power of up to 5 mW.*



### **WARNING**

*The laser beam can be harmful to eyesight. Avoid eye contact with the laser beam. Never point the beam at other people, or in a direction where people may be passing.*



## Safety Labels

These Class II labels are located on the MS-710 scanner.

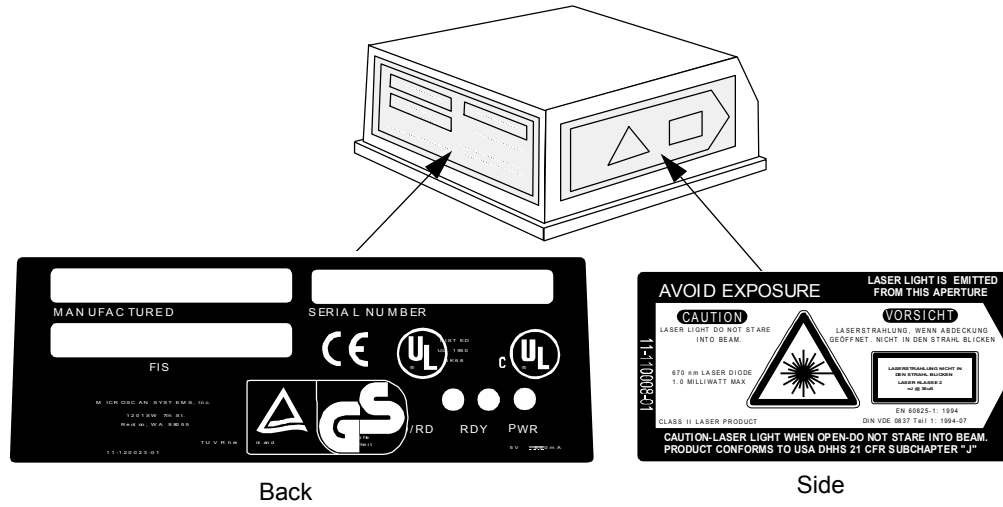

## Zulassungen



Dieses Gerät wurde für die Zulassung durch die folgenden Organisationen und in Übereinstimmung mit deren Normen entwickelt:

CDRH (Center for Devices & Radiological Health; Zentrum für Geräte und Strahlenschutz)

UL (Underwriters Laboratories, Inc.)

cUL (kanadisches UL-Zeichen)

TüV (Technischer Überwachungsverein)

FCC (Federal Communication Commission; Kommunikationsausschuß der USA)

CE konform

## Sicherheitshinweis und Vorsichtsmaßnahmen

Dieses Gerät wurde geprüft und entspricht den Grenzwerten für ein digitales Gerät der Klasse A gemäß Teil 15 der FCC-Richtlinien. Diese Grenzwerte bieten ausreichenden Schutz vor schädlichen Störungen bei einer Installation in Wohnräumen. Dieses Gerät kann Hochfrequenzstrahlung erzeugen, verwenden und abgeben. Wenn es nicht den Anleitungen entsprechend installiert und verwendet wird, kann es zu Funkstörungen kommen. Es gibt jedoch keine Garantie, daß bei bestimmten Installationen keine Störungen auftreten. Sie können feststellen, ob dieses Gerät den Funk- oder Fernsehempfang beeinträchtigt, indem Sie es ein- und ausschalten. Versuchen Sie in diesem Fall, die Störung mit Hilfe einer der folgenden Methoden zu beheben:

- Richten Sie die Empfangsantenne anders aus, oder wählen Sie einen anderen Standort.
- Erhöhen Sie den Abstand zwischen diesem Gerät und dem Empfangsgerät.
- Schließen Sie dieses Gerät an eine Steckdose eines anderen Stromkreises als dem des Empfangsgerätes an.
- Setzen Sie sich mit dem Händler oder einem erfahrenen Funk- und Fernsehtechniker in Verbindung.

Dieses Gerät darf nur an eine VDE geprüfte Spannungsversorgung 5V  $\overline{\text{---}}$  angeschlossen werden. Die SELV Spannungsversorgung muß mindestens 2 A.

Modelle für den europäischen Markt müssen eine entsprechende Stromversorgung der Klasse I oder II verwenden, die nach der Sicherheitsrichtlinie EN 60950 zertifiziert ist.

## Achtung/Warnung:



### **WARNUNG**

*Die Verwendung von Steuerelementen, Anpassungen oder das Ausführen von Prozeduren, die von den hier beschriebenen abweichen, kann dazu führen, daß Sie gefährlichen Laserstrahlen ausgesetzt werden.*



### **WARNUNG**

*Der Scanner MS-710 enthält keine Teile, die durch den Benutzer gewartet werden können. Durch Öffnen des Abtastkopfes wird die Gewährleistung von Microscan Systems nichtig. Außerdem können Sie einer Laserdiodenleistung von bis zu 5 mW ausgesetzt werden.*



### **WARNUNG**

*Der Laserstrahl kann Ihre Augen schädigen. Vermeiden Sie direkten Blickkontakt mit dem Laserstrahl. Richten Sie den Strahl niemals auf anwesende Personen oder dorthin, wo möglicherweise Personen vorbei kommen könnten.*



# Chapter 1

# Quick Start

1-Quick Start

## Chapter Contents

Step 1 - Plan Scanning System .....	1-2
Step 2 - Attach Cabling .....	1-3
Step 3 - Consider Read Range and Scan Width .....	1-4
Step 4 - Position Scanner .....	1-5
Step 5 - Mount Scanner .....	1-6
Step 6 - Establish Communications .....	1-7
Step 7 - Configure Scanner .....	1-8
Step 8 - Test Decode Rate with Static Label .....	1-9
Step 9 - Test Decode Rate with Moving Label .....	1-10
Step 10 - Increase the Number of Scans .....	1-11

This chapter provides step-by-step instructions for setting up and installing the MS-710 scanner.

**Note:** Bar code labels should meet minimum ANSI (American National Standards Institute) standards as specified in ANSI Bar Code Print Quality Guideline, X3.182-1990.

# Step 1 Plan Scanning System

Before installing the MS-710 scanner you should sketch out a diagram of your scanning system, showing equipment, connector and cable types, and cable lengths. (For wiring information, see "Attach Cabling" on page 1-3.)

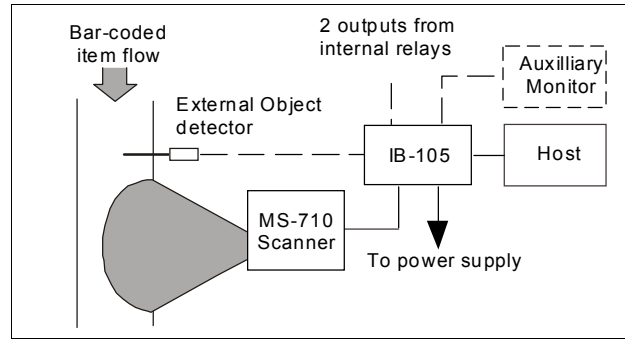

Figure 1-1 Typical Setup (without IB-105)

Figure 1-1 shows a typical scanning system setup without an IB-105. Figure 1-2 shows a system with an IB-105 and an auxiliary monitor (via aux port). (See also "Using the IB-105" on page A-18.)

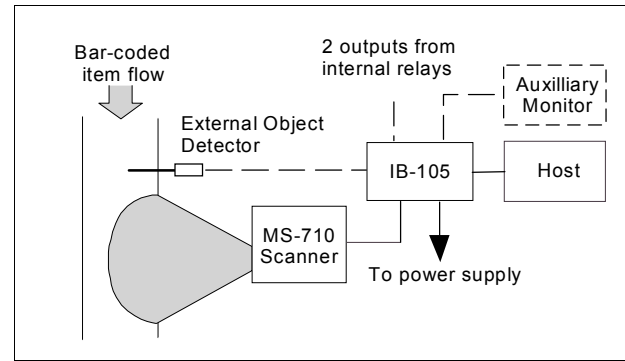

Figure 1-2 Auxiliary Port Setup

Figure 1-3 shows an IB-105 with two additional MS-710 scanners connected via the IB-105 as a "Daisy Chain" application.

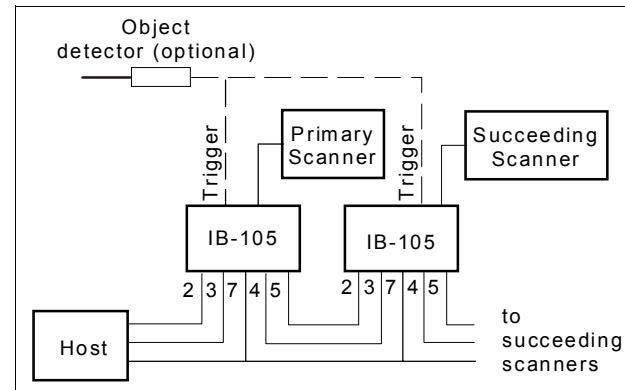

Figure 1-3 Daisy Chain Setup

## Step 2 Attach Cabling

The MS-710 has a 15-pin internal connector with a standard, hard-wired 3-foot cable terminating in an external 15-pin connector. Since +5 VDC power supply is included in the single cabling assembly, the scanner cable should not exceed 3 feet. RS-232 cabling from the 15-pin connector to the host can be up to 47 feet provided it does not include 5 VDC input.

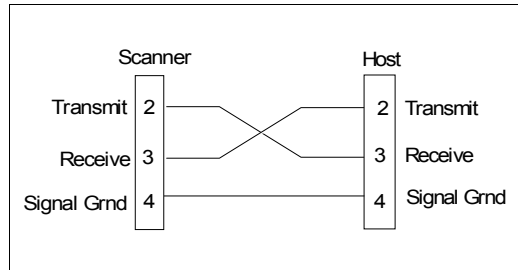

Figure 1-4 DTE Host Connection

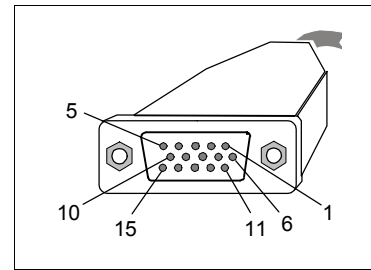

Figure 1-5 MS-710 External 15-pin Connector

**Note:** Pinouts are shown in Appendix B — “Electrical Specifications” on page A-5. Connections between the MS-710 and the IB-105 (P/N 99-420001) are shown in Appendix H on page A-18.

## Step 3 Consider Read Range and Scan Width

- a) Verify that the labels to be scanned will pass through the readable range. Optimum decode rates can be expected at the center of the depth of field (halfway between minimum and maximum read range) for a given bar code density.
- b) Note the approximate scan width at the specific distance the labels will be passing through.

**Read range** is the distance from the scanner in which a passing label can be read. For the MS-710, read range varies from 2 to 10 inches (high density model) depending on label density and optical version of scanner.

**Scan width** is that distance across the scan arc in which a label can be read. For a moving label, the closer to the scanner, the shorter the time it will be within the scan width, and hence the fewer scans it will receive.

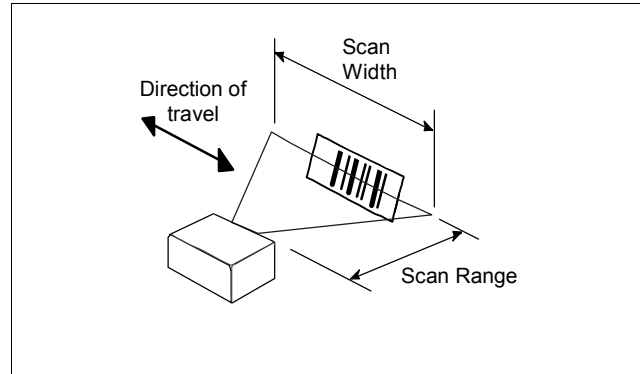

Figure 1-6 Read Range and Width

**Note:** See Table A-1, "Range Data," on page A-3.



## Step 4 Position Scanner

- a) Position the scanner in a place devoid of sunlight, bright lights, or laser light from other sources.
- b) Avoid excessive tilt, skew, or pitch. Maximum tilt is determined by label characteristics and the number of scans required. Maximum skew is  $\pm 40^\circ$ ; maximum pitch is  $\pm 50^\circ$ .<sup>1</sup>
- c) Pitch label slightly to avoid specular reflection, the return of direct, non-diffused light. For the MS-710 raster scanner, specular reflection is avoided by pitching labels at least  $5^\circ$  plus or minus from a line perpendicular to the mirror.<sup>2</sup>

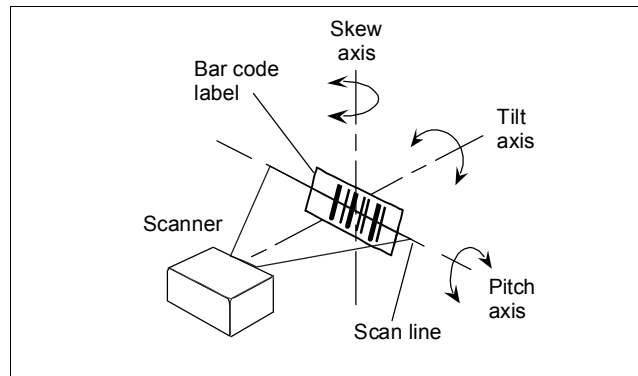

Figure 1-7 Tilt, Skew, and Pitch Axes

**Note:** Another way to avoid specular reflection is to skew the scanner slightly in relation to the label.

For more information, see Appendix D on page A-8.

1. Maximum tilt is determined by label characteristics and number of scans required.
2. The specular reflection zone is a narrow zone straight out from the scanner in which direct reflected light from a label can distort the scanner's ability to distinguish bars from spaces.

## Step 5 Mount Scanner

The MS-710 scanner can be top or bottom mounted depending on your model type.

Use the measurements provided in figure 1-8 to locate centers of mounting holes and drill as specified:

*Top mount* – drill two 0.16 inch (4.06 mm) diameter holes.

*Bottom mount* – drill two 0.203 inch (5.16 mm) diameter holes.

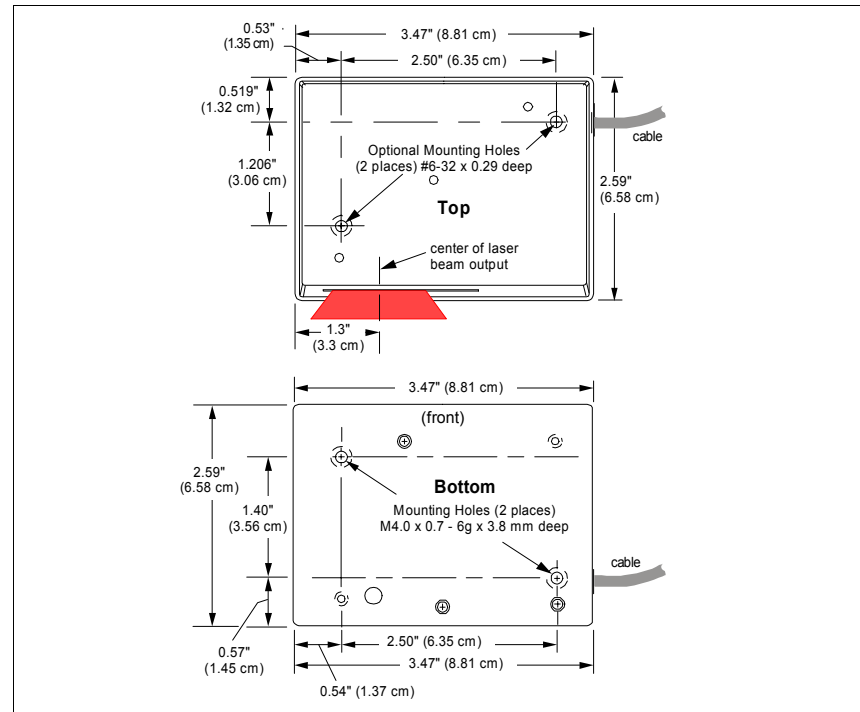



Figure 1-8 MS-710 Mounting Dimensions

**Caution:** Maximum penetration depth of screws is 0.29 inch (7.37 mm) for top mount or 0.15 inch (3.81 mm) for bottom mount.

**Caution:** To prevent twisting or distortion of the scanner housing, ensure that the mounting surface or bracket is flat.

## Step 6 Establish Communications

To set up the host communications, from the ESP™ main menu:

- Select Serial Port and Configure from the pull-down menus.
- Make the port selection from Serial Port options COM 1 through COM 8. (Usually COM 2 for desktops and COM 1 for laptops.)
- Click the **Auto Baud** button  or select **Auto Baud** from **Serial Port** pull down menu.

ESP will cycle through the various baud, etc. combinations until communications are established (look for the CONNECTED banner on your screen) or the cycle is completed without connecting and a DISCONNECTED banner appears on your screen. You can also interrupt the search by clicking the Stop button.

Allow some time for the auto baud routine to test most of the combinations. You can watch this at the bottom of the dialog box. Once it has found it, it will change the host's settings to match the scanner's.

The default settings for the MS-710 scanner are **9600** baud, **Even** Parity, **7** Data Bits, and **1** Stop Bits.

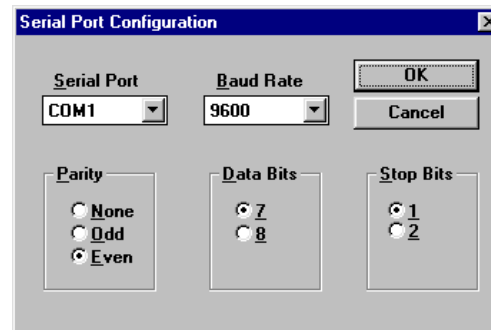

## Step 7 Configure Scanner

You can make changes from the default settings by modifying individual ESP menus and saving those changes to the scanner.

For explanations of menu configuration settings, see Chapter 2, "Menu Configuration."

**Note:** When you save communications changes to the scanner, serial port settings are automatically matched.

**Note:** You can check the scanner's settings at any time by clicking **SEND/RCV** and **RECEIVE FROM SCANNER** to receive the scanner's current settings into ESP.

As data is being received a blue bar will fill across the bottom of the dialog box.

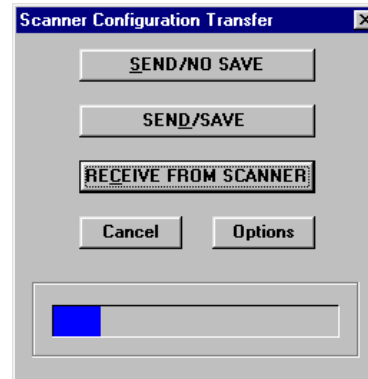

## Step 8 Test Decode Rate with Static Label

- a) Position the label in front of a functioning scanner, click on the **Utilities** button, and in the Read Rate dialog either click the **Percent** or **Decodes/Sec** radio button and click **Start**, or enter the **<Cp>** or **<C>** command from the host terminal to launch test.
- b) Observe rate. (The percent or decode rate is added to the front of the data string.)
- c) End the test by clicking the **Stop** button or the **<J>** command.

**Note:** If, after making adjustments, you have changed the read range or another parameter used in the number of scans formula, you should recalculate the number of scans (see "Number of Scans" on page A-11).

**Note:** Variations between labels are common. For this reason, the greater number of sample labels you test, the more likely you are to achieve optimum decode rates.

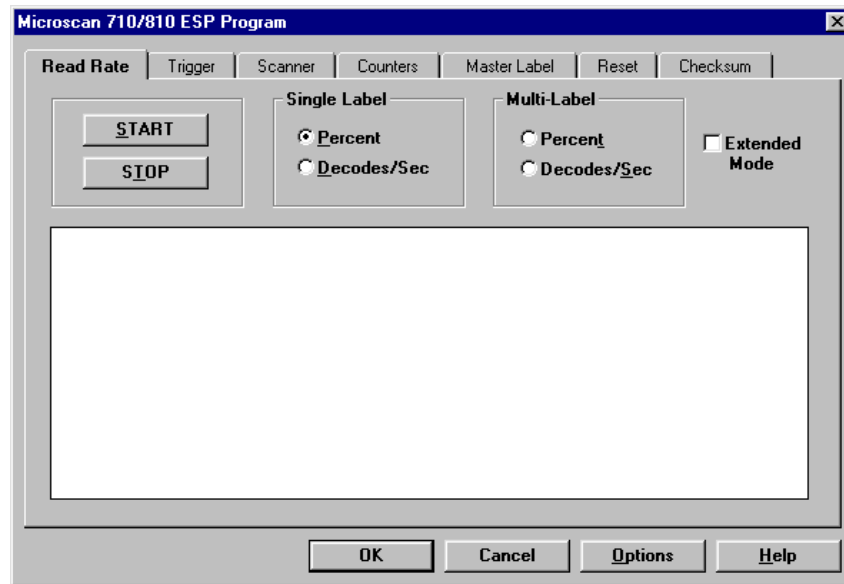

## Step 9 *Test Decode Rate with Moving Label*

Once you've mounted the scanner and established a good read rate with a stationary label, you can repeat the test with a moving label.

To ensure reliable scanning, you need to apply a minimum of **five scans** to each label. This means that all variables, label speed, read range, etc. are significant.

To calculate in advance the number of scans that the label will receive, use the formulas described in Appendix F, "Number of Scans," on page A-11.

---

## Step 10 *Increase the Number of Scans*

Where possible, you can increase the number of scans a label receives by:

- Increasing label height
- Decreasing label length
- Increasing scan rate (spinning mirror speed)
- Slowing label speed

See Appendix F, "Number of Scans," on page A-11.





*Chapter*  
**2**

# *Menu Configuration*

## *Chapter Contents*

About the Menu Configuration Program .....	2-2
Communications Menu .....	2-5
Protocol Menu .....	2-12
Operation Menu .....	2-16
Code Type Menu .....	2-25
Output Menu .....	2-32
Setup Menu .....	2-38

With Microscan's ESP™ (Easy Setup Program) configuration changes can be made in the ESP menus and sent and saved to your scanner. You can also send serial commands to the scanner via the ESP's Terminal window.

ESP can receive configuration settings from a scanner and post these in the Current Menu Settings window.

Multiple configuration settings can be saved to host computer can later be recalled and loaded into any MS-710 scanner.

# About the Menu Configuration Program

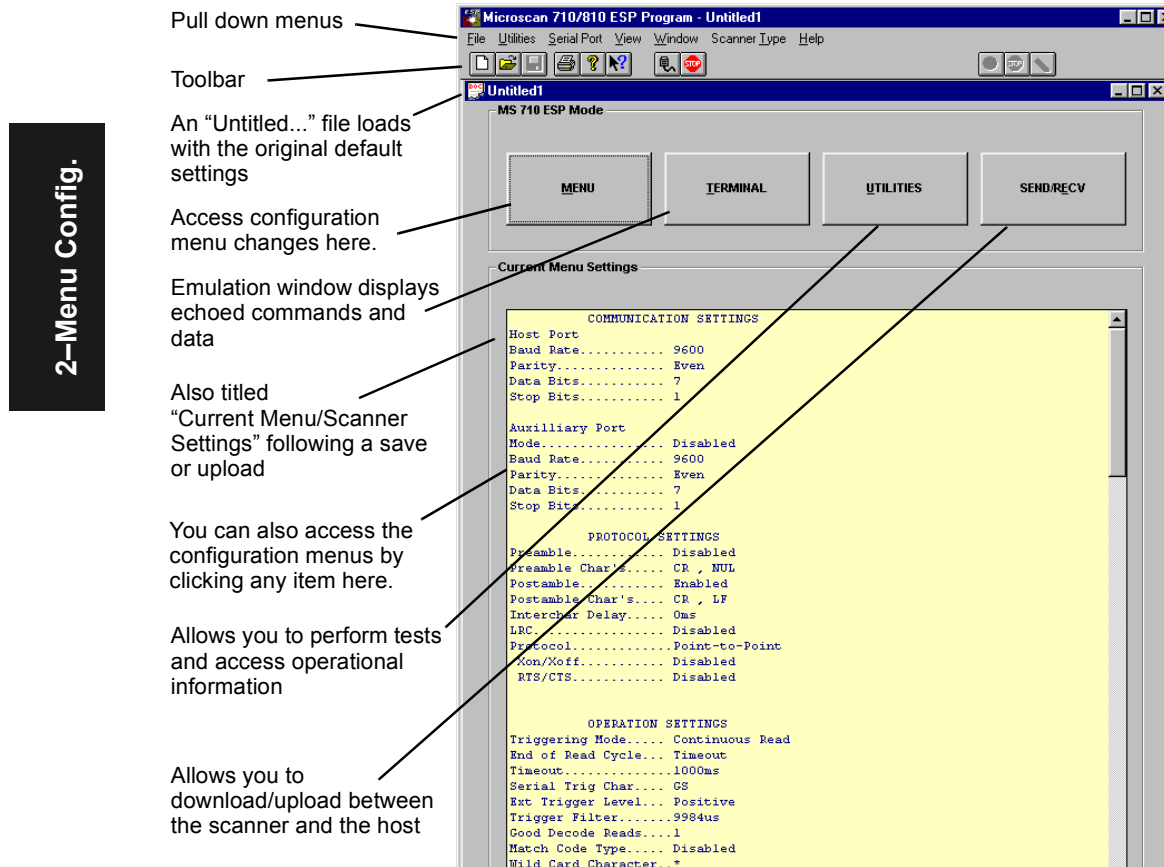

Figure 2-1 Configuration Program - Main Menu

## Using ESP to Configure the Scanner

This is the window you will see when you launch the Easy Setup Program.

To access the configuration menus, click on the **MENU** button.

If using a mouse, single click on menu items and enter text as appropriate. If using the keyboard, use the Alt key plus underlined letters and the tab key to move to the desired field, use arrow keys or the space bar to scroll through selections, and the **Enter** key to accept changes.

## Saving Settings to the Scanner

You can access the **SEND/RECV** box by clicking it directly from the Current Settings window, or from within any of the configuration menus, click **Apply**. To save changes to the scanner, select **Apply** in the menu pages. (Clicking **OK** on these menu pages will only update the items in the Current Settings window.) From within the SEND/RECV box, click **SEND/NO SAVE** to initialize, send data, and reset counters only, or **SEND/SAVE** to initialize, reset counters, and save these settings to the scanner's nonvolatile memory.

### Receiving Settings from the Scanner

To update Current Settings in ESP, click **SEND/RECV** and then **RECEIVE FROM SCANNER**.

**Note:** If receiving scan data and you are in Continuous Read, labels being scanned may interfere with your data request.

### Saving Settings to the Host Computer

When saving a file by selecting **SAVE AS** (or **SAVE**) from the File pull-down menu, the settings are saved only on the computer's hard drive or other storage medium. This is particularly useful for saving special sets of settings that you may want to recall later and use for a different application.

### Creating a New Configuration File

To create a new file of configuration settings, first be sure you've saved the current configuration file to the computer's hard drive or other storage device. Next pull down the File menu in the ESP and select **New**. A new Untitled window will open with a listing of the default settings. Change these settings to suit your requirements and save this file to the computer's hard drive under a new name. These settings can also be downloaded to the scanner at any time under a name of your choice.

### Restoring Default Settings

**Note:** Be certain that you've saved any other configuration files to the host computer that you may want to reload later.

To restore defaults for individual menus in ESP, click the **DEFAULT** button on the specific menu. To save those settings to the scanner, click **Apply**.

To restore defaults to the scanner (for ALL menus), click the **DEFAULT** button on the Interface tab of the Utilities menu, or send an **<Ad>** serial command. You can also default by hardware command.

### Loss of Communications

Making changes to communications parameters such as Baud Rate, Parity, Stop Bits, LRC, etc. without corresponding changes in linked device(s) can result in the loss of menu access. If this should occur, try ESP **Auto Baud** command or restore defaults.

**Caution:** Defaulting the scanner will reset all standard configuration parameters except Scanner Type, Scans per Second, and Gain Adjustment to their original default values.

**Note:** Power must be available to the scanner during the default procedure.

# Communications Menu

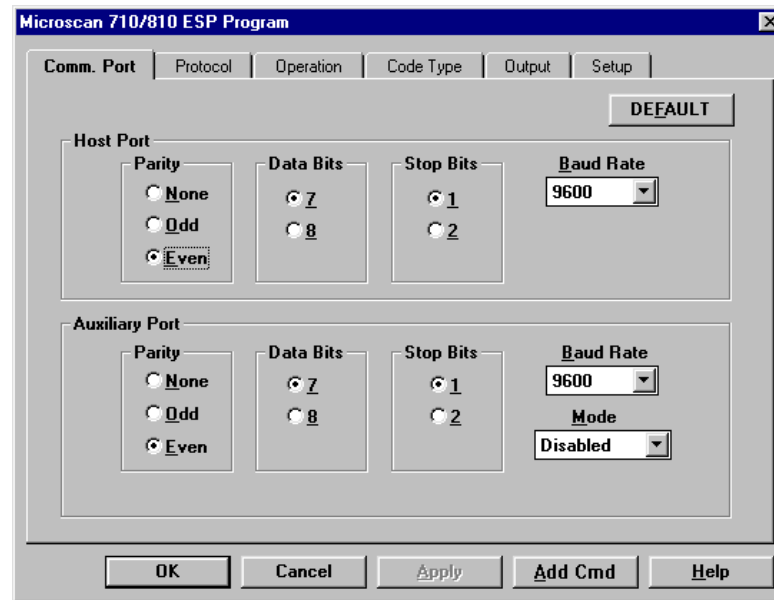

2-Menu Config.

Figure 2-2 Communications Menu Structure

## Default

Clicking the **DEFAULT** button will reset all parameters on the current menu to defaults. This does not take effect until it is saved to the scanner with the **SEND/NO SAVE** or **SEND/SAVE** buttons.

**Note:** When you make and save menu communications changes to the scanner, those changes will automatically be matched in the Serial Port pull-down options.

## Host Port

**Note:** Changes in Communications parameters or assigning an address to the scanner can cause loss of communications with the configuration terminal when you exit the menu program (whether or not changes are saved for power-on).

### Baud Rate

*Default:* **9600**

*Options:* 300, 600, 1200, 2400, 4800, 9600, 19.2K, and 38.4K

Allows you to set the number of bits transmitted per second.

### Parity

*Default:* **Even**

*Options:* Even, Odd, None

Allows you to select an error detection routine in which one data bit in each character is set to 1 or 0 so that the total number of 1 bits in the data field is even or odd.

### Stop Bits

*Default:* **One**

*Options:* One, Two

Allows you to select the last one or two bits in each character to indicate the end of the character.

### Data Bits

*Default:* **Seven**

*Options:* Seven, Eight

Allows you to establish the total number of bits in each character.

## Aux Port Parameters

Options for Baud Rate, Parity, Stop Bits, and Data Bits are identical to the host port parameters on [page 2-5](#) and are changed in the same manner.

### Mode

*Default:* **Disabled**

*Options:* Disabled, Transparent, Half Duplex, Full Duplex, and Daisy Chain

**Note:** Aux Port is only available through Microscan's IB-105.

Allows you to set communications parameters between the scanner and an auxiliary port. An auxiliary port can be used to configure the menus, send data to the host, and display data transmissions originating from the host or scanner.

**Note:** Aux Port cannot be used in conjunction with RS-485 or RTS/CTS on the host port.

**Note:** The Aux Port baud rate should never exceed Host Port baud rate or auxiliary port data could be lost.

**Transparent**

Used to batch data from the aux port to the host. The scanner buffers data from the aux port and displays the keyed data on the aux port. The scanner transmits aux port data to the host when a label is scanned or a carriage return is entered from the aux port.

**Data Initiated from the Aux Port**

- Aux Port data is passed through to the host whenever a return key is pressed at the aux port or whenever bar code data is sent. If sent with bar code data, it is processed on a first-in/first-out basis.
- Aux Port data to the host is always sent with a preamble and a postamble.
- If the scanner is in a polled mode to the host, aux port data will still pass through.
- A **<D>** command is the only command accepted by the scanner from the aux port. All other commands will pass through to the host.

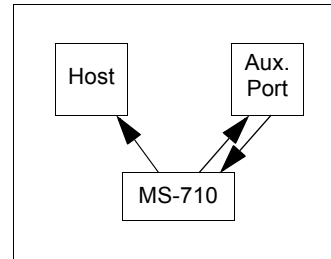

2-Menu Config.

**Data initiated from the Scanner**

- Transmission to the aux port occurs immediately upon a good read.
- Scan data to the aux port does not include a preamble or a postamble.
- Communications with the aux port is always in Point-to-Point protocol, even if the host is in a polled protocol mode.

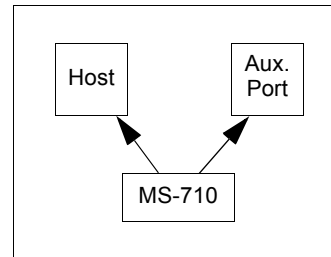

**Data initiated from the Host**

- In polled mode, data echoed from the host to the aux port must be in the format **<B \_\_\_\_>** (e.g., to send the word "LUNCH" to the aux port, it must be sent in the format **<BLUNCH>**).
- In unpolled mode, all host data is echoed to the aux port.

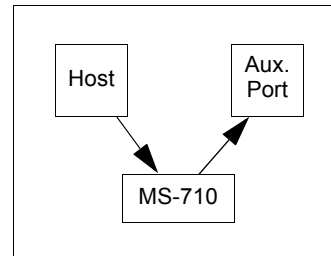

### Half Duplex Mode

In half duplex mode all aux port data and bar code data is sent directly to the host. Bar code data is displayed on the aux port screen at the same time the data is sent to the host.

#### Data initiated from the Aux Port

- Aux Port data to the host is ignored if the scanner is in a polled mode.
- Aux Port data or scanned data is sent to the host whenever it is received.
- Aux Port data is not echoed.
- Aux Port data to the host is always sent without a preamble or a postamble.
- **<D>** is the only command that is accepted by the scanner from the aux port. All other commands are passed through to the host.

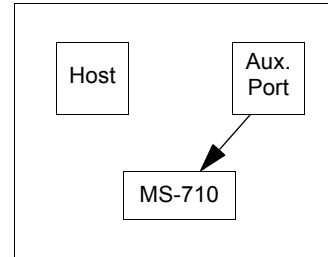

#### Data initiated from the Scanner

- Scan data is transmitted to the aux port at the same time it is transmitted to the host.
- Data transmission conforms with all parameters specified in the configuration menu (e.g., Preamble, Postamble, End of Read Cycle).

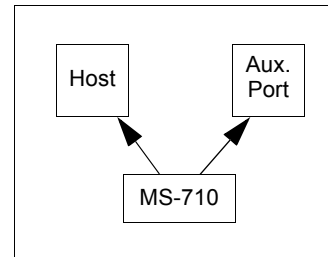

#### Data is initiated from the Host

- In polled mode, data echoed from the host to the aux port must be in the format **<B\_\_\_\_>** (i.e.: to send the word "LUNCH" to the terminal, it must be sent in the format **<BLUNCH>**).
- In unpolled mode, all host data is echoed to the aux port.

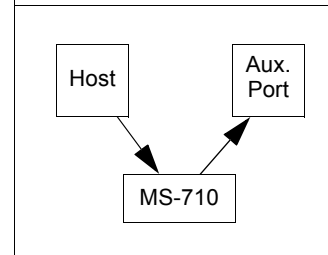



**Full Duplex Mode**

In full duplex mode, all aux port data and bar code data is sent directly to the host. Bar code data is not displayed on the aux port screen.

**Data initiated from the Aux Port**

- Aux port data is passed directly through to the host whenever it is received by the scanner, unless the scanner is in a polled mode, in which case the data will be ignored.
- Aux Port data is not echoed.
- Aux Port data to the host will not have a preamble or a postamble.
- A **<D>** command is the only command accepted by the scanner from the aux port. All other commands will pass through to the host.

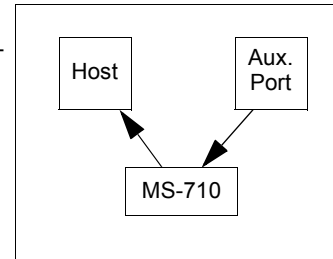

**Data initiated from the Scanner**

- Scan data is not sent to the aux port.

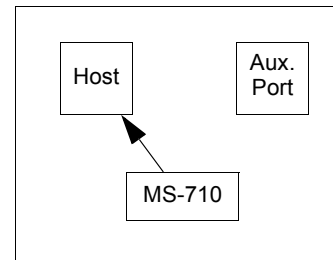

**Data initiated from the Host**

- In polled mode, data echoed from the host to the aux port must be in the format **<B\_\_\_\_>** (for example, to send the word "LUNCH" to the terminal, it must be sent in the format **<BLUNCH>**).
- In unpolled mode, all host data is echoed to the aux port.

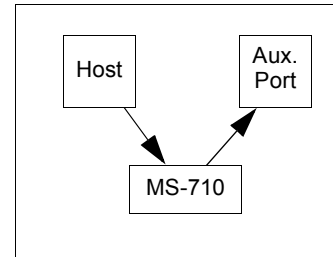

2-Menu Config.

### Daisy Chain Mode

In a daisy chain application, a primary scanner is linked directly to the host and succeeding scanners are linked in tandem. The source of transmitted data can be identified by enabling and assigning daisy chain IDs to each scanner.

Just before sending a noread message, the primary scanner checks its auxiliary port for data. It waits a maximum of 20 ms. If no character is received in 20 ms, it sends a noread message to the host. If a complete message is received, it is sent to the host instead of the noread message. If for example the primary scanner were set to timeout in 100 ms, the first succeeding scanner could be set to 90 ms, the next to 80 ms, etc., thus assuring that a minimum of 20 ms elapses between transmissions.

Daisy-chained scanners can send a series of labels by enabling Multilabel and a common multilabel separator. If the primary scanner does not receive the expected number of labels, noread messages are appended to the data string to make up the difference between the number of labels enabled in Multilabel (b) and the number of labels read.

For example, a primary and two succeeding scanners have Number of Labels set to 3 and Multilabel Separator defined as %. If the primary and the first succeeding scanner do not find labels, but the next succeeding scanner registers a good read, the transmitted results would be: *label data % noread % noread*.

The conditions for a daisy chain application are as follows:

1. The primary scanner's trigger can be serial or external; the succeeding scanners are automatically serially triggered.
2. All scanners are enabled to Daisy Chain mode.
3. Each scanner's *Aux* port must have its Send and Receive connected to the *Host* port of its succeeding scanner.
4. Each succeeding scanner in the daisy chain must be set to send its data *no less* than 20 ms before its preceding scanner.
5. All but the primary scanner must have Postamble set to CR (^M) and enabled.
6. All but the primary scanner must have their noread messages disabled.
7. If Multilabel is enabled, Multilabel Separator characters and Number of Labels must match in all scanners in the daisy chain.
8. Symbology ID enable/disable must be the same in all scanners.

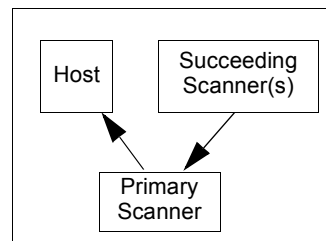

**Daisy Chain ID Status**

Default: **Disabled**

Options: Disabled, Enabled.

**Daisy Chain ID**

Default: **1/**

Options: Any one or two ASCII characters.

Each scanner enabled for Daisy Chain can be assigned a one or two character Daisy Chain ID that appears in front of the data decoded by that scanner. Enable/Disable and Length must be the same in all scanners.

2-Menu Config.

## Protocol Menu

Protocols define the sequence and format in which information is transferred between devices.

2-Menu Config.

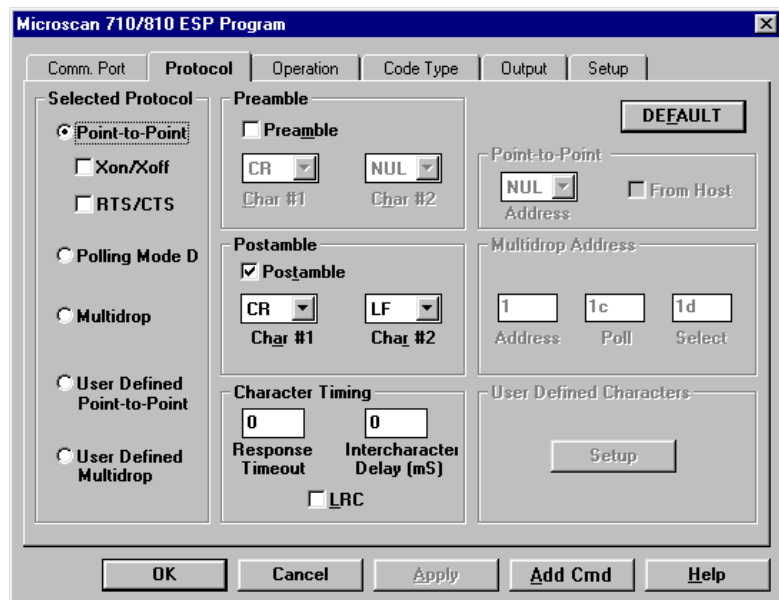

Figure 2-3 Protocol

### Default

Clicking the **DEFAULT** button will reset all parameters on the current menu to defaults. This does not take effect until it is saved to the scanner with the **SEND/NO SAVE** or **SEND/SAVE** buttons.

### Selected Protocol

*Default:* **Point-to-Point**

*Options:* *Point-to-Point, Point-to-Point with XON/XOFF, Point-to-Point with RTS/CTS, Point-to-Point with RTS/CTS & XON/XOFF, Polling Mode D, Multidrop, User Defined, User Defined Multidrop Protocol*

### Point-to-Point

Has no address and sends data to the host (RS-232) whenever it is available and without any request or handshake from the host.

### Point-to-Point with RTS/CTS (Request-to-Send/Clear-to-Send)

Used only with RS-232. This is a simple handshaking protocol that allows a device to initiate data transfers to the host with an RTS (request-to-send) transmission. The

host, when ready, responds with a CTS (clear-to-send) and the data is transmitted. CTS and RTS signals are transmitted over two dedicated wires (pins 6 and 10) as defined in the RS-232 standard.

#### *Point-to-Point with XON/XOFF (Transmitter On/Off)*

Used only with RS-232. This selection enables the host to send a single byte XON or XOFF transmission command of start (^Q) or stop (^S). If an XOFF has been received from the host, data will not be sent to the host until the host sends an XON. During the XOFF phase, the host is free to carry on other chores and accept data from other devices.

#### *Point-to-Point with RTS/CTS & XON/XOFF*

Used only with RS-232. It is a combination of Point-to-Point with RTS/CTS and Point-to-Point with XON/XOFF.

#### *Polling Mode D*

Like Point-to-Point, Polling Mode D requires a separate connection to the host; but unlike Point-to-Point, it requires an address and must wait for a poll from the host before sending data. When in Polling Mode D, an address of 1 is automatically displayed on the configuration screen. However, during transmission, a 1C hex poll address (FS) and a 1D hex select address (GS) are substituted for the 1.

#### *Multidrop*

**Note:** Scanners intended to link up to a Microscan MS-5000 multidrop concentrator must be configured in standard Multidrop protocol.

Similar to Polling Mode D except that a unique poll address and select address are required for each multidrop device, and only one host port connection is needed for up to 50 devices. (For Multidrop poll and select characters, see [Table A-12, "Multidrop Address Characters," on page A-31.](#))

Requires a concentrator or controller using RS-485 communications. When Multidrop is selected, the protocol characters for RES, REQ, etc. are assigned automatically. (See ["Appendix L – Multidrop Communications" on page A-29](#) for poll and select sequences.)

#### *User Defined*

**Note:** A specific ASCII character must not be assigned more than once.

Used only with RS-232. User Defined is necessary when a new protocol must be defined to match a specific host protocol. ASCII characters can be assigned as an address and as protocol commands (RES, REQ, EOT, STX, ETX, ACK, NAK, From Host). In order to enable a handshaking protocol, you must manually assign values where necessary. When User Defined is selected, the displayed protocol commands match those of the previously selected protocol. User Defined is considered to be in a polled mode only if an address has been assigned. The address can be any ASCII character from the ASCII table in [Appendix C](#). If null is selected as the address, the scanner will not function in a polling sequence. From Host, if enabled, allows the handshaking protocol to be initiated from the host, if unpolled.

## Chapter 2

### From Host

*Default:* **Disabled**

*Options:* *Disabled, Enabled*

Messages sent to the host from the MS-810 will always include the scanner's defined protocol. The status of From Host determines if messages sent to the MS-810 from the host must also include the defined protocol. If From Host is disabled, the defined protocol is not included. If From Host is enabled, the defined protocol must be included. (See **"Explanation of the From Host option,"** on page 3-7 for further information.)

### Multidrop Addresses

No two scanners in the Multidrop Network can have the same address.

Each scanner in the network must have an address (from 01 to 50) assigned in its configuration program.

Each address has its own separate poll and select address (from 1C to 7F hex).

For example, during a polling sequence, Scanner 03 expects a 20 hex ("SP" ASCII poll character) from the concentrator. And during a select command, it looks for a select value 21 hex ("!" ASCII select character).

### User Defined Multidrop

Used when connecting to a concentrator or other device that does not match standard Multidrop protocol.

Any single character (02 hex to 7E hex) in the ASCII table can be assigned as the address character. The character chosen is used as the poll character and the subsequent ASCII character becomes the select character. For example, if a ^B (02 hex) is selected as the address, ^C (03 hex) becomes the select address that the host will use in sending host select commands. (See **Table A-12, "Multidrop Address Characters,"** on page A-31.)

**Note:** Definitions of commands in User Defined and User Defined Multidrop must be duplicated in host applications to enable poll and select sequences to execute correctly during transmission.

**Note:** Typically, parameters in User Defined Multidrop are defined by first enabling Multidrop, then enabling User Defined Multidrop. This pre-loads Multidrop characters into the parameters. You then change individual characters to match the host or other requirements.

### Preamble

*Default:* **^M** (and a null). Corresponds to <CR><NUL> (carriage return/null) displayed in the menu.

*Options:* *Any ASCII character, including control characters.*

Allows you to define a one or two character data string that can be added to the front of the decoded data.

**Preamble (enable/disable)**

*Default:* **Disabled**

*Options:* Disabled, Enabled (within any protocol)

Allows you to enable or disable the preamble character(s).

**Postamble**

*Default:* **^M^J**

*Options:* Any ASCII character, including control characters.

Allows you to define a one or two character data string that can be added after the decoded message. For example, defining the Postamble as a carriage return and line feed would result in the display of each decoded message on its own line.

**Postamble (enable/disable)**

*Default:* **Enabled**

*Options:* Enabled, Disabled (within any protocol)

Allows you to enable or disable the Postamble character(s).

**LRC (Longitudinal Redundancy Check)**

*Default:* **Disabled**

*Options:* Disabled, Enabled

An error-checking routine that verifies the accuracy of transmissions. It is the exclusive OR of all characters following the SOM (start of message) up to and including the EOM (end of message). What this means is that the binary representation of all the characters in a transmissions are cumulatively added in a column and each resulting odd integer is assigned a 1 and each even integer a 0 (two 1s = 0, two 0s = 0, a 1 and a 0 = 1). This extra LRC character is then appended to the transmission and the receiver (usually the host) performs the same addition and compares the results.

**Response Timeout**

*Default:* **12 ms**

*Options:* 0 to 65,000 ms. A zero (0) setting causes an indefinite wait.

Allows you to set the time the scanner will wait before timing out if ACK, NAK, and ETX are enabled, and a host response is expected.

**Intercharacter Delay**

*Default:* **0**. Corresponds to 0 ms displayed in the menu.

*Options:* 0 to 255. Zero (0) causes no delay between characters.

Allows you to set the time interval in milliseconds between individual characters transmitted from the scanner to the host. A high setting will significantly slow down communications. For example, a 200 setting will result in a 1/5 second delay between each character that is transmitted.

# Operation Menu

2-Menu Config.

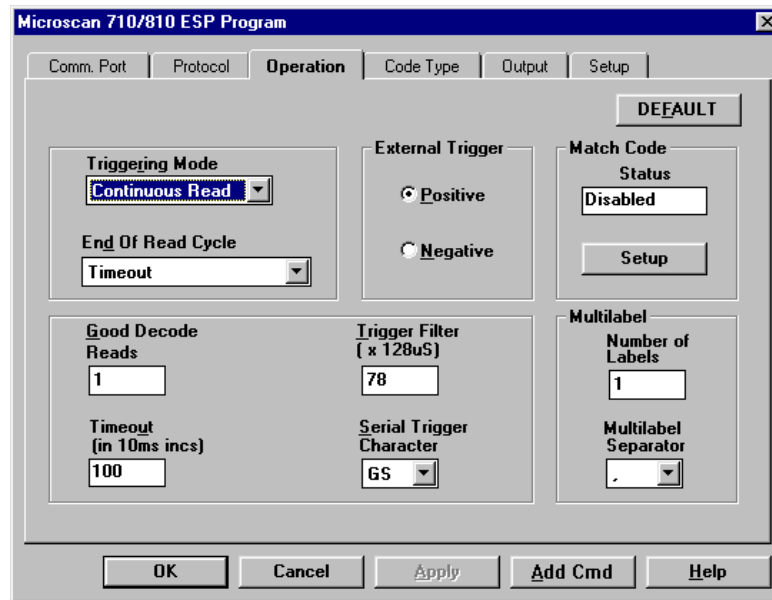

Figure 2-4 Operation Menu Structure

## Default

Clicking the **DEFAULT** button will reset all parameters on the current menu to defaults. This does not take effect until it is saved to the scanner with the **SEND/NO SAVE** or **SEND/SAVE** buttons.

## Triggering Mode

*Default:* **Continuous Read**

*Options:* *Continuous Read, Continuous Read 1 Output, External Level, External Edge, Serial Data, Serial Data & External Edge*

Allows you to establish the type of trigger event that will initiate or end the read cycle. (See **"End of Read Cycle" on page 2-18.**)

### Continuous Read

**Note:** If both Continuous Read and Match Code are enabled the scanner defaults to Continuous Read 1 Output mode.

Trigger input options are disabled and the scanner is always in the read cycle. Barcode data is decoded, and label information is transmitted repeatedly, as long as the



label is in the read range of the scanner. When To Output options have no affect on Continuous Read. Continuous Read is useful in testing label or scanner functions.

**Continuous Read 1 Output**

**Note:** Enabling Continuous Read 1 Output when Number of Labels (page 2-21) is set to any number greater than one will cause Number of Labels to default back to one.

Label data is immediately transmitted once every time new label data is placed in front of the scanner. With Timeout enabled for End Of Read Cycle, if the label doesn't change, the scanner will repeat the output at the end of each subsequent timeout period. For example, if Timeout were set to one second, the scanner would output the label data immediately, and then repeat the output at intervals of one second, for as long as the label continued to be scanned.

With Timeout disabled (that is, End Of Read Cycle set to New Trigger), the scanner will output the current label data immediately, but output it only once. A new label appearing at any time in the scan range will produce a new read output as long as the new label is not identical to the previous label.

**External Level<sup>1</sup>**

Allows a read cycle to be initiated by a trigger signal from an object detector when an object appears within the detector's range. The read cycle exists as long as the detector "sees" the object and does not end until the object moves out of the detector's range even if a good read or timeout occur sooner (figure 2-5).

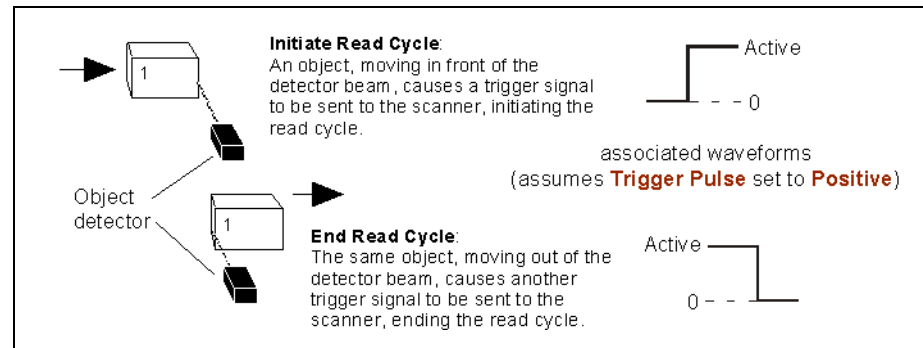

Figure 2-5 External Level Trigger Signals

1. *Level* and *Edge* apply to the active logic state (positive or negative) that exists while the object is in a read cycle, between the rising edge and falling edge. *Rising edge* is the trigger signal associated with the appearance of an object. *Falling edge* is the trigger signal associated with the subsequent disappearance of the object.

### External Edge

As with Level, Edge allows a read cycle to be initiated by a trigger signal from an object detector when it detects the appearance of an object (rising edge). But unlike Level mode, the removal of an object (falling edge) does not end the read cycle. With Edge enabled, the read cycle ends with a good read output, a timeout, or a new trigger (figure 2-6 on page 2-18).

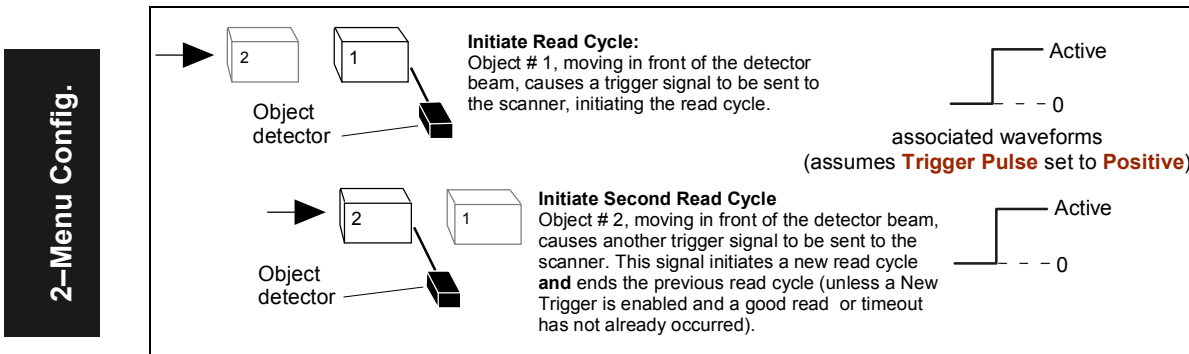

Figure 2-6 External Edge Trigger Signals

### Serial Data

The scanner accepts an ASCII character from the host or controlling device as a trigger to start a read cycle. Serial data trigger behaves the same as External Edge.

### Serial Data & External Edge

The scanner accepts either an external trigger or a serial ASCII command to start a read cycle.

### End of Read Cycle

**Default:** **Timeout**

**Options:** *Timeout, New Trigger, Timeout & New Trigger*

Allows you to choose the circumstances that will end the read cycle. The read cycle is the time during which the scanner will receive and process label data. When the Triggering Mode option is set in an External or Serial mode of operation, the trigger event initiates the read cycle.

**Note:** When operating in Continuous Read or Continuous Read 1 Output, the scanner is always in the read cycle.

### *Timeout*

Can end the read cycle after a specified period of time, and if no label has been read, causes a noread message, if enabled, to be transmitted.

With either External Edge, Serial Data, or Serial Data & Edge enabled, a timeout ends the read cycle.

With External Level enabled, the read cycle does not end until the falling edge trigger occurs, and the next read cycle does not begin until the next rising edge trigger.

With Continuous Read 1 Output enabled, a timeout initiates a new read cycle and allows the same label to be read again.

### *New Trigger*

Ends the read cycle at the occurrence of a new trigger event, and if no label has been read, causes a noread message, if enabled, to be transmitted at the occurrence of the new trigger event.

With either External Edge, Serial Data, or Serial Data & Edge enabled, and edge or serial trigger ends a read cycle and initiates the next read cycle. With External Level enabled, a falling edge trigger ends a read cycle, However, the next read cycle does not begin until the occurrence of the next rising edge trigger.

### *Timeout & New Trigger*

Ends the read cycle after a specified period of time or at the occurrence of a new trigger event, and if no label has been read, causes a noread message, if enabled, to be transmitted.

With either External Edge, Serial Data, or Serial Data & Edge enabled, a timeout, or an edge or serial trigger, whichever comes first, ends the read cycle.

With External Level enabled, the read cycle does not end until the occurrence of a falling edge, and the next read cycle does not begin until the next rising edge trigger.

### **Timeout (in 10 ms incs)**

*Default:* **100** (one second). Corresponds to 1000 ms displayed in the menu.

*Options:* 0 to 65535. Divide the number to be entered by 100 for time in seconds.

**Note:** Timeout or Timeout & New Trigger under End of Read Cycle ([page 2-19](#)) must be enabled for Timeout (in 10 ms incs) to take effect.

Allows you to define the duration of the timeout period.

### Serial Trigger Character

*Default:* **^]**. Corresponds to <GS> displayed in the menu.

*Options:* Any single ASCII character, including control characters, except NUL (00H), an existing host command character,<sup>1</sup> or an on-line protocol character.

**Note:** Serial Data ([page 2-18](#)) or Serial Data & Edge ([page 2-18](#)) must be enabled for Serial Trigger Character to take effect. "N/A" is displayed in the menu when all other triggering modes are enabled.

Allows you to define a single ASCII character as the host serial trigger character that initiates the read cycle. The serial trigger is considered an on-line host command and requires the same command format as all host commands (that is, to be entered within the < > brackets).

### External Trigger Polarity

*Default:* **Positive**

*Options:* Positive, Negative

**Note:** External Level ([page 2-17](#)), External Edge ([page 2-18](#)), or Serial Data & Edge ([page 2-18](#)) must be enabled for External Trigger Level to take effect. "N/A" is displayed in the menu when all other triggering modes are enabled.

Allows you to determine whether a positive or negative transition will initiate the read cycle.

**Note:** If using the Microscan object detector (P/N 99-440001-03), use positive trigger polarity.

### Trigger Filter

*Default:* **78** (approximately 10 ms). Corresponds to 9984  $\mu$ s displayed in the menu.

*Options:* 2 to 255 (approximately 0.256 ms to 32 ms in 0.128 ms increments). Multiply the number to be entered by 128 for time in microseconds, then divide by 1000 for time in milliseconds.

Allows you to set a trigger bounce filter duration.

1. For example, assigning an upper case D would nullify the <D> (Enter Menu Configuration) command. For a list of operational commands used by the scanner, see Chapter 4, "Operational Commands."

### Good Decode Reads

*Default:* **1**

*Options:* 1 to 31

Allows you to select the number of good reads (from 1 to 31) required per label before a good decode output.

**Note:** Be sure to set the value within the determined scan rate for the scanning setup so that the scanner is capable of scanning a label the required number of times.

### New Master Pin

*Default:* **Disabled**

*Options:* Disabled, Enabled

**Note:** Match Code Type ([page 2-22](#)) and a triggered mode ([page 2-16](#)) must be set for Enabled or Sequential for New Master Pin to take effect.

Allows you to momentarily connect pin 12 to ground in order to clear any existing master label information from memory and allows the next label to be read as the new master label information.

### Number of Labels

*Default:* **1**

*Options:* 1 to 6

**Note:** If Number of Labels is set to any number greater than one while Match Code Type or Continuous Read 1 Output is enabled, Number of Labels will default back to one.

**Note:** If using Supplementals option for UPC, see "[Supplementals](#)," on [page 2-29](#) for specific directions on defining Number of Labels.

Allows you to choose the number of different labels that can be read in a single trigger event. The following conditions apply:

1. Each label must be different to be read.
2. The maximum number of characters in any one label is 64.
3. The maximum number of characters in a single scan line is 384.
4. The maximum number of characters for all labels is 384, including preamble, postamble, and all spaces and commas.
5. All noread messages are posted at the end of the data string.
6. If more than one label is within the scan beam at the same time, label data may not be displayed in the order of appearance.

### Multilabel Separator

Default: **, (comma)**

Options: Any available ASCII character, except NUL.

Allows you to choose the separator character to be inserted between each label.

**Note:** UPC separator character, if used, must be different than the multilabel separator.

### Match Code Type

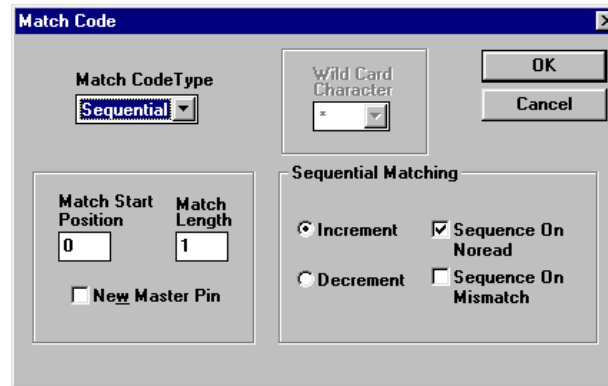

Figure 2-7 Match Code Type

Default: **Disabled**

Options: Disabled, Enabled, Wild Card, and Sequential

When not disabled, allows you to enter a master label into the scanner's RAM to be compared with subsequently scanned labels. The results of this comparison determine the scanner's data and relay outputs, if enabled.

The following conditions apply:

1. A triggered mode ([page 2-16](#) to [page 2-18](#)) must be enabled for Match Code Type to take effect.
2. Not disabling Match Code Type when Number of Labels is set to any number greater than one will cause Number of Labels to default back to one.
3. If you wish to send a pulse on a Good Read, Match Code Type must be disabled (see ["Output On" on page 2-33](#)).

#### Disabled

Disabled has no effect on operations.

#### Enabled

Instructs the scanner to compare labels or portions of labels with the master label.

### Sequential

Instructs the scanner to compare labels or portions of labels for sequential numbers in ascending or descending order.

There are four ways to load a master (see **“Master Label Entry” on page 2-24**). In every case sequencing occurs after each match. See **“Match Code Type” on page 3-11** for special noread and mismatch sequences.

### Wild Card

Allows you to enter user defined wild card characters in the master label.

For example, with wild card defined as the default asterisk, entering URGENT\*\* as your master label will result in matches for URGENT, URGENT1, and URGENT12 but not for URGENT123.

As in the above example, when wild cards are appended to the end of the master label, labels of variable lengths can result in matches. However, wild cards in the beginning or center of a label (e.g., UR\*\*NT) do not allow for variable label lengths.

### Matchcode Master

*Default:* **(blank)**

*Options:* *Displays current master and accepts user entry up to 64 characters.*

Allows you to edit an existing master or type in a new master label from your keyboard.

### Sequential Matching

*Default:* **Increment**

*Options:* *Increment, Decrement*

Defines the order (ascending or descending) in which labels will be compared when Match Code Type is set to Sequential.

### Match Start Position

*Default:* **0**

*Options:* *0 to 64*

Match Start Position must be set to 1 or greater to enable this feature.

Defines the first character in the label (from left to right) that will be compared with those of the master label when Match Code Type is set to Enabled or Sequential. For example, if you set Match Start Position to 3, the first 2 characters read in the label will be ignored and only the 3rd and subsequent characters to the right will be compared, up to the number of characters specified by Match Length.

### Match Length

*Default:* **1**

*Options:* 1 to 31

Defines the length of the character string that will be compared with that of the master label when Match Code Type is set to Enabled or Sequential and Match Start position is set to 1 or greater. For example, If Match Length is set to 6 in a 10 character label, and Match Start Position is set for 2, only the 2nd through 7th characters (from left to right) will be compared.

### Wild Card Character

*Default:* \* (asterisk)

*Options:* Any ASCII character

Allows you to define the wild card character that can be used when defining a master label.

#### **Master Label Entry**

With Match Code Type set to Enabled, Sequential, or Wild Card, a master label can be entered in four ways:

1. By typing in master label data in the Utilities menu.
2. With New Master Pin enabled (see [page 2-21](#)), toggling scanner pin 12 to ground (or by momentarily pressing the New Master button on the IB-105) will save the next label read as the master label.
3. Sending serial command <G> allows the next label read to be the master label.
4. Sending a serial command in the format < )XXXX )> downloads data as the master label.



# Code Type Menu

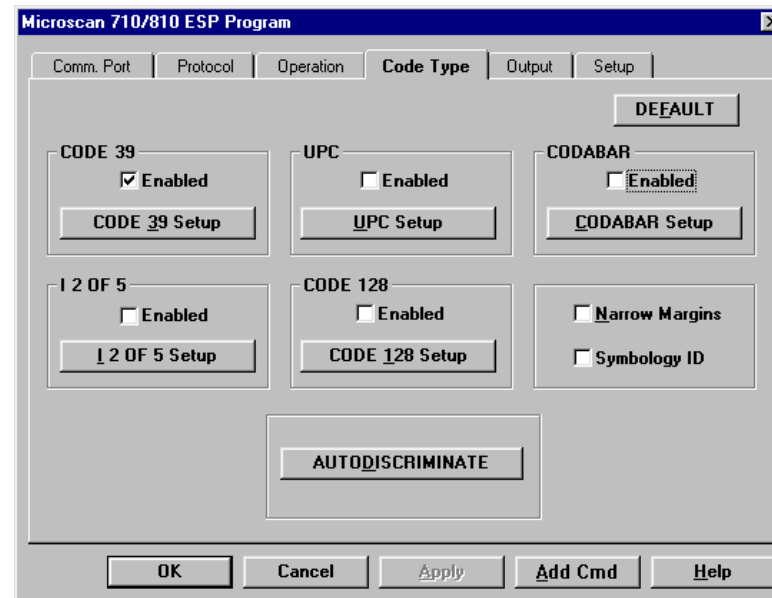

2-Menu Config.

Figure 2-8 Code Types Menu Structure

## Default

Clicking the **DEFAULT** button will reset all parameters on the current menu to defaults. This does not take effect until it is saved to the scanner with the **SEND/NO SAVE** or **SEND/SAVE** buttons.

## Code 39

Default: **Enabled**

Options: *Enabled, Disabled*

## Check Digit

Default: **Disabled**

Options: *Disabled, Enabled*

Code 39 is self-checking and does not normally require a check digit. However, for additional data integrity, a Modulus 43 check digit can be added to the bar code message. With Check Digit and an External or Serial trigger option enabled (see **“Triggering Mode” on page 2-16**), an invalid check digit calculation will cause a noread message to be transmitted at the end of the read cycle.

### Check Digit Output

Default: **Disabled**

Options: *Disabled, Enabled*

When enabled, the check digit character is sent along with the label data. When disabled, label data is sent without the check digit.

### Large Intercharacter Gap

Default: **Disabled**

Options: *Disabled, Enabled*

Allows the scanner to read labels with gaps between bar code characters exceeding three times the narrow element width.

### Fixed Code Length

Default: **Disabled**

Options: *Disabled, Enabled*

Used to increase data integrity by ensuring that only one label length will be accepted.

### Code Length

Default: **10**

Options: *1 to 64*

**Note:** Fixed Code Length must be enabled for Code Length to take effect.

Allows you to specify the exact number of characters that the scanner will recognize (this does not include start and stop). The scanner will ignore any code not having the specified length.

### Codabar

Default: **Disabled**

Options: *Disabled, Enabled*

### Start & Stop Match

Default: **Enabled**

Options: *Enabled, Disabled*

Requires the Codabar start and stop characters (a, b, c, or d) to match before a valid read can occur.

### Start & Stop Output

*Default:* **Enabled**

*Options:* Enabled, Disabled

Allows the start and stop characters to be transmitted with bar code data.

### Large Intercharacter Gap

*Default:* **Disabled**

*Options:* Disabled, Enabled

Allows the scanner to read labels with gaps between bar code characters exceeding three times the narrow element width.

### Fixed Code Length

*Default:* **Disabled**

*Options:* Disabled, Enabled

Used to increase data integrity by ensuring that only label length will be accepted.

### Code Length

*Default:* **10**

*Options:* 1 to 64

**Note:** Fixed Code Length must be enabled for Code Length to take effect.

Allows you to specify the exact number of characters that the scanner will recognize. The scanner will ignore any code not having the specified length.

**Note:** Setting Code Length to any number less than 4 will produce undetermined results.

### Check Digit

*Default:* **Disabled**

*Options:* Disabled, Modulus 16, NW 7, Both

Allows you to select the type of checksum system Codabar will use.

### Check Digit Output

*Default:* **Disabled**

*Options:* Disabled, Enabled

When enabled, the check digit character is sent along with the label data. When disabled, label data is sent without the check digit.

## Interleaved 2 of 5

*Default:* **Disabled**

*Options:* Disabled, Enabled

Because I 2 of 5 is a continuous code, it is prone to substitution errors. Hence, a code length must be defined and a bar code label containing an even number of digits must be used. It is also recommended that a Modulus 10 check digit be used to ensure the best possible data integrity.

### Check Digit

*Default:* **Disabled**

*Options:* Disabled, Enabled

I 2 of 5 uses a Modulus 10 check digit.

### Check Digit Output

*Default:* **Disabled**

*Options:* Disabled, Enabled

When enabled, the check digit character is sent along with the label data. When disabled, label data is sent without the check digit.

### Code Length #1

*Default:* **10**

*Options:* 0 to 64, even. If you enter an odd number the scanner will use the next lower number.

With I 2 of 5, two code lengths can be defined. When using only one label length in an application, we recommend setting Code Length #2 to 0 to ensure data integrity. If a check digit is used, it must be included in the code length count.

### Code Length #2

*Default:* **6**

*Options:* 0 to 64, even. (If you enter an odd number the scanner will use the next lower number.)

If using a second label, you may also specify a zero or any even code length from 2 to 30. If not using a second label, set Code Length #2 to 0 to ensure data integrity.

## UPC

*Default:* **Disabled**

*Options:* Disabled, Enabled

When enabled, the scanner will read UPC version A and UPC version E only.

## EAN

*Default:* **Disabled**

*Options:* Disabled, Enabled

**Note:** UPC must be enabled for EAN to take effect.

When EAN is enabled, the scanner will read UPC version A, UPC version E, EAN 13, and EAN 8. It will also append a leading zero to UPC version A label information and transmit 13 digits. If you do not want to transmit 13 digits when reading UPC version A labels, disable EAN.

## Supplementals

*Default:* **Disabled**

*Options:* Disabled, Enabled, Required

Allows the scanner to read supplemental bar code data that has been appended to the standard UPC or EAN codes.

### *Enabled*

When Supplementals is set to Enabled, the UPC main and supplemental label are considered to be separate labels. Therefore Number of Labels must be set to 2 and a multilabel separator will be inserted between the label data and the supplemental label data.

For example, if Supplementals is enabled, Number of Labels is set to 2, and the Multilabel Separator Character is defined as a #, the data will be displayed as: LABEL # SUPPLEMENTAL

If you are using two labels with Supplementals, set Number of Labels to 4.

**Note:** Under no circumstances will a supplemental label be output without a main label.

**Note:** Do not set Triggering Mode ([page 2-16](#)) to Continuous Read 1 Output. Enabling Continuous Read 1 Output will cause Number of Labels to default to 1.

### *Required*

When set to Required, the UPC main and supplemental labels are considered to be one label. If either the main or supplemental label is not read, a single noread message will be output.

For example, if Supplementals is set to Required, Separator is enabled, and an asterisk is defined as the Separator Character, then the data will be displayed as: LABEL \* SUPPLEMENTAL.

If set to disabled, the following will be displayed: LABEL SUPPLEMENTAL.

---

## Chapter 2

**Note:** If additional labels—other than the main or supplemental—will be read in the same read cycle, Number of Labels should be set accordingly.

### Separator

*Default:* **Disabled**

*Options:* Disabled, Enabled

Allows you to insert a character between the standard UPC or EAN code and the supplemental code when Supplementals is set to Required.

### Separator (character)

*Default:* , (comma)

*Options:* Any ASCII character.

Allows you to change the separator character from a comma to a new value.

## Code 128

*Default:* **Disabled**

*Options:* Disabled, Enabled

### Fixed Code Length

*Default:* **Disabled**

*Options:* Disabled, Enabled

Allows you to increase data integrity by ensuring that only one label length will be accepted.

### Code Length

*Default:* **10**

*Options:* 1 to 64

**Note:** Fixed Code Length must be enabled for Code Length to take effect.

Allows you to specify the exact number of characters that the scanner will recognize. The scanner will ignore any code not having the specified length.

## Narrow Margins

*Default:* **Disabled**

*Options:* Disabled, Enabled

Allows the scanner to read bar codes with quiet zones less than 10 times the width of the narrow bar element. "Quiet zone" is the space at the leading and trailing ends of a label. Each quiet zone can be as narrow as only five times the width of the narrow bar element when Narrow Margins is enabled.

## Symbology ID

Default: **Disabled**

Options: *Disabled, Enabled*

When enabled, the scanner reads and outputs a three character prefix:

1. **]** (close bracket character) indicating the presence of a symbology ID
2. **A, F, I, E, or C**  
A = Code 39; F = Codabar; I = I 2 of 5; E = UPC/EAN; C = Code 128
3. A single number indicating the status of the check digit character (**table 2-1**):

If check digit is not enabled, the output is 0 (Col. 1). If check digit and check digit output are enabled, the output is as shown in column 2. If check digit is enabled, but output is disabled (Col. 3), the output is as shown in Col. 4, which is the sum of Col. 2 and Col. 3.

Table 2-1 Symbology Identifier Option Values

	Column 1 No check character	Column 2 Check digit and output enabled	Column 3 Check digit output disabled	Column 4 Sum of Column 2 and 3
Code 39	0	1	(2)	3
Codabar	0	2	(4)	6
I 2 of 5	0	1	(2)	3
UPC/EAN	Always zero, do not follow AIM spec.			
Code 128				

Example 1: For Code 39, if check digit and check digit output are both enabled, a 1 will be output; but if check digit output is disabled, a 3 (the sum of column 2 and column 3) will be output.

Example 2: For Codabar, if check digit and check digit output are both enabled, a 2 will be output; but if check digit output is disabled, a 6 (the sum of 2 and 4) will be output.

## Autodiscrimination

Default: **Disabled**

Options: *Disabled, Enabled*

When enabled, all symbology types are enabled.

# Output Menu

2-Menu Config.

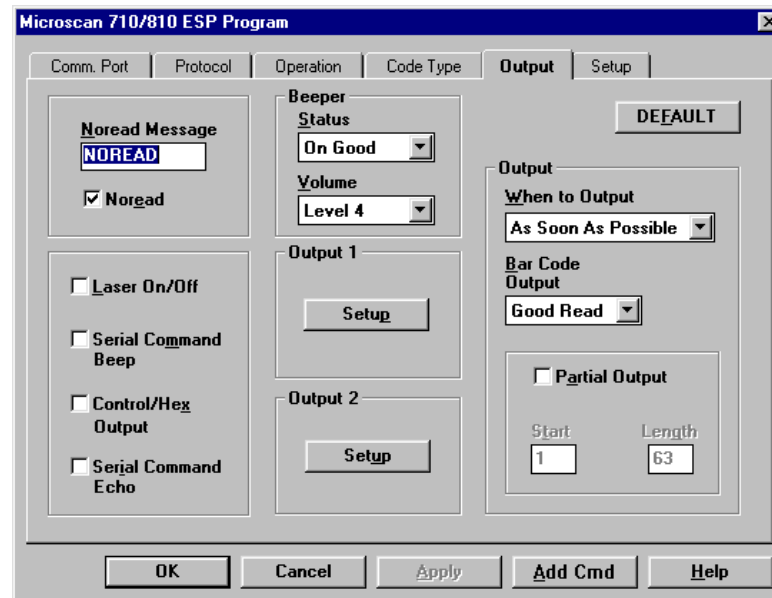

Figure 2-9 Scanner Output Menu Structure

## Default

Clicking the **DEFAULT** button will reset all parameters on the current menu to defaults. This does not take effect until it is saved to the scanner with the **SEND/NO SAVE** or **SEND/SAVE** buttons.

**Note:** Bar code output data and noread messages are transmitted on pin 2 under conditions set principally in Bar Code Output.

## Relay-1 and Relay-2

Relay pulses are transmitted via pins 7 and 14 (Relay-1 and Relay-2, respectively) and individually configured under conditions set in Relay-1 and Relay-2.

**Note:** Relay-1 output also causes closure of a relay in the IB-105 box, accessible through pin 15 of the IB-105 host connector (see [table A-9 on page A-19](#)).

Relay-1 and relay-2 can allow simultaneous output under individually programmed conditions.



**Output On**

*Default:* **Mismatch or Noread**

*Options:* *Mismatch or Noread, Match, Mismatch, Noread*

**Note:** If Output On is set to Mismatch or Noread, Match, or Mismatch, a relay pulse will not output unless Match Code Type ([page 2-22](#)) is not disabled and a master label is downloaded into memory ([page 2-21](#)).

**Note:** To send a pulse on a Good Read, enable Match and disable Match Code Type (see **"Match Code Type" on page 2-22**).

Allows you to set the conditions that will output a relay pulse either to pin 7 (Relay-1) or to pin 14 (Relay-2).

***Mismatch or Noread***

Sends a pulse when the label's data does not match that of the master label or the label is not decoded before the end of the read cycle.

***Match (or Good Read)***

Sends a pulse when the decoded label matches the master label. (To send the pulse on a good read, disable Match Code Type on [page 2-22](#).)

***Mismatch***

Sends a pulse when the label's data does not match that of the master label.

***Noread***

Sends a pulse when the label's data is not decoded before the end of the read cycle.

**Polarity**

*Default:* **Negative**

*Options:* *Negative, Positive*

Allows you to choose between positive and negative output signals for the relay output pin that is enabled.

**Pulse Width (in 10 ms incs)**

*Default:* **5** (.05 seconds). *Corresponds to 50 ms displayed in the menu.*

*Options:* *0 to 255 (0 to 2.55 seconds). Divide the number to be entered by 100 for time in seconds.*

Allows you to set the duration of the good match/noread output signals at the relay output pin that is enabled.

**Note:** After completing changes to Output On, Polarity, and Pulse Width, press **M** to advance to Bar Code Output and continue scrolling through the Scanner Output options.

---

## Chapter 2

### # Before Output

*Default:* **1**

*Options:* 1 to 255

Allows you to determine the number of consecutive hits (matches, mismatches, or noreads as configured by Output On) that must occur before a relay pulse will be sent from Relay-1 or Relay-2.

For example, if # Before Output is set to 3 and Relay-1 is set to Noread, then relay-1 will not fire until 3 consecutive noreads have occurred.

**Note:** The hits must be **consecutive** and **each one** must match the configured Output On condition. Any interruption in the consecutive sequence will result in a reset and cause the scanner to start the count over.

### Bar Code Output

*Default:* **Good Read**

*Options:* Good Read, Disabled, Match, Mismatch

**Note:** If Bar Code Output is set to Match or Mismatch, label data will not output unless Match Code Type ([page 2-22](#)) is enabled and a master label is downloaded into memory ([page 2-21](#)).

Allows you to choose the conditions under which label data (or noread messages) will be sent to the host.

#### *Good Read*

The scanner outputs on any good read independent of how Match Code Type is set.

#### *Disabled*

The scanner does not output both label data and noread messages to the serial port.

#### *Match (with Match Code Type enabled)*

The scanner outputs when the label data information matches the master label. However, if Match Code Type is disabled it outputs on any good read.

#### *Mismatch (with Match Code Type enabled)*

The scanner outputs when the label data information does not match the master label. However, if Match Code Type is disabled it outputs on any good read.

### When to Output (bar code data)

*Default:* **As Soon As Possible**

*Options:* As Soon As Possible, End of Read Cycle

Allows you to choose when bar code data is sent to the host.

#### *As Soon As Possible*

Causes bar code data (good reads) to be transmitted immediately upon a good decode.

### End of Read Cycle

Causes bar code data output to be delayed until the end of the read cycle.

### Noread Message

*Default:* **NOREAD**

*Options:* Up to seven ASCII characters (except NUL)

Allows you to define any combination of ASCII characters (except NUL) up to seven characters as the noread message. When enabled, and if no bar code label has been decoded before timeout or the end of the read cycle, the noread message will be transmitted to the host.

### Noread Output (enable/disable)

*Default:* **Enabled**

*Options:* Enabled, Disabled

**Note:** If Noread Output is enabled, the noread message will only output if Bar Code Output ([page 2-34](#)) is also enabled and MS-sensor Status ([page 2-40](#)) is disabled. Allows you to enable or disable the noread message.

### Beeper Status

*Default:* **On Good**

*Options:* On Good, On Noread

A beep is emitted either after each good read of a bar code label or after each noread.

**Note:** The beep period is short for triggered modes when a new trigger occurs immediately or the output is delayed to the end of the read cycle on edge and serial triggers.

### Beeper Volume

*Default:* **Level 4**

*Options:* Level 4, Level 5, Off, Level 1, Level 2, Level 3

### Laser On/Off

*Default:* **Disabled**

*Options:* Disabled, Enabled

**Note:** A serial or external trigger (see "Triggering Mode" on [page 2-16](#)) must be enabled for Laser On/Off to take effect.

When enabled, the laser is ON only during the read cycle. When disabled, the laser operates continuously.

**Note:** Laser On/Off does not relate to the Enable Laser Scanning (<H>) or Disable Laser Scanning (<I>) operational commands on [page 4-6](#).

## K Command Options

### *Echo K Command*

*Default:* **Disabled**

*Options:* *Disabled, Enabled*

When enabled, serial configuration commands ("K" commands) will be processed and the new string for that command will be echoed back to the host. If an invalid command is sent to the host, the scanner will echo back the current setting of that command. For example, if the current Noread Message is "NOREAD" and <Kk1,NONSENSE> is entered, the scanner will echo back: <Kk1,NOREAD>. In this example the attempted entry "NONSENSE" exceeds the maximum allowable seven characters. Therefore it is rejected and the current NOREAD message is echoed back and remains the Noread Message.

**Note:** It is important to note that if a command with multiple fields is processed, some of the fields may have been processed properly following an "invalid" command. These changes will be in the string echoed back so that the user will know what did or did not change.

### *Beep on K*

*Default:* **Disabled**

*Options:* *Disabled, Enabled*

When enabled, the scanner beeps once whenever a K command is entered to indicate that the command was accepted and processed. If an invalid command is entered, the scanner beeps 5 times to indicate an invalid entry. However, this does not necessarily mean that all data fields have been entered incorrectly. Only one bad field needs to be found in order to activate the 5 beep response.

### *Control Character Output*

*Default:* **Ctrl**

*Options:* *Ctrl, Hex*

Determines response to an Echo K or status request command. When set to CTRL, ASCII control character output includes a control character as shown in the "Ctrl" column of [Table A-4, "ASCII Table with Control Characters," on page A-7](#). When set to Hex, the output is the actual character.

## Partial Output

*Default:* **Disabled**

*Options:* *Disabled, Enabled*

When enabled, allows you to pre-select portions of labels to be transmitted by the scanner.

In multilabel mode, partial output is performed on each separate label. For example, if Start Position is set to 3 and Partial Length is set to 5, the following labels are transmitted as follows:

1234567890 as "34567"

1234 as "34"

1234,abcde as "34,cde" (two labels with separator)

12 as ""

### *Start Position*

*Default:* **1**

*Options:* *1 to 63*

Allows you to determine the first character from the beginning of a label to transmit.

### *Partial Length*

*Default:* **63**

*Options:* *1 to 63*

Allows you to determine the number of characters to be transmitted.

## Setup Menu

The Setup menu allows you to set specific bar code scanning parameters that affect decode rate, and if equipped with the MS-sensor, allows you to determine why the scanner did not decode a specific label within the triggered read cycle.

2-Menu Config.

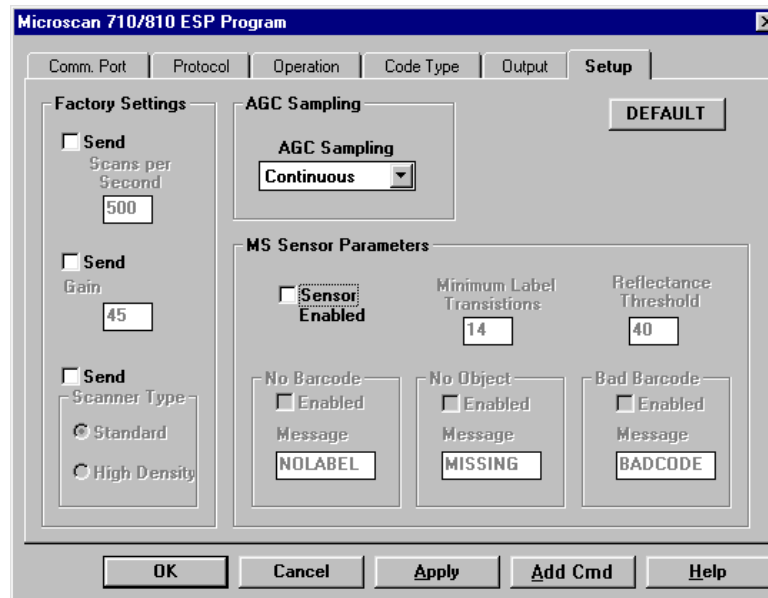

Figure 2-10 Setup Menu Structure

### Default

Clicking the **DEFAULT** button will reset all parameters on the current menu to defaults. This does not take effect until it is saved to the scanner with the **SEND/NO SAVE** or **SEND/SAVE** buttons.

**Note:** Unlike most configuration settings Scanner Type, Scans per Second, and Gain Adjustment are not saved for power-on (but are initialized) when you press Y. To save new settings to NOVRAM for these parameters, enter the <Zp> command. See "Save Scanner Type, SPS, and Gain for Power-on" on ["Save Scanner Type, SPS, and Gain for Power-on," on page 4-12.](#)

## Factory Settings

### Scans per Second

*Default:* **50**. Corresponds to 500 (scans per second) displayed in the menu.

*Options:* 30 to 55. Multiply the number to be entered by 10 for actual scans per second.

Allows you to set the number of scans per second by controlling mirror motor speed. The range is 300 to 550 scans per second.

### Gain Adjustment

*Default:* **45** (nominal)

*Options:* 10 to 255

**Note:** Gain Adjustment is optimized at the factory before shipment; your default value may not be 45.

Allows you to specify a gain value for the analog circuitry. Changes to Gain should typically be done by qualified technicians.

**Important:** Before saving any changes to Gain Adjustment (see "Save Scanner Type, SPS, and Gain for Power-on" on **"Save Scanner Type, SPS, and Gain for Power-on," on page 4-12**), first record the optimized factory setting for future reference.

### Scanner Type

*Default:* Standard if the unit is configured for low density; High Density if the unit is configured for high density.

*Options:* Standard, High Density

The Scanner Type "default" from the factory indicates the density type of the scanner (with the unit's optics adjusted accordingly). Do not change this setting unless instructed to do so by a Microscan representative.

**Important:** Entering the <Zp> command (see "Save Scanner Type, SPS, and Gain for Power-on" on page 4-12) will save the current setting for Scanner Type to NOVRAM. If you need to verify the density type of a unit, see your FIS number and contact your Microscan representative.

### AGC Sampling

*Default:* **Continuous**

*Options:* Continuous, Disabled, Leading Edge

Allows you to specify how automatic gain control sampling will be done. Continuous mode continually samples 14 transitions and stores the highest value of the samples and adjusts the AGC value at the end of the scan. Leading Edge mode finds the leading edge by looking for a 40  $\mu$ s quiet zone followed by 14 transitions and stores the highest value of the samples and adjusts the AGC at the end of the scan. Leading Edge is especially effective when labels are skewed. Changes to AGC Sampling should typically be done by qualified technicians.

## MS-sensor Parameters<sup>1</sup>

*Default:* **Disabled**

*Options:* *Disabled, Enabled*

**Note:** See **"MS-Sensor" on page A-24**.

The specular sensor—once you adjust it to your environment—determines why the scanner fails to decode a label within the triggered read cycle. It then outputs the appropriate message to you. The following three conditions are possible:

1. the object's bar code is defective (you receive a bad bar code message)
2. there is no bar code on the object (you receive a no bar code message)
3. there is no object (you receive a no object message)

The sensor is adjusted by the values you assign to Minimum Label Transitions and Reflectance Threshold. These settings are derived from the extended decode rate test, explained on **"Extended Mode" on page 4-4**.

### Minimum Label Transitions

*Default:* **14**

*Options:* *3 to 255*

Allows you to define the minimum number of label space transitions (bars and spaces) at which a label is detected. The number you enter is derived by testing several objects with labels while in Extended Mode (see **"Extended Mode," on page 4-4**). Select a number that is one or two numbers less than the smallest value displayed for number of label space transitions.

### Reflectance Threshold

*Default:* **40**

*Options:* *0 to 255*

Allows you to set the reflectance threshold—the level at which an object is detected. The number is derived by testing the reflectivity of empty space. Select a number that is one or two numbers greater than the value posted when nothing is in the scanner's beam. See **"MS-Sensor" on page A-24**.<sup>2</sup>

1. Applies only to FIS options that include the MS-sensor.

2. Reflectance can also be modified by sending the <KQ offset> test command which samples 50 scans for the highest reflectance value and adds a user-defined offset to this value.



**No Barcode Status**

*Default:* **Disabled**

*Options:* *Disabled, Enabled*

Allows you enable or disable the no label message.

**No Barcode Message**

*Default:* **NOLABEL**

*Options:* *Up to seven ASCII characters (except NUL)*

Allows you to define the message that is sent when an object is present without a label.

**Bad Barcode Status**

*Default:* **Disabled**

*Options:* *Disabled, Enabled*

Allows you to enable or disable the bad label message.

**Bad Barcode Message**

*Default:* **BADCODE**

*Options:* *Up to seven ASCII characters (except NUL)*

Allows you to define the message that is sent when a label is defective.

**No Object Status**

*Default:* **Disabled**

*Options:* *Disabled, Enabled*

Allows you to enable or disable the no object message.

**No Object Message**

*Default:* **MISSING**

*Options:* *Up to seven ASCII characters (except NUL)*

Allows you to define the message that is sent when an object is not present.



*Chapter*  
**3**

# *Serial Configuration*

## *Chapter Contents*

About Serial Configuration .....	3-3
Communications Port Commands .....	3-5
Protocol Commands .....	3-6
Operations Commands .....	3-10
Code Types Commands .....	3-13
Scanner Output Commands .....	3-15
Scanner Setup Commands .....	3-18

Most of the configuration changes to the scanner that can be made in the menu can also be accomplished by command strings from the host.

Serial command strings are entered from an ASCII terminal. As with menu configuration commands, serial configuration commands relate to the initial scanner setup.

To quickly reference the serial configuration commands, see [table 3-1 on page 3-2](#).

Table 3-1 Summary of Serial Configuration Commands

Function	K	Command	Format
Comm. Port	Ka	Host Port	<K <b>a</b> baud,parity,stop bits,data bits>
	Ky	Aux Port	<K <b>y</b> mode,baud,parity,stop bits,data bits,daisy chain enable,daisy chain id>
	KT	Communications Status Request	<K <b>T</b> ?>
Protocol	Kf	Communications Protocol	<K <b>f</b> protocol,address>
	Kd	Preamble	<K <b>d</b> status,ASCII characters>
	Ke	Postamble	<K <b>e</b> status,ASCII characters>
	Kc	LRC	<K <b>c</b> status>
	KA	Response Timeout	<K <b>A</b> timeout setting>
	KB	Intercharacter Delay	<K <b>B</b> number>
Operations	Kg	Triggering Mode	<K <b>g</b> mode,filter time>
	Kh	End of Read Cycle	<K <b>h</b> mode,time>
	Ki	Serial Trigger Character	<K <b>i</b> character>
	Kj	External Trigger Level	<K <b>j</b> mode>
	Km	Good Decode Reads	<K <b>m</b> number>
	Kn	Match Code Type	<K <b>n</b> type,sequential matching,match start position,match length,wild card character,sequence on noread,sequence on every mismatch>
	Kz	New Master Pin	<K <b>z</b> status>
	KL	Number of Labels	<K <b>L</b> number of labels,multilabel separator>
KV	Operations Status Request	<K <b>V</b> ?>	
Code Types	Kp	Code 39	<K <b>p</b> status,check digit status,check digit output status,large intercharacter gap,fixed code length status,code length>
	Kq	Codabar	<K <b>q</b> status,start & stop match status,start & stop output status,large intercharacter gap,fixed code length status,code length,check digit type,check digit output>
	Kr	Interleaved 2 of 5	<K <b>r</b> status,check digit,check digit output,length 1,length 2>
	Ks	UPC/EAN	<K <b>s</b> status,EAN status,supplementals status,separator status,separator char.>
	Kt	Code 128	<K <b>t</b> status,fixed length,length>
	Ko	Narrow Margins/Symbology ID	<K <b>o</b> narrow margins status,symbology ID status>
	P	Autodiscriminate All Codes	<P>
	KW	Code Types Status Request	<K <b>W</b> ?>
Scanner Output	Kv	Relay-1	<K <b>v</b> output on,polarity,pulse width,# before output>
	Kw	Relay-2	<K <b>w</b> output on,polarity,pulse width,# before output>
	Kl	Bar Code Output	<K <b>l</b> status,when to output>
	Kk	Noread Message	<K <b>k</b> status,output>
	Ku	Beeper	<K <b>u</b> status,volume>
	KC	Laser On/Off	<K <b>C</b> status>
	KS	Serial Verification	<K <b>S</b> serial command echo status,serial command beep status,control/hex output>
	KY	Partial Output	<K <b>Y</b> status,start position,length>
KX	Scanner Output Status Request	<K <b>X</b> ?>	
Scanner Setup	KP	Scanner Type	<K <b>P</b> density>
	KE	Scans per Second	<K <b>E</b> speed>
	KD	Auto Gain Control	<K <b>D</b> gain adjustment,AGC sampling>
	KH	MS-sensor Setup	<K <b>H</b> status,minimum transitions,reflectance>
	KQ	Reflectance Setup Test	<K <b>Q</b> offset>
	KM	Bad Barcode Message	<K <b>M</b> status,message>
	KN	No Barcode Message	<K <b>N</b> status,message>
	KO	No Object Output Message	<K <b>O</b> status,message>
KU	Scanner Setup Status Request	<K <b>U</b> ?>	
All	K?	Return all K Commands	<K <b>?</b> >

# About Serial Configuration

## Serial Configuration Command Format

The format for a serial configuration command is,

`<Kparameterdata,data,...etc.><initializing command>`

Where:

- Less than < and greater than > symbols are included as part of the commands.
- "parameter," as used here, are those character(s) that precede the data.
- The "initializing command" <A> or <Z> is sent after configuration is complete. <Z> resets and saves for power up. <A> initializes the change to RAM.<sup>1</sup> (For more information, see "[Reset](#)," on page 4-11.)

For example, the following command enables UPC and saves the change for power-on: **<Ks1><Z>**.

When using serial configuration commands, note also the following conventions:

- Parameters and data are "case sensitive." That is, characters must be entered as upper or lower case, as specified.
- All data fields (except the last) must be followed by a comma (without a space).
- If there is no change in a given field, then commas can be entered alone, or with the existing data (for example, **<Ka,,,0>** or **<Ka4,1,0,0>**).
- All fields preceding the modified field must be included. For example, in Host Port, to change Data Bits to Eight without changing any other field, enter either: **<Ka,,,1>** or **<Ka4,1,0,1>**.
- All fields following the modified field can be left out. For example, in the RS-232 port, to change Baud Rate to 4800, enter **<Ka3>**.

(See examples on following pages.)

1. See "[Initializing serial configuration commands](#)" on page 3-4 for definitions and examples.

**Initializing serial configuration commands**

To ensure that a serial configuration command will take effect, you need to follow it with one of the operational commands below:

**<A>** To reset but not save changes for power-on

**<Z>** To reset and save changes for power-on

For example, to change Baud Rate and reset without saving changes for power-up, enter **<Ka3><A>**.

To change Baud Rate and reset, saving the changes to NOVRAM, enter **<Ka3><Z>**.

To ensure that a command was received and accepted, you can enter the Show Scanner Status command, **<?>**.

**Concatenating Serial Commands**

Commands can be concatenated (added together) to a maximum of 64 characters in a single string or data block. Additional data blocks of 64 or less characters can be sent provided there is at least a 10 ms pause between blocks.

For example, **<Kc1><Kh1><Ko1><A>** enables LRC, sets End of Read Cycle mode to New Trigger, enables Narrow Margins and resets the data buffers (without saving the changes for power-on).

**Serial Command Status Request**

The status of serial commands can be requested by entering the command followed by a question mark. For example, enter **<Ke?>** to request the status of Postamble. Commands **KT?**, **KV?**, **KW?**, **KX?**, and **KU?** are used to request the status of groups of serial commands (see [table 3-1 on page 3-2](#)).

**Loss of Communications**

Making changes to communications parameters such as Baud Rate, Parity, Stop Bits, LRC, etc. without corresponding changes in linked device(s) can result in the loss of menu access. If this should occur, default the scanner with the **<Zd>** Restore/Save Default Configuration for Power-on command as described on [page 4-12](#).

**CAUTION:** Defaulting the scanner will reset all standard configuration parameters except Scanner Type, Scans per Second, and Gain Adjustment to their original default values.

**Note:** Power must be available to the scanner during the default procedure.

# Communications Port Commands

## Host Port

**Note:** Changes made in the scanner's communications parameters such as baud rate, parity, stop bits, LRC, etc., must be matched in the other device(s) or communications will be lost. If this occurs, default the scanner with the **<Zd>** Restore/Save Default Configuration for Power-on command as described on [page 4-12](#).

*Format:* **<Ka**baud rate,parity,stop bits,data bits**>**

<i>baud rate:</i>			<i>parity:</i>		
0 = 600	3 = 4800	6 = 38.4K	0 = None		
1 = 1200	<b>4 = 9600</b>	7 = 76.8K	<b>1 = Even</b>		
2 = 2400	5 = 19.2K	8 = 300	2 = Odd		
<i>stop bits:</i>			<i>data bits:</i>		
<b>0 = One</b>			<b>0 = Seven</b>		
1 = Two			1 = Eight		

Example: To change Host Port Baud Rate to 2400, enter **<Ka2>**.

## Auxiliary Port

*Format:* **<Ky**mode,baud rate,parity,stop bits,data bits,daisy chain ID status,daisy chain id**>**<sup>1</sup>

<i>mode:</i>		<i>baud rate:</i>			
<b>0 = Disabled</b>	3 = Full duplex	0 = 600	3 = 4800	6 = 38.4K	
1 = Transparent	4 = Daisy chain	1 = 1200	<b>4 = 9600</b>	7 = 76.8K	
2 = Half duplex		2 = 2400	5 = 19.2K	8 = 300	
<i>parity:</i>	<i>stop bits:</i>	<i>data bits:</i>	<i>daisy chain ID status</i>	<i>daisy chain I.D.</i>	
0 = None	<b>0 = One</b>	<b>0 = Seven</b>	<b>0 = Disabled</b>	any 2 ASCII characters.	
<b>1 = Even</b>	1 = Two	1 = Eight	1 = Enabled	Default is <b>1/</b>	
2 = Odd					

Example: To change Aux Port Baud Rate to 2400, enter **<Ky2>**.

## Communications Status Request

*Format:* **<KT?>**

Returns status of each command in the group.

1. For use with Microscan's IB-105.

# Protocol Commands

If selecting one of the options from 0 to 4 (Point-to-Point, Point-to-Point with RTS/CTS, Point-to-Point with XON/XOFF, Point-to-Point with RTS/CTS and XON/XOFF, or Polling Mode D), use this format:

Format: **<Kfprotocol>**<sup>1</sup>

protocol:

<b>0 = Point-to-Point</b>	4 = Polling Mode D
1 = Point-to-Point with RTS/CTS	5 = Multidrop (requires address)
2 = Point-to-Point with XON/XOFF	6 = User Defined
3 = Point-to-Point with RTS/CTS and XON/XOFF	7 = User Defined Multidrop

Example: To change the Protocol to Polling Mode D, enter **<Kf4>**.

If selecting Multidrop (5), you must define an address and append it to the command string.

Format: **<Kf5,address>**

protocol:

5 = Multidrop

address:

Any number from 1 to 50

Example: To change the Protocol to Multidrop with an address of 33, enter **<Kf5,33>**.

If selecting User Defined (6) or User Defined Multidrop (7), complete the format by either choosing new parameters or concatenating unchanged data fields (separate by commas).

**TIP:** For User Defined, first select Point-to-Point **<Kf0>** and then User Defined **<Kf6...>**. For user Defined Multidrop, first select Multidrop **<Kf5>**, then User Defined Multidrop **<Kf7...>**.

Format: **<Kfprotocol,RES,address,REQ,EOT,STX,ETX,ACK,NAK,from host>**

protocol:

6 = User Defined;

From Host: **0 = disabled** 1 = enabled

Example: To select an unpolled ACK/NAK User Defined protocol with LRC disabled, enter **<Kf0><Kf6,,,,,,^F,^U><Kc0>**.<sup>2</sup> ACK and NAK will be displayed in the menu.

1. Polling Mode D, Multidrop, User Defined, and User Defined Multidrop are for use with Microscan's IB-105.
2. **<Kf0>** nulls the address and **<Kc0>** disables LRC. A control character, although conventionally represented here and in the ASCII table on [page A-7](#) as two characters (^F or ^U, etc.), is actually a single ASCII character that is entered on the keyboard by holding down the control key while pressing the desired letter.



**Note:** Address, can be assigned any ASCII character except a null. Control characters are used to define RES through NAK (except Address). **Table 3-2** lists the control characters used for these data fields. (Refer to **Table A-4, "ASCII Table with Control Characters,"** on page A-7 for more information.)

**Explanation of the From Host option**

Suppose STX, ETX and EOT are defined in the MS-710, the trigger counter is currently T/00000, and you want to send the Trigger Counter Request command to the scanner.

Defined Protocol: **STX, ETX, EOT**

Trigger Counter Status: T/00000

Host Command Request: <T> (Trigger Counter Request Command)

The command string format from the host would depend on the From Host setting.

If From Host is disabled, <T> (Trigger Counter Request command) would be the required format from the host to cause the scanner to return STX T/00000 ETX EOT. However, if From Host is enabled, the required host command string would be **STX <T> ETX EOT** to receive the same response from the scanner. In either case the data string returned by the scanner always includes the defined protocol. In this example, that returned data would be **STX T/00000 ETX EOT**.

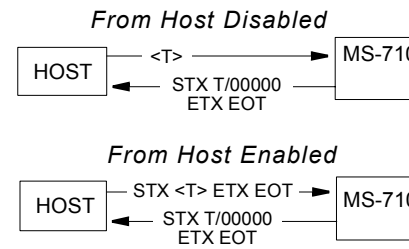

Format: <Kfprotocol,RES,address,REQ,EOT,STX,ETX,ACK,NAK>

protocol:

7 = User Defined Multidrop

Example: To customize multidrop protocol's STX (start of text) and EOT (reset) sequence and assign an address of 2, send <Kf5,2><Kf7,^M,,,^A>. The <Kf5,2> portion of the command enables the standard Multidrop protocol and assigns a Multidrop address. ^M is the new STX and ^A the new EOT. All other protocol characters will retain their standard Multidrop values.

**Note:** Address, can be assigned any ASCII character except a null. Control characters are used to define RES through NAK (except Address). **Table 3-2** lists the control characters used for these data fields. (Refer to **Table A-4, "ASCII Table with Control Characters,"** on page A-7 for more information.)

Table 3-2 Protocol Commands

Protocol Command (Mnemonic displayed on Microscan menu)	Control Characters (Entered in menu or serial command)	Effect of Command
RES	^D	Reset
REQ	^E	Request
EOT	^D	Reset
STX	^B	Start of Text
ETX	^C	End of Text
ACK	^F	Acknowledge
NAK	^U	Negative Acknowledge

### Preamble

Format: <Kdstatus,preamble character(s)>

status: preamble character(s):

**0 = Disabled** Enter one or two preamble characters except a null  
**1 = Enabled** (00H). Default is **^M**.

Example: To enable Preamble with just one character, an FF (form feed), enter <Kd1,^L>.

### Postamble

Format: <Kestatus,postamble character(s)>

status: postamble character(s):

**0 = Disabled** Enter one or two postamble characters except a  
**1 = Enabled** null (00H). Default characters are **^M^J**.

Example: To disable Postamble, enter <Ke0>.

### LRC

Format: <Kcstatus>

status:

**0 = Disabled**  
**1 = Enabled**

Example: To enable LRC, enter <Kc1>.

### Response Timeout

Format: <**KA**timeout setting><sup>1</sup>

timeout setting:

Default is **12** (ms).

Any number from 0 to 65,000 (a zero causes an indefinite wait).

Example: To change Response Timeout to 30 ms, enter <**KA30**>.

### Intercharacter Delay

Format: <**KB**time interval>

time interval (between characters in milliseconds):

Default is **0**.

Any number from 0 to 255.

Example: To change Inter-character Delay to 30 ms, enter <**KB30**>.

---

1. For use with Microscan's IB-105.

# Operation Commands

## Triggering Mode

Format: **<Kg**triggering mode,filter time>

triggering mode: trigger filter time (in 128  $\mu$ s increments):

- 0 = Continuous Read** Default is **78** (9984  $\mu$ s; approx. 10 ms)
- 1 = Continuous Read 1 Output Any number between 2 and 255.
- 2 = External Level
- 3 = External Edge
- 4 = Serial Data
- 5 = Serial Data & Edge

Example: To select External Edge, enter **<Kg3>**.

3-Serial Config.

## End of Read Cycle

Format: **<Kh**end of read cycle mode,timeout>

end of read cycle mode: timeout (in 10 millisecond increments):

- 0 = Timeout** Default is **100** (one second).
- 1 = New Trigger Any number between 0 and 65535.
- 2 = Timeout & New Trigger

Example: To select Timeout and change the timeout value to 6 seconds, enter **<Kh0,600>**.

## Serial Trigger Character

Format: **<Ki**serial trigger character><sup>1</sup>

serial trigger character:

Default is **^]**.

Any available ASCII character (see **"ASCII Table with Control Characters" on page A-7**).

Example: To define the Serial Trigger Character as a lowercase c, enter **<Kic>**.

1. Avoid selecting a serial trigger character that is also an operational command. For example, an uppercase C cannot be used as a serial trigger character because it is the operational command for Enter Decode Rate Test. However, a lowercase c could be used without initiating the decode rate test.

### External Trigger Level

Format: <Kjexternal trigger level>

external trigger level (initiates a read cycle):

0 = Negative

**1 = Positive**

Example: To change External Trigger Level to Negative, enter <Kj0>.

### Good Decode Reads

Format: <Kmnumber of reads>

number of reads (before a good decode):

Default is **1**.

Any number from 1 to 31.

Example: To change Good Decode Reads to 3, enter <Km3>.

### Match Code Type

Format: <Kn<sup>type</sup>,sequential matching,match start position,match length,wild card character,sequence on noread,sequence on every mismatch>

type: sequential matching match start position

**0 = Disabled**      **0 = Increment**      Default is **0**.

1 = Enabled      1 = Decrement      0 to 64

2 = Sequential

3 = Wild Card

match length      wild card character

Default is **1**.      Default is **\***.

1 to 64      Any ASCII character.

sequence on noread:

0 = Disabled      **1 = Enabled**

When enabled, the scanner sequences (increment or decrement) on every noread.

If 001, 002, noread, then search for 003.

If 001, 002, noread, then search for 004.

sequence on every mismatch:

**0 = Disabled**      1 = Enabled

When disabled, if a mismatch is out of sequence by no more than 1, then the sequence resumes and searches indefinitely.

When enabled, the scanner sequences on every mismatch.

If 001, 002, 004 (mismatch), then search for 005.

If 001, 002, mismatch, then search for 004. If mismatch occurs again, then search for 005, etc.

## Chapter 3

Example: To enable Match Code Type for Sequential, set Sequential Matching for Decrement, and enable Sequence on Every Mismatch, enter **<Kn2,1,,,,,1>**.

### New Master Pin

Format: **<Kzstatus>**

status:

**0 = Disabled**

1 = Enabled

Example: To enable New Master Pin, enter **<Kz1>**.

### Number of Labels

Format: **<KLnumber,multilabel separator>**

number of labels:

multilabel separator:

**Default is 1.**

**Default is ,.**

Any number from 1 to 6

Any valid ASCII character

Example: To change Number of Labels to 3, enter **<KL3>**.

### Operations Status Request

Format: **<KV?>**

Returns status of each command in the group.

## Code Type Commands

### Code 39

*Format: <Kpstatus,check digit status,check digit output status,large intercharacter gap,fixed code length status,code length>*

<i>status:</i>	<i>check digit status:</i>	<i>check digit output status:</i>
0 = Disabled	<b>0 = Disabled</b>	<b>0 = Disabled</b>
<b>1 = Enabled</b>	1 = Enabled	1 = Enabled
<i>large inter-character gap:fixed code length status:</i>	<i>status:</i>	<i>code length:</i>
<b>0 = Disabled</b>	<b>0 = Disabled</b>	Default is <b>10</b> .
1 = Enabled	1 = Enabled	Any number from 1 to 64.

Example: To set Fixed Code Length to 30, enter **<K,,,,1,30>** or **<Kp1,0,0,0,1,30>**.

### Codabar

*Format: <Kqstatus,start & stop match status,start & stop output status,large intercharacter gap,fixed code length status,code length,check digit type,check digit output>*

<i>status:</i>	<i>start &amp; stop match status:</i>	<i>start &amp; stop output status:</i>
<b>0 = Disabled</b>	<b>0 = Disabled</b>	<b>0 = Disabled</b>
1 = Enabled	1 = Enabled	1 = Enabled
<i>large inter-character gap:fixed code length status:</i>	<i>status:</i>	<i>code length:</i>
<b>0 = Disabled</b>	<b>0 = Disabled</b>	Default is <b>10</b>
1 = Enabled	1 = Enabled	Any number from 1 to 64.
<i>check digit type:</i>		<i>check digit output:</i>
<b>0 = Disabled</b>	2 = NW7	<b>0 = Disabled</b>
1 = Mod 16	3 = Both	1 = Enabled

Example: To set Fixed Code Length to 9, enter **<Kq1,,,,1,9>** or **<Kq1,1,1,0,1,9>**.

## I 2 of 5

Format: <Krstatus,check digit status,check digit output status,code length #1,code length #2>

status:	check digit status:	check digit output status:
<b>0 = Disabled</b>	<b>0 = Disabled</b>	<b>0 = Disabled</b>
1 = Enabled	1 = Enabled	1 = Enabled

code length #1:	code length #2:
Default is <b>10</b> .	Default is <b>6</b> .
Zero or any even number from 2 to 64.	Zero or any even number from 2 to 64.

Example: To set Fixed Code Length #1 to 8 and Fixed Code Length #2 to 4, enter <Kr1,,,8,4> or <Kr1,0,0,8,4>.

## UPC/EAN

Format: <KsUPC status,EAN status,supplementals status,separator status,separator character>

UPC status:	EAN status:	supplementals status:
<b>0 = Disabled</b>	<b>0 = Disabled</b>	<b>0 = Disabled</b>
1 = Enabled	1 = Enabled (UPC must also be enabled)	1 = Enabled 2 = Required
separator status:	separator character:	
<b>0 = Disabled</b>	Any ASCII character (except NUL).	
1 = Enabled	Default is a comma (,).	

Example: To change Supplementals to Required, and change Separator Character to a dash (-), enter <Ks1,1,2,1,->.

## Code 128

Format: <Ktstatus,fixed code length status,code length>

status:	fixed code length status:	code length:
<b>0 = Disabled</b>	<b>0 = Disabled</b>	Default is <b>10</b> .
1 = Enabled	1 = Enabled	Any number from 1 to 64.

Example: To enable Code 128, enable Fixed Code Length, and set Code Length to 9, enter <Kt1,1,9>.



### Narrow Margins/Symbology ID

Format: <**Ko**narrow margins status,symbology ID status>

narrow margins status:

symbology ID status:

**0 = Disabled**

**0 = Disabled**

1 = Enabled

1 = Enabled

Example: To enable Narrow Margins, send <**Ko1**>.

### Autodiscriminate

Format: <**P**>

Enables all available symbology types and disables OMR. You may individually disable/enable each symbology type also.

**Note:** For maximum scanning speed, enable only those symbologies used in the application.

### Code Types Status Request

Format: <**KW?**>

Example: Returns status of each command in the group

## Scanner Output Commands

### Relay-1

Format: **<Kv**output on,polarity,pulse width,# before output>

output on (mode):	polarity:	pulse width:	# before output:
<b>0 = Mismatch or Noread</b>	<b>0 = Negative</b>	Default is <b>5</b>	Default is <b>1</b> .
1 = Match (or Good Read)	1 = Positive	(50 ms).	1 to 255
2 = Mismatch		0 to 255	
3 = Noread			

Example: To set Relay-1 to Mismatch and change Pulse Width to 40 ms, and # Before Output to 5, enter **<Kv2,0,4,5>** or **<Kv2,,4,5>**.

### Relay-2

Format: **<Kw**output on,polarity,pulse width,# before output>

output on (mode):	polarity:	pulse width:	# before output:
<b>0 = Mismatch or Noread</b>	<b>0 = Negative</b>	Default is <b>5</b>	Default is <b>1</b> .
1 = Match (or Good Read)	1 = Positive	(50 ms).	1 to 255
2 = Mismatch		0 to 255	
3 = Noread			

Example: To set Relay-2 to Mismatch and change Pulse Width to 40 ms, enter **<Kw2,0,4>** or **<Kw2,,4>**.

### Bar Code Output

Format: **<KI**status,when to output>

status:	when to output:
<b>0 = Disabled</b>	<b>0 = As Soon As Possible</b>
1 = Match	1 = End of Read Cycle
2 = Mismatch	
3 = Good Read	

Example: To set When to Output to End of Read Cycle, enter **<KI3,1>**.

**Noread Message**

Format: <**Kk**status,output>

status:                    noread output:

0 = Disabled      Default is **NOREAD**.

**1 = Enabled**      Any ASCII string up to 7 digits.

Example: To enable Noread Message and send the message "FAIL," enter  
<**Kk1,FAIL**>.

**Beeper**

Format: <**Ku**beeper status,beeper volume>

beeper status:            beeper volume:

**0 = On Good**            0 = Off    3 = Level 3

1 = On Noread            1 = Level **14 = Level 4**

2 = Level 25 = Level 5

Example: To set the beeper for On Noread and set the beeper volume to Off, enter  
<**Ku1,0**>.

**Laser On/Off**

Format: <**KC**status>

status:

**0 = Disabled** 1 = Enabled

Example: To enable Laser On/Off, enter <**KC1**>.

**Partial Output**

Format: <**KY**status,start position,length>

partial output status:    start position:            length:

0 = Disabled            Default is 1            Default is 63

1 = Enabled            1 to 63            1 to 63

Example: To enable Partial Output, set start position to 5, and set length to 6 characters, send <**KY1,5,6**>.

### Serial Verification

Format: **<KS**serial command echo status,serial command beep status,control/hex output>

serial command echo status:	serial command beep status:	control/hex output:
0 = Disabled	0 = Disabled	0 = Control
1 = Enabled	1 = Enabled	1 = Hex

Example: To enable Serial Command Echo Status and Beep Status, and Hex output, enter **<KS1,1,1>**

### Scanner Output Status Request

Format: **<KX?>**

Returns status of each command in the Scanner Output group.

# Scanner Setup Commands

## Scanner Type

**Important:** Entering the **<Zp>** command (see "Save Scanner Type, SPS, and Gain for Power-on" on page 4-12) will save the current setting for Scanner Type to NOVRAM.

*Format:* **<KPdensity>**

*scanner density type:\**

0 = Standard

1 = High Density

\* The "default" will depend on the type of scanner.

Example: Do not change the scanner density type unless instructed to do so by a Microscan representative.

## Scans per Second

*Format:* **<KEscans per second>**

*scans per second (in 10 millisecond increments):*

Any number from 30 to 55.

Default is **50**. (500 scans per second.)

Example: To set the scanner to 400 scans per second, enter **<KE40>**.

## Auto Gain Control

**Important:** Before saving any changes to Gain Adjustment (see "Save Scanner Type, SPS, and Gain for Power-on" on page 4-12), first record the optimized factory setting for future reference.

*Format:* **<KDgain adjustment,AGC samplings>**

*gain adjustment:*

Default is **45** (nominal).

Any number from 10 to 255.

*AGC sampling:*

0 = Disabled

1 = Leading Edge

**2 = Continuous**

Example: To set the gain threshold to 40 and the AGC status to Leading Edge, enter **<KD40,1,0>**.

### MS-sensor Parameters<sup>1</sup>

Format: <KHstatus,minimum transitions,reflectance>

MS-sensor status:                      number of transitions:  
0 = **Disabled**                              Default is **14**.  
1 = Enabled                                  Any number from 3 to 255

reflectance threshold:  
Default is **40**.  
Any number from 0 to 255.

Example: To enable the sensor and set Number of Transitions to 20 and the reflectance threshold to 45, enter <KH1,20,45>.

### Reflectance Setup Test

Format: <KQoffset>

offset:  
0 to F (in hexadecimal)  
Samples 50 scans for the highest reflectance value and adds a user-defined offset to the reflectance threshold value under the MS-sensor Setup reflectance command <KH,,reflectance> above.

Example: To change the reflectance offset to add 12 to the reflectance threshold, enter <KQB>.

### Bad Barcode Message

Format: <KMstatus,message>

bad barcode status:                      message:  
0 = **Disabled**                              Default is **BADCODE**.  
1 = Enabled                                  Any ASCII string up to 7 characters.

Example: To change the message to "FAULTY," enter <KM1,FAULTY>.

1. Applies only to FIS options that include the sensor. If you did not order this option, disregard MS-sensor Setup through No Object Message.

### No Barcode Message

*Format:* <**KN**status,message>

*no barcode status:*

0 = **Disabled**

1 = Enabled

*message:*

Any ASCII string up to 7 characters.

Default is **NOLABEL**.

Example: To change the message to "NOCODE," enter **<KN1,NOCODE>**

### No Object Message

*Format:* <**KO**status,message>

*no object output status:*

0 = **Disabled**

1 = Enabled

*message:*

Default is **MISSING**.

Any ASCII string up to 7 characters.

Example: To change the message to "VACANT," enter **<KO1,VACANT>**.

### Scanner Setup Status Request

*Format:* <**KU?**>

Returns status of each command in the group.





# Chapter 4

# Utilities

## Chapter Contents

Read Rate .....	4-3
Trigger .....	4-5
Scanner .....	4-6
Counters .....	4-7
Master Label.....	4-9
Reset .....	4-11
Checksum.....	4-13
Code Type Commands.....	4-15

The Utilities menu allows you to send operational commands to the MS-710 to carry out routine operations “on the fly” as distinguished from serial configuration commands that are generally used during your initial setup.

The Utilities menu can be accessed by clicking the Utilities button or selecting from the Utilities pull down menu.

You can also send serial command strings to the scanner from a terminal window which you access by Clicking Terminal in ESP. Serial commands are enclosed in brackets **<>**.

Table 4-1 Summary of Operational Commands

Type	Cmd	Result
Read Rate	<C>	Decode Rate Test for Single Label
	<Cp>	Percentage Rate Test for Single Label
	<Cs>	Multilabel Decode Rate Test
	<Cm>	Multilabel Percentage Rate Test
	<Ce>	Extended Decode Rate Test for Single or Multilabel
	<J>	Exit any Rate Test
Trigger	<char>	Serial Trigger Character
Scanner	<H>	Enable Laser Scanning (Laser On)
	<I>	Disable Laser Scanning (Laser Off)
	<KE>	Motor On
	<KF>	Motor Off
	<L1>	Relay-1 Pulse
	<L2>	Relay-2 Pulse
Counters	<N>	Noread Counter
	<O>	Noread Counter Reset
	<T>	Trigger Counter
	<U>	Trigger Counter Reset
	<V>	Match Code/Good Read Counter
	<W>	Match Code/Good Read Counter Reset
	<X>	Mismatch Counter
	<Y>	Mismatch Counter Reset
Master Label	<E>	Enable Match Code Type
	<F>	Disable Match Code Type
	<G>	Store Next Label Scanned as Master Label
	<)XXXX>	Download Master Label Information
	<)>	Request Master Label Information
	<))>	Delete Master Label Information
Reset	<A>	Software Reset (does not save for power-on)
	<Ad>	Software Reset/Restore Default
	<An>	Software Reset/Read NOVRAM
	<D>	Enter Configuration Mode
	<Z>	Software Reset/Save Parameters for Power-on
	<Zd>	Restore/Save Default Configuration for Power-on
	<Zp>	Save Scanner Type, SPS, and Gain for Power-on
Checksum	<#>	Display Software Part Number
	<!>	Display Checksum of EPROM
	<?>	Show Scanner Status
	<?1>	Show Software Status (Send Status Byte, Part Number, and ROM Checksum. Display Current NOVRAM Checksum and Display NOVRAM Checksum at Power Up.)
Code Types (not in ESP)	<P>	Autodiscriminate All Codes
	<Q>	Enable Code 39 Only
	<R>	Enable Codabar Only
	<S>	Enable I 2 of 5 Only

## Read Rate

Decode (and percentage) rates can vary dramatically due to the angle and location of the label in relation to the scan beam (or scan line, if using a scan head with a moving beam). These tests are very useful in aligning and positioning the scanning device during installation.

### Single Label Percent Test

Clicking **Single Label Percent** and **Start** instructs the scanner to output the percent of decodes and any scanned label data.

*Associated serial command: <Cp>*

### Single Label Decodes/Second Test

Clicking **Single Label Decodes/Sec** and **Start** instructs the scanner to output the decodes per second and label data (if any). The decode rate can vary dramatically due to the angle and location of the label in relation to the scan beam (or scan line, if using a scan head with a moving beam). This test is very useful in aligning and positioning the scanning device during installation.

*Associated serial command: <C>*

### Multi-label Percent Test

Clicking **Multi-label Percent** and **Start** instructs the scanner to output the percentage of scans decoded and label data (if any) for multiple labels.

*Associated serial command: <Cm>*

### Multi-label Decode Rate Test

Clicking **Multi-label Decode/Sec** and **Start** instructs the scanner to output the decode rate and label data (if any) for multiple labels.

*Associated serial command: <Cs>*

### End Read Rate Test

Clicking **Stop** ends both the Percent test and the Decodes/Second test for both single and multi-label.

Associated serial command: **<J>**

### Extended Mode

Choosing any of the Read Rate modes along with **Extended Mode** affects both single and multiple labels. It instructs the scanner to output the transition data along with the data from the latest test command sent. For example, enabling extended mode along with single or multiple decodes per second will cause the decode rate, label data, and transition data to be displayed.

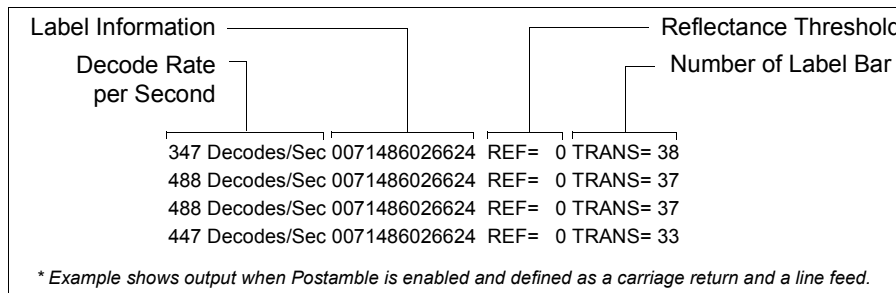

Associated serial command: **<Ce>** after **<C>**, **<Cs>**, **<C>**, or **<Cs>**

**Note:** The **<Ce>** command has no immediate effect if not preceded by **<C>**, **<Cs>**, **<C>**, or **<Cs>**.

# Trigger

Clicking the **Setup** button will bring up the current trigger character. Next click **Send** to send the trigger character to the scanner and initiate a read cycle. The results, a good read or noread message, will be displayed on the blank screen below the button.

**Note:** Your scanner must be in a point-to-point protocol for Trigger Setup to work.

**Note:** You can define the trigger character in the Operations menu.

*Associated serial command: <Ki **serial trigger character**>*

# Scanner

## Enable Laser Scanning

Clicking the **Laser On** button or sending serial command **<H>** will turn the laser on continuously.

**Note:** Enable Laser Scanning does not relate to Laser On/Off command.

*Associated serial command: <H>*

## Disable Laser Scanning

Clicking **Laser Off** will turn the laser off. This feature is useful during extended periods of time when no bar code labels are being scanned or the scanner is being configured. Disabling laser scanning will not affect any downloaded commands to the scanner.

**Note:** Disable Laser Scanning does not relate to Laser On/Off command.

*Associated serial command: <I>*

## Motor On

Clicking **Motor On** or sending serial command **<KE>** turns the spinning mirror and raster mirror motors on (if not already running).

Note: Spinning mirror reaches full speed after a short time delay).

*Associated serial command: <KE>*

## Motor Off

Clicking **Motor Off** or sending serial command **<KF>** turns the spinning mirror motor off. This command is useful for long idle periods.

*Associated serial command: <KF>*

## Output-1

Clicking **Output #1** activates the output between pin 7 (regardless of Master Label or Output-1 Driver status).

*Associated serial command: <L1>*

# Counters

Counter commands can be a numeric value from 00000 to 65,535. After reaching the maximum numeric limit of 65,535, an error message will be displayed and the counter will automatically rollover and start counting again at 00000. To obtain the cumulative total of counts after the rollover has occurred, add 65,536 per each rollover (the scanner does not keep track of the number of rollovers) to the current count.

Note: All counter values will be lost if power is recycled to the scanner or the scanner receives a reset or save command.

Clicking Reset for any counter will reset that counter to 0.

Clicking Request for any counter will return the current number for that counter.

## Noread Counter

Clicking Request displays the total number of noreads that have occurred since the last reset.

Associated serial command: **<N>**

## Noread Counter Reset

Clicking Reset sets Noread Counter to 00000.

Associated serial command: **<O>**

## Trigger Counter

Clicking Request displays the total number of triggers since the last reset.

Associated serial command: **<T>**

## Trigger Counter Reset

Clicking Reset sets the trigger counter to 00000.

Associated serial command: **<U>**

## Match Counter (or Good Read Counter)

Clicking Request displays the total number of good reads matching the master label

---

## Chapter 4

or, if Master Label is not enabled, the number of good reads since the last reset. This counter is always enabled, but will only work as a match count when Master Label is enabled. If Master Label is not enabled, this counter records the number of good reads. This count can be requested at any time.

*Associated serial command: <V>*

### Match Counter Reset

Clicking Reset sets the Match Counter to 00000.

*Associated serial command: <W>*

### Mismatch Counter

Clicking Request displays the message the number of labels successfully read that do not match the master label since the last reset.

*Associated serial command: <X>*

### Mismatch Counter Reset

Clicking Reset sets the Mismatch Counter to zero.

*Associated serial command: <Y>*



# Master Label

## Enable Match Code Type

Identical to **"Match Code Type," on page 2-22**. Instructs the scanner to compare bar code labels being scanned with a master label and may under certain conditions send out a relay driver signal and update internal counters.

If no master label has been entered, every decoded label will be a "mismatch" and will increment the mismatch counter by one.

Enable Match Code Type is intended for use when the scanner is in a triggered mode. If the Match Code Type is enabled in the Continuous Read mode, the scanner defaults to Continuous Read 1 Output mode, and the label data must change before the scanner will output data again, unless a timeout, if enabled, occurs. (See **"Operation Menu" on page 2-16**.)

*Associated serial commands:* **<E>**

## Disable Match Code Type

Disables Match Code Type.

*Associated serial commands:* **<F>**

## Store Next Label Scanned as Master Label

If Match Code has been enabled, causes the scanner to read the next bar code label scanned as the master label and stores it in RAM. All subsequently decoded labels are compared against the new master label information. (See **"Match Code Type" on page 2-22**.)

*Associated serial commands:* **<G>**

## Download Master Label Information

Downloads master label information into RAM from the host or a terminal. A stored master label will not affect standard operation unless Match Code Type is enabled.

The Xs denote alphanumeric data, from 1 to 64 characters.

*Associated serial commands:* **< )XXXX >**

### Request Master Label Information

Immediately sends the master label information to the host. To prevent conflicts with outputting label data, first send the <I> command (Disable Laser Scanning (Laser Off)).

*Associated serial commands: <I>*

### Delete Master Label Information

Deletes master label information that has previously been loaded by either <)XXXX)> Download Master Label Information Command or <G> Store Next Label as Master Label command.

*Associated serial commands: <))>*

# Reset

**Important:** All <A> and <Z> commands must be followed by a one second delay before any operations, commands, or reads can be processed.

## Reset

Initializes all serial configuration commands in RAM and resets all counters and operating parameters.

**Note:** Software Reset will reset all counters. You should record all data that you wish to save prior to sending this command.

*Associated serial command:* **<A>**

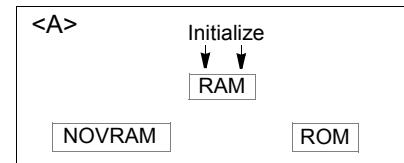

## Reset/Restore Default

Restores the ROM default values to RAM then initializes them. Does not effect Scanner Type, Scans per Second, or Gain Adjustment.

*Associated serial command:* **<Ad>**

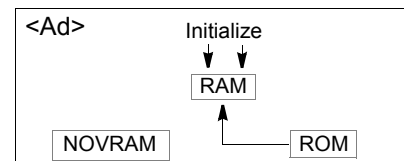

## Reset/Read NOVRAM

Reads the NOVRAM settings then initializes them to RAM.

*Associated serial command:* **<An>**

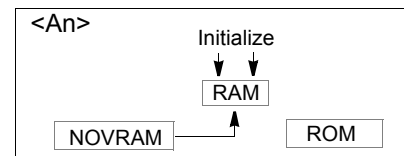

### Reset/Save Parameters for Power-on

Allows you to save all configuration command settings to NOVRAM. Numeric counter values and master label data are not saved by this command.<sup>1</sup>

Associated serial command: **<Z>**

### Restore/Save Default Configuration for Power-on

Allows you to restore and save default settings for all but Scanner Type, Scans per Second, and Gain Adjustment to NOVRAM.

**Note:** Power must be available to the scanner during the default procedure.

Defaulting might be necessary after temporary changes or if communications between the scanner and another device are lost or interrupted, or if you are using incompatible equipment (for example, a terminal is set to communicate at 9600 baud, but the scanner is configured at 38.4K baud).

Associated serial command: **<Zd>**

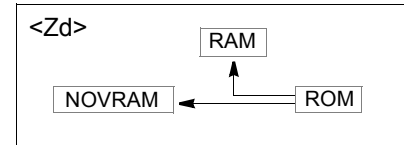

### Save Scanner Type, SPS, and Gain for Power-on

Allows you to save the current settings for Scanner Type,<sup>2</sup> Scans per Second, and Gain Adjustment to NOVRAM. Once you send this command, default values can only be recalled if you reenter them individually and then save them again with this command.

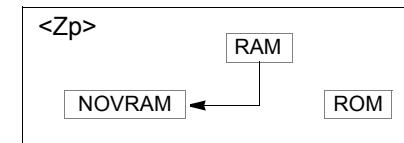

**Important:** This command will replace the optimized factory setting for Gain Adjustment with your new setting; record and save this setting for future reference prior to sending this command.

Associated serial command: **<Zp>**

1. The <Z> Software Reset/Save Parameters for Power-on command can be executed at least 10,000 times. In normal usage this will exceed the life of the scanner. If frequent changes to the operating parameters are required, it is recommended that the <Z> command be used only when the current configuration has been changed and the changes are to be permanent.
2. Scanner Type should not be changed from its factory setting.

# Checksum

## Part Number

Displays software part number.

Associated serial command: **<#>**

## Checksum

Displays a four-digit hex number (corresponding to a given firmware version) used to verify a scanner's EPROM.

Associated serial command: **<!>**

## Show Scanner Status

Used to display certain operating parameters (NOVRAM, command, and operation status). After sending this command, the scanner immediately responds with <X>, where "X" is an ASCII character between @ and Δ on the ASCII table.

Associated serial command: **<?>**

To interpret the scanner's status,

1. Look up the ASCII character's Hex value in the ASCII table on [page A-7](#).

For example, the scanner responds with an <M>, corresponding Hex value is 4D.

2. Refer to [table 4-2](#) to find the Hex value's binary conversion.

The binary bit digits for "4" equal 0100; the binary bit digits for "D" equal 1101. Hence, the binary conversion of 4D is 01001101.

Table 4-2 Hex Value to Binary Conversion

Hex Value Digits	Binary Bit Digits			
	7	6	5	4
0	0	0	0	0
1	0	0	0	1
2	0	0	1	0
3	0	0	1	1
4	0	1	0	0
5	0	1	0	1
6	0	1	1	0
7	0	1	1	1
8	1	0	0	0
9	1	0	0	1
A	1	0	1	0
B	1	0	1	1
C	1	1	0	0
D	1	1	0	1
E	1	1	1	0
F	1	1	1	1

In the example shown in [table 4-3](#), a scanner status request returns an <M> corresponding to 4D hex or 01001101. This means that the scanner's status is even parity, (skip bit location 6; it will always equal 1), with the scanner not in a read cycle, with the motor spinning and the scanner ready to read, with no NOVRAM error detected, with a communications error detected, with the command not received, and with a

3. Compare bit digits with the "Is Status Active?" row in [table 4-3](#) (each bit has a specific meaning)

Table 4-3 Finding Scanner Status from Binary Bit Digits

Binary Code	0	1	0	0	1	1	0	1
Bit Location:	7	6	5	4	3	2	1	0
Scanner Status:	Parity	Always set to 1	Scanner is in a read cycle	Motor is spinning; scanner is ready	NOVRAM error detector	Communication error detected	Command received	Command error detected
Is Status Active?	Yes = 0 = even No = 1 = odd	N/A	1	0	0	1	1	1
		N/A	0	1	1	0	0	0

- a. NOVRAM status is valid only after the first status request following a NOVRAM read or write.

If you send the <?>	The scanner will report:	For example:
After Power-on (NOVRAM Read)	Whether the NOVRAM was read correctly the first time the status command was received.	With the scanner in a triggered mode without a serial or edge trigger present, power-off, then power-on and enter the <?> command. The scanner responds with <@> for a good load or <H> for a bad load. See "NOVRAM error detected" in <a href="#">table 4-3 on page 4-14</a> .
After Sending a Command	Whether the command was sent correctly.	With the scanner in a triggered mode without a serial or edge trigger present, enter the <?> command to clear the error flags. Then enter the desired command, <L1> for example. Enter <?> again. The scanner responds with <B> if the command was received, <C> if there was an error in the command, or <F> if there was a serial data error.
After NOVRAM Write	Whether the NOVRAM was written correctly.	The scanner responds in the same manner as after power-on (NOVRAM read).

### Show Software Status

Sends the following in this order: status byte, part number, ROM checksum for both possible lengths of ROM (1 megabyte and 512 bytes), current NOVRAM checksum, and NOVRAM checksum at power up.

Associated serial command: **<?1>**

# Code Type Commands

(Not in the Utilities Menu.)

## Autodiscriminate All Codes

Enables the scanner to decode all available bar code types without changing scanner configuration settings.

**Note:** For maximum scanning speed, enable only those bar code symbologies used in the application.

*Associated serial command:* **<P>**

## Code 39 Only

Allows only Code 39 labels to be read.

*Associated serial command:* **<Q>**

## Codabar Only

Allows only Codabar labels to be read.

*Associated serial command:* **<R>**

## I 2 of 5 Only

Allows only Interleaved 2 of 5 labels to be read.

*Associated serial command:* **<S>**





# Appendices

## Contents

Appendix A — Scanner Specifications .....	A-2
Appendix B — Electrical Specifications .....	A-5
Appendix C — ASCII Table .....	A-7
Appendix D — Orientation .....	A-8
Appendix E — Defaulting the Scanner .....	A-10
Appendix F — Number of Scans .....	A-11
Appendix G — Troubleshooting .....	A-14
Appendix H — Using the IB-105 .....	A-18
Appendix I — MS-Sensor .....	A-24
Appendix J — Bar Code Symbology .....	A-27
Appendix K — Interface Standards .....	A-28
Appendix L — Multidrop Communications .....	A-29
Appendix M — Glossary of Terms .....	A-32

# Appendix A — Scanner Specifications

## Mechanical -- MS-710

Length: 3.47" (88.1 mm)    Width: 2.59" (65.8 mm)  
 Height: 1.32" (33.5 mm)    Weight: 9 oz. (255 g)

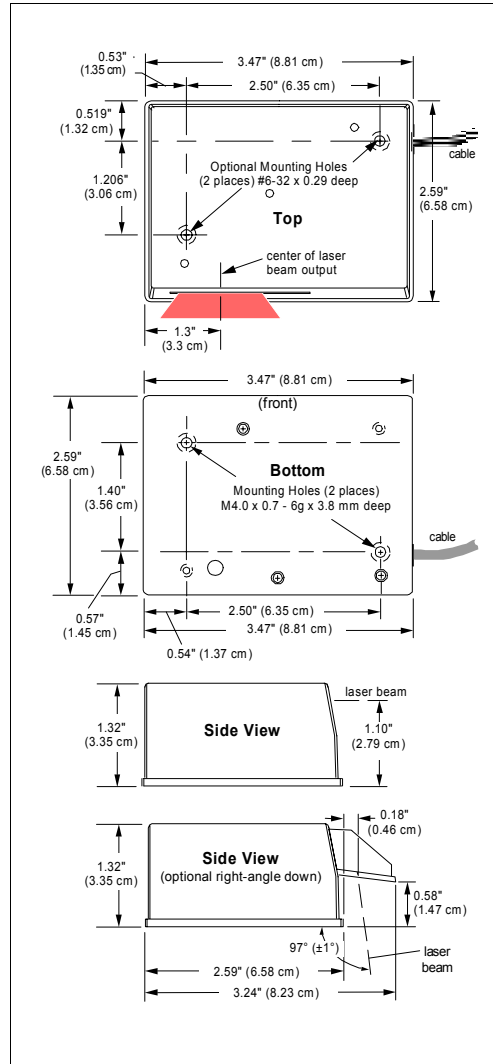

Figure A-1 MS-710 Dimensions

## Light Source

Type: Laser Diode  
 Output Wavelength: 670 nm nominal  
 Safety Class: CDRH Class II  
 Operating Life: 50,000 hours @25°C (10,000 hours @50°C)  
 Laser Cooling: Thermostatically controlled thermocooler

## Scanning Parameters

Primary Mirror Type: Rotating, 10-faceted  
 Scan Rate: 300 to 550 scans per second standard.  
 Scan Width Angle: Typically 60°  
 Optional Raster Mirror Image: 10 raster scan lines over a 2-degree arc (or 0.24 inch raster at 6-inch distance)

Scan Range	Raster Height
2 inches (50.8 mm)	0.10 inch (2.54 mm)
4 inches (101.6 mm)	0.17 inch (4.32 mm)
6 inches (152.4 mm)	0.24 inch (6.1 mm)
8 inches (203.2 mm)	0.31 inch (7.87 mm)
10 inches (254 mm)	0.38 inch (9.65 mm)

## Communications

Interface: RS-232, RS-422, and RS-485  
 Baud Rates: 300, 600, 1200, 2400, 4800, 9600, 19.2K, 38.4K, 76.8K  
 Parity: Odd, Even, None  
 Stop Bits: 1, 2    Data Bits: 7, 8

## Code Types

Code 39, Codabar, Interleaved 2 of 5, UPC/EAN, Code 128  
 Code 16K, UCC/EAN-128, AIAG, Code 49, Code 93, DX Code,  
 EDP & STK/EDP, MSI Code, Pharma Code, Plessey Code,  
 PDF 417

## Protocols

Point-to-Point, Point-to-Point w/RTS/CTS, Point-to-Point  
 w/XON/XOFF, Point-to-Point w/RTS/CTS & XON/XOFF, Polling  
 Mode D, Multidrop, User Defined, User Defined Multidrop.

## Environment

Enclosure: IP54  
 Operating Temperature (inside ambient):  
 32° to 122°F (0° to 50°C)  
 Storage Temperature: -20° to 158°F (-29° to 70°C)  
 Humidity: Up to 90% (non-condensing)  
 Ambient Light Immunity:  
 • 450 foot candles (indoor: fluorescent, incandescent, mercury vapor, sodium vapor)  
 • 1800 foot candles (soft outdoors)

**Status Lights**

LED	Luminance	Status <sup>a</sup>
Power	Red	5V power is present
Ready	Green	Scanner is ready to read
Good Read	Green	Label is qualified as good

<sup>a</sup> In menu status both green lights will flash on and off.

**Optical Characteristics**

Optics: Coaxial

Operating range (depending on label type and size):

High Density: 2 to 4 inches

Low Density: 2 to 10 inches

Right-angle Down: 1 to 8.5 inches

Scan width: 7 inches maximum

Skew: ±40° maximum

Pitch: ±50° maximum

Label contrast: 25% min. absolute dark to light differential at 670 nm wavelength

The table and graphs that follow show scan widths and read range minimum and maximums for several bar code densities.

**Table A-1 Range Data**

Narrow-bar-width	Read Range	Maximum Scan Width <sup>a</sup>
<b>High Density</b>		
.005" (.127 mm)	2 to 3.1" (5.08 to 7.87 cm)	2.1" (5.33 cm)
.0075" (.191 mm)	2 to 4" (5.08 to 10.2 cm)	3.6" (9.14 cm)
<b>Low Density</b>		
.0075" (.191 mm)	2.5 to 5.5" (6.35 to 14.0 cm)	4" (10.2 cm)
.010" (.254 mm)	2 to 6.5" (5.08 to 16.5 cm)	5" (12.7 cm)
.015" (.381 mm)	2 to 7.5" (5.08 to 19.0 cm)	6" (15.2 cm)
.020" (.508 mm)	2 to 10" (5.08 to 25.4 cm)	7" (17.8 cm)
.030" (.762 mm)	2 to 10" (5.08 to 25.4 cm)	7" (17.8 cm)
.040" (1.02 mm)	2 to 10" (5.08 to 25.4 cm)	7" (17.8 cm)
<b>Right-angle Down</b>		
.0075" (.191 mm)	1.25 to 4" (3.18 to 10.2 cm)	4" (10.2 cm)
.010" (.254 mm)	1 to 5" (2.54 to 12.7 cm)	5" (12.7 cm)
.015" (.381 mm)	1 to 6" (2.54 to 15.2 cm)	6" (15.2 cm)
.020" (.508 mm)	1 to 8.5" (2.54 to 21.6 cm)	7" (17.8 cm)
.030" (.762 mm)	1 to 8.5" (2.54 to 21.6 cm)	7" (17.8 cm)
.040" (1.02 mm)	1 to 8.5" (2.54 to 21.6 cm)	7" (17.8 cm)

<sup>a</sup> At 500 decodes per second using Code 39 grade A label.

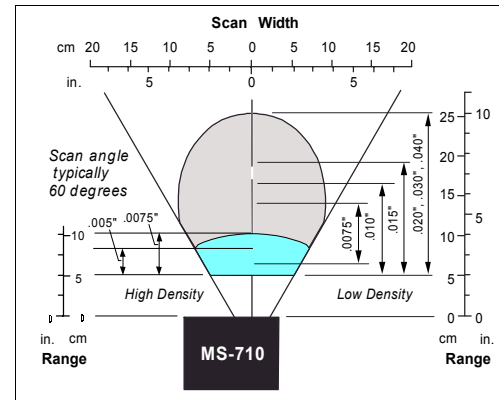

**Figure A-2 Low Density and High Density Scan Range/Width Graph**

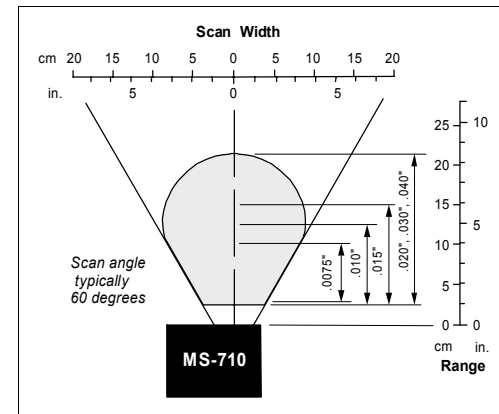

**Figure A-3 Right-angle Down Scan Range/Width Graph**

---

### ***FIS Options***

Each MS-710 model is identified by an FIS (final instruction sheet) number that refer to a set of options. The following are the standard options available at this time:

#### ***Hardware***

- Single line / Raster scanning
- Straight out / Right angle
- Bottom mount / Top mount
- Low density / High density
- RS-232 / RS-422 and RS-485
- Second relay for noread option
- MS-sensor

#### ***Software***

- Wand emulation
- Full ASCII code 39 software
- Code 49 software
- PDF-417
- Extended hold relay
- Photo finishing software
- MSI software
- Long line software
- Long label software
- Plessy code
- Pharma code

## Appendix B — Electrical Specifications

Power Supply Requirements: Input +5 VDC  $\pm$ 4% regulated @ 480 mA with 200 mV p-p max. ripple.

**Table A-2** applies to those FIS options that use RS-232 communications. **Table A-3** applies to those FIS options that use RS-422/485 options. The affected pins are 2, 3, 6, and 10.

*Table A-2 RS-232 15-pin External Cable Connections*

Pin #	Function	Pin #	Function
1	+5 VDC (in)	9	Trigger (in) from 3V to 24V
2	Transmit data (RS-232) (out)	10	CTS (5V only)
3	Receive data (RS-232) (in)	11	NC
4	Signal ground (RS-232)	12	New master
5	NC	13	Chassis ground
6	RTS (5V only)	14	Relay-2 Driver TTL (out). Can sink 10 mA and source 2 mA.
7	Relay-1 Driver TTL (out). Can sink 10 mA and source 2 mA. <sup>a</sup>	15	NC
8	Default configuration (in)		

*Table A-3 RS-422/485 External 15-pin Cable Connections*

Pin #	Function	Pin #	Function
1	+5 VDC (in)	9	Trigger (in) from 3V to 24V
2	RS-422/RS-485 transmit -	10	RS-422/RS-485 receive +
3	RS-422/RS-485 receive -	11	NC
4	Signal ground (RS-232)	12	New master
5	NC	13	Chassis ground
6	RS-422/RS-485 transmit +	14	Relay-2 Driver TTL (out). Can sink 10 mA and source 2 mA.
7	Relay-1 Driver TTL (out). Can sink 10 mA and source 2 mA. <sup>a</sup>	15	NC
8	Default configuration (in)		

<sup>a</sup> MS-710 only: Relay-1 output also causes closure of a relay in the IB-105 box, accessible through pin 15 of the IB-105 host connector (see **Table A-9**).

The MS-710 has a 15-pin internal connector with a standard, hard-wired 3-foot cable terminating in an external 15-pin connector. Connections between the MS-710 and the IB-105 (P/N 99-420001) are shown in **Appendix H on page A-18**. Since +5 VDC power supply is included in the single cabling assembly, the scanner cable should not exceed 3 feet. RS-232 cabling from the 15-pin connector to the host can be up to 47 feet provided it does not include 5 VDC input.

## Ground and Shield Considerations

Proper grounding is necessary for operator safety, noise reduction, and the protection of equipment from voltage transients. Buildings, including any steelwork, all circuits, and all junction boxes must be grounded directly to an earth ground in compliance with local and national electrical codes.

RS-232 signals have a common signal ground (pin 4). Pin 4 is normally connected to pin 13 (chassis ground) in the scanner; however, under certain conditions (e.g., when potential differences exist between power outlet grounds) signal and chassis grounds can be isolated from each other inside the scanner by Microscan technicians.

### Noise Interference

*Noise interference* can be minimized if cabling subject to noise interference is twisted and/or shielded or encased in grounded conduit, and the conduit or shielding ("drain" line) is grounded only to earth ground at one end, as shown in figure A-4. The cable has its shield attached to chassis and DC ground internally.

### Ground Loops

*Ground loops*, signal degradation due to different ground potentials in communicating devices, can be eliminated or minimized by ensuring that both the host, scanner, and their power supplies are connected to a common earth ground.

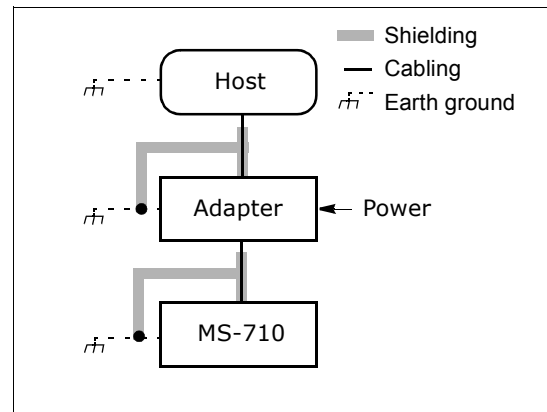

Figure A-4 Grounding Diagram, Scanner-Host

# Appendix C — ASCII Table

Table A-4 ASCII Table with Control Characters

Dec	Hex	Mne	Ctrl	Dec	Hex	Ch	Dec	Hex	Ch	Dec	Hex	Ch
00	00	NUL	^@	32	20	SP	64	40	@	96	60	`
01	01	SOH	^A	33	21	!	65	41	A	97	61	a
02	02	STX	^B	34	22	"	66	42	B	98	62	b
03	03	ETX	^C	35	23	#	67	43	C	99	63	c
04	04	EOT	^D	36	24	\$	68	44	D	100	64	d
05	05	ENQ	^E	37	25	%	69	45	E	101	65	e
06	06	ACK	^F	38	26	&	70	46	F	102	66	f
07	07	BEL	^G	39	27	'	71	47	G	103	67	g
08	08	BS	^H	40	28	(	72	48	H	104	68	h
09	09	HT	^I	41	29	)	73	49	I	105	69	i
10	0A	LF	^J	42	2A	*	74	4A	J	106	6A	j
11	0B	VT	^K	43	2B	+	75	4B	K	107	6B	k
12	0C	FF	^L	44	2C	,	76	4C	L	108	6C	l
13	0D	CR	^M	45	2D	-	77	4D	M	109	6D	m
14	0E	SO	^N	46	2E	.	78	4E	N	110	6E	n
15	0F	SI	^O	47	2F	/	79	4F	O	111	6F	o
16	10	DLE	^P	48	30	0	80	50	P	112	70	p
17	11	DC1	^Q	49	31	1	81	51	Q	113	71	q
18	12	DC2	^R	50	32	2	82	52	R	114	72	r
19	13	DC3	^S	51	33	3	83	53	S	115	73	s
20	14	DC4	^T	52	34	4	84	54	T	116	74	t
21	15	NAK	^U	53	35	5	85	55	U	117	75	u
22	16	SYN	^V	54	36	6	86	56	V	118	76	v
23	17	ETB	^W	55	37	7	87	57	W	119	77	w
24	18	CAN	^X	56	38	8	88	58	X	120	78	x
25	19	EM	^Y	57	39	9	89	59	Y	121	79	y
26	1A	SUB	^Z	58	3A	:	90	5A	Z	122	7A	z
27	1B	ESC	^[	59	3B	;	91	5B	[	123	7B	{
28	1C	FS	^\	60	3C	<	92	5C	\	124	7C	
29	1D	GS	^]	61	3D	=	93	5D	]	125	7D	}
30	1E	RS	^^	62	3E	>	94	5E	^	126	7E	~
31	1F	US	^_	63	3F	?	95	5F	_	127	7F	Δ

## Appendix D — Orientation

If the bar code label bars are parallel to the direction of travel, as shown in figure A-5, the label is said to be in a *ladder* orientation; if the bars are perpendicular with the direction of travel, the label is said to be in a *picket fence* orientation (figure A-6).

### Ladder Orientation

In general, depending on label size and speed, ladder orientation is preferable because different portions of the label are scanned as the label goes by. In addition, label placement is not as critical. As shown in figure A-5, a label can be successfully read if fully placed (including quiet zones) anywhere within the readable portion of the scan line.

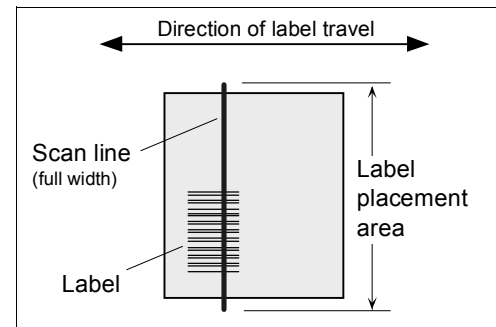

Figure A-5 Ladder Orientation

### Picket Fence Orientation

Unlike ladder, picket fence allows only a small portion of the entire label to be scanned. As a result, labels must be of good quality since even slight label imperfections such as extraneous ink, voids, etc., can cause misreads or non-reads.

One advantage of the picket fence over the ladder orientation is in the area of label speed. In ladder mode, the label travel distance is the height of the bar code; in picket fence mode, the label can be read while it travels the full distance of the scan width.

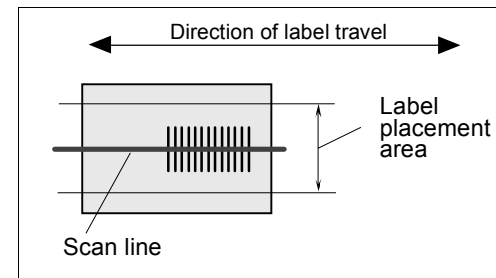

Figure A-6 Picket Fence Orientation

**Note:** Either ladder or picket fence can be rotated without losing its orientation, provided that the label's direction of travel does not change in relation to the scan line.



### Angled Picket Fence Orientation

The problems associated with picket fence can be minimized by slightly tilting the scan line (figure A-7). This allows a larger portion of the label to be scanned and increases the label placement area by “simulating” the ladder orientation. This of course is impractical with a short bar code height.

Angled picket fence is recommended only where the bar code is reasonably tall and the label speed is not too fast in relation to the scan field width, since angling the label will reduce the number of scans on the label.

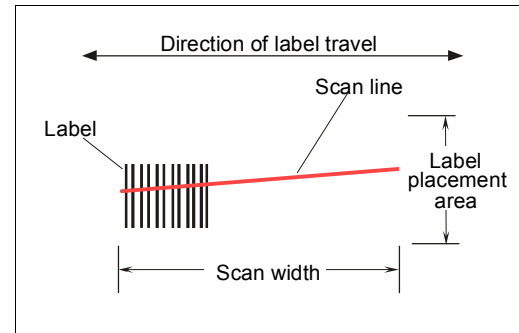

Figure A-7 Angled Picket Fence Orientation

### Object Detector

When an object detector is used, it is set up so that its beam will bounce off the approaching object and the resulting pulse will be sent to the scanner to begin the read cycle. Typically, a detector is positioned so that it will detect the presence of an object before the object's label can be scanned by the scanner.

An object detector is mounted in almost any position relative to the object as long as (1) the object passes within range of the detector and (2) direct or reflected light from the detector does not interfere with the scanner's reception.

As the item continues to move down the line, its label moves into the scanner beam and is read by the scanner.

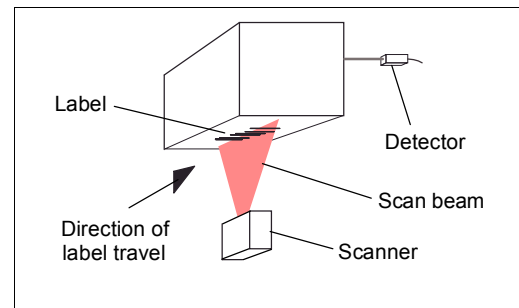
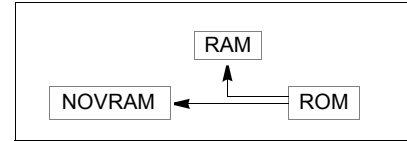

Figure A-8 Detector Orientation

---

## Appendix E — Defaulting the Scanner

Defaulting the scanner resets all scanner configuration parameters except Scanner Type, SPS, and Gain Adjustment to their original default values. These values are saved to NOVRAM for power-on by entering the <Zp> command (Save Scanner Type, SPS, and Gain for Power-on).



Defaulting is necessary if:

- You wish to quickly restore default settings to the configuration program after making some temporary changes.
- Communications between the scanner and another device are interrupted because of incompatible settings (for example, a terminal is set to communicate at 9600 baud, but the scanner is configured at 38.4K baud).
- The scanner has been assigned a polling address and you wish to access the scanner's menu.

**Note:** Power must be available to the scanner during all default procedures.

### Software Default

The software default is done by entering the **<Zd>** (Restore/Save Default Configuration for Power-on) command.

### Hardware Default

If using an IB-105 adapter box, you can default the MS-710 scanner by inserting the end of a straightened paper clip into the IB-105's default switch. (See **"Using the IB-105" on page A-18.**)

1. Connect scanner and IB-105 to host and apply power to the scanner and IB-105.
2. Momentarily insert probe into the IB-105 default switch. Listen for a series of short beeps.
3. Within 3 seconds, pull paper clip out slightly and re-insert. A longer beep should be heard. If not, repeat the process.

## Appendix F — Number of Scans

To ensure reliable scanning, apply a minimum of *five* scans to each label. Use the formulas below to calculate the number of scans that your label will receive. For definitions of terms, see inset on [page A-12](#).

If the number of scans you derive from one of these calculations is less than the minimum for your application, plug in the minimum number of scans (5) and solve for another parameter that might be changed, such as label speed or scans per second.

### Ladder Calculation

$$\left(\frac{LH}{LS} \times SR\right) - 3 = \text{number of complete scans}^1$$

Where LH = Label Height, LS = Label Speed, and SR = Scan Rate.

#### Example 1:

LH = 1 inch

LS = 10 inches per second

SR = 500 scans per second

$$\left(\frac{1}{10} \times 500\right) - 3 = 47 \text{ complete scans}$$

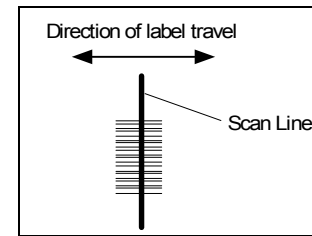

Figure A-9 Ladder Orientation

### Picket Fence Calculation

$$\left(\frac{(SW - LL)}{LS} \times SR\right) - 3 = \text{number of complete scans}^1$$

Where SW = Scan Width, LL = Label Length,

LS = Label Speed and SR = Scan Rate

#### Example 2:

LL = 2 inch (including quiet zones)

LS = 10 inches per second

SW = 8 inches

SR = 500 scans per second

$$\left(\frac{(8 - 2)}{10} \times 500\right) - 3 = 297 \text{ complete scans}$$

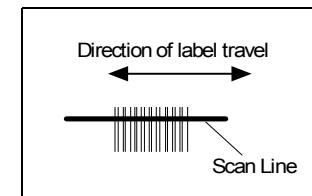

Figure A-10 Picket Fence Orientation

- The -3 component in the formula is included to allow for AGC acquisition, an incomplete first scan, and an incomplete last scan. This applies only if the number inside the parentheses equals 4 or more. If the number equals 3, then only subtract 2 to derive 1 good scan.

## Angled Picket Fence Calculation

The number of complete scans for angled picket fence is calculated the same as that for picket fence, with the exception that the scan width is shortened in proportion to scan tilt.

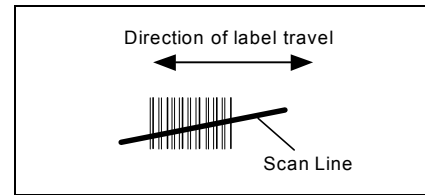

Figure A-11 Angled Picket Fence Orientation

### Definitions

Scan Rate (SR) is the number of scans per second that a given scanner is capable of emitting.

Scan Width (SW) (picket fence formula only) is the width across the scan beam, at a given distance from the scanner, in which a label can be read.

Label Speed (LS) is the distance per second that a label moves as it travels through the scan lines.

Label Length (LL) (picket fence formula only) is the length of the longest printed label to be read plus the length of the quiet zones ([figure A-12](#)).

Label Height (LH) (ladder formula only) is a measurement of the height of individual bars ([figure A-12](#)).

**Note:** Be sure to use a common unit of measurement when gathering data on scan width, label speed, label length, and label height.

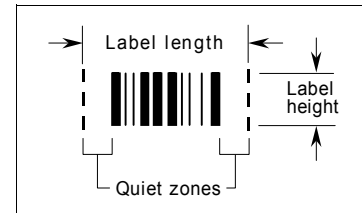

Figure A-12 Label Dimensions

## Improving the Number of Scans

1. After changing any of the parameters described in this section,
2. If applicable, recalculate the number of scans.
3. Repeat **step 9, "Test Decode Rate with Moving Label," on page 1-10.**
4. Compare the new decode rate results with those obtained earlier.

## Scan Rate

Scan rate is a function of motor speed and is adjustable in the Scanner Setup menu from 300 to 550 scans per second. Default speed for both scanners is 500 scans per second. A slower scan rate may allow greater label range and/or higher decode rates, but at the cost of fewer scans per label.

To adjust the scan rate (motor speed), select Scanner Setup menu.

After making changes, repeat **"Number of Scans" on page A-11** and **step 9, "Test Decode Rate with Moving Label," on page 1-10.**

### Range

Adjusting the label's range, if possible, is one of the quickest and most effective ways to improve decode rates. However, in some applications you may need to select a less than optimum range, or one that is beyond the fringes of the ranges listed in **table A-1 on page A-3.**

After making changes, repeat **"Number of Scans" on page A-11** and **step 9, "Test Decode Rate with Moving Label," on page 1-10.**

### Scan Width

Increasing scan width will increase the number of scans in a picket fence oriented application. Scan width is linked with scan range (as shown in **table A-1 on page A-3**) and changing one will usually require a change in the other.

After making changes, repeat **"Number of Scans" on page A-11** and **step 9, "Test Decode Rate with Moving Label," on page 1-10.**

### Label Speed

Applies to both picket fence and ladder oriented labels. If your application allows it, label speed (the time in seconds that a label is fully within the scan width of the scanner) is an effective way to alter the number of scans.

After making changes, repeat **"Number of Scans" on page A-11** and **step 9, "Test Decode Rate with Moving Label," on page 1-10.**

### Label Dimensions, Label Density, and Label Ratio

Not usually an option in most applications, but changes to label parameters can affect number-of-scan calculations and possibly decode rates.

If your application allows it, shortening the length of a picket fence label means the label will be in the scan range longer and hence receive a greater number of scans. Increasing the height of a ladder label means it will receive more scans. Changing label density and/or bar code ratio is another way ranges, decode rates, etc. can be altered.

After making changes, repeat **"Number of Scans" on page A-11** and **step 9, "Test Decode Rate with Moving Label," on page 1-10.**

### Gain and Tracking

These adjustments, typically made by qualified technicians, are done from within the Scanner Setup menu (see **page 2-39**). Changes to tracking will generally have a limited effect on decode rates.

---

## Appendix G — Troubleshooting

### Operational Tips

#### Do:

- Check inputs (label speed, length, height, etc.) to ensure the desired number of scans per label.
- Avoid excessive tilt, pitch, and skew of the bar code label.
- Check the label for readability by doing a decode rate test. If there is any question about the label's readability, contact your Microscan representative.
- After changing any parameter that might affect decode rate, repeat decode rate test.
- Clean the scanner window with a clean, dry Q-tip or cotton cloth on a regular basis.

#### Do Not:

- Aim the scanner into direct light or sunlight.
- Aim the scanner into an external object detector or other light-emitting device.
- Obstruct the scanner window with mounting hardware or other objects.
- Connect chassis of scanner and host to different ground potentials (see **“Electrical Specifications” on page A-5**).
- Operate the scanner in excessive temperature environments (see **“Environment” on page A-2**).

The MS-710 scanner when used correctly should produce good reads. If not, table **A-5** lists some of the more common problems associated with setting up and using the scanner. If you are unable to locate or correct the problem, call your Microscan representative.

#### WARNING

*Do not look directly into laser aperture.  
Laser light can be hazardous to your eyes.*

Table A-5 Troubleshooting

Problem	Possible Cause	Solution
Getting an "Upload from Scanner has timed out!" message when clicking the Receive from Scanner command.	Host cable defective or not wired properly	Check cable connections and wiring. (See <a href="#">"Attach Cabling" on page 1-3.</a> )
	Scanner configuration settings do not match host's	Reset scanner to default and/or match host settings with scanner's. <a href="#">page A-10.</a>
No data or decode rate in decode rate test (<C>)	Wrong label type (different label type being scanned than that enabled in firmware)	Check label configuration settings to be certain that they match the label type being scanned. If label type is in doubt, enable Autodiscriminate All Codes (<P> command). Ensure that fixed length and check sums, if enabled, are set correctly.
	Incorrect label range or label too long to be totally covered by scan beam.	See <a href="#">"Consider Read Range and Scan Width" on page 1-4.</a> Reposition label and check the decode rate.
	Poor label quality	Try a label that is known to be readable.
	Excessive ambient light, sunlight, or strobes	Shield the bar code and/or scan head to verify that excessive light is not the problem.
	Object detector or another scanner interfering with reads	Remedy by remounting, eliminating interference, or shielding.  Many object detectors emit pulsed infrared signals that can seriously degrade the decode rate if they shine into the scanner or onto the bar code label when it is being read.
Low decode rates during decode rate test (<C>)	Poor label, range, placement, etc.	See "No data..." in previous Problem heading. Do <a href="#">step 10 on page 1-11.</a>

Table A-5 Troubleshooting

Problem	Possible Cause	Solution
Decode rate okay but not getting any output (including noreads) in triggered mode	Object detector not positioned properly	Ensure read cycle is active during the time the label is in the scan line.
	End of Read Cycle not properly defined	Ensure that the proper End of Read Cycle is defined in scanner configuration.
	Scanner not triggered when in external mode	Ensure trigger device is operating properly. Do Decode Rate Test <C>. If it reads successfully, the problem is triggering.
	Scanner not triggered when in serial mode	Ensure that correct serial trigger character is entered with start/stop characters (a left angle bracket < (unless redefined) and a right angle bracket >).
	Label misaligned or reflecting direct laser light	Ensure the label is not excessively skewed, tilted, or otherwise disoriented. Ensure the bar code is in the scan line when it is supposed to be. Ensure that the bar code is pitched or skewed slightly so as to avoid specular reflection.
Decode rate okay but getting only noread messages in triggered mode	Triggering/timeout out of sync	Review triggering and timing. (See the Operation menu on <a href="#">page 2-16</a> .)
	Object detector or another scanner interfering with reads	Remedy by remounting, eliminating interference, or shielding. Many object detectors emit pulsed infrared signals that can seriously degrade the decode rate if they shine into the scanner or onto the bar code label when it is being read.
	Window dirty or obstructed	Clean or remove obstruction.
Previous label read, but subsequent label will not read	Scanner configured in Continuous Read 1 Output	Scan a label that contains different data than that of the one being read.
	Scanner in polled mode	Check communications protocol.
Scanner not entering read cycle in triggered mode (trigger not working)	Proper trigger levels not enabled	Ensure that the trigger pulse and the trigger polarity settings are correct.
	Trigger circuit not correctly wired	Ensure that the trigger circuit wiring meets the scanner requirements. (See " <a href="#">Attach Cabling</a> " on <a href="#">page 1-3</a> .)
	Object detector inoperative	Check detector range and sensitivity. Try a detector that is known to be good.



Table A-5 Troubleshooting

Problem	Possible Cause	Solution
MS-sensor displaying incorrect error messages	Reflectance Threshold or Minimum Label Transitions set incorrectly	See <a href="#">"MS-sensor Parameters" on page 2-40</a> . Minimum Label Transitions determines what the sensor will recognize as the lowest setting for a label; therefore, it should be set a few numbers less than the smallest value displayed during the extended decode rate test for an object with a label. Reflectance Threshold compares the reflectivity of empty space versus that of an object; therefore, the object must have a greater reflectivity than empty space for the sensor to respond accurately.
"Bad bar code" message	Poor bar code quality or incorrect label position.	Reposition label or test with a label that is known to be good.
"No bar code" message	No label is present.	See <a href="#">"MS-sensor Parameters" on page 2-40</a> .
"No object" message	No object is present.	See <a href="#">"MS-sensor Parameters" on page 2-40</a> .

# Appendix H — Using the IB-105

P/N: 99-420001

The IB-105 is a separately sold item that provides additional functionality to the MS-710. Specifically:

- Default switch
- RTS/CTS
- New master switch
- Aux port
- A normally open relay
- RS-485 Multidrop
- RS-232/RS-422 Mode switch
- Power switch

The IB-105 is available in five options (see Table [A-11, "IB-105 Options,"](#) on page [A-20](#)).

### **Mechanical**

Length: 4.5 in. (114.3 mm)

Width: 3 in. (76.2 mm)

Height: 1.5 in. (38.1 mm)

### **Communications**

RS-232, RS-422, RS-485

### **Environmental**

Operating Temperature: 0 to 50°C

Humidity: 90% @ 40°C maximum

### **Electrical**

Supply Voltage Input: Regulated +5 VDC @ 20 mA

Maximum ripple: 200 mV p-p with MS-710 +5 VDC @ 500 mA

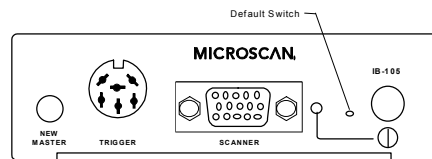
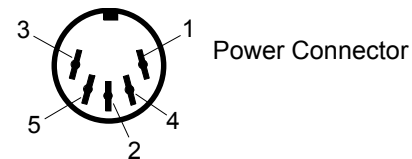
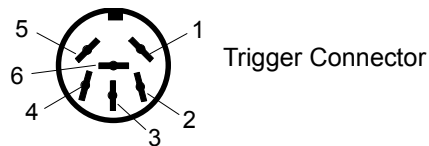

Figure A-13 Front of IB-105

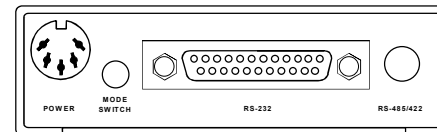

Figure A-14 Back of IB-105

Table A-6 6-pin Trigger Connector

Pin	Function
1	Trigger in to pin 9 of scanner connector
2	Relay contact normally open (up to 1watt)
3	VCC (+5V)
4	VBB (+12V, if using Microscan's standard object detector <sup>a</sup> )
5	Ground
6	Relay common

<sup>a</sup> P/N 99-440001-03

Table A-7 15-pin Scanner Connector

Pin	Function
1	+5 VDC (in)
2	Transmit data (RS-232) (out)
3	Receive data (RS-232) (in)
4	Signal ground (RS-232)
5	NC
6	RTS (5V only)
7	Relay-1 Driver (out). Can sink 10 mA and source 2 mA. <sup>a</sup>
8	Default configuration (in)
9	Trigger (in) from 3V to 24V
10	CTS (5V only)
11	NC
12	New master (in)
13	Chassis ground
14	Relay-2 Driver (out). Can sink 10 mA and source 2 mA.
15	NC

<sup>a</sup> Relay-1 output also causes closure of an isolated relay between pin 15 and pin 17 of the IB-105 host connector.

Table A-8 5-pin Power Connector

Pin	Function
1	Signal ground
2	Chassis ground
3	+5 VDC
4	NC
5	NC

Table A-9 25-pin D-sub Host Connector

Pin	Function
1	Chassis ground
2	Host RS-232 TXD (RS-232)
3	Host RS-232 RXD (RS-232)
4	Host RS-232 RTS or under software control aux RS-232 TXD, or RS-485 transmitter enable (out)
5	Host RS-232 CTS or under software control aux RS-232 RXD (in)
6	Relay-2 output from pin 14 of scanner connector.
7	Signal ground
8	Relay-1 output from pin 7 of scanner connector.
9	VCC (+5V)
10	Trigger input; same as pin 1 of trigger connector
11	Default configuration pin goes to pin 8 of the scanner connector and the default switch
12	NC
13	Host RS-422/RS-485 (+in)
14	Host RS-422/RS-485 (-out)
15	Relay contact normally open (up to 1watt) (common with pin 17)
16	Host RS-422/RS-485 (-in)
17	Relay contact normally open (up to 1watt) (common with pin 15)
18	NC
19	Host RS-422/RS-485 (+out)
20	NC
21	NC
22	Ground
23	NC
24	NC
25	New master input to pin 12 of the scanner connector and new master button

Table A-10 6-pin LAN (RJ11) Connector

Pin	Function
1	Chassis ground
2	RS-422/485 (+in)
3	RS-422/485 (-in)
4	RS-422/485 (+out)
5	RS-422/485 (-out)
6	Chassis ground

Table A-11 IB-105 Options

P/N 99-420001-XX	Description	Internal Dip Switches								
		8	7	6	5	4	3	2	1	
-01	RS-232 with RTS/CTS or RS-485									
-02	RS-232 with RTS/CTS or RS-422									
-03	RS-422 with Aux RS-232 or RS-232									
-04	RS-422 (MS-710) to RS-232									
-05	RS-422 LAN to RS-232 converter									

= ON     = OFF

The IB-105 routes signals between the scanner and other devices. It has the following connectors and switches:

**New Master Switch**

Used in match code operations to indicate that the next label will be read as the new master label. Momentarily press the switch to activate it.

**Trigger Connector**

Connects to an object detector.

**Internal Relay**

The IB-105 uses the scanner’s relay-1 signal to drive a one watt internal relay that connects pin 2 with pin 6 on the trigger connector and pin 15 with pin 17 on the host connector. The relay contacts are closed when relay-1 (pin 7 of the scanner connector) is high. (See tables [A-6](#), [A-7](#), [A-8](#), and [A-9](#) for pinouts.)

These contacts are isolated from ground to prevent unwanted ground currents.

**Default Switch**

Provides a convenient way to restore factory configuration settings to the scanner. This switch is recessed to prevent accidentally defaulting the scanner. For default instructions, see [Appendix E — “Defaulting the Scanner” on page A-10](#).

**Power Switch**

Connects the +5V supply (pin 3 of power connector) to the IB-105.

**Power Connector**

Designed to accept the standard +5V Microscan power supply. Chassis ground must be properly connected for the IB-105 and scanner to pass all regulatory requirements (FCC, CE, CISPER-22).

**Mode Switch**

Used in options -01 and -02 to toggle the host port between RS-232 and RS-485 or between RS-232 and RS-422, respectively. Options -03 and -04 require that the Mode switch be pushed IN for proper operation.

**25-pin (host) Connector**

The 25-pin (host) connector is similar to the MS-3000 host connector; therefore, applications that were set up for the MS-3000 will work with the IB-105. The only exception is the addition of relay contact pins 15 and 17 of the 25-pin host connector that are in parallel with pins 2 and 6 of the trigger connector.

Internally the IB-105 adds RS-232 levels to the RTS and CTS signals on the 25-pin (host) connector. These pins are alternately used for the second RS-232 port depending on the scanner's configuration.

**RS-485/422 (LAN) Connector**

The RS-485/422 (LAN) connector is pinned out the same as the MS-3000 to make it compatible with the Microscan network. See **Table A-10** for pinouts.

**OPTION -01: RS-232 with RTS/CTS to RS-485 or Second RS-232 Serial Port**

Use the Mode switch to toggle the host port between RS-232 and RS-485.

- When the Mode switch is OUT the RS-232 signals go through to the 25-pin (host) connector.

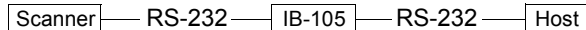

- When this switch is IN the IB-105 takes RS-232 signals (TXD, pin 2, RXD, pin 3) and converts them to RS-485 levels. The RS-485 levels are present at both the RS-485/422 (LAN) connector and the 25-pin (host) connector. (See tables **A-6**, **A-7**, **A-8**, and **A-9** for pinouts.)

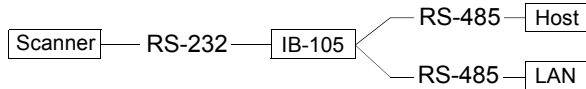

**Note:** In this mode the scanner must be set up for Multidrop communications.

**Note:** The second RS-232 TXD pin (pin 4 of the host connector) is not available in this mode.

### OPTION -02: RS-232/422 with RTS/CTS or Second RS-232 Serial Port

Use the Mode switch to toggle the host port between RS-232 and RS-422.

When the Mode switch is OUT, the RS-232 signals go through to the 25-pin (host) connector.

**Note:** The second RS-232 TXD pin is available in this mode.

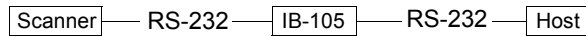

- When the Mode switch is IN, the IB-105 takes RS-232 signals (TXD, RXD) and converts them to RS-422 levels. The RS-422 levels are present at both the RS-485/422

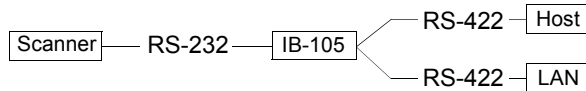

(LAN) connector and the 25-pin RS-232 connector. See [page A-19](#) and [page A-19](#) for pinouts.

### OPTION -03: RS-422 with Second RS-232 Serial Port on Pins 2 and 3

In this configuration the Mode switch must be IN for proper operation.

This mode is the same as option -02 except that the second serial port (aux) is present on pins 2 and 3 of the 25-pin (host) connector. This allows a standard RS-232 cable to connect to the second serial port.

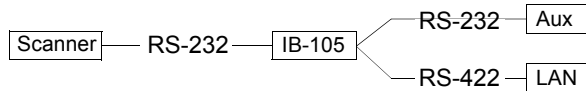

### OPTION -04: RS-422 (MS-710) to RS-232

In this configuration the Mode switch must be IN for proper operation.

This configuration has the same features as the previous configurations except that the Scanner connector pins for TXD, RXD, CTS, RTS are used by the MS-710 for 422 communications. So to connect an RS-232 terminal to the MS-710, the IB-105 con-

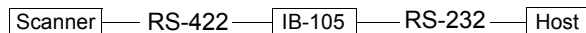

verts these signals to RS-232 levels and back. Pins 2 and 3 on the 25-pin (host) connector are the only communications pins that are active in this configuration.

**OPTION -05: RS-422 LAN to RS-232 Terminal<sup>1</sup>**

In this configuration the Mode switch must be IN for proper operation.  
This is a special configuration to convert RS-422 signals back to RS-232. The main purpose for this configuration is to use two IB-105's, one to convert the scanner communications to RS-422 and one to convert these signals back to RS-232 (this configuration) for long distance communications (up to 4000 feet).

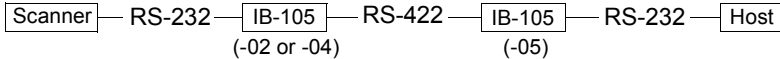

See **Table A-9** and **Table A-10** for pinouts. The LAN cable pinout must be as follows:

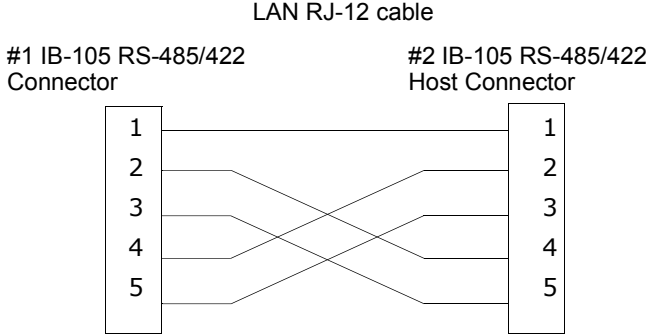

The signal routing is from the LAN connector to the LAN connector. The scanner and trigger connector are not used in this configuration.

1. Access to the configuration menus of a scanner that is in a polled mode can be forced (without defaulting) by sending the <D> command from an auxiliary terminal via the auxiliary RS-232 port.

# Appendix I — MS-Sensor

**Note:** The MS-sensor is an optional FIS feature.

The MS-sensor is a patented specular sensor that interprets reflected light from the laser beam. Once adjusted to your environment, it indicates why the scanner might fail to decode a label within the triggered read cycle and outputs the appropriate message to you. The following three conditions are possible:

- the object's bar code is defective (you receive a bad bar code message)
- there is no bar code on the object (you receive a no bar code message)
- there is no object (you receive a no object message)

To properly configure the MS-sensor, you must first enter the extended decode rate test to view the readouts for reflectance (REF) and transitions (TRANS), the number of label bar and space transitions. These readouts are the basis for configuring Reflectance Threshold and Minimum Label Transitions, which exclusively affect the MS-sensor's operation (see [page 2-40](#) for menu selection or [page 3-20](#) for serial commands).

**Note:** Prior to beginning the extended decode rate test, make sure that the lighting conditions are equivalent to what they will be during normal operations and that the sensor's field of view is clear of all objects that are not to be sensed.

a) To begin the extended decode rate test, enter **<Ce>**.

The extended decode rate test also displays decode rate and label data (if any exists) as well as reflectance and transition readings.

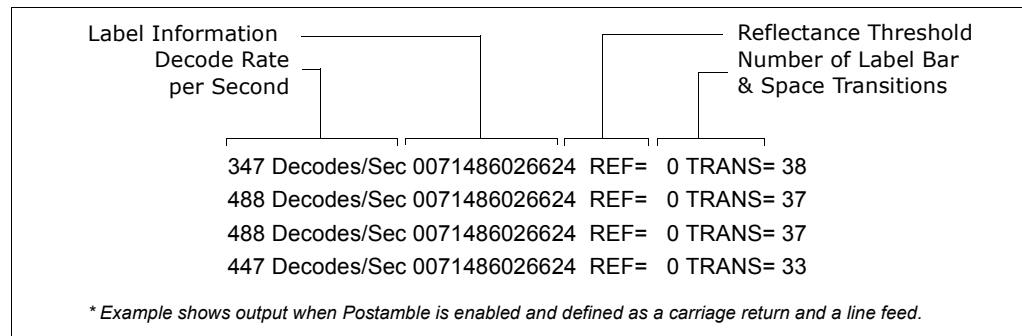

As shown in [figure A-15 on page A-25](#), the results for Minimum Label Transitions and Reflectance Threshold is sensed from directly in front of the scanner at an optimum detection range of 3 inches for diffused objects and 5 inches for specular objects.



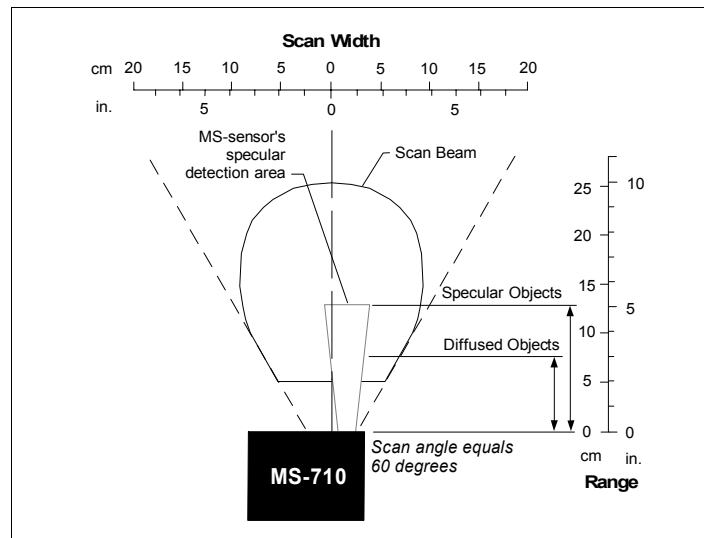

Figure A-15 MS-sensor Range

- b) Determine the setting for Reflectance Threshold (the minimum reflective level at which an object is detected) by selecting a value that is one or two numbers greater than the value posted next to REF when nothing is in the scanner's beam.<sup>1</sup>
- c) Determine the setting for Minimum Label Transitions (each bar and space along a bar code label is counted as a "label transition") by testing the TRANS readout for several objects with labels and then selecting a value that is one or two numbers less than the smallest value that was posted next to TRANS during the test period.
- d) Enter **<J>** to exit the extended decode rate test.
- e) Set Minimum Label Transitions and Reflectance Threshold (see **"Setup Menu" on page 2-38**) to the numbers you have selected during the extended decode rate test.
- f) Activate the triggering event; the scanner will either output the label's data or the sensor will display a message signifying that the bar code label is defective, that no label is present, or that no object is present.

1. Reflectance can also be modified by sending the **<KQoffset>** test command which samples 50 scans for the highest reflectance value and adds a user-defined offset to this value.

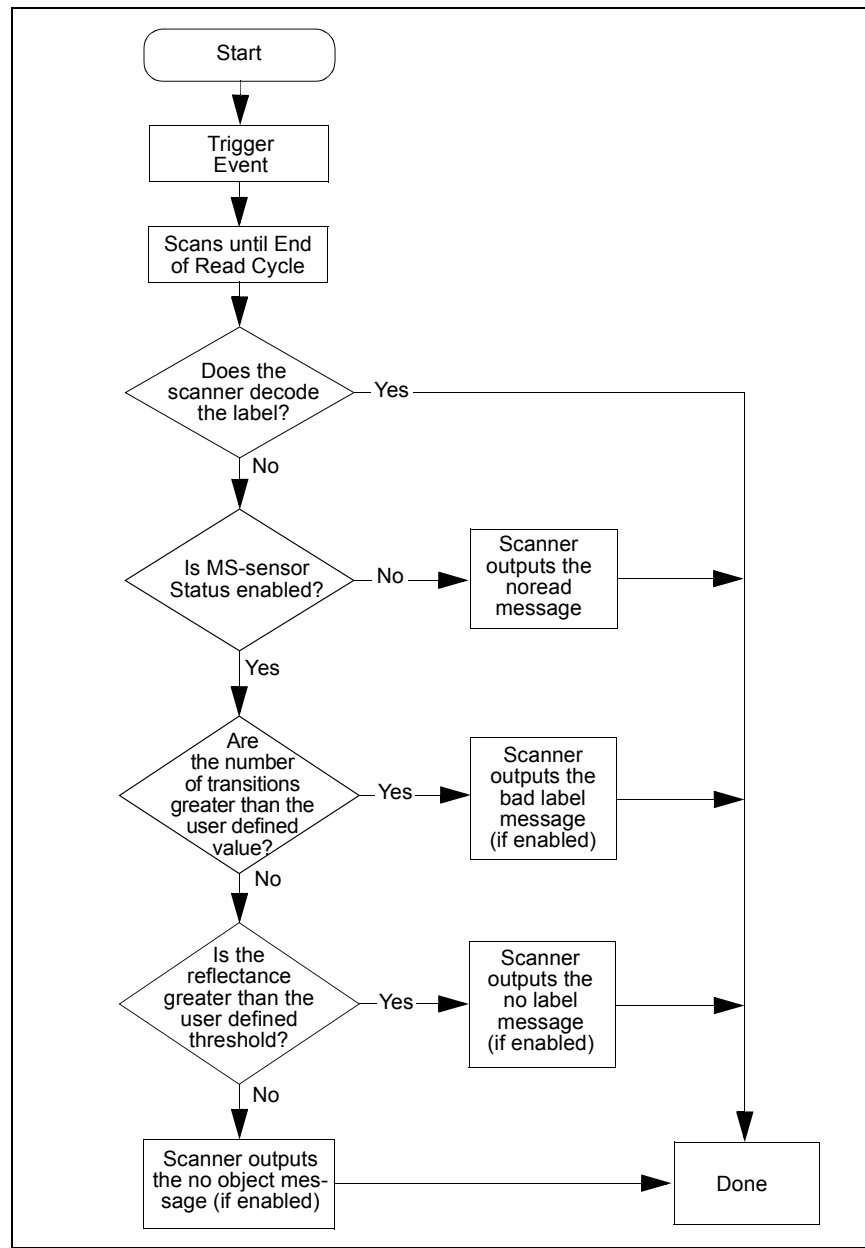

Figure A-16 MS-sensor Flowchart

## Appendix J — Bar Code Symbology

Before choosing a bar code symbol, consider:<sup>1</sup>

- the type of information to be scanned
- the length of the messages to be encoded
- how and where labels are to be applied
- label printer capabilities
- scan speed
- range and beam width
- the space available on the object to be identified
- host software limitations
- the speed of the conveyor

The Standard MS-710 supports the following five bar code symbologies. (Firmware can also be custom ordered to support other symbologies.)

### Code 39

An alphanumeric code with unique start/stop code patterns, composed of nine black and white elements per character, three of which are always wide. Considered the de facto standard for non-retail symbology.

### Codabar

A 16-character set (0 through 9, and the characters \$, :, /, ., +, and -) with start/stop codes and at least two distinctly different bar widths. It is commonly used in libraries, photo finishing, and air parcel express applications. (A check digit is highly recommended.)

### I 2 of 5

Interleaved 2 of 5 is a high-density, continuous numeric symbology used mainly in the distribution industry. I 2 of 5 encodes two digits: one in the bars, and one in the spaces. (A check digit is highly recommended.)

### UPC and EAN

UPC (Universal Product Code) is a fixed length numeric, continuous symbology used in the supermarket and retail industry. The European Article Numbering (EAN) system is a well-known variation of UPC. Both UPC and EAN can have two or five digit supplemental bar code data following the normal code.

### Code 128

A very high density alphanumeric symbology. Will encode all 128 ASCII characters, it is continuous, has variable length, and uses multiple element widths measured edge to edge. It is widely used in the non-food distribution industry and shipping containers.

1. For further information about symbology, see *The Bar Code Book*, by Roger C. Palmer, Helmers Publishing, Inc., 1989.

---

## Appendix K — Interface Standards

Interface Standards, established by the Electronic Industries Association (EIA), specify such things as the signaling voltage levels, maximum cable lengths, and number of drivers. With Microscan devices, selection of interface is made by pin assignment and, in the case of the host communications, by software switching between RS-232 and RS-422. Microscan devices use RS-232, RS-422, and RS-485 multidrop.

### RS-232

RS-232 defines an interface between two devices such as, for example, the scanner and host. It differs from the other interfaces by dedicating individual pins to specific functions and by requiring both devices to share a common ground line. Since both device chassis are connected to a common ground, a ground loop potential and the possibility of noise interference exists. Therefore cable lengths are limited to a maximum of 50 feet (19.7 m). Despite being the most limited, this interface is used frequently because of the large installed base of RS-232 equipment.

### RS-422

RS-422, unlike RS-232, measures signals differentially; that is, the receiver looks at the potentials between the two receive (or transmit) wires rather than the potential between signal and ground. As a result, cables, if shielded, can be up to 4000 feet (1219 m) in length. Like RS-232, RS-422 communication is designed for only two devices on a single line and must have a common ground. It can be used wherever RS-232 is used.

### RS-485

RS-485, like RS-422, can transmit up to 4000 feet (1219 m) using differential voltages but unlike RS-422, its transmitters are turned off until a request for data is received from the host. RS-485 is used exclusively in Multidrop protocol.

**Note:** See ["Protocol Menu," on page 2-12](#) for additional information on standards.

# Appendix L — Multidrop Communications

This appendix describes the rules for setting up a concentrator or controller to communicate with a scanner in standard Multidrop protocol.

The diagram to the right shows a typical Multidrop network in which 1 to 50 scanners can communicate with a host via an intermediary device, a concentrator or a controller.

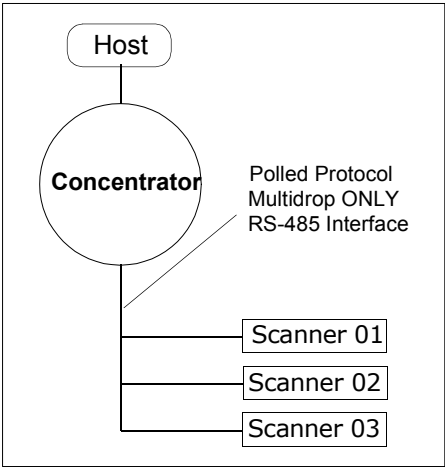

### Polling Sequence

Data that is transmitted to the host (barcode data, noread messages, counters, etc.) via concentrators is solicited by poll requests from the host.

The polling sequence example by poll address 1E (ASCII hex value for Scanner 02) and a REQ (request). The scanner responds by first transmitting its own address, 1E, followed by a STX (start of text) character, and then the data. Next it transmits an ETX (end of text) character and an LRC (longitudinal redundancy check) character.

If the concentrator (or controller) receives the data from the scanner and is able to validate it with an LRC calculation, it responds with an ACK (acknowledgment). If the scanner in turn receives the ACK, the scanner ends this successful exchange with a RES (reset).

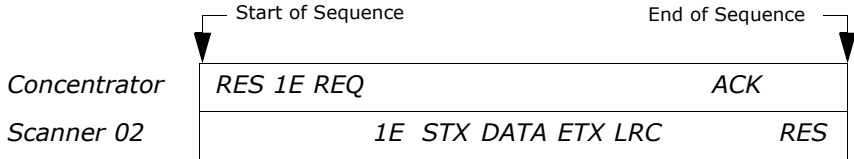

### Polling Reset

- If the scanner has no information, it responds to a poll request by transmitting a RES (reset).
- If the scanner receives a NAK instead of the ACK after transmitting its data string, it will re-attempt to transmit the data string up to three times. If the scanner still does not receive an ACK, it will transmit a RES (reset) and discard the data in its buffers.

- If the scanner transmits data to the concentrator and the concentrator responds with an ACK or NAK, but the scanner doesn't receive the concentrator's response, the scanner will timeout and transmit a REQ to the concentrator and request another response. If after three retries (the number of times it transmits a REQ to the concentrator) the scanner receives no response, it ends the transmission with a RES (reset).

### Select Sequence

Unlike poll requests, select commands always originate from the host and consist of serial configuration or operation commands to devices that are configured in Multi-drop. The scanner complies with the command when it is polled during the cycle.

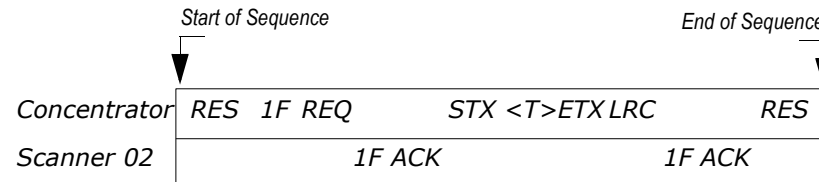

A RES (reset) is the first command in the select sequence. The 1F hex is the select address associated with Scanner 02 address. It is followed by a REQ (request). The scanner responds with its own select address, 1F hex, and an ACK (acknowledge). The concentrator then transmits an STX (start of text), the data (in this case a <T>), an ETX (end of text), and an LRC character.

The scanner replies by transmitting its own address, followed by an ACK, acknowledging receipt of the command. Upon receipt of an ACK, the concentrator concludes the successful exchange with a RES.

In the example above, the scanner only acknowledges a trigger counter request from the concentrator. It does not respond to the trigger counter request until a subsequent poll. For example, if the scanner's trigger count was 12 at the time the trigger counter request was received, on a subsequent poll it would transmit 02T/00012. (The 02 at the beginning of the string is the scanner's address.)

#### Select Reset

If the scanner receives bad data from the concentrator, it transmits a SEL (its select address) and a NAK to the concentrator. The concentrator re-transmits the data up to three times. The concentrator will end the sequence with a RES (reset) if no ACK is received.

Table A-12 Multidrop Address Characters

Multidrop Address	Poll Character		Select Character		Multidrop Address	Poll Character		Select Character	
	ASCII	HEX	ASCII	HEX		ASCII	HEX	ASCII	HEX
01	^\ 	1C	^] 	1D	26	N	4E	O	4F
02	^^	1E	^-	1F	27	P	50	Q	51
03	SP	20	!	21	28	R	52	S	53
04	"	22	#	23	29	T	54	U	55
05	\$	24	%	25	30	V	56	W	57
06	&	26	'	27	31	X	58	Y	59
07	(	28	)	29	32	Z	5A	[	5B
08	*	2A	+	2B	33	\	5C	]	5D
09	,	2C	-	2D	34	^	5E	_	5F
10	.	2E	/	2F	35	`	60	a	61
11	0	30	1	31	36	b	62	c	63
12	2	32	3	33	37	d	64	e	65
13	4	34	5	35	38	f	66	g	67
14	6	36	7	37	39	h	68	i	69
15	8	38	9	39	40	j	6A	k	6B
16	:	3A	;	3B	41	l	6C	m	6D
17	<	3C	=	3D	42	n	6E	o	6F
18	>	3E	?	3F	43	p	70	q	71
19	@	40	A	41	44	r	72	s	73
20	B	42	C	43	45	t	74	u	75
21	D	44	E	45	46	v	76	w	77
22	F	46	G	47	47	x	78	y	79
23	H	48	I	49	48	z	7A	{	7B
24	J	4A	K	4B	49		7C	}	7D
25	L	4C	M	4D	50	~	7E	Δ	7F

---

## Appendix M — Glossary of Terms

**Autodiscriminate.** The ability to decode several different bar code symbologies without changing configuration.

**AWG.** Abbreviation for American Wire Gauge. This is a standard measuring system for wire sizes, listed from 0 (biggest) to 40 (smallest). A 26 AWG is equivalent to 0.0159 in. (0.405 mm) in diameter.

**Bar Code.** Data that has been encoded into an array of parallel bars and spaces of varying widths.

**Bar Code Density.** Number of characters per inch or other unit of measure.

**Baud Rate.** The term used to describe the number of discrete signal events per second. In RS-232 and RS-422/485 systems, baud rate is the same as bits per second (bps).

**Code 39.** An alphanumeric bar code with a character set containing a start/stop character, 10 numbers, 26 letters, 6 symbols, and a space. This code is discrete, variable length, and self-checking.

**Configuration.** The method used to change factory default settings for operational features to match a specific application. Configuration can be done through menu selection or with serial commands.

**Connector.** Physical device (plug or socket) on unit or cable to provide in/out connectivity for various circuits and pins.

**Counter.** Memory space provided to keep track of read cycle events.

**Daisy Chain.** Linkage of primary and successive scanners to allow data to be cascaded up to the host via aux port connections.

**Decode Rate.** The number of good reads per second decoded by the scanner.

**Depth of Field.** The distance between the minimum and maximum range in which a scanner can read bar code labels.

**End of Read Cycle.** The time at which the scanner stops expecting label information to decode. This can be caused by a timeout, a trigger event, or a good read.

**Focal Length.** The distance measured from the scanner to the center of the depth of field, or *focal* point.

**Good Read.** The event that occurs when a label's data is accurately scanned and decoded.

**Intercharacter Gap.** The extra space between the last element of one character and the first element of the adjacent character of a specific bar code symbol.

**Label Height.** Regardless of orientation, the measurement taken along the length of a label's individual bars.



**Label Length.** Regardless of orientation, the measurement taken across the label's bars from one end to the other, including the quiet zone.

**Label Speed.** The rate in inches or centimeters per second at which a label moves through the scan beam.

**Label Transitions.** The transition of bars and spaces on a label, used by the MS-sensor to detect the presence of a label on an object.

**Ladder Label Orientation.** A bar code label in which the bars are parallel to the label's direction of travel.

**Match Code.** The ability to compare bar code labels being scanned against a master label that is stored in the memory of the scanner.

**Menu Configuration.** The process of changing factory default settings via a sequence of menus displayed on a terminal monitor.

**Mil.** One thousandths of an inch or 0.0254 mm. In bar-coding, a measurement that identifies a bar code label by the width of its narrowest element.

**Mismatch.** An event that occurs when the scanned bar code label does not match the master label that is stored in the memory of the scanner.

**MS-sensor.** An FIS option that analyzes label bar and space transitions and reflected light to determine why a label was not decoded within the triggered read cycle (bad label, no label, or no object), and displays a message to identify the cause.

**Narrow-bar-width.** The width of the narrowest bar of a given label, expressed in thousands of an inch (or mils).

**Non-volatile RAM (NOVRAM).** Random Access Memory that is available on power-on; that is, after power to the unit has been recycled.

**Noread.** A non-read. A condition that occurs when the scanner is set up to decode labels, and no labels are scanned during the read cycle.

**Number of Scans Calculation.** The number of times a bar code label is scanned by the scanner during one pass through the laser beam.

**Object Detector.** A photo electric device used to sense to presence or absence of an object (also referred to as a package detector).

**Operational Commands.** Serial commands from the host to the scanner that control current operating parameters, counters, master label operations, and program management that are not stored in non-volatile RAM.

**Picket Fence Label Orientation.** A bar code label in which the bars are perpendicular to the label's direction of travel.

**Pitch.** Label (or scanner) rotation around the center a line perpendicular to the label's bars.

**Point-to-Point.** A protocol consisting of a single communications event, typically used to connect a bar code reader to a terminal or host computer.

**Port.** Logical circuit for data entry and exit. (One or more ports may be included within a single connector.)

**Primary Scanner.** First scanner in a daisy chain mode and linked directly to the host and in tandem to succeeding scanners.

**Protocol.** The rules for communication between devices, providing a means to control the orderly flow of information between linked devices.

**Quiet Zones.** Specified "clear" (nonprinted) areas immediately before and after the bar code symbol. The area is usually white (for black and white bar code) and at least 10 times the width of the narrowest bar, as measured in thousands of an inch. The zones can be other than white as long as their densities remains consistent and they have the required contrast relative to the bars.

**RAM.** (Random Access Memory) Memory that is lost after power is recycled to the unit.

**Read Cycle.** A programmed period of time or condition during which the scanner will accept bar code label input.

**Read Range.** The distances in which a label can be reliably read, as measured from the front of the scanner. See "Depth of Field."

**Reflectance Threshold.** A user-defined setting of reflection (a few digits higher than an empty space reading) that is a point-of-reference for the MS-sensor. A reading lower than the threshold indicates that an object is not present whereas a higher reading indicates the presence of an object.

**Relay Driver.** A TTL signal sent by the scanner. The output is determined by the relay driver selection (by operational command).

**ROM.** (Read Only Memory) Memory that cannot be changed.

**Scanner.** A scanning device that is comprised of a scan head and a decoder integrated in one package.

**Scan Rate.** Number of scans per second that the scanner projects.

**Scan Width.** That portion of the scan line in which a label can be read.

**Serial Commands.** Online data strings (including configuration and operations) from a host or other terminal to the scanner, that are always preceded by a < left angle bracket symbol and followed by a > right angle bracket symbol.

**Serial Configuration** (Host Configuration). Serial command specifically for changing configuration and distinguished from operational command by the fact that they modify the non-volatile for power up configuration.

**Skew.** Label (or scanner) rotation around the center of the skew axis.

**Specular Reflection.** The direct, mirror-like reflection of laser light back to the scanner, causing over-light saturation. For the MS-710 scanner, specular reflection is avoided by skewing or pitching labels slightly.

**Successive Scanner.** Linked to the primary or preceding scanner in a daisy chain mode via its aux port to relay bar code data to the host. See "Daisy Chain."

**Symbology.** A set of bar code symbols, such as Code 39 or Code 128, that have special rules to define the widths and positions of bars and spaces to represent specific numeric or alphanumeric information.

**Tilt.** Label (or scanner) rotation around the centerline of the scan beam.

**Timeout.** A user-selected period of time that ends a scanner's read cycle.

**Wild Card.** User-defined character entered into a master label to permit matches with variable characters.



# Index

## Symbols

# Before Output 2-34

## A

Achtung/Warnung xi  
AGC Sampling 2-39  
Angled Picket Fence Orientation A-9  
Approvals vii  
As Soon As Possible 3-16  
ASCII table (with control characters) A-7  
Auto Baud 1-7, 2-4  
Auto Gain Control 3-19  
Autodiscriminate 3-15  
Autodiscriminate (definition) A-32  
Autodiscriminate All Codes 4-15  
Aux Port Parameters 2-6

## B

Bad Barcode Message 2-41, 3-20  
Bad Barcode Output 2-41  
Bar Code Output 2-34, 3-16  
Baud Rate 2-6, 3-5  
Baud Rates A-2  
Beep on K 2-36  
Beeper 2-35, 3-17  
Beeper Volume 2-35, 3-17

## C

Cable Connections A-5  
Cabling 1-3  
Cabling (ground loops) A-6  
Caution Summary viii  
CDRH x  
CE Konformitätszeichen x  
Check Digit (Codabar) 2-27  
Check Digit (Code 39) 2-25  
Check Digit (I 2 of 5) 2-28  
Check Digit Output (Codabar) 2-27  
Check Digit Output (Code 39) 2-26

Check Digit Output (I 2 of 5) 2-28  
Codabar 2-26, 3-13, A-27  
Codabar Only 4-15  
Code 128 2-30, 3-14, A-27  
Code 39 2-25, 3-13, A-27  
Code 39 Only 4-15  
Code Length #1 (I 2 of 5) 2-28  
Code Length #2 (I 2 of 5) 2-28  
Code Length (Codabar) 2-27  
Code Length (Code 128) 2-30  
Code Length (Code 39) 2-26  
Code Type A-2  
Code Type Menu 2-25  
Code Types Commands 4-15  
Code Types Status Request 3-15  
Communications 1-7, 3-5, A-2  
Communications (loss of) 2-4  
Communications Menu 2-5  
Configuration File 2-3  
Configure 1-8  
Continuous Read 2-16, 3-10  
Continuous Read 1 Output 2-17, 3-10  
Control Character Output (Echo K) 2-36  
Counters 4-7  
Creating a New Configuration File 2-3  
cUL x

## D

Daisy Chain ID 2-11  
Daisy Chain Mode 2-10  
Data Bits 2-6, 3-5  
Decode Rate 1-9  
Decode Rate Test (multi-label) 4-3  
Decodes/Second Test (single label) 4-3  
Default A-10  
Default Settings 2-3  
Defaulting the Scanner 3-4, 4-12, A-10  
Delete Master Label Information 4-10  
DTE Host Connection 1-3

**Index****E**

EAN 2-29, 3-14  
 Echo K Command 2-36  
 Edge 2-18  
 Electrical Specifications A-5  
 End of Read Cycle 2-18, 3-10, 3-16  
 End Read Rate Test 4-4  
 ESP (using) 2-2  
 Extended Decode Rate Test A-24  
 Extended Mode 4-4  
 External Edge 2-18, 3-10  
 External Level 2-17, 3-10  
 External Trigger Level 3-11

**F**

Factory Settings 2-39  
 FCC x  
 FIS (final instruction sheet) A-4  
 Fixed Code Length (Codabar) 2-27  
 Fixed Code Length (Code 128) 2-30  
 Fixed Code Length (Code 39) 2-26  
 From Host 2-14  
 Full Duplex Mode 2-9

**G**

Gain A-13  
 Gain Adjustment 2-39, 3-19  
 Glossary A-32  
 Good Decode Reads 2-21, 3-11  
 Good Read Counter 4-7  
 Grounding A-6

**H**

Half duplex 3-5  
 Half Duplex Mode 2-8  
 Hardware Default A-10  
 High Density A-3  
 Host Port 2-5, 3-5

**I**

I 2 of 5 3-14

I 2 of 5 Only 4-15  
 IB-105 A-18  
 Intercharacter Delay 2-15, 3-9  
 Intercharacter Gap (definition) A-32  
 Interface A-2  
 Interface Standards A-28  
 Interleaved 2 of 5 2-28, 3-14, A-27

**K**

K Command Options 2-36

**L**

Label density A-13  
 Label dimensions A-13  
 Label height A-12  
 Label length A-12  
 Label ratio A-13  
 Label Speed A-13  
 Label speed A-12  
 Ladder Orientation A-8  
 Large Intercharacter Gap (Codabar) 2-27  
 Large Intercharacter Gap (Code 39) 2-26  
 Laser On/Off 2-35, 3-17  
 Laser Scanning (enable/disable) 4-6  
 Level 2-17  
 Light Source specifications A-2  
 Longitudinal Redundancy Check 2-15, 3-8  
 Loss of communications 3-4  
 Low Density A-3

**M**

Master Label 4-9  
 Match Code 2-22, 3-11, 4-9  
 Match Code (definition) A-33  
 Match Counter 4-7  
 Match Length 2-24  
 Match Start Position 2-23  
 Matchcode Master 2-23  
 Mechanical specifications A-2  
 Menu Configuration Program (about) 2-2  
 Minimum Label Transitions 2-40  
 Mirror Type A-2

Mismatch Counter 4-8  
 Modulus 43 2-25  
 Motor Off 4-6  
 Motor On 4-6  
 MS-sensor 2-40, 3-20, A-24  
 MS-sensor (definition) A-33  
 Multidrop 2-13, 3-6  
 Multidrop Addresses 2-14  
 Multidrop Communications A-29  
 Multi-label Decode Rate Test 4-3  
 Multi-label Percent Test 4-3  
 Multilabel Separator 2-22, 3-12

**N**

Narrow Margins 2-30, 3-15  
 New Master Pin 2-21, 3-12  
 New Trigger 2-19, 3-10  
 No Barcode Message 2-41  
 No Barcode Output 2-41, 3-21  
 No Object Message 2-41, 3-21  
 No Object Output 2-41  
 Noise Interference A-6, A-28  
 Noread Counter 4-7  
 Noread Message 2-35  
 Noread Output 2-35, 3-17  
 Number of Labels 2-21, 3-12  
 Number of Scans 1-11, A-11  
 Number of scans calculation A-11  
 Number of Transistions 3-20

**O**

Operating Environment A-2  
 Operating Life A-2  
 Operation Commands 3-10  
 Operation Menu 2-16  
 Operations Status Request 3-12  
 Optical Characteristics A-3  
 Output Menu 2-32  
 Output On 2-33, 3-16  
 Output-1 4-6  
 Outputs 2-32

**P**

Parity 2-6, 3-5  
 Partial Length (Partial Output) 2-37  
 Partial Output 2-37, 3-17  
 Percent Test (percent test) 4-3  
 Percent Test (single label) 4-3  
 Picket Fence Orientation A-8  
 Pitch 1-5  
 Point-to-Point 2-12, 3-6  
 Point-to-Point with RTS/CTS 2-12, 3-6  
 Point-to-Point with RTS/CTS & XON/XOFF 2-13, 3-6  
 Point-to-Point with XON/XOFF 2-13  
 Polarity 2-33, 3-16  
 Polling Mode D 2-13, 3-6  
 Polling Sequence A-29  
 Postamble 2-15, 3-8  
 Power Supply Requirements A-5  
 Preamble 2-14, 3-8  
 Protocol 3-5, A-2  
 Protocol Commands 3-8  
 Pulse Width 2-33, 3-16

**Q**

Quiet Zones 2-30

**R**

Range A-13  
 Raster Height A-2  
 Raster Mirror A-2  
 Read Range 1-4  
 Read Rate 4-3  
 Receiving Settings 2-3  
 Reflectance Setup Test 3-20  
 Reflectance Threshold 2-40, 3-20, A-25  
 Relay Pulses 2-32  
 Relay-1 2-32, 3-16  
 Relay-2 3-16  
 Relay-2 (Output) 2-32  
 Request Master Label Information 4-10  
 Reset 4-11

**Index**

Reset/Read NOVRAM 4-11  
 Reset/Restore 4-11  
 Reset/Save Parameters for Power-on 4-12  
 Response Timeout 2-15, 3-9  
 Restoring Default Settings 2-3  
 Right-angle Down Scan Range/Width Graph A-3  
 RS-232 A-28  
 RS-232 15-pin External Cable Connections A-5  
 RS-422 A-28  
 RS-422/485 External 15-pin Cable Connections A-5  
 RS-485 A-28

**S**

Safety Class A-2  
 Safety Labels ix  
 Save Scanner Type, SPS, and Gain for Power-on 4-12  
 Saving Settings 2-3  
 Scan Range/Width Graph A-3  
 Scan Rate A-2, A-12  
 Scan Rate definition A-12  
 Scan Width A-13  
 Scan width 1-4  
 Scan Width Angle A-2  
 Scan Width definition A-12  
 Scanner 4-6, 4-12  
 Scanner Output 3-16  
 Scanner Output Status Request 3-18  
 Scanner Setup 3-18  
 Scanner Setup Commands 3-19  
 Scanner Setup Status Request 3-21  
 Scanner Type 2-39, 3-19  
 Scanning Parameters A-2  
 Scanning System 1-2  
 Scans per Second 2-39, 3-19  
 Select Sequence A-30  
 Separator 3-14  
 Separator (UPC/EAN) 2-30  
 Sequential 2-23

Sequential Matching 2-23  
 Serial Command Status Request 3-4  
 Serial Commands (concatenating) 3-4  
 Serial Commands (format) 3-3  
 Serial Commands (initializing changes) 3-4  
 Serial Configuration Table 3-2  
 Serial Data 2-18, 3-10  
 Serial Data & Edge 2-18, 3-10  
 Serial Trigger Character 2-20, 3-10  
 Setup Menu 2-38  
 Shielding A-6  
 Show Software Status 4-14  
 Sicherheitshinweis x  
 Skew 1-5  
 Specifications (general) A-2  
 Specular reflection 1-5  
 Start & Stop Match (Codabar) 2-26  
 Start & Stop Output (Codabar) 2-27  
 Start Position (Partial Output) 2-37  
 Static Label 1-9  
 Status Lights A-3  
 Stop Bits 2-6, 3-5  
 Supplementals 2-29, 3-14  
 Symbology A-27  
 Symbology ID 2-31, 3-15

**T**

Tilt 1-5  
 Timeout 2-19  
 Timeout & New Trigger 2-19, 3-10  
 Timeout (end of read cycle option) 2-19, 3-10  
 Timeout in 10 ms incs 3-10  
 Tracking A-13  
 Transparent 3-5  
 Transparent Mode 2-7  
 Trigger 4-5  
 Trigger Counter 4-7  
 Trigger Filter Timing Value 2-20  
 Trigger Polarity 2-20  
 Triggering Mode 2-16, 3-10  
 Troubleshooting A-14  
 TÜV x



**U**

- UL x
- UPC/EAN 2-29, 3-14, A-27
- User Defined 2-13, 3-6
- User Defined Multidrop 2-14, 3-6

**V**

- Vorsichtsmaßnahmen x

**W**

- Warning Summary viii
- Warnung xi
- Warranty Information ii
- Wavelength A-2
- When to Output 2-34, 3-16
- Wild Card 2-23
- Wild Card Character 2-24