



**Intermec**



User's Manual

**CN2G Handheld  
Computer**

Intermec Technologies Corporation

Corporate Headquarters  
6001 36th Ave. W.  
Everett, WA 98203  
U.S.A.

[www.intermec.com](http://www.intermec.com)

The information contained herein is proprietary and is provided solely for the purpose of allowing customers to operate and service Intermec-manufactured equipment and is not to be released, reproduced, or used for any other purpose without written permission of Intermec.

Information and specifications contained in this document are subject to change without prior notice and do not represent a commitment on the part of Intermec Technologies Corporation.

© 2004 by Intermec Technologies Corporation. All rights reserved.

The word Intermec, the Intermec logo, Norand, ArciTech, CrossBar, Data Collection Browser, dcBrowser, Duratherm, EasyCoder, EasyLAN, Enterprise Wireless LAN, EZBuilder, Fingerprint, i-gistics, INCA (under license), InterDriver, Intermec Printer Network Manager, IRL, JANUS, LabelShop, Mobile Framework, MobileLAN, Nor\*Ware, Pen\*Key, Precision Print, PrintSet, RoutePower, TE 2000, Trakker Antares, UAP, Universal Access Point, and Virtual Wedge are either trademarks or registered trademarks of Intermec Technologies Corporation.

Throughout this manual, trademarked names may be used. Rather than put a trademark (™ or ®) symbol in every occurrence of a trademarked name, we state that we are using the names only in an editorial fashion, and to the benefit of the trademark owner, with no intention of infringement.

# Contents

Before You Begin .....	vii
Safety Summary .....	vii
Safety Icons .....	viii
Global Services and Support .....	viii
Who Should Read This Document? .....	ix
Related Documents .....	ix
Patent Information .....	ix
Other Copyright Information .....	x

<b>1</b> Using the CN2G Handheld Computer .....	1
Introducing the CN2G Handheld Computer .....	2
Using the Battery .....	3
Installing and Charging the Battery .....	4
Maximizing Battery Life .....	5
Checking the Battery Status .....	6
Using the Keypad .....	6
Using the Touch Screen .....	8
Using the Touch Screen and Stylus .....	8
Understanding the Desktop .....	9
Using ScanDemo .....	9
Using Transcriber .....	10
Understanding the Screen Icons .....	12
Calibrating the Screen .....	12
Understanding the Status Lights .....	13
Understanding the Beeps .....	14
Scanning Bar Codes .....	14
Using the SD Card .....	16

**Contents**

<b>2</b>	<b>Configuring the CN2G</b> .....	19
	How to Configure the CN2G Parameters.....	20
	Configuring the CN2G With the Setup Assistant.....	21
	Configuring the CN2G Locally With Intermec Settings.....	22
	Restoring Default Settings.....	24
	Exiting Intermec Settings.....	25
	Configuring the CN2G Remotely With Intermec Settings.....	25
	Configuring the CN2G For Your Network.....	26
	Configuring USB Communications.....	26
	Configuring 802.11b Radio Communications.....	27
	Configuring the Network Parameters for a TCP/IP Network.....	28
	Configuring the Network Parameters for a UDP Plus Network.....	30
	Configuring Security.....	31
	Using Funk Security.....	32
	Selecting Funk as Your Security Choice.....	32
	Selecting a Profile for Funk Security.....	33
	Using WPA Security.....	34
	Configuring WPA Security With Funk Security.....	35
	Configuring WPA Security With Microsoft Security.....	37
	Using 802.1x Security.....	39
	Configuring 802.1x Security With Funk Security.....	40
	Configuring 802.1x Security With Microsoft Security.....	41
	Using LEAP Security.....	42
	Using Static WEP Security.....	43
	Configuring Static WEP Security With Funk Security.....	44
	Configuring Static WEP Security With Microsoft Security.....	44
	Loading a Certificate.....	45
	Disabling Security.....	48
<b>3</b>	<b>Developing and Installing Applications</b> .....	49
	Developing Applications for the CN2G.....	50
	Developing a New Application.....	50
	Developing a Web-Based Application.....	51
	Installing Applications on the CN2G.....	51
	Installing Applications Using ActiveSync.....	52
	Installing ActiveSync and Establishing a Partnership.....	52
	Using ActiveSync to Copy Files and Install Applications.....	54
	Installing Applications Using Your SD Card.....	56
	Installing Applications Using Wavelink Avalanche.....	56

**Contents**

Launching Your Application Automatically ..... 57

Upgrading Your CN2G ..... 57

    Upgrading the Operating System..... 57

        Upgrading the Operating System Using an SD Card.....57

        Upgrading the Operating System Remotely Using Intermec  
        Settings .....59

    Upgrading the Persistent Storage Manager Files..... 60

**4 Troubleshooting and Maintaining the CN2G ..... 63**

Problems and Solutions ..... 64

    Problems While Operating the CN2G ..... 64

    Problems While Configuring Security ..... 65

    Problems With Wireless Connectivity ..... 67

    Problems While Scanning Bar Codes..... 68

Booting the CN2G..... 70

    Warm Booting the CN2G..... 70

    Cold Booting the CN2G ..... 71

    Cleaning the Scanner Window and CN2G Screen..... 72

**A Appendix ..... 73**

Physical and Environmental Specifications..... 74

Accessories for the CN2G..... 75

Default Configuration ..... 76

**I Index ..... 79**

## **Contents**

## **Before You Begin**

This section provides you with safety information, technical support information, and sources for additional product information.

### **Safety Summary**

Your safety is extremely important. Read and follow all warnings and cautions in this document before handling and operating Intermec equipment. You can be seriously injured, and equipment and data can be damaged if you do not follow the safety warnings and cautions.

#### **Do Not Repair or Adjust Alone**

Do not repair or adjust energized equipment alone under any circumstances. Someone capable of providing first aid must always be present for your safety.

#### **First Aid**

Always obtain first aid or medical attention immediately after an injury. Never neglect an injury, no matter how slight it seems.

#### **Resuscitation**

Begin resuscitation immediately if someone is injured and stops breathing. Any delay could result in death. To work on or near high voltage, you should be familiar with approved industrial first aid methods.

#### **Energized Equipment**

Never work on energized equipment unless authorized by a responsible authority. Energized electrical equipment is dangerous. Electrical shock from energized equipment can cause death. If you must perform authorized emergency work on energized equipment, be sure that you comply strictly with approved safety regulations.

## Before You Begin

### Safety Icons

This section explains how to identify and understand warnings, cautions, and notes that are in this document.



**A warning alerts you of an operating procedure, practice, condition, or statement that must be strictly observed to avoid death or serious injury to the persons working on the equipment.**



**A caution alerts you to an operating procedure, practice, condition, or statement that must be strictly observed to prevent equipment damage or destruction, or corruption or loss of data.**



**Note:** Notes either provide extra information about a topic or contain special instructions for handling a particular condition or set of circumstances.

## Global Services and Support

### Warranty Information

To understand the warranty for your Intermec product, visit the Intermec web site at [www.intermec.com](http://www.intermec.com) and click **Service & Support > Service & Support**. The **Intermec Global Sales & Service** page appears. From the **Service & Support** menu, move your pointer over **Support**, and then click **Warranty**.

Disclaimer of warranties: The sample code included in this document is presented for reference only. The code does not necessarily represent complete, tested programs. The code is provided “as is with all faults.” All warranties are expressly disclaimed, including the implied warranties of merchantability and fitness for a particular purpose.

### Web Support

Visit the Intermec web site at [www.intermec.com](http://www.intermec.com) to download our current manuals in PDF format. To order printed versions of the Intermec manuals, contact your local Intermec representative or distributor.



## **Before You Begin**

Visit the Intermec technical knowledge base (Knowledge Central) at [intermec.custhelp.com](http://intermec.custhelp.com) to review technical information or to request technical support for your Intermec product.

### **Telephone Support**

You can find information on Intermec telephone support services at [www.intermec.com/AIT](http://www.intermec.com/AIT). To find the correct telephone support number for your country, click **Contact**.

## **Who Should Read This Document?**

The *CN2G Handheld Computer User's Manual* provides you with information about the features of the CN2G and how to install, operate, maintain, and troubleshoot the CN2G. Before you install and configure the CN2G, you should be familiar with your network and general networking terms, such as IP address.

The *Intermec Computer Command Reference Manual* (P/N 073529) is available as a download from the Intermec web site. Please refer to this manual for help configuring your CN2G. The reference manual contains information about most of the CN2G commands.

## **Related Documents**

The Intermec web site at [www.intermec.com](http://www.intermec.com) contains our documents that you can download as PDF files.

To order printed versions of the Intermec manuals, contact your local Intermec representative or distributor.

## **Patent Information**

Product is covered by one or more of the following patents:  
4,455,523; 5,627,360; 4,553,081; 5,657,317; 4,709,202; 5,671,436;  
4,845,419; 5,684,290; 4,961,043; 5,777,309; 5,195,183; 5,793,604;  
5,216,233; 5,805,807; 5,218,187; 5,818,027; 5,218,188; 5,821,523;  
5,227,614; 5,828,052; 5,241,488; 5,831,819; 5,278,487; 5,834,753;  
5,322,991; 5,841,121; 5,331,136; 5,844,222; 5,331,580; 5,883,492;  
5,349,678; 5,883,493; 5,397,885; 5,886,338; 5,371,858; 5,889,386;  
5,373,478; 5,898,162; 5,410,141; 5,969,328; 5,488,575; 5,986,435;  
5,500,516; 6,075,340; 5,504,367; 6,109,528; 5,508,599; 6,158,661;

### **Before You Begin**

5,530,619; 6,234,395; 5,567,925; 6,244,512; 5,568,645; 6,330,975;  
5,592,512; 6,431,451; 5,598,007, 6,497,368; 5,617,343; 6,538,413.

There may be other U.S. and foreign patents pending.

### **Other Copyright Information**

Microsoft, Windows, and the Windows logo are registered trademarks of Microsoft Corporation in the United States and/or other countries.

Wi-Fi is a registered certification mark of the Wi-Fi Alliance.

This product includes software developed by the OpenSSL Project for use in the OpenSSL Toolkit. ([www.openssl.org/](http://www.openssl.org/))

This product includes cryptographic software written by Eric Young. ([ey@cryptsoft.com](mailto:ey@cryptsoft.com))

This product uses Regex++, Index software during its operational phases. The owner of Regex++ has granted use of the software to anyone provided such use is accompanied by the following copyright and permission notice:

#### **Regex++, Index. (Version 3.31, 16th Dec 2001)**

Copyright © 1998-2001 Dr John Maddock

Permission to use, copy, modify, distribute and sell this software and its documentation for any purpose is hereby granted without fee, provided that the above copyright notice appear in all copies and that both that copyright notice and this permission notice appear in supporting documentation. Dr John Maddock makes no representations about the suitability of this software for any purpose. It is provided “as is” without express or implied warranty.



# **1 Using the CN2G Handheld Computer**

Use this chapter to familiarize yourself with the CN2G Handheld Computer. In this chapter you will find these sections:

- Introducing the CN2G Handheld Computer
- Using the Battery
- Using the Keypad
- Using the Touch Screen
- Understanding the Status Lights
- Understanding the Beeps
- Scanning Bar Codes
- Using the SD Card

## Introducing the CN2G Handheld Computer

The Intermec CN2G Handheld Computer is an ergonomically-designed handheld computer built on the Microsoft® Windows® CE .NET operating system. It is a semi-rugged, lightweight computer that runs client/server applications and browser-based applications.



**CN2G Handheld Computer**



The CN2G Handheld Computer with an IEEE 802.11b radio installed is Wi-Fi® certified for interoperability with other 802.11b wireless LAN devices.

The CN2G includes these features:

- 802.11b radio
- .NET Compact Framework
- Internet Explorer 6
- CCX v1.0 compliance
- IPv6 support
- Color display with touch screen
- 1D linear imager
- 64MB flash/128MB RAM memory
- 400 MHz processor

For a complete list of accessories, see “Accessories for the CN2G” on page 75.

## Using the Battery

The CN2G uses a lithium-ion battery as its main power source. You must fully charge the main battery before you can use the CN2G. When you change the battery, the backup battery maintains the computer’s status, memory, and real-time clock for at least 5 minutes.



Warning

**The lithium-ion battery pack that is used in this device may present a fire or chemical burn hazard if it is mistreated. Do not disassemble it, heat it above 100°C (212°F), or incinerate it.**



Caution

**Removing the main battery when the backup battery low or critically low icon appears on the status bar may cause your CN2G to cold boot and you may lose data.**



Caution

**If you fail to replace the battery immediately, you may lose important data or applications.**

Dispose of used battery packs promptly. Keep away from children. Contact your local Intermec sales representative for replacement batteries.

## Chapter 1 — Using the CN2G Handheld Computer

Several factors determine the life of your battery such as extreme temperatures and your usage.

### Installing and Charging the Battery

Make sure you fully charge the battery before you use your CN2G. To charge the battery, you need to install it in the CN2G.

#### To install and charge the battery

- 1 Push down on the battery door latch, and pull up on the battery door.

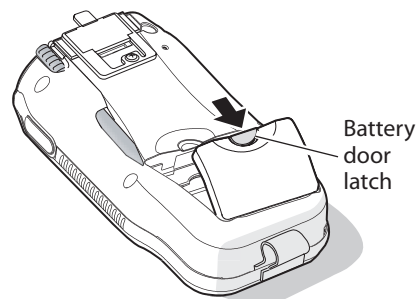

- 2 Align the battery contacts, and insert the battery in the battery compartment. Press down on the battery until it clicks into place.

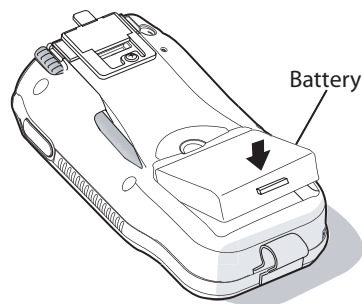

- 3 Replace the battery door.

## Chapter 1 — Using the CN2G Handheld Computer

- 4 Connect the AC power supply (P/N 074246) to the power connector on the back of the CN2 communications dock (P/N 074248), and then connect the power cord to the AC power supply.

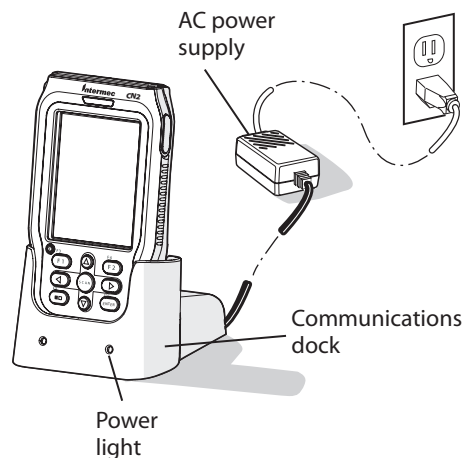

- 5 Connect the power cord to an AC power outlet. The green Power light on the communications dock turns on.
  - 6 Place the CN2G in the communications dock. The battery is fully charged in approximately 4 hours.
- For more information, see the instructions that ship with the communications dock.

### Maximizing Battery Life

There are several things that you can do to maximize the life of your fully charged battery.

- Set the backlight timeout to 10 seconds.
- Verify that Radio Power Management is enabled (Fast PSP). Enabling radio power management allows your radio to switch between awake and sleep modes based on network traffic.
- Verify that each setting under Power Management has a value of 1 minute for a combined automatic shutoff time of 3 minutes.



## Chapter 1 — Using the CN2G Handheld Computer

You can use Intermec Settings to easily make all of these configuration changes. For help, see “Configuring the CN2G Locally With Intermec Settings” on page 22.

### Checking the Battery Status

The easiest way to tell the status of your battery is to look at the battery icon on the status bar of your CN2G.

#### Battery Icon Status

Icon	Status
	The battery is charging.
	The battery is low. You need to charge the battery soon.
	The battery is critically low. You need to charge the battery now.

### Using the Keypad

The CN2G has a 10-key keypad. You enter all of the characters and functions printed on the keys just like you would on a standard keyboard.

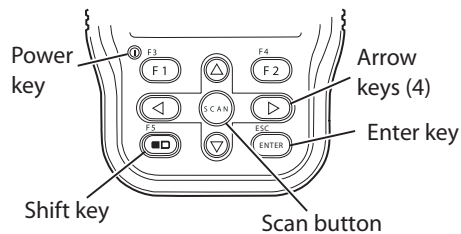



#### CN2G Keypad

The **Shift** (  ) key lets you access the additional functions printed on the keypad overlay.



**To access functions printed on the keypad overlay**

- 1 Press and release the **Shift** key. The  icon turns on and Shift mode is enabled.
- 2 Press and release the second key to access the function printed above a key. For example, press the **F1** key to access the **F3** function. The  icon turns off.

If you do not press another key within 3 seconds of pressing the **Shift** key, the  icon turns off and Shift mode is disabled.

**Using the Power Key**

When you press the **Power** key to turn off the CN2G, you actually put the CN2G in Suspend mode. In Suspend mode, the CN2G continues to supply power to all memory, but turns off power to most hardware. This power-saving feature is designed to prolong battery life.

When you press the **Power** key to turn the CN2G back on, your computer resumes where it was when you turned it off. If you are using WPA or 802.1x security, the computer may need to reauthenticate before it starts your application.

If your CN2G does not resume after pressing the **Power** key, your battery may be too low to supply power. Replace or charge the battery. If replacing or charging the battery does not solve the problem, see “Booting the CN2G” on page 70.

**To turn off the CN2G**

- Press and hold the **Power** key for approximately 2 seconds, and then release it. The CN2G turns off.

## Using the Touch Screen

The CN2G has a color touch screen display. The screen is 240 x 320 pixels. The desktop is 240 x 320 pixels and the taskbar is 240 x 20 pixels. In addition, the screen supports Unicode characters, user-programmable fonts, and bitmap graphics.



**CN2G Start Screen**

## Using the Touch Screen and Stylus

Your CN2G has a stylus for selecting items and entering information. Use the stylus in place of a mouse.

### **Functions You Can Perform With the Stylus**

Action	Description
Tap	Touch the screen once with the stylus to open items and select options.
Drag	Hold the stylus on the screen and drag across the screen to select text and images.
Tap and hold	Tap and hold the stylus on an item to see a list of actions available for that item. On the pop-up menu that appears, tap the action you want to perform.

## Understanding the Desktop

The Start screen has two distinct areas: the desktop and the taskbar. The desktop displays shortcuts to some of the applications installed on the CN2G. The first time you turn on the CN2G, the taskbar displays the Start menu icon, the time, the keyboard icon, and the desktop icon.

Most of the default shortcuts on the desktop are standard Windows CE applications. However, Intermec provides shortcuts to two additional applications: ScanDemo and Transcriber. ScanDemo is a simple application you can use to verify that your imager is working correctly. Transcriber enables you to write on the screen with your stylus, and then it converts your writing to text.

### Using ScanDemo

ScanDemo is an application that enables the CN2G to read bar code labels and display the information encoded on the label along with the symbology used to encode it.

### To open ScanDemo

- 1 Double-tap the **ScanDemo** shortcut on the desktop. The ScanDemo application opens.
- 2 Scan a bar code label. For information on how to scan a bar code label, see “Scanning Bar Codes” on page 14. The information you scanned along with the symbology used to encode it appears on the screen:

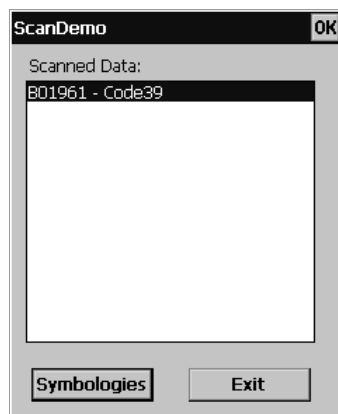

### To enable or disable symbologies

- 1 From the ScanDemo window, tap the **Symbologies** button to see the symbologies that are enabled.

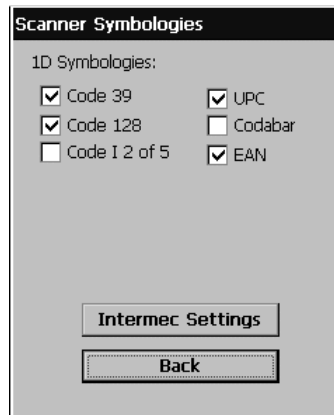

- 2 Select or clear the symbologies you want to use and tap **Back**.
- 3 If you want to configure symbology parameters, tap **Intermec Settings**. Intermec Settings appears on your screen.
- 4 From the Intermec Settings application, go to **Scanners, Symbologies > Internal Scanner > Symbologies**.
- 5 Select a symbology and modify its parameters.
- 6 Save your settings and close Intermec Settings. The Scanner Symbologies window appears.
- 7 Tap **Back**.
- 8 Scan bar code labels.

### Using Transcriber

In a program that accepts writing, such as Microsoft WordPad, you can use your stylus to write directly on the screen. Write the way you do on paper (print or cursive) and the Transcriber program converts your writing to text.

**To turn on Transcriber**

- Double-tap the **Transcriber** shortcut on the desktop or go to **Start > Programs > Transcriber**.

The Transcriber Intro box appears and an icon () appears in the taskbar with a dark gray background.

**To turn off Transcriber**

- Tap the **Transcriber** icon in the taskbar.

The background of the Transcriber icon turns light gray to match the taskbar and using the stylus does not produce a line on your desktop.

**To close Transcriber**

- 1 Tap and hold the **Transcriber** icon in the taskbar until the menu appears.
- 2 Tap **Close Transcriber**.

**To select text**

- 1 Tap and hold the stylus next to the text you want to select until the insertion point appears.
- 2 Without lifting, drag the stylus across the text you want to select.















**To get help for Transcriber**

- 1 Tap and hold the **Transcriber** icon in the taskbar until the menu appears.
- 2 Tap **Help**. The help system for Transcriber appears on the screen.

## Understanding the Screen Icons

Use the screen icons on the status bar to see the battery status, network connections, and special keys or functions you may be using. Standard Microsoft icons are not included in this table.

### CN2G Screen Icons

Icon	Description
	Battery is charging.
	Battery is low. Charge the battery soon.
	Battery is critically low. Charge the battery now.
	Backup battery is low. Charge the battery now.
	CN2G is authenticated with a strong connection to the access point.
	CN2G is authenticated with a good connection to the access point.
	CN2G is authenticated with a weak connection to the access point. Try moving closer to an access point.
	No connection to the access point. For help, see “Problems with Wireless Connectivity” on page 67.
	Shift key is enabled.
	Caps Lock feature on the input panel is enabled.
	UDP Plus is connected.
	UDP Plus is transferring data.
	No UDP Plus connection. For help, see “Configuring the Network Parameters for a UDP Plus Network” on page 30.
	The CN2G is connected using ActiveSync.

## Calibrating the Screen

If the screen does not respond when you tap it with the stylus, you may need to recalibrate the screen.

**To calibrate the screen**

- 1 Press and hold **■□**, and then press **▲**. The calibration screen appears.
- 2 Follow the instructions to calibrate the screen.

## Understanding the Status Lights

The status lights on the CN2G turn on to indicate the status of the battery or a successful decode of a bar code.

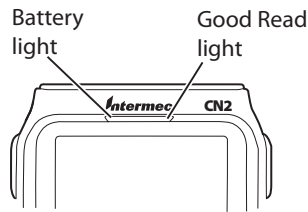

**CN2G Status Lights:** This illustration shows the location of the Battery and Good Read lights.

### Understanding the CN2G Status Lights

Light Name	Color	Description
Good Read	Green	This light turns on when the CN2G successfully decodes a bar code.
	Red	This light turns on when you press the <b>Scan</b> button or one of the <b>Side Scan</b> buttons.
Battery	Green	When the CN2G is connected to a power source, this light turns on to indicate that you can charge the battery.
	Orange	When the CN2G is connected to a power source, this light turns on if you cannot charge the battery. The temperature may not be within the charging range, or the battery may be damaged.
	Red	When the CN2G is connected to a power source, this light turns on to indicate that the battery is charging.

## Understanding the Beeps

The CN2G uses beeps to provide you with audio feedback when it performs some functions. For example, you hear a beep each time you scan a valid bar code.

### Understanding the CN2G Beeps

Beep Sequence	What it Means
High beep, low beep	You entered valid data or a valid command, the CN2G decoded a label, or the CN2G decoded the last row of a two-dimensional bar code.
Error beep	You entered or scanned an invalid command. Try entering or scanning the command again.
Click	You pressed a key.

You can change the beeper volume for your needs and environment. You can set the beeper volume to off, low (quiet), medium, high (loud), and very high (very loud – default setting).

### To change the beeper volume

- 1 From the **Start** menu, choose **Intermec Settings**.
- 2 Go to **Device Settings > Beeper > Volume**.
- 3 Select a volume level, save your changes, and exit Intermec Settings.

## Scanning Bar Codes

Use the scanner to scan and enter bar code data. The CN2G supports the scanning of 1D linear bar codes. When you unpack the CN2G, these bar code symbologies are enabled:

- Code 39
- Code 128
- UPC/EAN



## Chapter 1 — Using the CN2G Handheld Computer

Use Intermec Settings to enable and disable symbologies. For help understanding how to use Intermec Settings, see “Configuring the CN2G Locally With Intermec Settings” on page 22.

### To scan a bar code label with the CN2G

- 1 Press the **Power** key to turn on the CN2G.
- 2 Point the scanner window at the bar code label and hold the computer at a slight angle 15 to 25 cm (6 to 10 in) from the label.

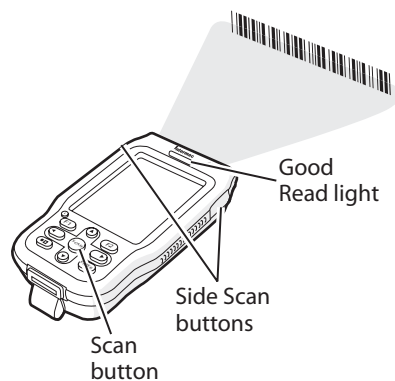

- 3 Press the **Scan** button on the keypad or one of the **Side Scan** buttons on the CN2G and center the red beam so that it falls across all bars in the bar code label.

Use this test bar code:

Code 39 Test Bar Code



\*123456\*

When the CN2G successfully reads a bar code label, you hear a high beep and the green Good Read light turns on briefly.

- 4 Release the **Scan** button or **Side Scan** button.

## Using the SD Card

You can use a Secure Digital (SD) card to increase file storage and install software. The CN2G currently supports SanDisk SD cards only.



**Note:** Before installing an SD card, make sure to attach one of the pull-tabs that ships with the CN2G. SD cards without a pull-tab can be very difficult to remove.

The CN2G ships with a 256MB SD card installed. The SD card slot is located under the battery in the battery compartment of the CN2G.

### To remove the SD card

- 1 Press and hold the **Power** key for approximately 2 seconds, and then release it to turn off the CN2G.
- 2 Push down on the battery door latch, and pull up on the battery door.

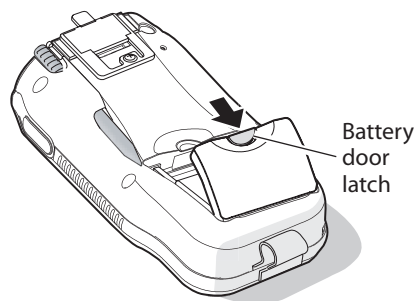

**Chapter 1 — Using the CN2G Handheld Computer**

- 3 Insert the stylus between the battery and the CN2G case, and press straight down until the battery is released.

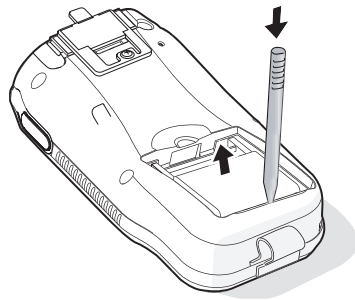

- 4 Pull the tab attached to the SD card toward the bottom of the CN2G.

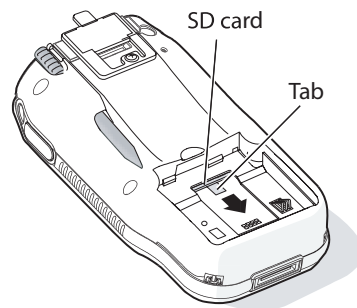

- 5 Remove the SD card from the CN2G.

***Chapter 1 — Using the CN2G Handheld Computer***



## **2** Configuring the CN2G

Use this chapter to understand how to configure the CN2G to communicate in your network. In this chapter, you will find these sections:

- How to Configure the CN2G Parameters
- Configuring the CN2G for Your Network
- Configuring Security

## How to Configure the CN2G Parameters

You can configure many parameters on the CN2G, such as the bar code symbologies it decodes or the network settings. These characteristics are controlled by configuration parameters. The values you set for these configuration parameters determine how the computer operates.

There are several ways to configure the CN2G:

### Use Setup Assistant

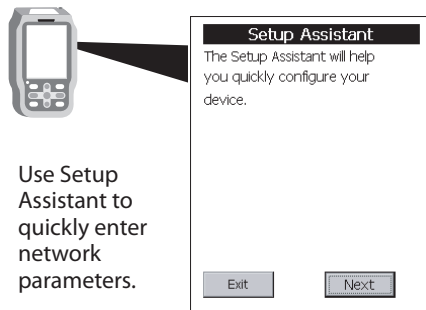

Use Setup Assistant to quickly enter network parameters.

### Use Intermec Settings Remotely

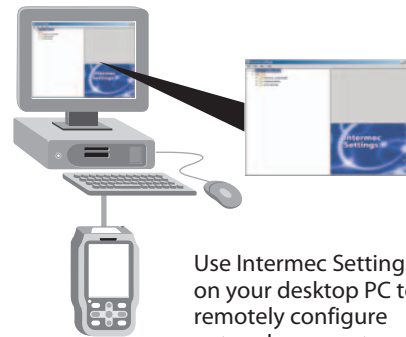

Use Intermec Settings on your desktop PC to remotely configure network parameters.

### Use Intermec Settings Locally

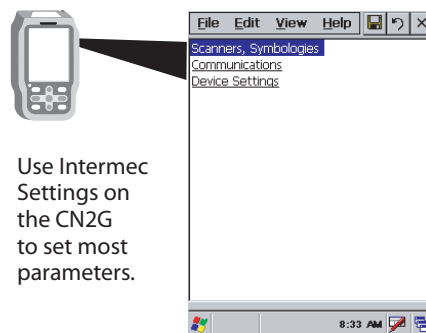

Use Intermec Settings on the CN2G to set most parameters.

**Configuring the CN2G:** The CN2G provides several ways for you to configure the communications, device, and imaging parameters.

## Configuring the CN2G With the Setup Assistant

The Setup Assistant runs on the CN2G the first time you turn on the computer. Use the Setup Assistant to set or enable basic network parameters and connect your CN2G to the network. The Setup Assistant guides you through setting the following basic network parameters:

- Date and time
- 802.11b radio and SSID (Network name)
- 802.1x security
- DHCP server or IP address, subnet mask, and default router
- Primary and secondary DNS addresses
- Primary and secondary WINS addresses
- Device name

To set other parameters, use Intermec Settings or another configuration method.

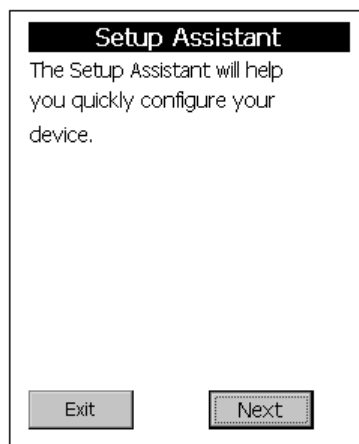

**The Setup Assistant Start Screen**

After you complete the Setup Assistant, the CN2G should be communicating with your network. A network connection icon appears on your taskbar. For more information on the network icons, see “Understanding the Screen Icons” on page 12.

## Configuring the CN2G Locally With Intermec Settings

Use Intermec Settings to configure the CN2G and view system information. You can access Intermec Settings while running any application.

### To open Intermec Settings

- 1 Tap the **Start** icon. The **Start** menu appears.



- 2 Select **Intermec Settings**. The Intermec Settings application appears.

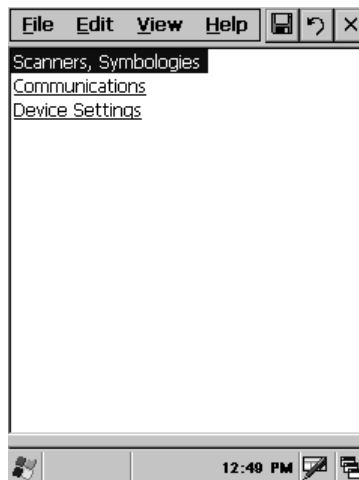



## Chapter 2 — Configuring the CN2G

Use the following diagram to help find the commands you need to use to configure your CN2G. These screens do not represent the exact information you will see on your CN2G. They have been modified to show you how the information is structured. For detailed information on most of the commands available in Intermec Settings, see the *Intermec Computer Command Reference Manual* (P/N 073529) available from the Intermec web site at [www.intermec.com](http://www.intermec.com).

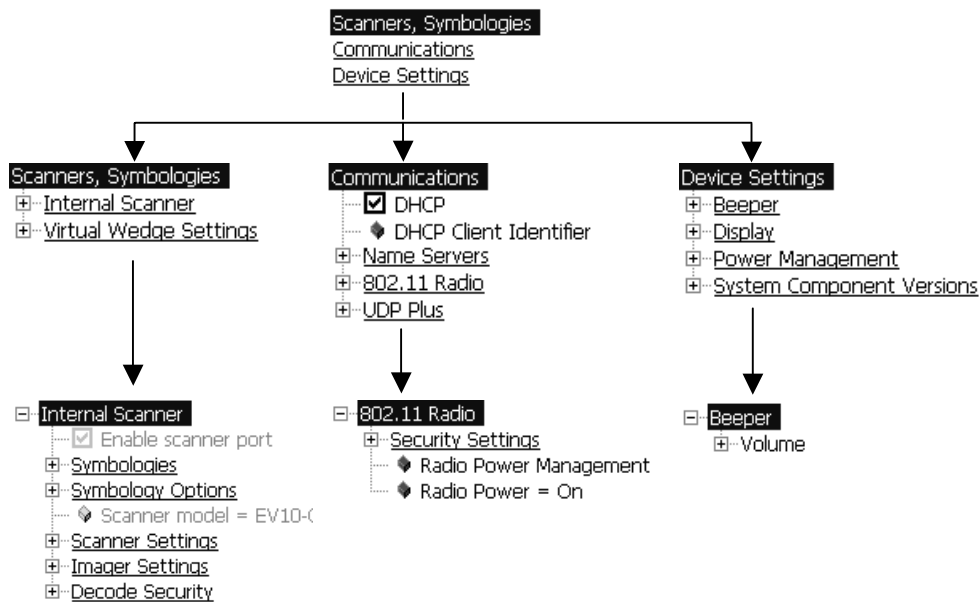

**Intermec Settings Menus:** Use this diagram to help navigate through the Intermec Settings application. This diagram should only be used as a guide; it does not accurately represent all of the information you will see on your screen.

## Chapter 2 — Configuring the CN2G

Use this table to understand how to navigate and enter information in Intermec Settings.

### Navigating in Intermec Settings

To Perform This Function:	Do This:
Select or expand an option	<ul style="list-style-type: none"><li>• Tap the option.</li><li>• Press ▲ or ▼ to select an option.</li></ul>
Select text in a text box	<ul style="list-style-type: none"><li>• Tap in the text box and drag the stylus over the text.</li></ul>
Expand an option	<ul style="list-style-type: none"><li>• Tap the option.</li><li>• Press ▲ or ▼ to select the option, and then press ►.</li></ul>
Save settings	<ul style="list-style-type: none"><li>• Tap <b>File &gt; Save Settings</b></li><li>• Tap the <b>Save</b> icon in the upper right corner</li></ul>

### Restoring Default Settings

You can restore the CN2G to factory default settings from Intermec Settings. For a complete list of the default settings, see “Default Configuration” on page 76.



**Note:** Restoring the CN2G to factory default settings resets all network parameters. As a result, you may lose network communications. This option should only be used by network administrators or by Intermec support personnel.

#### To restore default settings

- 1 Tap the **Start** icon. The **Start** menu appears.
- 2 Select **Intermec Settings**. The Intermec Settings application appears.
- 3 Select one of the menus: Scanners, Symbologies or Communications or Device Settings.
- 4 Tap **Edit > Restore Item Defaults**.
- 5 Tap the **Yes** button to restore all default settings.
- 6 Repeats Steps 3 and 4 for the other two menus.

### Exiting Intermec Settings

When you are done modifying your device configuration and have saved your settings, you should exit Intermec Settings.

#### To exit Intermec Settings

- From the Main Menu, choose **File > Exit**.
- Or,
- Tap the **Close** button ( **X** ) in the upper right corner of the window.

If you try to exit Intermec Settings without saving your changes, a message box appears asking if you want to save your configuration changes. Tap **Yes**.

## Configuring the CN2G Remotely With Intermec Settings

You can use Intermec Settings remotely to configure your CN2G. The remote version of Intermec Settings provides these features:

- Intermec Settings can configure CN2Gs one-to-one through an ActiveSync connection.
- Intermec Settings can run as a plug-in to the Wavelink Avalanche device management system. Avalanche automates device management within a network and lets you install, update, and manage the software and configurations of wireless and other devices.

The ActiveSync (one-to-one) version of Intermec Settings is available from the Intermec web site as part of the Intermec Developer's Library (IDL) download or from the IDL CD. For information on installing ActiveSync and establishing a partnership, see "Installing Applications Using ActiveSync" on page 52.

Intermec Settings is also available as part of a Wavelink Avalanche package for the CN2G. You can download this package from the Intermec web site.

For information on how to use the Intermec Settings application, see the online manual available from the Help menu in Intermec Settings.

## Configuring the CN2G For Your Network

The CN2G is a versatile handheld computer that you can easily add to your wired or wireless data collection network. You can connect your CN2G to your network using:

- USB communications
- 802.11b radio communications

### Configuring USB Communications

You can place the CN2G in the communications dock (P/N 074248) to transfer data to and receive data from another device using USB communications. The USB cable and the communications dock are sold separately. For more information on accessories and how to order them, see page 75.

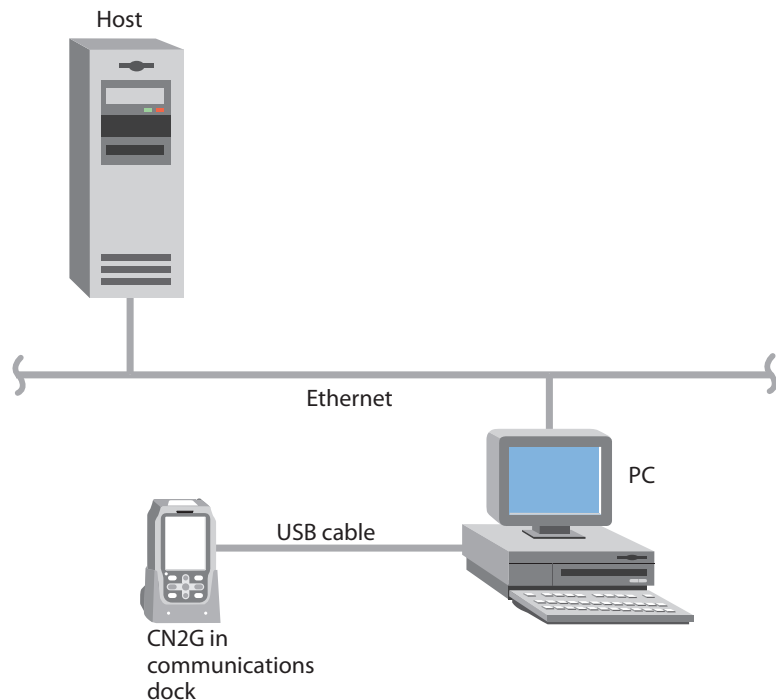

**CN2G Using USB Communications**

**To use USB communications with your CN2G**

- 1 Connect the communications dock to the USB port of the other device using an appropriate USB cable.
- 2 Make sure that your USB device is configured for USB communications.
- 3 Insert the CN2G into the communications dock.
- 4 Turn on the CN2G.

For more information about the communications dock, see the instructions that ship with the communications dock.

**Configuring 802.11b Radio Communications**



**Make sure all components with antennas are at least 30 cm (1 ft) apart when power is applied. Failure to comply could result in equipment damage.**

The wireless CN2G has an internal 802.11b radio to transfer data using wireless communications. This section of the manual assumes that you have already set up your wireless communications network including your access points. If you are using a UDP Plus network, you also need to have your Intermec Application Server communicating with a host computer.

Your CN2G supports these network protocols:

- TCP/IP
- UDP Plus

The next sections explain the parameters you need to configure for the CN2G to work in your wireless network.

**Chapter 2 — Configuring the CN2G**

**Configuring the Network Parameters for a TCP/IP Network**

In a TCP/IP network, the CN2G communicates with a host computer directly using TCP/IP. The access point acts as a bridge to allow communications between the wired network and the wireless network.

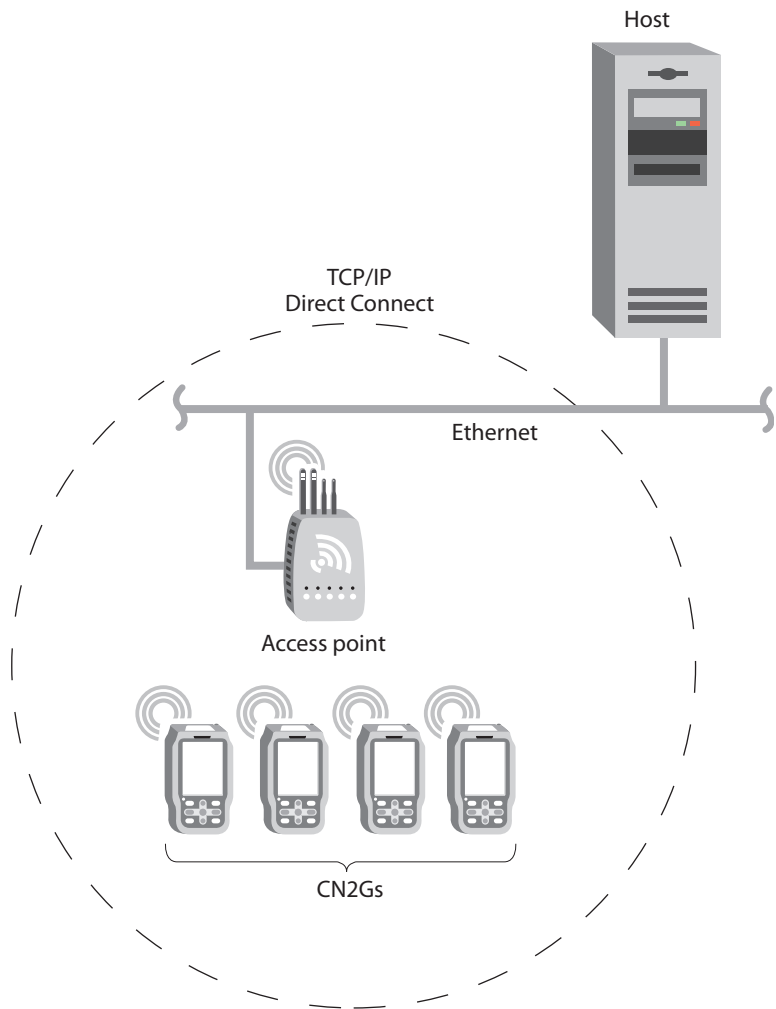

**CN2Gs in a TCP/IP Direct Connect Network**

## **Chapter 2 — Configuring the CN2G**

### **To use wireless communications in a TCP/IP network**

- 1** Configure these network parameters on each CN2G in the network:
  - Infrastructure mode (set to Infrastructure by default)
  - Network name (SSID)
  - Host IP address
  - IP settings (if not using DHCP)
  - Network port
- 2** Configure security. For help, see “Configuring Security” on page 31.

The easiest way to configure the network parameters on the CN2G is to use Intermec Settings. For help, see “Configuring the CN2G Locally With Intermec Settings” on page 22.

**Configuring the Network Parameters for a UDP Plus Network**

In a UDP Plus network, the CN2G communicates with a host computer through the Intermec Application Server.

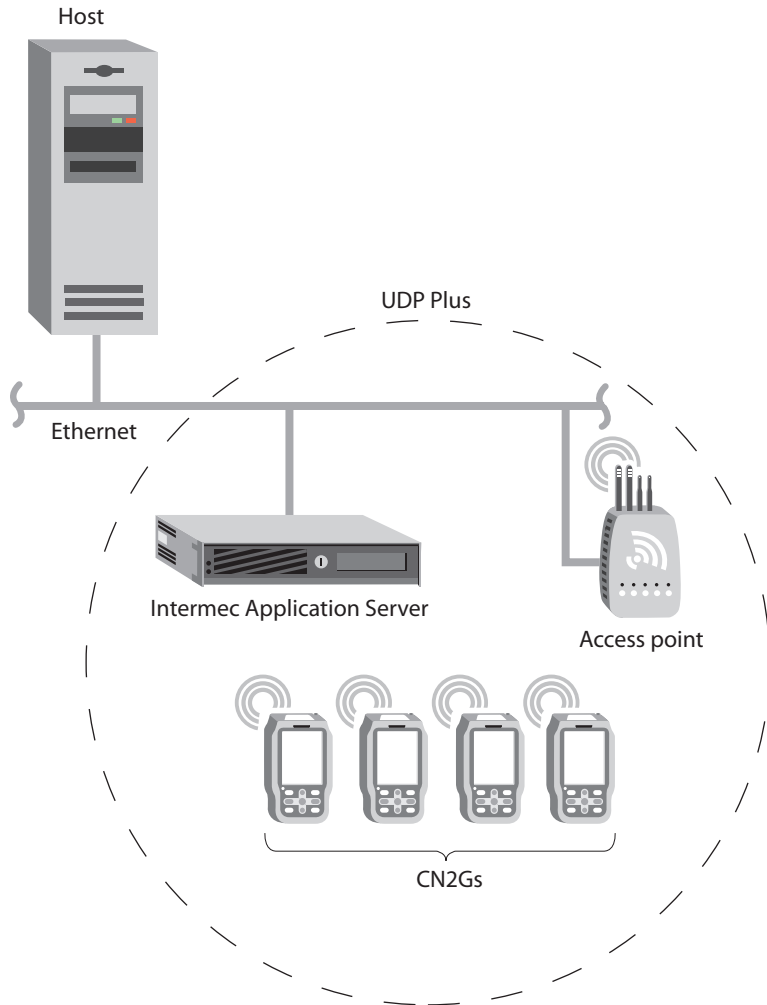

**CN2G in a UDP Plus Network**



## Chapter 2 — Configuring the CN2G

The Intermec Application Server translates UDP Plus packets on the wireless network into TCP/IP packets on the wired network and vice versa. The access point acts as a bridge to allow communications between the wired network and the wireless network.

### To use wireless communications in a UDP Plus network

- 1 Configure these network parameters on each CN2G in the network:
  - Network name (SSID)
  - Controller IP address
  - IP settings (if not using DHCP)
  - Controller port (set to 5555)
- 2 Configure the security. For help, see the next section, “Configuring Security.”

The easiest way to configure the network parameters on the CN2G is to use Intermec Settings. For help, see “Configuring the CN2G Locally With Intermec Settings” on page 22.

## Configuring Security

The CN2G provides three types of security for your wireless network:

- Wi-Fi Protected Access (WPA)
- 802.1x
- WEP

Use the next sections to understand how to configure each type of security on your wireless CN2G. If you choose not to use security, see “Disabling Security” on page 48. For more information on the different types of security, see the *MobileLAN™ secure 802.1x Security Solution Installation Guide* (P/N 073134) available at [www.intermec.com](http://www.intermec.com).

The CN2G provides both Microsoft and Funk security. Microsoft security is the default setting. Use the following sections to set security using either Microsoft or Funk as your security choice.

## Chapter 2 — Configuring the CN2G

If you are using 802.1x security, this section also assumes that your authentication server and authenticators are properly configured.

### Using Funk Security

Funk security provides everything you get with Microsoft security with the addition of CCX v1.0 compliance. Funk security also enables you to use LEAP and TTLS authentication on your CN2G.

The type of security you choose is not dependent on your authentication server. To use Funk security, you need to:

- select Funk security as your security choice.
- select a profile.

#### Selecting Funk as Your Security Choice

The default security setting is Microsoft. If you want to use Funk security, you need to select it as your security choice.

#### To select Funk security as your security choice

- 1 Tap the **Start** icon. The **Start** menu appears.
- 2 Select **Intermec Settings**. The **Intermec Settings** application appears.
- 3 Select **Communications** > **802.11 Radio** > **Security Settings** > **Security Choice**.
- 4 From the **Security Choice** list, select **Funk Security**.
- 5 Tap the **Save** icon in the upper right corner of the window. An alert box appears telling you that you must save your settings and warm boot the CN2G for your new security choice to take effect.
- 6 Tap **OK** to close the alert box.
- 7 Save your settings.
- 8 Warm boot your CN2G by pressing and holding the **Power** key for approximately 10 seconds.

### Selecting a Profile for Funk Security

You can define up to four profiles for your Funk security. Different profiles let your CN2G communicate in different networks without having to change all of your security settings. For example, you may want to set up one profile for the manufacturing floor and one for the warehouse.

#### To select a profile for Funk security

- 1 Tap the **Start** icon. The **Start** menu appears.
- 2 Select **Intermec Settings**. The **Intermec Settings** application appears.
- 3 Select **Communications > 802.11 Radio > Security Settings > Funk Security**.
- 4 (Optional) Give your Profile 1 a meaningful name.
  - a Select **Profile 1**. The profile expands.
  - b Select **Profile Label** and a text box appears.
  - c Select the text in the box and use the input panel to type in your meaningful name.
  - d Tap the **Save** icon in the upper right corner of the window.
- 5 (Optional) Modify more profiles.
  - a Tap **Active Profile**.
  - b Select the profile that you want to modify and tap anywhere on the screen.
  - c Repeat Step 4.
- 6 Repeat Step 5 for as many profiles as you want to define.
- 7 Select the active profile you want to configure with security settings.
- 8 Configure your security settings.

## Using WPA Security

Wi-Fi Protected Access (WPA) is a strongly enhanced, interoperable Wi-Fi security that addresses many of the vulnerabilities of Wired Equivalent Privacy (WEP). Instead of WEP, WPA uses Temporal Key Integrity Protocol (TKIP) for its data encryption method.

Currently, WPA satisfies some of the requirements in the IEEE 802.11i draft standard. When the standard is finalized, WPA will maintain forward compatibility.

WPA runs in 802.1x (Enterprise) mode or PSK (Pre-Shared Key) mode:

- In Enterprise mode, WPA provides user authentication using 802.1x and the Extensible Authentication Protocol (EAP). That is, an authentication server (such as a RADIUS server) must authenticate each device before the device can communicate with the wireless network.
- In PSK mode, WPA provides user authentication using a shared key between the authenticator and the CN2G. WPA-PSK is a good solution for small offices or home offices that do not want to use an authentication server.

To use WPA security, you need:

- an authentication server (Enterprise mode only).



**Note:** You can also use a MobileLAN access WA2XG product as an authentication server. For help, see the *MobileLAN access WA2XG System Manual* (P/N 074921).

- an access point with an 802.11b/g radio that supports WPA.
- a CN2G with the 802.11b radio and the 802.1x/WPA security option.

### Configuring WPA Security With Funk Security

Use these procedures to set WPA-802.1x and WPA-PSK security on your CN2G with Funk security.

#### To configure WPA-802.1x security on your CN2G with Funk security

- 1 Make sure you have configured the communications and radio parameters on your CN2G.
- 2 Make sure you have selected Funk as your security choice.
- 3 Load a user and root certificate on your CN2G. For help, see “Loading a Certificate” on page 45.
- 4 Open Intermec Settings.
- 5 Choose **Communications > 802.11 Radio > Security Settings > Funk Security > Profile**.
- 6 For **Association**, choose **WPA** and tap the **Save** icon in the upper right corner of the window. Encryption is set to TKIP by default.
- 7 For **Authentication**, choose **TTLS**, **PEAP**, or **TLS** and tap **Save**.

If you choose TTLS or PEAP:

- a Select **User name**, select the text in the text box, use the input panel to type your user name, and tap **Save**.
- b For **Password prompt**, make sure that **Enter password now** is selected.



**Note:** You can use **Prompt for password** to troubleshoot your connection to the network if you have problems.

- c Select **User Password**, select the text in the text box, use the input panel to type your user password, and tap **Save**.
- d For **Validate Server Certificate**, choose **Enabled** and tap **Save**.



**Note:** You must have the date on the CN2G set correctly when you enable Validate Server Certificate.

## Chapter 2 — Configuring the CN2G

If you choose TLS:

- a** For **Validate Server Certificate**, choose **Enabled** and tap **Save**.
  - b** You must enter a **User Name** and **Subject Name**. You can also enter a **Server Common Name** if you want to increase your level of security.
- 8** Exit Intermec Settings.

### To enable WPA-PSK security on your CN2G with Funk security

- 1** Make sure you have configured the communications and radio parameters on your CN2G.
- 2** Make sure you have selected Funk as your security choice.
- 3** Open Intermec Settings.
- 4** Choose **Communications > 802.11 Radio > Security Settings > Funk Security > Profile**.
- 5** For **Association**, choose **WPA** and tap **Save**.
- 6** For **Authentication**, choose **None** and tap **Save**.
- 7** For **Pre-Shared Key**, enter the pre-shared key or the passphrase.

The pre-shared key must be a value of 32 hex pairs preceded by 0x for a total of 66 characters. The value must match the key value on the access point. The passphrase must be from 8 to 63 characters. After you enter a passphrase, the CN2G internally converts it to a pre-shared key.

This value must match the passphrase on the authenticator.

- 8** Exit Intermec Settings.

### Configuring WPA Security With Microsoft Security

Use these procedures to set WPA-802.1x and WPA-PSK security on your CN2G with Microsoft security. These procedures assume that Microsoft is selected as your security choice.

#### To enable WPA-802.1x security on your CN2G with Microsoft security

- 1 Make sure you have configured the communications and radio parameters on your CN2G.
- 2 Load a user and root certificate on your CN2G. For help, see “Loading a Certificate” on page 45.
- 3 Open Intermec Settings.
- 4 Choose **Communications > 802.11 Radio > Security Settings > Microsoft Security**.
- 5 For **Infrastructure Mode**, choose **Infrastructure**.
- 6 For **Network Authentication**, choose **WPA** and tap the **Save** icon in the upper right corner of the window. Data Encryption is set to TKIP by default.
- 7 For **802.1x Authentication**, choose either **TLS** or **PEAP**.

If you choose TLS:

- a Tap **Properties** and tap the **Run App** button. The Authentication Settings box appears.



- b From the Authentication Settings box, tap the **Select** button.
- c Tap your certificate from the list and tap **Enter**.

## Chapter 2 — Configuring the CN2G

If you choose PEAP:

- a Tap **Properties** and tap the **Run App** button. The Authentication Settings box appears.
- b Tap the **Validate Server** check box.
- c Tap **Enter**. After the radio starts to authenticate, the Network Password dialog box appears:

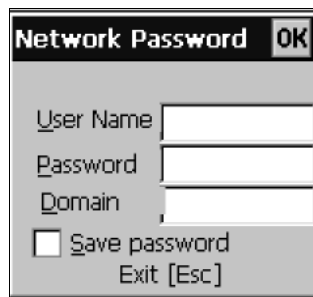

- d Enter a **User Name** and **Password** and tap the **Save Password** check box.
  - e (Optional) In the **Domain** field, enter the Active Directory domain associated with the user account.
  - f Press **Enter**.
- 8 Exit Intermec Settings.

### To enable WPA-PSK security on your CN2G With Microsoft security

- 1 Make sure you have configured the communications and radio parameters on your CN2G.
- 2 Load a user and root certificate on your CN2G. For help, see “Loading a Certificate” on page 45.
- 3 Open Intermec Settings.
- 4 Choose **Communications > 802.11 Radio > Security Settings > Microsoft Security**.
- 5 For **Infrastructure Mode**, choose **Infrastructure**.



6 For **Network Authentication**, choose **WPA-PSK** and tap the **Save** icon in the upper right corner of the window. Data Encryption is set to TKIP by default.

7 For **Pre-Shared Key**, enter the pre-shared key or the passphrase.

The pre-shared key must be a value of 32 hex pairs preceded by 0x for a total of 66 characters. The value must match the key value on the authenticator. The passphrase must be from 8 to 63 characters. After you enter a passphrase, the CN2G internally converts it to a pre-shared key.

This value must match the passphrase on the authenticator.

8 Exit Intermec Settings.

## Using 802.1x Security

802.1x security provides centralized user authentication using an authentication server, authenticators (access points), and supplicants. These components communicate using an EAP authentication type, such as TLS (Transport Layer Security) or PEAP (Protected Extensible Authentication Protocol). 802.1x security provides data encryption using dynamic WEP key management.

To use 802.1x security, you need:

- an authentication server.



**Note:** You can also use a MobileLAN access WA2XG product as an authentication server. For help, see the *MobileLAN access WA2XG System Manual* (P/N 074921).

- an access point with an 802.11b/g radio.
- a CN2G with an 802.11b radio and the 802.1x/WPA security option.
- user and root certificates.

These procedures assume that you have already selected either Microsoft or Funk as your security choice.

### Configuring 802.1x Security With Funk Security

- 1 Make sure you have configured the communications and radio parameters on your CN2G.
- 2 Make sure you have selected Funk as your security choice.
- 3 Load a user and root certificate on your CN2G. For help, see “Loading a Certificate” on page 45.
- 4 Open Intermec Settings.
- 5 Choose **Communications > 802.11 Radio > Security Settings > Funk Security > Profile**.
- 6 For **Association**, tap **Open** and tap **Save**.
- 7 For **Encryption**, tap **WEP** and tap **Save**.
- 8 For **Authentication**, tap **TTLS**, **PEAP**, or **TLS** and tap **Save**.

If you choose TTLS or PEAP:

- a Select **User name**, type your user name, and then tap **Save**.
- b Select **Password prompt**, choose **Enter password now**, and then tap **Save**.



**Note:** You can use **Prompt for password** to troubleshoot your connection to the network if you have problems.

- c Select **User Password**, type a user password, and then tap **Save**.
- d For **Validate Server Certificate**, choose **Enabled** and tap **Save**.

If you choose TLS:

- a For **Validate Server Certificate**, choose **Enabled** and tap **Save**.
  - b You can also enter a **User Name**, **Subject Name** and **Server Common Name** if you want to increase your level of security.
- 9 Exit Intermec Settings.

### Configuring 802.1x Security With Microsoft Security

- 1 Make sure you have configured the communications and radio parameters on your CN2G.
- 2 Load a user and root certificate on your CN2G. For help, see “Loading a Certificate” on page 45.
- 3 Open Intermec Settings.
- 4 Choose **Communications > 802.11 Radio > Security Settings > Microsoft Security**.
- 5 For **Infrastructure Mode**, choose **Infrastructure**.
- 6 For **Network Authentication**, choose **Open**.
- 7 For **Data Encryption**, choose **WEP**.
- 8 For **802.1X Authentication**, choose **TLS** or **PEAP**, and tap **Save**.

If you choose TLS:

- a Select **Properties** and tap the **Run App** button. The Authentication Settings box appears.



- b From the Authentication Settings box, tap the **Select** button.
- c Select your certificate from the list and tap **Save**.

If you choose PEAP:

- a Select **Properties** and tap the **Run App** button. The Authentication Settings box appears.
- b Select the **Validate Server** check box.

## Chapter 2 — Configuring the CN2G

- c Press **Enter**. Once the radio starts to authenticate, the Network Password dialog box appears:

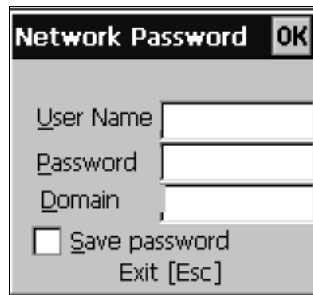

- d Enter a **User Name** and **Password** and Select the **Save Password** check box.
- e (Optional) In the **Domain** field, enter the domain.
- f Press **Enter**.
- 9 For **Network Key Setting**, choose **Automatic**.
- 10 Exit Intermec Settings.

## Using LEAP Security

Lightweight Extensible Authentication Protocol (LEAP), also known as Cisco-Wireless EAP, provides username/password-based authentication between a wireless client and a RADIUS server. In the 802.1x framework, traffic cannot pass through an Ethernet hub or wireless network access point until it successfully authenticates itself.

The station must identify itself and prove that it is an authorized user before it is actually allowed to use the LAN. LEAP also delivers a session key to the authenticated station, so that future frames can be encrypted with a key that is different than keys used by others' sessions.

To use LEAP security, you need:

- a RADIUS server.
- a Cisco access point with an 802.11b/g radio.



**Note:** LEAP security is not supported with Microsoft security.

#### To enable LEAP security on your CN2G

- 1 Make sure you have configured the communications and radio parameters on your CN2G.
- 2 Make sure you have selected Funk as your security choice.
- 3 From Intermec Settings, choose **Communications > 802.11 Radio > Security Settings > Funk Security > Profile**.
- 4 For **Authentication**, Select **LEAP** and then tap **Save**.
- 5 For **Association**, Select **Open** or **Network EAP** and then tap **Save**.
- 6 For **Encryption**, Select **WEP**, and then tap **Save**.
- 7 Select **User name**, type your user name, and then tap **Save**.
- 8 Select **Password prompt**, choose **Enter password now**, and then tap **Save**.



**Note:** You can use **Prompt for password** to troubleshoot your connection to the network if you have problems.

- 9 Select **User Password**, type a user password, and then tap **Save**.
- 10 Exit Intermec Settings.

### Using Static WEP Security

The CN2G uses the Wired Equivalent Privacy (WEP) protocol to add security to your wireless network based on the 802.11b standard.

To use WEP security, you need:

- an access point with an 802.11b/g radio.
- a CN2G handheld computer with an 802.11b radio.

### Configuring Static WEP Security With Funk Security

- 1 Make sure you have configured the communications and radio parameters on your CN2G.
- 2 Make sure you have selected Funk as your security choice.
- 3 Open Intermec Settings.
- 4 Choose **Communications > 802.11 Radio > Security Settings > Funk Security > Profile**.
- 5 For **Association**, choose **Open**, and then tap **Save**.
- 6 For **Encryption**, choose **WEP** and then tap **Save**.
- 7 For **Authentication**, choose **None** and then tap **Save**.
- 8 Select **WEP Key** and then define a value for each WEP key. You can define up to four WEP keys.

Enter an ASCII key or a hex key that is either 5 bytes or 13 bytes long depending on the type of WEP encryption you are using. Set a 5-byte value for 64-bit WEP or a 13-byte value for 128-bit WEP. Hex values must be preceded by 0x and contain 5 or 13 hex pairs.

- 9 Select **Network Key Index**, choose the WEP key you want to use for transmitting data.
- 10 Exit Intermec Settings.

### Configuring Static WEP Security With Microsoft Security

- 1 Make sure you have configured the communications and radio parameters on your CN2G.
- 2 Make sure you have selected Microsoft as your security choice.
- 3 Open Intermec Settings.
- 4 Choose **Communications > 802.11 Radio > Security Settings > Microsoft Security**.
- 5 For **Network Authentication**, choose **Open**.

- 6 For **Data Encryption**, choose **WEP**.
- 7 For **Network Key Setting**, choose **Enter Key and Index**.
- 8 For **Network Key Value**, enter an ASCII key or a hex key that is either 5 bytes or 13 bytes long depending on the type of WEP encryption you are using.  
  
Set a 5-byte value for 64-bit WEP or a 13-byte value for 128-bit WEP. Hex values must be preceded by 0x and contain 5 or 13 hex pairs.
- 9 For **Network Key Index**, select the key you want to use for data transmission.
- 10 Exit Intermec Settings.

## Loading a Certificate

If you choose to use transport layer security (TLS) with WPA or 802.1x security, you need to have a unique client certificate on the CN2G and a trusted root certificate authority (CA) certificate. You can use a third-party CA to issue unique client certificates and a root certificate.

If you are using Active Directory® to issue certificates, you can use the Enroll Certificates application to load the certificates. If you are using a third-party CA, you can use the Import Root or User Certificates programs to load the certificates.



**Note:** Do not cold boot the CN2G. Cold booting the computer resets the time and date.

### To load certificates on the CN2G if you are using Active Directory

- 1 Configure the network and radio settings for the CN2G to communicate with your certificate authority or establish an ActiveSync connection with the CA.
- 2 From the Configuration Utility, Select **Communications > 802.11 Radio > Security Settings > Certificates**.
- 3 Select **Enroll Certificates** and tap the **Run App** button.

## Chapter 2 — Configuring the CN2G

- 4 From the **Run Application** box, tap **Yes**. The Enroll Certificates dialog box appears.



- 5 Enter the **User Name**, **Password**, and **Server (IP address)** to log in to the CA server.
- 6 Tap **OK**. A dialog box appears asking if you want to load the root certificate.

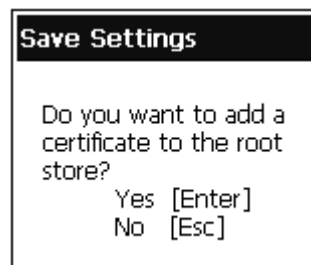

- 7 Press **Enter** for yes. The Enrollment Tool message box appears telling you that the user certificate has been added.
- 8 Press **Enter** to close the Enrollment Tool message box.
- 9 Configure your CN2G for WPA or 802.1x security.

### To load certificates on the CN2G if you are using a third-party CA



**Note:** You need to create the `\temp\root` and `\temp\user` folders on your CN2G before you can copy the certificate files to your handheld computer.

- 1 Copy your `.cer` file to the `\temp\root` folder on the CN2G.
- 2 Copy your `.der` and `.pvk` files to the `\temp\user` folder on the CN2G.



## Chapter 2 — Configuring the CN2G

- 3 From the Configuration Utility, select **Communications > 802.11 Radio > Security Settings > Certificates**.
- 4 Select **Import Root Certificates** and tap the **Run App** button to load the .cer file. A dialog box appears asking if you want to add the certificate to the root store.

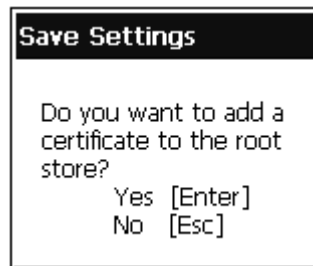

- 5 Press **Enter** to add the certificate. A message box appears telling you that the root certificate has been imported.



- 6 Tap **OK** to close the Success message box.
- 7 Select **Import User Certificate** to load the .der and .pvk files. A message box appears telling you that the certificate has been imported.



- 8 Tap **OK** to close the Success message box.
- 9 Configure your CN2G for WPA or 802.1x security.

## **Disabling Security**

If you choose not to use security with your wireless network, you can disable it on the CN2G. Intermec recommends that you always set security in your network.

### **To disable security**

- 1** Open Intermec Settings.
- 2** Choose **Communications > 802.11 Radio > Security Settings > Microsoft Security**.
- 3** For **Network Authentication**, choose **Open**.
- 4** For **Data Encryption**, choose **Disabled**.
- 5** Tap **Save**.
- 6** Close Intermec Settings.



## **3** Developing and Installing Applications

In this chapter you will find guidelines for developing applications using the Developer's Toolkits for AIT-III. You will also find information on installing applications and automatically launching them. You will find these sections:

- Developing Applications for the CN2G
- Installing Applications on the CN2G
- Launching Your Application Automatically
- Upgrading Your CN2G

## **Developing Applications for the CN2G**

The CN2G Handheld Computers run applications programmed in Microsoft Embedded Visual C++. The CN2G can also run applications developed for the .NET Compact Framework using Microsoft C# and Visual Basic .NET.

Use this section to understand what you need to:

- Develop a new application for the CN2G.
- Develop a web-based application for the CN2G.

### **Developing a New Application**

Use the Intermec Developer's Toolkits for AIT-III CD to help develop your C++ and .NET applications. The CD contains two toolkits, the Intermec AIT-III Developer's Toolkit and the Intermec AIT-III .NET Developer's Toolkit. The toolkits include hardware and software requirements, all of the functions that are supported by the CN2G, and instructions on how to use these functions.

The Developer's Toolkits for AIT-III is available on CD (P/N 074925) or as a download from the Intermec web site at [www.intermec.com/AIT](http://www.intermec.com/AIT).

You need these hardware and software components to use the Intermec toolkits:

- Pentium PC, 400 MHz or higher
- Windows 2000 (Service Pack 2 or later) or Windows XP (Home, Professional, or Server)
- For native C++ development, Microsoft eMbedded Visual C++ version 4.0 with eVC++ Service Pack 2
- For .NET Development and Compact Framework (C# and VB.NET), Microsoft Visual Studio .NET 2003
- 128MB RAM (196MB recommended)
- 360MB hard drive space for minimum installation (720MB for complete)

### **Chapter 3 — Developing and Installing Applications**

- CD-ROM drive compatible with multimedia PC specification
- VGA or higher-resolution monitor (Super VGA recommended)
- Microsoft Mouse or compatible pointing device

#### **Developing a Web-Based Application**

You can develop web-based data collection applications for use on the CN2G. For help, see any HTML source book. The CN2G contains Internet Explorer (IE) 6.0 for Windows CE for you to use. The Microsoft standard IE 6.0 is available from the desktop and provides all of the common elements you expect to find.

##### **To open Microsoft Internet Explorer**

- Double-tap **Internet Explorer** from the desktop. The Internet Explorer default window appears.

#### **Installing Applications on the CN2G**

There are several ways you can install applications on the CN2G:

- You can package your application as a cabinet (.cab) file.
- If you have a simple application, you may only need to deliver the .exe file.
- You can copy a directory structure that contains the application, supporting files, DLLs, images, and data files.

Intermec recommends using CAB files to install your applications. The CN2G uses standard Windows CE CAB files and will install third-party CAB files. After the CN2G executes a CAB file, it deletes the file. To keep your CAB files so that they can be installed when you perform a cold boot, you need to save them to the \DiskOnChip\Persistent Copy\CABFiles directory. On a cold boot, the CAB files are copied to the \CABFiles directory in the object store where they are executed and deleted. The original copy remains in the \DiskOnChip\Persistent Copy\CABFiles directory to be installed on the next cold boot.

### **Chapter 3 — Developing and Installing Applications**

Intermec recommends that you store your applications in a folder specific to your application underneath the \PROGRAM FILES folder. Intermec recommends that you store your application data in one of these locations on the CN2G:

- The SDMMC Disk folder
- The DiskOnChip folder

If you have an SD card inserted in your CN2G, it appears as the SDMMC Disk folder. This folder is the recommended location for placing your application install files.

The DiskOnChip folder is an area of storage that is part of the CN2G flash memory. This storage area is not deleted during a cold boot.

There are several ways you can install files and applications on the CN2G:

- ActiveSync
- SD Card
- Wavelink Avalanche

The following sections explain how to use each one of these processes to install your application on the CN2G.

#### **Installing Applications Using ActiveSync**

You can use ActiveSync to establish a connection between your PC and the CN2G. ActiveSync allows you to transfer files, synchronize files, perform remote debugging, and other device management activities. ActiveSync is a free application available from the Microsoft web site.

To establish a partnership between your PC and the CN2G, you need:

- a USB cable.
- a CN2 communications dock (P/N 074248).
- ActiveSync version 3.7.1 or later.

#### **Installing ActiveSync and Establishing a Partnership**

You can use a USB cable to establish your initial partnership between the CN2G and your PC.

### To install ActiveSync and establish a partnership

- 1 Download ActiveSync from the Microsoft web site and follow the onscreen instructions for installing it on your PC. When the installation process is complete, the Get Connected dialog box appears.



- 2 Connect the CN2G to your PC with the CN2 communications dock and a USB cable.
- 3 Click **Next** in the Get Connected dialog box. ActiveSync detects a device on the USB port and prompts you to set up a new partnership.
- 4 In the Set Up a Partnership dialog box, click **Next**.
- 5 In the Select Number of Partnerships dialog box, select **Yes, I want to synchronize with only this computer**, and then click **Next**.
- 6 In the Select Synchronization Settings dialog box, check the items you want to synchronize and click **Next**.
- 7 In the Setup Complete dialog box, click **Finish**.

When the partnership has been established, the following screen appears on your PC showing the device name of your CN2G and the Connected status.

### Chapter 3 — Developing and Installing Applications

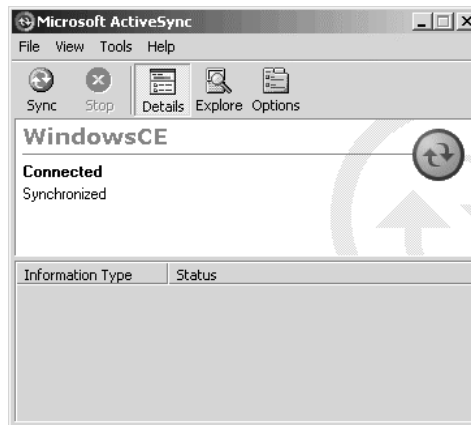

**The Microsoft ActiveSync Screen**

An ActiveSync icon (🌐) also appears on the CN2G status bar indicating that it has established an ActiveSync partnership with your PC.



**Note:** If ActiveSync does not establish a partnership on the first try, the Get Connected dialog box appears on your PC with the message “Your device was not detected.” Make sure all of your cables are securely connected and click **Next** on the Get Connected dialog box until your device is detected. You may need to remove the CN2G from the communications dock, and then insert it back into the communications dock to establish a partnership.

After the partnership is established, ActiveSync initiates all future connections. To connect to your PC using ActiveSync in the future, simply place a CN2G in the communications dock and turn on the CN2G.

#### **Using ActiveSync to Copy Files and Install Applications**

You can use ActiveSync to copy files to the CN2G and to install applications. Use the following procedures to learn how to copy files and install applications on the CN2G using ActiveSync.



## Chapter 3 — Developing and Installing Applications

### To install an application on the CN2G using ActiveSync

- 1 Connect the CN2G to your PC using ActiveSync. For help, see the previous section, “Installing ActiveSync and Establishing a Partnership.”
- 2 On the Microsoft ActiveSync screen, click **Explore**. Windows Explorer opens the Mobile Device window of your CN2G.



- 3 In Windows Explorer on your PC, browse to the file that you want to copy to your CN2G.
- 4 Right-click the file and click **Copy**.
- 5 Place the cursor in the SDMMC Disk or DiskOnChip folder of your CN2G, right-click, and click **Paste**.

The file is copied to the CN2G and you can see it using My Computer on the CN2G.

- 6 Navigate to your application file and run it.

After your application is installed, you can run it from the Program files folder from My Computer.

## **Installing Applications Using Your SD Card**

Using your SD card is the best method for you to install applications.

### **To install applications using the SD card**

- 1** If you are using an SD card reader, remove the SD card from the CN2G and place it in the reader. For help, see “Using the SD Card” on page 16.
- 2** Copy your application file to the SD card.  
If you are using ActiveSync or Wavelink Avalanche to copy the files to the SD card, place the application in the SDMMC Disk folder located in My Computer.
- 3** If you are using an SD card reader, insert the SD card back into the CN2G.
- 4** Navigate to the SDMMC Disk folder and run your application.

After your application is installed, you can run it from the Program files folder from My Computer.

## **Installing Applications Using Wavelink Avalanche**

You can use the Wavelink Avalanche device management system to install applications on all of your wireless CN2Gs. The CN2G ships with the Avalanche Enabler already loaded on it.

Each time the Avalanche Enabler is activated (typically on a warm boot), the CN2G attempts to connect to the Avalanche Agent. When the CN2G connects to the agent, the Agent determines whether an update is available and immediately starts the software upgrade, file transfer, or configuration update.

### **To use Avalanche to remotely manage the CN2G**

- 1** Install software packages and updates for the CN2G using the Avalanche Administrative Console.
- 2** Schedule the CN2G updates or manually initiate an update using the Avalanche Administrative Console.

### Chapter 3 — Developing and Installing Applications

For more information on using Wavelink Avalanche, contact your local Intermec representative or visit the Wavelink web site at [www.wavelink.com](http://www.wavelink.com).

## Launching Your Application Automatically

To launch your application automatically on the CN2G every time you perform a warm or cold boot, make sure your CAB file places a shortcut to your application in the \Windows\StartUp folder.

## Upgrading Your CN2G

When you upgrade your CN2G, you are updating these two components:

- Operating system (OS)
- Persistent Storage Manager (PSM) files

## Upgrading the Operating System

When you upgrade the operating system, you erase the current configuration and replace it with the new default configuration. You will need to set the network communications parameters on the CN2G to reestablish communications with the other devices in the wireless network.

There are two ways to upgrade the OS:

- You can upgrade your computer using an SD card.
- You can remotely upgrade your computer using Intermec Settings.

### Upgrading the Operating System Using an SD Card

To upgrade the OS, you need:

- an SD card formatted as FAT16.
- an SD card reader.
- the latest upgrade ZIP file. This file is available from the Intermec web site at [www.intermec.com](http://www.intermec.com). Go to **Service & Support > Downloads**. Make sure the file you select is for your language and that it has an SD at the end of the file name.

### Chapter 3 — Developing and Installing Applications

For information on how to remove the SD card, see “Using the SD Card” on page 16.

#### To upgrade the operating system

- 1 Download the latest upgrade ZIP file from the Intermec web site to your desktop PC.
- 2 Unzip the files on your desktop PC.
- 3 Place the SD card in the SD card reader.
- 4 Copy the nk.bin and eboot.bin files to your SD card. Place the files in the SDMMC Disk folder.
- 5 Insert the SD card into the CN2G.
- 6 Open the battery door and remove the battery.
- 7 Using the end of the stylus, press the **Reset** button on the inside of the battery compartment.

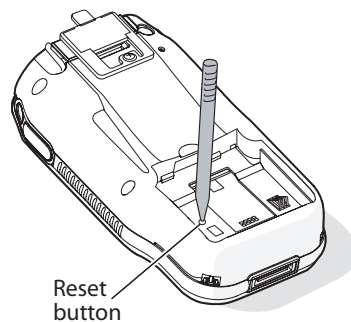

**Do not use force or a sharp object when pressing the Reset button. You may damage the Reset button.**

- 8 While holding the ▼ key, install the battery. Keep holding the ▼ key until the CN2 Bootloader Menu appears.
- 9 Install the battery door and place the CN2G in a communications dock.
- 10 Use the arrow keys to select **Update OS + Bootloader**, and press **Enter**. Messages about the download status appear at the bottom of the screen.

### Chapter 3 — Developing and Installing Applications

The “Need Reboot” message appears and **Cold Boot** is selected.

- 11 Press **Enter**. The CN2G cold boots and the Refreshing File System status box appears.
- 12 If the Confirm File Replace dialog box appears, tap **Yes To All**. The CN2G finished rebooting, and your operating system is updated.

#### Upgrading the Operating System Remotely Using Intermec Settings

You can use Intermec Settings to upgrade the operating system on your Intermec CN2G through an ActiveSync connection. For information on installing ActiveSync and establishing a partnership, see “Installing Applications Using ActiveSync” on page 52.

When you remotely upgrade your computer, you are updating the operating system and the Persistent Storage Memory (PSM) files. Before you can upgrade your computer, you need:

- The Intermec Settings application. This file is available from the Intermec web site as part of the Intermec Developer’s Library (IDL) download or from the IDL CD.
- The device upgrade ZIP file. This file is available from the Intermec web site at [www.intermec.com](http://www.intermec.com). Go to **Service & Support > Downloads**. Make sure the file you select is for your language and that it has Intermec Settings at the end of the file name.

#### To remotely upgrade a CN2G using Intermec Settings

- 1 Install the Intermec Settings application on your PC.
- 2 Create a device upgrade folder and unzip the device upgrade files to it.
- 3 On your PC, go to **Start > Programs > Intermec > Intermec Settings > Upgrade Device**.
- 4 In the Select upgrade folder dialog box, browse to the folder containing your upgrade files and click **OK**.

### Chapter 3 — Developing and Installing Applications

Intermec Settings begins the upgrade process. When the next message box appears on the PC screen, you can remove the CN2G and place it in a powered dock.

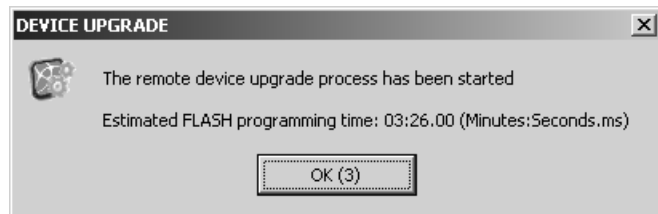

The CN2G updates the system and then cold boots.

- 5 If you need to upgrade more CN2Gs, place another CN2G in the communications dock and the remote device upgrade starts automatically.
- 6 When you are done upgrading CN2Gs, choose **File > Exit** from the Main Menu.

### Upgrading the Persistent Storage Manager Files

To upgrade the Persistent Storage Manager (PSM) files for your CN2G, you need:

- the device upgrade ZIP file containing the PSM files. This file is available from the Intermec web site at [www.intermec.com](http://www.intermec.com). Go to **Service & Support > Downloads**.
- an SD card reader.

#### To upgrade the PSM files

- 1 Copy the device upgrade ZIP file to your PC, and unzip the PSM files. You should see these folders:
  - 2577
  - DOImage
- 2 Remove the SD card from the CN2G and place it in the SD card reader. For help, see “Using the SD Card” on page 16.
- 3 Copy the 2577 and DOImage folders to the SD card.
- 4 Install the SD card in your CN2G.

### **Chapter 3 — Developing and Installing Applications**

- 5** Cold boot your CN2G. For help, see “Cold Booting the CN2G” on page 71. A dialog box appears telling you that it is updating the PSM. When this process is complete, the CN2G cold boots again and installs the files.

After the CN2G cold boots, the Refreshing the File System dialog box appears. Your CN2G is loaded with the new PSM files.

- 6** Remove the SD card.

### ***Chapter 3 — Developing and Installing Applications***





## **4 Troubleshooting and Maintaining the CN2G**

Use this chapter to solve problems you may encounter while using the CN2G. You will also find information on booting the computer and routine maintenance.

If you have any problems using the CN2G, look in this chapter to find a possible solution. This chapter consists of the following sections:

- Problems While Operating the CN2G
- Problems While Configuring Security
- Problems With Wireless Connectivity
- Problems While Scanning Bar Codes
- Booting the CN2G
- Cleaning the Scanner Window and CN2G Screen

## Problems and Solutions

If you send the CN2G in for service, it is your responsibility to save the computer data and configuration. Intermec is responsible only for ensuring that the keypad and other hardware features match the original configuration when repairing or replacing your computer.

### Problems While Operating the CN2G

Problem	Solution
You press the <b>Power</b> key to turn on the CN2G and nothing happens.	<p>Make sure you have a charged battery installed correctly. For help, see “Installing and Charging the Battery” on page 4.</p> <p>The battery may be discharged. Replace the battery with a spare charged battery, or charge the battery and try again.</p>
You press the <b>Power</b> key to turn off the CN2G and nothing happens.	<p>If the CN2G is processing data, it may not turn off when you press the <b>Power</b> key. Wait until the CN2G finishes processing.</p> <p>If the CN2G appears to be locked up, warm boot the CN2G. For help, see “Warm Booting the CN2G” on page 70.</p> <p>If the CN2G does not respond to a warm boot, see “Cold Booting the CN2G” on page 71.</p>
The CN2G screen is not responding to the stylus.	<p>Try these possible solutions in order:</p> <ul style="list-style-type: none"><li>• Recalibrate the screen. For help, see “Calibrating the Screen” on page 12.</li><li>• Press and hold the <b>Power</b> key for approximately 2 seconds, and then release it to turn off the CN2G. Press the <b>Power</b> key again to turn on the CN2G.</li></ul>
You place the CN2G in the communications dock, and the Battery light turns on and is orange.	<ul style="list-style-type: none"><li>• The temperature may not be within the charging range. Make sure that the temperature is from 0°C to 45°C (32°F to 113°F).</li><li>• The battery may be damaged. Replace the battery.</li></ul>

## Chapter 4 — Troubleshooting and Maintaining the CN2G

### Problems While Operating the CN2G (continued)

Problem	Solution
The CN2G appears to be locked up and you cannot enter data.	<p>Try these possible solutions in order:</p> <ul style="list-style-type: none"><li>• Wait at least 10 seconds and try again. If the CN2G is still connecting to the Intermec Application Server or the host, it ignores any input from the keypad or scanner.</li><li>• Press and hold the <b>Power</b> key for approximately 2 seconds, and then release it to turn off the CN2G. Press the <b>Power</b> key again to turn on the CN2G.</li><li>• Perform a warm boot on the CN2G. For help, see “Warm Booting the CN2G” on page 70.</li><li>• Perform a cold boot on the CN2G. For help, see “Cold Booting the CN2G” on page 71.</li><li>• Try reloading the firmware. For help, see “Upgrading Your CN2G” on page 57.</li><li>• If the CN2G will not boot or reset, contact your local Intermec service representative for help.</li></ul>

### Problems While Configuring Security

Problem	Solution
The CN2G indicates that it is authenticated, but it does not communicate with the host.	Make sure that the CN2G IP address, host IP address, subnet mask, and default router are properly configured for your network.
The CN2G does not appear to be authenticating and a network connection icon does not appear on the status bar. To see a list of network connections icons, see “Understanding the Screen Icons” on page 12.	<p>The CN2G may not be communicating with your access point. Make sure the network name on the CN2G is the same as the network name (SSID) of the access point that you are trying to communicate with. The default network name is “INTERMEC.”</p> <p>The 802.1x security network may not be active. Make sure that the server software is properly loaded and configured on the server PC. For help, see the documentation that shipped with your server software.</p>

## Chapter 4 — Troubleshooting and Maintaining the CN2G

### Problems While Configuring Security (continued)

Problem	Solution
A network connection icon appears in the status bar, but it disappears.	<p>The CN2G may not be communicating with the access point that you want it to communicate with. Make sure that the network name on the CN2G is the same as the network name of the access point that you are trying to communicate with. The default network name is “INTERMEC.”</p> <p>The access point that you are trying to communicate with may not be communicating with the server. Make sure your access point is turned on, properly configured, and has 802.1x security enabled.</p>
You receive a message saying, “The server certificate has expired or your system date is incorrect” after you cold boot the CN2G.	The date and time on the CN2G are not saved through a cold boot. You need to re-enter the date and time and then save your changes.
The CN2G indicates that it is not authenticated.	<p>Make sure that:</p> <ul style="list-style-type: none"><li>• The User Name and Password parameters on your CN2G match the user name and password on your authentication server. You may need to re-enter the password on both your CN2G and the authentication server.</li><li>• On your authentication server, the user and group are allowed and the group policy is allowed to log in to the server. For help, see the documentation that shipped with your authentication server software.</li><li>• The IP address and secret key for your access point must match the IP address and secret key on your authentication server. You may need to re-enter the IP address and secret key on both your access point and authentication server.</li><li>• The authentication server software is running on the server PC.</li></ul>
You are setting up multiple access points in a network, with different SSIDs, and the connection fails.	The CN2G does not save WEP key values when you change the SSID. Re-enter the WEP key value after you change the SSID and save your changes. You should now be able to connect to the different access points.

## Problems With Wireless Connectivity

Problem	Solution
<p>When you turn on the CN2G after it was suspended for a while (10-15 minutes or longer), it can no longer send or receive messages over the network.</p>	<p>The CN2G may not be recognizing the network card. Turn off the CN2G, and then turn it on again.</p> <p>The host may have deactivated or lost your current terminal emulation session. In a TCP/IP direct connect network, you need to turn off the “Keep Alive” message (if possible) from the host so that the TCP session is maintained while a CN2G is suspended.</p>
<p>The network connection icon is in the status bar, but the host computer is not receiving any data from the CN2G.</p>	<p>In a UDP Plus network, there may be a problem with the connection between the Intermec Application Server and the host computer. Check with your network administrator or see the user’s manual for the Intermec Application Server.</p> <p>In a TCP/IP network, there may be a problem with the connection between the access point and the host computer. Check with your network administrator or use your access point user’s manual.</p>
<p>The no network connection icon (🔌) appears on the status bar. The CN2G is not communicating with the access point.</p>	<p>The CN2G is not connected to the access point. Make sure the access point is turned on and operating. You may also be using the CN2G out of range of an access point. Try moving closer to an access point to re-establish communications.</p> <p>Make sure the CN2G is configured correctly for your network. The radio parameters on the CN2G must match the values set for all access points the CN2G may communicate with. For help, see “Configuring 802.11b Radio Communications” on page 27.</p> <p>If you have an 802.11b radio, the radio initialization process may have failed. Try resetting the CN2G. See “Booting the CN2G” on page 70.</p> <p>If you have tried these possible solutions and the no network connection icon still appears, you may have a defective radio card. For help, contact your local Intermec service representative.</p>

## Chapter 4 — Troubleshooting and Maintaining the CN2G

### Problems With Wireless Connectivity (continued)

Problem	Solution
The CN2G is connected to the Intermec Application Server or host computer and you move to a new site to collect data. The network connection icon was visible but now the no network connection icon (  ) is visible.	You may have gone out of range of an access point. Try moving closer to an access point or to a different location to re-establish communications. Once you are in range again, the network connection icon appears again. Any data you collected while out of range is transmitted over the network.

### Problems While Scanning Bar Codes

Problem	Solution
You cannot see a red beam of light from the scanner when you press the <b>Scan</b> button or one of the <b>Side Scan</b> buttons and aim the scanner at a bar code label.	<p>There are three possible problems:</p> <ul style="list-style-type: none"><li>• You may be too far away from the bar code label. Try moving closer to the bar code label and scan it again.</li><li>• You may be scanning the bar code label “straight on.” Change the scanning angle and try again.</li><li>• The PSM files may not be correctly installed. For help, see “Upgrading the Persistent Storage Manager Files” on page 60.</li></ul> <p>You can test the effective range of the scanner. Move within 61 cm (2 ft) of a wall and test the scanner. You need to be within the scanning range to scan bar code labels. For help scanning bar codes, see “Scanning Bar Codes” on page 14.</p>
When you release the <b>Scan</b> button or <b>Side Scan</b> button, the Good Read light does not turn off.	The Good Read light will remain on if you configure the CN2G to use continuous/edge triggering. If you configure the CN2G for level triggering and the Good Read light remains on, there may be a problem. Press the <b>Scan</b> button or one of the <b>Side Scan</b> buttons again without scanning a bar code label. If the light is still on, contact your local Intermec service representative.

## Chapter 4 — Troubleshooting and Maintaining the CN2G

### Problems While Scanning Bar Codes (continued)

Problem	Solution
The scanner will not read the bar code label.	<p>Make sure you aim the scanner beam so it crosses the entire bar code label in one pass.</p> <p>The angle you are scanning the bar code label may not be working well, or you may be scanning the label “straight on.” Try scanning the bar code label again, but vary the scanning angle.</p> <p>The bar code label print quality may be poor or unreadable. To check the quality of the bar code label, try scanning a bar code label that you know will scan. Compare the two bar code labels to see if the bar code quality is too low. You may need to replace the label that you cannot scan.</p> <p>Make sure the bar code symbology you are scanning is enabled. Use Intermec Settings to check the symbologies. If your bar code symbology is disabled, enable it and then try scanning the bar code label again.</p> <p>Make sure that the application you are running on the computer is expecting input from a bar code. You may need to use the input panel to enter this information instead of scanning it.</p>
The scanner does not read the bar code labels quickly, or the scanning beam seems to be faint or obscured.	<p>The scanner window may be dirty. Clean the window with a solution of ammonia and water. Wipe dry. Do not allow abrasive material to touch the window.</p>
You scan a valid bar code label to enter data for your application. The data decoded by the CN2G does not match the data encoded in the bar code label.	<p>The computer may have decoded the bar code label in a symbology other than the label’s actual symbology. Try scanning the bar code label again. Make sure you scan the entire label.</p> <p>To operate the computer quickly and efficiently, you should only enable the bar code symbologies that you are going to scan.</p>

## Booting the CN2G

You seldom need to warm or cold boot the CN2G. The CN2G uses the configuration currently saved in flash memory during the boot process.

You need to boot the CN2G when an application is locked up and will not respond, when you upgrade the firmware, or when you reflash the computer. The next instructions explain how you warm and cold boot the CN2G.

### Warm Booting the CN2G

If your charged CN2G does not resume after pressing the **Power** key, or if the computer or an application is locked up, you may need to warm boot it.

#### To warm boot the CN2G using the Warm Boot button

- Using the end of the stylus, press the **Warm Boot** button inside of the stylus holder.

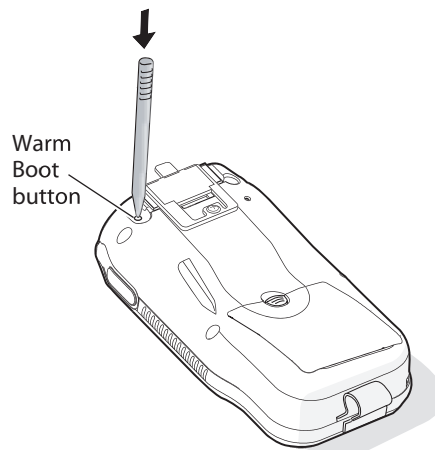

After approximately 10 seconds, the screen flickers. The Refreshing the File System dialog box appears, and the CN2G warm boots.



## Chapter 4 — Troubleshooting and Maintaining the CN2G

### To warm boot the CN2G using the Power key

- 1 Press and hold the **Power** key for approximately 10 seconds until the screen flickers.



**Note:** After about 8 seconds, the CN2G desktop appears briefly. Keep holding the **Power** key for another 2 seconds until the screen flickers.

- 2 Release the **Power** key. The Refreshing the File System dialog box appears, and the CN2G warm boots.

### Cold Booting the CN2G

If the CN2G or application is locked up and does not respond to a warm boot, follow this procedure to perform a cold boot. When you perform a cold boot, all data in your RAM storage is deleted.

#### To cold boot the CN2G

- 1 Open the battery door and remove the battery.
- 2 Using the end of the stylus, press the **Reset** button on the inside of the battery compartment.

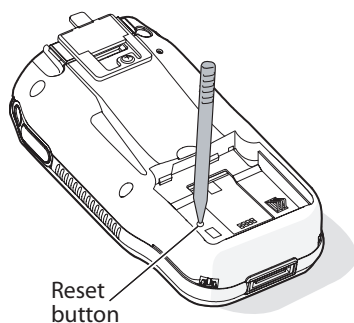

**Do not use force or a sharp object when pressing the Reset button. You may damage the Reset button.**

- 3 Install the battery and battery door.

After approximately 4 seconds, the CN2G starts the power on sequence.

## Chapter 4 — Troubleshooting and Maintaining the CN2G



**Note:** Date and time settings are not saved through a cold boot. You will need to reset the time and date.

### Cleaning the Scanner Window and CN2G Screen

To keep the computer in good working order, you may need to clean the scanner window.

Clean the scanner window as often as needed for the environment in which you are using the computer. To clean the CN2G, use a solution of ammonia and water.



**There are no user-serviceable parts inside the CN2G. Opening the unit will void the warranty and may cause damage to the internal components.**

#### To clean the scanner window

- 1 Press and hold the **Power** key for approximately 2 seconds, and then release it to turn off the CN2G.
- 2 Dip a clean towel or rag in the ammonia solution and wring out the excess. Wipe off the scanner window and screen. Do not allow any abrasive material to touch these surfaces.
- 3 Wipe dry.



# **A** Appendix

## Appendix A

# Physical and Environmental Specifications

Use this section to find technical information about the CN2G and its available features and options.

### Physical Dimensions

Length:	14.7 cm (5.8 in)
Width:	8.6 cm (3.4 in)
Thickness:	3.5 cm (1.4 in)
Weight:	370 g (11.9 oz)

### Power and Electrical Specifications

Operating:	Rechargeable 2150 mAh lithium-ion battery
Backup:	Rechargeable NiMH 20 mAh battery
Electrical rating:	⎓ 3.7 V; 1.5 A peak

### Temperature and Humidity Specifications

Operating:	0°C to 50°C (32°F to 122°F)
Storage:	-10°C to 50°C (14°F to 122°F)
Charging:	0°C to 45°C (32°F to 113°F)
Humidity:	5% to 95% relative humidity, non-condensing
Environmental rating:	IP64

### Screen Specifications

- RGB 240 x 320 pixels
- 8.9 cm (3.52 in) diagonal square active area, ¼ VGA

### Keypad

- 10-key function keypad

### Bar Code Symbologies

- Codabar
- Code 39
- Code 128
- Interleaved 2 of 5
- UPC/EAN

## **Accessories for the CN2G**

You can use these accessories (sold and ordered separately) with the CN2G. To order accessories, contact your local Intermec sales representative.

### **CN2 Battery (P/N 074201)**

Use the lithium-ion battery to provide main power to the computer.

### **CN2 Communications Dock (P/N 074248)**

Use the communications dock to charge your battery and provide power to your CN2G while still having the ability to communicate through a USB port.

### **CN2 Serial Adapter (P/N 074247)**

The serial adapter is a DB9 (9-pin) male serial connector that connects directly to the bottom of the CN2G.

### **AC Power Supply (P/N 074246)**

The power supply provides power to the CN2G and charges its battery when it is in the CN2 communications dock.

### **CN2 Holster (P/N 074490)**

The holster provides you with a convenient way to carry the CN2G when you are not using it.

### **CN2 Dust Cover (P/N 074103)**

The dust cover protects the CN2G keypad in dusty environments.

### **CAC Reader (P/N 074102)**

Attach the CAC reader module to your CN2G to read Common Access Cards (CACs).

## Appendix A

# Default Configuration

Use the following tables to see the default configuration settings of the CN2G. If you restore the CN2G to factory default settings, it will use these values. The tables are organized according to the options in Intermec Settings.

### Default Scanner Configuration

Symbology	Default Value
Codabar	Disabled
Code 39	Enabled
Code 128	Enabled
Interleaved 2 of 5	Disabled
UPC/EAN	Enabled

Symbology Options	Default Value
Preamble	No characters (disabled)
Postamble	No characters (disabled)
Global Symbology ID	Disable

Virtual Wedge Settings	Default Value
Virtual Wedge Enable	Enable
Grid	Null

### Default Communications Configuration

Communications Settings	Default Value
DHCP	Enable
Device Name	WindowsCE

**Default Communications Configuration (continued)**

<b>Name Servers Settings</b>	<b>Default Value</b>
Primary DNS	0.0.0.0
Secondary DNS	0.0.0.0
Primary WINS	0.0.0.0
Secondary WINS	0.0.0.0

<b>802.11 Radio Settings</b>	<b>Default Value</b>
Network Name	INTERMEC
Infrastructure Mode	Infrastructure
Security	
Security Choice	Microsoft
Infrastructure Mode	Infrastructure
Network Authentication	Open
Data Encryption	Disabled
802.1x Authentication	Disabled
Network Key Setting	Automatic
Network Key Index	Key 1
Radio Power Management	Disabled (CAM)

<b>UDP Plus Settings</b>	<b>Default Value</b>
UDP Plus Activate	Disable
Controller IP	0.0.0.0
Controller Port	5555
Ack Delay Upper Limit	5000 ms
Ack Delay Lower Limit	300 ms
Retries	7
Send Timer	20 sec
Receive Timer	45 sec

**Appendix A**

**Default Device Settings Configuration**

<b>Device Settings</b>	<b>Default Value</b>
Beeper Volume	Very high
Backlight Timeout	1 minute
Power Management	
User Idle	3 minute
System Idle	4 minute
Suspend	5 minute





## Index

### Symbols and Numbers

- key, *See* shift key
- 802.11b radio communications, configuring, 27
- 802.1x security
  - configuring
    - overview, 39
    - with Funk, 40
    - with Microsoft, 41
  - troubleshooting, 65 to 66

### A

- AC power supply, accessory described, 75
- accessing F3 to F5, 7
- accessories, described, 75
- ActiveSync
  - installing and establishing a partnership, 52
  - using to copy and install files, 54
  - using to install applications, 52
- AIT-III Developer's toolkit, using to develop applications, 50
- application
  - developing
    - web-based, 51
    - with toolkit, 50
  - installing with
    - ActiveSync, 52
    - Avalanche, 56
    - SD card, 56
  - launching automatically, 57
  - storing on the CN2G, 52
- audio feedback, *See* beeps
- authentication, troubleshooting 802.1x security, 65 to 66
- automatically launching your application, 57
- Avalanche, *See* Wavelink Avalanche

### B

- bar codes
  - scanning
    - how to, 14
    - troubleshooting, 68 to 69
  - supported symbologies, 74
  - symbologies, default, 14

### battery

- accessory, described, 75
  - charging, 4
  - checking status, 6
  - described, 75
  - installing, 4
  - maximizing life, 5
  - status icons, 6
  - using, 3
  - battery light, described, 13
  - beeper volume, changing, 14
  - beeps, understanding, 14
  - booting
    - CN2G, 70
    - cold, 71
    - warm, 70
  - button
    - Reset, 71
    - Scan, illustration, 2
    - Side Scan, illustration, 2
    - Warm Boot, 70
- ### C
- CAB file, using to install applications, 51
  - CAC reader, accessory described, 75
  - calibrating, touch screen, 12
  - card, SD
    - removing, 16
    - using to install applications, 56
    - using to store applications, 52
    - using to upgrade the operating system, 57
  - CCX v1.0 compliance, 3, 32
  - certificates, loading for security, 45
  - charging, battery, 4
  - CN2G
    - default configuration settings, 76, 78
    - description, 2
    - troubleshooting, guide to, 63
    - upgrading, 57
  - cold boot, 71
  - communications dock, accessory, described, 75
  - communications, default configuration settings, 76
  - configuration, default settings, 76

- configuring
  - 802.11b radio communications, 27
  - 802.1x security
    - configuring, 39
    - troubleshooting, 65 to 66
  - LEAP security, 42
  - parameters, 20
  - remotely with Intermec Settings, 25
  - security, 31
  - static WEP security, 43
  - TCP/IP network parameters, 28
  - UDP Plus network parameters, 30
  - USB communications, 26
  - using local Intermec Settings, 22
  - using Setup Assistant, 21
  - WPA security, 34
- converting writing to text, using
  - Transcriber, 10
- copy files to CN2G using
  - ActiveSync, 54
  - SD card, 56
  - Wavelink Avalanche, 56
- copyright information, x
- D**
  - default configuration
    - restoring, 24
    - settings, 76
  - desktop
    - illustration, 8
    - understanding, 9
  - developing applications using the
    - toolkit, 50
  - diagram, Intermec Settings, 23
  - dimensions, physical, 74
  - disabling security, 48
  - DiskOnChip folder, using to store
    - applications, 52
  - dust cover, accessory described, 75
- E**
  - electrical specifications, 74
  - Enroll Certificates application, 45
  - environmental specifications, 74
  - exiting Intermec Settings, 25
  - Extensible Authentication Protocol (EAP), 34
- F**
  - F3 to F5, accessing, 7
  - factory default settings, restoring, 24
  - Funk
    - configuring
      - 802.1x security, 40
      - WEP, 44
      - WPA security, 35
      - WPA-PSK, 36
    - selecting a profile, 33
    - selecting as security choice, 32
    - supplicant, using, 32
- G, H**
  - Good Read light
    - described, 13
    - troubleshooting, 68
  - gun, *See* CN2G
  - holster, accessory described, 75
  - host computer not receiving data,
    - troubleshooting, 67
  - humidity, specifications, 74
- I**
  - ICCU, *See* Intermec Settings
  - icons
    - battery status, 6
    - understanding screen, 12
  - Import Root utility, 45
  - installing
    - ActiveSync, 52
    - applications using the SD card, 56
    - battery, 4
  - Intermec AIT-III .NET Developer's
    - Toolkit, 50
  - Intermec AIT-III Developer's Toolkit, 50
  - Intermec Computer Command Reference Manual*, 23
  - Intermec Developer's Toolkits for AIT-III
    - CD, 50
  - Intermec Developer's Library (IDL), 50
  - Intermec Settings
    - exiting, 25
    - menu structure, illustrated, 23
    - navigating, 24
    - opening on the CN2G, 22
    - package for Wavelink Avalanche, 25

## Index

- Intermec Settings (*continued*)
  - using to configure the CN2G
    - remotely, 25
  - using to remotely upgrade, 59
- Internet Explorer, opening, 51
- K, L**
- keypad
  - 10-key illustration, 6
  - functions, accessing, 7
  - using, 6
- labels, scanning, 14
- launching applications automatically, 57
- LEAP security, configuring, 42
- lights, status, described, 13
- Lightweight Extensible Authentication Protocol (LEAP), described, 42
- loading certificates for security, 45
- M**
- manuals, downloading from web, viii
- maximizing battery life, 5
- menu structure, Intermec Settings, 23
- Microsoft ActiveSync, *See* ActiveSync
- Microsoft security, configuring
  - 802.1x security, 41
  - WEP, 44
  - WPA, 37
  - WPA-PSK, 38
- N, O**
- navigating in Intermec Settings, 24
- network protocols supported, 27
- no network connection icon,
  - troubleshooting, 67
- operating system, upgrading, 57
- operating the CN2G
  - humidity range, 74
  - temperature range, 74
  - troubleshooting, 64
- P**
- parameters, configuring CN2G, 20
- passphrase
  - setting for Funk WPA-PSK, 36
  - setting for Microsoft WPA-PSK, 39
- patent information, ix
- Persistent Storage Memory (PSM),
  - upgrading, 60
- physical
  - dimensions, 74
  - specifications, 74
- power key
  - illustration, 6
  - using, 7
- power specifications, 74
- power supply, accessory described, 75
- Pre-Shared key Mode, WPA, 34
- problems, finding and solving, 64
- profile, selecting for Funk security, 33
- Protected Extensible Authentication Protocol (PEAP), described, 39
- R**
- radio communications, configuring, 27
- remotely managing the CN2G, using
  - Avalanche, 56
- removing the SD card, 16
- Reset button, 71
- restoring default settings, 24
- S**
- safety
  - icons, viii
  - summary, vii
- Scan button
  - illustration, 6
  - troubleshooting, 68
- ScanDemo, using, 9
- scanner
  - default configuration settings, 76
  - troubleshooting, 68
- scanning bar codes, 14
  - described, 14
  - using ScanDemo application, 9
- screen
  - cleaning, 72
  - specifications, 74
  - See also* touch screen
- screen icons, understanding, 12
- SD card
  - removing, 16
  - using to copy and install files, 56

- SD card (*continued*)
  - using to install applications, 56
  - using to store applications, 52
- SDMMC disk, using to store applications, 52
- security
  - disabling, 48
  - loading certificates, 45
  - using the Funk supplicant, 32
- security choice, selecting Funk, 32
- security, configuring
  - 802.1x, 39
  - LEAP, 42
  - overview, 31
  - WEP, 43
  - WPA, 34
- serial adapter, accessory described, 75
- settings, restoring default, 24
- Setup Assistant, using to configure CN2G, 21
- shift key
  - illustration, 6
  - using, 7
- sounds, *See* beeps
- specifications
  - electrical, 74
  - humidity, 74
  - power, 74
  - screen, 74
  - temperature, 74
- start screen
  - illustration, 8
  - understanding, 9
- static WEP security, configuring, 43
- status
  - beeps, 14
  - checking battery, 6
  - lights, understanding, 13
- storing your application on the CN2G, 52
- stylus
  - troubleshooting, calibrating the touch screen, 12
  - using with touch screen, 8
- symbolologies, bar code
  - default, 14
  - supported, 74
- T**
- taskbar
  - described, 8
  - understanding, 9
- TCP/IP
  - network diagram, 28
  - network, configuring parameters, 28
- technical support, accessing on web, ix
- temperature, specifications, 74
- TKIP, using with WPA, 34
- touch screen
  - calibrating, 12
  - understanding icons, 12
  - using with stylus, 8
- Transcriber, using, 10
- Transport Layer Security (TLS), described, 39
- troubleshooting
  - bar code symbolologies, 68 to 69
  - configuring 802.1x security, 65 to 66
  - guide to finding solutions, 63
  - lost network connection after suspend, 67
  - operating the CN2G, 64
  - scanning bar codes, 68
  - wireless connectivity, 67
- U**
- UDP Plus
  - network diagram, 30
  - network, configuring parameters, 30
- understanding
  - screen icons, 12
  - status lights, 13
- upgrading
  - operating system with an SD card, 57
  - operating system with Intermec Settings, 59
  - Persistent Storage Memory (PSM), 60
- USB communications
  - configuring, 26
  - network diagram, 26
- User Certificates utility, 45
- using
  - battery, 3
  - power key, 7
  - SD card, 16

## **Index**

using (*continued*)  
  shift key, 7  
  touch screen, 8

### **W**

Warm Boot button, 70  
warm booting, 70  
warranty information, viii  
Wavelink Avalanche  
  package for CN2G, 25  
  using to copy and install files, 56  
  using to remotely manage the  
    CN2G, 56  
WEP security, configuring, 43

Wi-Fi Protected Access (WPA) security, 34  
wireless communications  
  configuring, 27  
  troubleshooting, 67 to 68  
WPA security  
  configuring with Funk, 35  
  configuring with Microsoft, 37  
  described, 34  
WPA-PSK security  
  configuring with Funk, 36  
  configuring with Microsoft, 38  
  described, 34  
writing on touch screen, converting with  
  Transcriber, 10





**Corporate Headquarters**  
6001 36th Avenue West  
Everett, Washington 98203  
U.S.A.

**tel** 425.348.2600

**fax** 425.355.9551

[www.intermec.com](http://www.intermec.com)

CN2G Handheld Computer User's Manual



P/N 074751-001