



# **Handbook for the Palm™ Tungsten™ T3 Handheld**



## Copyright

© 1998–2003 Palm, Inc. All rights reserved. Graffiti, HotSync, MultiMail, PalmModem, the Palm logo, and Palm OS are registered trademarks of Palm, Inc. Palm, Palm Powered, Tungsten, and VersaMail are trademarks of Palm, Inc. Palm, Inc. uses the Bluetooth and MPEG Layer-3 audio decoding technology trademarks under express license from their respective owners.

## Disclaimer and Limitation of Liability

Palm, Inc. assumes no responsibility for any damage or loss resulting from the use of this handbook.

Palm assumes no responsibility for any loss or claims by third parties which may arise through the use of this software. Palm, Inc. assumes no responsibility for any damage or loss caused by deletion of data as a result of malfunction, dead battery, or repairs. Be sure to make backup copies of all important data on other media to protect against data loss.

---

**IMPORTANT** Please read the End User Software License Agreement with this product before using the accompanying software program(s). Using any part of the software indicates that you accept the terms of the End User Software License Agreement.

---

# Contents

<b>Chapter 1: Setting Up Your Palm™ Tungsten™ T3 Handheld</b> .....	<b>1</b>
System requirements .....	1
Minimum requirements: Windows computers .....	1
Minimum requirements: Mac computers .....	2
Internet access requirements .....	2
Upgrade information .....	2
Step 1: Connect the HotSync® cradle to the computer .....	3
Step 2: Charge your handheld .....	3
Step 3: Set up your handheld .....	4
Step 4: Run Palm Setup Wizard .....	4
Congratulations! .....	4
Additional software .....	5
Performing a daily HotSync operation .....	5
<b>Chapter 2: Exploring Your Handheld</b> .....	<b>7</b>
Opening and closing your handheld .....	7
Locating front panel controls .....	8
Locating top and side panel components .....	9
Locating back panel components .....	10
Using the protective cover .....	11
Adding an expansion card .....	12
Elements of the handheld interface .....	13
Displaying online tips .....	15
Using the navigator .....	15
Using the status bar .....	17
Changing system information .....	18
Using Bluetooth and connecting to the network from the status bar ....	18
Rotating the screen .....	19

<b>Chapter 3: Entering Data on Your Handheld</b> .....	<b>21</b>
Using the onscreen keyboards .....	21
Using Graffiti® 2 writing .....	22
Writing in Graffiti 2 input areas .....	22
Using Full-screen Writing .....	23
Graffiti 2 character set .....	24
Graffiti 2 ShortCuts .....	29
Beaming data .....	29
Sending data .....	31
Sending data using Bluetooth™ communication .....	32
Sending data using e-mail or SMS communication .....	32
Using your computer keyboard .....	32
Importing data .....	33
Importing data from a Windows computer .....	33
Importing data from a Mac computer .....	34
Using a portable keyboard .....	35
<b>Chapter 4: Working with Applications</b> .....	<b>37</b>
Opening applications .....	37
Opening expansion card applications .....	38
Switching between applications .....	38
Categorizing applications .....	39
Copying applications to or from an expansion card .....	39
Selecting copy settings .....	40
Using menus .....	41
Graffiti 2 menu commands .....	42
Performing common tasks .....	43
Creating records .....	43
Editing records .....	43
Deleting records .....	44
Purging records .....	44
Categorizing records .....	45
Finding information .....	47
Sorting lists of records .....	50
Attaching notes .....	51
Choosing fonts .....	52
Receiving alerts .....	53
Hiding or masking private records .....	54

---

Installing and removing applications . . . . .	54
Installing files and add-on applications . . . . .	54
Installing applications and files on a Windows computer . . . . .	55
Palm Quick Install tips . . . . .	58
Installing applications and files on a Mac computer . . . . .	59
Removing applications . . . . .	60
Removing Palm™ Desktop software . . . . .	61
<b>Chapter 5: Using Calendar . . . . .</b>	<b>63</b>
Working in Agenda View . . . . .	64
Setting Agenda View display options . . . . .	64
Working in Day View . . . . .	65
Setting Day View display options . . . . .	65
Scheduling an event . . . . .	66
Scheduling repeating or continuous events . . . . .	69
Setting an alarm for an event . . . . .	69
Setting an event location . . . . .	71
Rescheduling an event . . . . .	71
Using categories . . . . .	71
Working in Week View . . . . .	72
Working in Month View . . . . .	73
Setting Month View display options . . . . .	74
Working in Year View . . . . .	75
Spotting event conflicts . . . . .	75
Beaming events . . . . .	76
Viewing birthday events . . . . .	76
Using Calendar menus . . . . .	77
Record menu . . . . .	77
Option menu/Preferences . . . . .	77
<b>Chapter 6: Using Card Info . . . . .</b>	<b>79</b>
Reviewing Card Information . . . . .	79
Renaming a card . . . . .	79
Formatting a card . . . . .	80
Managing expansion cards . . . . .	80
Using Card Info help . . . . .	81

<b>Chapter 7: Using Contacts</b> .....	<b>83</b>
Creating a contact .....	83
Displaying additional contact fields .....	86
Selecting field types .....	86
Changing Contact details .....	88
Creating a business card .....	88
Making connections from Contacts .....	88
Using Contacts menus .....	91
<b>Chapter 8: Using Palm™ Dialer</b> .....	<b>93</b>
Configuring phone preferences and connecting to your mobile phone .....	93
Dialing a number .....	94
Redialing the most recently dialed number .....	94
Using speed dial .....	95
Dialing a number from the Call History list .....	96
<b>Chapter 9: Using Expense</b> .....	<b>97</b>
Adding expense items .....	97
Changing the date of an Expense item .....	98
Entering receipt details .....	98
Customizing the Currency pick list .....	99
Changing the default currency .....	100
Defining a custom currency symbol .....	100
Setting Show Options .....	101
Working with Expense data on your computer .....	101
Setting the automatic fill preference .....	102
<b>Chapter 10: Using Memos</b> .....	<b>103</b>
Creating memos .....	103
Reviewing memos .....	104
Using Memos menus .....	104
Record menus .....	104
Options menus .....	104
<b>Chapter 11: Using Note Pad</b> .....	<b>105</b>
Creating a note .....	105
Reviewing notes .....	106
Changing Note Pad color settings .....	106
Setting an alarm for a note .....	107
Using Note Pad menus .....	108

---

Record menu .....	108
Options menus .....	108
<b>Chapter 12: Using Phone Link .....</b>	<b>109</b>
What can you do with a phone connection? .....	109
Setting up a phone connection .....	110
Configuring network service settings for your phone .....	113
Updating the phone files on your handheld .....	115
Using phone connections .....	116
<b>Chapter 13: Using Palm™ Photos .....</b>	<b>119</b>
Viewing photos .....	119
Viewing photos in Thumbnail view .....	119
Viewing photos in List view .....	120
Viewing a slide show .....	122
Rotating photos .....	123
Viewing photo information .....	123
Creating an album .....	124
Filing photos in albums .....	124
Copying photos .....	125
Renaming or deleting an album .....	126
Beaming photos .....	126
Deleting photos .....	127
Working with photos on your computer .....	127
Using Palm Photos menus .....	128
Options menu .....	128
<b>Chapter 14: Using SMS .....</b>	<b>129</b>
Configuring phone preferences and connecting to your mobile phone ....	129
Using the navigator in SMS .....	130
Creating messages .....	130
Sending and receiving messages .....	131
Viewing messages .....	132
Working with draft messages .....	133
Adding a signature to a message .....	134
Sending data from another application .....	135
Setting SMS Preferences .....	135
Using SMS menus .....	138

<b>Chapter 15: Using Tasks</b> .....	<b>139</b>
Creating tasks .....	139
Setting priority .....	140
Checking off a task .....	140
Changing task details .....	141
Setting a due date .....	141
Setting an alarm .....	142
Scheduling repeating tasks .....	142
Display options .....	144
Using the display filters .....	144
Setting Tasks Preferences .....	145
<b>Chapter 16: Using Palm™ VersaMail™ Personal E-mail Software</b> .....	<b>147</b>
VersaMail™ application features .....	147
Getting started with the VersaMail application .....	147
Synchronizing an existing username .....	148
Upgrading a MultiMail/VersaMail database .....	148
Setting up and managing e-mail accounts .....	148
Account and connection types .....	149
Network e-mail account prerequisites .....	149
Creating an e-mail account .....	152
Editing e-mail accounts .....	160
Deleting an e-mail account .....	160
Selecting a different service for a given e-mail account .....	161
Adding ESMTP to an account .....	163
Troubleshooting account access problems .....	164
Getting, sending, and managing e-mail .....	164
Getting e-mail .....	164
Auto get mail with notification .....	167
Reading e-mail .....	175
Creating and editing mail folders .....	185
Creating and sending new e-mail .....	186
Working with URLs .....	197
Working with attachments .....	198
Deleting messages .....	208
Emptying the trash .....	210
Marking messages as read or unread .....	211
Setting preferences for getting and deleting e-mail .....	213
Adding or updating a Contacts record directly from a message .....	214



Synchronizing e-mail between the handheld and the desktop .....	215
Configuring account settings in HotSync Manager .....	215
Setting synchronization options and account settings .....	216
Synchronizing an account .....	226
Using SSL with the conduit .....	228
<b>Chapter 17: Using Voice Memo .....</b>	<b>229</b>
Creating a voice memo .....	230
Pausing and resuming a voice memo recording .....	230
Storing voice memos on an expansion card .....	232
Listening to voice memos .....	232
Setting an alarm for a voice memo .....	234
Using Voice Memo menus .....	234
V Memo menus .....	234
Options menus .....	235
<b>Chapter 18: Using Palm™ Web Pro .....</b>	<b>237</b>
What Web Pro looks like .....	238
Getting help in Web Pro .....	238
Disconnecting from and connecting to the Internet .....	238
Browsing the web on your handheld .....	239
Visiting a web page .....	239
Viewing different parts of a web page .....	240
Following a link .....	241
Returning to a web page you just visited .....	241
Returning to your home page .....	241
Downloading files and pages .....	242
Downloading a file to your handheld .....	242
Saving a page .....	243
Viewing and editing a saved page on the handheld .....	243
Viewing files on an expansion card .....	244
Viewing a file from another application .....	245
Refreshing a page .....	245
Viewing information about a web page .....	245
Using passwords .....	245
Copying and pasting text .....	246

Communicating with other users .....	246
Sending e-mail .....	247
Beaming a URL .....	247
E-mailing a URL .....	247
Bookmarking your favorite pages .....	248
Adding a bookmark .....	248
Visiting a bookmarked page .....	248
Editing information about a bookmark .....	249
Deleting a bookmark .....	250
Finding web pages you recently visited .....	250
Returning to a page you visited .....	250
Viewing a cached page .....	251
Clearing the History list .....	251
Changing page characteristics .....	251
Changing the default size of text .....	251
Changing display views .....	252
Changing link colors .....	252
Changing how images are downloaded .....	253
Changing your start and home page .....	253
Enabling or disabling autofill .....	254
Enabling or disabling cookies .....	255
Enabling or disabling JavaScript .....	255
Changing the size and content of the cache .....	256
Controlling how Web Pro accesses the Internet .....	257
Changing Network Preferences .....	258
Changing the proxy server .....	258
<b>Chapter 19: Using World Clock .....</b>	<b>261</b>
Viewing the time .....	261
Setting the primary location .....	262
Choosing a different primary location .....	264
Setting the secondary locations .....	264
Adding a location .....	264
Modifying a location .....	266
Removing a location .....	266
Setting an alarm .....	267
Using World Clock menus .....	267

---

<b>Chapter 20: Performing HotSync® Operations</b> .....	<b>269</b>
Selecting HotSync setup options .....	269
Customizing HotSync application settings .....	272
Conducting cradle/cable HotSync operations .....	274
Performing a cradle/cable HotSync operation: Windows computers ...	274
Performing a direct HotSync operation: Mac computers .....	276
Conducting IR HotSync operations .....	278
Preparing your computer for infrared communication .....	278
Performing an IR HotSync operation .....	280
Returning to cradle/cable HotSync operations .....	281
Conducting modem HotSync operations .....	282
Preparing your computer for a modem HotSync operation .....	282
Preparing your handheld for a modem HotSync operation .....	284
Selecting the conduits for a modem HotSync operation .....	286
Performing a modem HotSync operation .....	287
Conducting Bluetooth HotSync operations .....	287
Preparing your computer for a Bluetooth HotSync operation .....	287
Preparing your handheld for a Bluetooth HotSync operation .....	289
Performing a Bluetooth HotSync operation .....	289
Conducting network HotSync operations .....	290
Connecting to your company's dial-in server .....	290
Performing a network HotSync operation .....	293
Using File Link .....	293
Creating a user profile .....	293
Performing the first HotSync operation with a user profile .....	295
<b>Chapter 21: Setting Preferences for Your Handheld</b> .....	<b>297</b>
Accessing Preferences .....	298
Bluetooth Preferences .....	298
Turning Bluetooth communication on and off .....	299
Assigning a Bluetooth device name .....	299
Setting device discovery .....	300
Allowing Wakeup .....	301
Adding trusted devices .....	303
Enabling/disabling the user cache .....	305
Making Bluetooth connections .....	305
Buttons Preferences .....	306
HotSync Buttons Preferences .....	306
Pen Button Preferences .....	307

Color Theme Preferences .....	308
Connection Preferences .....	308
Editing connections .....	309
Creating Bluetooth connections .....	311
Date & Time Preferences .....	314
Digitizer Preferences .....	316
Formats Preferences .....	316
Graffiti 2 Preferences .....	317
Handedness Preferences .....	318
Keylock Preferences .....	318
Network Preferences .....	319
Creating and selecting network service profiles .....	320
Entering a user name .....	321
Entering a password .....	321
Selecting a connection .....	322
Adding telephone settings .....	322
Entering a prefix .....	323
Disabling Call Waiting .....	324
Using a calling card .....	324
Connecting to your service .....	325
LAN access points .....	326
Accessing the Internet with a Bluetooth phone or LAN access point ...	326
Adding detailed information to a network service profile .....	329
Defining primary and secondary DNS .....	330
Defining the IP address .....	330
Adding a Login script .....	331
Deleting a network service profile .....	333
TCP/IP troubleshooting .....	334
Owner Preferences .....	334
Phone Preferences .....	335
Power Preferences .....	336
Auto-off after .....	336
Stay on in Cradle .....	337
Beam Receive .....	337
Power on when opened and Power off when closed .....	337
Security Preferences .....	338
ShortCuts Preferences .....	344
Creating a ShortCut .....	344
Editing or delete a ShortCut .....	345

---

Sounds & Alerts Preferences .....	346
System Sound, Game Sound, and Alarm Sound settings .....	346
Alarm LED and Alarm Vibrate settings .....	347
<b>Appendix A: Maintaining Your Handheld .....</b>	<b>349</b>
Caring for your handheld .....	349
Prolonging battery life .....	350
Resetting your handheld .....	350
Performing a soft reset .....	351
Performing a hard reset .....	351
<b>Appendix B: Frequently Asked Questions .....</b>	<b>355</b>
Software installation problems .....	356
Operating problems .....	357
Tapping and writing problems .....	359
Application problems .....	359
HotSync problems .....	361
Beaming and sending problems .....	367
Phone connection problems .....	367
VersaMail™ e-mail software problems .....	369
Recharging problems .....	370
Password problems .....	370
Problems with incompatible applications .....	371
Finding a third-party application that is causing a problem .....	371
Technical support .....	373
<b>Product Regulatory Information .....</b>	<b>375</b>
<b>Index .....</b>	<b>379</b>



# Setting Up Your Palm™ Tungsten™ T3 Handheld

Your new Palm™ Tungsten™ T3 handheld enables you to stay organized and on time by keeping your appointments, contact information, and tasks in one place. You can easily capture your thoughts with the voice recorder and view digital pictures.

## System requirements

To install and operate Palm™ Desktop software, your computer system must meet the requirements described in this section.

### Minimum requirements: Windows computers

The minimum requirements for Windows computers are as follows:

- Pentium-class computer
- One of the following operating systems:
  - Windows NT 4.0 Workstation and SP6 or later (requires a serial cradle/cable—sold separately—and administrator rights to install Palm Desktop software)
  - Windows 98
  - Windows ME
  - Windows 2000 Pro (requires administrator rights to install Palm Desktop software)
  - Windows XP Home or Pro (requires administrator rights to install Palm Desktop software)
- Internet Explorer 4.01 with SP2 or later
- 50 megabytes (MB) available hard disk space
- VGA monitor or better (Palm Desktop software *Quick Tour* requires 256-color video display; 16 Bit or High Color, and 800 x 600 resolution recommended)
- CD-ROM or DVD-ROM drive
- Mouse
- One available USB port or serial port (serial cradle/cable sold separately)

## Minimum requirements: Mac computers

The minimum requirements for Mac computers are as follows:

- Mac computer with a PowerPC processor
- Mac OS 9, version 9.1 or later or Mac OS X, version 10.1.2 through 10.2.6
- 25MB available hard disk space
- Monitor that supports screen resolution of 800 x 600 or better
- CD-ROM or DVD-ROM drive
- Mouse
- One available USB port or serial port (serial cradle/cable sold separately and compatible with Mac OS 9 only)

## Internet access requirements

The requirements for Internet access are as follows:

- Any one of the following:
  - A Bluetooth mobile phone
  - An IR-enabled mobile phone
  - A mobile phone with a cable that connects to your handheld
  - A modem accessory for your handheld
  - A Bluetooth network connection with Internet access
- An account with an ISP, or Internet service provided by your company

**NOTE** A data connection service may also be required by some mobile phone network providers.

## Upgrade information

If you already own a Palm OS® handheld, go to the web site [www.palm.com/support/tungstenT3](http://www.palm.com/support/tungstenT3) for upgrade instructions.



## Step 1: Connect the HotSync® cradle to the computer

**IMPORTANT** Windows NT users cannot use a USB cradle/cable and port. You must use a cradle with a serial port connection (sold separately).

- a. Locate the USB icon and ports on your computer.
- b. Plug the USB connector into a USB port on your computer.
- c. Connect the adapter cable to the back of the cradle.

**NOTE** Your adapter may connect to the back of the USB connector, not to the cradle itself.

- d. Plug the adapter into a working electric outlet.

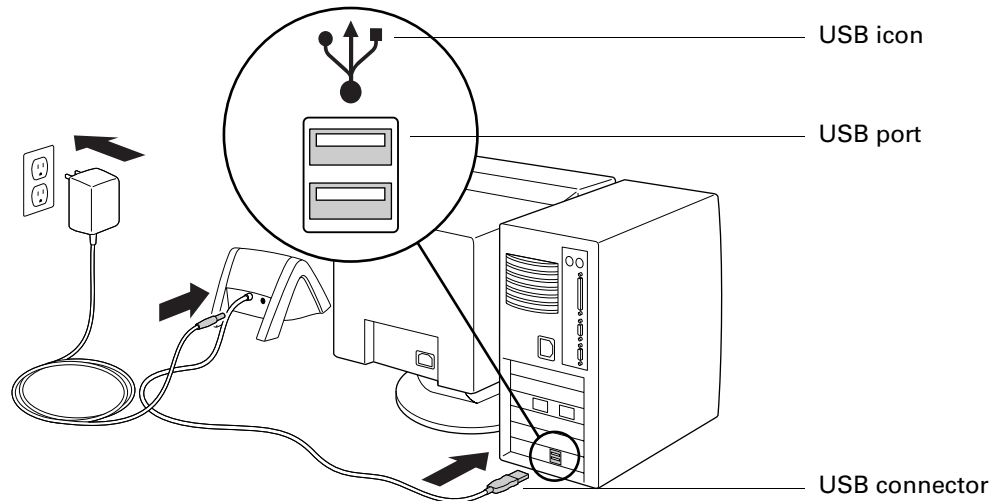

## Step 2: Charge your handheld

- a. Place your handheld in the cradle for at least two hours for an initial charge. Your handheld's indicator light glows steady green when it is charging.
- b. After it is charged, remove the handheld from the cradle by gently tilting it forward and then lifting it from the cradle.

Once your handheld is set up and in daily use it requires 15 to 30 minutes of charge time per day, depending on usage.

## Step 4: Run Palm Setup Wizard

- a. Insert the Software Installation CD-ROM into your computer's CD-ROM drive.
- b. Follow the onscreen instructions, which guide you through installing Palm Desktop software, performing your first HotSync® operation, and registering your handheld.

**NOTE** You need administrator rights to install Palm Desktop software on some operating systems.

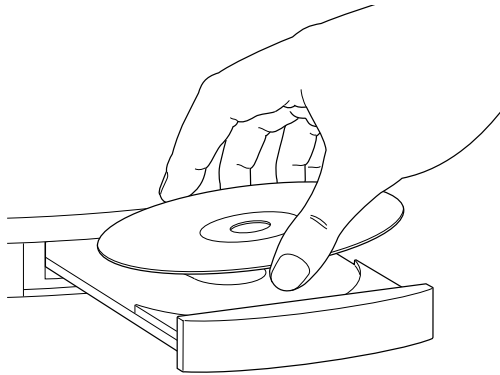

## Congratulations!

You've set up your handheld, installed Palm Desktop software, performed your first HotSync operation, and registered your handheld.

For more information about using Palm Desktop software, see the following:

- The online help for Palm Desktop software. To access the online help, go to the Help menu in Palm Desktop software.
- **Mac:** The electronic *Palm Desktop Software for the Macintosh User's Guide*. To access this guide, open the Palm folder, and then open the Documentation folder. Double-click the file Palm Desktop.pdf. (Adobe Reader must be installed to view the .pdf file.)

## Additional software

For details on using the multimedia applications included on your handheld and the Software Installation CD-ROM, go to [www.palm.com/support/tungstenT3](http://www.palm.com/support/tungstenT3) and click the link for Photos, Music & Videos Guide.

The Software Installation CD-ROM that came with your handheld includes software that lets you add a variety of functionality. Some applications require additional accessories or services sold separately. Also, you may need to download software from the Internet while installing some applications from the CD-ROM. See the individual software application documentation for information.

## Performing a daily HotSync operation

Performing a daily HotSync operation keeps your information current and protects your data.

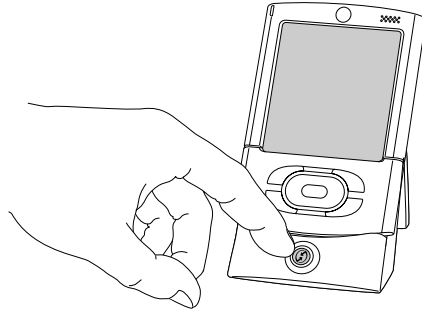

Place your handheld in the cradle and press the HotSync button.

**Tip:** You can also perform a HotSync operation using Bluetooth communication. For more information, see [“Performing a Bluetooth HotSync operation”](#) in [Chapter 20](#).

If you encounter a problem during a HotSync operation, see [“HotSync problems”](#) in [Appendix B](#).



## Exploring Your Handheld

Your Palm™ Tungsten™ T3 handheld can help you stay organized, on time, and in communication while you are away from your desk.

### Opening and closing your handheld

When your handheld is open, you can access additional controls on the front and back panels. You can use your handheld in either the open or closed position.

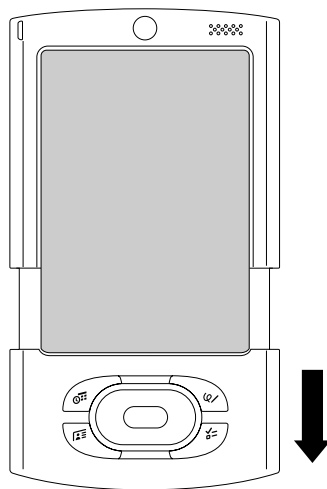

Slide the bottom portion of your handheld away from the screen.

## Locating front panel controls

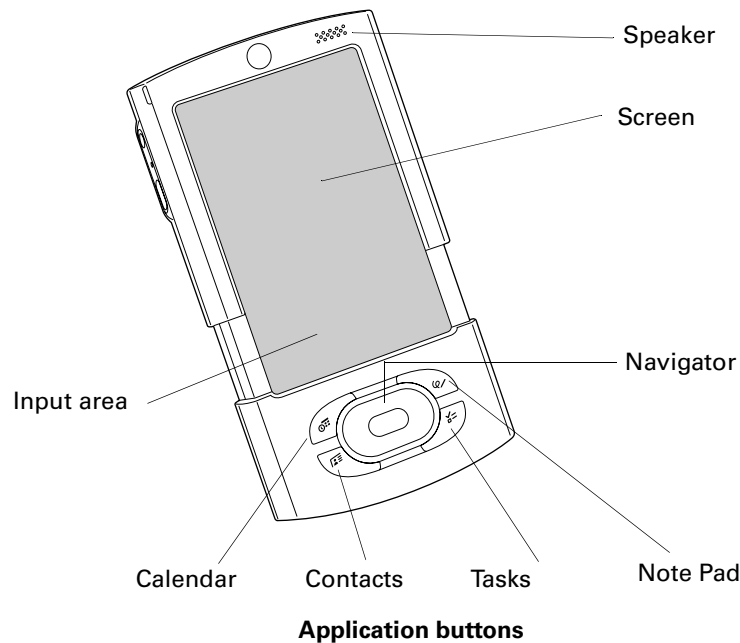

- Navigator** Select and display records on your handheld screen. See [“Using the navigator”](#) later in this chapter for additional information, and look for tips throughout this handbook.
- Application buttons** Activate the individual handheld applications that correspond to the icons on the buttons: Calendar, Contacts, Tasks, and Note Pad. See [“Buttons Preferences”](#) in [Chapter 21](#) for details on reassigning these buttons to activate any application on your handheld.
- Input area** Customize this area to display onscreen keyboards or an active writing area where you write letters and numbers using Graffiti® 2.
- Speaker** Listen to alarms, voice memos, music, and game sounds on your handheld.
- Screen** Display the applications and information stored in your handheld.

## Locating top and side panel components

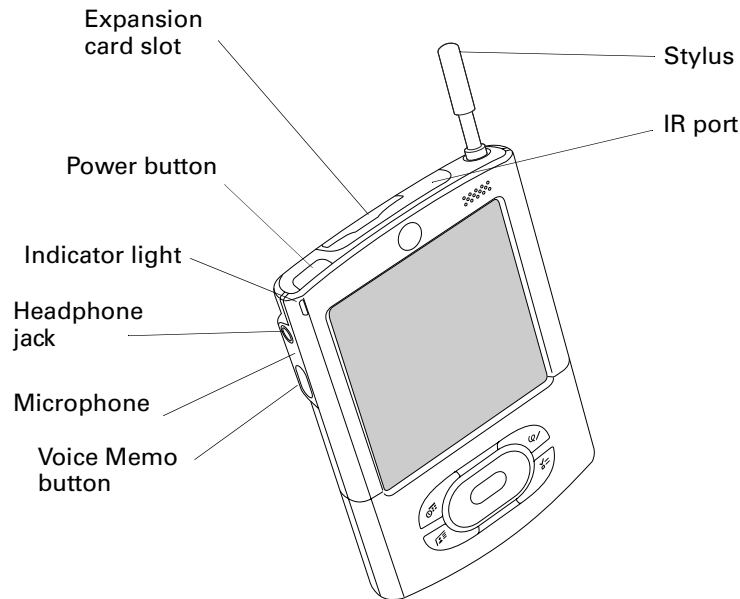

- Voice Memo button** Press and hold to record voice memos.
- Microphone** An audio input device for applications such as Voice Memo.
- Headphone jack** A jack to connect a standard 3.5mm stereo headphones (sold separately) to your handheld.
- Indicator light** The light serves as an alert and also indicates the battery-charging status when your handheld is in the cradle/cable.
- Power button** The button turns your handheld on or off.
- Expansion card slot** The slot accepts Secure Digital (SD), Secure Digital Input/Output (SDIO), or MultiMediaCard (MMC) expansion cards. Expansion cards enable you to back up data, add more memory, add wireless communication features, or use additional applications. (Expansion cards sold separately.)

- Stylus** The stylus is your writing and tapping tool. To use the stylus, gently press the top of the stylus to release it from the slot, and then pull it out of the slot and hold it as you would a pen or pencil.
- IR port** The port uses infrared technology to transmit data to and receive data from other infrared-enabled devices and to perform HotSync® operations. See [“Beaming data”](#) in [Chapter 3](#) and see [“Conducting IR HotSync operations”](#) in [Chapter 20](#) for more information.

## Locating back panel components

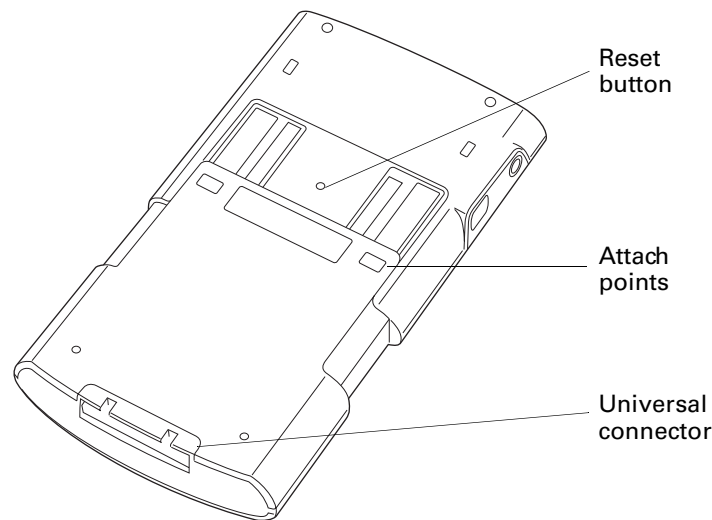

- Reset button** Resets your handheld. Under normal use, you should not have to use the reset button. See [“Resetting your handheld”](#) in [Appendix A](#) for information about when and how to use the reset button.
- Attach points** Enable you to connect optional accessories to your handheld, such as a modem or sled. These accessories are sold separately and are typically available from Palm and third-party developers.



**Universal connector** Connects your handheld to the cradle, which in turn connects to the back of your computer and through the AC adapter to the wall current. This enables you to recharge your handheld as well as update the information between your handheld and your computer, using HotSync technology.

The universal connector also connects peripheral hardware devices to your handheld, such battery pack, HotSync cable or portable keyboard (sold separately).

## Using the protective cover

The cover protects your handheld screen when it is not in use.

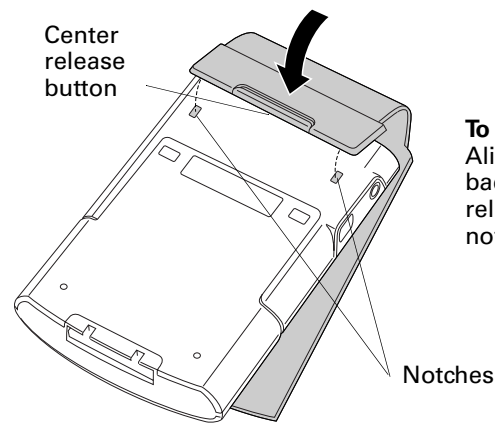

**To install the cover:**

Align the cover tabs with the notches on the back of your handheld, and then press the center release button while inserting the tabs into the notches.

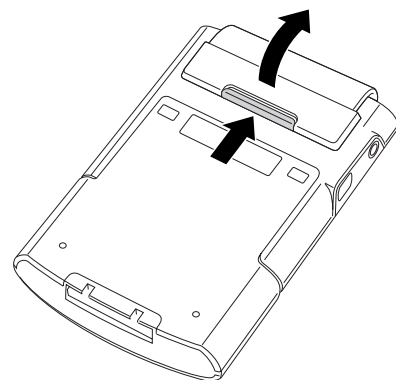

**To remove the cover:**

Press the center release button while lifting the cover from the back of the handheld.

## Adding an expansion card

An expansion card (sold separately) increases the variety of tasks you can do and the amount of space you have for software and data on your handheld.

### To insert a card:

1. Insert the card into the expansion slot with the label side facing the display.
2. Push lightly against the card with your thumb.

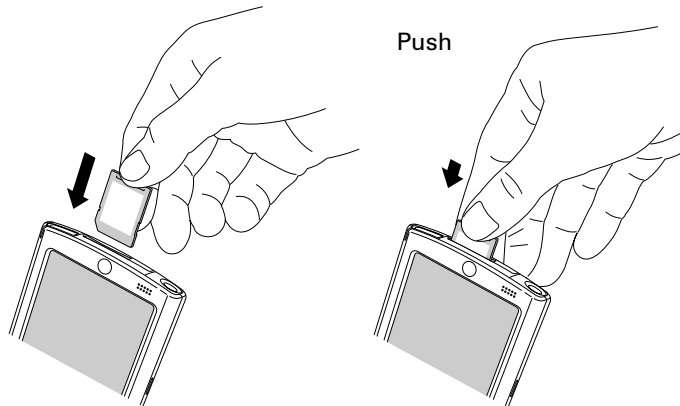

### To remove a card:

1. Push lightly against the card with your thumb.
2. Slide the card out of the expansion slot.

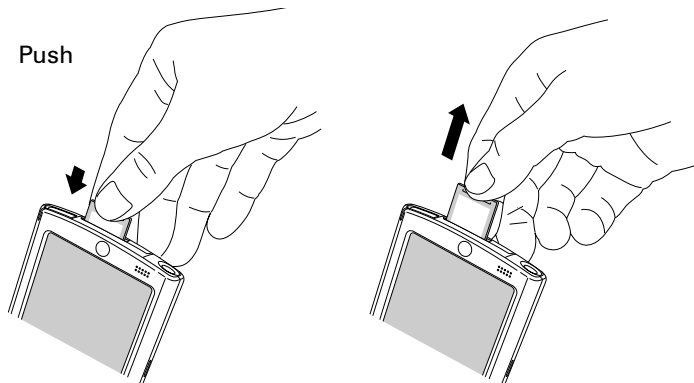

For complete information about working with expansion cards, see [Chapter 6](#).

## Elements of the handheld interface

Like using a mouse to click elements on a computer screen, using the stylus to tap elements on your handheld screen is the basic action you use to get things done on your handheld.

The first time you start your handheld, the setup instructions appear on the screen. These instructions include a digitizer screen that aligns the internal circuitry of your handheld with its touch-sensitive screen so that when you tap an element on the screen, the handheld can detect exactly which task you want to perform.

---

**IMPORTANT** Always use the point of the stylus for tapping or for making strokes on the handheld screen. Never use an actual pen, pencil, or other sharp object to write on the handheld screen, because this will scratch the screen.



---

With your handheld turned on, you can tap the handheld screen to perform many operations. For example, you can do the following:

- Open applications.
- Select menu commands.
- Use the status bar.
- Initiate a Find operation to search through applications installed on your handheld for specific text. (Find operations do not search through applications on expansion cards.)
- Select options in dialog boxes.
- Open the onscreen keyboards.

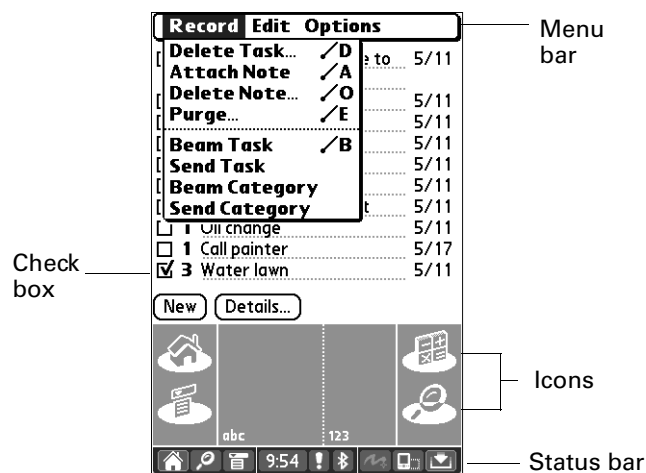
Just as you can drag the mouse to select text or move objects on your computer, you can drag the stylus to select text. You can also use the stylus to drag the slider of any scroll bar.



- Check box** Tap a check box to select or deselect it. When a check box contains a check mark, the corresponding option is selected and active. When a check box is empty, the corresponding option is deselected and inactive.
  
- Menu bar** Use the menu bar to access a set of application-specific commands. Not all applications have a menu bar.
  
- Icons** Tap the icons to open applications , menus , and a favorite application, and to find text anywhere in your data . See “Opening applications,” “Using menus,” and “Finding information” in Chapter 4, and see “Buttons Preferences” in Chapter 21 for more information about using these icons.
  
- Status bar** Use the status bar for quick access to many functions. For more information, see “Using the status bar” in the next section.

Previous/next arrows

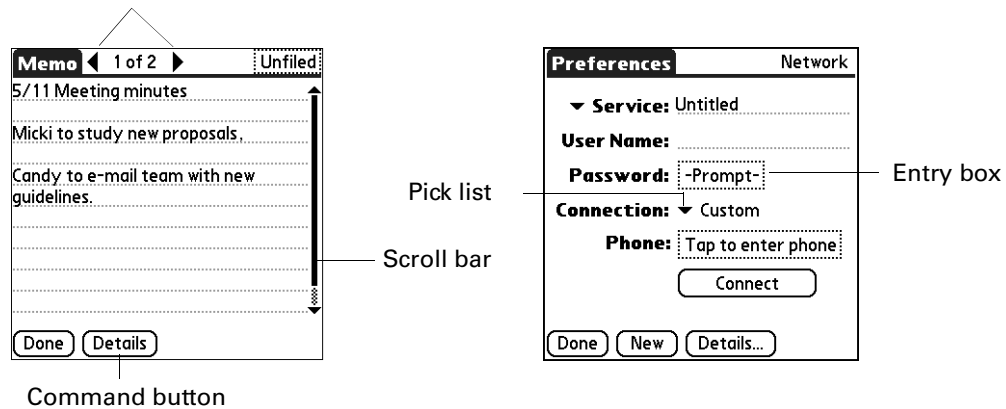

- Command buttons** Tap a button to perform a command. Command buttons appear at the bottom of dialog boxes and application screens.
  
- Next/previous arrows** Tap the left and right arrows to display the previous and next records; tap the up and down arrows to display the previous and next pages of information.
  
- Scroll bar** Drag the slider, or tap the top or bottom arrow, to scroll the display one line at a time. To scroll to the previous page, tap the scroll bar just above the slider. To scroll to the next page, tap the scroll bar just below the slider.



You can also scroll to the previous and next pages within a record by pressing Up and Down on the navigator.

<b>Pick list</b>	Tap the arrow to display a list of choices, and then tap an item in the list to select it.
<b>Entry box</b>	Tap box to open dialog box or enter data directly in the box.

## Displaying online tips

Many of the dialog boxes that appear on your handheld contain an online Tips icon in the upper-right corner. Online tips anticipate questions you might have in a dialog box, provide shortcuts for using the dialog box, or give you other useful information.

To display an online tip:

1. Tap the Tips icon ⓘ.
2. After you review the tip, tap Done.

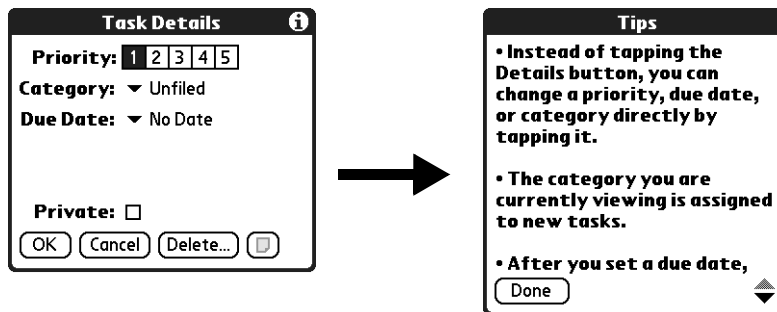

## Using the navigator

When you work with most applications, the navigator on the front panel of your handheld makes it easy for you to navigate among and select your entries. You can use the navigator to perform tasks without the stylus, using one hand.



Look for the navigator icon to find navigator tips throughout this guide. See the chapters on the applications for additional information about using the navigator with each application.

**To navigate in list screens, do any of the following:**

- Press Up or Down on the navigator to scroll an entire screen of records.
- Press and hold Up or Down on the navigator to accelerate the scrolling.
- Press Select in the center of the navigator to insert the selection highlight. When the selection highlight is present, you can do the following:
  - Press Up or Down on the navigator to scroll to the previous or next records.
  - Press Select again to view the selected record.
  - Press Left on the navigator to remove the selection highlight.

Tasks	All	Date	Category
<input checked="" type="checkbox"/> 1	Write thank you note to Lisa	5/11	
<input checked="" type="checkbox"/> 1	Call Doreen	5/11	
<input checked="" type="checkbox"/> 1	Pick up flower pots	5/11	
<input type="checkbox"/> 1	Get football tickets	5/11	
<input type="checkbox"/> 1	Buy birthday present	5/11	
<input type="checkbox"/> 1	Pick up movie	–	
<input type="checkbox"/> 2	Oil change	5/11	
<input type="checkbox"/> 2	Call painter	5/17	
<input checked="" type="checkbox"/> 3	Wash car	5/12	
<input checked="" type="checkbox"/> 3	Water lawn	5/15	

New Details... [ ]

Scroll through this list using the navigator instead of tapping the scroll arrows

**To navigate in record screens:**

1. Press Up or Down on the navigator to scroll within the current record.
2. Press Right or Left on the navigator to scroll to the previous or next record. (This feature is not available in Contacts.)
3. Press Select in the center of the navigator to return to the list screen.

Memo	1 of 6	Unfiled
Handheld Basics		
• Press any application button to turn on your handheld computer and start a main application.		
• Tap New to create a new record.		
• Tap a record to edit it.		
• Tap Details to access more options		

Done Details

Scroll through this record with the navigator instead of tapping the scroll arrows

**To navigate in dialog boxes:**

- While a pick list is open, press Up or Down on the navigator to highlight an item, and then press Select in the center of the navigator to select the item.
- Press Select on the navigator to close a dialog box.
  - If there is only one button, pressing Select activates that button.
  - If there are two buttons, pressing Select activates the action button (versus Cancel) such as OK, Yes, or Delete.
  - If there are multiple buttons, Select activates affirming buttons such as OK, Yes, or Done.

---

**IMPORTANT** Read dialog boxes carefully. Sometimes, selecting a button such as OK or Yes results in canceling an operation or deleting data.

---

## Using the status bar

The status bar gives you access to valuable tools and is accessible in all views.

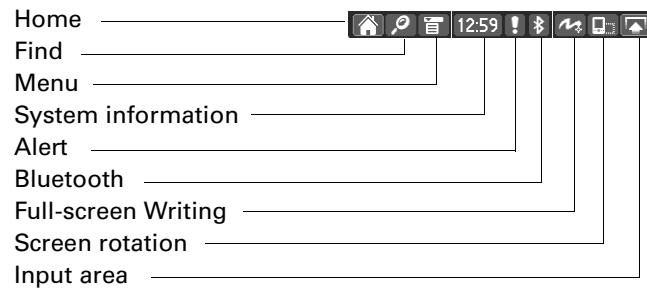

<b>Home</b>	Tap to display the Home screen.  Tap and hold to open a list of the last six applications that were opened. Select an application from the list to open it.
<b>Find</b>	Tap to open the Find dialog box. See <a href="#">“Finding information”</a> in <a href="#">Chapter 4</a> .
<b>Menu</b>	Tap to open the menu for the current screen. See <a href="#">“Using menus”</a> in <a href="#">Chapter 4</a> .
<b>System information</b>	Shows the current time.  Tap to open the system information dialog box. The dialog box shows the date and time, available memory, battery level, and allows you to adjust the volume and screen brightness. See <a href="#">“Changing system information”</a> later in this chapter for more information.
<b>Alert</b>	Tap to display the Attention Manager dialog box. See <a href="#">“Receiving alerts”</a> in <a href="#">Chapter 4</a> .
<b>Bluetooth</b>	Tap to display Bluetooth dialog box where Bluetooth can be turned on and off, and you can connect to the network. See <a href="#">“Using Bluetooth and connecting to the network from the status bar”</a> later in this chapter for more information.
<b>Full-screen Writing</b>	Tap to turn Full-screen Writing on and off. See <a href="#">“Using Full-screen Writing”</a> in <a href="#">Chapter 3</a> .
<b>Screen rotation</b>	Tap to toggle between landscape and portrait view. Landscape view is useful for viewing spreadsheets, e-mail, web pages, and photos. See <a href="#">“Rotating the screen”</a> later in this chapter.

- Input area** Tap to toggle between showing and hiding the input area.
- Tap and hold to display the input area selection menu. You can select between three types of input areas. For information about the on-screen keyboards, see [“Using the onscreen keyboards”](#) in [Chapter 3](#). For information about the Graffiti 2 input area, see [“Writing in Graffiti 2 input areas”](#) in [Chapter 3](#).

## Changing system information

Tap the time icon on the status bar to open the system information dialog box where you can view and change system information. Tap anywhere outside of the dialog box to close it.

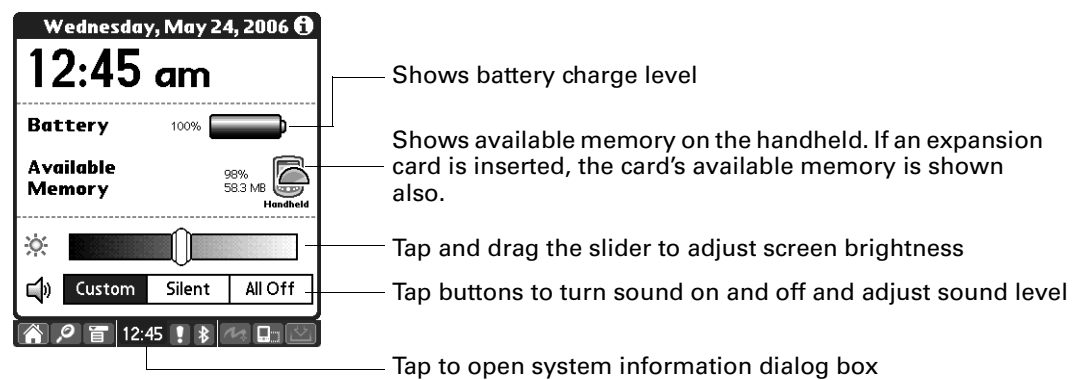

## Using Bluetooth and connecting to the network from the status bar

Tap the BlueTooth icon on the status bar to open the Bluetooth dialog box where you can connect to your network service provider and turn on or off your handheld's Bluetooth availability. You can also open the Bluetooth preferences screen. For more information on the Bluetooth preferences, see [“Bluetooth Preferences”](#) in [Chapter 21](#). Tap anywhere outside of the dialog box to close it.



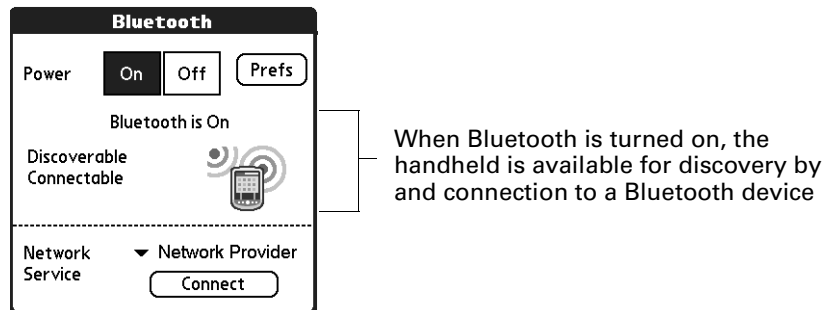
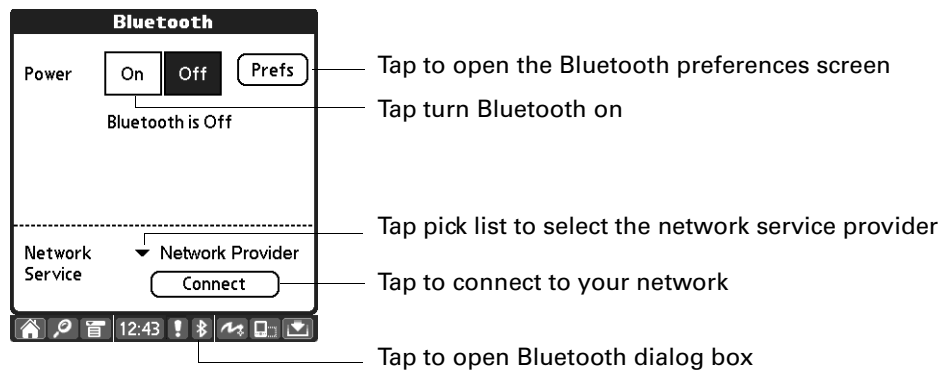

## Rotating the screen

You can toggle between landscape and portrait view by tapping the screen rotation icon. Landscape view is useful for viewing spreadsheets, e-mail, web pages, and photos.

**NOTE** You can customize which way the screen rotates in landscape mode by choosing right- or left-handed rotation. See [“Handedness Preferences”](#) in [Chapter 21](#).

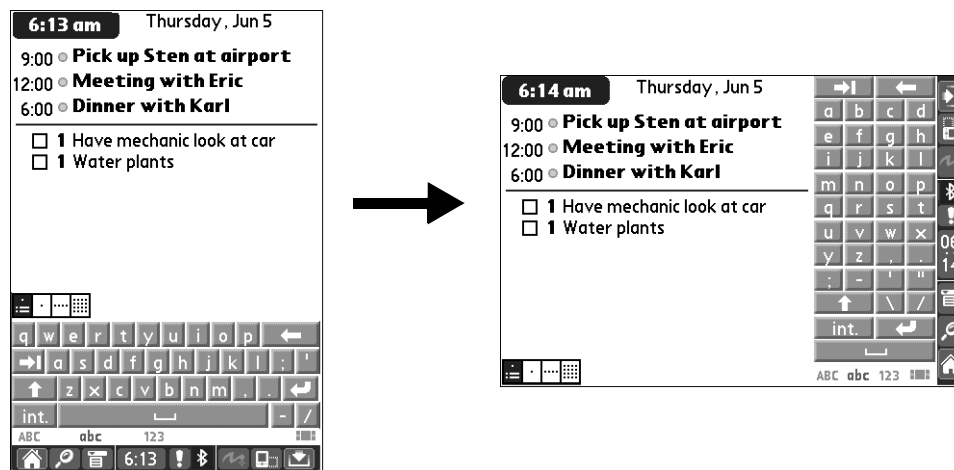



# Entering Data on Your Handheld

This chapter explains several ways to enter data on your handheld.

## Using the onscreen keyboards

You can change the input area to display the onscreen keyboard anytime you need to enter text or numbers on your handheld.

**TIP** Full-screen Writing enables you to use Graffiti® 2 writing when the keyboard is open, which makes it easy to switch between these two methods of entering data. For information on Full-screen Writing, see [“Using Full-screen Writing”](#) later in this chapter.

Keyboards are accessible from the status bar and input areas.



Tap and hold. Then select keyboard icon.

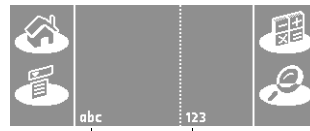
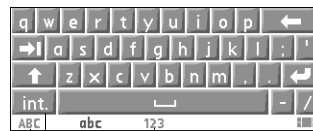

Tap here to display keyboard

You can display four different keyboards.

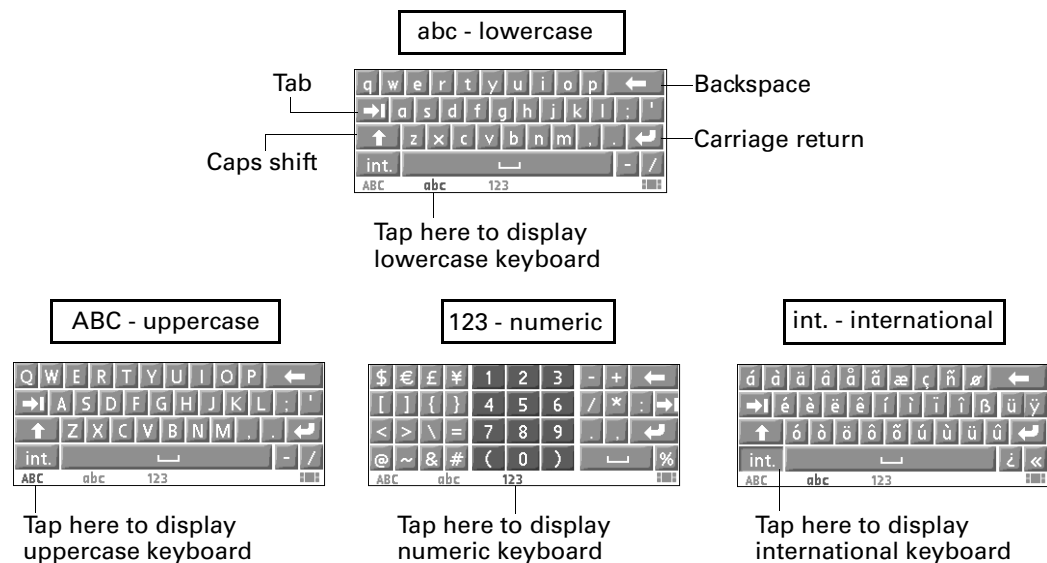

## Using Graffiti® 2 writing

Your handheld has Graffiti 2 help that describes the characters and writing procedures for Graffiti 2.

This section contains tables of all the Graffiti 2 characters.

**NOTE** By default, your full-screen pen stroke is set to open Graffiti 2 help. See [“Pen Button Preferences”](#) in [Chapter 21](#) for more information.

**To access Graffiti 2 help from an application:**

1. Tap on an editable text field.
2. Tap the Menu icon .
3. Select Graffiti 2 Help from the Edit menu.

**To access Graffiti 2 information from Quick Tour:**

1. Tap the Home icon .
2. Tap the Quick Tour icon.
3. Select Graffiti 2.

## Writing in Graffiti 2 input areas

You can write Graffiti 2 characters in the designated input areas, or you can turn on Full-screen Writing and write outside the input area.

The input area has two different Graffiti 2 screens that you can access from the status bar.

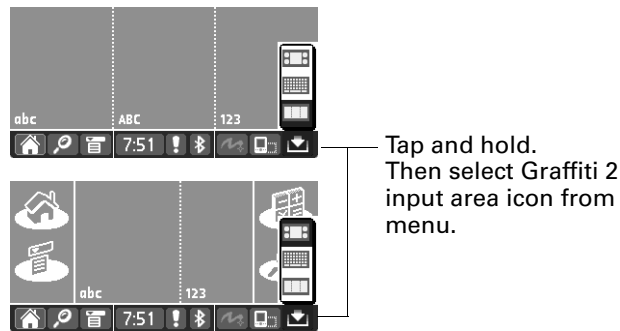

The two Graffiti 2 screens have designated areas that recognize certain characters. If those characters are written in the wrong area, they are not recognized correctly and an incorrect character is written. For a list of characters and the designated Graffiti 2 area where they can be written, see [“Graffiti 2 character set”](#) later in this chapter.

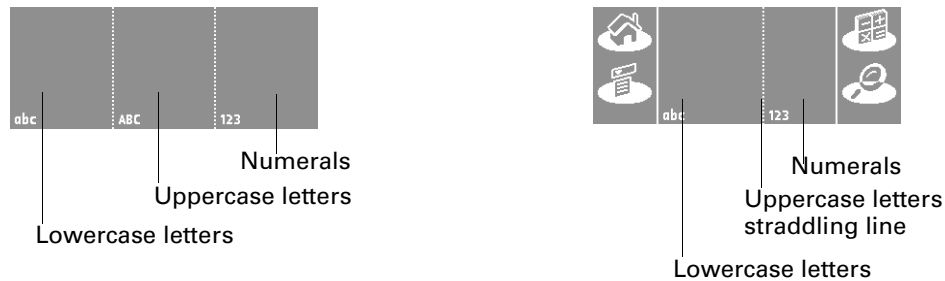

## Using Full-screen Writing

When Full-screen Writing is turned on and is active, you can write outside the Graffiti 2 input area. When Full-screen Writing is turned off or is inactive, you must write character strokes in the Graffiti 2 input area for your handheld to recognize them.

You can write letters or characters in the following areas:

- **Left side of the screen:** letters or characters that are assigned to the abc or ABC input areas
- **Right side of the screen:** numbers or characters that are assigned to the 123 input area
- **Middle of the screen straddling the imaginary dividing line between the left and right sides:** capital or uppercase letters

**NOTE** For a brief period of time after writing a character, a quick tap on the screen is interpreted as a period character. This makes it easier to tap buttons and place the cursor without having the action interpreted as a period character.



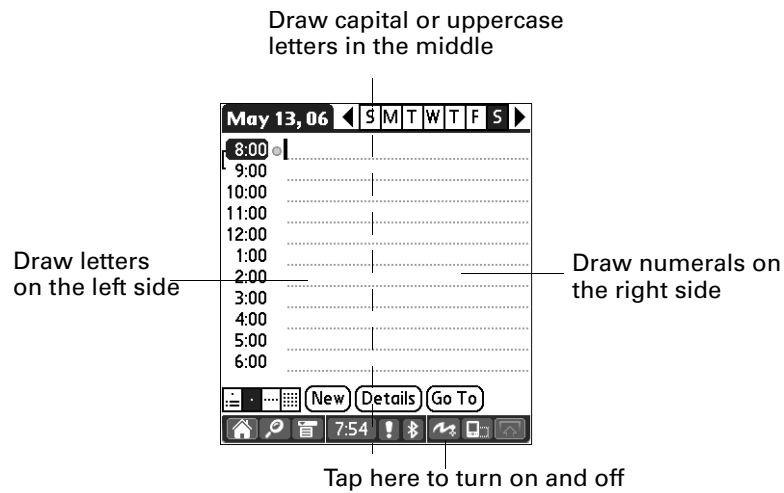









Full-screen Writing is turned on and off by tapping the Full-screen Writing button on the status bar.













## Graffiti 2 character set

### Graffiti 2 alphabet

Draw letters on the abc and ABC writing area			
Letter	Strokes	Letter	Strokes
A		B	
C		D	
E		F	
G		H	
I		J	
K		L	
M		N	

Draw letters on the abc and ABC writing area			
Letter	Strokes	Letter	Strokes
O		P	
Q		R	
S		T	
U		V	
W		X	
Y		Z	

**Graffiti 2 numbers**

Draw numbers on the 123 writing area			
Number	Strokes	Number	Strokes
0		1	
2		3	
4		5	
6		7	
8		9	

### Punctuation marks

Draw these marks on the abc or ABC writing area			
Mark	Stroke	Mark	Stroke
Period .		Ampersand &	
Comma ,		Carriage return	
Apostrophe '		At @	
Space		Straight quotes "	
Question ?		Tab	
Exclamation !			

Draw these marks on the 123 writing area			
Mark	Stroke	Mark	Stroke
Period .		Backslash \	
Comma ,		Slash /	
Tilde ~		Left Paren (	
Dash -		Right Paren )	
Plus +		Equal =	
Asterisk *			



## Accented characters

Draw accents on the 123 writing area			
Accent	Stroke	Accent	Stroke
Acute á		Dieresis ä	
Grave à		Circumflex â	
Tilde ã		Ring å	

Using these accent strokes, you can write the following accented letters:

à á â ã ä å è é ê ë ì í î ï ò ó ô õ ö ù ú û ü ý ÿ ñ

## Symbols and other special characters

You can write symbols and other special characters using the Punctuation Shift stroke.

**NOTE** You can also use the Punctuation Shift stroke to write punctuation marks.

To write symbols and special characters:

1. Enter the Punctuation Shift stroke:

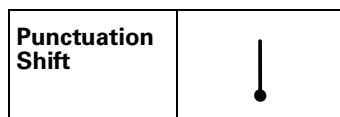

When Punctuation Shift is active, an up arrow symbol appears in the lower-right corner of the handheld screen. If you accidentally activate Punctuation Shift, another Punctuation Shift stroke will cancel it.

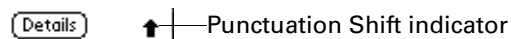

**NOTE** Drawing two Punctuation Shift strokes also cancels the automatic capitalization of the first letter of a new record or sentence.

2. Write the symbol or other special character shown in the table that follows. You can make a symbol stroke anywhere in the Graffiti 2 input area.

3. Enter an additional Punctuation Shift stroke to finish writing the character and to make the character appear more quickly.

After the arrow disappears, the symbol appears.

Draw symbols on EITHER side of the Graffiti 2 input area

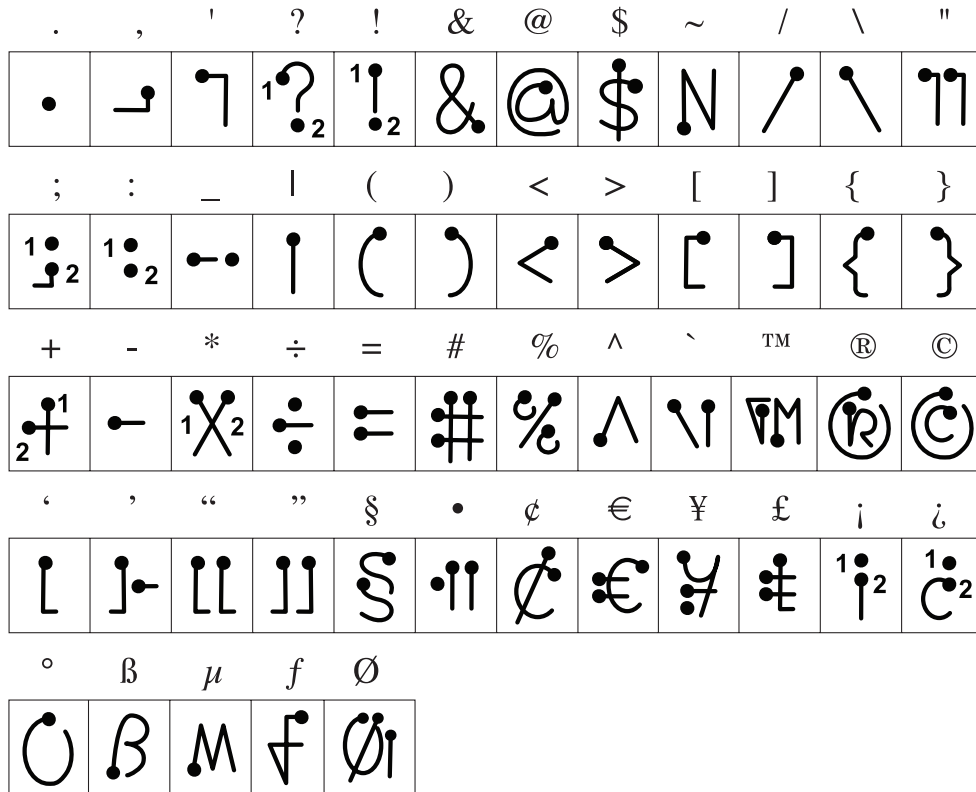

### Graffiti 2 Gestures

Draw gestures on the abc or ABC writing area			
Gesture	Stroke	Gesture	Stroke
Cut		Paste	
Copy		Undo	
Erase		Tab	
Punctuation Shift		Menu Command	
Short Cut			

## Graffiti 2 ShortCuts

Graffiti 2 writing comes with several predefined ShortCuts. You can also create your own shortcuts. See “ShortCuts Preferences” in [Chapter 21](#) to learn about creating ShortCuts.

To use a ShortCut, draw the ShortCut stroke followed by the ShortCut characters. The ShortCut symbol appears at the insertion point to show that you are in ShortCut mode.

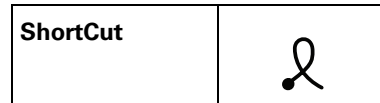

Your handheld includes the following predefined Graffiti 2 ShortCuts:

### Draw ShortCuts on the abc or ABC writing area

Entry	ShortCut
Date stamp	ds
Time stamp	ts
Date/time stamp	dts
Meeting	me
Breakfast	br
Lunch	lu
Dinner	di

## Beaming data

Your handheld is equipped with an IR port that is located at the top of the handheld, behind the small dark shield. The IR port supports the IrCOMM implementation of the standards for infrared communication established by the Infrared Data Association (IrDA). This means that you can beam data to any nearby device that supports the IrCOMM implementation of the IrDA standards and that can read the type of data you’re beaming. For example, you can beam a Contacts entry to a Palm OS® handheld, a mobile phone, or a computer that’s equipped with an IR port and that can read vCard data.

**NOTE** Records may be truncated when beamed to earlier models of Palm handhelds.

You can beam the following information between devices:

- The record currently displayed in Calendar, Contacts, Memos, Note Pad, Tasks, Palm™ Photos, or Palm™ Web Browser Pro
- All records of the category currently displayed in Calendar, Contacts, Memos, Note Pad, or Tasks, or all photos in the currently selected in Palm Photos
- A special Contacts record that you designate as your business card, containing information you want to exchange with business contacts
- An unlocked application installed in RAM memory
- An unlocked application installed on an expansion card that is seated in the card slot

**TIP** You can also perform HotSync® operations using the IR port. See “[Conducting IR HotSync operations](#)” in [Chapter 20](#) for more details.

**To select a business card:**

1. Create a Contacts record that contains the information you want on your business card.
2. Tap the Menu icon .
3. Tap Record, and then tap Select Business Card.
4. Tap Yes.

**To beam a record, business card, or category of records:**

1. Locate the record, business card, or category you want to beam.

**NOTE** The procedure for beaming photos and albums is slightly different from the procedure for beaming other records and categories. See [Chapter 13](#) for details.

2. Tap the Menu icon .
3. Tap one of the following from the Record menu:
  - The Beam command for an individual record.
  - In Contacts only: Beam Business Card.
  - In Note Pad only: If you are beaming to someone who is using an earlier version of Note Pad, tap Compatibility, and then tap Beam.
  - Beam Category.

**TIP** You can also press and hold the Contacts application button to instantly beam your business card to another device.



4. When the Beam Status dialog box appears, point the IR port directly at the IR port of the receiving device.

For best results, Palm handhelds should be between 10 centimeters (approximately 4 inches) and 1 meter (approximately 39 inches) apart, and the path between the two handhelds must be clear of obstacles. The beaming distance to other devices may be different.



5. Wait for the Beam Status dialog box to indicate that the transfer is complete before you continue working on your handheld.

**To beam an application:**

1. Tap the Home icon .
2. Tap the Menu icon .
3. Tap App, and then tap Beam.
4. Tap the Beam From pick list.
5. Select either Handheld or Card.
6. Tap the application you want to transfer.

Some applications are copy-protected and cannot be beamed. Each of these is listed with a lock icon next to it.

7. Tap Beam.
8. When the Beam Status dialog box appears, point the IR port directly at the IR port of the receiving device.
9. Wait for the Beam Status dialog box to indicate that the transfer is complete before you continue working on your handheld.

**To receive beamed information:**

1. Turn on your handheld.
2. Point the IR port directly at the IR port of the transmitting device to open the Beam dialog box.

## Sending data

You can send data by using Bluetooth™ communication or by using e-mail or SMS communication.

## Sending data using Bluetooth™ communication

If you enable Bluetooth communication, you can send data to other Bluetooth devices. The Bluetooth device must be discoverable and must be positioned within 10 meters (approximately 30 feet) of your handheld. For more information on enabling Bluetooth communication, see [“Using Bluetooth and connecting to the network from the status bar”](#) in [Chapter 2](#). For more information about Bluetooth settings, see [“Bluetooth Preferences”](#) in [Chapter 21](#).

To send data using Bluetooth communication:

1. Open the application you from which you want to send data.
2. Select the record or category you want to send.
3. Select the Send command from the application. For example, in Contacts, tap the Menu icon, tap Record, and then tap Send Address.

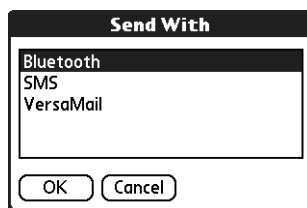

4. Select Bluetooth and tap OK.

## Sending data using e-mail or SMS communication

In addition to beaming data, you can also use e-mail or SMS communication to send information to and receive information from other devices.

To use your handheld for e-mail communication, you need to perform a HotSync operation with your computer by using a Bluetooth local area network (LAN) access point or modem, or use a mobile phone. For more information, see [Chapter 16](#).

To use your handheld for SMS communication, you need a Global System for Mobile Communications (GSM) phone (sold separately) and you need to establish a connection with your GSM mobile phone. For additional information about connecting to your GSM phone, see [Chapter 12](#). For additional information about sending SMS data, see [Chapter 14](#).

## Using your computer keyboard

If you have a lot of data to enter, or prefer to use the computer keyboard, you can use Palm™ Desktop software or any supported personal information manager (PIM), such as Microsoft Outlook, to enter information. You can then perform a HotSync operation to synchronize the information on your computer with the information on your handheld. Many of the applications that came with your handheld are also available in Palm Desktop software and in most PIMs, so you

don't need to learn different applications. For more information on entering data on your computer, refer to the online Help in Palm Desktop software and the *Palm Desktop Software for the Macintosh User's Guide* on the Software Installation CD-ROM.

## Importing data

If you have data stored in computer applications, such as spreadsheets and databases, or if you want to import data from another handheld, you can transfer the data to your handheld without typing it. Save the data in one of the file formats listed in the next section, import it into Palm Desktop software, and then perform a HotSync operation to transfer the data to your handheld.

### Importing data from a Windows computer

Palm Desktop software can import data in the following file formats:

- Comma-delimited (.csv, .txt): Contacts and Memos only
- Tab-delimited (.tab, .tsv, .txt): Contacts and Memos only
- CSV (Lotus Organizer 2.x/97 Mapping): Contacts only
- vCal (.vcs): Calendar only
- vCard (.vcf): Contacts only
- Calendar archive (.dba)
- Contacts archive (.aba)
- Tasks archive (.tda)
- Memos archive (.mpa)

Archive formats can be used only with Palm Desktop software. Use the archive file formats to share information with other people who use a Palm OS handheld or to create a copy of your important Palm Desktop information.

See Palm Desktop online Help for more information on importing and exporting data.

#### To import data from a Windows computer:

1. Open Palm Desktop software.
2. Click the application into which you want to import data.
3. If you are importing records that contain a field with category names, do the following:

Select All in the Category box.

Be sure that the same categories that appear in the imported file also exist in the application. If the categories do not exist, create them now; otherwise, the records are imported into the Unfiled category.

4. From the File menu, select Import.
5. Select the file you want to import.
6. Click Open.

If you are importing a vCal or vCard file, skip to step 10. You do not have to specify which fields correspond to the imported data.

7. To import data into the correct Palm Desktop fields, drag each field in the left column so that they are opposite the corresponding imported field on the right.
8. If you don't want to import a field, click the check box for that field to deselect it.
9. Click OK.

The imported data is highlighted in the application.

10. To add the imported data to your handheld, perform a HotSync operation.

See Palm Desktop online Help for more information on importing and exporting data.

### Using File Link

The File Link feature enables you to import Contacts and Memos information, such as a company phone list, to your handheld from a separate external file on your Windows computer. You can configure the File Link feature to check for changes to the external file when you perform a HotSync operation. HotSync Manager stores the data in a separate category in Palm Desktop software and on your handheld.

For information on how to set up a file link, see the Palm Desktop online Help.

## Importing data from a Mac computer

Palm Desktop software can import data from any applications that can export the data in any of the following file formats:

- Tab-delimited file
- Text
- Palm Desktop software for Mac
- vCal (.vcs)
- vCard (.vcf)

For example, you can export tab-delimited files from applications such as FileMaker Pro, Meeting Maker, Now Contact, and Now Up-to-Date.

### To import data from a Mac computer:

1. Open Palm Desktop software.
2. From the File menu, select Import.
3. Select the file you want to import.



4. Click Open.
5. If you want to change the order of the fields you're importing, point to a field, wait for the cursor to change to a double arrow, and then drag the field to a new location.
6. If you do not want to import a field, click the arrow between the field names.
7. From the Fields pop-up menu, select the appropriate field.
8. From the Delimiters pop-up menu, select the appropriate delimiter.
9. Click OK.
10. To add the imported data to your handheld, perform a HotSync operation.

See Palm Desktop online Help for more information on importing and exporting data.

## Using a portable keyboard

You can connect a portable keyboard accessory to the universal connector on your handheld so that you can type data directly into your handheld. Portable keyboards are very helpful when you need to enter large amounts of data quickly and accurately while you are away from your computer—for example, when you need to write an e-mail message. For additional information about this optional accessory, go to the web site [www.palm.com](http://www.palm.com).



# Working with Applications

This chapter explains how to open and switch between applications on your handheld, how to change application settings so they are personalized to your work methods, and how to categorize applications so you view them in related groups.

## Opening applications

You can use the Home screen to open any application installed on your handheld or on expansion card. You can also open Calendar, Contacts, Tasks, Note Pad, and Voice Memo with the application buttons on your handheld.

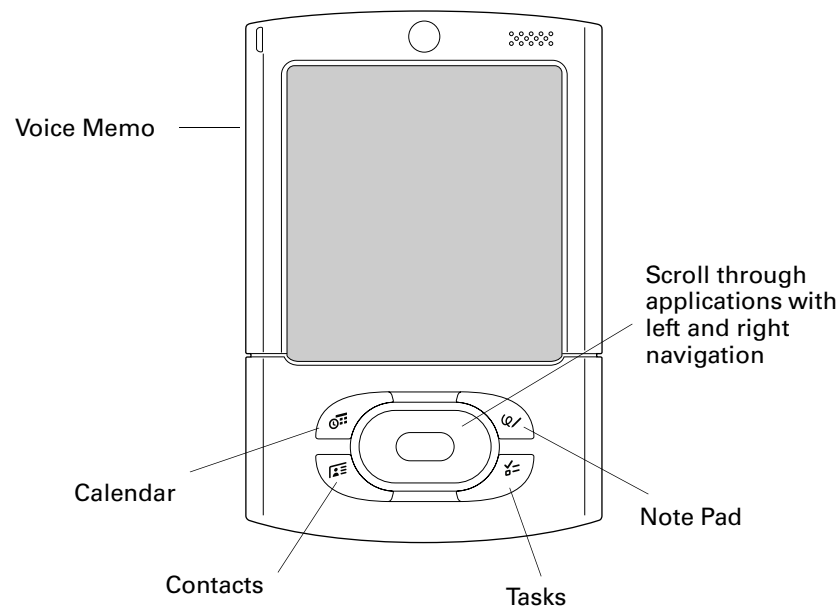

In addition to providing a way for you to open applications, the Home screen displays the current time, battery level, and application category.

**To open an application on your handheld:**

1. Tap the Home icon .
2. Tap the icon of the application that you want to open. If you have many applications installed on your handheld, tap the scroll bar to see all your applications.

## Opening expansion card applications

When an expansion card is properly seated in the expansion card slot, your handheld responds based on the contents of the card and the application that is active when you insert the card. In some cases the application on the card opens automatically upon insertion, or if you insert a card containing data from the current application, the application displays the data on the card. In other cases the Home screen switches to the card and displays its contents, and the pick list in the upper-right corner of the screen displays the name of the card.

## Switching between applications

When working with any application, select the Home icon  or press an application button on your handheld to switch to another application.



You can also press and hold Select (the center button) on the navigator to switch to the Home screen at any time.

When you use an expansion card, your handheld creates and displays a new category that matches the name of the expansion card. You can easily switch between applications installed on your handheld and on the expansion card.

**To switch to an expansion card:**

1. Tap the pick list in the upper-right corner.
2. Select the category item that matches the name of the expansion card.

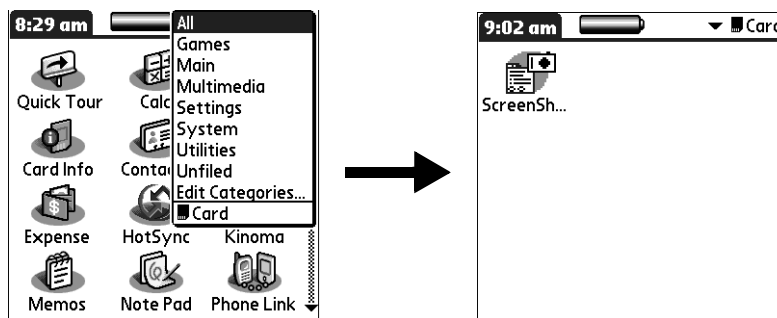

3. You can also press right and left on the navigator to switch between categories, including the expansion card category.



## Categorizing applications

You can assign an application to a category and then display a single category or all your applications.

By default, your handheld includes system-defined categories, such as All and Unfiled, and user-defined categories, such as Games, Main, and System.

In addition, you can create your own user-defined categories. You can have a maximum of 15 user-defined categories.



### To categorize an application:

1. Tap the Home icon .
2. Tap the Menu icon .
3. Select Category on the App menu.
4. Tap the pick list next to each application to select a category.

**TIP** To create a new category, tap Edit Categories from the pick list. Tap New, enter the category name, and then tap OK to add the category. Tap OK again to close the Edit Categories dialog box.

5. Tap Done.

### To display applications by category:

1. Tap the Home icon .
  2. Do one of the following:
    - Tap the Home icon  repeatedly to cycle through all your categories.
    - Tap the pick list in the upper-right corner of the screen, and select the category you want to display.
-  – Press and hold Select on the navigator to open the category list, press Up or Down on the navigator to highlight a category, and then press Select on the navigator to view that category.



## Copying applications to or from an expansion card

You can copy applications from your handheld to an expansion card, or from an expansion card to your handheld.

You can install applications to a card that is seated in the expansion card slot during a HotSync® operation. See [“Installing files and add-on applications”](#) later in this chapter for details.

You can also beam applications from expansion cards to your handheld or send applications from expansion cards to your handheld. See [“Beaming data”](#) and [“Sending data”](#) in [Chapter 3](#) for details.

To copy an application to or from an expansion card:

1. Tap the Home icon .
2. Tap the Menu icon .
3. Select Copy on the App menu.

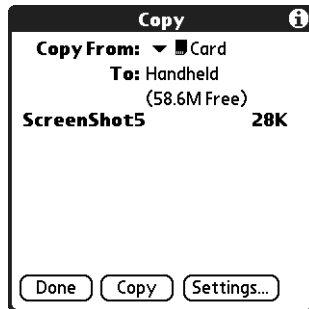

4. Tap the Copy From pick list and select Handheld or the card name.
5. If there are multiple cards available, tap the Copy To pick list and select the Handheld or the card name.

If you selected Handheld in the Copy from pick list, the Copy To pick list appears only if there are multiple cards available.



6. Tap an application to copy.
7. Tap Copy.
8. Tap Done.

**NOTE** If you view your applications on the card using a Card Reader on your Windows or Mac computer, the actual file names may differ from those displayed in the Home screen.

## Selecting copy settings

The copy feature enables you to copy only the application or both the application and its data files.

To select copy settings:

1. Tap the Home icon .
2. Tap the Menu icon .
3. Select Copy on the App menu.

## 4. Tap Settings.



## 5. Tap the Sort By pick list and select Name or Size.

## 6. Tap the Copy Application Only check box to select it if you want to copy only the application files. Leave it deselected if you want to copy both the application file and its associated data file(s).

## 7. Tap OK.

**NOTE** The Sort By setting is in effect each time you use the copy feature. Each time you want to copy an application only, you must select the Copy Applications Only check box.

## Using menus

Menus on your handheld are easy to use. Once you have mastered them in one application, you can use them the same way in all other applications.

The menus of each application are illustrated in the chapter that discusses that application.

### To open the menu bar:

1. Open an application (such as Memos).
2. Do one of the following:
  - Tap the Menu icon  on the status bar or in the input area.
  - Tap the inverted title area at the top of the screen.

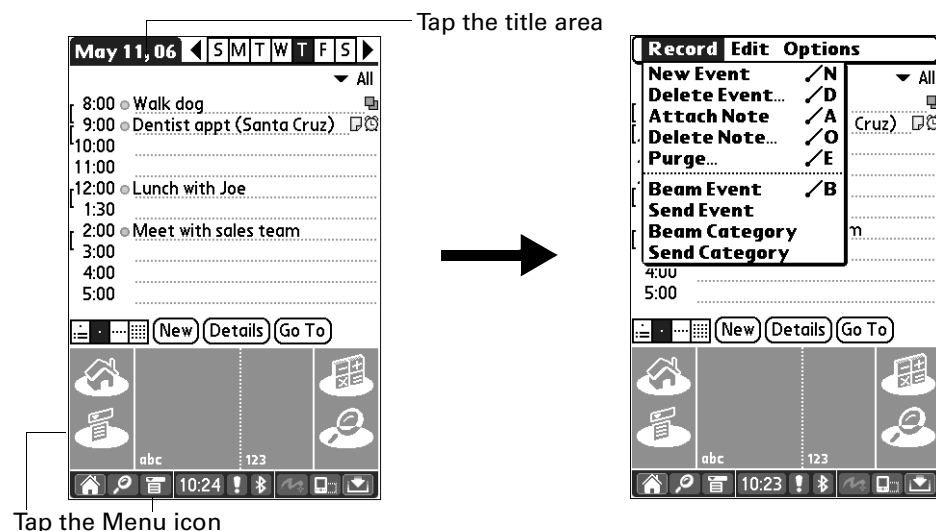

In this example, three menus are available: Record, Edit, and Options. The Record menu is selected and shows the selection.

## Graffiti 2 menu commands

Most menu commands have an equivalent Graffiti 2 Command stroke, which is similar to the keyboard shortcuts used to execute commands on computers. The command letters appear to the right of the command names.

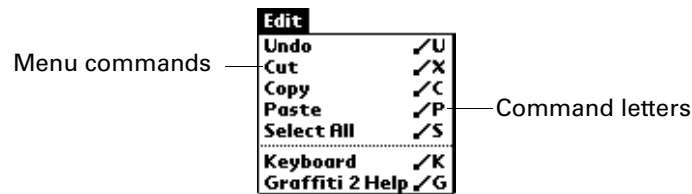

When you draw the Command stroke anywhere in the Graffiti 2 input area, the Command toolbar appears below the Graffiti 2 input area to indicate that you are in Command mode. The Command toolbar covers the status bar.

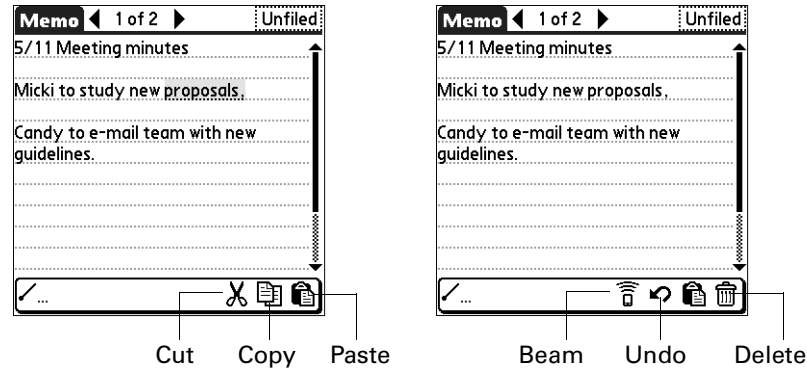
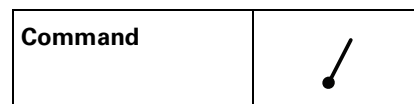

The Command toolbar displays context-sensitive menu commands for the active screen. For example, if text is selected, the menu icons displayed may be Undo, Cut, Copy, and Paste. Tap an icon to select the command, or immediately write the corresponding command letter for an appropriate command in the Graffiti 2 writing area.

For example, to select Paste from the Edit menu, draw the Command stroke, followed by the letter *p*.

Command mode is active only for a short time, so you must tap an icon or write the command letter immediately to select the menu command.



## Performing common tasks

The following tasks are common to most applications.

### Creating records

You can use the following procedure to create a new record in Calendar, Contacts, Tasks, Note Pad, Memos, and Expense.

In SMS, you use a different procedure to create a message. For more information, see “[Creating messages](#)” in [Chapter 14](#).

In Palm™ Web Browser Pro, you can either save a web page or bookmark it so you can return to it later. For more information, see [Chapter 18](#).

To create a record:

1. Select the application in which you want to create a record.
2. Tap New.
3. In Calendar only: Select start and end times for your appointment, and tap OK.
4. Enter text for the record.
5. (Optional) Tap Details to select attributes for the record. (In Note Pad the Details command is located on the Options menu.)
6. In Contacts, Note Pad, and Memos only: Tap Done.

### Editing records

After you create a record, you can change, delete, or enter new text at any time. Two screen features tell you when your handheld is in Edit mode:

- A blinking cursor
- One or more dotted edit lines

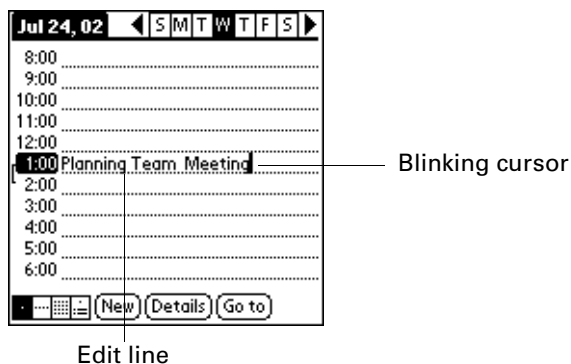

**NOTE** In Note Pad you can write anywhere on the screen. Therefore, you will not see an edit line or blinking cursor unless the cursor is in the title line.

### Entering text

For information on entering text using Graffiti 2 writing, using the onscreen keyboards, or using the keyboard attached to your computer, see [Chapter 3](#). For information on entering text in Note Pad, see “[Creating a note](#)” in [Chapter 11](#).

### Using the Edit menu

The Edit menu is available with any screen where you enter or edit text. In general, commands available in the Edit menu apply to text that you *select* in an application.

#### To select text in an application:

1. Tap the beginning of the text that you want to select.
2. Drag the stylus over the text to highlight it (in yellow).

**NOTE** You can also double-tap to select a word, or triple-tap to select a line of text. In addition, you can also drag *across* the text to select additional words, or drag *down* to select a group of lines.

**TIP** To select text when Full-screen Writing is turned on, tap and hold briefly at the beginning of the text you want to select, before dragging the stylus. Otherwise, a quick tap or stroke may be interpreted as a Graffiti 2 character.

## Deleting records

#### To delete a record:

1. Select the record you want to delete.
2. Tap the Menu icon .
3. Select the Delete command on the Record menu. In Voice Memo, the Delete command is on the V Memo menu. In Palm™ Photos, the Delete command is on the Photo menu:

A confirmation dialog box appears. If you want to save a copy of the deleted item to an archive file in Palm™ Desktop software, be sure that the check box is selected. If you don't want to save a copy, tap the check box to deselect it.

The archive option is not available in Note Pad, Palm Photos, Palm Web Browser Pro, and Voice Memo. In SMS, you must tap Archive on the Message menu to archive a message.

4. Tap OK.

If you chose to save a copy of the selected item, your handheld transfers it to the archive file on your desktop the next time you perform a HotSync operation.

## Purging records

Over time, as you use Calendar, Tasks, and Expense, you will accumulate records in these applications that have outlived their usefulness. These outdated records take up memory on your handheld, so it's a good idea to remove them by using

Purge. If you think Calendar or Tasks records might prove useful later, you can purge them from your handheld and save them in an archive file on your computer.

Purging is not available in Contacts, Note Pad, Palm™ Photos, Voice Memo, SMS, or Memos. You must delete outdated records manually from these applications.

In Palm Web Browser Pro, you can purge stored web pages by clearing the cache. See [“Changing the size and content of the cache”](#) in [Chapter 18](#).

**To purge records:**

1. Open the application.
2. Tap the Menu icon .
3. Select Purge from the Record menu.

A confirmation dialog box appears.

**Calendar:** Tap the pick list and select how old a record must be to be purged. Purge deletes repeating events if the last of the series ends before the date that you purge records.

**Calendar and Tasks:** If you want to save a copy of the purged records to an archive file on your desktop, be sure that the check box is selected. If you don't want to save a copy, tap the check box to deselect it.

**Expense:** Select the category you want to purge. All data in the selected category is purged, and there is no archive option.

4. Tap OK, or in Expense, tap Purge.

If you chose to save a copy of the purged records, your handheld transfers them to an archive file on your desktop the next time you perform a HotSync operation.

## Categorizing records

You can categorize records in the Calendar, Contacts, Tasks, Note Pad, Voice Memo, Memos, and Expense applications so that they are grouped logically into categories and are easy to review. In Palm Photos, categories are called *albums*. Throughout this section, *categories* refers also to albums unless otherwise noted. In calendar, you can add color coding to your categories. See [“Using categories”](#) in [Chapter 5](#).

By default, your handheld includes system-defined categories, such as All and Unfiled, and user-defined categories, such as Business and Personal. In addition, you can create your own user-defined categories. In Palm Photos you can have a maximum of 14 user-defined albums, and in all other applications you can have a maximum of 15 user-defined categories.

The illustrations in this section come from Contacts, but you can use the following procedures in all the applications in which categories are available. The only exception is that the procedure for moving photos into albums is slightly different. See [“Filing photos in albums”](#) in [Chapter 13](#) for details.

**To move a record into a category:**

1. Select the record you want to categorize.
2. In Contacts only: Tap Edit.
3. Tap Details.
4. Tap the Category pick list to display the list of available categories.



5. Select the category for the record.
6. Tap OK.

**NOTE** In Contacts, Note Pad, Voice Memo, and Memos you can select the category name in the upper-right corner of the screen to assign the item to a different category.

**To display a category of records:**

1. Tap the category pick list in the upper-right corner of the list screen.

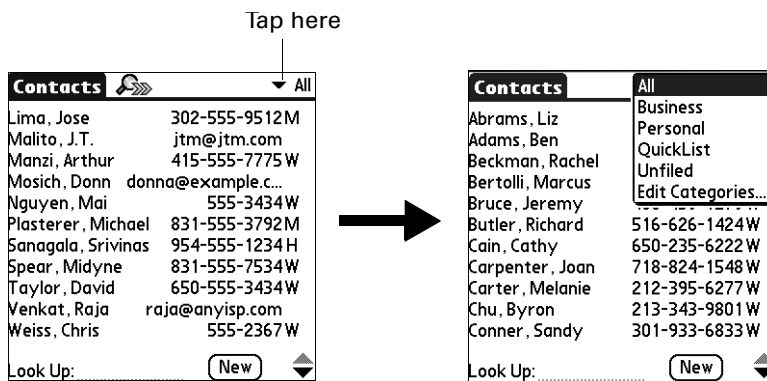

2. In the Calendar Day, Week, and Month views, the pick list can be shown or hidden by setting an option in the Display Options dialog box. If the pick list is shown, it appears in the upper-right corner below the menu bar.
3. Select the category you want to view.

The list screen now displays only the records assigned to that category.

**TIP** Pressing an application button on your handheld scrolls through all the categories of that application except for Unfiled. This feature is not available in Calendar.

**To define a new category:**

1. Tap the category pick list in the upper-right corner of the screen or list.
2. Select Edit Categories from the pick list.
3. Tap New.

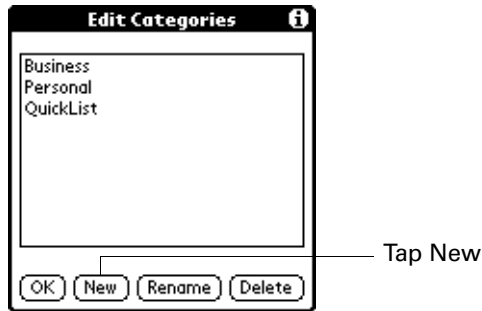

4. Enter the name of the new category, and then tap OK.

**NOTE** In Calendar, you can also select a different color for each category.

5. Tap OK.

You can assign any of your records to the new category.

**To rename a category:**

1. Tap the category pick list in the upper-right corner of the screen or list.
2. Select Edit Categories.

The Edit Categories dialog box opens.

3. Select the category that you want to rename, and then tap Rename.
4. Enter the new name for the category, and then tap OK.
5. Tap OK.

**TIP** You can group the records within two or more categories into one category by giving the categories the same name. For example, if you change the name of the Personal category to Business, all records formerly in the Personal category appear in the Business category.

## Finding information

Your handheld offers several ways for you to find information quickly.

### Using Find

You can use Find to locate any text that you specify, in any application that resides on your handheld. Find does not search applications that reside on an expansion card.

**To use Find:**

1. Tap the Find icon  on the status bar.

**TIP** If you select text in an application before you tap Find, the selected text automatically appears in the Find dialog box.

2. Enter the text that you want to find.

Find is *not* case sensitive. For example, searching for the name “davidson” also finds “Davidson.”

Find locates any words that begin with the text you enter. For example, searching for “plane” finds “planet” but not “airplane.”

3. Tap OK.

Find searches for the text in all records and all notes.

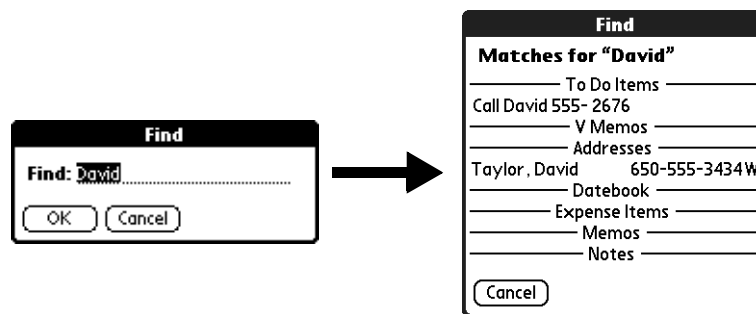

As your handheld searches for the text, you can tap Stop at any time. You may want to do this if the entry you want appears before your handheld finishes the search. To continue the search after you tap Stop, tap Find More.

4. Tap the text that you want to review.

**Looking up Contacts records**

In Contacts you can use the Look Up line with the stylus or navigator to look up and quickly scroll to any of your Contacts entries.

**To look up a Contacts record with the navigator:**

1. From the Contacts list screen, press Right on the navigator to display the Quick Look Up line.
2. Press Up and Down on the navigator to select the first letter of the name you want to find.

The list scrolls to the first entry that begins with that letter.

- Press Right on the navigator to move to the next letter box.

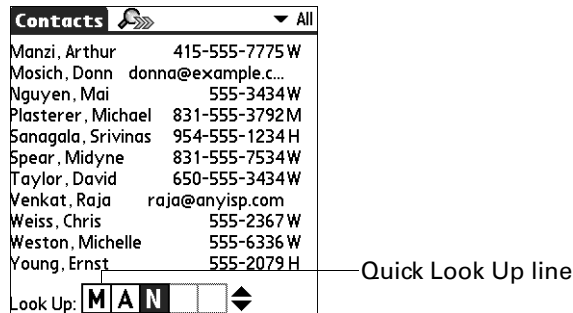

- The Quick Look Up line displays only letters that are a possible match for that position. For example, in the screen shown here, if you enter *c* in the first box, only the letters *a*, *h*, and *o* appear in the second box.

If there is only one possible match for a particular position, the highlight jumps to the next position.

- Press Up or Down on the navigator to select the next letter of the name you want to find.

The list then scrolls to the first entry that starts with those *two* letters. For example, selecting *s* scrolls to “Sands,” and selecting *sm* scrolls further to “Smith.” If you sort the list by company name, the Quick Look Up feature scrolls to the matches for the company name.

- Repeat steps 3 and 4 until the entry you want appears in the list.
- Press Select on the navigator to highlight the record you want.
- Press Select on the navigator to view the contents of the selected record.

**TIP** If there is only one possible match for the letters you selected, the contents of the record are automatically displayed.

#### To look up an Contacts record with the stylus:

- From the Contacts list screen, enter the first letter of the name you want to find.

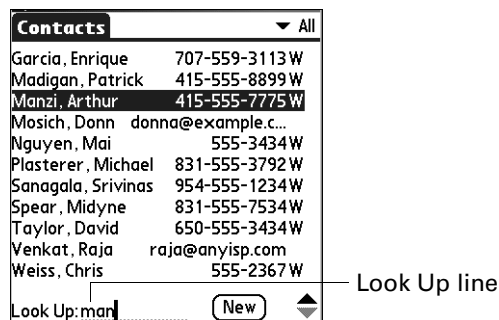

- The list scrolls to the first entry that begins with that letter. If you write another letter, the list scrolls to the first entry that starts with those *two* letters. For example, writing an *s* scrolls to “Sands,” and writing *sm* scrolls further to “Smith.” If you sort the list by company name, the Look Up feature scrolls to the first letter of the company name.
- Tap the record to view its contents.

### Using Phone Lookup

Phone Lookup displays the Contacts list screen. You can add to a record the information that appears in this list.

#### To use Phone Lookup:

- Display the record in which you want to insert a phone number. The record can be in Calendar, Tasks, Memos, SMS, or any other application that takes advantage of this feature.
- Tap the Menu icon .
- Select Options, and then select Phone Lookup.
- Begin to spell the last name of the name you want to find.

The list scrolls to the first record in the list that starts with the first letter you enter. Continue to spell the name you’re looking for, or when you see the name, tap it.

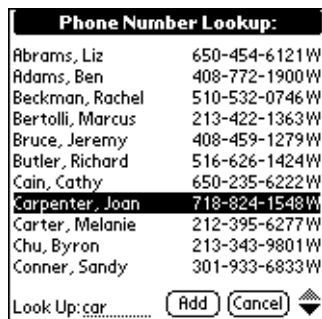

- Tap Add.

The name you selected, along with the information associated with it, is pasted into the record you selected in step 1.

## Sorting lists of records

Sorting is available in applications that have list screens: Contacts, Tasks, Note Pad, Voice Memo, Memos, and Expense. You can also sort photos in Palm Photos. See “[Creating an album](#)” in [Chapter 13](#) for details.

**NOTE** You can also assign records to categories. See “[Categorizing records](#)” earlier in this chapter.



**To sort records in Expense:**

1. Open the Expense to display the list screen.
2. Tap Show.
3. Tap the Sort by pick list and select an option.
4. Tap OK.

**To sort records in Contacts, Note Pad, Voice Memo, Tasks, and Memos:**

1. Open the application to display the list screen.
2. Tap the Menu icon .
3. Select Options, and then select Preferences.
4. Do one of the following:

**Contacts:** Tap the setting you want.

**Note Pad, Voice Memo, Tasks, Memos:** Tap the Sort by pick list and select an option from pick list.

5. Tap OK.

To sort the Note Pad, Voice Memo, or Memo list manually, tap and drag a note, voice memo, or memo to a new location in the list.

To make the list appear in Palm Desktop software as you manually sorted it on your handheld, open the application in Palm Desktop software and click Sort by. Then select Order on Handheld.

## Attaching notes

In Contacts, Calendar, Tasks, Palm Photos, and Expense, you can attach a note to a record. A note can be up to several thousand characters long. For example, for an appointment in Calendar, you can attach a note with directions to the location.

**To attach a note to a record:**

1. Display the entry to which you want to add a note.



To display an entry, tap it or press Up or Down on the navigator to highlight it, and then press Select on the navigator.

2. In Contacts only: Tap Edit.
3. Tap Details.
4. Tap Note or the Note button .
5. Enter your note.
6. Tap Done.

A small note icon appears at the right side of any item that has a note.

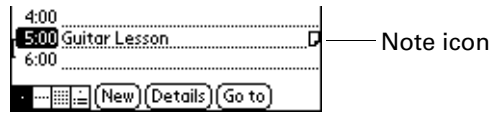

To review or edit a note:

- Tap the Note icon .



**TIP** In Calendar, you can also highlight the event that contains the note, press Select on the navigator to open the note, and then press Select on the navigator again to close the note.

To delete a note:

1. Tap the Note icon .
2. Tap Delete.
3. Tap Yes.

## Choosing fonts

In many applications, you can change the font style to make text easier to read. You can choose small, small bold, large, or large bold fonts in each application that enables you to change the font style.

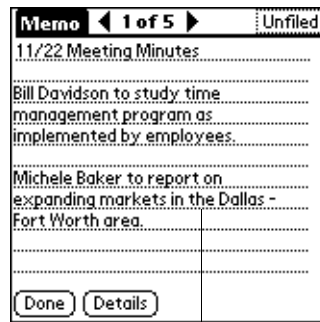

Small font

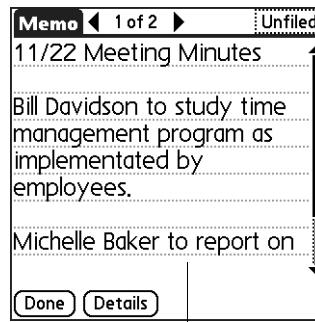

Large font

Small bold font



Large bold font



**To change the font style:**

1. Open an application.
2. Tap the Menu icon .
3. Select Options, and then select Font.
4. Tap the font style you want to use.

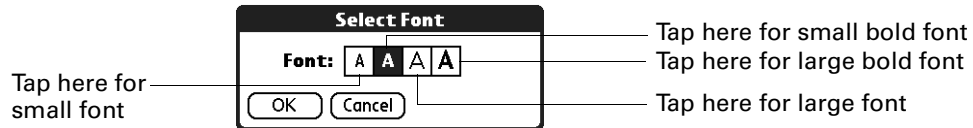

5. Tap OK.

## Receiving alerts

You can receive alerts on your handheld and from Palm Desktop software.

**NOTE** You can access Attention Manager by tapping the Alert icon  on the status bar.

### Receiving alerts on your handheld

When you use certain application settings, your handheld can alert you to any of the following:

- An appointment set in Calendar
- A note created in Note Pad
- A voice memo created in Voice Memo
- An alarm set in World Clock
- A task created in Tasks

When an alert occurs, your handheld displays a reminder message. If you tap Snooze in response to an alert message, your handheld reminds you of the item again in five minutes. The Reminder screen displays alerts that await attention.

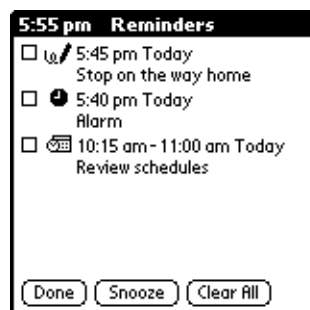

### Receiving alerts from Palm Desktop software

You can also set an option to receive Calendar event alerts from Palm Desktop software. The feature is disabled by default, so you must enable it within Palm Desktop software.

To enable an event alert from Palm Desktop software:

1. Double-click the Palm Desktop icon.
2. From the Tools menu, select Options, and then select Alarms.
3. Set Alarm Configuration options, either Always Available or Available only when the Palm Desktop is running.
4. (Optional) To hear an alert sound as well as receive an alert message, select the check box Play audible notification with alarm dialog box.
5. Click OK.

### Hiding or masking private records

You can use Security Preferences to set a password and select whether to mask your private records or hide them completely. See [“Making records private”](#) in [Chapter 21](#) for details.

## Installing and removing applications

This section explains how to install and remove applications and other files on your handheld or on an expansion card, and how to remove Palm Desktop software from your computer.

### Installing files and add-on applications

Your handheld comes with many applications installed and ready to use. During a HotSync operation you can also install additional applications, such as games and other software, on your handheld or on a card that is seated in the expansion card slot. Applications or games that you install on your handheld reside in RAM memory, and you can delete them at any time.

You can also install other files that are associated with an application on your handheld, such as Microsoft Office documents, photos, or audio files. Files that are not associated with an application on your handheld might not be installed during a HotSync operation.

Both applications and files are easy to install during a HotSync operation. You can install the following types of files:

- Palm OS® file types, including .prc and .pdb
- Image files, including .bmp and .jpg
- MP3 and Real Audio files (expansion card required, sold separately)

**NOTE** To install some software, you may need to download files from the Internet to your computer. Check the Software Installation CD-ROM for details.

- Microsoft Office files, such as Word, Excel, and PowerPoint documents
- Kinoma video files

There are a variety of third-party applications available for your handheld. To learn more about these applications, go to the web site: [www.palm.com](http://www.palm.com).

**NOTE** Palm works with developers of third-party add-on applications to ensure the compatibility of these applications with your new Palm™ handheld. Some third-party applications, however, may not have been upgraded to be compatible with your new Palm handheld. If you suspect that a third-party application is adversely affecting the operation of your handheld, contact the developer of the application.

## Installing applications and files on a Windows computer

Palm™ Quick Install makes it easy to install applications and files during the next HotSync operation. You can even install compatible files directly from a Zip file. Depending on the file type, Palm Quick Install determines whether to install the files on your handheld or on an expansion card.

You can use any of the following methods to install applications and files with Palm Quick Install:

- Drag and drop files onto the Palm Quick Install icon on the Windows desktop.
- Drag and drop files onto the Palm Quick Install window.
- Use the commands or buttons in the Palm Quick Install window.
- Right-click a file and send it to Palm Quick Install.

The procedures that follow explain how to install applications and files using each of these methods.

### To drag and drop applications or files onto the Palm Quick Install icon:

1. Copy or download the application(s) or file(s) you want to install onto your computer.
2. From My Computer or Windows Explorer, select the file(s) or folder that you want to install.
3. Drag and drop the file(s) or folder onto the Palm Quick Install icon on the Windows desktop.



Palm Quick Install displays a confirmation dialog box that shows whether the files will be installed on your handheld or on an expansion card, and you can choose the username to which the files will be installed.

## 4. Click OK.

The selected files are placed in the Handheld or Expansion Card file list, based on the file extension.

5. Perform a HotSync operation to install the files. See [Chapter 20](#) for details.

**NOTE** Files that remain in the list after you perform a HotSync operation were not installed. This can happen if your handheld is too full to install the file or if the file type was not recognized during the HotSync operation. If files are unrecognized, try launching the associated application from your handheld and then performing another HotSync operation. If the files still remain in the list, they are not associated with an application on your handheld and cannot be installed. Expansion cards may also hold files that are not Palm™ application files.

**To drag and drop applications or files onto the Palm Quick Install window:**

1. Copy or download the application(s) or file(s) you want to install onto your computer.
2. Double-click the Palm Quick Install icon on the Windows desktop.

Handheld file list

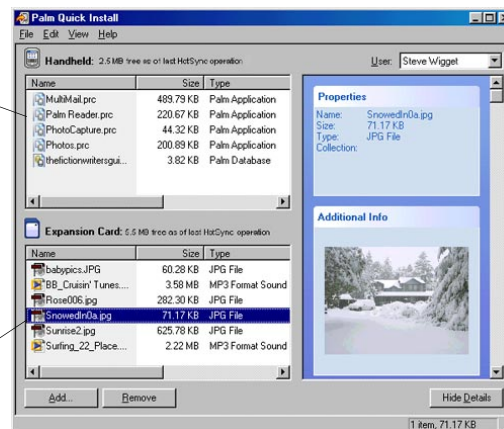

Expansion card file list

Status bar

3. From My Computer or Windows Explorer, select the file(s) or folder that you want to install.
4. Drag and drop the file(s) or folder onto the handheld or expansion card file list.

If a No symbol appears when you attempt to drag a file onto a file list, the file is not supported on that destination.

The status bar shows the number of files selected and their total size. However, because some file types are compressed during synchronization, they may actually require less space than the amount shown in the file size column or status bar.

5. Perform a HotSync operation to install the files. See [Chapter 20](#) for details.

**NOTE** Files that remain in the list after you perform a HotSync operation were not installed. This can happen if your handheld is too full to install the file or if the file type was not recognized during the HotSync operation. If files are unrecognized, try launching the associated application from your handheld and then performing another HotSync operation. If the files still remain in the list, they are not associated with an application on your handheld and cannot be installed. Expansion cards may also hold files that are not Palm application files.

To use the command buttons in the Palm Quick Install window:

1. Copy or download the application(s) or file(s) you want to install onto your computer.
2. Double-click the Palm Quick Install icon on the Windows desktop.

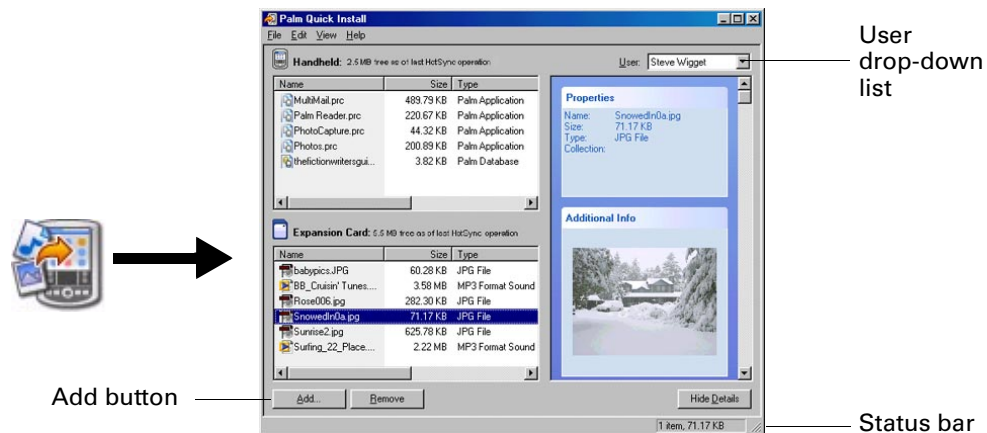

3. In the User drop-down list, select the name that corresponds to your handheld.
4. Click Add.

**TIP** To install a folder, open the File menu and select Add Folder.

5. Select the application(s) or file(s) that you want to install.

If you do not see the application(s) or file(s) in the default folder, navigate to the folder that contains the application(s) or file(s) that you want to install.

6. Click OK.
7. If you need to change the destination of the application you are installing, drag the files to move applications between the handheld and expansion card file list.

The status bar shows the number of files selected and their total size. However, because some file types are compressed during synchronization, they may actually require less space than the amount shown in the file size column or status bar.

8. Perform a HotSync operation to install the selected application(s). See [Chapter 20](#) for details.

**NOTE** Files that remain in the list after you perform a HotSync operation were not installed. This can happen if your handheld is too full to install the file or if the file type was not recognized during the HotSync operation. If files are unrecognized, try launching the associated application from your handheld and then performing another HotSync operation. If the files still remain in the list, they are not associated with an application on your handheld and cannot be installed. Expansion cards may also hold files that are not Palm application files.

**To use the right-click menu to send the file to Palm Quick Install:**

1. Copy or download the application(s) or file(s) you want to install onto your computer.
2. From My Computer or Windows Explorer, right-click the file(s) or folder that you want to install.
3. Select Send To, and then select Palm Quick Install.

Palm Quick Install displays a confirmation dialog box that shows whether the files will be installed on your handheld or on an expansion card.

4. Click OK.

The selected files are placed in the handheld or expansion card file list, based on the file extension.

5. Perform a HotSync operation to install the files. See [Chapter 20](#) for details.  
Any unrecognized files are not installed.

## Palm Quick Install tips

The following tips can help you use Palm Quick Install more effectively:

- Audio files are automatically placed in the expansion card file list. If you attempt to place audio files in the handheld file list, a No symbol appears.
- By default, Kinoma video files are placed in the expansion card file list. If you prefer to store these files on your handheld you can move them to the handheld file list.
- When you drag and drop a folder, Palm Quick Install looks at files in the first level of subfolders only; it does not look at folders nested inside the subfolders.
- To install files in a different location, start Palm Quick Install and drag the files to a different file list.
- You can also access the Palm Quick Install window by clicking Quick Install on the Palm Desktop launch bar.



## Installing applications and files on a Mac computer

The Install Tool makes it easy to install applications and files during a HotSync operation. You can specify whether to install the files on your handheld or on an expansion card.

To install add-on software on your handheld using a Mac computer:

1. On your Mac computer, copy or download the application you want to install into the Add-on folder in your Palm folder.
2. Double-click the HotSync Manager icon in the Palm™ folder.
3. From the HotSync menu, select Install Handheld Files.
4. From the User pop-up menu, select the name that corresponds to your handheld.

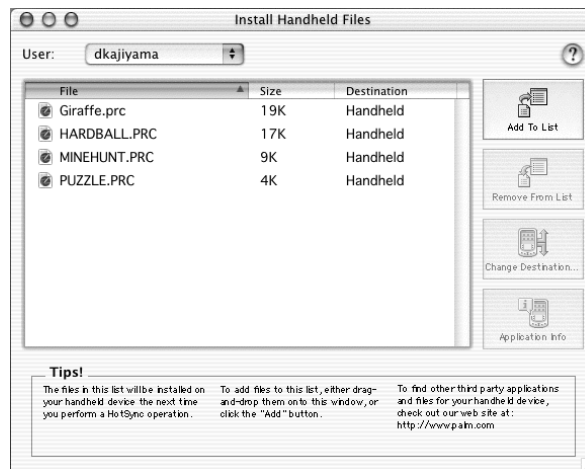

Shown with Mac OS X

5. Click Add To List.

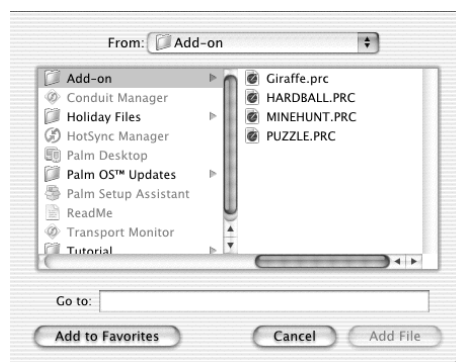

Shown with Mac OS X

If the file you want to install is not listed in the dialog box, go to the folder to which you copied the file. Most handheld application files have the extension PRC or PDB.

6. Select the application(s) you want to install.

- Click Add File to add the selected application to the Install Handheld Files list.

**TIP** You can also drag files, or folders of files, to the list in the Install Handheld Files dialog box. The files are copied to the Files To Install folder.

- If you need to change the destination of the application you are installing, click Change Destination in the Install Handheld Files window, and then use the arrows to move applications between your handheld and an expansion card.



Shown with Mac OS X



- Click OK to close the Change Destination window.
- Close the Install Handheld Files window.
- Perform a HotSync operation to install the selected application(s) on your handheld. See [Chapter 20](#) for details.

**NOTE** Files that remain in the list after you perform a HotSync operation were not installed. This can happen if the file type was not recognized during the HotSync operation. Expansion cards may hold applications that use files other than the Palm application files. For your handheld to recognize such a file, you must first launch the associated application at least once.

## Removing applications

If you run out of memory or decide that you no longer need an application you installed, you can remove applications from your handheld or from an expansion card. From your handheld, you can remove only add-on applications, patches, and extensions that you install; you cannot remove the applications that reside in the ROM portion of your handheld.

**To remove an add-on application:**

- Tap the Home icon .
- Tap the Menu icon .
- Select Delete on the App menu.
- Tap the Delete From pick list and select either Handheld or Card. If you want to delete applications from a card, the card must be seated in the expansion card slot.

5. Tap the application that you want to remove.



6. Tap Delete.
7. Tap Yes.
8. Tap Done.

## Removing Palm™ Desktop software

If you no longer want to use Palm Desktop software, you can remove it from your computer.

This process removes only the application files. The data in your Users folder remains untouched.

---

**IMPORTANT** If you remove Palm Desktop software, you also remove the HotSync Manager synchronization software and can no longer synchronize with your computer. If you want to synchronize data with another personal information manager (PIM), you need to have Palm Desktop software installed.

---

**NOTE** You may need to modify the steps shown here to accommodate the version of the operating system installed on your computer.

### To remove Palm Desktop software from a Windows computer:

1. From the Windows Start menu, select Settings and then click Control Panel.
2. Double-click the Add/Remove Programs icon.
3. Click the Change or Remove Programs button.
4. Select Palm Desktop.
5. Click Change/Remove.

This process removes only the application files. The data in your Users folder remains untouched.

6. Click Yes in the Confirm File Deletion checkbox.
7. Click OK.
8. Click Close.

**To remove Palm Desktop software from a Mac computer:**

1. Insert the Software Installation CD-ROM into the CD-ROM drive on your computer.
2. Double-click the Software Installation CD-ROM icon on your desktop.
3. Double-click the Palm Desktop Installer icon.
4. From the Easy Install screen, select Uninstall from the pop-up menu.
5. Select the software you want to remove.
6. Click Uninstall.
7. Select the folder that contains your Palm Desktop software files.
8. Click Remove.
9. Restart your computer.

# Using Calendar



Calendar enables you to quickly and easily schedule appointments or any kind of activity associated with a time and date. You can attach notes to Calendar events and set alarms to remind you when they happen.

**NOTE** Certain tasks are common among several handheld applications. For more information, see [Chapter 4, "Working with Applications."](#)

**To open Calendar:**

- Press the Calendar application button on the front panel of your handheld. Calendar opens to Agenda View by default.

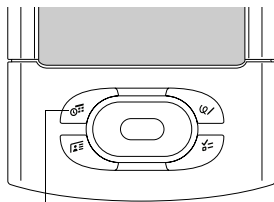

Calendar application button

**TIP** Press the Calendar application button repeatedly to cycle through the Agenda, Day, Week, and Month views.

## Working in Agenda View

The Agenda View shows you your daily appointments and events, Task items in one screen. you can also choose to show messages from your e-mail program.

To display the Agenda View:

- Tap the Agenda View button.

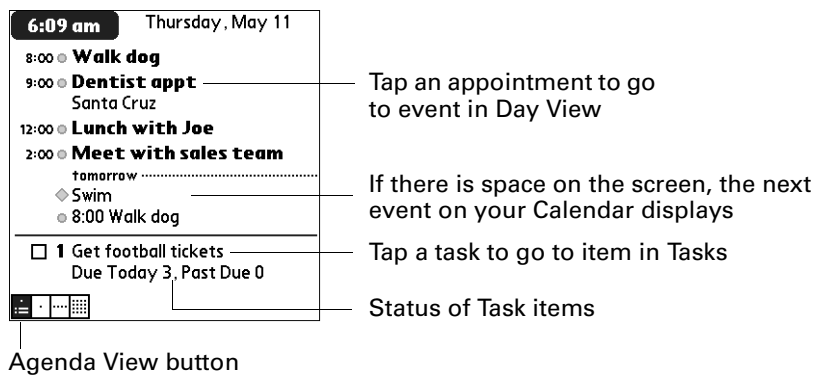

## Setting Agenda View display options

You can customize the Agenda View appearance using the Display Options dialog box. To set the start and stop times for the calendar screens, see “[Option menu/Preferences](#)” later in this chapter.

<b>Default View</b>	Choose from the pick list the view that displays when you open Calendar.
<b>Show Due Tasks</b>	Displays tasks that are due today and tasks that are past due.
<b>Show Messages</b>	Shows the number of read and unread e-mail messages.
<b>Background Image</b>	Displays a background image in Agenda view.

## Working in Day View

Day View shows the calendar of your events for an entire day. Day View is the working area of Calendar, where you schedule and remove events, and set alarms.

### To display the Day View:

- Tap the Day View button.

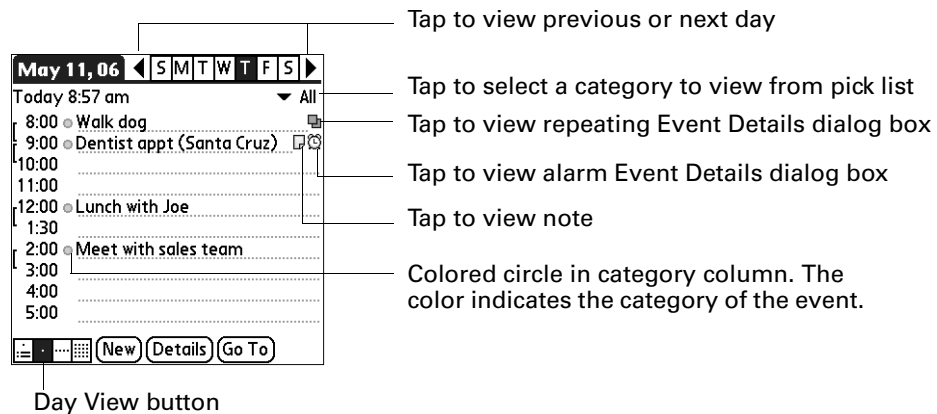

## Setting Day View display options

You can customize the Day View appearance using the Display Options dialog box. To set the start and stop times for the calendar screens, see [“Option menu/Preferences”](#) later in this chapter.

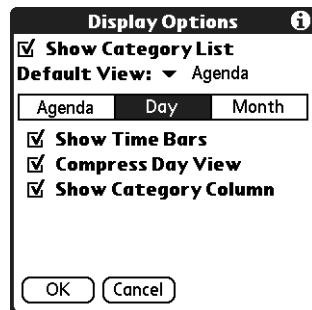

### Show Category List

By default, the Category pick list does not appear at the top of the screen. You can choose to have the pick list display by selecting the check box.

### Default View

Choose from the pick list the view that displays when you open Calendar.

- Show Time Bars** Activates the time bars that appear in the Day View. The time bars show the duration of an event and illustrate event conflicts.
- Show Category Column** Displays the color-coded circle between the time and event. The color indicates the category the event is filed under.

## Scheduling an event

When you schedule an event, its description appears on the time line, and its duration is automatically set to one hour.

To schedule an event for the current day:

1. Tap the time line that corresponds to the beginning of the event or tap New.

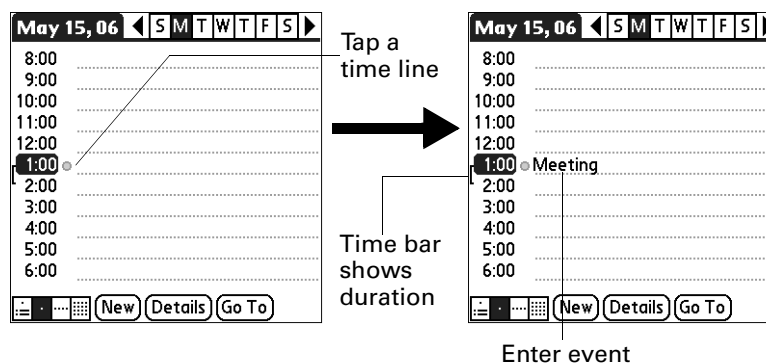

2. Enter a description of the event. You can enter up to 255 characters.
3. If the event is one hour long, skip to step 5. If the event is longer or shorter than an hour, tap the time of the event to open the Set Time dialog box.

**TIP** You can also use the Graffiti® 2 input area to open the Set Time dialog box. Make sure that no event is selected, and then on the number side of the Graffiti 2 input area, write a number for the start time of the event.

4. Do one of the following:
  - Tap the time columns on the right side of the Set Time dialog box to set the start time, and then tap the End Time box and tap the time columns to set the end time.
  - Tap All Day to automatically insert the start and end time of the event as defined in your Calendar Preferences.



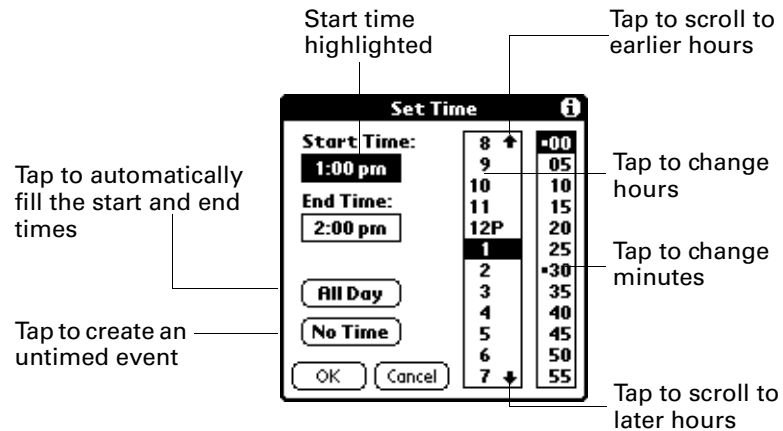

5. Tap OK.
6. Tap a blank area of the screen to deselect the event. A vertical line appears next to the time, indicating the duration of the event.



If two or more events have the same start and end time, the time appears only once.

**NOTE** You can schedule events that span midnight so that they appear in the list of events for two days. An event spanning midnight is automatically created when your End Time precedes a Start Time. An event spanning midnight cannot be longer than 24 hours.

#### To schedule an event for another day:

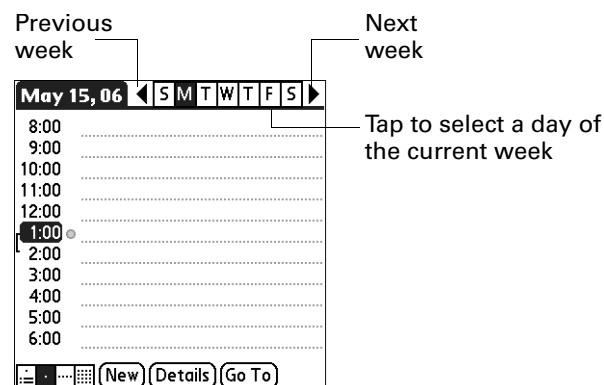
1. Select the date you want for the event by doing one of the following:
  - Tap the day of the week that you want in the date bar at the top of the screen. If necessary, tap the Previous week or Next week scroll arrows to move to another week.



-  Press Right or Left on the navigator to scroll to the next or previous day.
-  Press Up or Down on the navigator to scroll within the current day.

- Tap Go To at the bottom of the screen to open the Go to Date dialog box. Select a date by tapping a year, month, and day in the calendar.

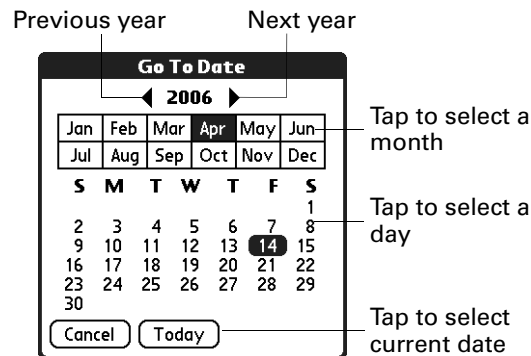

2. After you locate the date, follow the steps for scheduling an event for the current day.

**To schedule an untimed event:**

1. Select the date that you want for the event.
2. Tap New.
3. Tap No Time, so that no start or end times are defined for the new event.

**TIP** You can also create a new untimed event by making sure no event is selected and then writing letters in the Graffiti 2 input area.

4. Enter a description of the event.

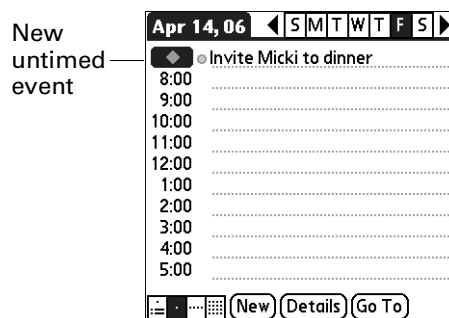

5. Tap a blank area on the screen to deselect the untimed event.

If you create an event and decide later that there is no particular start or end time, you can easily change it to an untimed event. Tap the time of the event in the Calendar screen, tap No Time, and then tap OK.

**TIP** To attach a note to an entry and work with attached notes, see [“Attaching notes”](#) in [Chapter 4](#).

## Scheduling repeating or continuous events

The Repeat function enables you to schedule events that recur at regular intervals or that extend over a period of consecutive days.

### To schedule a repeating or continuous event:

1. Select the event.
2. Tap Details.
3. Tap the Repeat box to open the Change Repeat dialog box.
4. Tap Day, Week, Month, or Year to set how often the event repeats.

For a continuous event, tap Day.

5. On the Every line, enter a number that corresponds to how often you want the event to repeat

For example, if you select Month and enter the number 2, the event repeats every other month.

6. To specify an end date for the repeating or continuous event, tap the End on pick list and tap Choose Date. Use the date picker to select an end date.
7. Tap OK.

After you schedule a repeating or continuous event, the Repeat icon  appears at the far right of the event.

### To delete repeating events:

1. Select the record you want to delete.
2. Tap the Menu icon .
3. Select Delete Event from the Record menu.
4. Do one of the following:
  - Tap Current to delete only the current event item.
  - Tap Future to delete the current and all future event items and reset the end date of the repeating event to the last shown date.
  - Tap All to delete all occurrences of the repeating event.
5. Tap OK.

## Setting an alarm for an event

The Alarm setting enables you to set an alarm for events in your Calendar. When you set an alarm, the Alarm icon  appears at the far right of the event. When the alarm is triggered, a reminder message also appears onscreen.

**To set an alarm for an event:**

1. Select the event to which you want to assign an alarm.
2. Tap Details.
3. Tap the Alarm check box to select it.  
The default setting, 5 Minutes, appears.
4. Tap the pick list to select Minutes, Hours, or Days.
5. Select the 5 and enter any number from 0 to 99 (inclusive) as the number of time units.

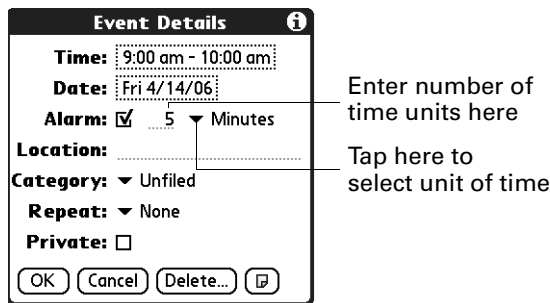

6. Tap OK.
7. When the reminder message appears onscreen, do one of the following:
  - Tap OK to permanently dismiss the reminder and return to the current screen.
  - Tap Snooze to dismiss the reminder and return to the current screen. An attention indicator blinks in the upper-left corner of the screen to remind you of the pending alarm, and the reminder message appears again five minutes later.
  - Tap Go To to open Calendar. Calendar will open and display the event associated with the alarm.

**Alarm for untimed events:** You can set a silent alarm for an untimed event. In this case the alarm is triggered at the specified period of minutes, hours, or days before midnight (beginning) of the day of the untimed event. When the alarm is triggered, the reminder list displays the alarm message until you clear it. See [“Receiving alerts”](#) in [Chapter 4](#) for details.

For example, you set an alarm for an untimed event that occurs on February 4. If the alarm is set for 5 minutes, the reminder message appears at 11:55 PM on February 3. The reminder remains in the reminder list until you turn on your handheld and dismiss it.

## Setting an event location

Events can have a location that appears in the Day view and in the Details view.

**To add an event location:**

1. Select an event.
2. Tap Details.
3. Tap Location and enter a location.
4. Tap OK.

In Day view, the location appears in parenthesis after the event description.

## Rescheduling an event

You can easily make changes to your schedule with your handheld.

**To reschedule an event:**

1. Select the event you want to reschedule.
2. Tap Details.
3. To change the time, tap the Time box, and then tap a new time.
4. To change the date, tap the Date box, and then tap a new date.
5. Tap OK.

## Using categories

Categories are a way to group similar events so that they can be viewed separately. The color coding in Calendar makes it easy to track events from different categories when all events are shown. For more information on categories, see [“Categorizing records”](#) in [Chapter 4](#).

**To categorize an event:**

1. Select the event you want to categorize.
2. Tap Details.
3. Tap Category pick list and select a category
4. Tap OK.

**To edit a category or create a new category:**

1. Select the event you want to categorize.
2. Tap Details.
3. Tap Category pick list and select a Edit Categories

4. Perform one of the following:
  - To edit a category, select a category and tap Edit.
  - To create a new category, tap New.

The Edit Category dialog box opens.

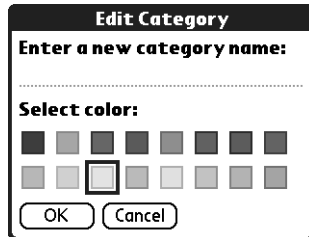

5. Enter a new name and select a color.
6. Tap OK.

## Working in Week View

Week View shows the calendar of your events for an entire week.

**To display the Week View:**

1. Tap the Week View button.
2. Tap the navigation controls to move forward or backward a week at a time, or tap on a column to display details of an event.

The Week View also shows untimed events and events that are before and after the range of times shown. Continuous events appear in green with the Repeat icon

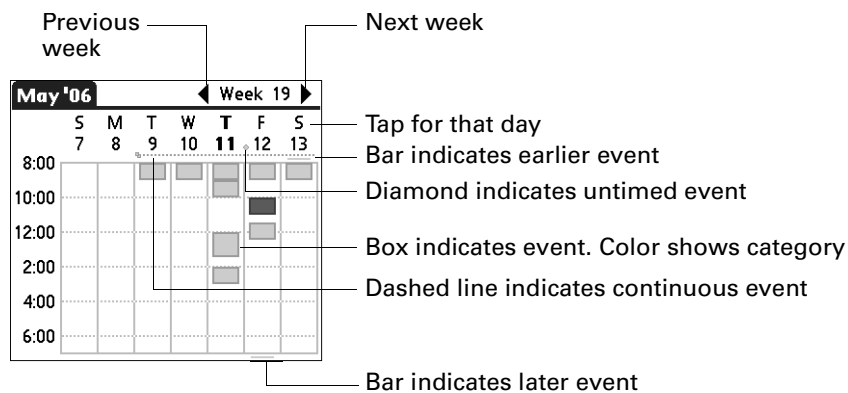

- Tap an event to show a description of the event.

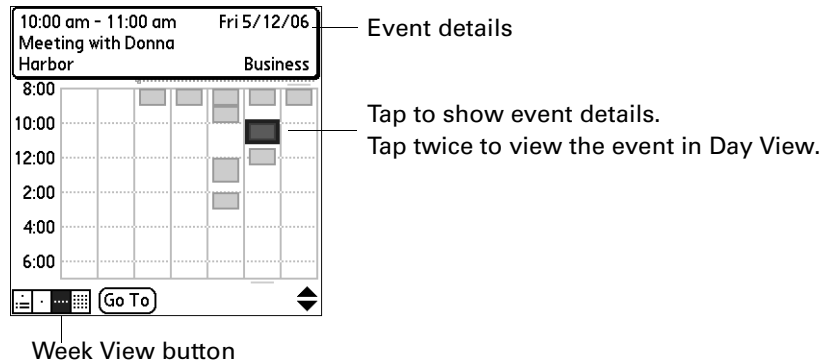

Keep the following points in mind:

- Tap any day or date that appears at the top of the Week View to move directly to that day without selecting an event.
- Press Right and Left on the navigator to scroll to the next or previous week.
- Press Select on the navigator to insert a highlight, and then press Right and Left to select a day within the selected week. To go to Day View for that day, press Select on the navigator again.
- The Week View shows the time span defined by the Start Time and End Time in the Calendar Preferences settings. If you have an event before or after this time span, a bar appears at the top or bottom of that day's column. Use the onscreen scroll arrows to scroll to the event, or press Up and Down on the navigator to scroll to earlier and later time slots within the selected week.

## Working in Month View

The Month View screen shows which days have events scheduled.

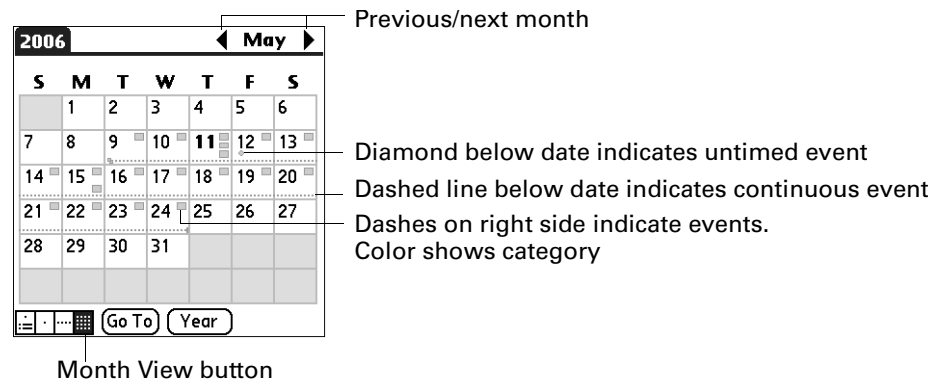

You can control the types of events that appear in the Month View. See [“Setting Month View display options”](#) later in this chapter.

Keep the following points in mind:

- Tap a day in Month View to display that day in the Day View.
- Tap the scroll arrows in the upper-right corner, or press Left or Right on the navigator to move forward or backward a month.
- Press Select on the navigator to insert the highlight, and then press Left or Right on the navigator to scroll to a specific day. Press Select on the navigator to display that day in the Day View.

Tap the Input Area icon  on the status bar to hide the input area so that you can view the previous and next months

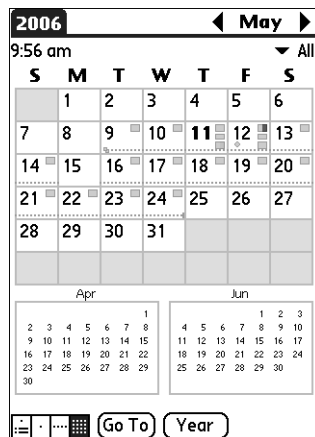

## Setting Month View display options

You can customize the Month View appearance using the Display Options dialog box. To set the start and stop times for the calendar screens, see [“Option menu/Preferences”](#) later in this chapter.



### Show Category List

By default, the Category pick list does not appear at the top of the screen. You can choose to have the pick list display by selecting the check box.

### Default View

Choose from the pick list the view that displays when you open Calendar.



- Timed Event** Shows events that have a time range.
- Untimed Events** Shows events that do not have a time range.
- Daily Repeating Events** Shows events that repeat every day.

## Working in Year View

The Year View screen allows you to view multiple months.

To display the Year View:

- Perform one of the following:
  - From the Options menu, select Year View.
  - From the Month View screen, tap the Year Button.

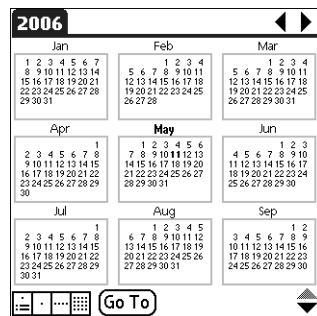

## Spotting event conflicts

With the ability to define specific start and end times for any event, you could schedule events that overlap (an event that starts before a previous event finishes).

An event conflict (time overlap) appears in the Week View as overlapping bars. The first event created appears as a gray bar, and any subsequent conflicting events appear as a single red bar. The Day View displays overlapping red brackets to the left of the conflicting times.

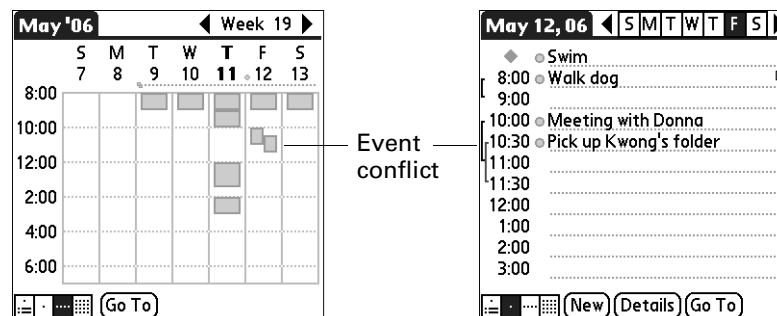

## Beaming events

You can share your calendars with family or business associates by beaming events and categories. For more information on beaming, see [“Beaming data”](#) in [Chapter 3](#).

**To beam an event:**

1. Tap the Menu icon .
2. Select Beam Event.

**To beam a category of events:**

1. Tap the Menu icon .
2. Select Beam Category.
3. The Beam Category dialog box opens.
4. Tap the Category pick list, and then select a category.
5. Tap the Beam events for pick list, and then select a date or date range.

You can select one of the date ranges in the list or create your own range by selecting Date Range.

If you select Date Range, the Date Range dialog box opens; you can set a start and end range using the Set Date dialog box.

6. Tap Beam.

**To receive a beamed category of events:**

- Perform one of the following in the Receive Category dialog box:
  - Tap Add to add a new category or add the events to the current category by the same name.
  - Tap Replace to delete the events in the current category and replace them with the beamed events.
  - Tap the Category pick list, and then select the category you want the events added to. Then tap Add.

## Viewing birthday events

If you have a birthday event set in Contacts, the event displays with the untimed events. For more information about setting a birthday in Contacts, see [“Creating a contact”](#) in [Chapter 7](#).

**To view a birthday event:**

- Tap the event listing.

The Birthday dialog box appears showing the settings.

## Using Calendar menus

Calendar features that are not explained elsewhere in this book are described here. See “Using menus” in [Chapter 4](#) for information about choosing menu commands.

### Record menu

- |                   |   |
|-------------------|---|
| <b>Purge</b>      | Opens a dialog box where you can choose which old events to purge from your handheld and whether you want to archive purged events on your computer.                        |
| <b>Send Event</b> | Opens a dialog box where you can choose how you want to send the selected event to another device. The options available depend on the software installed on your handheld. |

### Option menu/Preferences

Opens the Preferences dialog box, where you can customize Calendar’s default time display and alarm settings.

- |                       |   |
|-----------------------|---|
| <b>Start/End Time</b> | Defines the start and end times for Calendar screens. If the time slots you select do not fit on one screen, you can tap the scroll arrows  to scroll up and down. |
| <b>Alarm Preset</b>   | Automatically sets an alarm for each new event. The silent alarm for untimed events is defined by minutes, days, or hours before midnight at the beginning of the date of the event.  |
| <b>Alarm Sound</b>    | Sets the tone of the alarm.   |
| <b>Remind Me</b>      | Defines how many times the alarm will occur after the initial occurrence. The choices are Once, Twice, 3 Times, 5 Times, and 10 Times.  |
| <b>Play Every</b>     | Defines how often the alarm sounds. The choices are Minute, 5 minutes, 10 minutes, and 30 minutes.  |



# Using Card Info

 Card Info enables you to review general information about an expansion card. You can review card contents, rename a card, and format a card.

## Reviewing Card Information

You can view the card name, type, available storage space, and a summary of its contents.

To review Card Information:

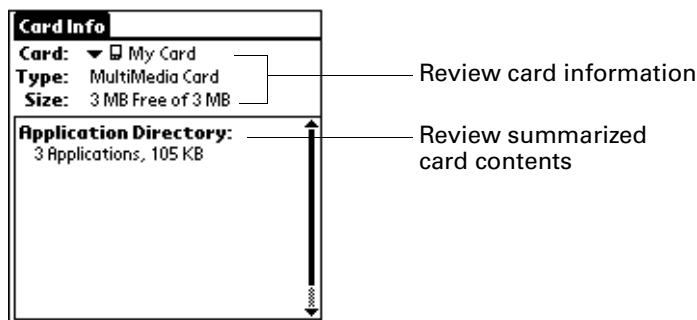

1. Tap the Home icon .
2. Tap the Card Info icon .



## Renaming a card

You can assign a name to each expansion card that appears in the Category pick list and in other lists.

To rename a card:



1. Tap the Home icon .
2. Tap the Card Info icon .
3. Tap the Menu icon .
4. Select Rename Card from the Card menu.

5. Enter the new name for the card.
6. Tap Rename.

## Formatting a card

Formatting a card destroys all its data and prepares it to accept new applications and data.

**To format a card:**

1. Tap the Home icon .
2. Tap the Card Info icon .
3. Tap the Menu icon .
4. Select Format Card from the Card menu.
5. Tap OK.

## Managing expansion cards

- When writing data to an expansion card, wait for your handheld to complete the operation before removing the card from the slot. This prevents data corruption or accidental damage to the expansion card.
- You can install applications to an expansion card after performing an initial HotSync® operation. See [“Installing files and add-on applications”](#) in [Chapter 4](#) for information. For optimal performance, we recommend that you do not install more than 50 applications to a single expansion card.
- Reading and writing information on an expansion card uses more battery power than performing the same task on your handheld. If you have ample storage space on your handheld, consider copying the information to your handheld.



**NOTE** You must store and access MP3™ files from an expansion card.

- When your handheld’s battery level becomes very low, access to the expansion card may be disabled to protect your data. If this occurs, recharge your handheld as soon as possible.

## Using Card Info help

Card Info help is available to explain Card Info features.

**To access Card Info help:**

1. Tap the Home icon .
2. Tap the Card Info icon .
3. Tap the Menu icon .
4. Select Help from the Card menu.





# Using Contacts



Contacts enables you to maintain names, addresses, phone numbers, and other information about your personal or business contacts.

**NOTE** Certain tasks are common among several handheld applications. For more information, see [Chapter 4, “Working with Applications.”](#)

### To open Contacts:

- Press the Contacts application button on the front panel of your handheld. Contacts opens to display the list of all your records.

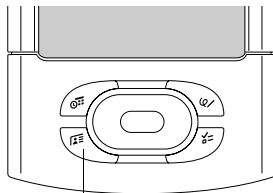

Contacts button

**TIP** Press the Contacts application button repeatedly to cycle through the categories in which you have records. Pressing and holding the application button will beam your business card to another handheld. See [“Creating a business card”](#) later in this chapter for information.

## Creating a contact

You can create contacts on your handheld, or you can use Palm™ Desktop software to create contacts on your computer and then transfer the contacts to your handheld with your next HotSync® operation.

**To create a new contact:**

1. Press the Contacts application button  on the front of your handheld to display the Contacts list.
2. Tap New.

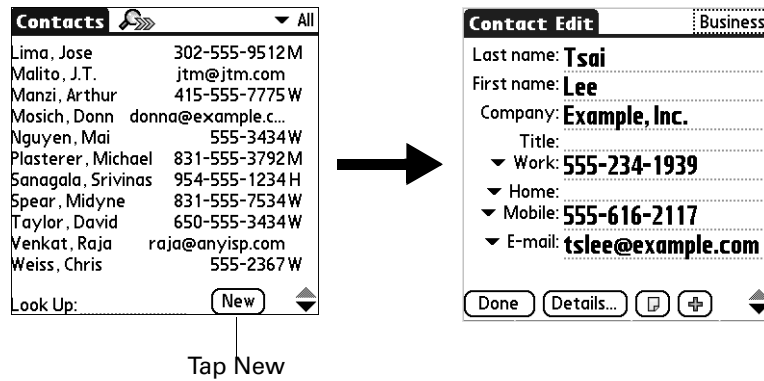

3. Tap each field for which you have contact information and enter the information. The features described in the following table help streamline and organize contact data entry.

**TIP** Tap the scroll arrows  to move to the next page of information. See [“Options menus”](#) later in this chapter for information on the custom fields that appear at the bottom of the Contact Entry screen.

Field name	Feature
All fields except numeric and e-mail fields	The handheld automatically capitalizes the first letter of each field. You do not have to use the Graffiti® 2 capital stroke to capitalize the first letter of the name.
Title, Company, City, and State	Text appears for the first logical match that exists in your Contacts list. As you enter more letters, a closer match appears. For example, you may already have Sacramento and San Francisco in your Contacts list. As you enter <i>S</i> , Sacramento appears, and as you continue entering <i>a</i> and <i>n</i> , San Francisco replaces Sacramento. As soon as the word you want appears, tap the next field to accept the word.
Address	You can enter up to three addresses. Each address contains five fields: Addr, City, State, Zip Code, and Country. You can designate an address as work (W), home (H), or other (O). By default, Contacts enters the first address as work.

**Field name****Feature**

Birthday

To enter contact birthday information, do the following:

1. Tap in the box, use the left and right arrows to scroll to the year you want, and then tap to select the birth month and date (or tap Today to select the current date as the birthday).



**TIP** If you do not select a year, the current year is displayed. Tap and hold the left or right arrow to scroll quickly through the years.

2. If you want a reminder, select the Reminder check box, enter the number of days in advance of the birthday that you want the reminder to appear, and then tap OK.

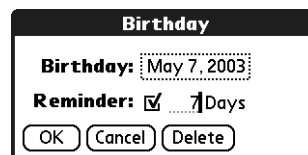

**NOTE** Birthdays you enter in Contacts appear as untimed events in Calendar. If you update the birthday in Contacts, it automatically updates in Calendar as well.

4. After you finish entering information, tap Done.

**TIP** To create a contact that always appears at the top of the Contacts list, begin the Last name or Company field with a symbol, as in \*If Found Call\*. This contact can contain contact information in case you lose your handheld.

## Displaying additional contact fields

The Contact Edit screen displays certain fields by default. You can customize the Contact Edit screen to display additional fields that you want.

If you display an additional field and leave it blank, the field is not displayed when you return to the Contact Edit screen. You must enter information into the field in order for it to continue to display on the Contact Edit screen.

To display additional contact fields:

1. Tap the plus button on the lower-right corner of the Contact Edit screen.



2. Select the field you want displayed. The fields appear in a preset order on the Contact Edit screen.

**NOTE** Each field type can be displayed a certain number of times on the Contact Edit screen; for example, you can display multiple IM fields. Contacts sets a maximum number for how many times each field type can appear on the screen. Once you reach this maximum (for example, the maximum number of IM fields is displayed), the field type no longer appears on the pop-up list.

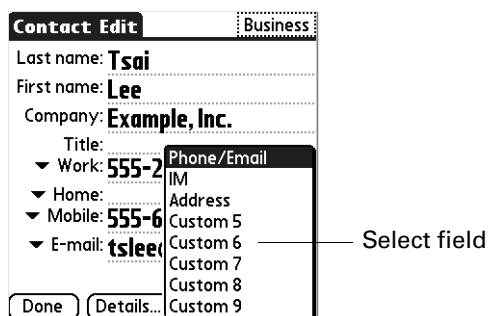

## Selecting field types

You can select the types of phone numbers or e-mail addresses, as well as specify the instant messenger (IM) account, that you associate with a contact. Any changes you make apply only to the current contact.

**To select field types in a contact:**

1. Tap the contact that you want to change.
2. Tap Edit.
3. Tap the pick list next to the label you want to change.

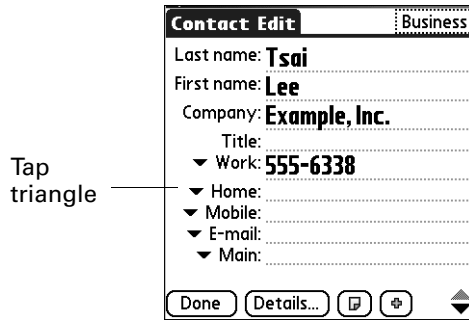

4. For phone numbers and e-mail addresses: Select a new label.

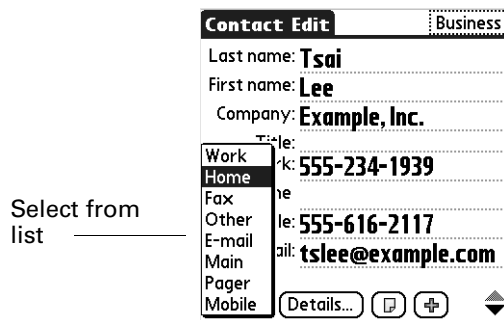

For IM accounts: Select the IM service you want to use, or select IM if you do not want to specify a service. You must set up an IM account with a service provider to use IM on your handheld. See [“Making connections from Contacts”](#) later in this chapter for more information.

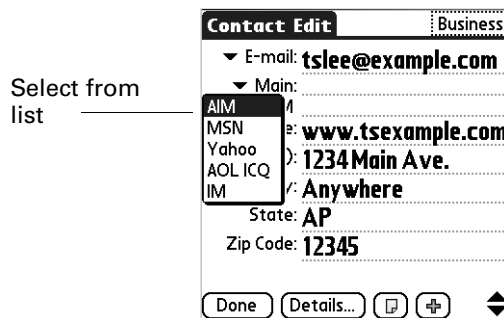

## Changing Contact details

The Contact Details dialog box provides a variety of options that you can associate with a contact.

To open the Contact Details dialog box:

1. Tap the contact whose details you want to change.



**TIP** You can also use the navigator to open a contact. See “Using the navigator” in Chapter 2 for instructions.

2. Tap Edit, and then tap Details.



3. Select any of the following settings:

- |                     |  |
|---------------------|--|
| <b>Show in List</b> | Select which type of phone or other information appears in the Contacts list screen. Your options are Work, Home, Fax, Other, E-mail, Main, Pager, and Mobile. The identifying letters <i>W</i> , <i>H</i> , <i>F</i> , <i>O</i> , <i>M</i> , or <i>P</i> appear next to the record in the Contacts list, depending on which information is displayed. If you select E-mail, no identifying letter is displayed. |
| <b>Category</b>     | Assign the contact to a category.  |
| <b>Private</b>      | Hide this contact when Security is turned on.  |

## Creating a business card

You can create a contact to contain your business card information: your name, company, and contact information. You can then beam this business card information to other handhelds. See “Beaming data” in Chapter 3 for information on setting up and beaming business card information.

## Making connections from Contacts

You can use the contacts in your Contacts list to launch applications that perform tasks such as dialing a phone number or creating an e-mail or SMS message. Some of the applications you can launch are included on the CD-ROM that comes with your handheld, and others may be available from third-party developers and are sold separately. Most of these applications require a GSM mobile phone (sold separately) that is compatible with your handheld.



## Quick Connect

If you have a compatible GSM mobile phone (sold separately), you can use Quick Connect to select a contact and initiate a related task with one hand, using the navigator. You can also configure which application opens when you choose a specific Contacts record field, and whether to add a prefix to all phone numbers.

### To use Quick Connect from a contact:

1. Open the contact to which you want to connect.
2. Press Right on the navigator to open the Quick Connect dialog box.

**TIP** You can also tap the Quick Connect icon in the title bar of the Contacts record.

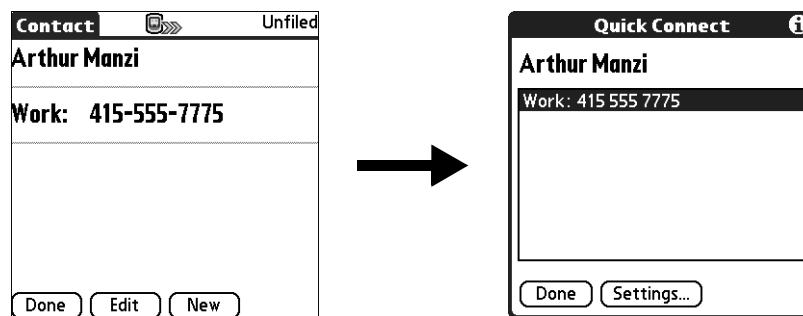

3. Select the method you want to use to connect.

Quick Connect initiates the related task. For example, if you tap a phone number, Quick Connect sends the selected phone number to your mobile phone.

### To use Quick Connect from the Contacts list:

1. Highlight the contact to which you want to connect.
2. Tap the Menu icon .
3. Select Connect on the Record menu.
4. Select the method you want to use to connect.

Quick Connect initiates the related task. For example, if you tap a phone number, Quick Connect sends the selected phone number to your mobile phone.

**NOTE** To use the Quick Connect feature, you must have all the requirements for that connection type. For example, to connect by tapping an e-mail address, you must have installed the e-mail application on your handheld and have an e-mail account with an Internet service provider (ISP). See the documentation included with the desired connection type for requirements to use that connection type.

**To configure Quick Connect settings:**

1. From the Quick Connect dialog box, tap Settings.

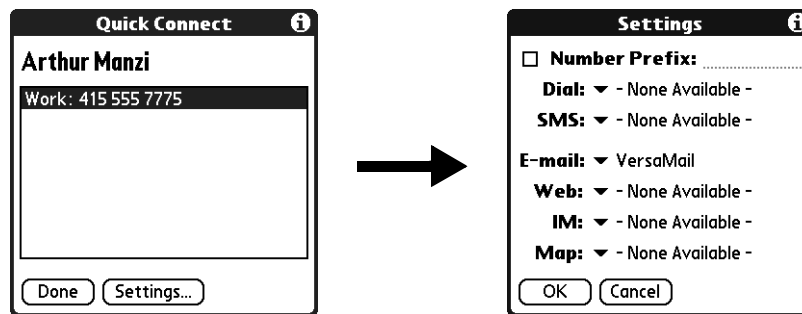

2. (Optional) Tap the Number Prefix check box, and then enter a prefix.  
For example, to dial 1 before all phone numbers, select this check box and enter a "1" in this field. The prefix is not added to a number that begins with the "+" character.
3. Tap each of the pick lists and select the application you want to associate with that task.
4. Tap OK.

**Tap-to-Connect**

With Tap-to-Connect, you can select a contact and initiate a related task by tapping it with the stylus. By default, Tap-to-Connect is not enabled.

**To enable Tap-to-Connect:**

1. From the Contacts list, tap the Menu icon .
2. Select Option, and then select Preferences.
3. Tap Enable Tap-to-Connect.
4. Tap OK.

**TIP** You can also configure which application opens when you tap a specific Contacts record field, and whether to add a prefix to all phone numbers. See ["Quick Connect"](#) earlier in this chapter to learn how to configure these settings.

**To make a connection with Tap-to-Connect:**

1. Open the contact to which you want to connect.
2. Tap an item.

For example, to dial a phone number, tap the number you want to dial. To address an e-mail message, tap an e-mail address.



3. (Optional) Tap the number to edit it.

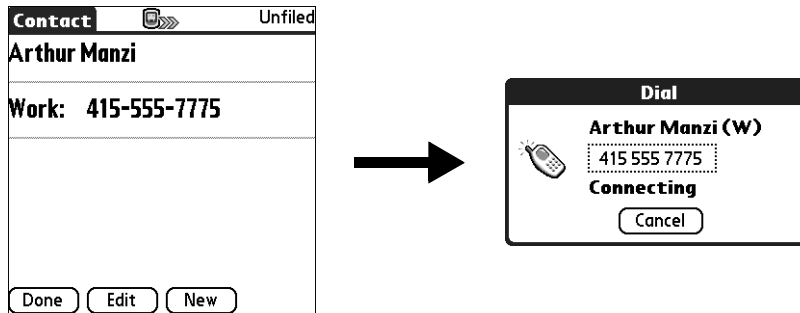

For example, you might want to add an area code, a 1, or a country code to a phone number.

## Using Contacts menus

Contacts menu commands that are not explained elsewhere in this book are described here. See [“Using menus”](#) in [Chapter 4](#) for information about selecting menu commands.

The Record and Options menus differ depending on whether you’re displaying the Contacts list screen or the Contacts Edit screen.

### Record menus

<b>Duplicate Contact</b>	Makes a copy of the current record and displays the copy in Contacts Edit so you can make changes to the copied record. The copy has the same category and attached notes as the original record.
<b>Connect</b>	Opens the Quick Connect dialog box, where you can choose which application you want to use to make the connection.
<b>Send Category</b>	Opens a dialog box where you can choose how you want to send all records in the selected category to another device.
<b>Send Contact</b>	Opens a dialog box where you can choose how you want to send the selected contact to another device.

## Options menus

**Preferences** Opens a dialog box where you can choose Contacts display options.

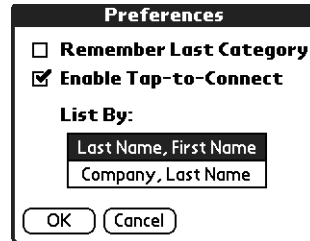

**Remember Last Category.** Determines how Contacts appears when you return to it from another application. If you select this check box, Contacts shows the last category you selected. If you deselect it, Contacts displays the All category.

**Rename Custom Fields** These custom fields appear at the end of the Contacts Edit screen. Rename them to identify the kind of information you enter in them. The names you give the custom fields appear in all contacts.

You can use these custom fields to track additional information in your Contacts records, such as names of spouses, children, or any other details.

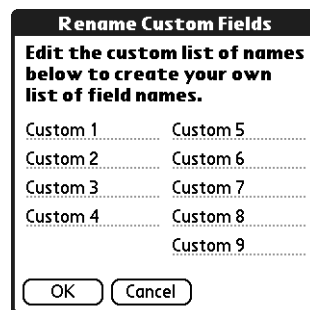

**About Contacts** Shows version information for Contacts.

# Using Palm™ Dialer





Palm™ Dialer is a fast and simple way to use your handheld to dial a telephone number on your mobile phone. The Palm Dialer also allows you to speed-dial frequently called numbers and to log recently called numbers.

---

**IMPORTANT** Your mobile phone plan must be a Global System for Mobile Communications (GSM) phone in order to use Palm Dialer.

---

To open Palm Dialer:

1. Tap the Home icon .
2. Tap the Palm Dialer icon .

## Configuring phone preferences and connecting to your mobile phone

You need to configure the phone preferences of your handheld and connect your handheld to your mobile phone before you use Palm Dialer. For information on configuring your phone preferences, see [Chapter 21](#). For information on connecting your handheld to your mobile phone, see “[Setting up a phone connection](#)” in [Chapter 12](#).

## Dialing a number

Palm Dialer allows you to directly dial a number from your handheld.

To dial a number:

1. Tap the telephone number on the keypad.

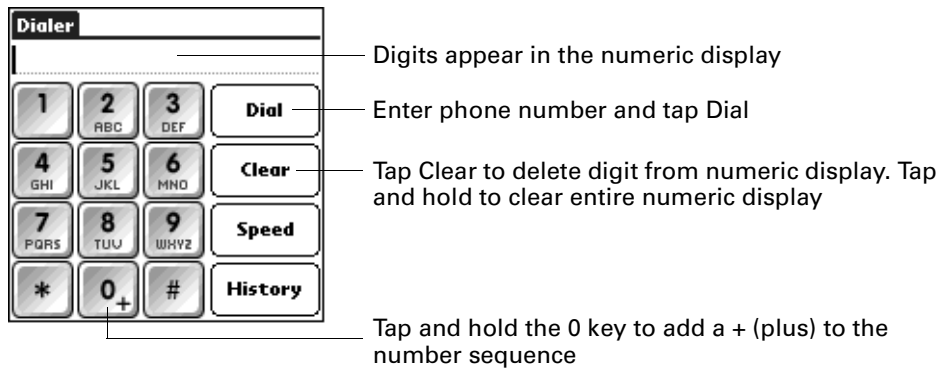

2. Tap Dial.

## Redialing the most recently dialed number

You can quickly redial the most recently dialed number from the Dialer screen.

To redial the most recently dialed number:

1. Tap Dial when the numeric display is empty.
2. Tap Dial again.

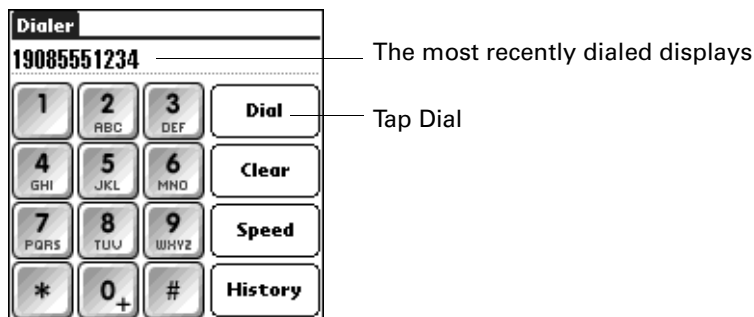

## Using speed dial

Speed dialing allows you to quickly dial ten of your most commonly used numbers.

**To add a speed-dial entry:**

1. Tap Speed.
2. Tap an empty speed-dial button.

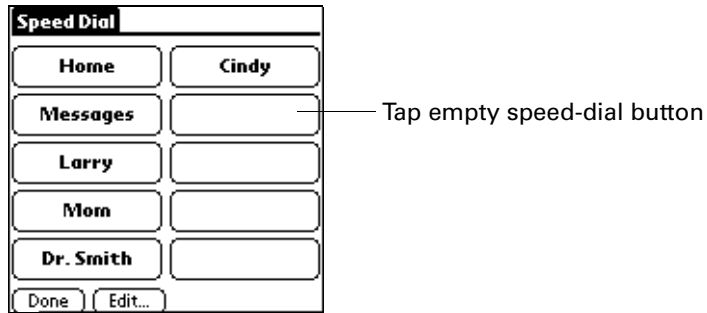

3. Enter a name and telephone number.
4. Tap OK.  
The name appears on the speed-dial button.
5. Tap Done.

**To dial a speed dial entry:**

1. Tap Speed.
2. Tap one of the speed-dial buttons.

The number is dialed and added to the Call History list. You are now ready to communicate over your mobile phone.

**To edit a speed-dial entry:**

1. Tap Speed.
2. Tap Edit.

**TIP** You can also go directly to the Edit Entry dialog box by tapping and holding a speed-dial button.

3. Tap an entry.
4. Edit the entry and tap OK.

## Dialing a number from the Call History list

You can dial a number using the Call History list of 11 of the most recently dialed numbers.

**To dial a number from the Call History list:**

1. Tap History.
2. Tap an entry from the list.
3. Tap Dial.

The number is dialed and you are now ready to communicate over your mobile phone.

# Using Expense



Expense enables you to keep track of your expenses and then transfer the information to a spreadsheet on your computer.

**NOTE** Certain tasks are common among several handheld applications. For more information, see [Chapter 4, “Working with Applications.”](#)

To open Expense:

1. Tap the Home icon .
2. Select the Expense icon .

## Adding expense items

You can sort your Expense items into categories.

To add an expense item:

1. Tap New.

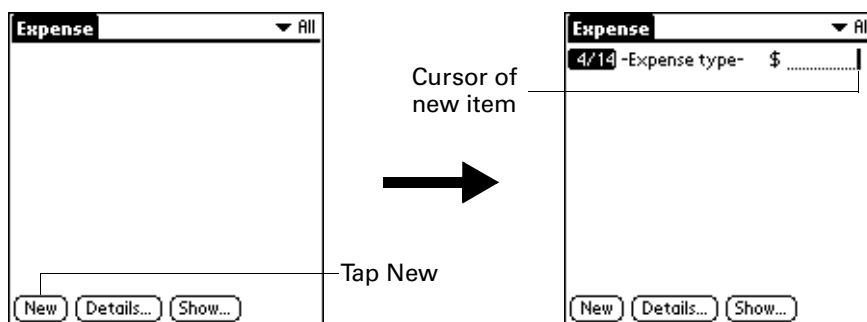

2. Enter the amount of the expense.

3. Tap the Expense type pick list and select a type from the list.

As soon as you select an expense type, your handheld saves your entry. If you do not select an expense type, it does not save the entry.

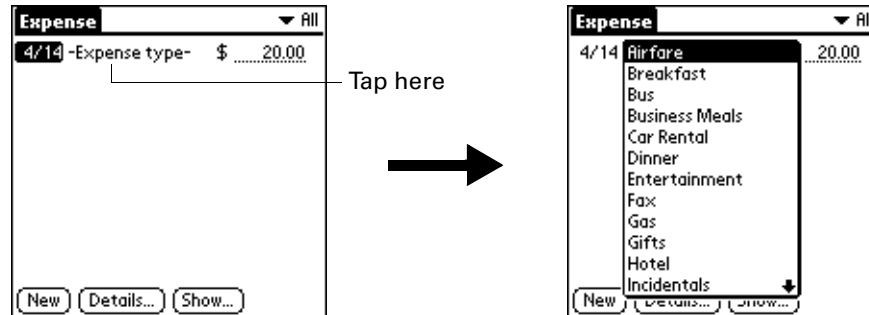

**TIP** To attach a note to an entry and work with attached notes, see [“Attaching notes”](#) in [Chapter 4](#).

## Changing the date of an Expense item

You can change the date associated with any Expense item.

**To change the date of an Expense item:**

1. Tap the Expense item you want to change.
2. Tap the date of the selected item.
3. Tap the new date.

## Entering receipt details

Expense provides a variety of options that you can associate with an item.

**To open the Receipt Details dialog box:**

1. Tap the Expense item to which you want to assign details.
2. Tap Details.



3. Select any of the following options:

- Category** Opens a pick list of system and user-defined categories. See [“Categorizing records”](#) in [Chapter 4](#) for more information.
- Type** Opens a pick list of expense types.
- Payment** Enables you to choose the payment method for the Expense item. If the item is prepaid (such as airline tickets supplied by your company), you can choose Prepaid to place your expense in the appropriate company-paid cell of your printed expense report.
- Currency** Enables you to choose the type of currency used to pay the Expense item. The default currency unit is defined in the Preferences dialog box. You can also display up to four other common types of currency. See [“Customizing the Currency pick list”](#) later in this chapter for more information.
- Vendor and City** Enables you to record the name of the vendor (usually a company) associated with the expense and the city where the expense was incurred. For example, a business lunch might be at Rosie’s Cafe in San Francisco.
- Attendees** Lookup displays the names in your Contacts that have data In the company field, you can add these names to a list of attendees associated with an expense record.

4. Tap OK.

## Customizing the Currency pick list

You can select the currencies and symbols that appear in the Currency pick list.

To customize the Currency pick list:

1. Tap the Currency pick list in the Receipt Details dialog box, and then select Edit currencies.

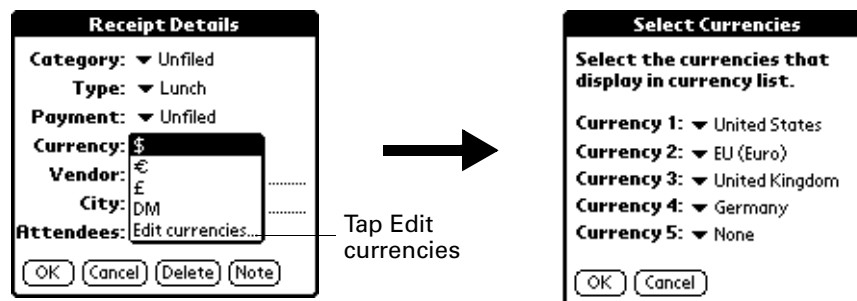

2. Tap each Currency pick list and select the country whose currency you want to display on that line.

3. Tap OK to close the Select Currencies dialog box.
4. Tap OK.

## Changing the default currency

You can select which currency appears by default when you're entering Expense items.

**To change your default currency:**

1. Open Expense.
2. Tap the Menu icon .
3. Select Options, and then select Preferences.
4. Tap the Default Currency pick list.
5. Tap the currency symbol that you want to appear in Expense.
6. Tap OK.

## Defining a custom currency symbol

If the currency you want to use is not in the list of countries, you can create your own custom country and currency symbol.

**To define a custom currency symbol:**

1. Tap the Menu icon .
2. Select Options, and then select Custom Currencies.
3. Tap one of the four Country boxes.
4. Enter the name of the country and the symbol that you want to appear in Expense.
5. Tap OK to close the Currency Properties dialog box.
6. Tap OK.

## Setting Show Options

Show Options defines the sort order and other settings that relate to your Expense items.

To open the Show Options dialog box:

1. In the Expense list, tap Show.
2. Select any of the options.

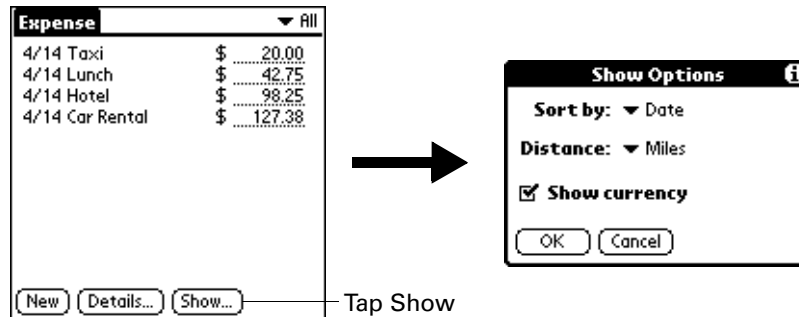

- Sort by** Enables you to sort expense items by date or type.
- Distance** Enables you to display Mileage entries in miles or kilometers.
- Show currency** Shows or hides the currency symbol in the Expense list.

3. Tap OK.

## Working with Expense data on your computer

After you enter your expenses into the Expense application on your handheld and you perform a HotSync® operation, Palm™ Desktop software enables you to do any of the following on your Windows computer. See the Palm Desktop software online help for details. This feature is not available on Mac computers.

- Add, modify, and delete your Expense data.
- Organize your Expense data by category, amount, date, type, or notes.
- View Expense data in various formats: List, Large Icons, or Small Icons.
- Record individual expenses in various currencies and display the total in one selected currency type.
- Print Expense reports.
- Transfer Expense data to other applications, such as Microsoft Excel, using the Send command or Export command, and import data in popular file formats.

## Setting the automatic fill preference

Automatic fill enables you to select an expense type by writing the first letter of an expense type. For example, if you write the letter *T*, it enters the “Taxi” expense type. Writing *T* and then *E* enters “Telephone,” which is the first expense type beginning with the letters *TE*.

To set automatic fill:

1. Tap the Menu icon .
2. Select Options, and then select Preferences.
3. Tap the checkbox to select or deselect automatic fill.

# Using Memos

 Memos provides you with a place to take notes that are not associated with records in Calendar, Contacts, or Tasks. The number of memos you can store depends only on the memory available on your handheld.

**NOTE** Certain tasks are common among several handheld applications. For more information, see [Chapter 4, “Working with Applications.”](#)

To open Memos:

1. Tap the Home icon .
2. Select the Memos icon .

## Creating memos

This section describes how to create a memo. Each memo you create can be up to approximately 32KB in size.

To create a new memo:

1. Open Memos.
2. Tap New.

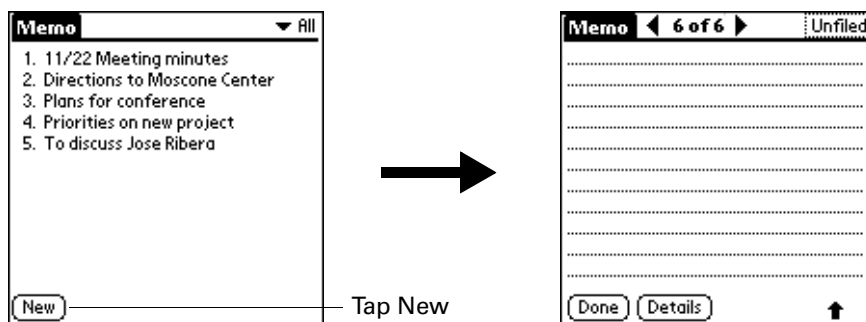

**TIP** In the Memo list screen, you can also begin writing in the input area to create a new memo. The first letter is automatically capitalized and begins your new memo.

3. Enter the text you want to appear in the memo. Use the carriage return stroke to move down to new lines in the memo.
4. Tap Done.

## Reviewing memos

The first line of a memo appears in the Memo list. This makes it easy to locate and review your memos.

To review a memo:

1. From the Memo list, select the text of the memo.



**TIP** You can also select, review, and move between memos with the navigator. See “Using the navigator” in Chapter 2 for details.

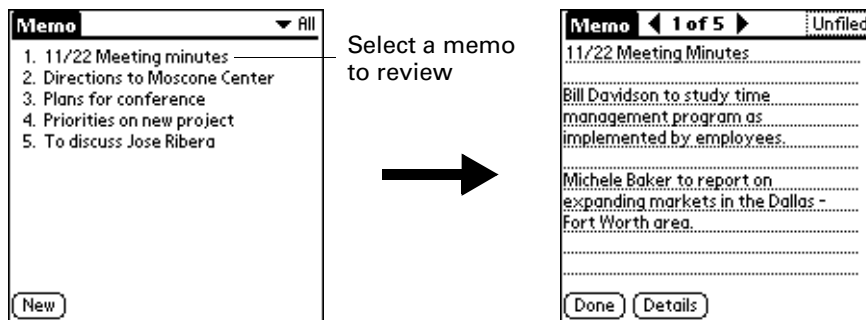

2. Review or edit the text in the memo, and then tap Done.

## Using Memos menus

Memos menu commands that are not explained elsewhere in this book are described here. See “Using menus” in Chapter 4 for information about selecting menu commands.

The Record and Options menus differ depending on whether you’re displaying the Memo list or an individual memo.

### Record menus

- |                      |  |
|----------------------|--|
| <b>Send Category</b> | Opens a dialog box where you can choose how you want to send all records in the selected category to another device. |
| <b>Send Memo</b>     | Opens a dialog box where you can choose how you want to send the selected memo to another device.                    |

### Options menus

- |                    |  |
|--------------------|--|
| <b>Preferences</b> | Displays the Memo Preferences dialog box, where you define the sort order for memos. |
| <b>About Memos</b> | Shows version information for Memos.   |

# Using Note Pad

 Note Pad provides a place to take notes in your own handwriting. You can use Note Pad to do everything you might do with a piece of paper and a pencil.

**NOTE** Certain tasks are common among several handheld applications. For more information, see [Chapter 4, "Working with Applications."](#)

### To open Note Pad:

- Press the Note Pad application button on the front panel of your handheld. Note Pad opens to display the list of all your records.

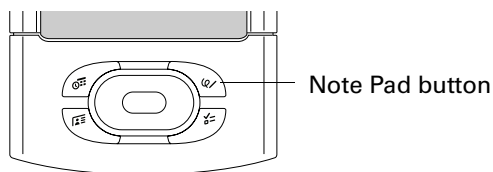

**TIP** Press the Note Pad application button repeatedly to cycle through the categories in which you have records.

## Creating a note

A record in Note Pad is called a *note*. You can assign notes to categories and mark them private as described in [Chapter 4](#). This section covers how to create a note.

### To create a new note:

1. Tap New.

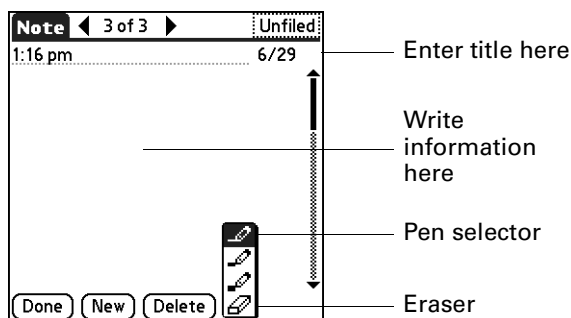

2. Write the information directly on the handheld screen.  
Tap the pen selector to select a different pen width, or select the eraser to remove unwanted strokes.
3. (Optional) Select the time at the top of the screen, and then enter a title using Graffiti® 2 writing.
4. Tap Done.

To clear the screen:

1. Tap the Menu icon .
2. Select Edit, and then select Clear Note.

## Reviewing notes

The note title and the date you created the note appear in the Note Pad list. If you did not assign a title to your note, the time you created the note appears as the note title. This makes it easy to locate and review your notes.

To review a note:

1. In the Note Pad list, select the note title.



**TIP** You can also select, review, and move between notes with the navigator. See [“Using the navigator”](#) in [Chapter 2](#) for details.

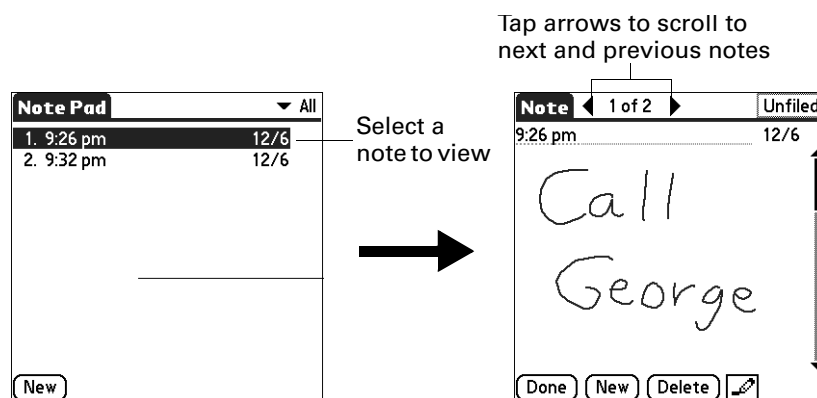

2. Review or edit the contents of the note.
3. Tap Done.

## Changing Note Pad color settings

By default, your notes appear with a white “paper” background, and the ink from the pen is blue. You can change the color of both the paper and the ink from the pen. Your color selections apply to all your notes. You cannot change the color settings for individual notes.



**To set the colors:**

1. In the Note Pad list, tap the Menu icon .
2. Select Options, and then select Preferences.
3. Tap Color.
4. Tap Pen, and then tap the color of ink you want to use.
5. Tap Paper, and then tap the color of paper you want to use.
6. Tap OK.

## Setting an alarm for a note

You can set an alarm for a specific time and date to remind you to follow up on a note.

**To set an alarm for a note:**

1. Tap the note to which you want to assign an alarm.
2. Tap the Menu icon .
3. Select Options, and then select Alarm.
4. Tap the Date box.
5. Tap the year, month, and date you want the alarm to sound.  
After you tap the date, the Set Alarm dialog box reappears.
6. Tap the Time box.
7. Tap the hour and minute columns to select the time you want the alarm to occur.
8. Tap OK.
9. When the alarm goes off and the reminder message appears onscreen, do one of the following:
  - Tap OK to permanently dismiss the reminder and return to the current screen.
  - Tap Snooze to dismiss the reminder and return to the current screen. An attention indicator blinks in the upper-left corner of the screen to remind you of the pending alarm, and the reminder message appears again in five minutes. When the reminder message reappears, the current time appears in the Reminder bar and the note title appears on the screen.
  - If you did not title the note, the time the note was created appears on the screen.
  - Tap Go To to open Note Pad. Note Pad will open and display the note associated with the alarm.

## Using Note Pad menus

Note Pad features that are not explained elsewhere in this book are described here. See “Using menus” in [Chapter 4](#) for information about selecting menu commands.

### Record menu

The Record menu is the same when you’re viewing the Note Pad list and an individual note.

- Send Category** Opens a dialog box where you can choose how you want to send all records in the selected category to another device. The options available depend on the software installed on your handheld.
- Send Note** Opens a dialog box where you can choose how you want to send the selected note to another device. The options available depend on the software installed on your handheld.
- Compatibility** Displays the Compatibility dialog box, where you can choose to beam notes to a previous version of Note Pad.

### Options menus

The Options menu differs depending on whether you’re viewing the Note Pad list or an individual note.

- Preferences** Displays the Note Pad Preferences dialog box, where you define the pen and paper color, the sort order for notes, and the alarm sound.
- Details** Displays the Note Details dialog box, where you assign a category and privacy option for a note.
- About Note Pad** Shows version information for Note Pad.

# Using Phone Link



Phone Link helps you configure a connection between your handheld and a compatible mobile phone. You can connect to a compatible mobile phone using any of the following methods:

- **Bluetooth™ technology:** A wireless link that enables you to connect to a Bluetooth mobile phone that is within 10 meters (approximately 30 feet) of your handheld. See [“Bluetooth Preferences”](#) in [Chapter 21](#) for additional information on Bluetooth technology.
- **Infrared communication:** A wireless link that enables you to connect to an infrared-enabled mobile phone within 1 meter (approximately 39 inches) of your handheld. The infrared ports on the two devices must be aligned and the path between the two devices must be clear of obstacles. See [“Beaming data”](#) in [Chapter 3](#) for more information about your handheld’s infrared capabilities.
- **A serial cable connection:** A wire-based link that connects your handheld to a mobile phone with a physical cable.

Serial cables and mobile phones that are enabled with infrared or Bluetooth technology are sold separately.

## What can you do with a phone connection?

When your handheld is linked to a mobile phone and your mobile phone carrier supports the required services, you can do the following:

- **Access the Internet:** Use a high-speed wireless data service—such as General Packet Radio Service (GPRS)—or data services and an Internet service provider (ISP) dial-up account, to access the Internet and browse the web. See [Chapter 18](#) for more information.
- **Check and send e-mail:** Use a high-speed wireless data service, or data services and a dial-up connection, to access your POP3 or IMAP e-mail account. See [Chapter 16](#) for more information.
- **Dial telephone numbers from your Contacts:** Use the Quick Connect and Tap-to-Connect features with a Global System of Mobile Communications (GSM) mobile phone to dial directly from your Contacts. See [“Making connections from Contacts”](#) in [Chapter 7](#) for details.



- **Exchange SMS messages:** Use a GSM phone carrier service to send and receive short text messages. See [Chapter 14](#) for more information.
- **Use Palm™ Dialer to dial numbers on your phone:** You can use the phone keypad displayed on your handheld to dial numbers on your GSM mobile phone. See [Chapter 8](#) for more information.

A GSM mobile phone, GSM network service, data service, high-speed wireless data service, and an ISP account with a dial-up connection are not included with your handheld.

## Setting up a phone connection

The instructions in this section assume that you have already installed the desktop software that came with your handheld and that you have performed at least one HotSync® operation.

**To configure a phone connection on your handheld:**

1. If you are establishing a Bluetooth connection with a phone, you must first turn on Bluetooth communication and turn on the Discoverable setting on your handheld. See “[Bluetooth Preferences](#)” in [Chapter 21](#) for instructions.
2. Tap the Home icon .
3. Select the Phone Link icon .
4. Tap the Phone Connection box.

The Connection Setup screen appears.

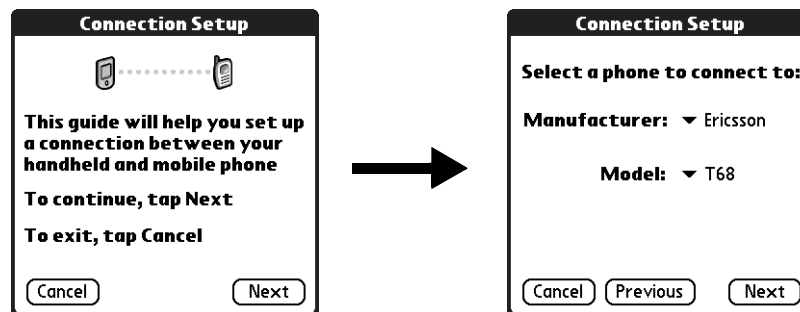

5. Tap the Manufacturer pick list and select your phone’s manufacturer.

6. Tap the Model pick list and select your phone model.

If your phone model does not appear on the list, either you need to download and install a driver for your phone (see [“Updating the phone files on your handheld”](#) later in this chapter) or your phone is not supported at this time.

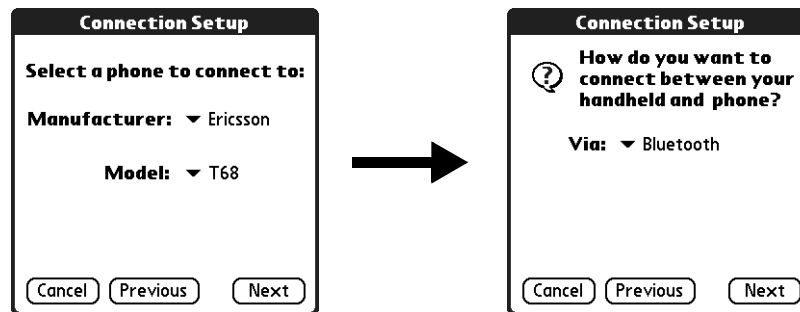

7. Tap Next.
8. Tap the Via pick list and select the method you want to use to connect: Bluetooth, Infrared, or Cable.  
The Via pick list options vary based on the phone model.
9. Tap Next.
10. If you selected Infrared or Cable in step 8, skip to [“Configuring network service settings for your phone”](#) later in this chapter. If you selected Bluetooth in step 8, complete the steps in the procedure that follows.

**To configure Bluetooth settings for your phone connection:**

1. For details, place your phone into the mode where it can accept Bluetooth pairing from another device. See the documentation that came with your phone.
2. Wait for your handheld to discover your phone.

When your handheld discovers a Bluetooth phone, it displays a screen similar to the screen that follows.

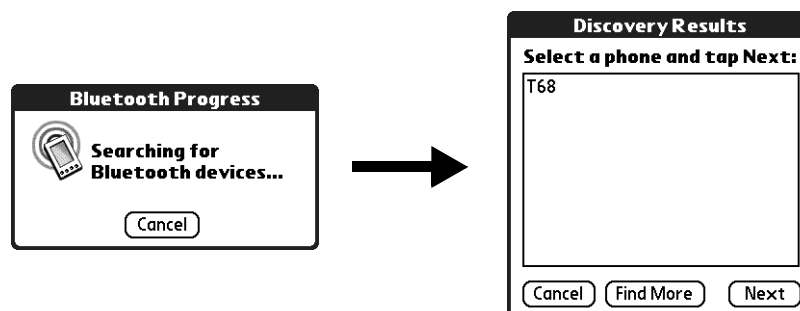

3. Select your phone from the list.

If your phone doesn't appear on the list, tap Find More, and select your phone's name when it appears on the list.

4. Tap Next.

Your handheld connects to your phone.

5. When prompted to create a trusted connection, tap Next.

6. Enter a passkey for this connection on your phone, and then tap OK.

A passkey is a unique identifier that enables secure data exchange between two Bluetooth devices that have formed a connection with each another. The passkey is stored on both devices and you must enter the same passkey on both your handheld and phone. If Phone Link is unable to validate the same passkey on both your handheld and your phone, an error message appears and you are given the option to try connecting again. If you need additional information about connecting your phone, refer to the *Phone Pairing Handbook* at [www.palm.com/support](http://www.palm.com/support).

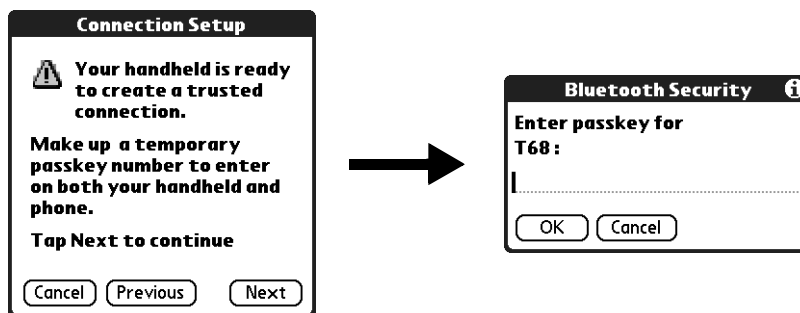

7. When prompted to create a trusted connection, tap Next.

8. Enter a passkey for this connection on your handheld, and then tap OK.

- When the Confirmation dialog box appears, tap Yes.

---

**IMPORTANT** If you tap No in the Confirmation dialog box, the link between your phone and handheld will not work.

---

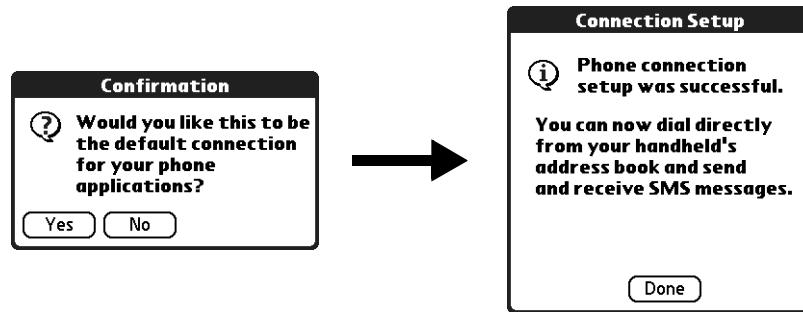

- Tap Done.

The Network Service dialog box appears.



- Tap Yes, and then follow the instructions in the next section to set up network services for your phone.

## Configuring network service settings for your phone

If you want to use your handheld to connect to the Internet and to send and receive e-mail, you must configure network service settings for your phone.

**To configure a GPRS high-speed wireless data service connection for your phone:**

- After tapping Yes in step 11 of the preceding procedure, tap Next on the Network Service Setup screen.

If you do not see the Network Service Setup screen, tap the Home icon , select the Phone Link icon , and then tap the Network Service box.

- Tap Yes when asked if you subscribe to a high-speed data service.
- Tap Next.
- Tap the Select the area... pick list and select your mobile phone carrier's location.

5. Tap the Select your carrier pick list and select your mobile phone carrier.

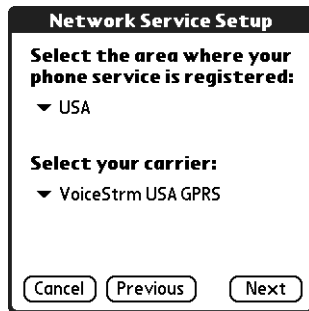

If your mobile phone carrier does not appear on the list, either you need to download and install the settings for your mobile phone carrier (see [“Updating the phone files on your handheld”](#) later in this chapter) or your carrier is not supported at this time.

6. Tap Next.
7. Tap Done.

#### To configure a dial-up connection:

1. After tapping Yes in step 11 of the [“To configure Bluetooth settings for your phone connection:”](#) procedure, tap Next on the Network Service Setup screen.

If you do not see the Network Service Setup screen, tap the Home icon , select the Phone Link icon , and then tap the Network Service box.

2. Tap No when asked if you subscribe to a high-speed data service.
3. Tap Next.

A screen appears informing you that you are about to set up a dial-up connection for your ISP.

4. Tap Next.
5. Tap the Phone # field and enter the phone number you use to connect to your ISP.

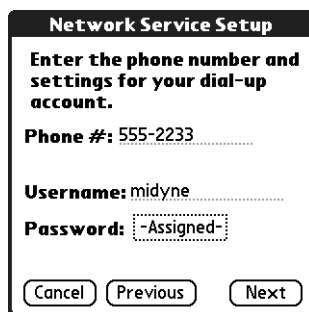

6. Tap the Username field and enter the name you use when you log in to your ISP account.



7. Tap the Password box and enter the password for your ISP account.
8. Tap Next.
9. Tap Done.

## Updating the phone files on your handheld

The Phone Link Updater application on your computer guides you through the process of updating the telephony files on your handheld.

The instructions in this section assume that you have already installed the desktop software that came with your handheld and that you have performed at least one HotSync operation. You also need Internet access to download the most recent phone files during the installation.

### To update the phone files from your Windows computer:

1. If you are establishing a Bluetooth connection with a phone, you must first turn on Bluetooth communication and turn on the Discoverable setting on your handheld. See “Bluetooth Preferences” in [Chapter 21](#) for instructions.
2. From the Windows Start menu, select Programs, select Palm Desktop, and then click Phone Link Updater.
3. Follow the instructions on the screen and click Next and Back to navigate between the screens as you do the following:
  - a. Select your phone’s manufacturer and model.

If your phone is not listed, you cannot create a connection to your phone at this time; try running Phone Link Updater again at a later date to see if a new driver is available.
  - b. Download phone driver updates from the Internet.
  - c. Select the region where you are located.
  - d. Select your mobile phone carrier service.
  - e. Select your handheld’s username.
4. After prompted, perform a HotSync operation.

After the HotSync operation is complete, the phone files are installed on your handheld.
5. Click Finish.

If you need additional information about connecting your phone, refer to the *Phone Pairing Handbook for Palm™ Tungsten™ T Handhelds* at [www.palm.com/support](http://www.palm.com/support).

**To update the phone files from your Mac computer:**

1. If you are establishing a Bluetooth connection with a phone, you must first turn on Bluetooth communication and turn on the Discoverable setting on your handheld. See “Bluetooth Preferences” in Chapter 21 for instructions.
2. Download the correct driver for your phone from [www.palm.com/support](http://www.palm.com/support).
3. Install the phone driver as you would install any other add-on application. See “Installing files and add-on applications” in Chapter 4 for details.
4. Perform a HotSync operation.

If you need additional information about connecting your phone, refer to the *Phone Pairing Handbook for Palm™ Tungsten™ T Handhelds* at [www.palm.com/support](http://www.palm.com/support).

## Using phone connections

After you update the phone files and configure a link between your handheld and your phone, you are ready to make connections. Depending on the type of link you configured (infrared, cable, or Bluetooth), refer to the appropriate set of instructions in this section.

By default, your handheld disconnects automatically when the connection is inactive for one minute.

If you used the Network Preferences screen to set up multiple network service profiles, you can choose a different service when you establish a connection. See “Network Preferences” in Chapter 21 for information on setting up multiple network service profiles.

**To make an infrared connection:**

1. Turn on your handheld and your mobile phone.
2. Activate the infrared port on your phone.
3. Align the infrared port on your handheld with the infrared port on your phone.
4. Launch the application that requires the phone connection.

For example, to access the Internet, launch a web browser application.

**To make a cable connection:**

1. Connect the cable to your handheld and mobile phone.
2. Turn on your handheld and your mobile phone.
3. Launch the application that requires the phone connection.

For example, to access the Internet, launch a web browser application.

**To make a Bluetooth connection:**

1. Turn on your handheld and your mobile phone.
2. Activate Bluetooth on your handheld and phone.
3. Make sure your phone is within 10 meters (approximately 30 feet) of your handheld.
4. Launch the application that requires the phone connection.

For example, to access the Internet, launch Palm™ Web Browser Pro.



# Using Palm™ Photos



Palm™ Photos enables you to view, manage, and share photos on your handheld or on an expansion card. Use Palm Photos to locate, organize, and play a slide show of your photos, as well as exchange photos with other applications and devices.

**NOTE** Certain tasks are common among several handheld applications. For more information, see [Chapter 4, “Working with Applications.”](#)

**To open Palm Photos:**

1. Tap the Home icon .
2. Tap the Photos icon .

## Viewing photos

You can use Palm Photos to transfer photos from your computer or receive photos beamed from another device, and then view the photos on your handheld. You can also view photos from an expansion card inserted into your handheld.

You can view the following types of photos:

- JPG files
- BMP files
- TIFF files
- GIF files

## Viewing photos in Thumbnail view

Thumbnail view displays miniature versions of your photos so that you can see several photos on the screen at the same time. Use this view to browse through photos or to locate a photo when you don't know the name of the photo.

To view photos in Thumbnail view:

1. Tap the Thumbnail icon .

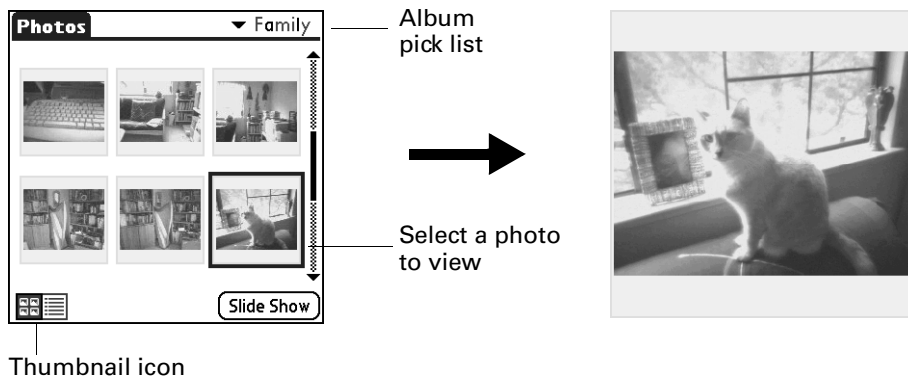

2. Tap the Album pick list in the upper-right corner, and then select the album you want to view.
3. Tap the thumbnail of the photo you want to view.



**TIP** You can also select a photo with the navigator. Press Select on the navigator to insert the highlight, press Up, Down, Right, or Left to highlight a specific photo, and then press Select to view the photo.

4. Tap anywhere on the screen to return to Thumbnail view.

## Viewing photos in List view

List view displays a list of your photos so that you can see the names and dates associated with your photos. Use this view to locate a photo when you know the name or the date the photo was created.

**To view photos in List view:**

1. Tap the List icon .

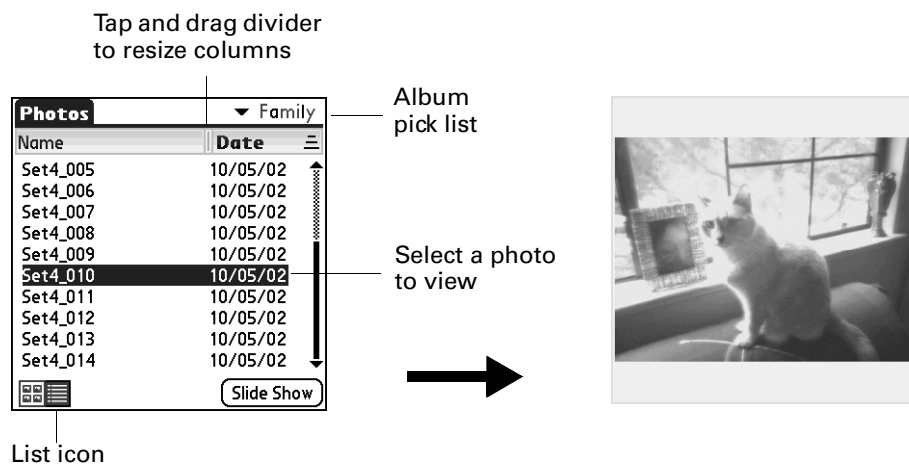

2. Tap the Album pick list in the upper-right corner, and then select the album you want to view.
3. Tap the name of the photo you want to view.
4. Tap anywhere on the screen to return to List view.

**Sorting photos in List view**

In List view, you can sort photos in ascending or descending order by name or date.

**To sort photos in List view:**

1. Tap a column heading to sort the photos based on that item.

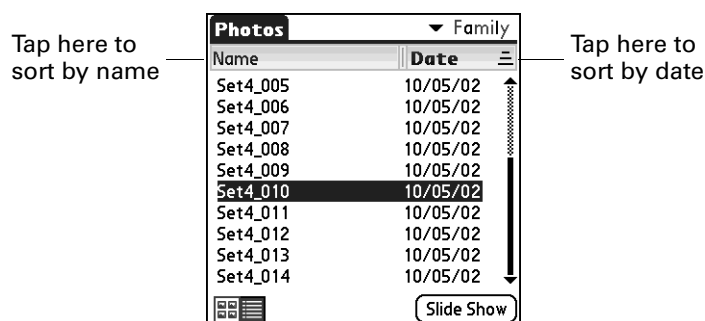

2. Tap the column heading to sort the photos in reverse order.

## Viewing a slide show

A slide show is a sequential presentation of each of the photos in the current album.

**NOTE** The status bar does not display during a slide show.

To view a slide show:

1. Tap the Album pick list in the upper-right corner, and then select the album you want to view.
2. Tap Slide Show.

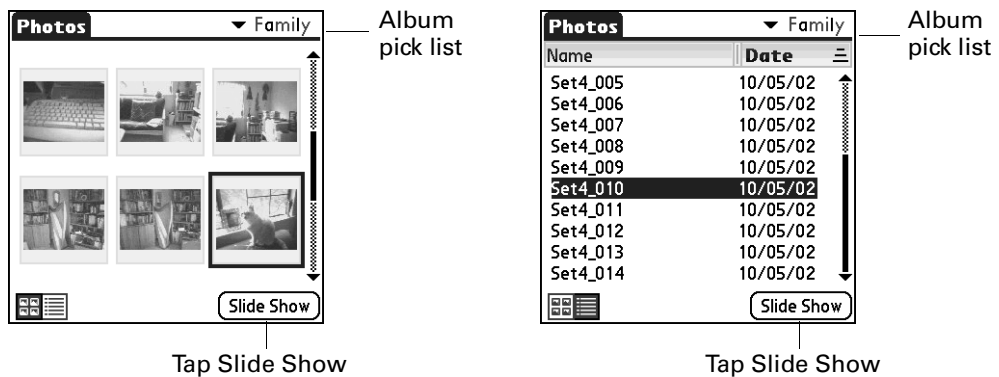

To adjust the delay between photos during a slide show:

1. Tap the Menu icon .
2. Select Options, and then select Preferences.



3. Tap the pick list, and then select the delay interval: 1 second, 2 seconds, 3 seconds, 5 seconds, or 1 minute.
4. Tap OK.



## Rotating photos

If a photo appears in the wrong orientation, you can rotate the photo.

To rotate a photo:

1. Tap the Menu icon .
2. Select Photo, and then select Rotate.

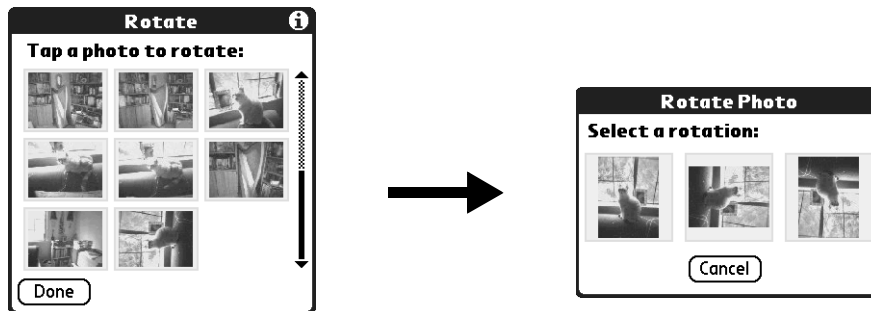

3. Tap the photo you want to rotate.
4. Select the new orientation, and then tap Done.

## Viewing photo information

The Photo Details dialog box enables you to view information about a photo and to change the photo name, assign it to an album, add a note about the photo, and delete a photo.

To review photo information:

1. Tap the Menu icon .
2. Select Photo, and then select Details.

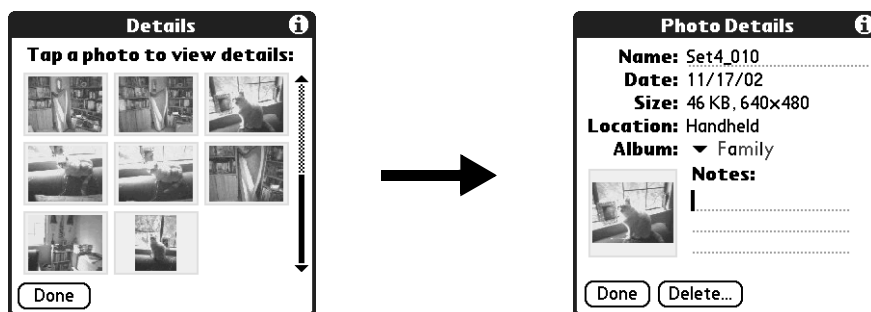

3. Tap the photo for which you want to view information.
4. Review or edit the information, and then tap Done twice.



**TIP** You can press Right or Left on the navigator to change photo information.

## Creating an album

The process for creating a new photo album is identical to the process for creating a new category in your other handheld applications.

To create an album:

1. Tap the Album pick list in the upper-right corner.
2. Select Edit Albums.

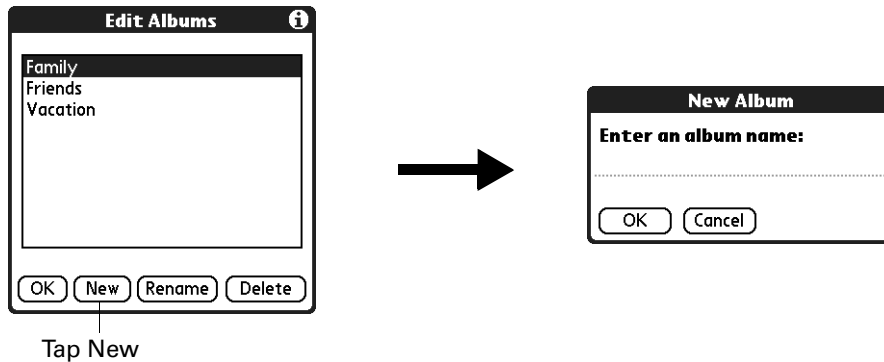

3. Tap New.
4. Enter a title for the album.
5. Tap OK, and then tap Done.

## Filing photos in albums

You can organize the photos on your handheld by filing them into different albums. You cannot file photos stored on an expansion card in albums.

To file photos in albums:

1. Tap the Album pick list in the upper-right corner, and then select the album to which you want to add photos.

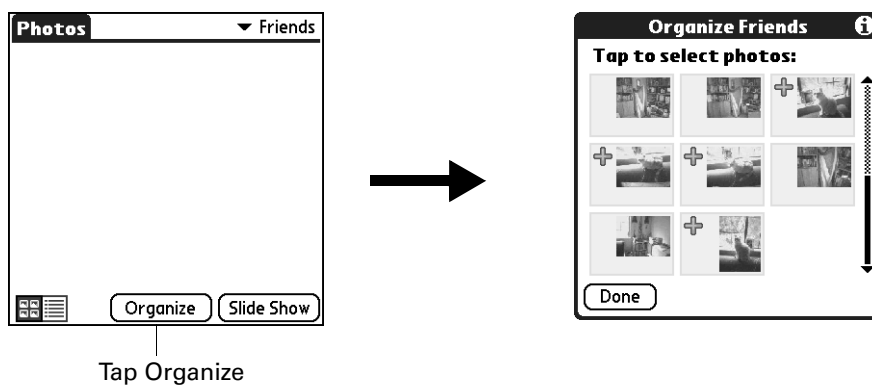

2. Tap Organize.  
Plus signs appear next to the photos that are part of the selected album.
3. Tap any photos you want to add to the current album.  
A plus sign appears next to each photo you select.  
**TIP** You can also tap and drag to select adjacent photos.
4. Tap any photos you want to remove from the current album.  
The plus signs next to the selected photos disappear.
5. Tap Done.

## Copying photos

The Copy command enables you to make a copy of a photo on your handheld or on an expansion card. When you copy a photo from an expansion card to your handheld, a number is appended to the photo name. If a photo was originally larger than the display area on your handheld (320 x 320 pixels or 320 x 480 pixels), then the photo is scaled to fit within the display area, and the aspect ratio is maintained.

To copy photos:

1. Tap the Menu icon .
2. Select Photo, and then select Copy.
3. Tap the photo(s) you want to copy.  
A plus sign appears next to the photo(s) you select.



**TIP** You can also select a photo with the navigator. Press Select on the navigator to insert the highlight, press Up, Down, Right, or Left to highlight a specific photo, and then press Select to view the photo.

4. Tap Copy.



Tap Copy

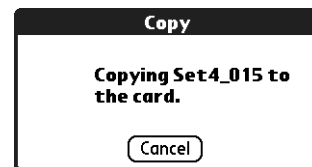

## Renaming or deleting an album

You can rename or delete any of the albums that you create. You cannot rename or delete the Unfiled album.

### To rename an album:

1. Tap the Album pick list in the upper-right corner.
2. Select Edit Albums.
3. Select the album you want to rename.
4. Tap Rename, and then enter the new name.
5. Tap OK, and then tap Done.

### To delete an album:

1. Tap the Album pick list in the upper-right corner.
2. Select Edit Albums.
3. Select the album you want to delete, and then tap Delete.
4. When the confirmation dialog box appears, tap Delete.
5. Tap Done.

## Beaming photos

The Beam command enables you to beam photos to other devices that are enabled with infrared (IR) technology. The receiving device must have an application that can display photos. For instructions on beaming a single photo, see “[Beaming data](#)” in [Chapter 3](#). Follow the steps below to beam multiple photos.

### To beam photos:

1. Tap the Menu icon .
2. Select Photo, and then select Beam.

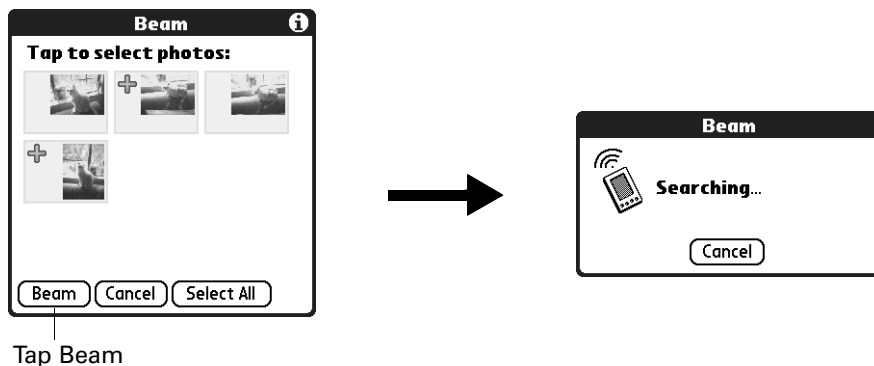

3. Tap the photos you want to beam.  
A plus sign appears next to the photos you select.
4. Tap Beam.
5. Point the IR port on your handheld at the IR port on the receiving device.  
See “Sending data” in Chapter 3 for additional information on beaming data.

## Deleting photos

If you no longer want a photo on your handheld or expansion card, you can delete the photo.

To delete photos:

1. Tap the Menu icon .
2. Select Photo, and then select Delete.

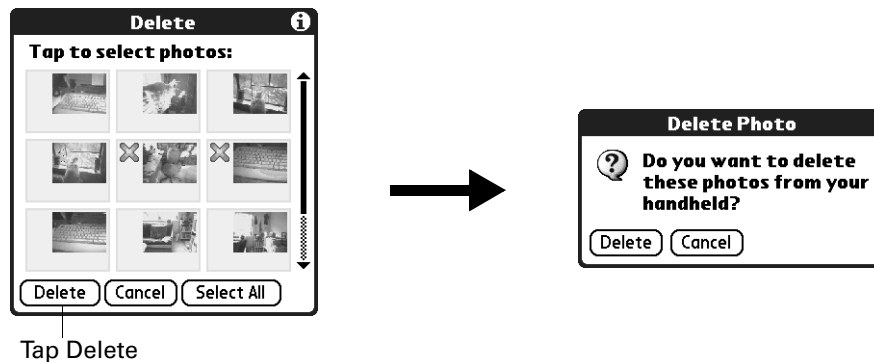

3. Tap the photo(s) you want to delete.  
An X appears next to the photo(s) you select.
4. Tap Delete.
5. When the confirmation dialog box appears, tap Delete.

## Working with photos on your computer

After you perform a HotSync® operation to synchronize photos from your handheld onto your Windows computer, Palm™ Desktop software enables you to do any of the following on your computer. See the Palm Desktop software online Help for details.

- View photos in various formats: List, Thumbnails, Details, and Editor with a Handheld preview.
- Drag photos onto the Palm Quick Install icon or the Palm Photos desktop window to install them on your handheld or on an expansion card during the next HotSync operation.

- Modify and delete your photos.
- Organize your photos and add notes.
- Transfer photos to other applications using the Send command or Export command, and import data in popular file formats.

For information on working with photos on your Mac computer, open the Palm folder, open the Documentation folder, and double-click the Photo and Audio Readme file.

## Using Palm Photos menus

Palm Photos menu commands that are not explained elsewhere in this book are described here. See [“Using menus”](#) in [Chapter 4](#) for information about selecting menu commands.

### Options menu

**About Photos** Shows version information for Palm Photos.

# Using SMS



SMS enables you to send and receive short text messages using your handheld and a Global System for Mobile Communications (GSM) phone. SMS allows you to receive records associated with other applications, such as Calendar events. You can add such records to the associated application or view the information as a text message.

---

**IMPORTANT** Your mobile phone plan must be a GSM phone and must enable you to send and receive SMS messages in order for you to use SMS.

---

**To open SMS:**

1. Tap the Home icon .
2. Tap the pick list in the upper-right corner of the screen.
3. Tap Main.
4. Tap the SMS icon .

## Configuring phone preferences and connecting to your mobile phone

You need to configure the phone preferences of your handheld and connect your handheld to your mobile phone before you use SMS. Whenever you send or receive messages in SMS, your handheld must be connected to your mobile phone.

For more information on configuring your phone preferences, see [Chapter 21](#). For more information on connecting your handheld to your mobile phone, see “[Setting up a phone connection](#)” in [Chapter 12](#).

## Using the navigator in SMS

You can use the navigator on your handheld to work in SMS.

### To navigate in SMS list screens:



- Press Up or Down on the navigator to scroll an entire screen of messages.
- Press and hold Up or Down to scroll quickly.
- Press Select to insert a highlight.
- When a message is highlighted, you use the navigator as follows:
  - Press Select again to view the selected message.
  - Press Up or Down to scroll to the previous or next message.
  - Press Left to remove the selection highlight.

### To navigate in message screens:

- Press Up or Down to scroll within the current message.
- Press Right or Left to scroll to the previous or next message.
- Press Select to return to the list screen.

## Creating messages

When you create a message, the title bar indicates the number of characters the message contains.

### To create a message:

1. From any SMS list view, tap New.
2. Tap To.

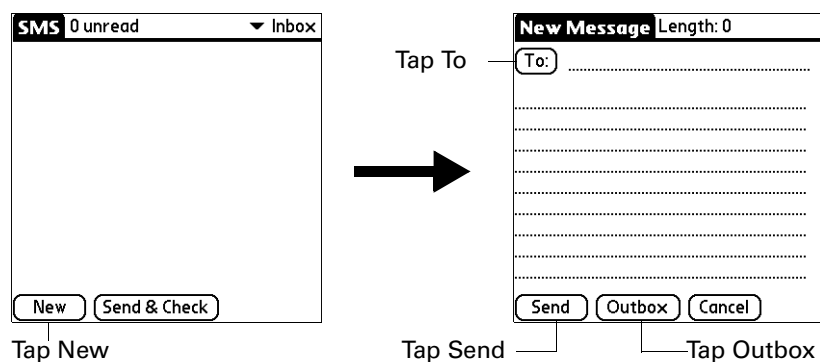



3. Tap the recipient's name, and then tap Add.

**TIP** To send a message to someone who isn't in your Contacts list, enter that person's mobile phone number on the To line.

4. Enter the message text.
5. Connect to your phone. See ["Setting up a phone connection"](#) in [Chapter 12](#).
6. Tap Send to send the message now, or tap Outbox to send the message later.

**NOTE** Tapping Send does not send any of the other messages in your Outbox. It sends only the current message.

## Sending and receiving messages

You can send all the messages in your Outbox and retrieve all the new messages from your mobile phone at the same time.

**To send and receive messages at the same time:**

1. Connect to your phone. See ["Setting up a phone connection"](#) in [Chapter 12](#).
2. From any SMS list view, tap Send & Check.

When the transmission finishes, a message appears, indicating the number of new messages you received.

**To send all messages in your Outbox:**

1. Connect to your phone. See ["Setting up a phone connection"](#) in [Chapter 12](#).
2. From any SMS list view, tap the Menu icon .
3. Tap Send from the Message menu.

**To download all messages from your phone:**

1. Connect to your phone. See ["Setting up a phone connection"](#) in [Chapter 12](#).
2. From any SMS list view, tap the Menu icon .
3. Tap Check from the Message menu.

## Viewing messages

SMS stores your messages in five categories:

- Inbox** Stores messages downloaded from your phone.
- Outbox** Stores messages waiting to be sent.
- Trash** Stores messages you deleted. You can restore deleted messages to their original category.
- Archive** Files messages you want to keep.
- Draft** Stores messages you want to change or review before you send them.

To view text messages in your Inbox:

1. Tap the category pick list in the upper-right corner.
2. Tap Inbox.

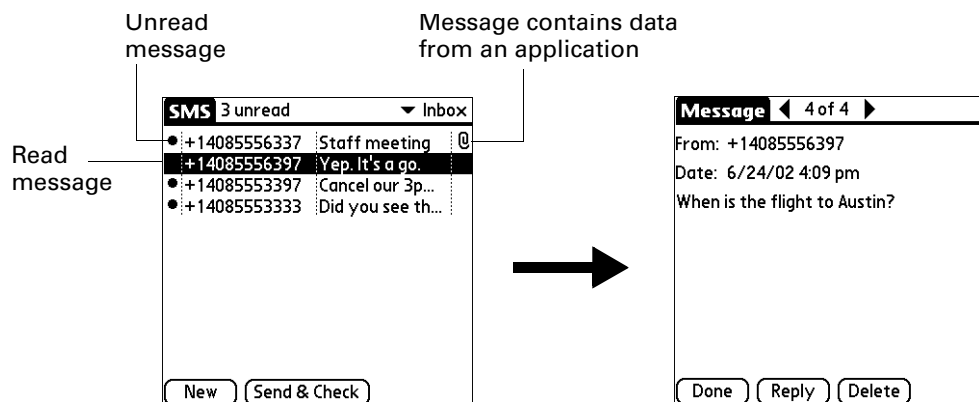

3. Tap the message you want to view.
4. Tap one of the following:

- Done** Returns to the list view.
- Reply** Creates a message to the sender and copies any selected text into the new message.
- Delete** Moves the message to the Trash category.

**To view data messages in your Inbox:**

1. Tap the category pick list in the upper-right corner.
2. Tap Inbox.

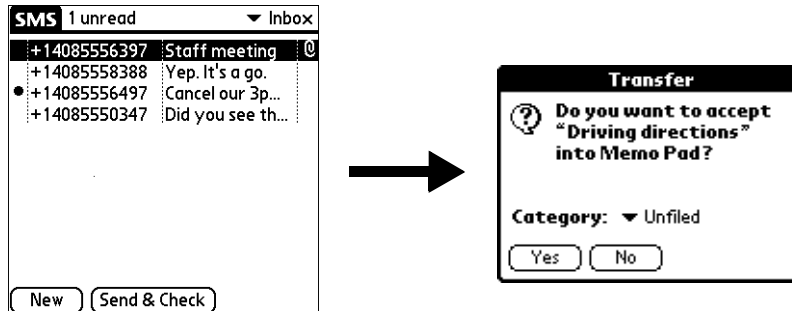

3. Tap the message you want to view.
4. Tap Yes to add the data to the appropriate application, or tap No to view the raw data.

## Working with draft messages

When you create a message, you can save it as a draft message.

**To place a message in the Draft category:**

1. Create or open the message you want to store in the Draft category.
2. From the Message view, tap the Menu icon .
3. Tap Draft from the Message menu.

**To view or edit draft messages:**

1. Tap the category pick list in the upper-right corner.
2. Tap Draft.
3. Tap the message you want to edit.
4. In the message view, tap Edit.

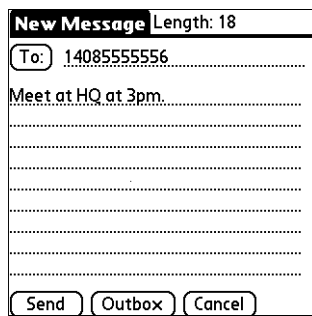

5. Edit the message.
6. Tap one of the following:

<b>Send</b>	Sends the message now.
<b>Outbox</b>	Moves the message to the Outbox to be sent later.
<b>Cancel</b>	Opens a dialog box that asks if you want to save the message in the Draft category. Tap Yes to keep your changes and return the message to the Draft category. Tap No to discard your changes and return the message to the Draft category.

## Adding a signature to a message

A signature is text that appears at the end of a message.

To define a signature:

1. Tap the Menu icon .
2. Tap Options, and then tap Preferences.

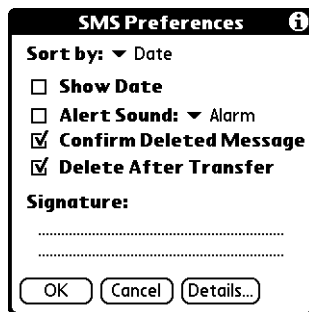

3. Enter your signature.
4. Tap OK.

To add your signature to a message:

1. Create or edit the message where you want to add your signature.
2. From the New or Edit Message view, tap the Menu icon .
3. Tap Options, and then tap Add signature.

## Sending data from another application

**NOTE** Not all applications include a send command.

To send data from another application:

1. Open the record you want to send.
2. Tap the Menu icon .
3. Tap Send from the Record menu. (The name of the menu may be different depending on which application you're sending data from. For example, tap Send from the Note menu in Note Pad.)
4. If necessary, tap SMS to send the data using SMS rather than Bluetooth™ technology, and then tap OK.

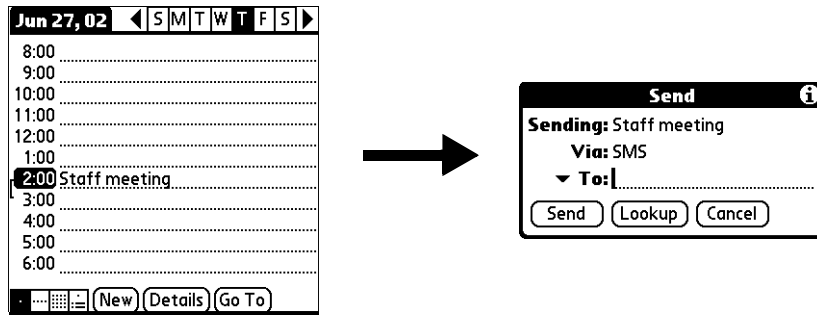

5. Tap To to select from a list of recent recipients, or tap Lookup to select a number from your contacts.
6. Tap Send.

## Setting SMS Preferences

The SMS Preferences screen enables you to customize several of the settings in the SMS application.

**To view or change SMS Preferences:**

1. Tap the Menu icon .
2. Tap Options, and then tap Preferences.

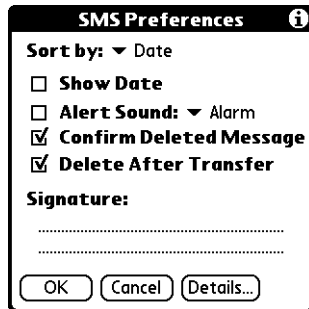

3. Change any of the following options:

**Sort by** Sorts messages in order of one of the following: Alphabetic, Date, Phone Number, and Status.

**Show Date** Displays dates in list views when this check box is selected.

**Alert Sound** Indicates whether new messages trigger an alert and which alert is triggered. To trigger a new message alert, select this check box. Tap the pick list to select one of the following sounds: Alarm, Alert, Bird, Concerto, Phone, Sci-fi, and Wake up.

**NOTE** When a new message triggers an alert sound, tap anywhere on your handheld screen to stop the sound.

**Confirm Deleted Message** Indicates whether a confirmation message appears each time you delete a message or you select the Empty Trash option from the Message menu. To display confirmation messages, select this check box.

**Delete After Transfer** Indicates whether data messages are deleted after you accept the data in the appropriate application. To keep data messages after you transfer them to the application, deselect this check box.

**Signature** Enables you to enter a personal signature that you can add to your messages.

## 4. Tap Details.

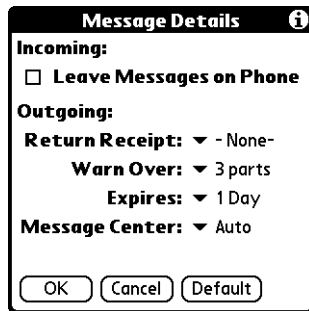

## 5. Change any of the following options:

**NOTE** Outgoing SMS message settings may depend on the service offered by your SMS carrier.

<b>Leave Messages on Phone</b>	Indicates whether messages are deleted from your phone after you download them to your handheld. To keep messages on your phone after you transfer them to your handheld, select this check box.
<b>Return Receipt</b>	Determines whether you receive receipt confirmation notices. To receive receipt confirmation notices, select Requested.
<b>Warn Over</b>	Determines whether you receive a warning when multipart messages exceed the specified number of parts. Select from the following options: 1 part, 3 parts, 5 parts, 10 parts, 50 parts, and Never warn.
<b>Expires</b>	Indicates how long unsent messages remain in your Outbox. Select from the following options: 4 Hours, 1 Day, 1 Week, 2 Weeks, 1 Month, and Max. Time.
<b>Message Center</b>	Indicates whether your handheld obtains your mobile phone service provider's Message Center number directly from the phone, or whether you need to enter the number manually. If your phone is already configured to use SMS, you do not need to change this setting.

**TIP** To restore all of these options to the original settings, tap Default.

## 6. Tap OK to close the Message Details dialog box.

## 7. Tap OK.

## Using SMS menus

SMS features that are not explained elsewhere are described here. See “Using menus” in [Chapter 4](#) for information about selecting menu commands.

### Message menu

- Send** Sends all messages in the Outbox.
- Check** Retrieves all messages stored on the phone.
- Empty Trash** Permanently removes all messages in the Trash category from your handheld.
- Archive** Moves the current message to the Archive category.

### Options menu

- Phone Lookup** Opens the Phone Lookup dialog box, in which you can select a mobile phone number where you want to send a message.
- Font** Opens the Font dialog box, in which you can choose separate fonts for the list and message views.



# Using Tasks

 Tasks is a convenient place to create reminders and prioritize the things you need to do. You can assign a priority level and due date to each task and sort your tasks by due date, priority level, or category.

**NOTE** Certain tasks are common among several handheld applications. For more information, see [Chapter 4, "Working with Applications."](#)

**To open Tasks:**

- Press the Tasks application button on the front panel of your handheld. Tasks opens to display the list of all your records.

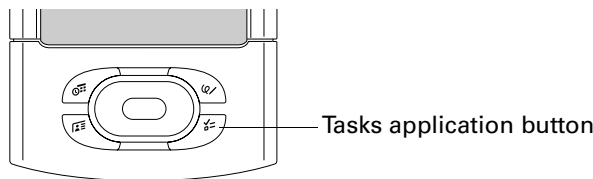

**TIP** Press the Tasks application button repeatedly to cycle through the Tasks list filters.

## Creating tasks

A task is a reminder of an item that you must complete.

**To create a task:**

1. Tap New.

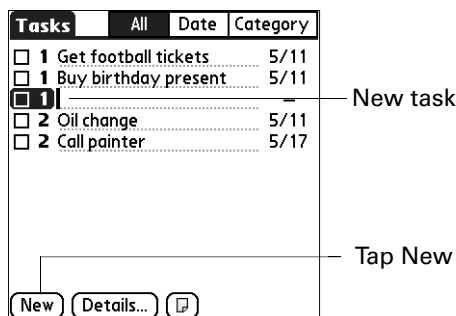

2. Enter the text of the task. The text can be longer than one line.
3. Tap anywhere onscreen to deselect the task.

**TIP** If no task is currently selected, write in the Graffiti® 2 input area to automatically create a new item.

## Setting priority

You can use the priority setting for items to arrange the tasks according to importance or urgency. The default setting for Tasks is to arrange items by due date and then priority, with priority 1 items at the top. If you have a number of items in your list, changing an item's priority setting may move its position in the list.

**To set the priority of a task:**

1. Tap the Priority number on the left side of the task.

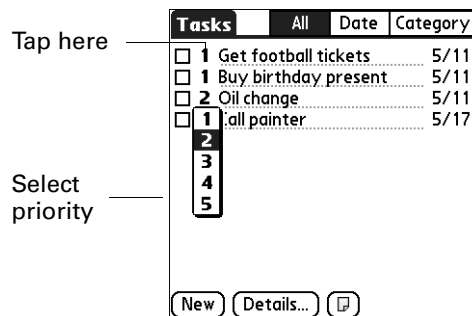

2. Select the Priority number that you want to set (1 is most important).

## Checking off a task

You can check off a task to indicate that you've completed it. You can set options to record the date that you complete the task, and you can show or hide completed items. See "Setting Tasks Preferences" later in this chapter.

**To check off a task:**

- Tap the check box on the left side of the item.

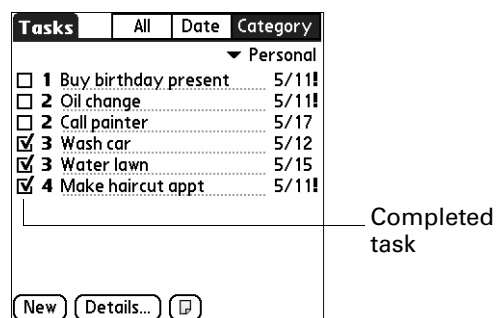

## Changing task details

The Tasks Details dialog box enables you to change settings for individual items.

**To display the Tasks Details dialog box:**

1. Tap the text of the item whose details you want to change.



**TIP** You can also select an item with the navigator. See [“Using the navigator”](#) in [Chapter 2](#) for details.

2. Tap Details.

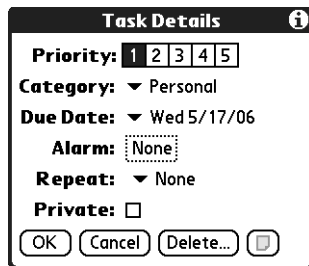

3. Change any of the settings.

**NOTE** To add a task to a category, see [“Categorizing records”](#) in [Chapter 4](#).

## Setting a due date

You can set a due date that displays with the task.

**To set a due date for a task:**

1. In the Details dialog box, tap the Due Date pick list.
2. Tap the date that you want to assign the item:
  - Choose date opens the date selector, where you can choose any date that you want for the item.
  - No Date removes the due date from the item.
3. Tap OK.

**TIP** If you turn on the Show Due Dates option in the Tasks Preferences dialog box, you can tap directly on the due date in the Tasks list to open the pick list shown in step 2.

## Setting an alarm

You can set an alarm before a task is due to remind you to start the task.

### To set an alarm for a task:

1. Select the task to which you want to assign an alarm.
2. Tap Details.
3. Tap the Alarm box. The Alarm box only appears if you have set a due date.  
The Set Alarm dialog box appears.
4. Tap the Alarm check box.
5. Select the 5, and then enter any number from 0 to 99 (inclusive) as the number of days.

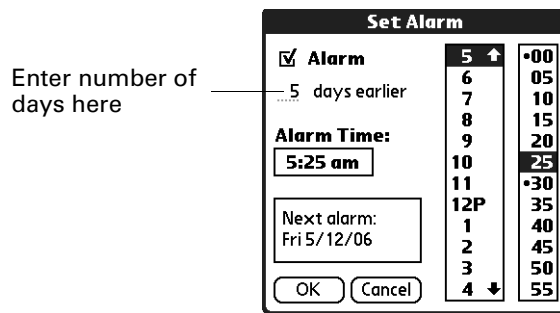

6. Enter or select the time.
7. Tap OK  
An alarm icon appears next to the task in the Tasks list.

## Scheduling repeating tasks

The repeat function enables you to schedule tasks that recur at fixed intervals or recur at regular intervals after a prior instance of the task has been completed.

### To schedule a repeating fixed-interval task:

1. Select the task.
2. Tap Details.
3. Tap the Repeat pick list.

4. Perform one of the following:
  - Select a fixed interval from the pick list and tap OK.
  - Select Daily until. Use the date picker to select an end date and tap OK.
  - Select Other to open the Change Repeat dialog box and go to step 5.



5. Tap Day, Week, Month, or Year to set how often the task repeats.
6. Tap Fixed Schedule.
7. On the Every line, enter a number that corresponds to how often you want the task to repeat.
 

For example, if you select Month and enter 2, the task repeats every other month.
8. To specify an end date for the repeating task, tap the End on pick list, and then tap Choose Date. Use the date picker to select an end date.
9. If you selected Week or Month, perform one of the following:
  - If you selected Week, tap on the day of the week to repeat the task on.
  - If you selected Month, select the day of the week or day of the month to repeat the task on.
10. Tap OK.

After you schedule a repeating or continuous task, the Repeat icon  appears next to the task in the Tasks list.

**To schedule a task that repeats at fixed intervals after a prior instance of the task is completed:**

1. Select the task.
2. Tap Details.
3. Tap the Repeat pick list.

- Select Other to open the Change Repeat dialog box.

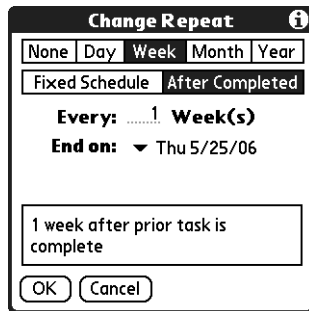

- Tap Day, Week, Month, or Year to set how often the task repeats.
- Tap After Completed.
- On the Every line, enter a number that corresponds to how often you want the task to repeat.  
For example, if you select Day and enter 2, the task repeats every other day after the prior instance of the task is completed.
- To specify an end date, tap the End on pick list, and then tap Choose Date. Use the date picker to select an end date.
- Tap OK.

After you schedule a repeating task, the Repeat icon  appears next to the task in the Tasks list.

## Display options

You can choose what tasks you want to view and how the tasks are sorted by choosing a display filter and setting Tasks Preferences.

### Using the display filters

You can choose to view alternate views of your task list by using the filtering option buttons. The three main options include All, Date, and Category.

---

**IMPORTANT** The sort order and types of tasks displayed, such as showing completed or due tasks, is set in the Preferences menu. For more information, see [“Setting Tasks Preferences”](#) in the next section.

---

To use the display filters:

1. Tap filter button.
2. Tap the filter pick list and select the filter type.

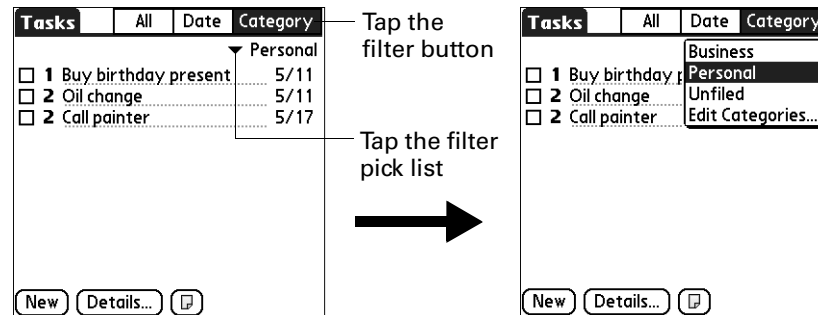

#### All

Displays a list of all tasks.

#### Date

When Date is selected, the Date filter pick list appears in the upper-right corner below the title bar. Select from the following date filters.

- **Due Today:** Lists all tasks due today.
- **Last 7 Days:** Displays a list of all tasks that were due in the 7 days including today.
- **Next 7 Days:** Displays all tasks that are due in the next days.
- **Past Due:** Displays all past-due-date incomplete tasks.

#### Category

When Category is selected, the Category pick list displays in the upper-right corner below the title bar. Select a category from the list to display all tasks within the selected category.

## Setting Tasks Preferences

The Tasks Preferences dialog box enables you to control the which tasks are displayed and how they are sorted. These settings also affect task items displayed in Calendar Agenda view. See [“Working in Agenda View”](#) in [Chapter 5](#).

You can also set alarm sounds for tasks in the Preferences dialog box.

To change Preferences settings:

1. Tap the Menu icon .
2. Select Preferences from the Options menu.

3. Select any of the following settings:

- |                               |   |
|-------------------------------|---|
| <b>Sort by</b>                | Tap the pick list to select the order the tasks display in the Tasks list.  |
| <b>Show Completed Tasks</b>   | <p>Displays your completed tasks in the Tasks list. If you turn off this setting, your tasks disappear from the list when you complete (check) them.</p> <p>Items that no longer appear on the list because you turn off this setting have not been deleted. They are still in the memory of your handheld. You can purge completed items to remove them from memory.</p> |
| <b>Record Completion Date</b> | Replaces the due date with the actual date when you complete (check) the task. If you do not assign a due date to a task, the completion date still records when you complete the task.   |
| <b>Show Due Dates</b>         | Displays the due dates associated with tasks in the list and displays an exclamation mark next to tasks that remain incomplete after the due date passes.   |
| <b>Show Priorities</b>        | Shows the priority setting for each task.   |
| <b>Show Categories</b>        | Shows the category for each task.   |
| <b>Alarm Sound</b>            | Tap pick list to select an alarm sound.   |

4. Tap OK.



# Using Palm™ VersaMail™ Personal E-mail Software

With Palm™ VersaMail™ personal e-mail software, you can send, receive, and manage e-mail on your handheld. This chapter describes how to set up different types of e-mail accounts and explains how to use the many e-mail features in the VersaMail application.

## VersaMail™ application features

Key features of the VersaMail 2.6 application include the following:

- Support for both the Palm™ Tungsten™ T3 navigator and keyboard, simplifying data entry and navigation
- Support for the built-in Bluetooth radio in your handheld, enabling wireless e-mail connectivity
- Enhanced use of color, fonts, styles, and user-selected display options
- Basic Hypertext Markup Language (HTML) formatting display for e-mail messages received in HTML format
- Increased number of file types supported for being sent and received as attachments
- Scheduled retrieval of new e-mail, with notification
- Improved message-addressing capabilities
- Enhanced security

## Getting started with the VersaMail application

To start using the application, tap the VersaMail icon  on the Home screen of your handheld.

If you are using a Windows computer, the Palm VersaMail HotSync® Conduit is installed automatically when you install the Palm™ Desktop software. See [“Synchronizing e-mail between the handheld and the desktop”](#) later in this chapter for information on using the conduit.

## Synchronizing an existing username

If you plan to synchronize your Palm Tungsten T3 handheld with an existing username by performing a HotSync operation, you must do so before you enter your e-mail account information in the VersaMail application. If you enter the e-mail account information first and then synchronize your handheld to an existing username, the e-mail account information you entered is overwritten.

## Upgrading a MultiMail/VersaMail database

If you have previously used a Palm personal e-mail application such as MultiMail SE or MultiMail Deluxe, or an earlier version of the VersaMail application, you can upgrade your e-mail database for use with the VersaMail 2.6 application.

**To upgrade an existing e-mail database for use with the VersaMail application:**

1. Perform a HotSync operation with a user profile that contains the existing e-mail database. To do so, tap the HotSync icon , and then select a profile that contains an e-mail database from the displayed list of users.

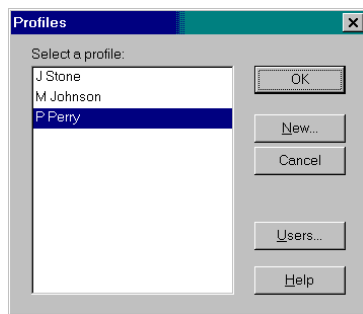

2. Tap the VersaMail icon .
3. Tap Yes to accept the upgrade.

## Setting up and managing e-mail accounts

With the VersaMail application, you can set up accounts on your handheld to access e-mail accounts from providers such as Earthlink or Yahoo; to access your corporate e-mail with the appropriate mail server configuration (see [“Using a corporate e-mail account”](#) later in this chapter for more information); or to synchronize e-mail messages with a desktop e-mail application.

You can add up to eight e-mail accounts on your handheld.

## Account and connection types

Two types of e-mail accounts are supported:

- **Network:** You can send and receive e-mail directly to and from your handheld by connecting with an e-mail service provider.
- **Synchronize Only (Windows computers only):** You can download, view, and manage e-mail between the handheld and a desktop e-mail application, such as Microsoft Outlook, by performing a HotSync operation using the HotSync cradle. You can't send and receive messages wirelessly or with a modem for an account of this type.

Using a network account, you can set up or access an e-mail account by using any of the following connection methods:

- Built-in Bluetooth radio
- PalmModem<sup>®</sup> accessory (sold separately)
- External modem sled (sold separately)
- Infrared (IR) port on the handheld to IR port on a mobile phone
- Direct connection to a mobile phone by means of a physical cable
- HotSync cradle connected to your desktop (Windows users only)

## Network e-mail account prerequisites

Before you can set up a network e-mail account, you must do the following:

- Establish the e-mail account with an e-mail service provider. Common providers include Internet service providers (ISPs) such as Earthlink and Prodigy. A provider can also be a Global System for Mobile Communications (GSM) or high-speed wireless (GPRS) carrier such as VoiceStream, Cingular, or Vodafone. You may also use a corporate e-mail account.
- Configure the service connection settings for this account on your handheld using your handheld's Network Preferences and Connection Preferences screens. See "[Connection Preferences](#)" in [Chapter 21](#) for more information.

You must also have the appropriate prerequisite for the type of connection you want to make, as follows.

Connection Type	Prerequisite
Built-in Bluetooth radio via a mobile phone	Active wireless service with a GSM or GSM/GPRS carrier, and GSM or GPRS mobile phone enabled with Bluetooth technology. Note that some GSM carriers require you to order a special data service (separate from voice service) in order to make a network connection.
Built-in Bluetooth radio via a LAN access point	Proximity to a LAN access point
PalmModem accessory	PalmModem accessory.
External modem sled	Wireless modem accessory.
Infrared to infrared phone	Infrared-enabled mobile phone.
Direct connection to a phone by means of a physical cable	Connector cable and mobile phone.
HotSync cradle connected to desktop	HotSync cradle (Windows users only).

### Using an ISP

If you are setting up a new e-mail account and have a well-known ISP such as Earthlink or Yahoo, many of the required settings during the account setup are automatically configured.

For other ISPs, you need the following information:

- The protocol used for incoming mail, such as Post Office Protocol (POP) or Internet Message Access Protocol (IMAP)
- The name of the incoming mail server
- The name of the outgoing mail (Simple Mail Transfer Protocol, or SMTP) server
- Whether your e-mail account requires any security, such as Secure Sockets Layer (SSL), APOP, or Extended Simple Mail Transfer Protocol (ESMTP)
- Your e-mail address and password
- The login script (if any) that you need for connecting to your ISP or mail server

**NOTE** Information about your e-mail account is available from the e-mail provider. Depending on the type of e-mail service you have, you may be able to access this information by going to the e-mail provider's web site or by contacting the provider's customer support.

### Using a corporate e-mail account

If you want to access e-mail on your handheld using your corporate e-mail account, you create this account on your handheld in exactly the same way as any other account (see [“Creating an e-mail account”](#) later in this chapter), with one exception: for a corporate e-mail account, you may need to set up a virtual private network (VPN). See [“VPNs”](#) later in this chapter for information.

**NOTE** If your company has a Bluetooth network located behind the corporate firewall, or if you are using an 802.11b SDIO card, sold separately, in your handheld and your company has an 802.11b network located behind the corporate firewall, you may not need to set up a VPN to access your corporate e-mail account. See the following section for details.

The following considerations apply when setting up a corporate e-mail account:

<b>Username and password</b>	These might be your Windows NT or Windows 2000 username and password, your Lotus Notes ID username and password, or something else. Check with your company’s server administrator to obtain the correct username and password. The VersaMail 2.6 application provides strong 128-bit AES encryption for your password.
<b>Protocol</b>	Most corporate mail servers use the IMAP protocol for retrieving mail. In rare cases, your company server may use the POP protocol. Check with your company’s server administrator to verify the protocol.
<b>Incoming and outgoing mail server settings</b>	Check with your company’s server administrator to obtain these settings.

See [“Creating an e-mail account”](#) later in this chapter for steps for inputting your username, password, protocol, and incoming and outgoing server settings when you set up your corporate e-mail account.

With a corporate e-mail account, you can access the following types of mail servers, among others:

- Microsoft Exchange
- Lotus Domino
- Sun iPlanet

### VPNs

If you want to access e-mail on your handheld using your corporate e-mail account, you may need to set up a virtual private network (VPN) on your handheld. A VPN enables you to log in to your corporate mail server through the company’s firewall (security layer). Without a VPN, you cannot “break through” the firewall to gain access to the mail server.

You need to set up a VPN to access corporate e-mail in either of the following two situations:

- Your company's wireless local area network (LAN) is located outside the firewall.
- Your company's wireless LAN is located inside the firewall, but you are trying to access the network from outside the firewall (for example, from a public location or at home).

Check with your company's server administrator to see if a VPN is required to access the corporate network.

**NOTE** The auto get mail with notification feature in the VersaMail application may not work with a particular VPN connection. Also, you cannot use scheduled sending retry of e-mail with accounts that use a VPN connection. See ["Auto get mail with notification"](#) and ["Send retry"](#) later in this chapter for information.

## Creating an e-mail account

You create a new account in Account Setup, which guides you through the process. The steps for creating a network account and a synchronize-only account are identical except for selection of a single check box for a synchronize-only account; see step 4 in the procedure below.

**To create a network e-mail account:**

1. Tap the Menu icon , select Accounts, and then select Account Setup.
2. Tap New.



3. Enter the following:

- Account Name** Enter a descriptive name for the account, such as “My Yahoo.”
- Mail Service** Tap the Mail Service pick list, and then select the provider to which you are connecting. Select Other if your ISP is not listed.
- Protocol** Tap the Protocol pick list, and then select POP or IMAP. (Most e-mail providers use POP.)

The screenshot shows the 'Account Setup' dialog box. At the top, it says 'Enter a name for this account (e.g. My Mail) and select settings.' Below this, there are three fields: 'Account Name' with the value 'Sam Yahoo', 'Mail Service' with a dropdown arrow and the value 'Yahoo', and 'Protocol' with a dropdown arrow and the value 'POP'. At the bottom, there is a checkbox labeled 'Synchronize Only Account' which is currently unchecked. There are 'Cancel' and 'Next' buttons at the bottom of the dialog.

If the VersaMail application knows the protocol for the mail service you selected, it displays the correct protocol.

4. For synchronize-only accounts only: On the same screen, select the Synchronize Only Account check box.

**NOTE** You must be using a Windows computer to use a synchronize-only account.

This screenshot is similar to the previous one, but the 'Synchronize Only Account' checkbox is now checked. A line points from the text 'Select check box for a synchronize-only account' to the checked checkbox. The 'Account Name' field now contains 'Sam Sync' and the 'Mail Service' dropdown now shows 'EarthLink'. The 'Protocol' dropdown still shows 'POP'. The 'Cancel' and 'Next' buttons are still present at the bottom.

5. Tap Next.

### Entering the account username and password

In the next part of the VersaMail Account Setup, you enter the username and password for this account. The VersaMail 2.6 application provides strong 128-bit AES encryption for your password.

**To enter the account username and password:**

1. Enter the username you use to access your e-mail. This is generally the part of your e-mail address appearing before the @ symbol; it is usually not your entire e-mail address.



2. Tap the Password box, and then enter your password.
3. Tap OK. The Password box displays the word “Assigned” to indicate that a password has been entered.
4. Tap Next.

**Entering the name of the incoming and outgoing mail server**

You need to verify your e-mail address for the account you are accessing, as well as enter the names of the outgoing and incoming mail servers.

**To enter mail server settings:**

1. If you chose a preconfigured service from the Mail Services pick list on the Account Setup screen, the e-mail address field is completed automatically, based on the username and mail service you entered. Check the address to verify that it is correct, and edit it if necessary.

If you chose Other from the Mail Services pick list on the Account Setup screen, enter the e-mail address for your account.



E-mail address will be filled in automatically if you chose a preconfigured mail service

Mail servers will be filled in automatically if the VersaMail application knows the names based on the mail service you chose



2. Enter the name of your incoming (POP) mail server, such as pop.mail.yahoo.com.

If the VersaMail application knows the incoming mail server name based on the mail service you selected, the correct server name is displayed.

3. Enter the name of your outgoing (SMTP) mail server, such as smtp.mail.yahoo.com.

If the VersaMail application knows the outgoing mail server name based on the mail service you selected, the correct server name is displayed.

4. Tap Next.

5. Do one of the following:

- To accept these mail options and begin using the VersaMail application, tap Done. This takes you to the Inbox of the account you set up. See [“Getting, sending, and managing e-mail”](#) later in this chapter for information on getting and sending e-mail. If you set up a synchronize-only e-mail account, you need to configure this account on your desktop. See [“Configuring account settings in HotSync Manager”](#) later in this chapter for information. You will not be able to synchronize e-mail between your handheld and your desktop until you configure the account on your desktop.
- To set up additional mail options, tap Next. Continue with the next set of procedures.

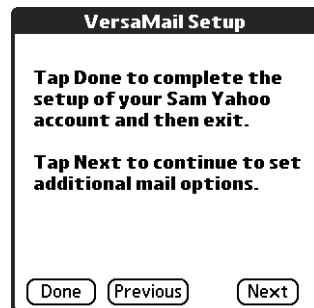

### Setting mail retrieval options for a POP or IMAP account

The next VersaMail Setup screen displays different options depending on whether your mail service uses POP or IMAP.

**To set mail retrieval server options for a POP or IMAP account:**

1. (Optional) Select any of the following:

**Get unread mail**     **NOTE** The POP protocol does not support retrieval of unread mail only from the server. If you have a POP e-mail account, the VersaMail application downloads all messages from the server regardless of whether you have read them (for example, on your desktop or on the web), and regardless of whether this check box is selected.

For IMAP accounts, select Get unread mail ONLY to download only unread mail to your handheld. If you don't choose this option and you tap Get & Send, all of your e-mail messages on your provider's mail server are downloaded to your Inbox, including messages you have already read. To get all mail (including mail you have already read) and not just unread mail, deselect Get unread mail ONLY.

**Delete messages on server**     To delete messages on your provider's mail server when they are deleted in the VersaMail application, select the Delete messages on the server when they are deleted in VersaMail check box.

**Leave mail on server (POP account only)**     To get e-mail on your handheld but also leave it on the server so you can view it later on your desktop, select the Leave mail on server check box. For example, if you create an account to receive e-mail from your Yahoo account and select this option, your old Yahoo e-mail is still visible the next time you visit Yahoo.com to access your Yahoo e-mail Inbox.

**Port Number**     The port number setting defaults to 110 for POP and to 143 for IMAP servers. You may need to change the port number if you choose to retrieve incoming mail over a secure connection (see the next bullet item). If you are not sure about the correct port number, check with your mail server administrator.

**Use Secure Connection**     To retrieve incoming mail over a secure (Secure Sockets Layer, or SSL) connection, select the Use Secure Connection check box.

**Maximum Message Size**

To limit the maximum size of an incoming e-mail message, enter the size in kilobytes (KB) for Maximum Message Size. The maximum size of an incoming message is 5KB by default, but you can enter any size up to 2048KB, including attachments. The maximum message size that you can retrieve is 60KB for the body text and approximately 5 megabytes (MB) of total data for any attachments. Because downloading large messages can consume handheld resources, the VersaMail application displays the size of and asks if you want to continue downloading any message that exceeds your maximum message size, up to a total size of 5MB.

## POP accounts

## IMAP accounts

## 2. Tap Next.

**Setting outgoing mail options**

Outgoing mail options are the same for POP and IMAP accounts.

**To set outgoing mail options:**

## 1. (Optional) Do any of the following:

- Display Name** Enter the name you want to appear on your outgoing messages, such as "Joe Smith."
- Reply To Address** Enter the e-mail address that you want recipients to see and reply to on your e-mail messages, only if this is different from the e-mail address from which you are sending the message. For example, if you are sending a message from me@yahoo.com but you want recipients to reply to me@earthlink.net, enter the reply-to address here. Reply To Address makes it look as though the e-mail came from the address you entered.

- BCC** Select the BCC check box to send a blind copy of any e-mail message you send to another e-mail address. The blind copy e-mail address is not seen by the other recipients of the message. For example, if you want a copy of all messages you send from your handheld to be sent to your corporate e-mail account, enter that e-mail address.

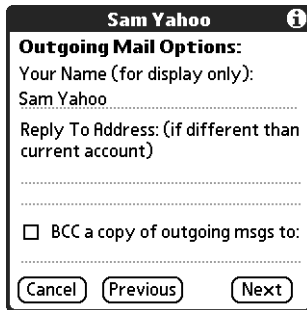

2. Tap Next.

### Adding a signature

If you want, you can add a signature to each e-mail message you send. For example, you can enter your name and telephone number so that they appear on each message you send.

#### To add a personal signature:

1. Tap the Attach Signature to messages check box, and then enter the text of the signature.

This signature is attached to all your outgoing e-mail.



Signature lines appear only if check box is selected

2. Tap Next.

## Setting advanced outgoing mail options

You can set additional outgoing mail options.

### To set advanced outgoing mail options:

1. (Optional) Select either of the following:

**Port Number**      The default is 25, the port number most SMTP servers use. If you are not sure about the correct port number, check with your mail server administrator.

**Authentication**      Select the My server requires authentication (ESMTP) check box if the outgoing server (SMTP) requires authentication. Check with your system administrator before selecting this option. See [“Adding ESMTP to an account”](#) later in this chapter for information. If you select this option, username and password fields appear. These fields are already filled in based on the account information you entered previously. In most cases, the information displayed is correct; however, occasionally your authentication username and/or password is different from your account username or password. Check with your e-mail service provider for authentication username and password information.

If you need to enter new information, enter a username and/or tap the Password box and enter a password, and then tap OK.

The screenshot shows a dialog box titled 'Sam Yahoo' with an information icon. The main heading is 'Advanced Outgoing Options:'. Below it, 'Port Number: 25' is displayed. A checkbox labeled 'My server requires authentication (ESMTP)' is checked. Underneath, the 'Username:' field contains '-Assigned-' and the 'Password:' field also contains '-Assigned-'. At the bottom, there are two buttons: 'Done' and 'Previous'. A line from the text to the right points to the 'Password:' field.

Username and Password fields appear only if ESMTP check box is selected

2. Tap Done.

## Testing your new account

After you finish setting up a new e-mail account, the Inbox of the account you just created is displayed. You can test whether the e-mail account is set up and working properly by tapping Get Mail. See [“Getting e-mail by subject or getting the entire message”](#) later in this chapter for more information.

If you set up a synchronize-only e-mail account, you need to configure this account on your desktop. See [“Configuring account settings in HotSync Manager”](#) later in this chapter for information. You will not be able to synchronize e-mail between your handheld and your desktop until you configure the account on your desktop.

## Editing e-mail accounts

From time to time, you may need to edit information about one of the e-mail accounts you set up.

To select the account to edit:

1. Tap the Menu icon , select Accounts, and then select Account Setup.
2. Tap the name of the account to edit, and then tap Edit.

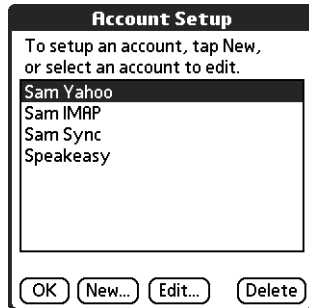

After you select the account to edit, the VersaMail application displays the same series of screens that you see when you set up an account. To edit an account, follow the procedures in [“Creating an e-mail account,”](#) earlier in this chapter, and change the entries you want to edit on the appropriate screens.

## Deleting an e-mail account

When you delete an account in the VersaMail application, the account is removed from your handheld. The account still exists on the server. For example, deleting your Yahoo account from the VersaMail application deletes the account only from your handheld. Your e-mail account still exists at Yahoo.com.

**NOTE** You can delete all but one of your e-mail accounts; you must have at least one account.

To delete an account:

1. Tap the Menu icon , select Accounts, and then select Account Setup.
2. Tap the name of the account you want to delete, and then tap Delete.

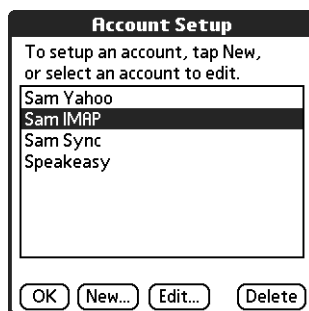

3. Tap Yes in the Delete Account dialog box to delete the account and all associated e-mail messages.



4. Tap OK.

After you perform the next HotSync operation, the memory associated with an account and its messages is released.

## Selecting a different service for a given e-mail account

When you set up connections on your handheld (using the Phone Link application on your handheld), you pair each connection with a network service and then select one of these services to be the default for all network activity (sending and receiving e-mail, surfing the web, and so on) on your handheld. By default, the VersaMail application uses this service for sending and receiving messages for all e-mail accounts you set up. See [Chapter 12](#) for information on setting up the default service for your handheld.

However, for any given e-mail account, you have the option of switching to a different service for use with that account only. For example, the default service you have selected for your handheld may be called Bluetooth and may use your handheld's built-in Bluetooth radio to make a connection to your corporate mail server. However, for your Earthlink account, you may want to switch to the service called Modem, which uses an external modem accessory (sold separately) to make a connection to your e-mail service provider.

**To set up a service for a given e-mail account (different from the default service for your handheld):**

1. From the Inbox of the account you want to switch, tap Get Mail.

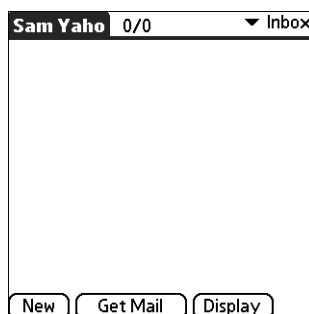

2. Tap Details.

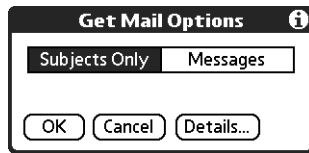

3. Tap the Always connect using check box. A pick list of available services appears. The currently used connection is displayed by default.



Tap to change the service connection for this e-mail account only from your default handheld service connection

4. Select the connection you want to switch to from the Service pick list.

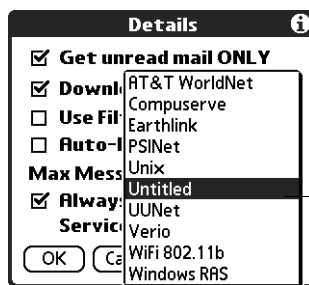

Select a new service connection for this e-mail account only

5. Tap OK, and then tap OK again. If there is an existing service connection, it is disconnected and the new connection is initiated. The VersaMail application sends and checks for any new e-mail using the new connection.

When you exit the VersaMail application, the new service disconnects (unless you are using the default service for your handheld). When you reopen the application, the e-mail account you selected (Earthlink in this example) continues to connect using the new connection (Modem in this example) until you either select a new service or deselect the Always connect using check box. If you deselect the Always connect using check box, the e-mail account (Earthlink) connects using the default handheld service (Bluetooth in this example).

The Always connect using check box changes the connection service for the selected e-mail account only. You must follow the preceding procedure for each e-mail account whose connection you want to switch from the default connection on your handheld.



## Adding ESMTP to an account

Some services require ESMTP authentication to validate your username and password on an SMTP server. If you aren't sure if your ISP or web e-mail provider supports ESMTP, check with your e-mail provider.

To edit an account and add ESMTP:

1. In your Inbox or on another folder screen, tap the Menu icon .
2. Select Options.
3. Select Mail Servers.
4. Tap the Account pick list, and then select Edit Accounts.

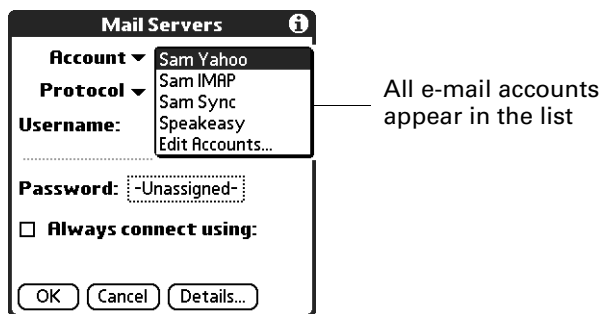

5. Tap the name of the account you want to change, and then tap OK.
6. On the Server Settings screen, tap Details.
7. Tap the Options pick list, and then select Advanced Outgoing.

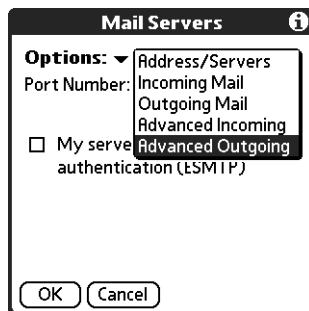

8. Select the My server requires authentication (ESMTP) check box if the outgoing server (SMTP) requires authentication. Check with your system administrator before selecting this option. If you select this option, username and password fields appear. These fields are already filled in based on the account information you entered previously. In most cases, the information displayed is correct; however, occasionally your authentication username and/or password is different from your account username or password. Check with your e-mail service provider for authentication username and password information.

If you need to enter new information, enter a username and/or tap the Password box and enter a password, and then tap OK.

Username and Password fields appear only if ESMTP check box is selected

9. Tap OK.

## Troubleshooting account access problems

Occasionally you may experience problems using an e-mail account after you set it up. If you followed the account setup procedures described in [“Setting up and managing e-mail accounts”](#) earlier in this chapter but experience problems using the account, you may need to verify that the account complies with your e-mail provider’s requirements. See [Appendix B](#) for troubleshooting information for account access problems.

## Getting, sending, and managing e-mail

Getting and sending e-mail on your handheld is easy and helps you keep your business and personal life organized.

You can manage the messages in your e-mail accounts by moving messages between folders, deleting old e-mail messages individually or in groups, and marking messages as read or unread.

### Getting e-mail

You can get e-mail subjects only—the message size, author, and subject—or you can get entire messages immediately. If you choose to get message subjects only and want to read a full message, you can get more of the message. If you choose to get the entire message, the body text of the message will be downloaded up to the maximum message size you select. See [“Reading e-mail”](#) later in this chapter for information.

#### Choosing the e-mail account and displaying the Inbox

To view the e-mail in an account, you must switch to that account and then get the e-mail. For example, if you want to collect and view the e-mail from your Yahoo account, you switch to the account created to retrieve e-mail from your Yahoo account.

**To display an account and its Inbox:**

1. In your Inbox or on another folder screen, tap the Menu icon , and then select Accounts.
2. Tap the name of the account you want from the list.
3. Tap the folders pick list, and then select Inbox if the Inbox is not displayed.

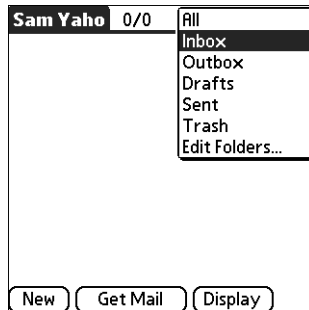
**Getting e-mail by subject or getting the entire message**

When you get e-mail messages, you can choose to get the subject only or to get the entire message. You can also use the Details dialog box to select options for getting unread e-mail only, downloading attachments, using filters, and more.

**To get e-mail messages:**

1. Tap Get Mail.
  - If you have e-mail stored in your Outbox, tap Get & Send.
2. In the Get Mail Options dialog box, tap Subjects Only to download subjects only, or tap Messages to download entire messages.



**TIP** You can deactivate the Get Mail Options dialog box by using VersaMail Preferences. See [“Setting preferences for getting and deleting e-mail”](#) later in this chapter.

3. (Optional) Tap Details, and then select options for retrieving unread e-mail (IMAP accounts only), downloading attachments, using filters to download only messages that meet certain criteria, using auto-disconnect to close your remote connections after each command, maximum download size, and default connection type for this account. Tap OK.

**NOTE** See [“Selecting a different service for a given e-mail account”](#) earlier in this chapter for information on setting a default connection type.

**NOTE** The maximum size of an incoming message is 5KB by default.



4. (Optional) For IMAP accounts, you have the option of synchronizing IMAP folders from the Get Mail Options dialog box. Wireless IMAP folder synchronization enables you to synchronize e-mail messages between a folder in an e-mail account on your handheld and a folder with the same name on your e-mail provider's mail server.
5. Tap OK.
6. (Optional) If you are retrieving mail using a VPN connection, you may be asked to enter the username and password you use to log in to the VPN. If so, enter the username and password. See "VPNs" earlier in this chapter for more information.
7. The Getting Messages dialog box shows updates as your e-mail is downloaded. When the Getting Messages dialog box disappears, another dialog box appears and displays the number of new e-mail messages.

8. Tap OK.

A list of your e-mail appears in the Inbox.

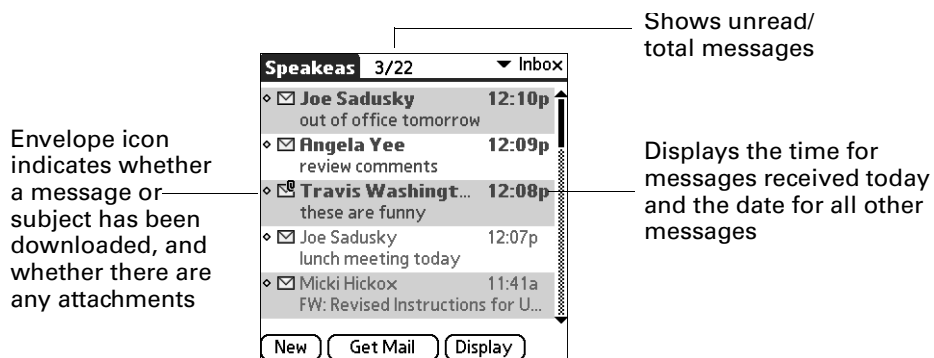

## Auto get mail with notification

You can set up the VersaMail application to automatically search for new mail on a regular schedule for an e-mail account. The auto get mail feature automatically retrieves new messages and downloads them to your handheld.

If auto get downloads any new messages, your handheld notifies you by blinking an indicator light, beeping, or vibrating. The handheld also displays a visual list of notifications on the Reminders screen.

The auto get feature downloads the first 3KB of each message. If a message is larger than 3KB, tap the More button on the message screen to download and view the entire message.

Auto get mail recognizes any filter criteria you have set up for downloading messages to your handheld. Any messages that do not meet the filter criteria are not downloaded during an auto get. To retrieve messages that do not conform to filter criteria, perform a manual get with all filters turned off.

If auto get is occurring and you turn your handheld off or the connection to your e-mail service provider is disconnected, the auto get fails. If you are attempting an auto get over a network from a public location, you must be in range of a network access point for the auto get to work.

### Scheduling auto get mail

When setting up a schedule, you select the interval for retrieving mail, the start and end times for retrieving mail, and the days on which scheduled e-mail retrieval should take place.

You can set up different schedules for each of your e-mail accounts, but you can set up only one schedule for an account. For example, if you set up a schedule for mail retrieval on weekdays for your Yahoo account, you cannot set up a separate schedule for weekends on the same account.

If more than one scheduled auto get takes place at the same time (for example, for two separate e-mail accounts), the retrievals take place in the following order:

- Any past-due auto get (for example, a retry of an earlier failed auto get)
- Current retrievals according to the order of e-mail accounts (#1, #2, and so on)

**NOTE** The auto get feature may not work with your specific VPN connection. It is also not supported for SSL connections, or if you have configured the security preferences on your handheld to encrypt databases on the handheld. For some nonsupported connection types, the Options menu does not display the auto get mail option; for others, if you try to set up an auto get schedule, an error message appears.

#### To set up a scheduled auto get mail:

1. On the message screen, tap the Menu icon .
2. Select Options.
3. Select Auto Get Mail.

4. Select the Get mail automatically check box.



5. Set schedule options:

**Interval** Tap the Every pick list and select the time interval, from 15 minutes to 12 hours. See [“Resource issues with auto get mail”](#) later in this chapter for information on setting the interval.

**Start Time** Tap the Start Time box, tap to enter the start time hour and minute, and tap to enter AM or PM. Then tap OK.

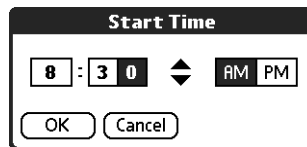

**NOTE** The start and end time screens display the hour and minute using the default time format you select for your handheld.

**End Time** Tap the End Time box, tap to enter the end time hour and minute, and tap to enter AM or PM. Then tap OK.

**Days** Tap the days you want the schedule to be active. You can choose any number of days, but you can set up only one schedule for each e-mail account.

6. Tap OK.
7. (Optional) Tap Get Mail. You should perform a manual get mail after setting up a scheduled auto get. This ensures that only new messages are retrieved during auto get.

**TIP** Alternately, if you have configured an e-mail account to synchronize messages between your handheld and your desktop, you can perform a HotSync operation after setting up a scheduled auto get to ensure that only new messages will be retrieved during auto get. See [“Synchronizing e-mail between the handheld and the desktop”](#) later in this chapter for configuration information.



### Auto get notifications

The auto get mail feature provides three types of alerts during and after message retrieval:

- Depending on the connection type, a series of status messages may appear during the auto get connection and mail retrieval process.
- You can choose to have your handheld alert you when a new message arrives in your account. The beep or alert sound you hear is called a *notification*. Your handheld also notifies you of a new message’s arrival by blinking an indicator light or vibrating if certain preferences are selected. For more information, see [“Making your handheld buzz or blink when you get new e-mail”](#) later in this chapter.

**NOTE** You must select the Notification option to have your handheld notify you when new messages are received. See the next section, [“Setting notification options,”](#) for more information.

- If auto get discovers and downloads new messages for an e-mail account, a notification appears on the Reminders screen, displaying the account name and the number of new messages. If auto get is scheduled for more than one account, a separate notification appears for each account. See [“Viewing and using the Reminders screen”](#) later in this chapter.

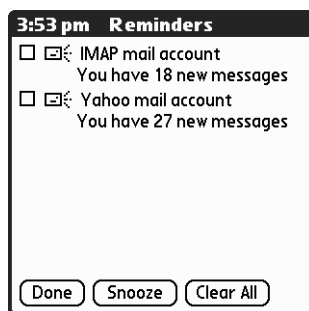

### Setting notification options

You can turn the notification sound on or off to notify you when new e-mail arrives. You can choose from a variety of sounds, such as birds, bumble bees, or simply an alarm.

To set notification options:

1. In the Inbox or on another folder screen, tap the Menu icon .
2. Tap Options.
3. Tap Notification.
4. Tap the Notify me of new mail and mail alerts check box.



5. Tap the Notify Sound pick list, and then select a sound. The handheld plays a brief demonstration of the sound.

**NOTE** If you have installed a custom sound on your handheld, it appears on the Notify Sound pick list.

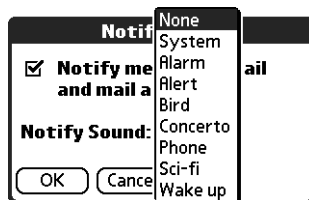

6. To receive notifications of successful auto get mail and automatic send retries only, deselect the Notify me of Auto Get and Send failures check box. Leave the check box selected if you want to receive notifications of both successful and failed auto get mail and automatic send retries.
7. Tap OK.

You can follow these procedure steps to change the notification sound or to turn the sound on or off at any time.

### Making your handheld buzz or blink when you get new e-mail

In addition to setting a notification sound, you can also choose to have your handheld's indicator light blink or to have your handheld vibrate when you receive new e-mail. You select how your handheld notifies you of new e-mail in your handheld's General preferences.



To make your handheld buzz or blink when you get new e-mail:

1. Tap the Home icon .
2. Tap the Prefs icon .
3. From the General Preferences list, tap Sounds & Alerts.

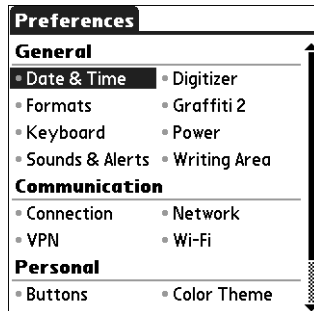

4. Do any of the following:
  - To change the volume of the Alarm Sound, tap the Alarm Sound pick list, and then select Low, Medium, High, or Off.
  - To change whether or not the handheld indicator light blinks when you receive new e-mail, tap the Alarm LED pick list, and then select On or Off.
  - To change whether or not the handheld vibrates when you receive new e-mail, tap the Alarm Vibrate pick list, and then select On or Off.

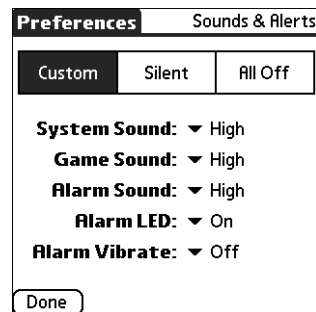

5. Tap Done.

### Viewing and using the Reminders screen

Your handheld displays a Reminders screen that shows summary information about new e-mail messages and alerts from other applications, such as alerts to remind you of Calendar appointments.

**To view the Reminders screen:**

- Tap the blinking asterisk  in the upper-left corner of any screen.

Tap the check box to remove a single reminder from the list

The mail icon tells you that this reminder is for an e-mail message

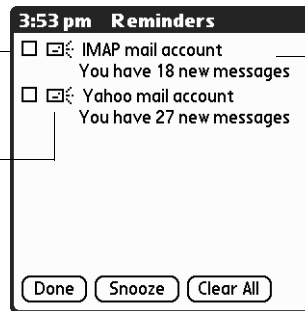

Tap the text to open the account Inbox or view a detailed error message

If you set up a scheduled auto get mail and you receive new e-mail messages, they are downloaded into the Inbox. As you work with e-mail messages in the Inbox, the Reminders screen doesn't display a reminder for any new messages that arrive, because the messages are already displayed in the Inbox.

**NOTE** A broken envelope icon  appears next to a notification when an auto get mail fails.

To respond to the reminders, do one of the following:

- Tap the check box to clear a reminder from the list.
- Tap the reminder (either the mail icon or the text description) to go to the Inbox of that account or to read a detailed error message.
- Tap Done to close the Reminders screen and return to whatever you were doing on your handheld before the Reminders screen appeared.
- Tap Clear All to dismiss all reminders on the Reminders screen.

When a notification appears on the Reminders screen, tap the notification to go to the Inbox of that account, or launch the VersaMail application and go to that account. Once you view a message in the Inbox, it is removed from the Reminders screen, even if you do not open the message. Auto get then starts at the next scheduled interval, with the Reminders screen counter reset to 1.

If you do not view the Inbox of the selected account and another scheduled e-mail retrieval takes place and finds new messages, the Reminders screen adds the number of new messages to the notification for that account. For example, if scheduled auto get #1 finds two new messages and, before you view the Inbox, scheduled auto get #2 takes place and finds three more new messages, the Reminders screen notification indicates five new messages for that account.

If auto get discovers new messages but then fails for any reason, a notification appears on the Reminders screen, displaying the account name and an error message.

**NOTE** You can choose to disable notifications for auto get mail failures. See “[Setting notification options](#)” earlier in this chapter for instructions.

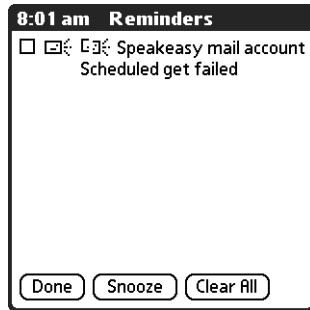

You can tap the error message or open the VersaMail application for that account for more detailed information on the failed auto get.

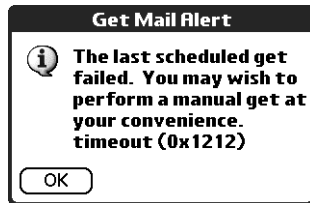

If auto get discovers no new messages for an account, no notifications appear on the Reminders screen for that account.

The Reminders screen displays only the most recent notification for an account. For example, if one scheduled auto get failed, but the next one succeeded and downloaded two new messages, the Reminders screen would first display the error message, but would display the number of messages retrieved after the successful retrieval.

Reminders screen notifications are specific for each account. For example, if auto get fails for one account but succeeds in downloading new messages for a separate account, the Reminders screen displays an error message for the first account and a message indicating the number of messages downloaded for the second account.

### Auto get mail retries

If the interval for scheduled auto get is set at “Every 1 hour” or less frequently, and an auto get fails for any reason, the VersaMail application continues attempting to retrieve e-mail at 30-minute intervals until either the next scheduled auto get occurs or the end time for scheduled e-mail retrieval is reached. If the interval is set for more frequently than one hour and an auto get fails, the VersaMail application waits until the next scheduled auto get.

### Resource issues with auto get mail

If you use the auto get mail feature, you should be aware of the following potential resource constraints:

**Decreased battery life** If you set the auto get interval for more frequently than once per hour, you may drain your handheld's battery charge more quickly, and thus need to recharge the battery more frequently.

**Increased monthly charges** If your e-mail service provider is a wireless provider such as Cingular or T-Mobile that charges a fee for data transactions, using the auto get feature can substantially add to your monthly charges. This issue is especially noticeable for POP accounts, because the size of the IDs used to locate POP account messages is much larger (and thus POP messages take longer to download) than for IMAP accounts.

**NOTE** If you primarily retrieve messages over your company's network (Bluetooth or 802.11b network), monthly charges should not be an issue.

To minimize resource concerns, set your interval for e-mail auto get to no more frequently than once per hour.

### Inbox icons in the VersaMail application

The icons to the left of a message in the Inbox indicate the message's status.



Only the subject header information is downloaded.



Part or all of the message text is downloaded.



Part or all of the message text and attachment information is downloaded.

## Reading e-mail

To read e-mail, tap the e-mail message in the Inbox or the folder where the message is located.

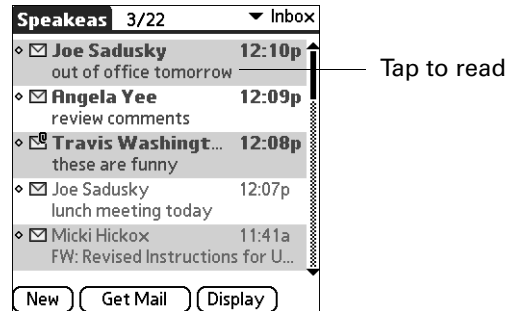

Alternately, you can use the navigator for one-hand message viewing.

### To read a message using the navigator:



1. Press Select on the navigator to highlight the first message displayed on the screen, and then press Up or Down to scroll one message at a time to the message you want to read.
2. Press Select to open the message.
3. After reading the message, press Select to close the message.

If you chose to get messages by subjects only, tap the More button  to view the body of the e-mail message, plus any attachments, up to the maximum message size you select. If the downloaded message exceeds your maximum message size, only a partial message is displayed. Tap the More button to view the entire message. See [“Getting e-mail by subject or getting the entire message”](#) earlier in this chapter.

If you chose to get entire messages, the body of the e-mail message is displayed. However, if the downloaded message exceeds your maximum message size, only a partial message is displayed. Tap the More button to view the entire message.

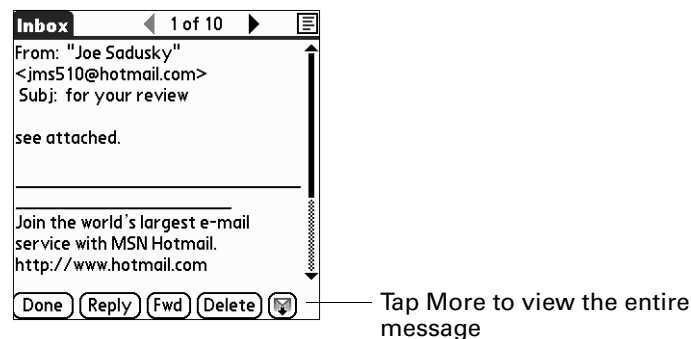

### Plain text and HTML e-mail

By default, the VersaMail application is set to receive mail in HTML format. This means that any e-mail messages sent as HTML will be displayed on your handheld with basic HTML formatting intact, including the following:

- Boldface
- Italics
- Underlining
- Colored words
- Bullet lists
- Numbered lists
- Line breaks

Most formatting not displayed is stripped of its HTML tags and shown as plain text. For certain types of graphic images (for example, JPEG or GIF files), the graphic may be displayed as a URL in the body of the e-mail message. In some cases, you can tap the URL to open the graphic image. See [“Working with URLs”](#) later in this chapter for more information.

When you set the VersaMail application to receive e-mail messages as HTML, any messages sent as plain text will be displayed as plain text only. You can also set the application to receive all messages as plain text only, regardless of the format in which they were sent. If you choose this option, only the text of any messages sent in HTML format will be displayed.

**NOTE** The VersaMail application sends all messages as plain text only, with all HTML tags stripped, even if you are forwarding or replying to a message that was originally received as HTML.

To select whether to receive e-mail messages in HTML or in plain text format:

1. Tap the Menu icon , select Options, and then select Preferences.

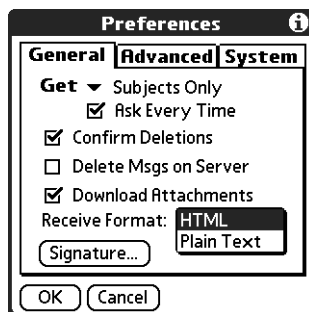

2. Tap the Receive Format pick list, and then select HTML or Plain Text. The default is HTML.
3. Tap OK.

## Viewing other folders

By default, the VersaMail application displays the messages in a given account's Inbox folder. You can easily view the messages in a different folder.

### To view other folders:

1. Tap the folders pick list in the upper-right corner of the screen.

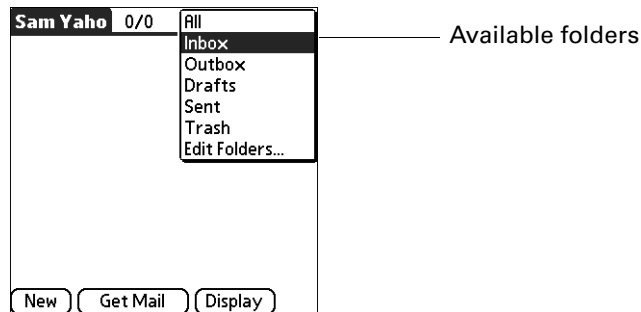

2. Tap the folder you want to view.

## Managing display options in the folder's list view

You can customize the way in which messages appear in the list view of your mail folders. The options you choose apply to all folders.

The display options that you can customize, and the default settings, are as follows:

Option	Default
Sort by	Date
Sort order	Descend
Summary view	Two-line view
Summary view columns	Sender, Date, Subject
Font	Palm 9 Plain
Unread message color	Black
Read message color	Black

To change the sort order:

1. Tap Display.
2. Tap the Sort by pick list, and then select the column name.

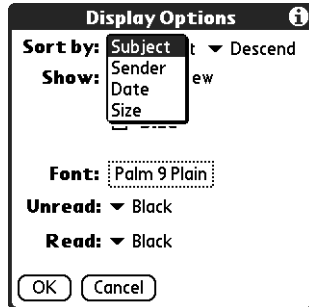

3. Tap Descend or Ascend to change the sort order.

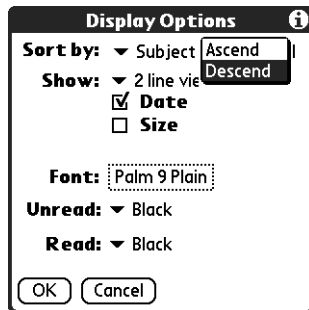

4. Tap OK.

To select a one-line or two-line view:

1. Tap Display.
2. Tap the Show pick list, and then select the view you want.

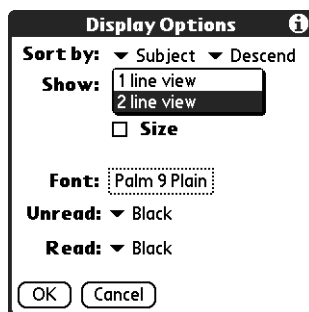

3. Tap OK.



To display or hide a column in a folder's list view:

1. Tap Display.
2. Tap the check box for each column that you want to show. The column options will change depending on whether you choose a one-line or a two-line view.

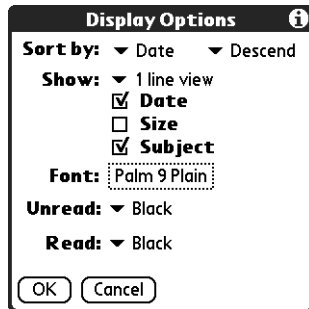

**NOTE** If you select Date, the Date column displays the message *time* for any messages received today—that is, any message received after 12:01 A.M. Otherwise, the Date column shows the date the message was received.

3. Tap OK.

To change the font:

1. Tap Display.
2. Tap in the Font field.

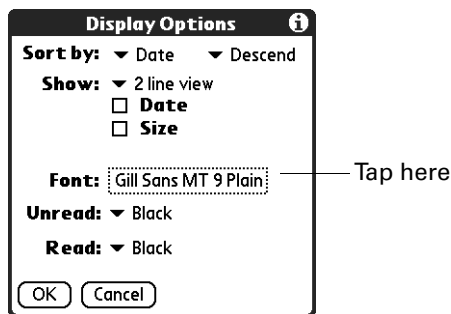

3. Tap the Font pick list, and then select the font you want.

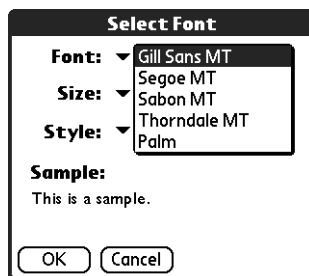

4. Tap the Size pick list, and then select the font size you want.

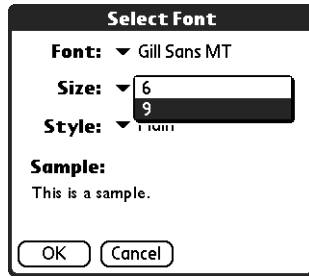

5. Tap the Style pick list, and then select the font style you want.

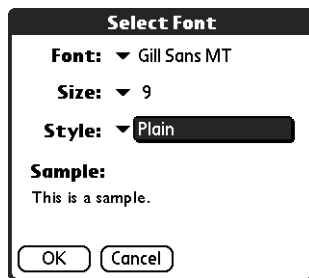

6. Tap OK.

To select colors for read and unread mail:

1. Tap Display.
2. Tap the Unread pick list, and then tap the color you want to use to display unread messages.
3. Tap the Read pick list, and then tap the color you want to use to display read messages.

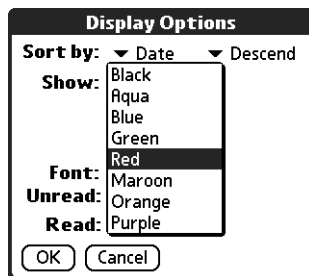

4. Tap OK.

In the list view itself, you can also change the size of the columns.

To change the size of a column in the folder's list view:

**NOTE** Changing column size is available for one-line message view only.

1. Tap and hold the stylus on the column divider.
2. Drag the column divider to change the width of the column.

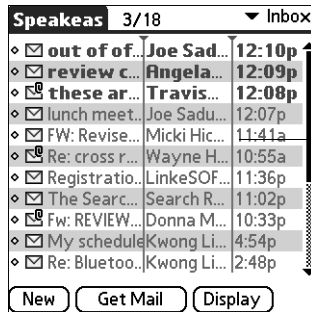

Drag the column divider left or right to make the column narrower or wider

3. Tap OK.

You can also change the font within an individual message. This change affects the the font of all messages you compose.

To change the font of a composed message:

1. On the message screen, tap the Menu icon .
2. Select Options.
3. Tap Font.
4. Tap the Font pick list, and then select the font you want.

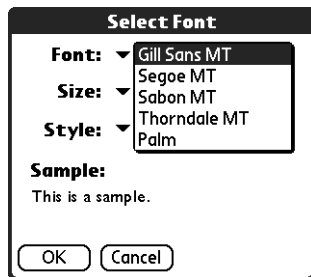

5. Tap the Size pick list, and then select the font size you want.

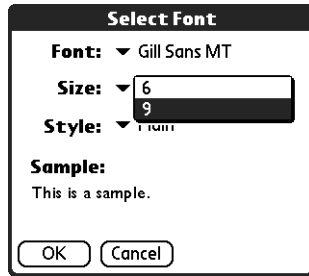

6. Tap the Style pick list, and then select the font style you want.

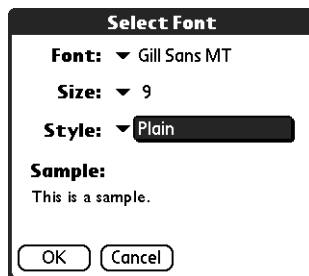

7. Tap OK.

### Moving e-mail between folders

You can move one or more e-mail messages between folders.

To move one e-mail message:



1. Tap the folders pick list in the upper-right corner of the screen, and then select the folder name; or, press Up or Down to move to the folder you want, and then press Select to select the folder.

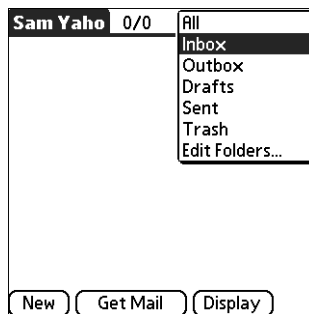

2. Tap the message you want to move, press Right on the navigator to open the Message menu, press Down to go to the Move To option, and then press Select to select this option.

Alternately, tap the icon to the left of the message, and then tap Move To from the pop-up menu.

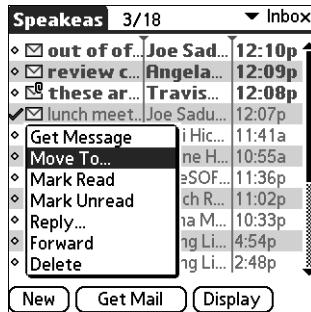

The folders pick list appears.

3. Press Up or Down on the navigator to move to the folder you want, and then press Select to select the folder.

Alternately, tap the folder you want.

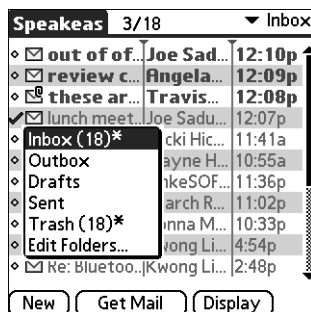

To move multiple e-mail messages:

1. Tap the folder that contains the e-mail messages you want to move.
2. Select the messages by tapping to the left of each message icon.

**TIP** To select a group of adjacent messages, drag the stylus to the left of the message icons.

A checkmark appears next to each selected message.

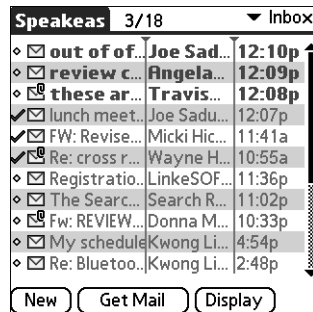

3. Do either of the following:

- Tap the Menu icon , and then select Move To on the Message menu.
- Tap a message icon next to a selected message, and then tap Move To on the pick list.

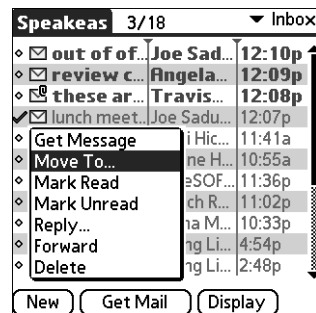

4. Tap the folders pick list, and then select a destination folder.

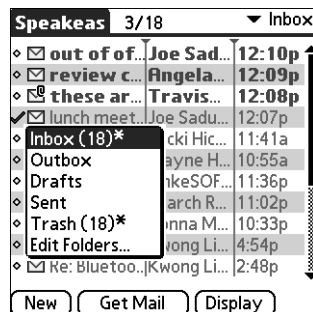

5. Tap OK.

## Creating and editing mail folders

You can also create new folders so that you can store e-mail messages by subject, person, or project. The VersaMail application has certain existing folders, such as Inbox, Outbox, Drafts, and Trash.

The procedure for creating and editing folders varies slightly between POP and IMAP e-mail accounts, as described in the following procedure.

### To create and edit e-mail folders:

1. Tap the folders pick list in the upper-right corner of the screen, and then tap Edit Folders.
2. On the Edit Folders or Edit IMAP Folders screen, select any of the following:

POP accounts

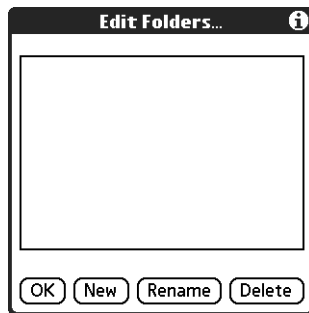

IMAP accounts

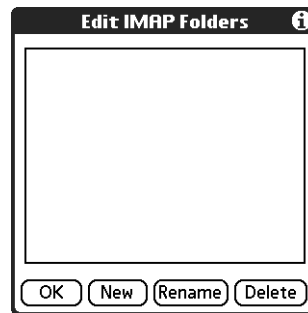

- To create a new folder, tap New, and then enter the new folder name. For IMAP accounts only, select the check box if you also want to create the folder on the server. When finished, tap OK.

POP accounts



IMAP accounts

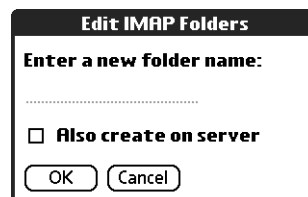

- To rename a folder, tap the folder name from the list on the screen, tap Rename, and then enter the new folder name. For IMAP accounts only, select the check box if you also want to rename the folder on the server. When finished, tap OK.

POP accounts



IMAP accounts

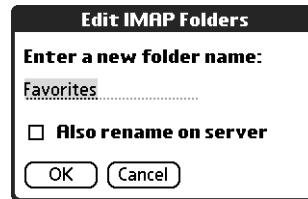

- To delete a folder, tap the folder name from the list on the screen, and then tap Delete. For IMAP accounts only, select the check box if you also want to delete the folder on the server, and then tap OK. For POP accounts, the folder will be deleted immediately, and you will not see a confirmation screen.



Delete confirmation appears for IMAP accounts only

## Creating and sending new e-mail

When you create a new e-mail message, you can enter the person's e-mail address or use the Lookup screen to find a particular address.

To create a new e-mail message:

1. Tap New.

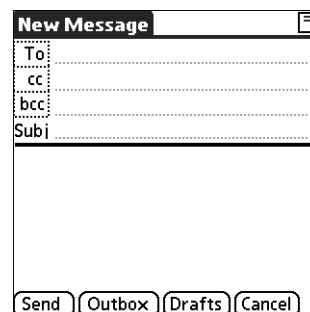
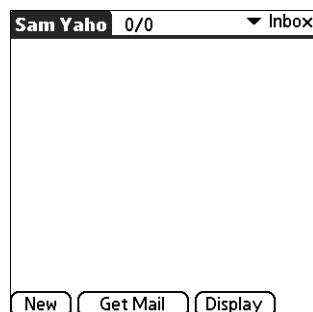

2. Enter the recipient's name using one of the methods described in the next procedures.



**NOTE** When you address a message to several recipients, you do not see all the recipients on the To list because the list is truncated on the To line. If you tap the To field, a dialog box shows all recipients for the current message.

### Addressing a message by typing the address

You can address a message by entering the complete address.

To enter the address:

1. On the New Message screen, tap or navigate to the To field and enter the address, and then tap Done.



For multiple recipients, type a semicolon (;) and then a space between recipient names. The To field expands to two lines during address entry for addresses longer than the one-line display.

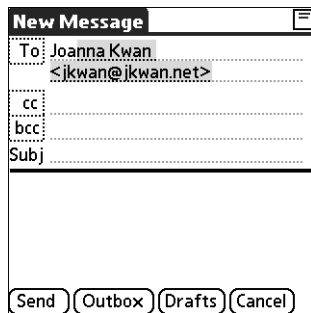

After address entry, addresses longer than one line are shown on a single line with a red ellipsis symbol to the right of the address line.

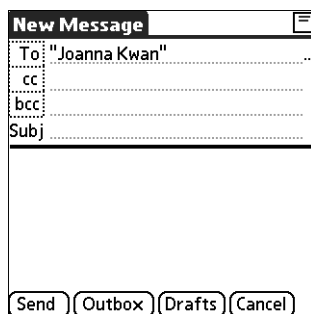

Red ellipsis indicates address is longer than one line

Alternately, on the New Message screen, tap To and enter the address on the Recipient List screen, and then tap Done. Use the shortcut buttons at the bottom of the screen for quick address entry.

For multiple recipients, type a semicolon (;) or tap the semicolon button at the bottom of the screen, and then type a space between recipient names.



**NOTE** If you enter a comma instead of a semicolon, it is automatically changed to a semicolon. If you enter a space with no punctuation between names, semicolons are not inserted, and the e-mail message is improperly addressed.

If you want to edit an e-mail address that is longer than the line provided on the New Message screen, tap the To field and edit the address.

2. To send copies, tap cc: or bcc: and then enter the recipient's address.

Copies (cc:) allow recipients to see the addresses of the other recipients; addresses in the blind copies (bcc:) field are hidden from all other recipients.

**TIP** To automatically fill in the address as you type, see ["Using Smart Addressing to address a message"](#) later in this chapter.

### Addressing a message using Contacts

You can enter a recipient's address by using the Lookup screen to select the address. The names and addresses on the Lookup screen come from Contacts.

#### To use an address from Contacts:

1. On the New Message screen, tap the word To.
2. On the Recipient List screen, tap Lookup.

3. On the Address Lookup screen, tap the address you want, and then tap Add.

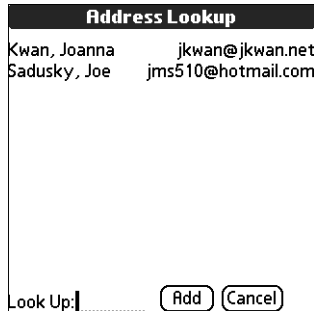

4. (Optional) Repeat steps 2 and 3 for each address you want to add.
5. To enter an address in the cc: or bcc: field, tap the field name and follow the steps given for the To field.

### Using Smart Addressing to address a message

Smart Addressing completes a recognized e-mail address. Smart Addressing automatically fills in fields when the recipient's name and e-mail address are in your Contacts list.

By default, Smart Addressing is selected in VersaMail Preferences.

#### To use Smart Addressing to address a message:

1. On the New Message screen, tap in the To field.
2. Start entering the person's name, such as Joe Smith.

Once the name is recognized from your Contacts list, the name and e-mail address are automatically completed on the recipient list. For example, if you have a Joe Smith and a Joan Smith in Contacts (and no other names starting with J), once you type "Joe," the entry "Joe Smith" is completed with the correct e-mail address.

3. If Smart Addressing recognizes more than one name for the typed entry, or if the recognized name has more than one e-mail address associated with it, all the names or e-mail addresses are displayed. Continue typing until only the name or e-mail address you want is displayed, or navigate or tap to select the name or e-mail address you want.

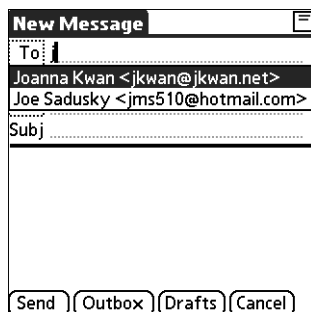

4. Tap Done.

### Turning Smart Addressing on or off

You can turn Smart Addressing on or off in VersaMail Preferences. By default, Smart Addressing is turned on.

To turn Smart Addressing on or off in VersaMail Preferences:

1. Tap the Menu icon , tap Options, and then tap Preferences.
2. Tap Advanced.

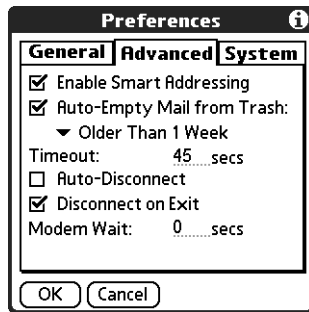

3. Tap the Enable Smart Addressing check box if it is not selected. A checkmark means it is turned on.
4. Tap OK.

### Composing and sending e-mail

After you enter your recipient addresses, you can compose the rest of the e-mail message.

To compose the rest of the e-mail and send it:

1. Tap the Subject field and enter the subject of your e-mail.

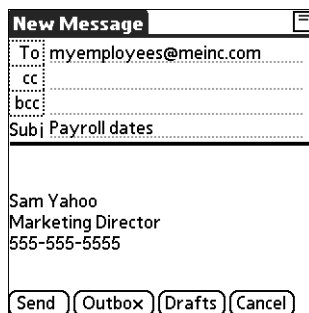

Subjects longer than one line are shown on a single line with a red ellipsis symbol to the right of the subject line.

2. Tap the area below the Subject line, and then enter the text of your e-mail.

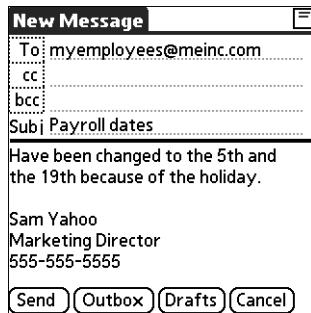

To access the editing features available on the Edit menu, tap the Menu icon . The first character of each sentence is automatically capitalized for you.

3. (Optional) Tap the Options menu, and then select Add Attachments. See [“Attaching files from a handheld application”](#) later in this chapter.
4. Tap one of the following to send the e-mail:

- Send** Sends the e-mail immediately.
- Outbox** Stores e-mail in the Outbox so you can compose e-mail offline and then send all e-mail during one connection with the server. To send your e-mail later, tap Get & Send. A connection is made to the mail server and all the e-mail in the Outbox is delivered.

**TIP** You can also tap Drafts to save this message in the Drafts folder rather than send it.

### Send retry

When you tap Send on the message menu, the VersaMail application automatically attempts to send the message. If the send attempt fails for any reason (for example, your handheld is out of range, or the application cannot connect to the mail server), you can choose to have the application move the message to the Outbox and continue to try to send the message at 30-minute intervals, a maximum of three times.

If you put a message in the Outbox, you must perform a manual send to send the message on the first attempt. The VersaMail application attempts automatic send retry only after a manual send attempt fails.

If automatic send retry succeeds on any attempt, the message is moved to the Sent folder.

**NOTE** Automatic send retry occurs only if you tap Send to send the message manually. It does not work if you tap Get & Send.

**To select automatic send retry:**

- Tap Yes in the dialog box notifying you that manual send has failed.

**NOTE** Automatic send retry is not supported for VPN or SSL connections, or for accounts for which your ISP requires you to log in to the mail server before sending mail. It is also not supported if you have configured the security preferences on your handheld to encrypt databases on the handheld.

**Send retry notifications**

If automatic send retry fails after the third attempt, a notification appears on the Reminders screen. A separate notification appears for each e-mail account for which a send retry has failed.

**NOTE** You can choose to disable notifications for send retry failures. See [“Setting notification options”](#) earlier in this chapter for instructions.

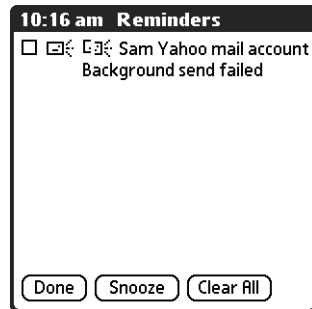

**NOTE** A broken envelope icon  appears next to a notification when an automatic send retry fails.

Tap the notification or open the account in the VersaMail application to view a detailed error message.

Viewing the error message deletes the notification from the Reminders screen. The Reminders screen shows only the most recent notification for an e-mail account, no matter how many automatic send retries have been attempted for that account.

If automatic send retry fails after the third attempt, you must send the message manually.

**NOTE** If you perform a soft reset or a HotSync operation during automatic send retry, the retry cancels. You must manually send any messages in the Outbox after the soft reset.

### Modifying messages in the Outbox

A message in the Outbox waiting for the next automatic send retry can be edited, moved, or deleted. However, if you edit the message, you will need to perform a manual send in order to send the message. If the manual send fails, you can choose to store the message in the Outbox to await the next automatic send retry.

During automatic send retry, any message that the VersaMail application is attempting to send is in a locked state and cannot be edited, moved, or deleted. If you try to modify a message in the locked state, an error message appears.

If a send retry fails after the third attempt, the message is stored in the Outbox in the error state. You can send the message again manually, or edit, move, or delete the message. However, if you edit the message, you will need to perform a manual send in order to send the message. If the manual send fails, you can choose to store the message in the Outbox to await the next automatic send retry.

See the next section, “[Outbox icons in the VersaMail applications](#),” for icons that indicate messages awaiting the next automatic send retry as well as messages in the locked and error state.

### Outbox icons in the VersaMail applications

The icons to the left of a message in the Outbox indicate the message’s status.



Message is waiting either to be manually sent or to be sent during the next send retry. You can edit, move, or delete a message in this state.



Send retry is currently in process; you cannot edit, move, or delete a message in this state.



Third automatic send retry has failed. You must manually send a message in this state by tapping Get & Send.

### Completing drafts

If you are composing an e-mail message and you exit the VersaMail application before tapping Outbox, Send, or Cancel, the e-mail automatically moves to the Drafts folder. To finish editing the e-mail, tap the folders pick list, and then select Drafts. Select the e-mail you want to complete or edit, and then tap Edit. You can also delete the e-mail in the Drafts folder.

### Attaching a personal signature

You can include a personal signature, such as your name, e-mail address, and telephone number, with each e-mail you send.

**To create a personal signature:**

1. Tap the Menu icon , tap Options, and then tap Preferences.
2. Tap Signature.

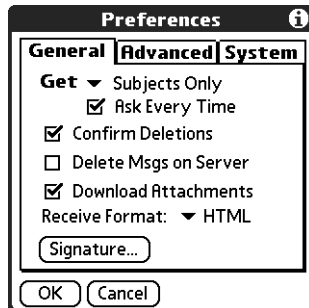

3. Tap the Attach Signature check box to select it.



4. Enter your signature information, and then tap OK.

**Forwarding e-mail**

You can quickly forward e-mail messages from any folder other than the Outbox folder.

**To forward e-mail:**

1. Tap the folders pick list, and then select the folder that contains the e-mail.
2. Tap the e-mail message to display it.
3. Tap the Forward button.



Tap Forward



4. Tap the word To.
5. On the Recipient List screen, enter or look up the recipient address. See the procedure for creating new e-mail earlier in this chapter for more information on addressing messages.

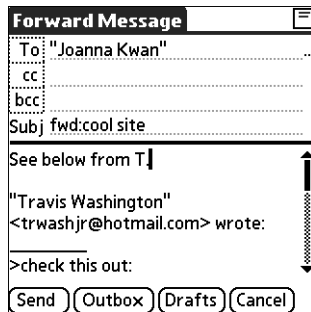

6. (Optional) Enter some text describing the forwarded message.
7. Tap Send to send the message, or tap Outbox to store it in the Outbox.

**NOTE** Forwarded messages are always sent as text only, even if you received the original message in HTML format.

### Replying to e-mail

You can reply to an e-mail message as you are reading it, or start the reply when viewing messages in the folders list view.

**To reply to an e-mail message that you are reading:**

1. Tap the message you want to reply to.
2. Tap Reply.

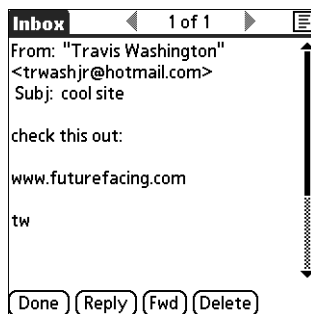

- In the Reply Options dialog box, select options for replying to the sender only or to all e-mail recipients, and for including original message text.

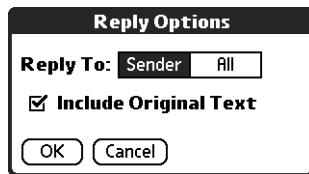

- Tap OK.
- Enter a reply.

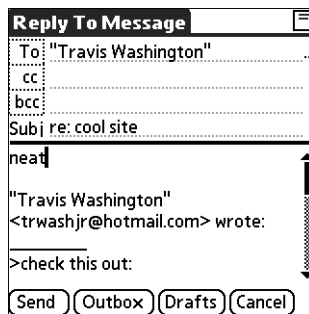

- Tap Send to send the message now, or tap Outbox to send it later.

**NOTE** Replies are always sent as text only, even if you received the original message in HTML format.

**To reply to an e-mail message from the folders list:**



- On the message screen, tap the folder name in the upper-left corner to open the message menu, and then press Right on the navigator to move to and open the Options menu.
- Press Down on the navigator to move to the Reply option, and then press Select to select this option.

**TIP** Alternately, you can tap the folders pick list, select the folder that contains the e-mail, tap the envelope icon next to the message, and then tap Reply on the pick list.

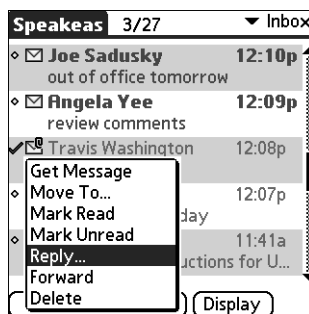

- In the Reply Options dialog box, select options for replying to the sender only or to all e-mail recipients, and for including original message text.

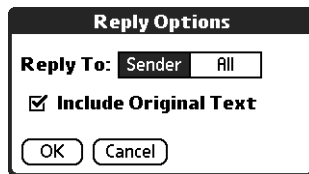

- Tap OK. The e-mail is addressed.
- Enter a reply.

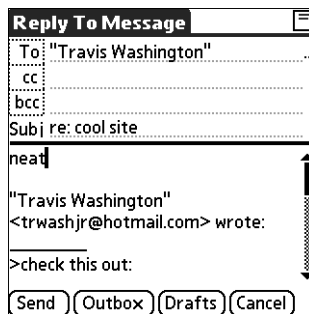

- Tap Send to send the message now, or tap Outbox to send it later.

**NOTE** Replies are always sent as text only, even if you received the original message in HTML format.

## Working with URLs

You can tap a URL in a received message to view the web page or file associated with the URL. Tapping the URL opens Palm™ Web Browser Pro to view the page or file.

You can also tap an embedded e-mail address to open a new message screen with the address in the To field.

Depending on whether the received message is displayed in HTML or plain text format, URLs and e-mail addresses appear in slightly different forms, as follows:

- HTML** URLs and e-mail addresses appear as blue underlined text.
- Plain text** URLs appear as any text beginning with “http://” or “www.” You cannot view the page or file associated with a URL that does not begin with “http://” or “www” in a plain text message.
- E-mail addresses appear in the form “username@mailservice.com” (or other three-letter extension such as .net, .org, and so on).

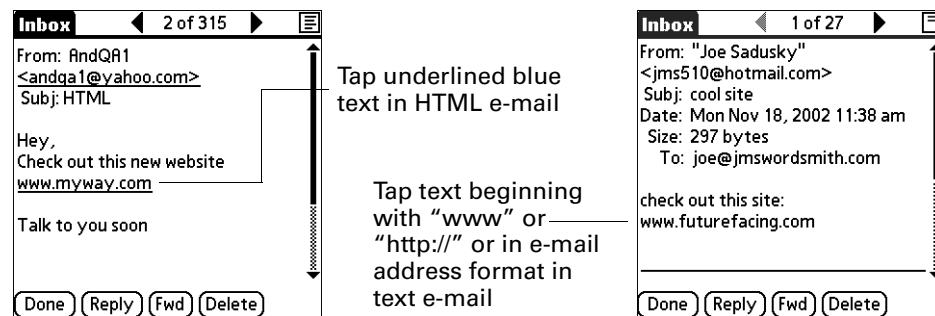

## Working with attachments

You can easily download, view, and send attachments with e-mail messages.

### Downloading attachments to your handheld

E-mail may contain attached files, such as Microsoft Word or text files, that you want to view or install on your handheld. When you receive an e-mail message with an attached file, the VersaMail application automatically scans your handheld to see if an application resides on the handheld that can open the attachment. If the VersaMail application detects such an application, the attachment automatically opens in the appropriate application.

The types of attached files you can download and work with include the following:

- vCard (.vcf)** This is contact information.
- vCal/iCal (.vcs or .ics)** This is usually a calendar appointment or a task.
- Text (.txt)** This is usually a memo or another plain text file.
- HTML (.html or .htm)** This is usually a web page or a formatted text file. Your handheld displays HTML attachments with full formatting intact.

<b>Microsoft Word (.doc)</b>	Automatically opens in the Word To Go application on your handheld. You can view and edit the document in the same way that you could using the Word application on your desktop.
<b>Microsoft Excel (.xls)</b>	Automatically opens in the Sheets To Go application on your handheld. You can view and edit the spreadsheet in the same way that you could using the Excel application on your desktop.
<b>Graphics files (.jpg, .bmp, .tif, .gif)</b>	You can download these files and view them using the Palm™ Photos application on your handheld.
<b>Other application files</b>	For other types of application files, your handheld may contain a viewer that allows other applications to pass it a file for viewing. You do not need to do anything different in the steps for downloading and viewing attachments; if your handheld contains such a viewer, the attachment is automatically opened. If your handheld does not contain such a viewer, you cannot view the attachment. Among the file types that may be supported are MP3 and AAC files.
<b>PRC (.prc)</b>	This is a Palm OS® application that you can install and run on your handheld.
<b>PDB (.pdb)</b>	This is a file that works with specific Palm OS applications.
<b>ZIP (.zip)</b>	These are compressed files that contain other types of files, for example, text files or Word docs. You can download and uncompress (“unzip”) a Zip file and then view the contents on your handheld.

Among the types of attachments you can receive are the following handheld application files:

- Contacts entries
- Calendar appointments
- Tasks list items
- Text memos

You can also save downloaded files to an expansion card. See [“Saving attachments to an expansion card”](#) later in this chapter for information.

**NOTE** The maximum message size that you can retrieve is 60KB for the body text and approximately 5MB of total data for any attachments. If the attachment is too large, it cannot be downloaded to the handheld. Because downloading large messages can consume handheld resources, the VersaMail application displays the size of and asks if you want to continue downloading any message that exceeds your maximum message size, up to a total size of 5MB.

**To download an attachment:**

1. In the Inbox, tap the message with the attachment.

A paper clip icon appears on the message's icon if the message has an attachment that has been downloaded.

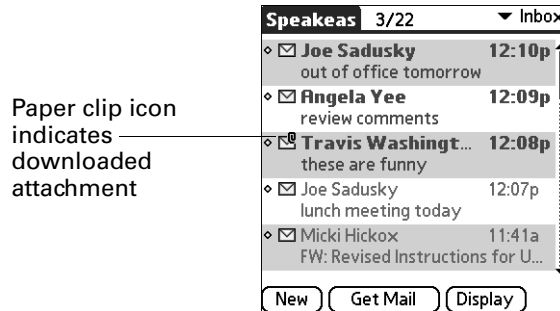

If you choose to get messages by subject only, you must tap More for each downloaded message in order to view the body of the e-mail message plus any attachments, up to the maximum message size. If the downloaded message (either body text alone or body text plus any attachments) exceeds your maximum message size, you see a message showing that the message and/or attachments were too large and asking if you would like to continue downloading them.

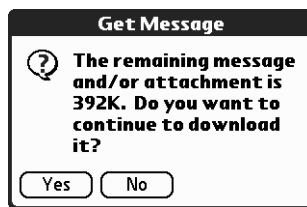

For example, if the maximum message size is 5KB and you download a body of 2KB, then any attachment under 3KB is also downloaded, and any attachment over 3KB is not. See [“Downloading large attachments”](#) later in this chapter.

2. Tap the red paper clip icon in the upper-right corner. If the attachment is not downloaded, a paper clip icon will not appear even though the message was sent with an attachment. You must download the attachment for the paper clip icon to appear.

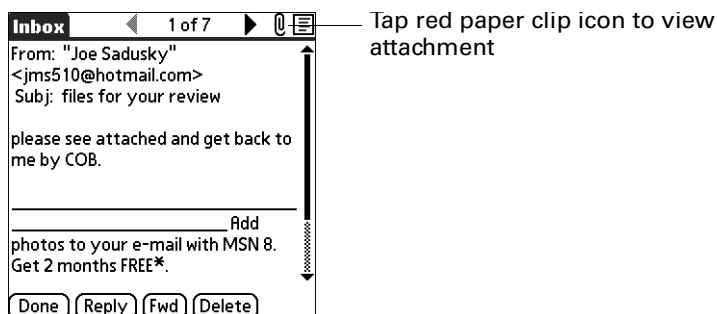

3. Your options for working with a downloaded attachment vary according to the file type.

Type	Action
Viewable file: text, Word doc, task, HTML, graphic, and so on	Tap the name of the attachment you want to view, and then tap View. If there are multiple viewers registered on your handheld for the attachment file type, either use the default viewer shown, or select a viewer from the list. For example, if you have two photo viewing applications on your handheld and you select a photo attachment on the list, the Viewer pick list appears containing the names of the photo viewing applications. Tap the pick list, and then select the application you want to use to view the photo attachment. If there is only one viewer registered for the attachment file type, the viewer is shown without a list.
Palm OS application or database file (.prc or .pdb)	Tap the name of the attachment you want, and then tap Install. The file is installed automatically.
Compressed Zip file	Tap the name of the attachment you want, and then tap Unzip. The file uncompresses, and the files it contains are listed. Tap the name of the file you want to view or install, and then tap View or Install.

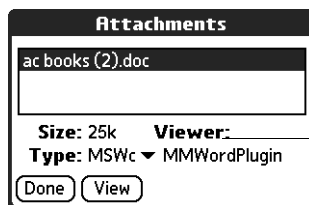

Viewer pick list is displayed only if handheld has multiple viewers registered for attachment file type

Button displays View, Install, or Unzip, depending on the attachment file type

4. When you have finished viewing or installing the attachment, tap Done. This returns you to the Attachments dialog box, where you can select another attachment if you want to.

If there is no Done button on the attachment screen, tap the VersaMail icon  on the Home screen to return to the Inbox of the account you were in.

5. When you have finished viewing or installing all attachments, tap Done on the Attachments dialog box. This returns you to the Message screen.

### Downloading large attachments

Downloading and viewing a message with a single attachment that exceeds your maximum message size, or a message with multiple attachments whose total size exceeds your maximum message size, requires some extra steps.

To determine if a message has an attachment or multiple attachments that exceed the maximum message size:

- In the Inbox, tap the message title.



More button indicates that message plus any attachments exceeds maximum message size

If the message plus attachments exceeds the maximum message size, the More button  appears on the Message screen. In the case of multiple attachments, if some of the attachments were downloaded completely, you see both the red paper clip icon (indicating fully downloaded attachments) and the More button (indicating incompletely downloaded attachments).

To download a single attachment that exceeds the maximum message size:

1. Tap the More button.



Tap More

2. Tap Yes to continue downloading the entire message with attachment.

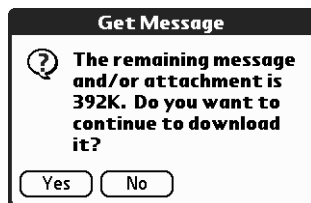



When downloading is complete, the red paper clip icon appears and the More button is no longer displayed. Follow the procedure for viewing an attachment presented earlier in this chapter.

**To download multiple attachments whose total size exceeds the maximum message size:**

1. Tap the red paper clip icon.

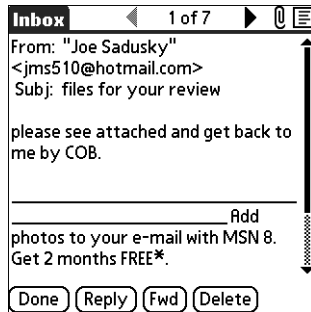

2. Select one of the following:

- To view any fully downloaded attachments without continuing to download additional attachments, tap No. Follow the procedure for viewing an attachment presented earlier in this chapter.
- To continue downloading all messages, tap Yes.

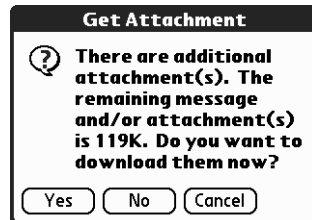

When downloading is complete, the Attachments dialog box appears, showing all downloaded messages. Follow the procedure for viewing an attachment presented earlier in this chapter.

### Saving attachments to an expansion card

If you have purchased an expansion card that provides extra memory, you can save downloaded attachments to the expansion card.

**To save an attachment to an expansion card:**

1. Insert the expansion card into the slot on your handheld.
2. Follow the procedure for downloading attachments described earlier in this chapter.

3. On the Attachments screen, select the attachment you want to save, and then tap Save To Card.

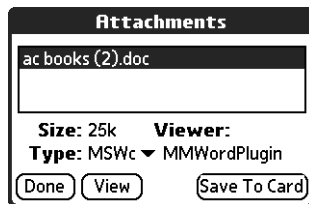

4. Tap OK.

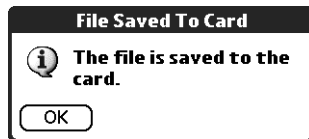

5. Repeat steps 3 and 4 for each attachment you want to save.

### Attaching files from a handheld application

You can attach files on your handheld to e-mail messages you send. For example, you can attach files from the various handheld applications, such as a Calendar appointment (.vcs/.ics), tasks in the Tasks application (.vcs/.ics), or text memos (.txt).

**NOTE** The maximum size message you can send is 60KB for the body text and approximately 5MB of total data for any attachments. The maximum number of attachments for any e-mail message is ten, regardless of the attachments' total size.

You can attach the following types of files from a handheld application:

- vCard (.vcf)
- vCal/iCal (.vcs/.ics)
- Memo/Text (.txt)
- PRC (.prc)
- PDB (.pdb)
- Microsoft Word document (.doc)
- Microsoft Excel spreadsheet (.xls)

**To attach a file from a handheld application:**

1. Tap the Menu icon , tap Options, and then tap Attachment.
2. Tap the Type pick list, and then select the file type. The VersaMail application displays all file types that reside on your handheld that you are able to attach to an e-mail message.

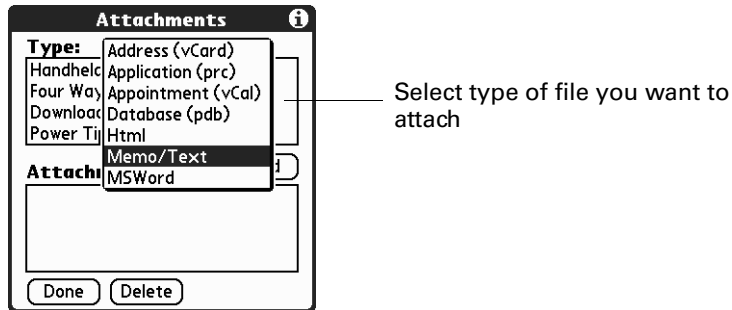

All files of the selected type appear in the Type box. For example, if you select Appointments (vCal/iCal), tap Calendar to see a list of appointments from a particular date that you can attach, or tap Tasks to see tasks.

3. Tap the file that you want to attach, and then tap Add.

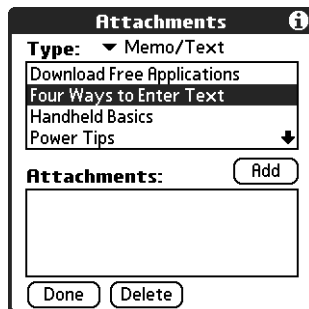

The selected file appears in the Attachments box.

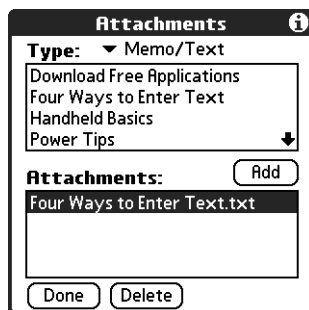

- Repeat steps 2 and 3 for each attachment you want to add, and then tap Done.

**TIP** To delete an attachment from an e-mail message, tap the attached file in the Attachments box, and then tap Delete.

- Tap Send or Outbox.

### Attaching files from an expansion card

If you have purchased an expansion card and have saved files to the card, you can attach files from the card to an e-mail message you are sending. The types of files you can attach from an expansion card include the following:

- Word docs
- HTML files
- JPEG and GIF graphics files
- MP3 and WAV audio files
- Any other file type

To attach a file from an expansion card:

- Insert the expansion card into the slot on your handheld.
- On the New Message screen, tap the Menu icon , tap Options, and then tap Attachment.
- Tap the From pick list, and then select Files on Card.

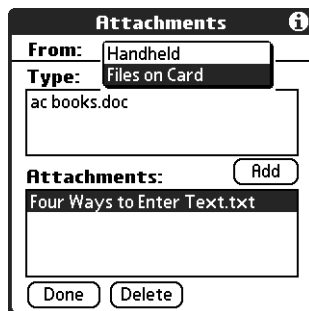

4. Tap the Type pick list, and then select the file type. The VersaMail application displays all file types that reside on the card. You can select a particular file type, or select All Files to view all files on the card.

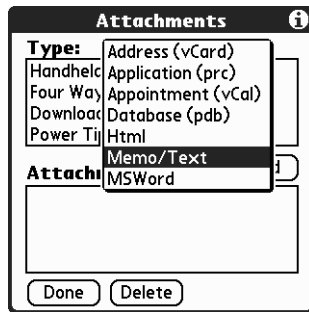

5. Tap the file that you want to attach, and then tap Add.

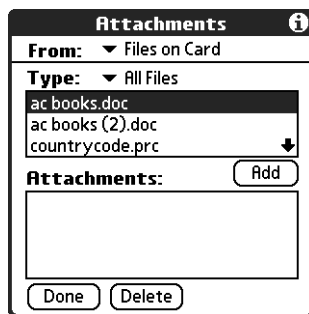

The selected file appears in the Attachments box.

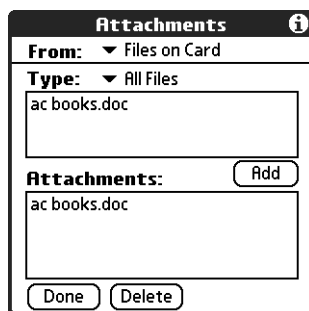

6. Repeat steps 6 and 7 for each attachment you want to add, and then tap Done.

**TIP** To delete an attachment from an e-mail message, tap the attached file in the Attachments box and then tap Delete.

7. Tap Send or Outbox.

### Forwarding an attachment

You can include an attachment on any message you forward, up to the maximum message size.

#### To forward a message with an attachment:

1. Tap the folders pick list, and then select the folder that contains the e-mail.
2. Tap the e-mail message to display it.
3. Tap the Forward button.
4. Tap the word To. On the Recipient List screen, enter or look up the recipient address. See the procedure for creating e-mail earlier in this chapter for more information on addressing messages.
5. Follow the procedure for attaching files presented earlier in this chapter.

### Deleting messages

You can delete one or more e-mail messages from any folder. For example, you can delete old messages in the Inbox or messages that you were working on in the Drafts folder. When you delete a message, it is placed in the Trash folder. See [“Emptying the trash”](#) later in this chapter.

To delete messages on the server when you empty the trash on your handheld, you can select the Delete Msgs on Server setting in VersaMail Preferences. If you don't periodically empty the trash and delete messages on the server, any incoming e-mail may “bounce” back to the sender. See [“Setting preferences for getting and deleting e-mail”](#) later in this chapter.

#### To delete one or more messages:

1. Tap the folders pick list, and then select the folder that contains the message you want to delete.
2. Do one of the following:

Item to delete	Action
One message	Tap the bullet next to the message's icon.
Multiple messages	Tap the bullet next to the icon of each message that you want to delete.
A group of adjacent messages	Drag the stylus along the left of the message icons. To select another group, lift the stylus and select the next group of messages.

3. Press Right on the navigator to move to and open the Message menu.

4. Press Down on the navigator to move to the Delete option, and then press Select to delete the message.

**TIP** Alternately, you can tap the message icon next to a selected e-mail message, and then tap Delete, or tap the Menu icon , and then select Delete.

5. Tap OK.
6. (Optional) Tap Also delete message(s) on server if you want to delete the messages from the server now.

The selected messages move to the Trash folder and are deleted from your handheld when you empty the trash. You can empty the trash manually, or set the preference to automatically empty the trash. By default, the trash auto-empties all deleted e-mail older than one week. See [“Emptying the trash”](#) later in this chapter for more information.

---

**IMPORTANT** If you delete a message on the server, you cannot retrieve it and view it again later.

---

#### To delete messages before a certain date:

1. Tap the Menu icon , and then tap Delete Old from the Message menu.
2. Tap the Folder pick list, and then select the folder that contains the messages you want to delete.

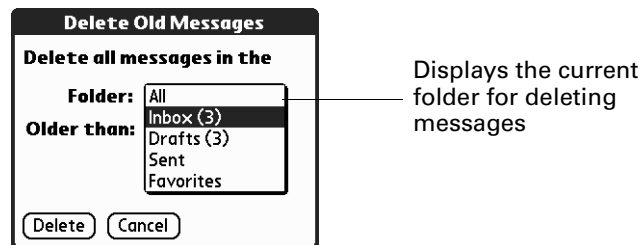

3. Tap the Older than pick list, and then tap One Week, One Month, or Choose Date.



If you tap Choose Date, you can select a date from the calendar.

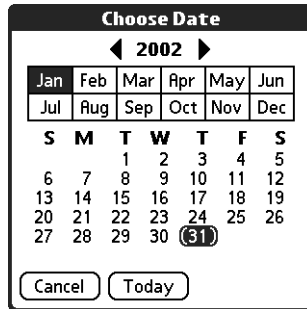

Tap a date to select it,  
or tap Today

4. Tap Delete.
5. (Optional) Tap Also delete message(s) on server if you want to delete the message from the server now.



6. Tap OK.

## Emptying the trash

Deleted e-mail accumulates in the Trash folder and takes up space on your handheld. To increase memory, you should empty the trash regularly. If you want to automatically empty the trash, you can set a preference to empty the trash immediately or empty any e-mail older than a certain number of days.

**To empty the trash:**

1. Tap the Menu icon , and then select Empty Trash from the Message menu.

**NOTE** If Auto-Empty Mail from Trash is selected in VersaMail Preferences, a message asks if you want to delete the trash.

2. (Optional) Tap Details to see how many messages are in the trash and whether the messages are set to be deleted on the server.
3. If you want to delete messages from the handheld as well as from the server, tap Both. A message asks if you want to update the server now.

To delete the message from only the handheld now, tap Handheld.

**NOTE** Many e-mail providers, such as Yahoo, have size restrictions for mail storage. If your mailbox on the server becomes full, messages are returned to the senders.



**To have the trash emptied automatically:**

1. Tap the Menu icon , select Options, and then select Preferences.
2. Tap Advanced.

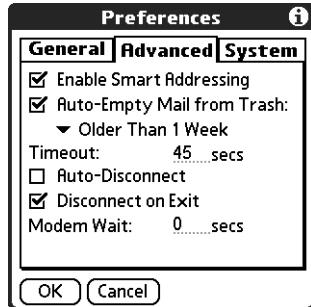

By default, Auto-Empty Mail from Trash is selected, and the time interval is set at Older Than 1 Week.

3. Tap the pick list, and then select how often you want the e-mail messages automatically emptied from the trash.
  - Immediately
  - Older Than 1 Day
  - Older Than 3 Days
  - Older Than 1 Week
  - Older Than 1 Month
4. Tap OK.

## Marking messages as read or unread

You can mark messages as read or unread. When you tap a message to read it, it is automatically marked as read.

**To mark messages as read or unread:**

1. Tap the folders pick list, and then select the folder you want.
2. Tap the icon next to the message you want to mark.

3. Tap Mark Read or tap Mark Unread.

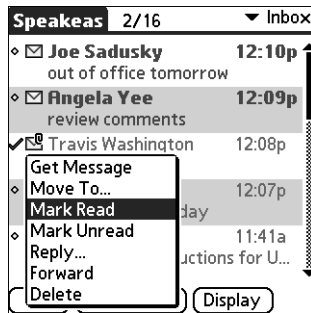

**TIP** To mark multiple messages, tap the bullets next to the messages you want, tap the Menu icon , and then select Mark Read or Mark Unread.



4. For IMAP accounts only: Tap Handheld to mark the messages as read or unread on your handheld. Tap Both to mark the messages on both the handheld and the server.



If you tap Both, this screen appears.



- Tap OK to connect with the server and immediately mark the messages as read or unread on the server. This action also processes any other pending actions on the server, such as messages not yet deleted.

- Tap Cancel if you want the messages marked during the next HotSync operation or the next time you connect to the server.

**NOTE** Because POP servers do not support the read or unread message feature, the message is in bold or regular typeface for POP accounts on the handheld, but you can't connect with the server to change the message state.

Read messages appear in plain text; unread messages appear in bold text.

## Setting preferences for getting and deleting e-mail

VersaMail Preferences determine how the VersaMail application gets, sends, and deletes e-mail.

To set e-mail preferences:

1. Tap the Menu icon , tap Options, and then select Preferences.

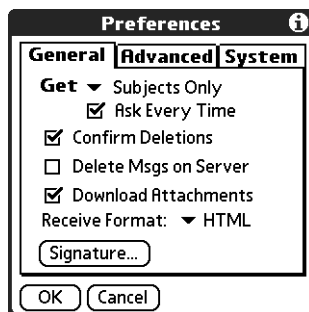

2. Select preferences:

<b>Get</b>	Enables you to retrieve the subject only or the entire message.
<b>Ask Every Time</b>	Displays a dialog box for choosing subjects only or entire messages each time you retrieve e-mail. If it is deselected, messages are retrieved according to the option you select in the Get pick list.
<b>Confirm Deletions</b>	Displays a confirmation dialog before deleting e-mail.
<b>Delete Msgs on Server</b>	If this is selected, it automatically deletes messages on the server that you have deleted on your handheld. If it is deselected, you will be asked each time you delete messages on your handheld whether you want to also delete them on the server. Because mailboxes on the server usually have size restrictions, we recommend periodically deleting messages on the server.

<b>Download Attachments</b>	Causes files attached to e-mail to be automatically downloaded to your handheld. Attachments that exceed the maximum message size cannot be downloaded. See <a href="#">“Working with attachments”</a> earlier in this chapter for more information.
<b>Receive Format</b>	Enables you to retrieve messages in HTML format or in plain text format. If you choose HTML, any messages sent to you in HTML format will be displayed with basic HTML formatting intact. Other messages will be displayed as plain text. If you choose Plain Text, all messages will be displayed as plain text, regardless of the format in which they were sent. Default setting is HTML.  See <a href="#">“Working with URLs”</a> earlier in this chapter for more information on receiving e-mail in HTML format.
<b>Signature</b>	Enables you to attach a default signature to all your outgoing messages. See <a href="#">“Attaching a personal signature”</a> earlier in this chapter for more information.

## Adding or updating a Contacts record directly from a message

You can add or update an e-mail address in Contacts directly from the body of a received e-mail message.

### To add a new Contacts record:

1. On the Message screen, tap the Menu icon , tap Options, and then select Add to Contacts.

A dialog box appears with the “From” address displayed. If a Display Name exists for this Contacts record, the Last name and First name fields show the display name.

2. (Optional) If the Last name and First name fields are blank, enter the first and last name associated with the “From” e-mail address.
3. Tap OK to add the e-mail address to Contacts, and then tap OK in the confirmation dialog box.

You can also update an existing Contacts record with a new e-mail address, or create a second Contacts record for a name that has an existing record. The procedure is the same as for adding a new Contacts record. If you tap Add to Contacts from the body of an e-mail message and a record already exists for the recipient name, you are prompted either to update the e-mail address for the recipient or to create a new record for the recipient.

## Synchronizing e-mail between the handheld and the desktop

**IMPORTANT** You must have a Windows computer to synchronize e-mail between your handheld and your computer.

To manage your e-mail on your desktop as well as on your handheld, you can synchronize an e-mail account on the handheld with an e-mail application on the desktop. You can use many popular e-mail applications, called *clients*, such as Microsoft Outlook, Eudora, Lotus Notes, Outlook Express, or any other e-mail clients that use MAPI.

### Configuring account settings in HotSync Manager

Before synchronizing an e-mail account, you configure the account's settings in the Palm VersaMail HotSync Conduit. The settings have to be specified only once unless you need to make changes.

To start Palm VersaMail HotSync Conduit:

1. Click the HotSync Manager icon  in the Windows system tray.
2. Select Custom.
3. Select VersaMail in the Conduit list.
4. Click Change.
5. Select Synchronize Active Accounts.

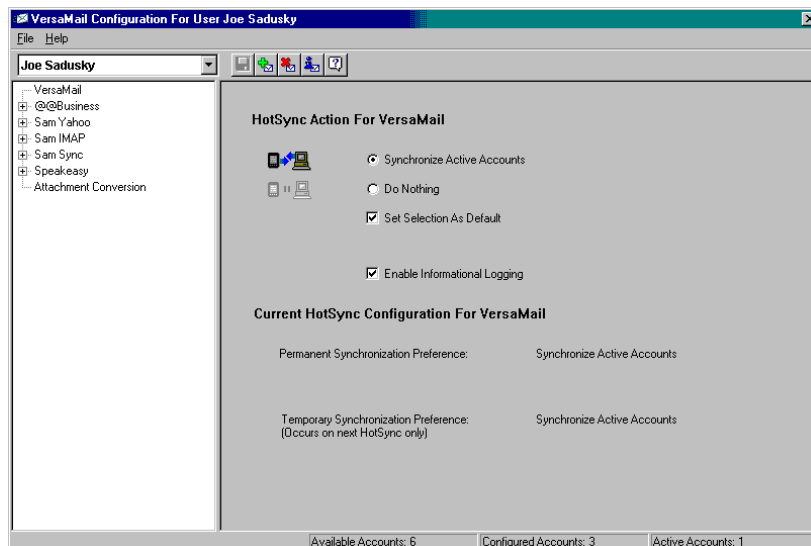

6. (Optional) Select the check box Enable Informational Logging if you want the HotSync log to record information, such as errors encountered, about the conduit during a HotSync operation.
7. (Optional) Select the check box Set Selection As Default to make the current settings the default settings for all accounts.

## Setting synchronization options and account settings

Next, you must configure each e-mail account's general synchronization settings. For example, if you created an Earthlink e-mail account on the handheld and want to synchronize that with the desktop, set the synchronization options for the Earthlink account. During a HotSync operation, the Earthlink account on the handheld and the e-mail application specified in the conduit are synchronized.

**To configure an account and set the synchronization options:**

1. On the VersaMail Configuration For User screen, click the plus sign to the left of the account you want to configure.

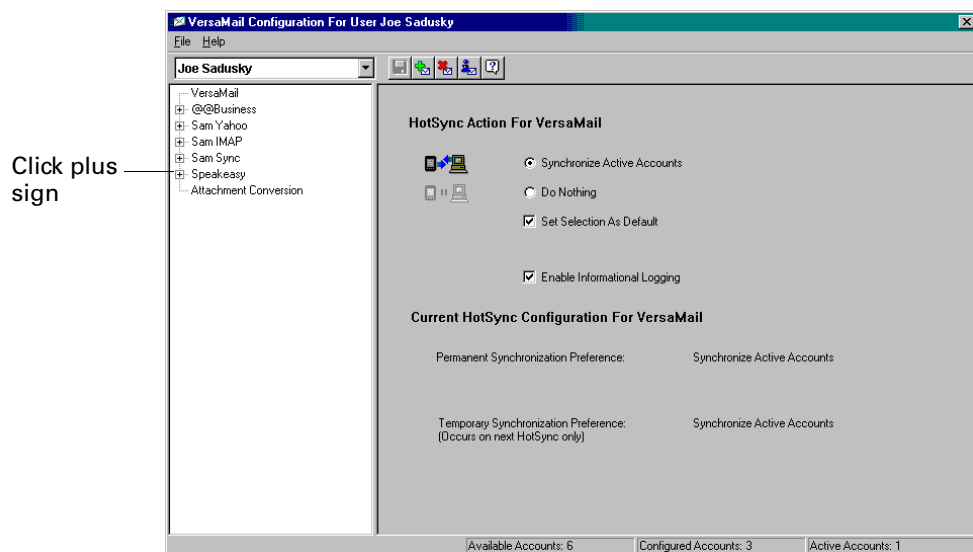

- Under the account name, click Mail Client Sync Setup.

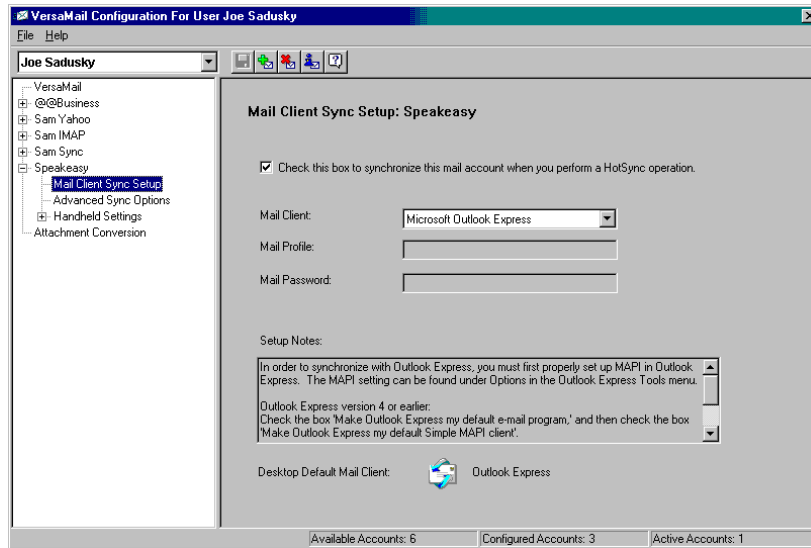

- Select the option Check this box to synchronize this mail account when you perform a HotSync operation; otherwise, the account cannot be synchronized.
- Click the Mail Client pick list and select the desktop e-mail application you will use to synchronize the selected account with your handheld. For each application, additional setup information is displayed in the Setup Notes box. See the following table for additional setup information for each client.

**TIP** If your e-mail application is compatible with Extended MAPI, try Microsoft Exchange 5.0 or later as a choice for the Mail Client option. If your e-mail application is compatible with Simple MAPI (SMAPI), try Microsoft Outlook Express as a choice for the Mail Client option. Although Netscape uses SMAPI, Netscape is not supported.

(Optional) If prompted, enter profile and password information for the client you selected.

---

**IMPORTANT** You must select the synchronize check box and select a mail client in order to synchronize the account between your desktop and your handheld.

---

<b>Mail Client</b>	<b>Action</b>
Microsoft Exchange 5.0 or later	Select a MAPI profile to access the mail server. The conduit displays any existing MAPI profiles in the list. Enter your password for Exchange.
Microsoft Outlook 97 or later	<p>Select the MAPI profile to access the mail server. The conduit checks for any existing MAPI profiles and displays them in the list. Enter your password for Outlook.</p> <p>To synchronize Microsoft Outlook 97/98/2000/XP with a VersaMail e-mail account, you must set Microsoft Outlook as the default e-mail handler. You must check your username and password.</p> <p>To configure Microsoft Outlook:</p> <ol style="list-style-type: none"><li>1. In the Control Panel, click Internet Options.</li><li>2. For Windows XP, click Network and Internet Connections, and then click Internet Options.</li><li>3. Click the Programs tab.</li><li>4. Select Microsoft Outlook as the default e-mail program.</li><li>5. Click OK.</li></ol> <p><b>NOTE</b> Make sure your username and password are set up correctly within Microsoft Outlook.</p>
Microsoft Outlook Express 5.5 or later	<p>If you select Microsoft Outlook Express, enter the password for your e-mail account.</p> <p>To synchronize a VersaMail e-mail account with Microsoft Outlook Express 5.5 or 6.0, you must set Outlook Express as the default e-mail handler.</p> <p><b>NOTE</b> Make sure your username and password are set up correctly within Outlook Express.</p> <p>To configure Outlook Express:</p> <ol style="list-style-type: none"><li>1. In the Control Panel, click Internet Options.</li></ol> <p><b>NOTE</b> For Windows XP, click Network and Internet Connections, and then click Internet Options.</p> <ol style="list-style-type: none"><li>2. Click the Programs tab.</li><li>3. Select Outlook Express as the default e-mail program.</li><li>4. Click OK.</li></ol> <p><b>TIP</b> You can also make Outlook Express the default e-mail handler within the e-mail application. From the Tools menu, select Options. Click the General tab, and then click Make Default.</p>



<b>Mail Client</b>	<b>Action</b>
Lotus Notes	<p>Enter your Lotus Notes ID and password. Click Browse if you need to locate your Notes ID.</p> <p>If you want to synchronize to a local mail file instead of a server mail file, select the Synchronize to local (replicated) mail file check box. You must do all of the following in order to synchronize to a local mail file:</p> <ul style="list-style-type: none"><li>■ Replicate the server mail file to the desktop.</li><li>■ Make sure the replicated mail file is in the Notes data directory.</li><li>■ If you have performed a custom Notes installation and have replicated the server mail file to another directory on your desktop, make sure that it is the path found in the notes.ini file.</li></ul>
Eudora 5.0 or later	<p>If you are using Eudora as your e-mail application, you must set up MAPI in Eudora.</p> <p>To set up MAPI in Eudora:</p> <ol style="list-style-type: none"><li>1. From the Eudora Tools menu, select Options.</li><li>2. Do one of the following:<ul style="list-style-type: none"><li>– If Eudora is the only e-mail application that you use, select Always as the MAPI setting.</li><li>– If you use more than one e-mail application, select When Eudora is running as the MAPI setting.</li></ul></li><li>3. Ensure that your username and password are set up correctly within Eudora. This information is needed to log in to Eudora to retrieve and synchronize your e-mail.</li></ol>

---

**IMPORTANT** Eudora must be running in order for you to perform a HotSync operation. The VersaMail application synchronizes with your Dominant Personality in Eudora 5.1 or later.

---

<b>Mail Client</b>	<b>Action</b>
Direct POP connection to server	<p>Select this option to synchronize an account by connecting directly with a POP server. You must enter the information about the server in the VersaMail application on your handheld when you create the e-mail account to access the server. You will enter information about the incoming (POP) server, the outgoing (SMTP) server, your e-mail username, your password, and your e-mail address.</p> <p>During the HotSync operation, the conduit reads the settings you made. If the settings do not exist or all server information is wrong, an error is reported in the HotSync.log file. However, if the incoming server (POP) is correct, the Inbox is synchronized if the option to synchronize the Inbox is selected. If the outgoing server (SMTP) is correct, the Outbox is synchronized (send e-mail) if you selected the option to synchronize the Outbox. If neither is correct, then nothing happens.</p> <p>If you want to synchronize e-mail for an account that requires APOP authentication, you must select the option to use APOP on your handheld.</p> <p>If you want to synchronize e-mail for an account that requires ESMTP authentication (for example, Yahoo accounts require ESMTP authentication), you must select the option to use ESMTP on your handheld. See <a href="#">“Adding ESMTP to an account”</a> earlier in this chapter for details.</p> <p>The conduit does not support SSL for accounts set up as direct POP.</p>
Direct IMAP connection to server	<p>Select this option to synchronize an account by connecting directly with an IMAP server. You must enter the information about the server in the VersaMail application on your handheld when you create the e-mail account to access the server. You will enter information about the incoming (IMAP) server, the outgoing (SMTP) server, your e-mail username, your password, and your e-mail address.</p> <p>During the HotSync operation, the conduit reads the settings you made. If the settings do not exist or all server information is wrong, an error is reported in the HotSync.log file. However, if the incoming server (IMAP) is correct, the Inbox is synchronized if the option to synchronize the Inbox is selected. If the outgoing server (SMTP) is correct, the Outbox is synchronized (send e-mail) if you selected the option to synchronize the Outbox. If neither is correct, then nothing happens.</p>

Mail Client	Action
	<p>If you want to synchronize e-mail for an account that requires ESMTP authentication (for example, Yahoo accounts require ESMTP authentication), you must select the option to use ESMTP on your handheld. See <a href="#">“Adding ESMTP to an account”</a> earlier in this chapter for details.</p> <p>The conduit does not support SSL for accounts set up as direct POP.</p>
Other e-mail applications	<p>Select Microsoft Exchange 5.0 or later as a choice for the Mail Client option if your e-mail application is compatible with extended MAPI. If your e-mail application is compatible with SMAPI, select Microsoft Outlook Express as a choice for the Mail Client option.</p>

**NOTE** A profile contains configuration information, such as the location of incoming e-mail, your personal contacts list, and other information services that you can use. The profile may be MS Exchange Settings, your name, or something different. For more information on profiles, see your e-mail application’s documentation.

4. Under the account name, click Advanced Sync Options.

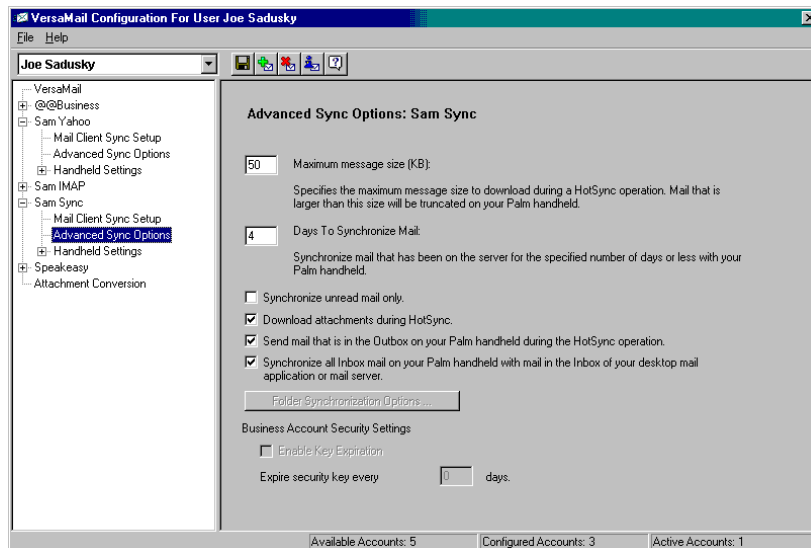

## 5. Enter the synchronization options you want:

**Maximum message size (KB)**

Enter the maximum message size from 1 to 2048KB. If the message exceeds the maximum size, the conduit truncates the message. For example, the maximum message size might be 50KB, and the message might have the following:

- Message header: 1KB
- Body: 20KB
- Attachment: 140KB
- Attachment: 220KB

In this case, the conduit puts the message header, body, and attachment 2—totaling 41KB—on the handheld. Attachment 1 is removed because adding it to the message causes the message to exceed the maximum.

**Days To Synchronize Mail**

Set how many days, between 0 and 999, that e-mail should be synchronized. A value of 0 synchronizes all e-mail in the Inbox during the next HotSync operation. For other values, the conduit synchronizes e-mail for today and the number of days preceding today. For example, if you enter a value of 2, e-mail is synchronized for today and yesterday, but if you enter 3, e-mail is synchronized for today, yesterday, and the day before.

**Synchronize unread mail only**

Select whether to synchronize all e-mail between your desktop and your handheld, or unread e-mail only. By default, the check box is deselected, meaning that all e-mail will be synchronized.

**Download attachments**

Select whether to download attachments during synchronization. By default, the check box is selected; if it is deselected, only the body text of any message containing an attachment will be downloaded to your handheld during synchronization.

**Send e-mail from Outbox**

Select the check box to send any e-mail in the handheld's Outbox during the next HotSync operation.

**Synchronize incoming e-mail**

Select the check box to synchronize the Inbox during the next HotSync operation.



- c. Click the arrow to open the drop-down list, and then click Yes or No to synchronize the folder or not.

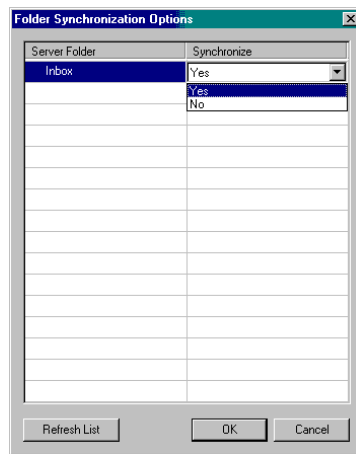

- 7. Click OK.
- 8. Click the Save icon  on the toolbar to save the settings for this account.

### Account information screens

Two screens in the Palm VersaMail HotSync Conduit provide summary information on your accounts:

- The Account Overview screen indicates whether the account is active; whether the account has been synchronized and, if so, the last synchronization date; the mail client for this account; and whether the mail client and/or the incoming mail server has been changed since the last HotSync operation.

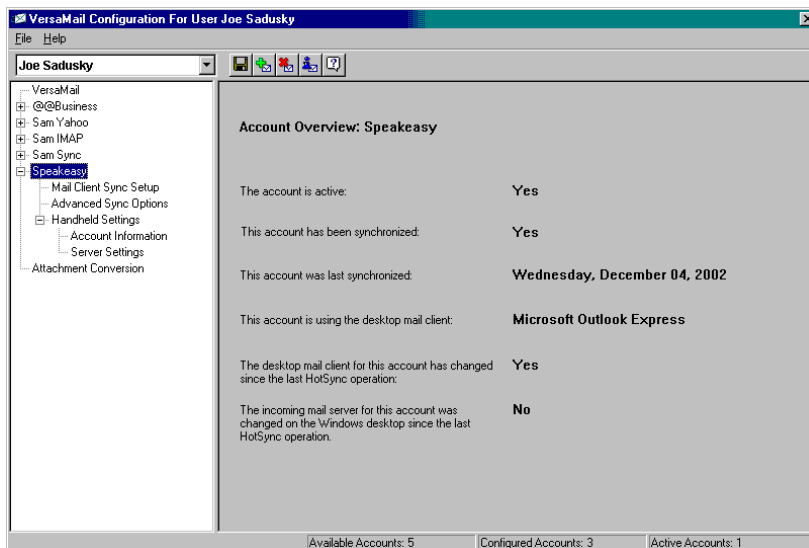

- The Handheld Settings Overview screen lists the server protocol, display name, e-mail address, incoming and outgoing mail server addresses, and whether APOP or ESMTP authentication is required.

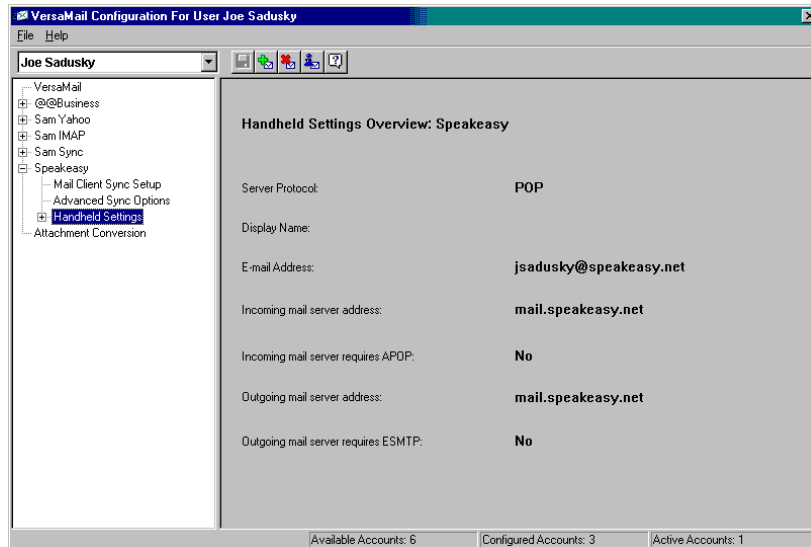

To view the Account Overview screen:

- Click the selected account name.

To view the Handheld Settings Overview screen:

- Under the selected account name, click Handheld Settings.

### Palm VersaMail HotSync Conduit shortcuts

You can use the icons in the toolbar to perform certain tasks quickly, such as saving account configuration settings.

Icon	Action
	Save account settings. Saves any changes you have made to an account.
	Add a new account. You are prompted to enter the account name and protocol.
	Delete an account. You are prompted to select the account to delete from a drop-down list.
	Quick account reference. Lists all accounts and shows whether they are active and the date they were last synchronized.
	Help. Displays the Help window with complete online help.

### Verifying handheld account settings before synchronizing accounts

Certain settings you configure on your handheld for an e-mail account must be set correctly for the synchronization process as well. Before configuring an e-mail client on your desktop for synchronization, be sure to verify the following settings on your handheld:

- **APOP, ESMTP, and SSL:** If you want to synchronize e-mail for an account that requires either APOP or ESMTP authentication (for example, Yahoo accounts require ESMTP authentication) or a secure (SSL) connection for incoming mail, you must select the option to use APOP, ESMTP, or a secure connection on your handheld. See “[Adding ESMTP to an account](#)” earlier in this chapter for information on ESMTP.
- **Mail filters:** Any mail filters you have configured for an e-mail account on your handheld also apply during the synchronization process. For example, if you have set filters to accept only e-mail containing the subject words “Current Software Project,” only those same messages are synchronized between your desktop and your handheld. Be sure to turn mail filters off if you want to synchronize all messages between your desktop and your handheld.

## Synchronizing an account

To synchronize accounts, you must set the HotSync action for the VersaMail application in HotSync Manager. You can, however, exclude e-mail accounts from a HotSync operation.

**TIP** If you don’t want an account synchronized, deselect the check box **Select this check box to synchronize this e-mail account when you perform a HotSync operation.**

**To select which accounts are synchronized during a HotSync operation:**

1. Click the HotSync Manager icon  in the Windows system tray.
2. Select Custom.
3. Select VersaMail in the Conduit list.
4. Click Change.
5. Select one of the following:

- |                                    |  |
|------------------------------------|--|
| <b>Synchronize Active Accounts</b> | Select this option to include active accounts in the next HotSync operation. For an account to be synchronized, you must have selected the option <b>Check this box to synchronize this mail account when you perform a HotSync operation.</b> |
| <b>Do Nothing</b>                  | Select this option to exclude e-mail accounts from the next HotSync operation.   |



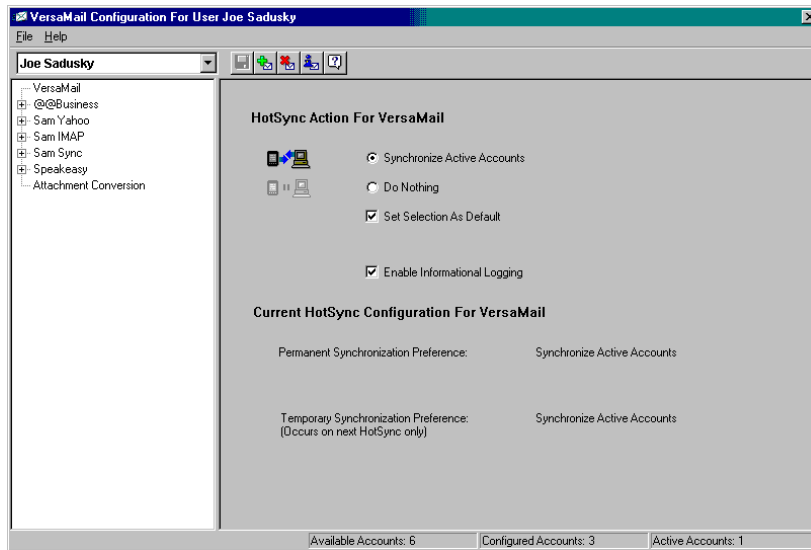

6. (Optional) Select Set Selection As Default to apply the options you selected to all subsequent HotSync operations. Otherwise, the settings apply to the next HotSync operation only.
7. Click OK.
8. Perform a HotSync operation.

### Synchronizing multiple accounts

You can synchronize more than one account during the same HotSync operation.

**NOTE** If you want to synchronize both a Microsoft Outlook and a Microsoft Outlook Express account, you must have Microsoft Outlook set as the default e-mail client on the desktop.

The maximum number of accounts you can synchronize are as follows:

- 1 Simple MAPI account (for example, an account set up using Outlook Express or Eudora)
- 1 Extended MAPI account (for example, an account set up using Outlook)
- 1 Lotus Notes account
- 5 combined direct POP or direct IMAP accounts

If you attempt to synchronize more than the limit for a particular type of account during a HotSync operation, you will receive an alert prompting you to deactivate any accounts over the allowed number.

## Using SSL with the conduit

When you set up an e-mail account, you can choose to use a secure connection (Secure Sockets Layer, or SSL) for sending and receiving e-mail messages. The Palm VersaMail HotSync Conduit supports SSL when synchronizing with an e-mail account only if that account uses one of the following desktop e-mail applications (mail clients):

- Outlook
- Outlook Express
- Eudora

The conduit does not support SSL for accounts set up as direct POP or direct IMAP or for Microsoft Exchange or Lotus Notes accounts.

# Using Voice Memo

 Voice Memo provides a place for you to record and play back voice memos directly on your handheld. Use your voice memos with alarms as reminder messages and share your voice memos with other people.

**To open Voice Memo:**

- Press the Voice Memo application button on the side panel of your handheld. Voice Memo opens to display the list of all your voice memos.

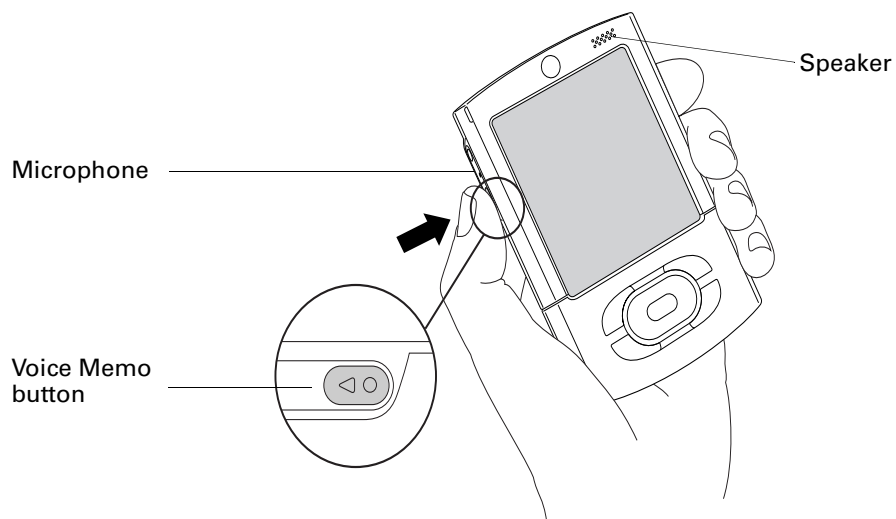

## Creating a voice memo

To record a voice memo, you can use the Voice Memo application button or the onscreen controls.

**To record a voice memo on your handheld:**

1. Press and hold the Voice Memo application button .

---

**IMPORTANT** Continue holding the Voice Memo application button until you finish recording. If you are recording a long voice memo and don't want to continue holding the Voice Memo application button, see ["Pausing and resuming a voice memo recording"](#) later in this chapter to make a recording with the onscreen controls. For optimum results, hold your handheld within 30 centimeters (approximately 1 foot) of your mouth while recording.

---

A tone sounds to indicate that recording has started.

2. Face your handheld and begin speaking.
3. Release the Voice Memo application button to stop recording.

A tone sounds to indicate that recording has stopped.

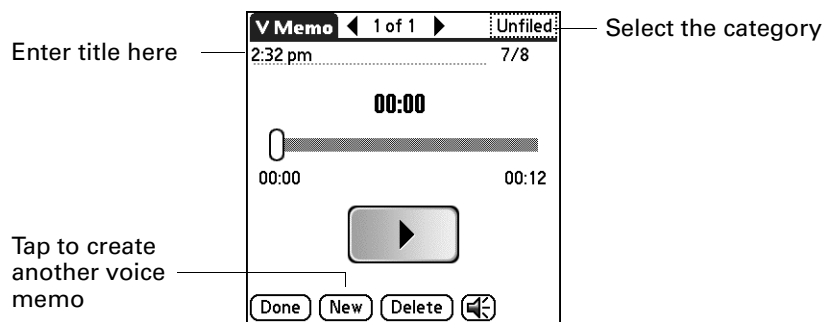

4. Tap Done.

## Pausing and resuming a voice memo recording

To pause and resume while recording a voice memo, you must use the onscreen controls.

**To pause and restart while creating a voice memo:**

1. In the Voice Memo list, tap New.
2. (Optional) Tap the category pick list in the upper-right corner and select the category in which you want to store the voice memo.

**TIP** To automatically store voice memos on an expansion card, see ["Storing voice memos on an expansion card"](#) later in this chapter.

3. Tap Record.

A tone sounds to indicate that recording has started.

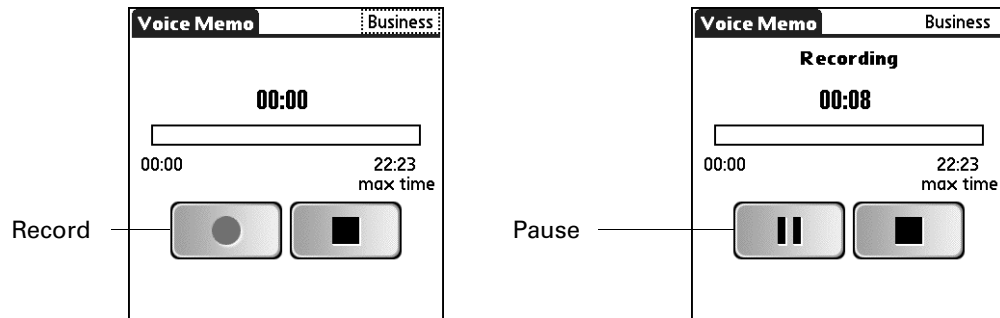

4. Face your handheld and begin speaking.

5. Tap Pause to stop recording.

A tone sounds to indicate that recording has paused.

**NOTE** If you use other applications on your handheld while pausing the recording, press (and release) the Voice Memo application button (▶) to resume recording later.

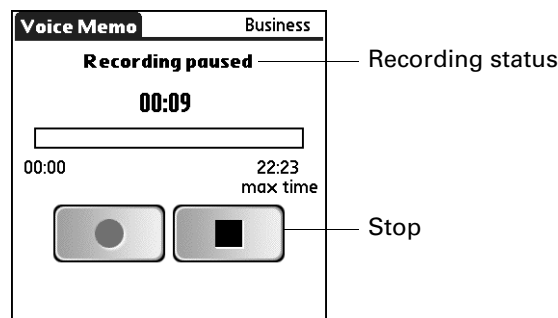

6. Tap Record.

A tone sounds to indicate that recording has restarted.

7. Tap Stop.

A tone sounds to indicate that recording has stopped.

8. (Optional) Select the time at the top of the screen and enter a title.

9. Tap Done.

## Storing voice memos on an expansion card

You can conserve storage space on your handheld, or create voice memos for others, by storing your voice memos on an expansion card. Voice Memo enables you to store specific voice memos on an expansion card, or to configure your handheld to always store voice memos on an expansion card when one is present.

Keep in mind that when you store voice memos on an expansion card, they do not appear in the Voice Memo portion of Palm™ Desktop software after a HotSync® operation and are not backed up. So if you give your expansion card to a friend, you do not have another copy of your voice memo(s). You must use a card reader (sold separately) to view the contents of the expansion card on your computer, and use a third-party application to back up data stored on an expansion card. Additionally, you cannot mark voice memos private or attach alarms to voice memos that are stored on an expansion card.

**NOTE** Palm works with developers of third-party add-on applications to ensure the compatibility of these applications with your new Palm handheld. Some third-party applications, however, may not have been upgraded to be compatible with your new Palm handheld. If you suspect that a third-party application is adversely affecting the operation of your handheld, contact the developer of the application.

**To store specific voice memos on an expansion card:**

1. Create or open a voice memo.
2. Tap the category pick list in the upper-right corner and select Card.
3. Tap Done.

**To automatically store voice memos on an expansion card:**

1. From the Voice Memo list, tap the Menu icon .
2. Select Options, and then select Preferences.

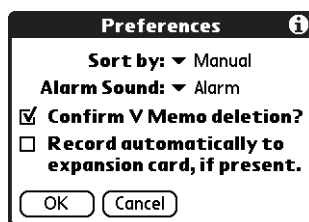

3. Select the check box Record automatically to expansion card, if present.
4. Tap OK.

## Listening to voice memos

The Voice Memo list displays the title, creation date, and duration of each voice memo.

**To listen to a voice memo:**

1. In the Voice Memo list, select the voice memo title.



**TIP** You can also select a voice memo with the navigator. See [“Using the navigator”](#) in [Chapter 2](#) for details.

The voice memo begins to play after a few seconds. To start playing immediately, tap Play.

2. Tap the arrows at the top of the screen to listen to the next and previous voice memo.



**TIP** You can also press Right or Left on the navigator to listen to the next or previous voice memo.

3. Tap Done.

**To adjust the volume:**

1. In the V Memo screen, tap the Speaker icon .



2. Drag the slider or press Up or Down on the navigator to adjust the volume.

3. Tap Done.



**TIP** When a voice memo is playing, you can also press Up or Right on the navigator to increase the volume, or press Down or Left to decrease the volume.

**To play a portion of a voice memo:**

1. In the Voice Memo list, select the voice memo title.
2. Drag the slider to the portion you want to hear.

**TIP** You can also tap the slider bar to jump the slider to that position.

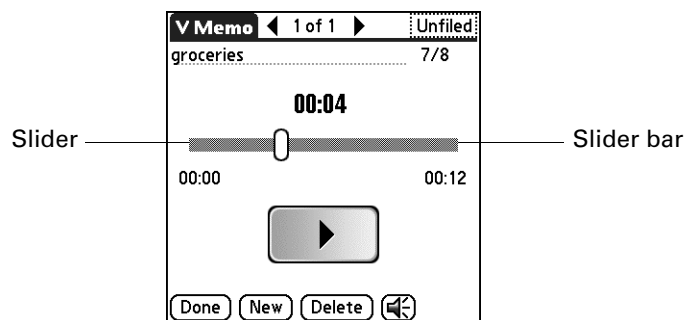

3. Tap Play.
4. Tap Done.

## Setting an alarm for a voice memo

You can set an alarm for a specific time and date to remind you to follow up on a voice memo.

**To set an alarm for a voice memo:**

1. Select the voice memo to which you want to assign an alarm.
2. Tap the Menu icon .
3. Select Options, and then select Alarm.

4. Tap the Date box.
5. Tap the year, month, and date you want the alarm to sound.

After you tap the date, the Set Alarm dialog box reappears.

6. Tap the Time box.
7. Tap the hour and minute columns to select the time you want the alarm to occur.
8. (Optional) Tap the Auto-play check box to automatically play the voice memo when the alarm goes off.
9. Tap OK.

## Using Voice Memo menus

Voice Memo features that are not explained elsewhere in this book are described here. The Voice Memos and Options menus differ depending on whether you're displaying the Voice Memo list or an individual voice memo.

### V Memo menus

- |                      |   |
|----------------------|---|
| <b>Send Category</b> | Opens a dialog box where you can choose how to send the category. You can send the category using Bluetooth™ communication, SMS, or the VersaMail™ application.   |
| <b>Send V Memo</b>   | Opens a dialog box where you can choose how to send the voice memo. You can send the voice memo using Bluetooth communication, SMS, or the VersaMail application. |



## Options menus

<b>Preferences</b>	Displays the Voice Memo Preferences dialog box, where you define the sort order for voice memos, the alarm sound, the deletion confirmation setting, and whether to automatically store voice memos on an expansion card if one is present.
<b>Security</b>	Displays the Change Security dialog box, where you set a privacy option for all voice memos.
<b>Details</b>	Displays the V Memo Details dialog box, where you assign a category and privacy option for a voice memo.



# Using Palm™ Web Pro

 Palm™ Web Pro is your gateway to the web allowing you to view and save Internet web pages, bookmark web pages, and download files from the Internet.

---

**IMPORTANT** To use Web Pro, you must first configure and establish a connection with the Internet, such as through a mobile phone. For more information on connecting to the Internet using a mobile phone, [see “Setting up a phone connection” in Chapter 12.](#)

---

**To open Web Pro:**

1. Tap the Home icon .
2. Select All in the Category pick list in the upper-right corner of the screen.
3. Tap the Web Pro icon .

Web Pro may take a moment to load the first page.

---

**IMPORTANT** If you are in another application, such as VersaMail, you can tap on a URL and Web Pro automatically opens and connects to the Internet to display the page. Depending on your preference, Web Pro also opens when you click on a supported file type (gif, .jpeg, .html, or .png) received as an attachment in VersaMail.

---

**NOTE** The rest of the instructions in this chapter assume that you’re already running Web Pro and that you’ve successfully connected to the Internet.

## What Web Pro looks like

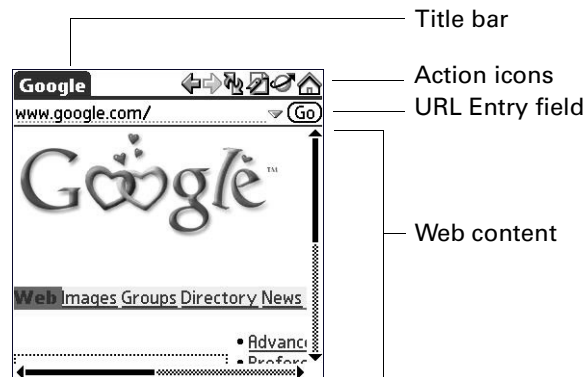



The Web Pro screen has four parts:

- The title bar displays the name of the current web page or shows the status of actions, such as “Requesting...”, “Receiving...”, “Formatting...”, and so forth.
- The action icons enable you to navigate in the browser, to refresh pages, and to bookmark pages.
- The URL Entry field enables you to quickly enter web page addresses.
- The rest of the screen displays the content of the web page.

You can perform other actions by tapping items in menus. Like in other Palm OS® applications, when you select the title bar, it is replaced by the menu bar. For information about menus, see see “Using menus” in [Chapter 4](#).

## Getting help in Web Pro

Help is available in the following locations:

- Tap the Menu icon  and select Web Pro help in the Options menu for information about Web Pro.
- Most dialog boxes in Web Pro have help about the options in the dialog box. To see that information, tap the Tips icon .
- For help with drawing Graffiti® 2 characters, tap the Menu icon , tap Edit, and then tap Graffiti 2 Help.

## Disconnecting from and connecting to the Internet

While you’re working with stored information in Web Pro, such as saved pages, stored versions of pages, and so forth, you can disconnect from the Internet in order to reduce usage charges. You can connect to the Internet again when you need access again.

**To disconnect from the Internet:**

1. Tap the Menu icon .
2. Tap Disconnect in the Page menu.

**To connect to the Internet:**

1. Tap the Menu icon .
2. Select Connect in the Page menu.

The Service Connection Progress dialog opens.

3. If the connection is not established, do one of the following:
  - Tap Cancel to stop the connection process.
  - Tap Change Network to select a different service to connect to.

## Browsing the web on your handheld

Just like the web browser you use on your desktop computer, Web Pro lets you browse the web in several ways:

- Visit a web page by entering its URL.
- Visit another web page by tapping a link.
- Go back to the pages you have already visited by using the Back and Forward icons.

### Visiting a web page

You can visit web pages using the Open URL dialog box or using the URL Entry field.

**To visit a web page using the Open URL dialog box:**

1. Tap the Open URL icon .
2. Enter the URL of the web page you want to visit.

The field in the Open URL dialog box already contains the characters “www.” If the web address you want to enter starts with another set of letters, just drag over the “www.” and backspace to erase them.

Tap buttons to enter other characters commonly used in web addresses.

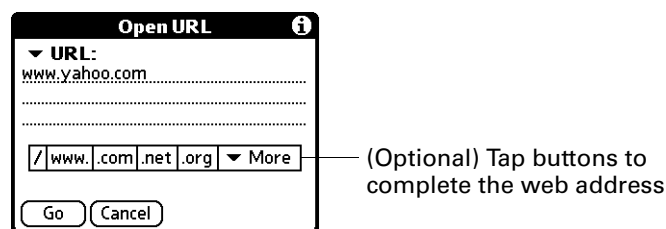

3. Tap Go.

During the short delay while the new page is being downloaded, the title bar displays information about the download process.

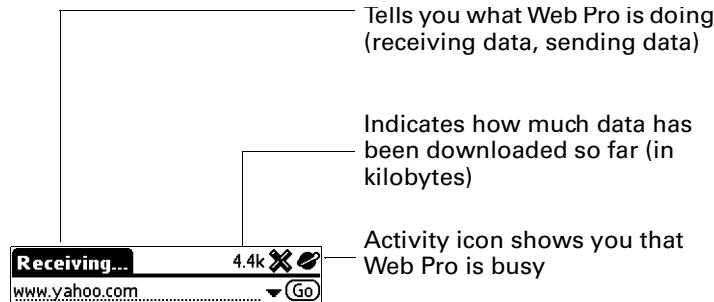

To visit a web page using the URL Entry field:

1. Tap the URL Entry field at the top of the screen.



2. Enter the URL in the field.
3. Tap Go.

**TIP** If autofill is enabled, when you enter the first few letters of a URL that you've entered before in the URL Entry field, Web Pro completes the URL for you. For more information on autofill, see ["Enabling or disabling autofill."](#)

## Viewing different parts of a web page

If the web page is larger than your screen, you can tap and drag the stylus to move the web page in any direction to view different parts of the web page.

**NOTE** Due to the ability to tap and drag pages to view other parts of a page, you must tap and hold, then drag to select text when copying from a page.

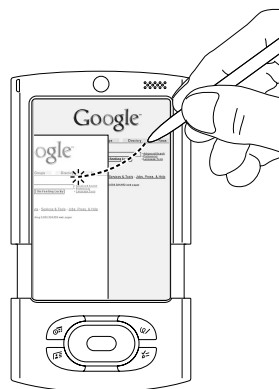

## Following a link

Many web pages contain links, which are text or pictures that when clicked, take you to another web page or to another part of the same page. Like many other web browsers, Web Pro highlights these links by underlining them.

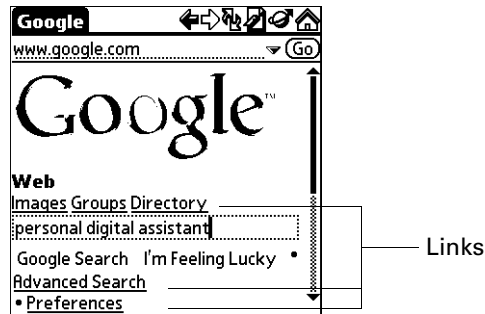

### To follow a link:

- Tap the link.



**TIP** Press Select on the Navigator to select the first link on the screen. Press Up and Down to navigate through the links, and then press Select to follow the link.

## Returning to a web page you just visited

### To go back to the last web page you visited:

- Tap the Back icon .

### To go back to an earlier page:

- Tap the Back icon until you return to the page you want.

The list of visited pages (which is limited by your handheld's memory) is called the *cache*. See "[Finding web pages you recently visited](#)" for more information on the cache.

### To go forward through the cached pages:

- Tap the Forward icon .

## Returning to your home page

No matter where you navigate on the Internet, you can always return to your home page quickly and easily.

### To return to your home page:

- Tap the Home Page icon in the Web Pro action bar .

If you want a different web page to be your home page, see "[Changing your start and home page.](#)"

## Downloading files and pages

You can download files and save pages to your handheld or an expansion card.

### Downloading a file to your handheld

Web Pro can download any type of file for which your handheld provides native support, which means that your handheld contains an application that enables you to open and view the file in its original format. (Some handheld applications allow you to view files only after you perform a HotSync® operation, during which the file is converted from its original format to different format. Web Pro does not download files that are supported only in this way.) For example, if your handheld contains an application that lets you open PDF documents without format conversion required on the desktop computer, you will be able to download PDF files with Web Pro.

Popular file types that Web Pro can download (when native support is present on your handheld) include applications (.prc) and databases (.pdb) for Palm OS software, as well as documents (.doc, .txt, and .pdf), images (.jpeg and .gif), and music files.

Downloading a file is much like visiting a web page.

#### To download a file by following a link from a web page:

1. Tap the link.

The Download dialog box appears, asking you to confirm the file you want to download.

If you want to download to an expansion card, select the Download to card check box.

2. If the file is the one you want, tap Save.

A message appears showing you the progress of the download. When the file download is complete, a message appears.

3. Tap OK.

#### To stop a web page from downloading:

- Tap the Stop icon  in the Web Pro action bar.

#### To stop a file from downloading:

- Tap Cancel in the Download dialog box.

You can make changes to improve the download speed, such as not downloading images that appear on web pages. See [“Changing how images are downloaded.”](#)



## Saving a page

You can save a web page to your handheld.

**To save a web page to your handheld:**

1. Open the web page you want to save.
2. Open the menus.
3. Select Save Page from the Page menu.



4. (Optional) Change the page name or category.
5. Tap Save.

## Viewing and editing a saved page on the handheld

When you open a saved page, remember that you're seeing a copy of the actual page.

**To open a saved page:**

1. Open the menus.
2. Select View Saved Pages from the Page menu.
3. Tap the name of the saved page you want to open.

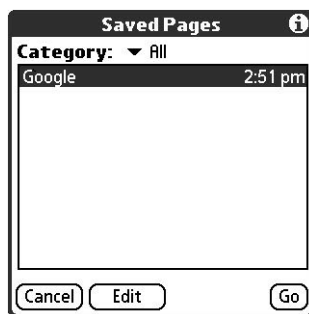

Shows when you saved the page. If you saved it today, it shows the time. If you saved it before today, it shows the date.

4. Tap Go.

**To edit information about a saved page:**

1. Open the menus.
2. Select View Saved Pages from the Page menu.
3. Tap the name of the saved page you want to edit.
4. Tap Edit.
5. Edit the information about the saved page:
  - Tap the Name field, and then enter a new name.
  - Tap the Category pick list to change the category or to create a new category.
6. Tap Save.

A confirmation dialog box appears.

7. Tap Yes.
8. Tap Done.

**To delete a saved page:**

1. Open the menus.
2. Select View Saved Pages from the Page menu.
3. Tap the name of the saved page you want to delete.
4. Tap Delete.

A confirmation dialog box appears.

5. Tap OK.
6. Tap Done.

## Viewing files on an expansion card

You can view saved files on an expansion card without an active internet connection. The following files types can be opened from an expansion card: .html, .htm, .gif, .jpg, and .png.

**NOTE** The Open from Card option appears only when an expansion card is inserted into your handheld.

**To view a file on an expansion card:**

1. Open the menus.
2. Select Open from Card from the Page menu.
3. Open the folder that contains the file.
4. Select the file.
5. Tap Open.

## Viewing a file from another application

Web Pro also functions as a viewer, enabling you to quickly view certain files while working in other applications. For example, if you read an e-mail message that has an image file attached, tap the image file. If no other application on your handheld is identified to open the image file by default, Web Pro opens so that you can view the image.

## Refreshing a page

To make sure you have the latest content, refresh the page.

**To refresh a page:**

- Tap the Refresh icon .

You can also view old content instead of accessing the Internet. See [“Controlling how Web Pro accesses the Internet.”](#)

## Viewing information about a web page

Because of the limited space on the handheld screen, sometimes the current web address (URL) gets truncated. To find the full URL, name, and size of the current web page, open the Web Page Info dialog box.

**To view information about the current web page:**

1. Tap the Menu icon .
2. Select Page Info in the Page menu.

## Using passwords

Some web sites require that you use a password to gain access to information. Passwords in Web Pro work in a slightly different way from those in typical desktop browsers.

**To enter a password:**

1. Open the web page where you must enter the password. The password field contains the word “Unassigned.”



2. Enter your sign-in name in the appropriate field.
3. Enter your password in the appropriate field and tap OK.  
The password field now contains asterisks indicating the password has been entered.
4. Tap the sign-in button (Enter, Go, and so forth) on the web page to gain access to the password-protected information.

## Copying and pasting text

To copy text, select the text and use the options from the Edit menu. For more information about the edit functions, see [“Editing records”](#) in [Chapter 4](#).

When editing, note the following:

- None of the Edit options copy images, only text.
- Due to the ability to tap and drag pages to view other parts of a page, you must tap and hold, then drag to select text. For more information on tap and drag to view other parts of a page, see [“Viewing different parts of a web page”](#) earlier in this chapter.

## Communicating with other users

Web Pro allows you to communicate with other users in several ways:

- Use a mailto link in a web page to compose and send e-mail.
- Beam a URL to another Web Pro user.
- E-mail a URL to another user.

## Sending e-mail

Some web pages include “mailto” links. You can use these links to send e-mail to others if you use the VersaMail™ application or another application that supports this functionality. For more information on the VersaMail application, see [Chapter 16](#).

### To send e-mail:

1. Tap a mailto link in a web page.

The e-mail application opens and a new e-mail message is created. The message is already addressed to the mailto address, and the subject line may be filled out for you, as well.

2. Compose your e-mail message in the e-mail application. For more information on composing e-mail messages in the VersaMail application, see [Chapter 16](#).
3. Tap Outbox to save the e-mail in your e-mail application’s outbox.

Use your e-mail application, such as VersaMail, to send the e-mail message.

You are returned to Web Pro and to the web page you were viewing.

## Beaming a URL

You can share your favorite web pages with other Web Pro users by beaming URLs to their handhelds.

### To beam a web page’s URL:

1. Navigate to the web page.
2. Tap the Menu icon  and select Send from the Page menu.  
A dialog box opens.
3. Point the IR port of your handheld directly at the IR port of the receiving device.
4. Tap Beam URL.

The recipient can choose to accept the beamed URL or not. If the recipient chooses not to accept the URL, the beaming process ends.

Messages display showing the beaming progress. When the message closes, the beaming process is complete.

## E-mailing a URL

You can also e-mail the URLs of your favorite web pages to other users.

### To e-mail a web page’s URL:

1. Navigate to the web page.
2. Tap the Menu icon  and select Send from the Page menu.

A dialog box opens.

3. Tap Mail URL.

The e-mail application opens.

4. Compose your mail message in the e-mail application.

For more information on composing e-mail messages in the VersaMail application, see [Chapter 16](#).

5. Tap Send to send the e-mail message now, Outbox to send the e-mail message later, or Cancel.

You are returned to Web Pro and to the web page you were viewing.

## Bookmarking your favorite pages

When you read a printed book, you place a bookmark at the page where you stopped reading so that you can remember where you stopped. In the same way, you can bookmark a web page for later reference. A bookmark in Web Pro doesn't store the actual page; instead, it stores a reference to the page's URL.

### Adding a bookmark

If you would like to visit the current page again, add a bookmark to the Bookmark list.

To add a bookmark for the current page:

1. Tap the Menu icon , and then select Bookmark URL from the Page menu.
2. (Optional) Change the bookmark name, URL, or category.

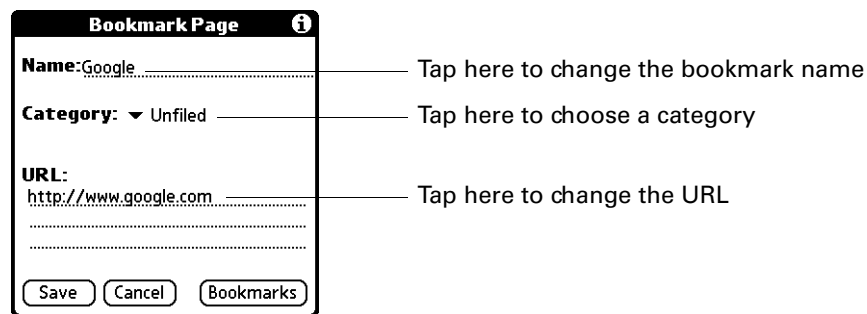

3. Tap Save.

### Visiting a bookmarked page

Use your list of bookmarks to visit a particular page again.

**NOTE** You can set Bookmarks as your start page. See [“Changing your start and home page”](#) later in this chapter.

**To visit a bookmarked page:**

1. Do one of the following:
  - Tap the Bookmark icon .
  - Open the menus, and then select View Bookmarks from the Page menu.

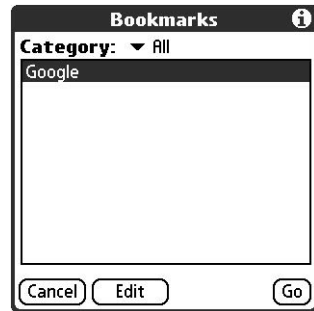



2. Do one of the following:
  - Tap the name of the bookmarked page you want to visit, and then tap Go.
  - If your handheld includes a navigator, press Up and Down to scroll through the list of bookmarks, and then press Select to visit the bookmarked page you've chosen.

## Editing information about a bookmark

You can edit the name and URL of a bookmark, and change its category.

**To edit information about a bookmark:**

1. Do one of the following:
  - Tap the Bookmark icon , and then tap Bookmarks.
  - Tap the Menu icon , and then select View Bookmarks from the Page menu.
2. Do one of the following to select the bookmark you want to edit:
  - Tap the name of the bookmark you want to edit.
  - If your handheld includes a navigator, press Up and Down to scroll through the list of bookmarks to the bookmark you want to edit.
3. Tap Edit.
4. Tap Details.
5. Edit the bookmark:
  - Tap the Name field, and then enter a new name.
  - Tap the URL box to change the address.
  - Tap the Category pick list to change the category or to create a new category.

6. Tap Save.
7. Tap Done.

## Deleting a bookmark

You can delete bookmarks that you no longer want.

**To delete a bookmark:**



1. Press Select on the navigator.
2. Press Up and Down on the navigator to scroll through the list of bookmarks to the bookmark you want to delete.
3. Tap Delete.  
A confirmation dialog box appears.
4. Tap OK.
5. Tap Done.

## Finding web pages you recently visited

Using the Back and Forward icons to browse through the pages you recently visited, one page at a time, can be tedious. Instead, you can use the History list to view a list of the pages you visited and go directly to any page in that list. The History list contains a record of the last 50 pages you have visited and is saved even when you exit Web Pro.

The History list also indicates pages that have been cached, or stored on your handheld, which means you can view them again without connecting to the internet.

## Returning to a page you visited

**To return to a page you visited:**

1. Tap the Menu icon .
2. Select History from the Options menu.
3. Tap the name of the web page you want to visit.

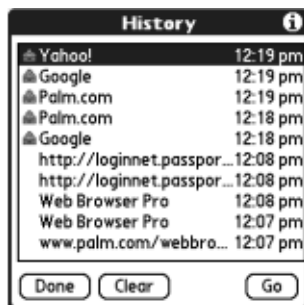

4. Tap Go.



---

## Viewing a cached page

- Tap a page that appears in the History list next to the cached icon.  
A dialog box appears, reminding you that you are about to view old content.
- Do one of the following:
  - Tap Yes to view the stored version.
  - Tap No, Get Latest to initiate an Internet connection and retrieve up-to-date content.

## Clearing the History list

If you've recently visited web pages you have no intention of visiting again, you can clear the History list.

---

**IMPORTANT** Clearing the History list removes the record of your recent browsing history. Pages you've recently visited are still available in the cache and you can visit those pages by using the Back and Forward icons in the Web Pro action bar. If you want to save the location or content of a web page indefinitely, create a bookmark or a saved page for that page before clearing the History list. For more information on the cache, see ["Changing the size and content of the cache."](#) For more information on the Back and Forward icons, see ["Returning to a web page you just visited."](#)

---

To clear the History list:

1. Tap the Menu icon .
2. Select History from the Options menu.
3. Tap Clear.  
A confirmation dialog box appears.
4. Tap OK.

**NOTE** This action clears only the contents of the History list. Your bookmarks and saved pages are not deleted.

5. Tap Done.

## Changing page characteristics

You can change the color of links on pages. In some cases, you can also change the way images appear on pages.

### Changing the default size of text

If the default size of the text is too small, you can increase the size.

**To change the default size of text:**

1. Tap the Menu icon .
2. Select Font from the Options menu.
3. Choose font size and check the sample text.
4. When you're satisfied with your choice, tap OK.

## Changing display views

You can optimize your viewing of a web page on your handheld.

Normal View functionality is only available when the proxy server is turned off. By default, your handheld comes with the proxy server turned on and displays pages in Handheld view. When you select Normal View, you have a choice to turn off the proxy server and display pages in Normal View, or remain in Handheld View. By keeping the proxy server turned on, web pages generally load much faster and your data charges are reduced. For more information on using a proxy server, see [“Changing the proxy server”](#) later in this chapter.

**To change display views:**

1. Open the menus.
2. Select Options, and then tap one of the following options:

<b>Normal View</b>	Displays the web page as it would appear in a desktop computer web browser.
<b>Handheld View</b>	Displays a modified version of the web page so that it is optimized for handheld viewing.
<b>Fullscreen View</b>	The web page fills the whole screen. To exit Fullscreen mode, tap the circle icon in the upper-right corner.

## Changing link colors

You can change the colors that are used to display visited and unvisited links on the web pages you view.

**To change link colors:**

1. Tap the Menu icon .
2. Select Display Options from the Options menu.
3. Change the display colors for visited and/or unvisited links. The default display color for unvisited links is blue; for visited links it is purple.
4. Tap OK.

## Changing how images are downloaded

Images in web pages can be very large. If you are accessing the Internet by using a proxy server, you may be able to set options to make web pages download faster by reducing image quality or removing images altogether, or you may choose to have images downloaded so that they appear at their highest quality.

---

**IMPORTANT** If you are not using a proxy server, you will only be able to select or deselect an option to view images. When you choose to view images, they will be displayed at their best quality.

---

To change how images are downloaded and displayed:

1. Open the menus.
2. Select Display Options from the Options menu.
3. Select one of the following items from the Images pick list:

<b>No Images</b>	All web pages are downloaded without images. If images are already in cache, they will be displayed.
<b>Low Quality</b>	Images are compressed and have a very low resolution. This makes downloading faster but results in reduced image quality.
<b>Normal Quality</b>	Image quality is average. This is the best compromise between speed and image quality.
<b>High Quality</b>	Image quality is better than average. This is the default setting.
<b>Best Quality</b>	Images are downloaded at their highest quality. This may result in longer download times.

4. Tap OK.

## Changing your start and home page

You can select the start page you want Web Pro to open to when you first open the browser. You can also change your home page to any web address.

**NOTE** Your service provider has the option to disable this choice. If the choice is disabled, your changes have no effect.

To change your start page:

1. Tap the Menu icon .
2. Select Preferences from the Options menu.

3. Select Default.
4. Tap Start With pick list and select from the options.
5. Tap OK.

**To change your home page:**

1. Tap the Menu icon .
2. Select Preferences from the Options menu.
3. Tap Default.
4. Tap the Home Page box.

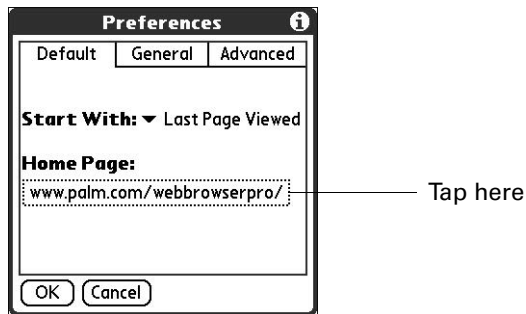

5. Enter the URL.

To make the page currently displayed in Palm Tungsten T3 your home page, tap Current URL.

To select one of the last five home pages you've used as your home page, tap the URL pick list and select a URL.

6. Tap OK.

## Enabling or disabling autofill

Filling out an order form or application on the web usually requires entering several pieces of information: your name, address, phone number, and so on. By default, Web Pro stores the information you entered in these fields. The next time you use that order form and type the first few letters in a field, Web Pro remembers the last item you entered in that field that started with those letters, and fills in the field.

This also applies to URLs. If autofill is enabled, when you enter the first few letters of a URL you've entered before in the URL Entry field, Web Pro completes the URL for you.

**To enable or disable autofill:**

1. Tap the Menu icon .
2. Select Preferences from the Options menu.
3. Tap General.
4. In the Autofill Text check box, do one of the following:
  - To turn off autofill, tap to remove the checkmark.
  - To turn on autofill, tap to select it.
5. Tap OK.

## Enabling or disabling cookies

Some web sites store information in a small text file, called a *cookie*. Cookies usually contain information about you and your preferences for that web site. A site can use this information to customize the pages you see the next time you visit.

Allowing a web site to create a cookie does not give the site access to the rest of your handheld. A cookie stores only the information you provide while visiting the web site.

By default, Web Pro saves the cookies it receives. You can tell it not to accept cookies. You can also periodically delete cookies from your handheld.

**To enable or disable cookies:**

1. Tap the Menu icon .
2. Select Preferences from the Options menu.
3. Tap Advanced.
4. In the Accept cookies check box, do one of the following:
  - To not store cookies, tap to remove the checkmark.
  - To accept cookies, tap to select it.
5. Tap OK.

**To delete cookies:**

1. In the Advanced Preferences screen, tap the Delete Cookies box.
2. Tap OK in the Delete Cookies confirmation dialog box.

## Enabling or disabling JavaScript

Web Pro supports JavaScript code on web pages. JavaScript is often used on web pages for interactive content.

If Web Pro is configured for a Palm-hosted proxy server, JavaScript is enabled by default and can't be turned off.

If Web Pro is configured for a non-Palm proxy server or to operate without a proxy server, JavaScript is enabled by default, but you can disable JavaScript using the procedure below.

**NOTE** Some JavaScript implementations are not supported, such as mouse rollovers and form validation.

**To enable or disable JavaScript:**

1. Tap the Menu icon .
2. Select Preferences from the Options menu.
3. Tap Advanced.
4. In the Enable JavaScript check box, do one of the following:
  - To disable JavaScript, tap to remove the checkmark.
  - To enable JavaScript, tap to select it.
5. Tap OK.

## Changing the size and content of the cache

The *cache* in Web Pro consists of web pages that are stored so you can view them again without accessing the Internet. By default, this cache is saved, thereby saving the content you've viewed even when you exit Web Pro.

You can change the size of the cache to increase the number of web pages stored, you can choose to clear the cache immediately, or you can choose to clear the cache each time you exit Palm Tungsten T3 so that it starts fresh at the beginning of each session.

**To change the size and content of the cache:**

1. Tap the Menu icon .
2. Select Preferences from the Options menu.
3. Tap Advanced.

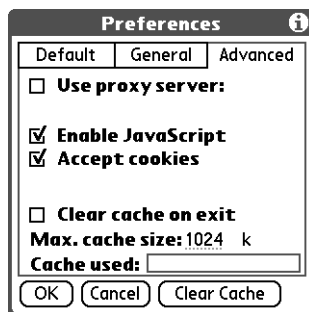

4. Use one or more of the following options:

<b>Clear Cache</b>	Tap to clear the cache immediately.
<b>Clear cache on exit</b>	Select the check box to clear the cache each time you exit Web Pro. Deselect the check box to keep the cache from session to session.
<b>Max. cache size</b>	Tap to change the maximum cache size used to store web pages. The default size of the cache is 1,024KB and the maximum size is 9,999KB.

**NOTE** Remember that your handheld has a limited amount of memory. Choose a cache size that lets you store at least a few pages but still leaves room on your handheld for other data and applications. A value of at least 500KB is recommended.

5. Tap OK.

## Controlling how Web Pro accesses the Internet

Because some wireless Internet service providers (ISPs) charge by the amount of data you download, Web Pro is careful to limit how often it accesses the Internet. If you have a faster or more permanent connection to the Internet, the default settings should work for you.

If you have a slower or more expensive Internet connection, you can enable three settings that can help reduce your access costs.

To change connection settings:

1. Tap the Menu icon .
2. Select Preferences from the Options menu.
3. Tap General.
4. Tap the check box next to the following options to enable or disable that option:

<b>Offer old content if available</b>	Old pages from cache are displayed instead of new versions being retrieved from the Internet, even if the old pages are outdated. A dialog box is displayed informing you when the page you are viewing is old.
<b>Ask before connecting</b>	You're notified each time before you access the Internet.
<b>Disconnect on Exit</b>	Your handheld disconnects from the Internet when you exit Web Pro.

By default, these options are disabled (that is, there are no checks in the check boxes).

5. Tap OK.

## Changing Network Preferences

Web Pro includes many options you can use to change the way in which you access the network.

**To change Network Preferences:**

1. Tap the Menu icon .
2. Select Network from the Options menu.

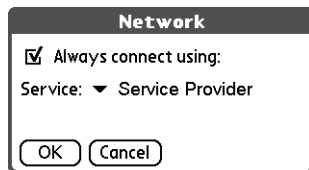

3. Change one or more of the following settings:

**Always connect using** Check if you always want to use the same ISP to connect to the Internet.

**Service** Select the ISP you want to use to connect to the Internet.

4. Tap Done.

## Changing the proxy server

Using a proxy server reduces your data charges by downloading web pages faster. Your handheld comes with the proxy server turned on. You can turn the proxy server off, or configure some other proxy server.

**NOTE** Normal view of the web pages is only available when the proxy server is turned off. For more information on using the different display views, see [“Changing display views”](#) earlier in this chapter.

**To turn on or off the proxy server or to configure another the proxy server:**

1. Tap the Menu icon .
2. Select Preferences from the Options menu.
3. Tap Advanced.



4. In the Use proxy server check box, do one of the following:
  - To not use a proxy server, tap to remove the checkmark.
  - To use a proxy server, tap to select it.

If you want to use a proxy server other than the default Palm hosted proxy server, enter the appropriate server address and port number.



5. Tap OK.



# Using World Clock

 World Clock enables you to view the current time and date in multiple locations and to set an alarm.

**To open World Clock:**

1. Tap the Home icon .
2. Select the World Clock icon .



**TIP** You can also open World Clock by tapping the Clock icon  in the upper-left corner of the Graffiti<sup>®</sup> 2 input area and then tapping Go to Clock, or when your handheld is off, you can press Select on the navigator and then tap Go to Clock.



## Viewing the time

There are several ways for you to easily check the current time and date.



**To view the time:**

Do one of the following:

- When your handheld is on, tap the Clock icon  in the upper-left corner of the Graffiti 2 input area.

Your handheld displays the time for two seconds and then returns to the previous application.



- When your handheld is off, press Select on the navigator.  
Your handheld turns on, displays the time, and then turns off after a few seconds.
- Tap the Home icon , and then select the World Clock icon .

## Setting the primary location

You can use World Clock to select the location, date, and time for the primary location. Keep in mind that the primary location settings are also your system date and time and that these settings are used by all the applications on your handheld. The primary location settings also appear in the Date & Time Preferences screen. Similarly, if you change the settings in the Date & Time Preferences screen, those settings become your system date and time and also appear under the primary location in World Clock. The primary location settings also serve as a point of reference for the secondary locations.

### To set the primary location:

1. Tap the primary location pick list.

Primary location  
pick list



2. Tap the location you want to use as the primary location.

The location you select is typically a large city in the same time zone as the one where you live. If an appropriate choice does not appear in the list, see [“Adding a location”](#) later in this chapter to create a new location.

3. Tap OK.

### To set the date:

1. Tap Set Date & Time.
2. Tap the Set Date box.

- Tap the arrows to select the current year.

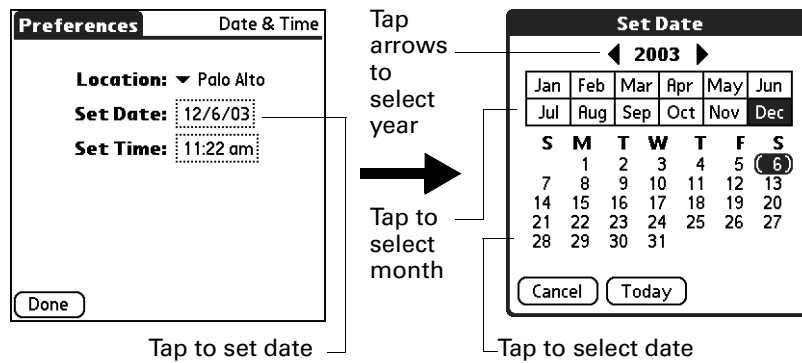

- Tap the current month.
- Tap the current date.
- Tap Done.

To set the time:

- Tap Set Date & Time.
- Tap the Set Time box.

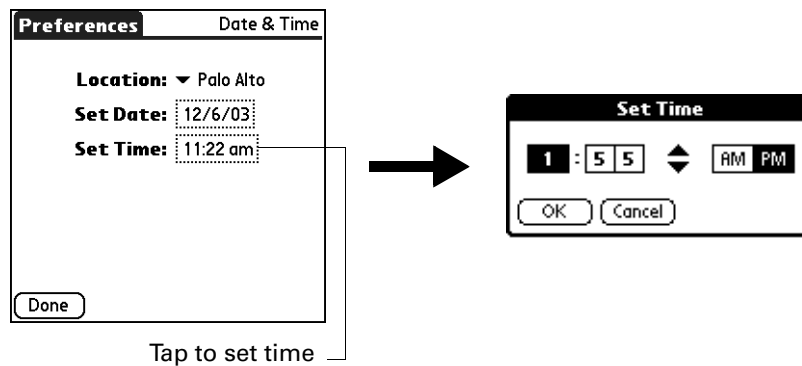

- Tap the up or down arrow to change the hour.
- Tap each number of the minute, and then tap an arrow to change the minutes.
- Tap OK.
- Tap Done.

## Choosing a different primary location

If you travel to another location and you want alerts to appear based on local time, you need to change the primary location to update the system time.

To change the primary location:

1. Tap the pick list next to the current primary location.

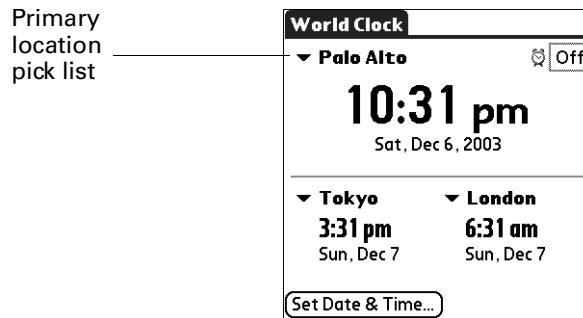

2. Tap the location you want to use as the new primary location.

If the new location is in another time zone, World Clock automatically updates the date and time in all the applications on your handheld.

## Setting the secondary locations

The secondary locations display the date and time in two locations other than the primary location.

To select a secondary locations:

1. Tap the pick list next to the secondary location.
2. Tap the location you want to use as the new secondary location.

If an appropriate location does not appear in the list, see the next section, [“Adding a location.”](#)

## Adding a location

If an appropriate location does not appear in the Location pick list, you can add a new location to the list. When you add a location, the default Time Zone and Daylight Saving settings are usually correct. However, you can adjust these settings if necessary. When the Daylight Saving options are active, the time change automatically occurs at 1:00 AM on the selected start and end dates.

**To add a location:**

1. Tap a Location pick list.
2. Select Edit List.
3. Tap Add.
4. Select a location that is in the same time zone as the city you want to add.
5. Tap OK.
6. (Optional) Tap the Name field and modify the location name.
7. (Optional) Tap the Time Zone box and select a time zone.

8. Tap OK.
9. Tap Done.

**To set Daylight Saving options:**

1. From the Edit Location dialog box, tap the This location observes Daylight Saving Time check box to select it.
2. Tap the Start box.

3. Tap the month when daylight saving begins.
4. Tap the Week pick list.
5. Select the week when daylight saving begins within the selected month.
6. Tap the Day pick list.

7. Select the day of the week when daylight saving begins within the selected week.
8. Tap OK.
9. Tap the End box and repeat steps 3 through 8 to select when daylight saving ends.
10. Tap OK.

## Modifying a location

You can edit the location information.

**To modify a location:**

1. Tap a Location pick list.
2. Select Edit List.
3. Select the location you want to modify.
4. Tap Edit.
5. Adjust the settings. See [“Adding a location”](#) earlier in this chapter for details.
6. Tap OK.
7. Tap Done.

## Removing a location

You cannot remove a location that is currently assigned to the primary location.

**To remove a location:**

1. Tap a Location pick list.
2. Select Edit List.
3. Select the location you want to remove.
4. Tap Remove.
5. Tap OK to confirm the deletion.
6. Tap Done.



## Setting an alarm

You can set an alarm to sound during the next 24-hour period.

### To set an alarm:

1. Tap the box next to the Alarm  icon to open the Set Alarm dialog box.
2. Tap the time columns to set the hour and minute.
3. Tap OK.
4. When the alarm reminder message appears, do one of the following:

Tap OK to permanently dismiss the reminder and return to the current screen.

Tap Snooze to dismiss the reminder and return to the current screen. An attention indicator blinks in the upper-left corner of the screen to remind you of the pending alarm, and the reminder message appears again in five minutes.

When the reminder message reappears, the current time appears in the Reminder bar and the alarm time appears on the screen.

Tap Go To to open World Clock and to dismiss the alarm.

## Using World Clock menus

World Clock features that are not explained elsewhere in this book are described here. See “Using menus” in [Chapter 4](#) for information about choosing menu commands.

### Options menu

**Display Options** Opens a dialog box where you can choose which information appears on the World Clock screen.

**Show Multiple Locations:** Activates the secondary location displays. When it is selected, the secondary locations appear below the primary location.

**Date:** Activates the date display. When it is selected, the date appears below the time for each location.

### Alarm Preferences

**Sound:** Sets the sound of the alarm. The choices are Alarm, Bumble Bee, Reveille, Sonata, Wake Up, and Warbler.

**Volume:** Defines how loud the alarm sounds. The choices are Low, Medium, and High.



# Performing HotSync® Operations

HotSync® technology enables you to synchronize data between one or more Palm OS® handhelds and Palm™ Desktop software or another personal information manager (PIM) such as Microsoft Outlook. To synchronize data, you must connect your handheld and your computer either directly or indirectly. Direct methods include placing your handheld in the cradle/cable attached to your computer, using infrared communications, or using a Bluetooth™ connection. Indirect methods include using a modem or network HotSync technology.

## Selecting HotSync setup options

You can choose when HotSync Manager will run. If necessary, you can adjust the local and modem HotSync settings as well.

**To set the HotSync options on a Windows computer:**

1. Click the HotSync icon  in the Windows system tray (lower-right corner of the taskbar).

If you do not see the HotSync icon, you need to start HotSync Manager: On the Windows desktop, click Start, and then select Programs. Navigate to the Palm Desktop software program group, and select HotSync Manager.

Alternatively, you can start the Palm Desktop software, which automatically opens the HotSync Manager.

2. Select Setup.

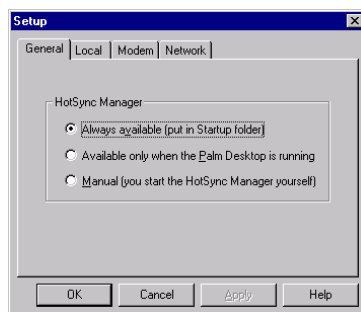

3. Click the General tab, and select one of the following options:

- |   |   |
|---|---|
| <b>Always available</b>   | Adds HotSync Manager to the Startup folder and constantly monitors the communication port for synchronization requests from your handheld. With this option the HotSync Manager synchronizes data even when Palm Desktop software is not running. |
| <b>Available only when the Palm Desktop software is running</b> | Starts HotSync Manager and monitors requests automatically when you open Palm Desktop software.   |
| <b>Manual</b>   | Monitors requests only when you select HotSync Manager from the Start menu.   |

If you're not sure which option to use, keep the default setting: Always available.

4. If you are using a serial cradle/cable, click the Local tab to display the settings for the connection between your computer and the handheld cradle/cable, and adjust the following options as needed.

If you are using the USB cradle/cable, you do not need to use the settings on the Local tab for a direct HotSync operation.

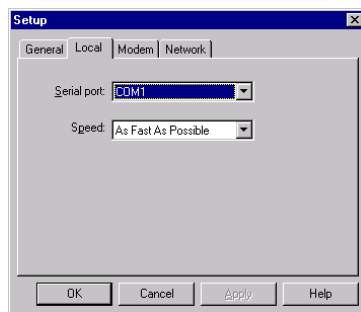

- |                    |  |
|--------------------|--|
| <b>Serial Port</b> | Identifies the port that HotSync Manager uses to communicate with the cradle/cable. If necessary, you can change the port selection. |
|--------------------|--|

Your handheld cannot share this port with an internal modem or other device.

- |              |   |
|--------------|---|
| <b>Speed</b> | Determines the speed at which data is transferred between your handheld and Palm Desktop software. Try the As Fast As Possible rate first, and adjust downward if you experience problems. This setting allows your handheld to synchronize with your computer at the fastest speed possible. |
|--------------|---|

5. Click the Modem tab to display the modem settings and adjust the options as needed. For more information, see “[Conducting modem HotSync operations](#)” later in this chapter.
6. If your computer is attached to a network, click the Network tab to display the network settings and adjust the options as needed. For more information, see “[Conducting network HotSync operations](#)” later in this chapter.
7. Click OK.

**To set the HotSync options on a Mac computer:**

1. Double-click the HotSync Manager icon in the Palm folder.
2. Click the HotSync Controls tab, and select any of the following options.

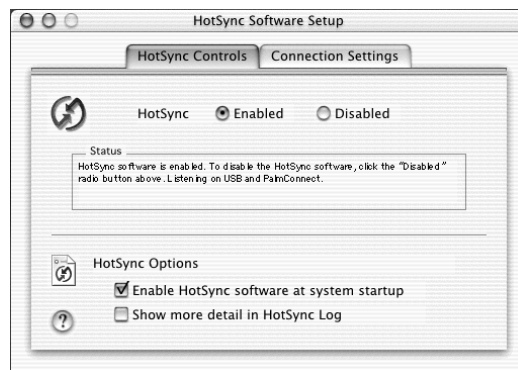

Shown with Mac OS X

**HotSync Enabled/  
Disabled**

Activates the transport monitor and prepares your Mac computer to synchronize with your handheld. By default, the transport monitor is enabled to listen on USB and PalmConnect whenever you start your computer.

If you are using Mac OS 9.1 and the optional serial HotSync cradle/cable and you use the same serial port for other devices besides the HotSync cradle/cable, disable the transport monitor and then enable it manually only when you connect the cradle/cable to perform a HotSync operation.

**Enable HotSync  
software at system  
startup**

Activates the transport monitor automatically each time you start your computer. If this option is not selected, you must open HotSync Manager and select the Enabled option before you can perform a HotSync operation.

**Show more detail  
in HotSync Log**

Includes more troubleshooting information in the log that is generated when you perform a HotSync operation.

**NOTE** The Connection Settings tab for a direct HotSync operation are set automatically when you perform the first HotSync operation.

- If you are using the USB cradle/cable, you do not need to adjust the settings on the Connection Settings tab for a direct HotSync operation; they are set automatically when you perform the first HotSync operation.

If you are using Mac OS 9.1 and the optional serial cradle/cable, click the Connection Settings tab and select the port where you attached the cradle/cable.

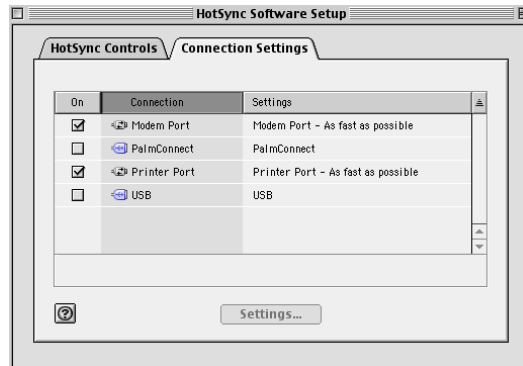

Shown with Mac OS 9.1

You can set both Modem and Printer port settings and prepare your computer to synchronize with your handheld using the HotSync cradle/cable or a modem. However, choosing both setups prevents you from using either port for other operations such as printing, faxing, or AppleTalk networking.

- Close the HotSync Software Setup window.

## Customizing HotSync application settings

For each application, you can define a set of options that determines how records are handled during synchronization. These options are called a *conduit*. By default, a HotSync operation synchronizes all files between the handheld and Palm Desktop software.

---

**IMPORTANT** If you are synchronizing data between Microsoft Outlook and your handheld, you can customize the conduit settings from your handheld by selecting Microsoft Outlook from the HotSync Options menu. For complete details about MS Outlook conduit settings, see the MS Outlook conduit help in HotSync Manager.

Follow these steps to access MS Outlook conduit help:

- Click the HotSync icon  in the Windows system tray
  - Select Custom.
  - Select one of the Outlook conduits from list.
  - Select Change.
  - Select one of the conduits from the list.
-

In general, you should leave the default settings to synchronize all files. The only reason you might want to change these settings is to overwrite data on either your handheld or Palm Desktop software, or to avoid synchronizing a particular type of file because you don't use it.

In addition to the conduits for Calendar, Contacts, Tasks, Memos, Note Pad, Voice Memo, and Palm™ Photos, Palm Desktop software includes System and Install conduits. The System conduit backs up the system information stored on your handheld, including Graffiti® 2 ShortCuts. The Install conduit installs add-on applications on your handheld.

**To customize HotSync application settings on a Windows computer:**

1. Click the HotSync icon  in the Windows system tray (lower-right corner of the taskbar).

You can also click the HotSync command on the Palm Desktop software menu bar.

2. From the HotSync Manager menu, select Custom.
3. Select the appropriate username from the list.
4. Select an application in the Conduit list.
5. Click Change.
6. For each application, click the direction in which you want to write data, or click Do Nothing to skip data transfer for an application.

Changing the HotSync setting from the default affects only the *next* HotSync operation. Thereafter, the HotSync Actions revert to their default settings. To use a new setting on an ongoing basis, select the Set As Default box. Thereafter, whatever you selected as the default setting is used when you click the Default button in the Custom dialog box.

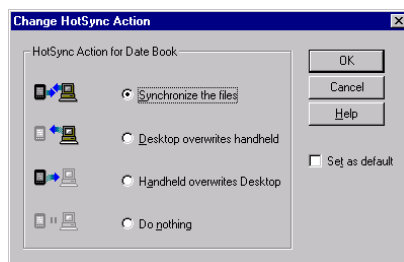

7. Click OK.
8. Click Done to activate your settings.

To customize HotSync application settings on a Mac computer:

1. Double-click the Palm Desktop icon in the Palm folder.
2. From the HotSync menu, select Conduit Settings.
3. From the User pop-up menu, select the appropriate username.
4. Select an application in the Conduit list.
5. Click Conduit Settings.
6. For each application, click the direction in which you want to write data, or click Do Nothing to skip data transfer for an application.

Changing the HotSync setting from the default affects only the *next* HotSync operation. Thereafter, the HotSync Actions revert to their default settings. To use a new setting on an ongoing basis, click Make Default. Thereafter, whatever you selected as the default setting is used for HotSync operations.

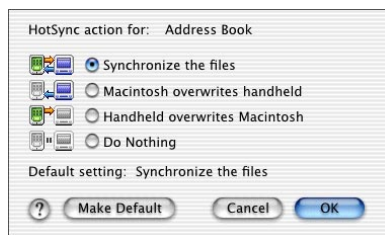

Shown with Mac OS X

7. Click OK.
8. Close the Conduit Settings window.

## Conducting cradle/cable HotSync operations

The simplest way to synchronize data is to perform a direct HotSync operation by seating your handheld in the cradle/cable and pressing the HotSync button.

### Performing a cradle/cable HotSync operation: Windows computers

The first time you synchronize your data, you need to enter user information on Palm Desktop software. After you enter this information and synchronize with your handheld, the HotSync Manager recognizes your handheld and doesn't ask for this information again.

If you are a system administrator preparing several handhelds for a group of users, you may want to create a user profile. See [“Creating a user profile”](#) later in this chapter before performing the following steps.

---

**IMPORTANT** You must perform your *first* HotSync operation with a local, direct connection or with infrared communication, rather than with a modem or network.

---



The following steps assume that you have already installed Palm Desktop software. If you have not installed this software, see “[Step 4: Run Palm Setup Wizard](#)” in [Chapter 1](#) for instructions.

To perform a local HotSync operation on a Windows computer:

1. Place your handheld in the cradle/cable.

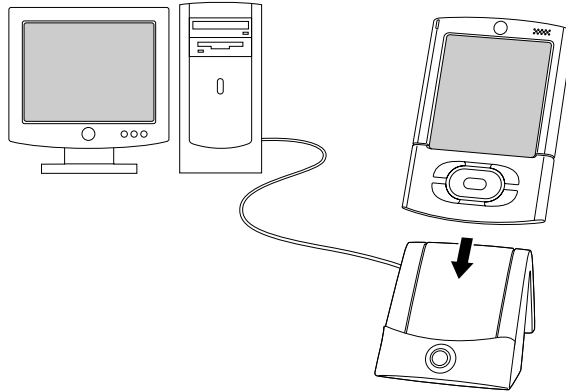

2. If the HotSync Manager is not running, start it: On the Windows desktop, click Start, and then select Programs. Navigate to the Palm Desktop software program group, and select HotSync Manager. Alternatively, you can start the Palm Desktop software, which automatically opens the HotSync Manager.
3. Press the HotSync button  on the cradle/cable.

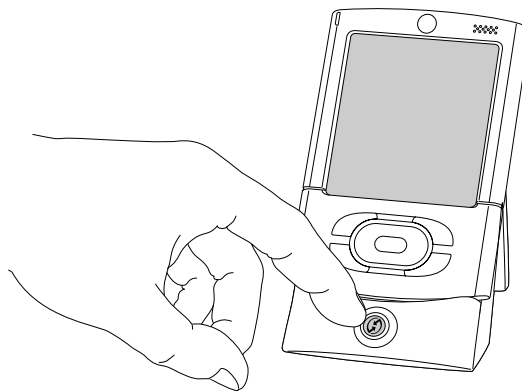

---

**IMPORTANT** The first time you perform a HotSync operation, you must enter a username in the New User dialog box and click OK. Every handheld should have a unique name. To prevent loss of a user's records, never try to synchronize more than one handheld to the same username.

---

The HotSync Progress dialog box appears, and synchronization begins.

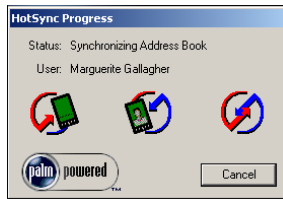

4. Wait for a message on your handheld indicating that the process is complete.

When the HotSync process is complete, you can remove your handheld from the cradle/cable. Gently tilt your handheld forward in the cradle/cable, and then lift it up to remove it.

## Performing a direct HotSync operation: Mac computers

When you installed Palm Desktop software, you entered a username. This user name is the connection between your handheld and your computer.

The first time you perform a HotSync operation the Palm Desktop software does the following:

- Adds a username to your handheld.
- Creates a folder for the username in the Users folder inside the Palm folder. For example, if you entered Jane Garcia as your user name, a folder named Jane Garcia is created in the Users folder.

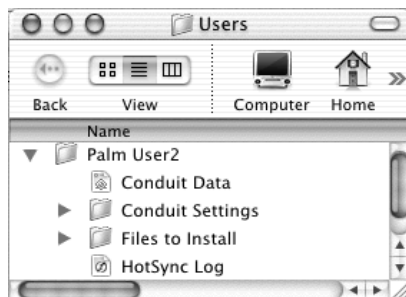

Shown with Mac OS X

- Creates a file named User Data in your username folder.

User names appear in the User pop-up menu on the right side of the toolbar. You can change users by selecting a new name in the pop-up menu.

Each subsequent time you perform a HotSync operation, HotSync Manager reads the username from your handheld and synchronizes the data in the folder of the same name.

Be sure you select the correct username from the User pop-up menu before entering data on Palm Desktop or performing a HotSync operation.

If you are a system administrator preparing several handhelds for a group of users, you may want to create a user profile. See [“Creating a user profile”](#) later in this chapter before performing the following steps.

---

**IMPORTANT** You must perform your *first* HotSync operation with a local, direct connection or with infrared communication, rather than with a modem.

---

The following steps assume that you have already installed Palm Desktop software. See [“Step 4: Run Palm Setup Wizard”](#) in [Chapter 1](#) if you have not installed this software.

**To perform a local HotSync operation on a Mac computer:**

1. Place your handheld in the HotSync cradle/cable.

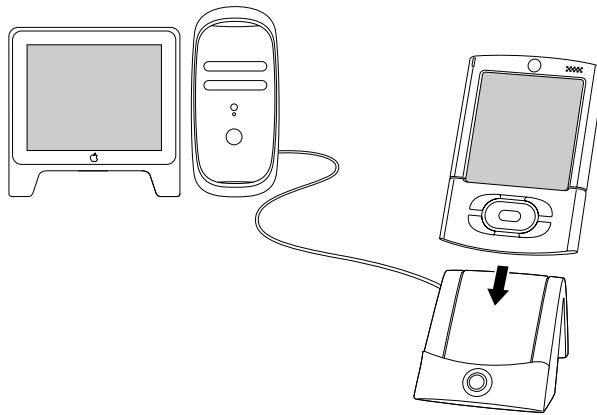

2. Make sure that HotSync Manager is enabled: Double-click the HotSync Manager icon in the Palm folder. Click the HotSync Controls tab, and make sure the Enabled option is selected.
3. Press the HotSync button  on the cradle/cable.

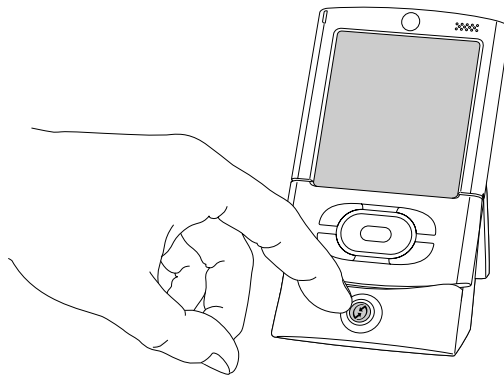

The HotSync Progress dialog box appears, followed by the Select User dialog box.

4. In the Select User dialog box, select the user name you entered when you installed the Palm Desktop software, and click OK.

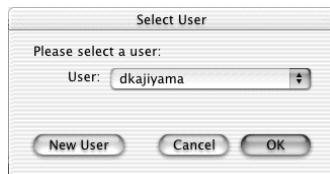

Shown with Mac OS X

The HotSync Progress dialog box reappears, and synchronization begins.

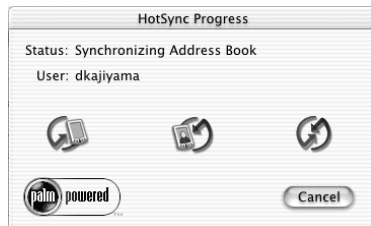

Shown with Mac OS X

5. Wait for a message on your handheld indicating that the process is complete.

When the HotSync process is complete, you can remove your handheld from the cradle/cable. Gently tilt your handheld forward in the cradle/cable, and then lift it up to remove it.

## Conducting IR HotSync operations

You can use the infrared (IR) port on your handheld to perform HotSync operations. When you perform an IR HotSync operation, you don't need your cradle/cable. However, you must have a computer that's equipped with an IR port and that supports the IrCOMM implementation of the Infrared Data Association (IrDA) standards. This is especially useful if you travel with an infrared-enabled laptop. You simply enable infrared communication on your laptop and handheld and follow the steps in ["Performing an IR HotSync operation"](#) later in this section.

## Preparing your computer for infrared communication

Before you can perform a HotSync operation using the IR port, the computer with which you want to synchronize must fulfill these requirements:

- Your computer must support the IrCOMM implementation of the IrDA standards.
- Your computer must have an enabled infrared port that's built into the computer, or an enabled infrared device attached to the computer.
- Some desktop computers may require an infrared device attached to a physical COM port. Laptops are likely to have a built-in IR port, so no external device is necessary.

- Your computer must have an installed infrared driver.
- If you have an external infrared device attached to your computer, a driver is probably included with the device. Consult the documentation included with the device for information on installing the required driver.

Check your computer's documentation to learn whether the computer supports infrared communication.

**To configure HotSync Manager for infrared communication on a Windows computer:**

- Click the HotSync Manager icon  in the Windows system tray, and make sure that Infrared is selected.
  - If you have an Infrared option on the HotSync Manager menu, and that option is selected, skip to [“Performing an IR HotSync operation.”](#)
  - If you do not have an Infrared option on the HotSync Manager menu, complete the following steps:
    - a. Make sure that Local Serial is selected on the menu.
    - b. From the HotSync Manager menu, select Setup.
    - c. Click the Local tab.
    - d. In the Serial Port drop-down box, select the simulated port that your computer uses for infrared communication.

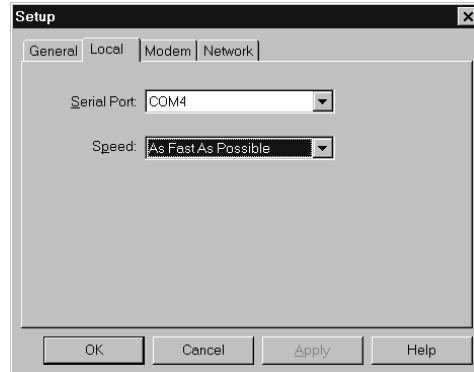

See the documentation for your operating system for instructions on finding the simulated port. This information is usually located in the Control Panel.

- e. Click OK.

**NOTE** If your cradle/cable is connected to a USB port, you can continue using the cradle/cable while HotSync Manager is configured for infrared communication. If your cradle/cable is connected to a serial port, you cannot use your HotSync cradle/cable again until you reconfigure the HotSync Manager to communicate with the port defined for cradle/cable synchronization.

To configure HotSync Manager for infrared communication on a Mac computer:

1. Double-click the HotSync Manager icon  in the Palm folder.
2. In the HotSync Controls tab, select Enabled.
3. Click the Connection Settings tab.
4. Select the On check box next to IR port.

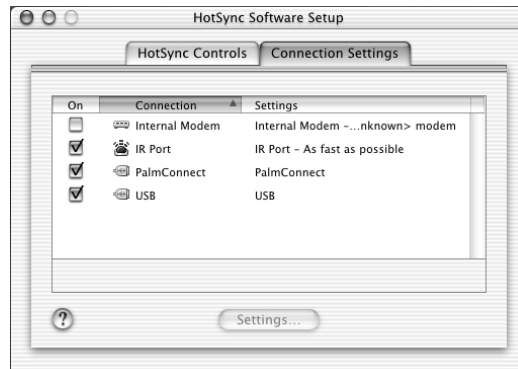



Shown with Mac OS X

5. Close the HotSync Software Setup window.

## Performing an IR HotSync operation

After you complete the steps to prepare for performing an IR HotSync operation, it's easy to perform the actual operation.

To perform an IR HotSync operation:

1. Tap the Home icon .
2. Select the HotSync icon .
3. Tap Local.
4. Tap the pick list below the HotSync icon and select IR to a PC/Handheld.
5. Position the IR port of your handheld within a couple of inches of the infrared port of your computer.
6. Tap the HotSync icon  to start the IR HotSync operation.

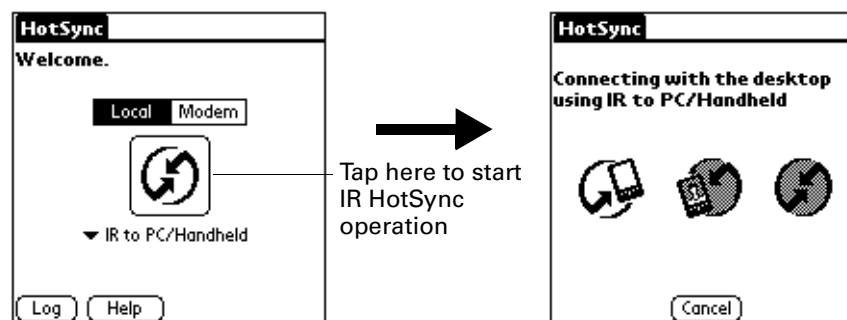

## Returning to cradle/cable HotSync operations

If your cradle/cable is connected to a USB port, you can continue using it while HotSync Manager is configured for infrared communication. Use the following instructions to return to local USB cradle/cable HotSync operations only when necessary, such as when you have disconnected the cradle/cable from the USB port.

### To return to local USB cradle/cable HotSync operations on a Windows computer:

1. If necessary, connect the cradle/cable to the USB port of the computer you use for HotSync operations.
2. Click the HotSync Manager icon  in the Windows system tray, and select Local USB if it is not already selected.

### To return to local serial cradle/cable HotSync operations on a Windows computer:

1. If necessary, connect the cradle/cable to the port of the computer you use for HotSync operations.
2. Click the HotSync Manager icon  in the Windows system tray.
3. Select Setup, and then click Local.
4. Select the COM port where your cradle/cable is connected.
5. Click OK.

On a Mac computer, the HotSync Manager software monitors all ports at the same time. However, you may want to turn off the IR port when you're not using, to improve performance of HotSync operations.

### To return to local serial cradle/cable HotSync operations on a Mac computer:

1. If necessary, connect the cradle/cable to a serial port on your computer.
2. Double-click the HotSync Manager icon in the Palm folder.
3. In the HotSync Controls tab, select Enabled.
4. Click the Connection Settings tab, and select the correct connection.
5. Close the HotSync Software Setup window.

The next time you want to perform a HotSync operation, just press the HotSync button on the cradle/cable, as you always did before.

## Conducting modem HotSync operations

You can use a modem to synchronize your handheld when you are away from your computer.

---

**IMPORTANT** You must perform the first HotSync operation by using a local, direct connection or infrared communication. After that, you can perform a modem HotSync operation.

---

To perform a modem HotSync operation you need the following:

- A modem connected to your computer.
- Palm Desktop software configured for use with the modem.
- A modem connected to your handheld.
- A configuration for the kind of modem connection you want to make. See [“Connection Preferences”](#) in [Chapter 21](#) for more information.

## Preparing your computer for a modem HotSync operation

Be sure to perform these steps before you leave your office so that your computer is ready to receive a call from your handheld.

**To prepare a Windows computer for a modem HotSync operation:**

1. Confirm that the computer modem is connected and turned on and that no communications applications, such as fax or telephony software, are running on a COM port.

Make sure the computer is disconnected from all online services, such as America Online (AOL). This helps to avoid conflicts with the COM port.

2. Start HotSync Manager if it is not already running, and from the HotSync Manager menu, select Modem.



- Adjust the following options as needed.

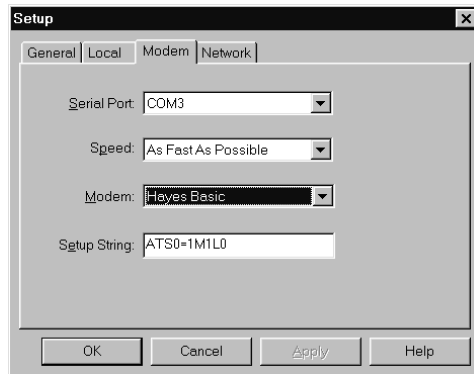

- Serial Port** Identifies the port for the modem. If you are unsure of the port assignment, look at the Modem Properties in the Windows Control Panel.
- Speed** Determines the speed at which data is transferred. Try the As Fast As Possible rate first, and adjust downward if you experience problems. This setting allows your handheld to synchronize with your computer at the fastest speed possible.
- Modem** Identifies the modem type or manufacturer. Refer to your modem manual or faceplate for its type or settings. If you're not sure of your modem type or if your modem doesn't match any that appear in the list, select Hayes Basic.
- Setup String** Identifies the setup string for your particular modem. Not all modems require a setup string. Refer to your modem manual, and enter the setup string if it is recommended by the manufacturer.

- Click OK.

**To prepare a Mac computer for a modem HotSync operation:**

- Confirm that the computer modem is connected and turned on and that no communications applications, such as fax or telephony software, or AppleTalk networking are running on that serial port.

Make sure your computer is disconnected from all online services, such as CompuServe and America Online (AOL). This helps to avoid conflicts with the serial port. In addition, your computer must be on, and it should not be in sleep mode when receiving a call from a remote handheld.

- Double-click the HotSync Manager icon in the Palm folder.
- Click the HotSync Controls tab and enable the Transport Monitor, if it is not already enabled.

4. Click the Connection Settings tab.
5. Select the On check box for the modem connection you're using, and then click Settings.
6. In the Settings dialog box, select Modem as the connection type, if it is not already selected.

**NOTE** This step is not necessary for internal modems.

7. Adjust the following options as needed.

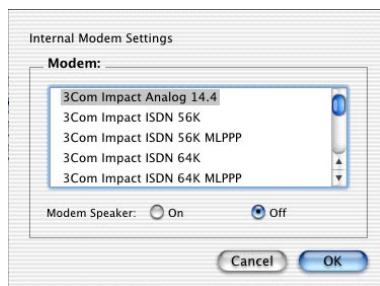

Shown with Mac OS X

**Modem** Identifies the type of modem connected to your computer. If your modem does not appear on the list, use the Hayes Basic setting, or select Custom to enter a command string. Refer to the manual that came with your modem to find the appropriate command string.



**Modem Speaker** Activates the modem's speaker. If you are having trouble connecting, turn on this option to make sure that the modem connected to your computer is responding to incoming calls.

8. Click OK.
9. Close the HotSync Software Setup window.

## Preparing your handheld for a modem HotSync operation

There are a few steps you must perform to prepare your handheld for a modem HotSync operation.

**To prepare your handheld for a modem HotSync operation:**

1. Tap the Home icon .
2. Select the HotSync icon .
3. Tap Modem.

4. Tap the pick list below the icon and select a modem configuration.

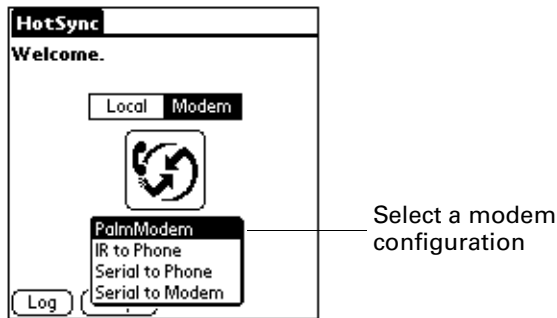

If you need to create a configuration, tap the Menu icon , and then select Connection Setup on the Options menu. See [“Connection Preferences”](#) in [Chapter 21](#) for more information.

5. Tap the Enter phone # field.

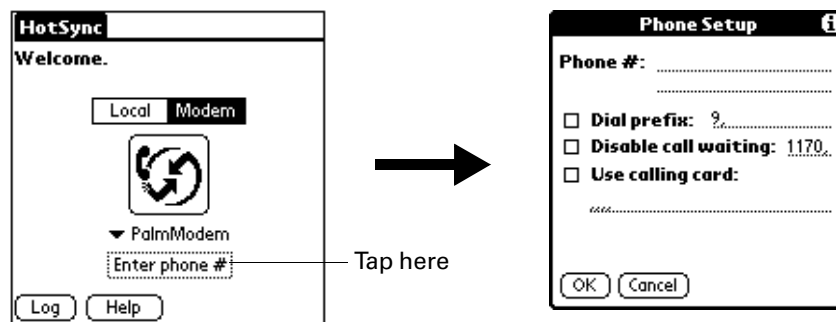

If you plan to connect to your company’s dial-in server (network modem) instead of connecting to a computer modem, see [“Conducting network HotSync operations”](#) later in this chapter.

6. Enter the telephone number to access the modem connected to your computer.
7. If necessary, enter a dial prefix (such as “9”) to access an outside line, and then tap the Dial Prefix check box.

**TIP** You can enter a comma in the field to introduce a “pause” in the dialing sequence. Each comma equals a two-second pause.

8. If the phone line you’re using for the handheld has Call Waiting, select the Disable call waiting check box to avoid an interruption during the modem HotSync operation.
9. If you want to use a calling card to place the call, select the check box and enter the calling card number.
10. Tap OK.

## Selecting the conduits for a modem HotSync operation



The Conduit Setup dialog box on your handheld enables you to define which files and/or applications are synchronized during a modem HotSync operation. You can use these settings to minimize the time required to synchronize data with a modem.

**IMPORTANT** If you are synchronizing data between Microsoft Outlook and your handheld, you can customize the conduit settings from your handheld by selecting Microsoft Outlook from the HotSync Options menu. For complete details about MS Outlook conduit settings, see the MS Outlook conduit help in HotSync Manager.

Follow these steps to access MS Outlook conduit help:

- Click the HotSync icon  in the Windows system tray
- Select Custom.
- Select one of the Outlook conduits from list.
- Select Change.
- Select one of the conduits from the list.

To change the Conduit Setup for a modem HotSync operation:

1. Tap the Home icon .
2. Select the HotSync icon .
3. Tap the Menu icon .
4. Select Conduit Setup from the Options menu.
5. Tap the check boxes to deselect the files and applications that you do *not* want to synchronize during a modem HotSync operation. The default setting is to synchronize all files.

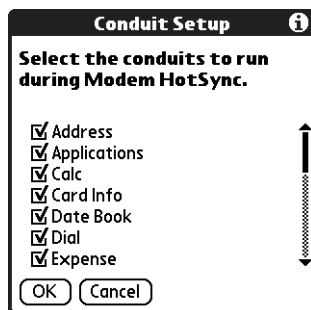



Applications that do not have a database (such as games) are not synchronized, even if you select the item in the Conduit Setup dialog box.

6. Tap OK.

## Performing a modem HotSync operation

After you prepare your computer and your handheld and select your Conduit Setup options, you are ready to perform a modem HotSync operation.

To perform a modem HotSync operation:

1. Tap the Home icon .
2. Select the HotSync icon .
3. Tap the Modem icon  to dial the Palm Desktop modem and synchronize the applications.
4. Wait for the HotSync operation to complete. If you have any problems conducting a successful HotSync operation, see “HotSync problems” in [Appendix B](#).

## Conducting Bluetooth HotSync operations

If you have a Bluetooth computer running Windows 98/Me/NT/2000 or Mac OS X, version 10.1.2 or later with the Apple Bluetooth software, you can use Bluetooth technology to perform wireless HotSync operations.

**NOTE** Go to the web site [www.palm.com/support](http://www.palm.com/support) for additional information on compatibility with other versions of the Windows operating system.

## Preparing your computer for a Bluetooth HotSync operation

There are a few steps you must perform to prepare your computer for a Bluetooth HotSync operation.

To prepare your Windows computer for a Bluetooth HotSync operation:

1. Use the Bluetooth setup software on your computer to open or create a virtual serial port for Bluetooth communication. See the documentation included with your computer for instructions on changing port settings or configuring the Bluetooth serial host.
2. Click the HotSync Manager icon  in the Windows system tray, and then select Setup.

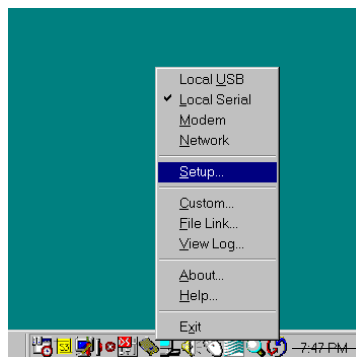

Click the HotSync Manager icon

3. Click the Local tab.

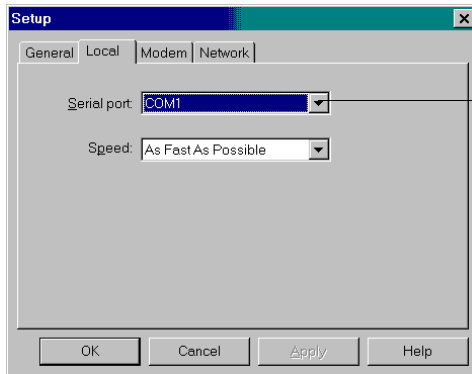

Select the port from the drop-down list

4. In the Serial port drop-down box, select the virtual serial port you chose or created in step 1.
5. Click OK.

**To prepare your Mac computer for a Bluetooth HotSync operation:**

1. Double-click the HotSync Manager icon  in the Palm folder.
2. In the HotSync Controls tab, select Enabled.
3. Click the Connection Settings tab, and select the On check box next to bluetooth-pda-sync-port.

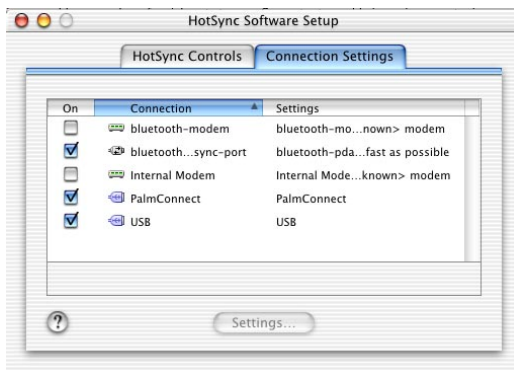



Shown with Mac OS X

4. Close the HotSync Software Setup window.

## Preparing your handheld for a Bluetooth HotSync operation

There are a few steps you must perform to prepare your handheld for a Bluetooth HotSync operation.

To prepare your handheld for a Bluetooth HotSync operation:

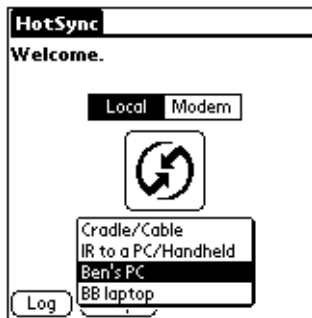

1. Create a trusted pair with your computer. See [“Adding trusted devices”](#) in [Chapter 21](#) for details.
2. Create a connection with your computer. See [“Creating Bluetooth connections”](#) in [Chapter 21](#) for details.
3. Tap the Home icon .
4. Select the HotSync icon .
5. Tap the pick list in the center of the screen and select the connection settings you just created.



## Performing a Bluetooth HotSync operation

After you prepare your computer and your handheld, you are ready to perform a Bluetooth HotSync operation.

To perform a Bluetooth HotSync operation:

1. Tap the Home icon .
2. Select the HotSync icon .
3. Tap the HotSync icon in the center of the screen.

## Conducting network HotSync operations

When you use the network HotSync technology, you can take advantage of the LAN and WAN connectivity available in many office environments. Network HotSync technology enables you to perform a HotSync operation by using Bluetooth technology or an 802.11 accessory to make a wireless connection to a network, by dialing in to a network, or by using a cradle/cable that is connected to any computer on your LAN or WAN (provided that the computer connected to the cradle/cable also has the network HotSync technology installed, your computer is on, and the HotSync Manager is running).

---

**IMPORTANT** Network HotSync technology is available only on Windows computers. You must perform the first HotSync operation by using a local, direct connection or infrared communication. After that, you can perform a network HotSync operation.

---

### Connecting to your company's dial-in server

A network HotSync operation requires the following (consult your system administrator for assistance):

- Your computer has TCP/IP support installed.
- Both your company's network system and its remote access server support TCP/IP.
- You have a remote access account.

Everything you need for connecting to your company's dial-in server (network modem) is included with Palm Desktop software and handheld software. You need to activate the feature, however, on both Palm Desktop software and your handheld.

To prepare your Windows computer for a network HotSync operation:

1. Click the HotSync Manager icon  in the Windows system tray.
2. From the HotSync Manager menu, select Network.

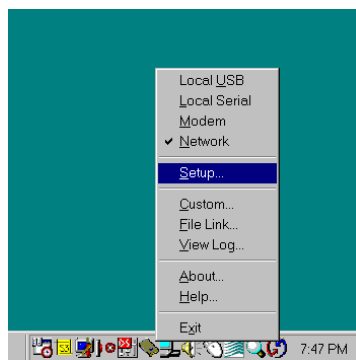



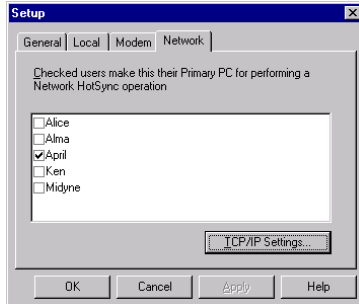

3. From the HotSync Manager menu, select Setup.
4. Click the Network tab and make sure your user name has a checkmark next to it. If the checkmark is not there, click the check box next to your user name.



5. Click OK.
6. Put your handheld in the cradle/cable, and perform a HotSync operation.  
The HotSync operation records network information about your computer on your handheld. With this information, your handheld can locate your computer when you perform a HotSync operation over the network.

**To prepare your handheld for a network HotSync operation:**

1. Tap the Home icon .
2. Select the HotSync icon .
3. Tap the Menu icon .
4. From the Options menu, select Modem Sync Prefs.
5. Tap Network.

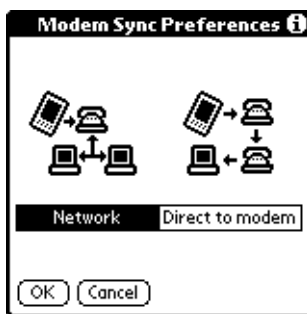

6. Tap OK.

7. Tap Select Service.

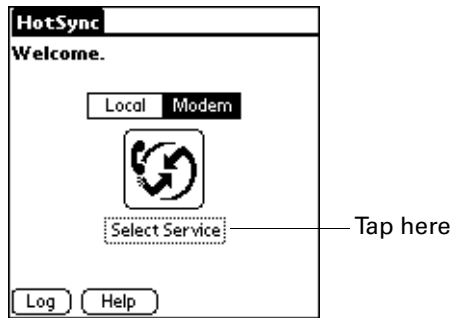

**NOTE** See “[Network Preferences](#)” in [Chapter 21](#) for information on creating a network or Bluetooth connection.

8. Tap Service and select a service.

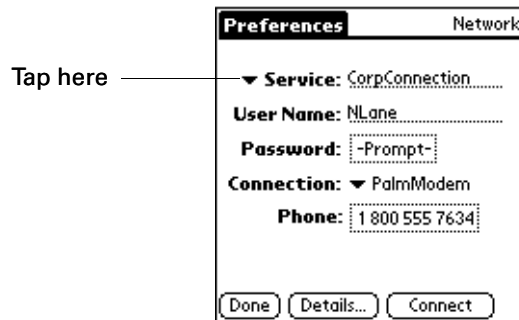

9. Tap Done.
10. Tap the Menu icon .
11. From the Options menu, select Conduit Setup.

For instructions, see “[Selecting the conduits for a modem HotSync operation](#)” earlier in this chapter.

## Performing a network HotSync operation

After you prepare your computer and your handheld and select your Conduit Setup options, you are ready to perform a network HotSync operation.

To perform a network HotSync operation:

- Tap the modem HotSync icon to begin the operation.

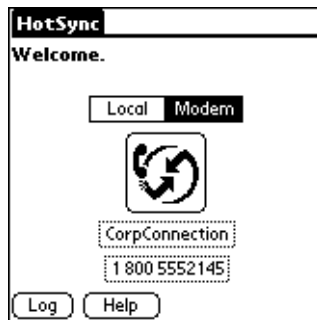

## Using File Link

The File Link feature enables you to import Contacts and Memos information onto your handheld from a separate external file such as a company phone list. HotSync Manager stores the data in a separate category on your Palm Desktop software and your handheld. You can configure the File Link feature to check for changes to the external file when you perform a HotSync operation.

With File Link you can import data stored in any of the following formats:

- Comma-separated (\*.csv)
- Memos archive (\*.mpa)
- Contacts archive (\*.aba)
- Text (\*.txt)

For information on how to set up a file link, see the Palm Desktop online Help.

**NOTE** The File Link feature is not available in Palm Desktop software for Mac.

## Creating a user profile

A user profile enables you to install the same set of data onto multiple Palm OS handhelds before each handheld is individualized with a specific username and data file.

A handheld that is preconfigured with a user profile can be given to anyone, because the handheld is not yet identified by a unique username. The handheld acquires a unique username when the new user performs his or her first local HotSync operation.

For example, suppose a sales organization wants to distribute two dozen handhelds that all have a common company phone list, a set of memos, and several key applications. A user profile can be created to install the common data before the handhelds are distributed to the employees who will use them. Then when the employees perform their first HotSync operation, the common data becomes part of their individual data file.

**NOTE** The handhelds that are synchronized with a user profile must be either new ones that have never been synchronized or handhelds that have had their usernames and data removed by a hard reset.

**To create a user profile on a Windows computer:**

1. Open Palm Desktop software.
2. From the Tools menu, select Users.
3. Click Profiles.
4. Click New.

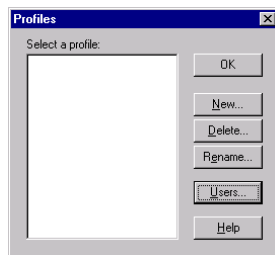

5. Enter a unique name for the profile, and click OK.

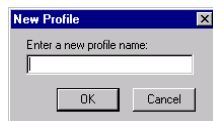

6. Repeat steps 3 through 5 for each profile that you want to create, and then click OK to return to Palm Desktop software.
7. Select the profile from the User list, and create the data for the profile (such as a company phone list).

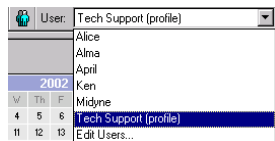

**To create a user profile on a Mac computer:**

1. Open Palm Desktop software.
2. From the User pop-up menu, select Edit Users.
3. Click New Profile.

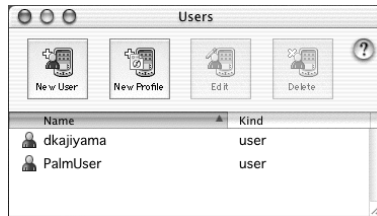

Shown with Mac OS X

4. Enter a unique name for the profile, and click OK.



Shown with Mac OS X

5. Close the Users window.
6. From the User pop-up menu, select the new profile.
7. Create the data for the profile (such as a company phone list).
8. From the HotSync menu, select Conduit Settings.
9. Select the conduit settings for the profile. For details, see [“Customizing HotSync application settings”](#) earlier in this chapter.

## Performing the first HotSync operation with a user profile

After you create a user profile, you are ready to transfer the information to the new handheld during the first HotSync operation.

**To use a profile for a first-time HotSync operation on a Windows computer:**

1. Place the new handheld in the cradle/cable.
2. Press the HotSync button  on the cradle/cable.
3. Click Profiles.

4. Select the profile you want to load on the handheld, and click OK.



5. Click Yes to transfer all the profile data to the handheld.

The next time you perform a HotSync operation, Palm Desktop software prompts you to assign a username to the handheld.

**To use a profile for a first-time HotSync operation on a Mac computer:**

1. Connect the new handheld to the HotSync cradle/cable.
2. Press the HotSync button  on the cradle/cable.
3. Select the profile you want to load on the handheld, and click OK to transfer all the profile data to the handheld.

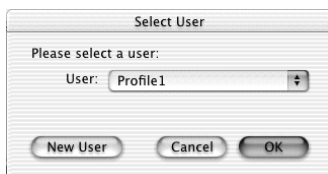

Shown with Mac OS X

The next time you perform a HotSync operation, Palm Desktop software prompts you to assign a username to the handheld.

# Setting Preferences for Your Handheld

Preferences are grouped into three categories: General, Communication, and Personal. Use preferences to do the following:

- Access the General Preferences screens to customize any of the following settings:

<b>Date &amp; Time</b>	Set the location, date, and time.
<b>Digitizer</b>	Calibrate the screen on your handheld.
<b>Formats</b>	Set the country default and the formats for times, dates, calendar, and numbers.
<b>Graffiti 2</b>	Select alternate strokes for selected Graffiti® 2 characters.
<b>Keylock</b>	Prevent your handheld from turning on accidentally.
<b>Power</b>	Set these features: auto-shutoff interval, Stay on in cradle, Beam receive, Power on when opened, and Power off when closed.
<b>Security</b>	Set a password, privacy options, and locking options.
<b>Sounds &amp; Alerts</b>	Select system, game, and alarm options from three profiles: Custom, Silent, and All Off.
  
- Access the Communication Preferences screens to customize any of the following settings:

<b>Bluetooth</b>	Turn Bluetooth™ communication on and off, assign a name to your handheld, and configure device discovery and wakeup settings.
<b>Connection</b>	Configure communication settings.
<b>Network</b>	Configure your handheld for use with a network.
<b>Phone</b>	Select a connection for use with wireless data and phone applications on your handheld.

- Access the Personal Preferences screens to customize any of the following settings:

<b>Buttons</b>	Assign an application to the Favorites icon. Reassign various applications to the following: the application buttons on the front and side panels of your handheld, the HotSync® button on the cradle/cable, and the full-screen pen stroke command.
<b>Color Theme</b>	Select a color theme to change the appearance of your handheld screen.
<b>Handedness</b>	Select your orientation for handwriting with Graffiti 2.
<b>Owner</b>	Enter your name, phone number, and other owner information to your handheld.
<b>ShortCuts</b>	Define a list of Graffiti 2 abbreviations.

## Accessing Preferences

The Preferences screen gives you access to the handheld preferences. Preferences for individual applications are discussed in the application chapters.

To open the Preferences screens:

1. Tap the Home icon .
2. Tap the Prefs icon .
3. From the Preferences list select a Preferences screen.

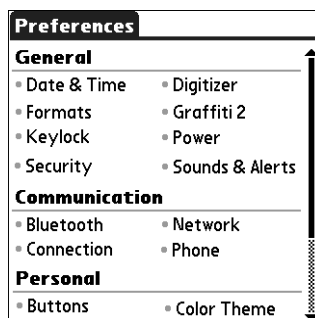

## Bluetooth Preferences

You can connect your handheld with Bluetooth devices such as:

- Mobile phones
- Computers



- LAN access points
- Palm OS® handhelds

The other Bluetooth device must be within range (typically 10 meters or approximately 30 feet) of your handheld.

The Bluetooth Preferences screen enables you to configure settings that determine how your handheld communicates with other Bluetooth devices. You can turn Bluetooth communication on and off, assign a name to your handheld for Bluetooth communication, and choose device discovery and wakeup settings.

## Turning Bluetooth communication on and off

By default, the Bluetooth communication feature on your handheld is turned off. The default setting is designed to conserve battery power. When Bluetooth communication is off, you cannot communicate with other Bluetooth devices. You must turn on Bluetooth communication to use any of the Bluetooth communication features. Keep in mind that when Bluetooth communication is on, your battery drains more quickly than when Bluetooth communication is off.

**To turn on Bluetooth communication:**

1. From the Communications Preferences list, select Bluetooth.
2. Tap the Bluetooth pick list and select On.

**NOTE** Switching Bluetooth on and off may take several seconds. Please wait before proceeding to step 3 below.

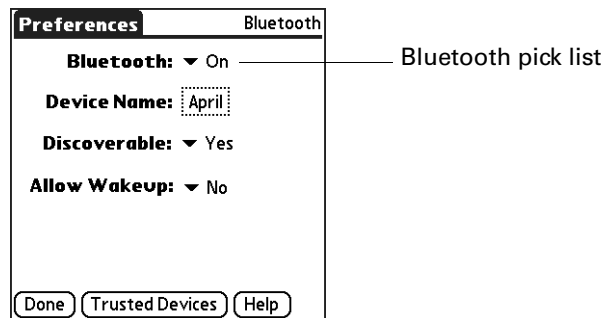

3. Tap Done.

## Assigning a Bluetooth device name

The Bluetooth device name is similar to a name tag that you would wear. The name you assign to your handheld identifies you to other Bluetooth devices. When other users search for Bluetooth devices, your Bluetooth device name appears on their screen as a discovered device. If you do not enter a device name, your handheld sends the default name *Palm OS handheld*.

To assign a Bluetooth name to your handheld:

1. From the Communications Preferences list, select Bluetooth.
2. Tap the Device Name box.
3. Enter a name for your device.

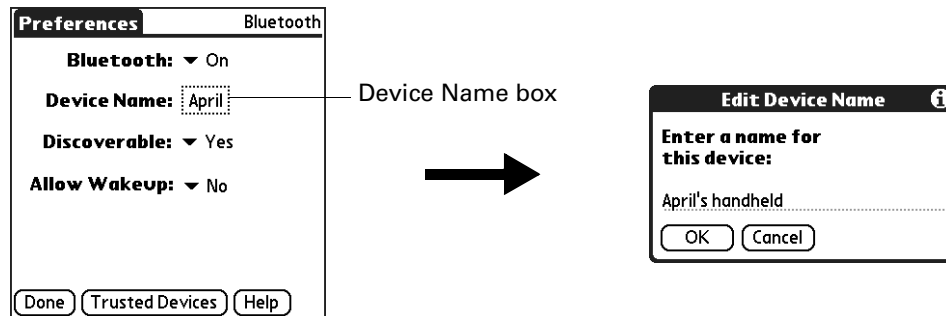

4. Tap OK.
5. Tap Done.

## Setting device discovery

Discovery is the process that Bluetooth devices use to find each other when they are within range of each other. As each device is discovered, it is listed. Once you find the devices you are looking for, you can select the devices with which you want to connect.

The discovery process is typically initiated by an application. For example, when you connect your handheld with a mobile phone using the Phone Link application, Phone Link discovers phones that are equipped with Bluetooth technology and that are within range, in order to connect with one of those phones.

You can use the Discoverable and Bluetooth settings to achieve three discovery states on your handheld. The following is a description of setting combinations and the resulting discovery states:

- **Bluetooth Off:** When the Bluetooth setting is off, other users cannot discover your handheld. This is similar to locking your door with a dead bolt and a security chain, and disabling the doorbell. When Bluetooth is off, you cannot access the Discoverable setting. See [“Turning Bluetooth communication on and off”](#) earlier in this chapter for instructions on turning Bluetooth communication on and off.
- **Bluetooth On and Discoverable No:** When your handheld and Bluetooth are on and the Discoverable setting is set to No, you can receive connections only from devices with which you have previously formed a trusted pair. This is similar to locking your door with a dead bolt and disabling the doorbell, but any friends who already have the key can enter. By default, the Discoverable setting is enabled when Bluetooth is on.

- **Bluetooth On and Discoverable Yes:** When your handheld is on, Bluetooth is on, and the Discoverable setting is set to Yes, you can receive connections from *any* Bluetooth device. You are automatically connected with devices with which you have previously formed a trusted pair, but you can refuse invitations to connect with unrecognized devices. This is similar to locking your front door with a dead bolt and enabling the doorbell. Friends who already have the key can enter freely, and if someone without a key rings the bell to request a connection, you can choose to open the door or ignore the request.

To disable discovery:

1. From the Communications Preferences list, select Bluetooth.
2. Tap the Discoverable pick list and select No.

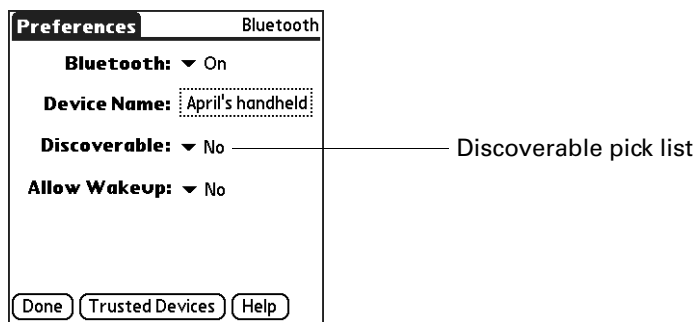

3. Tap Done.

## Allowing Wakeup

When your handheld is off, the Allow Wakeup setting determines whether your handheld wakes up when you receive a connection request from another Bluetooth device that knows your device name. When this setting is enabled, you can receive requested information while your handheld is off, and then review it later. You can allow wakeup at any time, during specific hours of the day, or not at all. By default, your handheld is set to not wake up.

For another Bluetooth device or application to wake up your handheld, the application must “remember” your device name. The BlueBoard and BlueChat applications on the Software Essentials CD-ROM can remember device names; however, Contacts, Memos, Note Pad, and Tasks cannot remember device names and therefore cannot wake up another handheld.

**NOTE** Enabling the Allow Wakeup setting uses battery power even when your handheld is turned off. Be sure to monitor your battery level.

**To enable wakeup:**

1. From the Communications Preferences list, select Bluetooth.
2. Tap the Allow Wakeup pick list and select Yes.

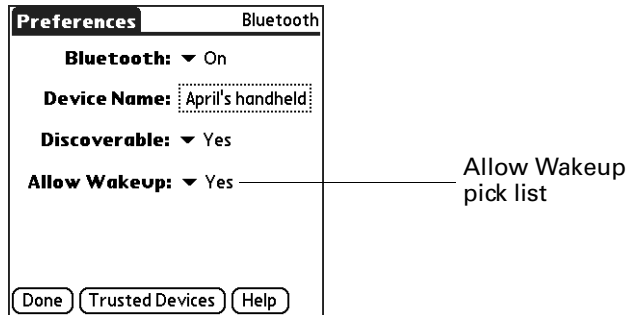

3. Tap Done.

**To enable wakeup during specific hours:**

1. From the Communications Preferences list, select Bluetooth.
2. Tap the Allow Wakeup pick list.
3. Select Scheduled.
4. Tap the hours box.

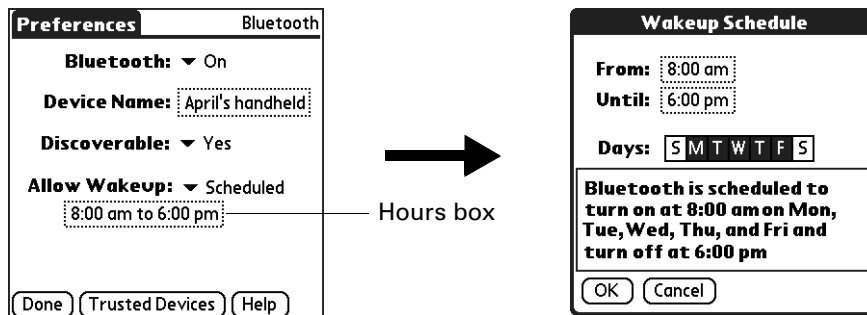

5. Tap the From box, select the start time, and then tap OK.
6. Tap the Until box, select the end time, and then tap OK.
7. Tap the Days boxes to select the days when you want the wakeup feature to be active.
8. Tap OK.
9. Tap Done.

## Adding trusted devices

When you create a trusted pair, you enter an identical secret code on both devices. This secret code is called a *passkey*. The passkey enables you to create a list of Bluetooth devices from which you automatically accept communication. If a device with a recognized passkey attempts to communicate with your handheld, it bypasses the discovery and authentication process and automatically accepts the communication. If a device without a recognized passkey attempts to communicate with your handheld, it goes through the discovery and authentication process, and you can choose to accept or reject the communication.

To add a trusted device:

1. From the Communications Preferences list, select Bluetooth.
2. Tap Trusted Devices.
3. Tap Add Device.

The discovery process begins, and the discovery screens appear.

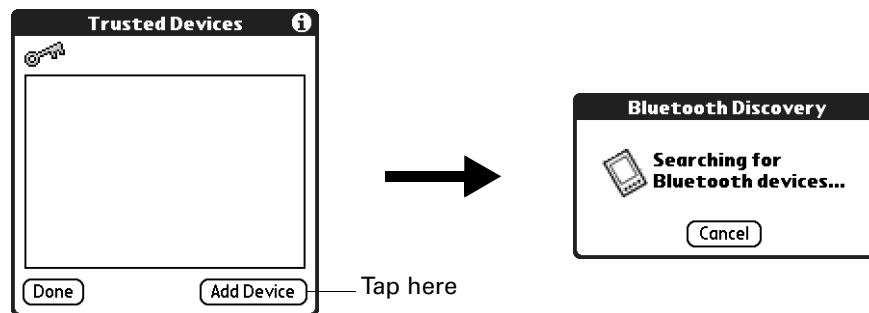

4. When the Discovery Results screen appears, select the device you want to add as a trusted device.

If the device you want to add as a trusted device does not appear on the discovery results list, tap Find More.

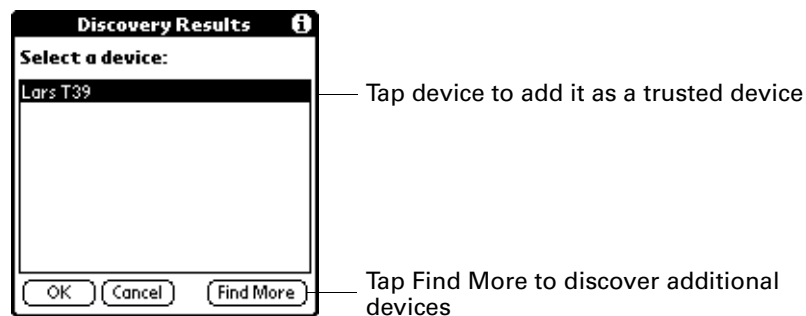

5. Tap OK.

6. Enter the same passkey on your handheld and the trusted device.

Some Bluetooth devices have a built-in passkey; others enable you to choose the passkey; see the documentation included with your Bluetooth device for information. In either case you must use the same passkey for both the device and your handheld.

Many phones also require you to put the phone into a mode where it can accept a key exchange for bonding in a trusted pair. See the documentation included with your phone for information.

7. Tap OK.
8. Tap Done to return to the Bluetooth Preferences screen.
9. Tap Done again.

**To view details about a trusted device:**

1. From the Communications Preferences list, select Bluetooth.
2. Tap Trusted Devices.
3. Select the device you want to view.



4. Tap Details.



5. Tap Done to return to the Trusted Devices screen.
6. Tap Done again to return to the Bluetooth Preferences screen.
7. Tap Done again.

**To delete a trusted device:**

1. From the Communications Preferences list, select Bluetooth.
2. Tap Trusted Devices.
3. Select the device you want to delete.
4. Tap Details.
5. Tap Delete Device.
6. Tap OK.
7. Tap Done to return to the Bluetooth Preferences screen.
8. Tap Done again.

## Enabling/disabling the user cache

When you enable or disable the user cache you control whether or not your handheld retrieves the names of remote devices each time the discovery process takes place. By default, the user cache is enabled. This means that the names of devices found during one round of discovery are stored in your handheld's user cache. The next time your handheld discovers a device that is listed in the user cache, the device name appears very quickly.

Using cached names saves time, because it eliminates the extra step of retrieving a name remotely. Disabling this feature is useful only if the name of a remote device has changed, because it forces your handheld to retrieve the new device name.

**To disable the user cache:**

1. From the Bluetooth Preferences screen, tap the Menu icon .
2. Select Disable device name cache from the Options menu.

## Making Bluetooth connections

There are several ways you can make Bluetooth connections. The method you use determines the types of devices your handheld can discover. The following methods enable you to discover the types of Bluetooth devices that are within range:

- **Using an Internet application:** Access the Internet using Palm™ Web Pro. See [Chapter 18](#) for details.
- **Using the Send command:** Connect to a Palm OS handheld or a computer to exchange data or applications. See [“Sending data”](#) in [Chapter 3](#) for details.
- **Using HotSync Manager software:** Connect to your computer to synchronize data with your handheld. See [“Conducting Bluetooth HotSync operations”](#) in [Chapter 20](#) for details.

- **Using a collaborative application:** Connect to a Palm OS handheld using applications such as BlueBoard and BlueChat included on the Software Essentials CD-ROM. See the *BlueBoard 2.0 Handbook* and the *BlueChat 2.0 Handbook* on the Software Essentials CD-ROM to learn more about these applications. Other third-party applications may be available. Visit [www.palm.com](http://www.palm.com) for information about downloading third-party applications, and refer to the documentation that comes with these applications for details on using them.

**NOTE** Palm, Inc. works with developers of third-party add-on applications to ensure the compatibility of these applications with your new Palm handheld. Some third-party applications, however, may not have been upgraded to be compatible with your new Palm handheld. If you suspect that a third-party application is adversely affecting the operation of your handheld, contact the developer of the application.

## Buttons Preferences

The Buttons Preferences screen enables you to assign a frequently used application to the Favorite icon, and to associate various applications with the buttons on the front and side of the handheld.

If you assign a different application to a button, you can still access the original application by using the Home screen.

**To change the Buttons Preferences:**

1. From the Personal Preferences list, select Buttons
2. Tap the pick list next to the button you want to reassign.
3. Select the application that you want to assign to the button.  
To restore all the buttons to their factory settings, tap Default.
4. Tap Done.

## HotSync Buttons Preferences

The Buttons Preferences screen also enables you to associate various applications with the HotSync button on the cradle/cable and the HotSync button on an optional modem accessory. Any changes that you make in the HotSync Buttons dialog box become effective immediately; you do not have to change to a different screen or application.

**To change the HotSync buttons preferences:**

1. From the Personal Preferences list, select Buttons.
2. Tap More.
3. Tap HotSync.
4. Tap the pick list next to the button you want to assign.



5. Select the application that you want to assign to each button.

The default setting for each button is the HotSync setting, which means that the cradle/cable and optional modem accessories perform their normal HotSync functions.

6. Tap OK twice to return to the Buttons Preferences screen.
7. Tap Done.

## Pen Button Preferences

The Buttons Preferences screen enables you to change the assignment of the full-screen pen stroke. By default, the full-screen pen stroke activates Graffiti 2 Help.

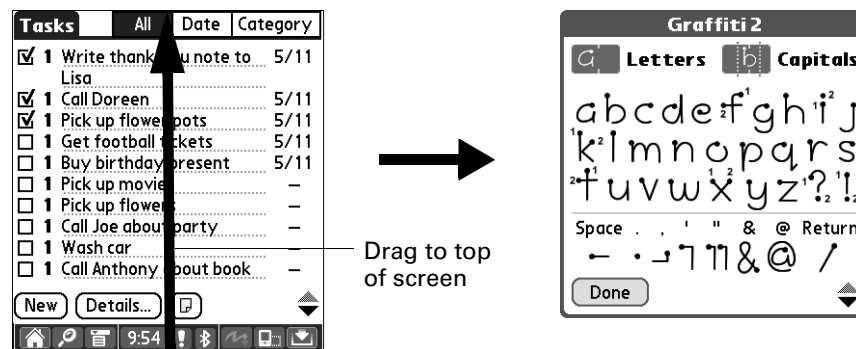

To change the pen preferences:

1. From the Personal Preferences list, select Buttons.
2. Tap Pen.
3. Tap the pick list and select one of the following settings for the full-screen pen stroke:

<b>Brightness</b>	Opens the brightness control dialog box.
<b>Keyboard</b>	Opens the onscreen keyboard for entering text characters.
<b>Graffiti 2 Help</b>	Opens a series of screens that show the complete Graffiti 2 character set.
<b>Turn Off &amp; Lock</b>	Turns off and locks the handheld. You must assign a password to lock the handheld. When it is locked, you need to enter the password to use your handheld.
<b>Beam Data</b>	Beams the current record to another device with an IR port.

4. Tap OK and then tap Done.

## Color Theme Preferences

The Color Theme Preferences screen enables you to select a different set of pre-defined colors for your handheld screen.

To select a color theme:

1. From the Personal Preferences list, select Color Theme.

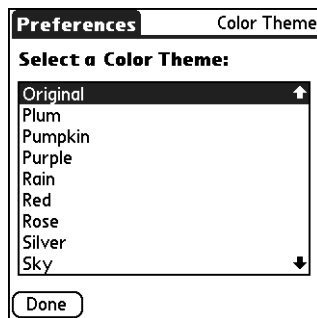

2. Select a theme.

The new colors immediately appear on the screen. You can scroll through the various color selections until you find the one you want to use.

3. Tap Done.

## Connection Preferences

The Connection Preferences screen enables you to define the settings used to connect your handheld to other devices. The screen displays a list of available configurations that are ready to be further defined; the list varies depending on the kind of software you've added to your handheld.

For example, a modem connection appears on the list. If you have this modem, you need only to specify the phone setup (and network connection, if required) to complete the configuration.

You can also create custom configurations, which include the following:

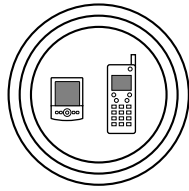

**Phone to Bluetooth:** A connection between your handheld and a Bluetooth phone.

**TIP** For Global System for Mobile Communications (GSM) phones, use Phone Link to quickly establish a connection with a Bluetooth GSM phone. For more information, see [Chapter 12](#).

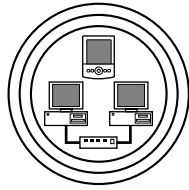

**LAN to Bluetooth:** A connection between your handheld and a Bluetooth local area network.

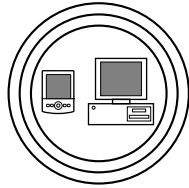

**PC to Bluetooth:** A connection between your handheld and a Bluetooth computer or laptop.

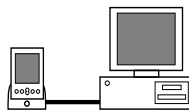

**PC to Cradle/Cable:** A local HotSync connection—the direct connection between your handheld and your desktop computer. Your handheld is connected by its universal connector to the cradle/cable, and the cradle/cable is attached to a USB port of your desktop computer. (If you are using the optional serial cradle/cable, the cradle attaches to a serial [COM] port of your computer.)

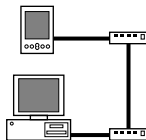

**Modem to Universal connector:** A cable connection between your handheld's universal connector and a modem for dialing in to a modem that is part of your computer or laptop.

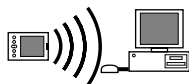

**PC to Infrared:** A connection between the IR port of your handheld and the infrared device of your computer or laptop.



**Modem to Infrared:** A connection between the IR port of your handheld and a modem. The modem can be attached to or within a mobile phone or other device containing an IR port. (Some IR phones contain modems.)

## Editing connections

The following example shows you how to edit the IR to GSM Phone connection to adjust the communication speed; you can similarly edit other connections or settings or create a custom connection. You can use the IR to GSM Phone

connection to perform a remote IR HotSync operation. To accomplish the HotSync operation, your handheld sends data through its IR port to a modem within your mobile phone, which then dials a modem attached to or within your desktop computer, to synchronize with your Palm™ Desktop software.

To edit the IR to Phone connection:

1. From the Communications Preferences list, select Connection.
2. Select the IR to GSM Phone connection.

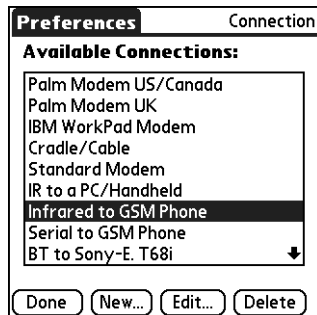

3. Tap Edit.
4. Tap Details.

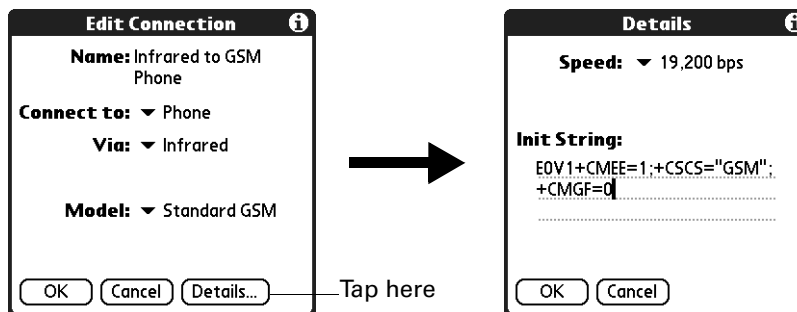

5. Tap the Speed pick list and select the appropriate speed.
6. Enter the initialization string supplied by the documentation for the modem in your mobile phone, if necessary.
7. Tap OK.
8. Tap OK again to save the configuration.

After you create the configuration, you need to set up the HotSync Manager of your Palm Desktop software and the HotSync application of your handheld to perform a modem HotSync operation.

## Creating Bluetooth connections

You can use the Connection Preferences screen to create connections to the following types of Bluetooth devices:

- GSM mobile phones (See “[Connecting to non-GSM phones](#)” later in this chapter for information on connecting to other mobile phones.)

**TIP** For Global System for Mobile Communications (GSM) phones, use Phone Link to quickly establish a connection with a Bluetooth GSM phone. For more information, see [Chapter 12](#).

- Computers
- LAN access points
- High-speed wireless data networks (such as a General Packet Radio Service [GPRS] network)

High-speed wireless data networks provide an “always on” network connectivity and high-speed wireless data transmission. To connect to a high-speed wireless data network, you must have a GSM mobile phone, the correct driver for your phone, a subscription to high-speed wireless data network services with your mobile phone carrier, and the correct high-speed wireless data network settings for your carrier.

**TIP** You can also create a connection with a GSM phone by using the Phone Link application. We recommend using Phone Link to create phone connections. See [Chapter 12](#) for details. Use the steps described in these sections only if you are unable to create a connection with Phone Link.

To create a Bluetooth to LAN connection:

1. From the Communications Preferences list, select Connection.
2. Tap New.

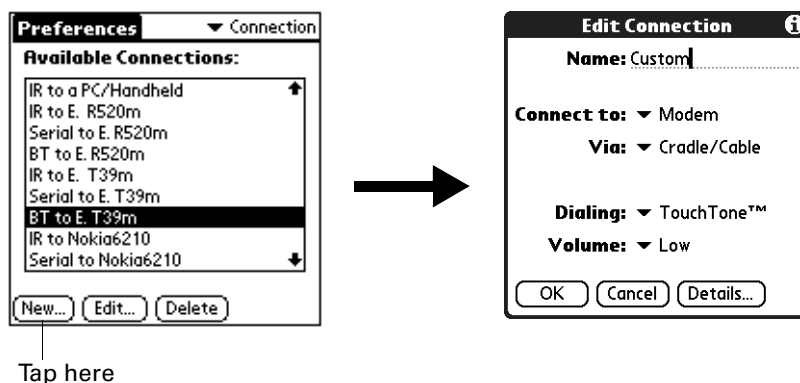

3. Enter a name for the connection, such as BT to LAN.
4. Tap the Connect to pick list and select Local Network.
5. Tap the Via pick list and select Bluetooth.
6. Make sure the network access point is ready to accept a Bluetooth connection.

**NOTE** See the documentation included with the network access point device for information on how to prepare it to accept a Bluetooth connection. The documentation might refer to a Bluetooth connection as a Bluetooth pairing or a Bluetooth link.

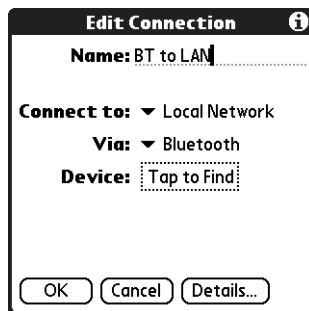

7. Tap the Device box.  
The discovery process begins, and the discovery screen appears.
8. When the Discovery Results screen appears, select the device to which you want to connect.

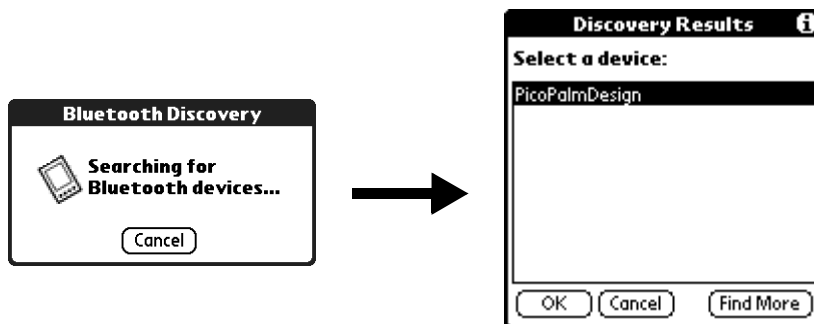

If the device to which you want to connect does not appear on the discovery results list, tap Find More.

9. Tap OK.

If prompted, create a trusted pair with the device. See [“Adding trusted devices”](#) earlier in this chapter for details.

### Connecting to non-GSM phones

If you have a non-GSM phone enabled with Bluetooth technology, you can connect with the phone from your handheld to access the Internet and use Internet-based applications such as e-mail or a web browser. To access the Internet and use Internet-based applications, you must subscribe to data services from your mobile phone carrier and must also have an Internet access account. These services are not included with your handheld.

To create a connection with a non-GSM phone:

1. From the Communications Preferences list, select Connection.
2. Tap New.

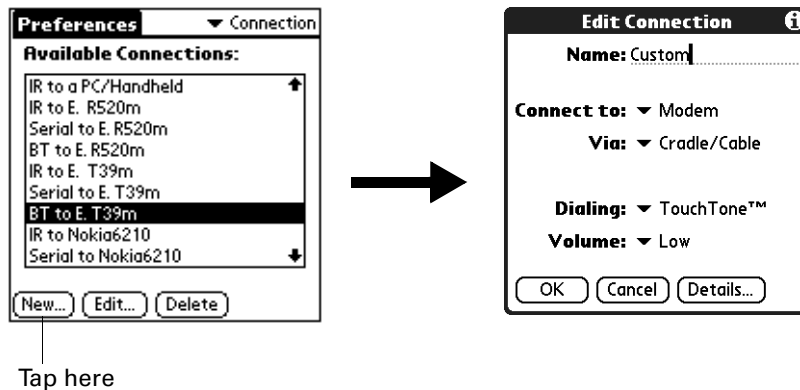

3. Enter a name for the connection.
4. Tap the Connect to pick list and select Modem.
5. Tap the Via pick list and select Bluetooth.

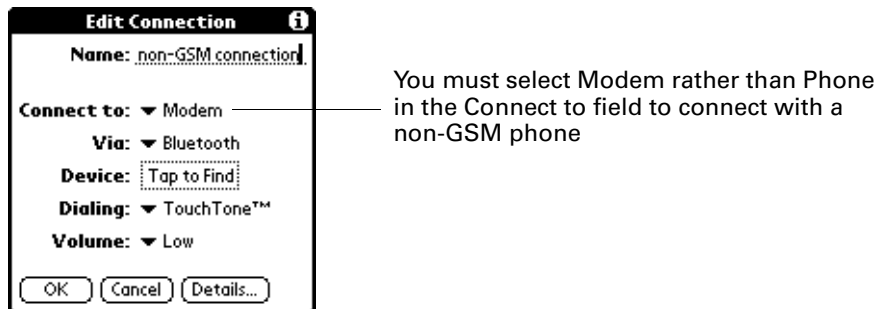

6. Prepare your phone to accept a Bluetooth connection.

**NOTE** See the documentation that was included with your phone for how to prepare your phone to accept a Bluetooth connection. The documentation might refer to a Bluetooth connection as a Bluetooth pairing or a Bluetooth link.

7. Tap the Device box.

The discovery process begins, and the discovery screen appears.

8. When the Discovery Results screen appears, select the phone with which you want to connect, and then tap OK.

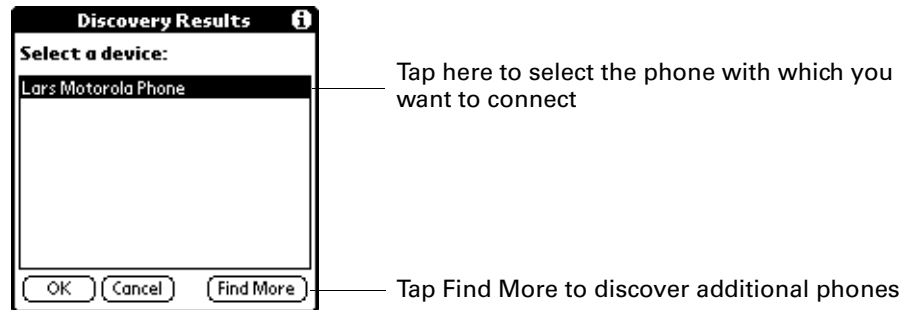

9. Create a trusted pair with the phone. See [“Adding trusted devices”](#) earlier in this chapter for details.

## Date & Time Preferences

The Date & Time Preferences screen enables you to choose a primary location and to set the date, time, and time zone for that location. You can also indicate whether that location observes daylight saving time and the dates that daylight saving time starts and ends. All of these settings also appear as the primary location in the World Clock application and are used by all the applications on your handheld.

### To set the location:

1. From the General Preferences list, select Date & Time.
2. Tap the Location pick list and select the location you want to use as your primary location.

The location you select should be a large city in the same time zone as the one where you live. If an appropriate choice does not appear in the list, see [“Adding a location”](#) in [Chapter 19](#) to create a new location.

3. Tap Done.

When you travel, changing the primary Location setting automatically resets the date and time on your handheld based on the local time zone, but it does not change the time of appointments set in Calendar.

### To set the date:

1. From the General Preferences list, select Date & Time.
2. Tap the Set Date box.



3. Tap the arrows to select the current year.

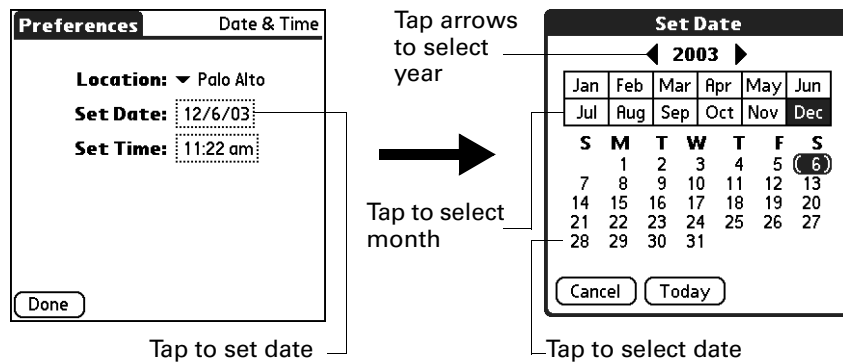

4. Tap the current month.
5. Tap the current date.
6. Tap Done.

#### To set the time:

1. From the General Preferences list, select Date & Time.
2. Tap the Set Time box.

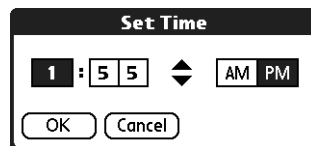

3. Tap the up or down arrow to change the hour.
4. Tap each minute number, and then tap the arrows to change them.
5. Tap OK.
6. Tap Done.

#### To set the time zone and daylight saving time:

1. From the General Preferences list, select Date & Time.
2. Tap the Location pick list.
3. Select Edit List.
4. Select the location where you want to set the time zone.
5. Tap Edit to open the Edit Location dialog box.
6. Follow the steps under [“Adding a location”](#) in [Chapter 19](#) to select the time zone and daylight saving time settings.
7. Tap Done.

## Digitizer Preferences

You can recalibrate your screen after a hard reset or if your digitizer drifts. You may need to repeat this process a few times until the calibration registers.

**To calibrate your handheld screen:**

1. From the General Preferences list, select Digitizer.
2. Tap the targets as indicated on the screen as precisely as possible.

## Formats Preferences

Use the Formats Preferences screen to set the country default and the display format of the dates, times, and numbers on your handheld.

### Country default

The country default sets date, time, week start day, and number conventions based on geographic regions where you might use your handheld. For example, in the United Kingdom, time often is expressed using a 24-hour clock. In the United States, however, time is expressed using a 12-hour clock with an AM or PM suffix.

**To set the country default:**

1. From the General Preferences list, select Formats.
2. Tap the country name pick list.

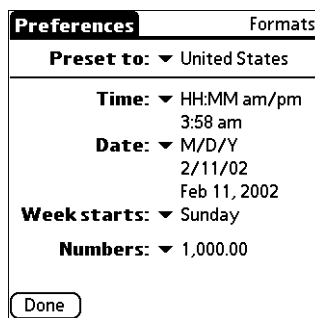

3. Select the setting you want to use.
4. Tap Done.

### Time, date, week start, and numbers formats

The Time setting defines the format for the time of day. The time format that you select appears in all applications on your handheld.

#### To select the time, date, week start, and numbers format:

1. From the General Preferences list, select Formats
2. Tap the Time pick list and select a format.
3. Tap the Date pick list and select a format.
4. Tap the Week starts pick list, and select whether you want the first day of the week to be Sunday or Monday.

This setting controls the Day, Week, and Month views in Calendar and all other aspects of your handheld that display a calendar.

5. Tap the Numbers pick list, and select formats for the decimal point and thousands separator.
6. Tap Done.

## Graffiti 2 Preferences

The Graffiti 2 Preferences screen enables you to select an alternate stroke shape for specific characters.

#### To select alternate strokes:

1. From the General Preferences list, select Graffiti 2.
2. Tap the letter you want to change.

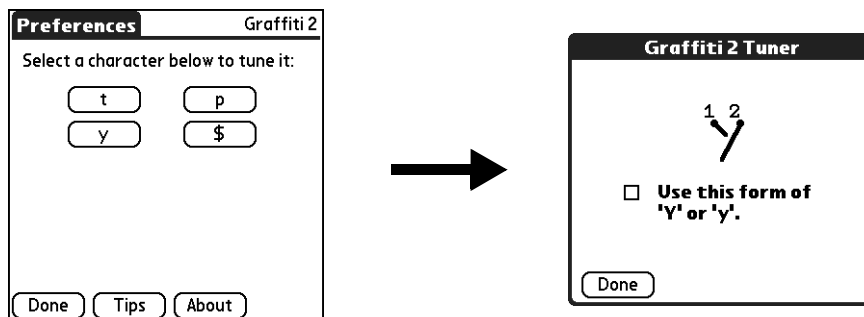

3. Tap the check box to activate the alternate stroke.
4. Tap Done.
5. Repeat steps 2 through 4 for other letters.
6. Tap Done.

## Handedness Preferences

The Handedness Preferences enables you to select right-hand or left-hand orientation when you rotate the screen into landscape mode.

**To select a handedness orientation:**

1. From the Personal Preferences list, select Handedness.
2. Tap Left-Handed or Right-Handed.

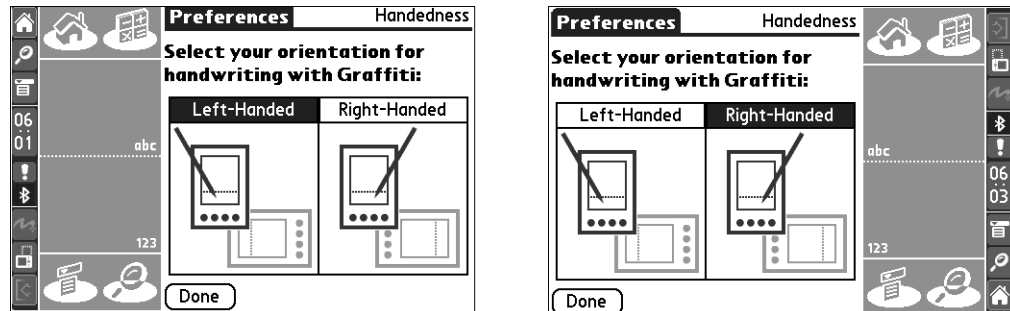

3. Tap Done.

## Keylock Preferences

Use the Keylock Preferences screen to prevent your handheld from turning on if a button or key is accidentally pressed. This feature helps conserve the charge in your handheld.

**To change Keylock settings:**

1. From the General Preferences list, select Keylock.
2. Select the setting you want to use for the Keylock feature.

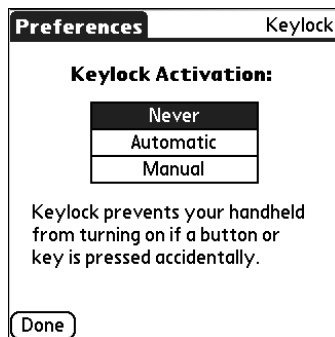

---

<b>Never</b>	Keylock is never activated.
<b>Automatic</b>	Keylock is activated automatically when your handheld is powered off. This includes when you turn your handheld off and when it goes to sleep.
<b>Press and hold</b>	Keylock is activated when you press and hold the power button for two seconds. The system sounds to confirm that Keylock is activated.

## Network Preferences

You can use your handheld's Bluetooth technology and the software that is included in the handheld operating system to connect with Internet service providers (ISPs) or dial-in (remote access) servers by using a mobile phone or optional modem accessory. Your mobile phone must be equipped with one of the following: an IR port, Bluetooth technology, or a serial cable that connects to your handheld's universal connector. You also need an ISP account or corporate remote access account and a mobile phone carrier account that supports dial-up connections, or a mobile phone carrier account with high-speed wireless data network services.

You can also use your handheld's Bluetooth technology and the software that is included in the handheld operating system to connect with a LAN access point.

To use the e-mail or web browser software included with your handheld, you must create a configuration in Connection Preferences and then create Network Preferences settings. See "[Connection Preferences](#)" earlier in this chapter for a complete explanation of how to define Connection configurations that enable your handheld to communicate with remote devices.

After you configure both the Connection and Network Preferences, you can establish a PPP (Point-to-Point Protocol) connection with your ISP or dial-in server. You can do this either by using menu commands from the Network Preferences screen or by using a third-party application.

**NOTE** Palm works with developers of third-party add-on applications to ensure the compatibility of these applications with your new Palm™ handheld. Some third-party applications, however, may not have been upgraded to be compatible with your new Palm handheld. If you suspect that a third-party application is adversely affecting the operation of your handheld, contact the developer of the application.

The Network Preferences settings enable you to connect to your ISP or dial-in server with applications that support viewing the transmitted data. Visit the web site [www.palm.com](http://www.palm.com) for information on third-party applications that take advantage of TCP/IP.

## Creating and selecting network service profiles

Use network service profiles to store the configuration settings for your ISP or a dial-in server. You can create, save, and reuse network service profiles. You can create additional network service profiles from scratch or by duplicating existing profiles and editing information. After you create a new or duplicate profile, you can add and edit settings. You can also duplicate and rename a profile that you created with Phone Link. This preserves the current Phone Link settings when you use Phone Link to create a new phone connection. Otherwise, Phone Link erases the current settings when it creates the new settings.

### To add a new network service profile:

1. From the Communications Preferences list, select Network.
2. Tap New.

An Untitled network service profile appears in the Service pick list.

3. Tap Done.

### To select a network service profile:

1. From the Communications Preferences list, select Network.
2. Tap the Service pick list.

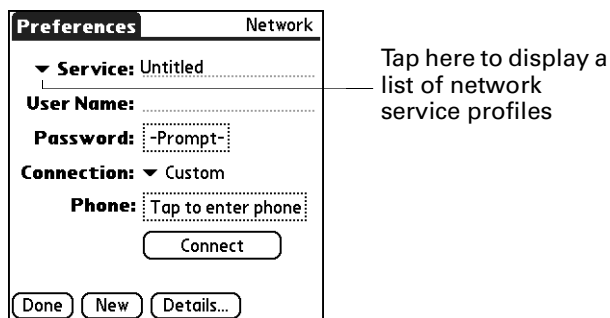

3. Select the network service profile you want to use.
4. Tap Done.

### To duplicate an existing network service profile:

1. From the Communications Preferences list, select Network.
2. Tap the Service pick list.
3. Select the predefined network service profile you want to duplicate.
4. Tap the Menu icon .
5. Select Service, and then select Duplicate.

A copy of the network service profile is added to the Service pick list.

## Entering a user name

The User Name setting identifies the name you use when you log in to your ISP or your dial-in server. Although this field can contain multiple lines of text, only two lines appear onscreen.

**To enter a username:**

1. From the Communications Preferences list, select Network.
2. Tap the User Name field.
3. Enter your username.

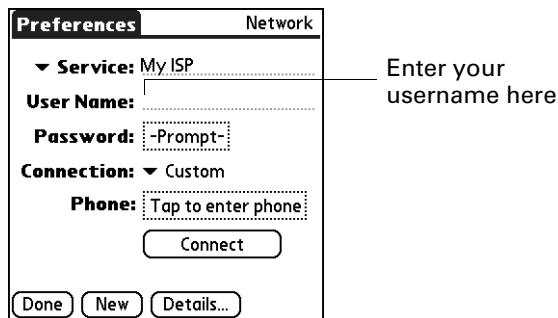

**NOTE** Most dial-in servers do not accept spaces in the username.

4. Tap Done.

## Entering a password

The Password box identifies the password you use to log in to your server or ISP. Your entry in this field determines whether your handheld prompts you to enter a password each time you log into your network.

- If you do not enter a password, your handheld displays the word “Prompt” in this field and asks you to enter a password during the login procedure. If you are concerned about security, select the Prompt option.
- If you enter a password, your handheld displays the word “Assigned” in this field and does not prompt you to enter a password during the login procedure.

**To enter a password:**

1. From the Communications Preferences list, select Network.
2. Tap the Password field.

3. Enter the password you use to log in to your server.

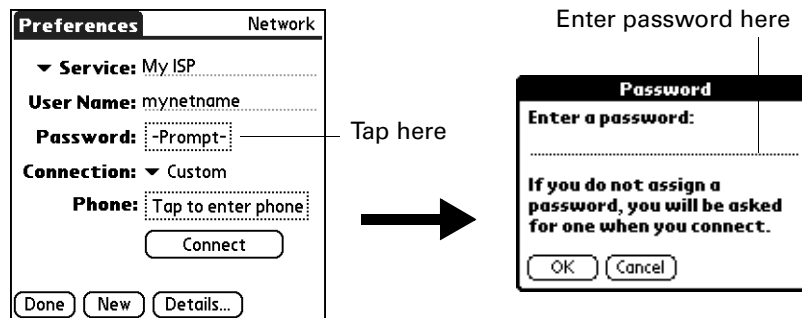

4. Tap OK.  
The word "Assigned" appears in the Password field.
5. Tap Done.

## Selecting a connection

Use the Connection setting to select the method you want to use to connect to your ISP or to a dial-in server. See "[Connection Preferences](#)" earlier in this chapter for information about creating and configuring connection settings.

To select a connection:

1. From the Communications Preferences list, select Network.
2. Tap the Connection pick list.

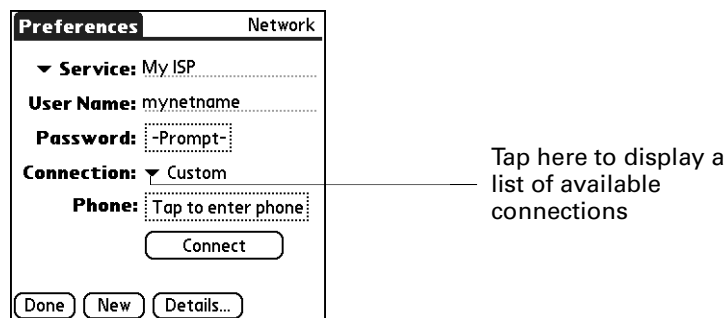

3. Select the connection you want to use.
4. Tap Done.

## Adding telephone settings

The Phone field enables you to store the telephone number you use to connect with your ISP or dial-in server. You can also define a prefix, disable Call Waiting, and give special instructions for using a calling card.



**To enter your server phone number:**

1. From the Communications Preferences list, select Network.
2. Tap the Phone box.
3. Enter the phone number for your ISP or dial-in server.

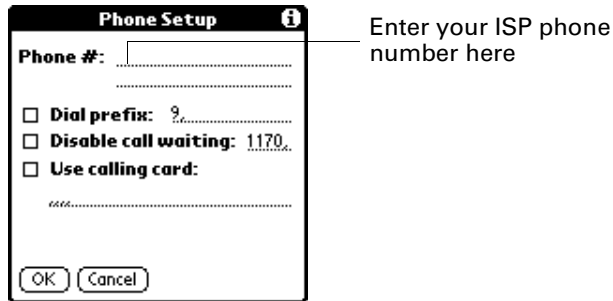

4. If you need to enter a prefix or to disable Call Waiting, skip to those procedures. Otherwise, tap OK.
5. Tap Done.

**Entering a prefix**

A prefix is a number that you dial before the telephone number to access an outside line. For example, many offices require that you first dial “9” to dial a number outside the building.

**To enter a prefix:**

1. From the Communications Preferences list, select Network.
2. Tap the Phone box.
3. Tap the Dial Prefix check box to select it.



4. Enter the prefix.
5. Tap OK.
6. Tap Done.

## Disabling Call Waiting

Call Waiting can cause your session to terminate if you receive a call while you are connected. If your telephone has Call Waiting, you need to disable this feature before logging in to your ISP or dial-in server.

### To disable Call Waiting:

1. From the Communications Preferences list, select Network.
2. Tap the Phone box.
3. Tap the Disable call waiting check box to select it.

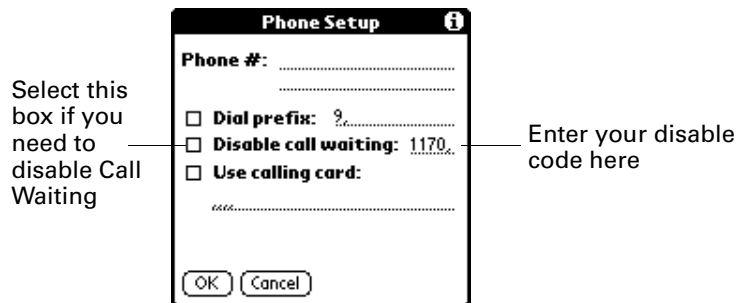

4. On the Disable call waiting line enter the code to disable Call Waiting.

Each telephone company assigns a code to disable Call Waiting. Contact your local telephone company for the code that is appropriate for you.

5. Tap OK.
6. Tap Done.

## Using a calling card

The Use calling card field enables you to use your calling card when dialing your ISP or Intranet server. Keep in mind that there is usually a delay before you enter your calling card number. When you define your calling card number, you need to add commas at the beginning to compensate for this delay. Each comma delays transmission of your calling card number for two seconds.

### To use a calling card:

1. From the Communications Preferences list, select Network.
2. Tap the Phone box.

3. Tap the Use calling card check box to select it.



4. Enter your calling card number on the Use calling card line.

**NOTE** The Phone Setup dialog box works correctly for AT&T and Sprint long-distance services. However, because MCI works differently, MCI customers need to enter the calling card number in the Phone # field and the phone number in the Use calling card field.

**TIP** It's a good idea to add at least three commas before your calling card number to compensate for the cue delay.

5. Tap OK.
6. Tap Done.

## Connecting to your service

After you set your Connection and Network Preferences, establishing a connection to your ISP or your company's network (dial-in server) is easy.

### To establish a connection:

1. From the Communications Preferences list, select Network.
2. Tap Connect to dial the current service and display the Service Connection Progress messages.
3. (Optional) From the Service Connection Progress dialog box, tap the box that displays the service name, select another service, and then tap Done.



To see expanded Service Connection Progress messages, press Down on the navigator.

4. Tap Done.

### To close a connection:

1. From the Communications Preferences list, select Network.
2. Tap Disconnect to terminate the connection between your handheld and your service.
3. Tap Done.

## LAN access points

A LAN access point enabled with Bluetooth™ technology provides an entry point into a local area network. You can log in to these networks from your handheld to access services such as e-mail and the Internet.

LAN access points can be located in private, corporate or in public areas. In some cases there may be a fee to use a LAN access point. To access a LAN access point from your handheld, you must set your Network Preferences as described in the sections that follow.

## Accessing the Internet with a Bluetooth phone or LAN access point

With your handheld's built-in Bluetooth technology, you can connect to the Internet using a Bluetooth mobile phone or a LAN access point. To connect to a Bluetooth mobile phone or LAN access point, you must be within range of these devices. If you have a GSM mobile phone and subscribe to high-speed wireless data services with your mobile phone carrier, you can use these services to connect to the Internet when you are within range of the high-speed wireless data network.

You can also configure Internet access with a GSM phone or high-speed wireless data network by using the Phone Link application. We recommend using Phone Link to enter these settings. See [“Setting up a phone connection”](#) in [Chapter 12](#) for details. Use the steps described in this section only if you are unable to create a connection with Phone Link and you have already used the Connection Preferences screen to create a trusted pair for your phone, high-speed data network, or LAN access point. See [“Creating Bluetooth connections”](#) earlier in this chapter for additional information.

**To configure Internet access with a Bluetooth phone or LAN access point:**

1. From the Communications Preferences list, select Network.
2. Tap the Service pick list and select the name of your ISP or network service. See [“To select a network service profile:”](#) earlier in this chapter for details.

If the name of your service does not appear on the list, see [“Adding detailed information to a network service profile”](#) later in this chapter for information on adding an item to the Service pick list.

3. Enter your username and password for your ISP or network service. See [“Entering a user name”](#) and [“Entering a password”](#) earlier in this chapter for details.

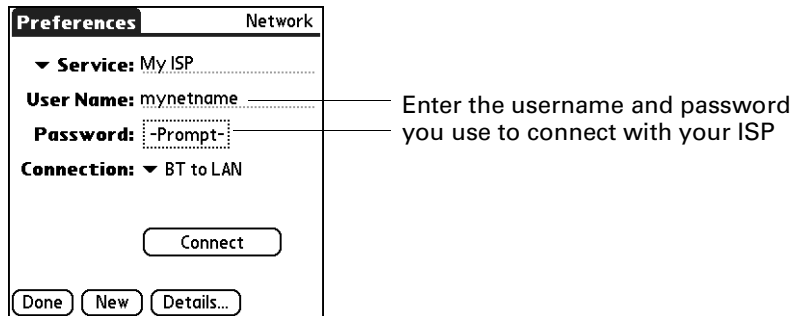

4. Tap the Connection pick list and select a connection to a Bluetooth GSM phone, a high-speed wireless data network, or a LAN access point for which you have already created a trusted pair. The Connection name is based on the model of your phone (if you used Phone Link to create the connection) or the name you assigned to the high-speed wireless data network or LAN access point connection when you created it.
5. If you selected a Bluetooth phone connection in step 4, tap Phone and enter the dial-up connection number for your ISP, and then tap OK. See [“Adding telephone settings”](#) earlier in this chapter for details.

If you are using a Bluetooth Phone or LAN access point, you can now connect and disconnect as described earlier in this chapter. If you are using a high-speed wireless data network connection, you must send an initialization (INIT) string as described in the following procedure.

**To enter an INIT string for a high-speed wireless data network connection:**

1. After completing step 5 in the preceding procedure, tap Details.



2. Tap Script.

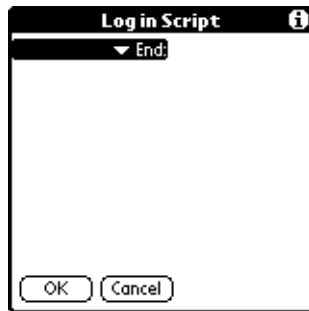

3. Tap End to expand the pick list, and then tap Send.

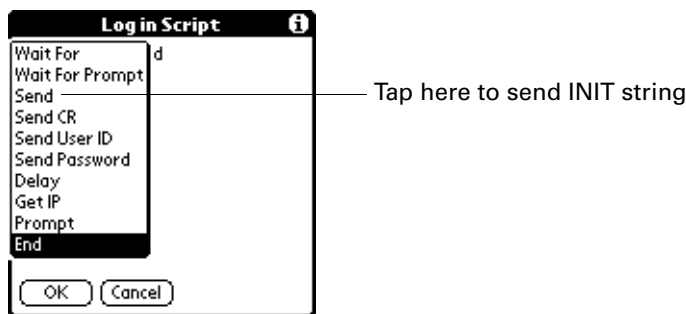

4. In the Send field, enter the INIT string provided by your wireless operator.

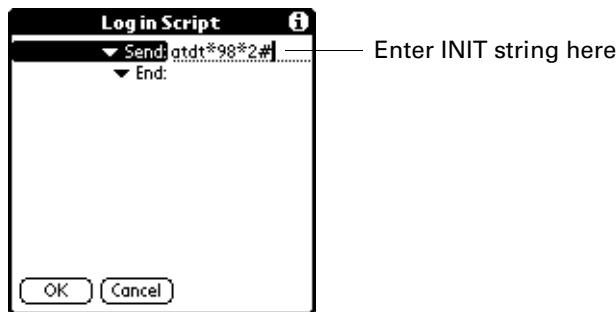

5. Tap OK.

High-speed wireless data network services are not available in all locations. If you pass from an area with coverage into one without coverage, you will lose your network connection with no notice.

If your network connection drops unexpectedly, check your phone to see if a high-speed wireless data network is active and available for the area you are in. If a high-speed wireless data network is available, reconnect to the network using the preceding steps.

If a high-speed wireless data network is not available, you must switch your phone to a standard (non-GPRS) phone connection and access the Internet using your ISP.

You can do this only if you have previously created a standard connection with your phone. For instructions on creating a standard connection, see “[Setting up a phone connection](#)” in [Chapter 12](#).

## Adding detailed information to a network service profile

If you are using one of the predefined network service profiles, you probably need to enter only your username, password, and telephone number. If you are creating a new network service profile, you may need to provide additional information to your ISP or dial-in server. You use the Details dialog box to add more information to a selected network service profile.

### To add connection details:

1. From the Communications Preferences list, select Network.
2. Tap the service field.
3. Tap Details.



### Idle timeout

The Idle timeout setting defines how long your handheld waits before dropping the connection with your ISP or dial-in server when you switch out of a TCP/IP application.

### To set the Idle timeout:

1. Tap the Idle timeout pick list and select one of the following options:
 

<b>1 minute</b>	Waits one minute for you to open another application before it drops the connection.
<b>2 minutes</b>	Waits two minutes.
<b>3 minutes</b>	Waits three minutes.
<b>Never</b>	Keeps your PPP or SLIP connection until you turn off your handheld (or until it times out).
2. Tap OK.

## Defining primary and secondary DNS

The domain name system (DNS) is a mechanism in the Internet for translating the names of host computers into IP addresses. When you enter a DNS number (or IP address), you are identifying a specific server that handles the translation services.

Each IP address has four sections, separated by periods. In the Details dialog box, you enter each section separately. Each section of an IP address is made up of a number from 0 to 255; numbers are the only allowable characters in this field.

Ask your ISP or system administrator for the correct primary or secondary DNS IP address.

Many systems do not require that you enter a DNS IP address. If you are not sure, leave the DNS field blank.

### To enter a primary and secondary DNS:

1. Tap the Query DNS check box to deselect it.
2. Tap the space to the left of the first period in the Primary DNS field, and then enter the first section of the IP address.

Each section must be a number from 0 to 255.

3. Repeat step 2 for the second, third, and last sections of the Primary DNS field.
4. Repeat steps 2 and 3 for the Secondary DNS field.
5. Tap OK.

## Defining the IP address

Everyone who logs in to the Internet needs to have a unique identifier (an IP address), whether permanent or temporary. Some networks dynamically assign a temporary IP address when clients log in. You can use the IP Address field to indicate whether your network provides automatic (dynamic) temporary IP addressing.

If your IP address is permanently assigned, you need to get that information from your system administrator. If you are not sure, select Automatic.

### To identify dynamic IP addressing:

- Tap the IP Address check box to select it.

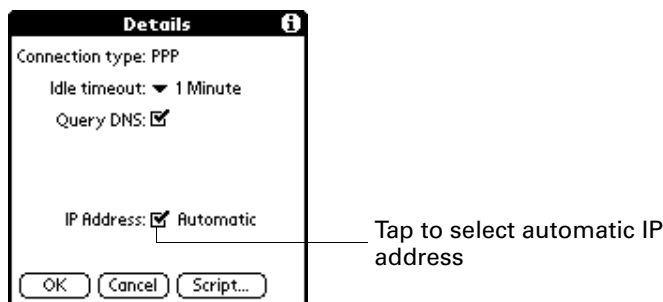



**To enter a permanent IP address:**

1. Tap the IP Address check box to deselect it and to display a permanent IP address field below the check box.
2. Tap the space to the left of the first period, and then enter the first section of the IP address.

Each section must be a number from 0 to 255.

3. Tap and enter the remaining sections of the IP address.
4. Tap OK.

## Adding a Login script

A login script is a series of commands that automates logging in to a network server—for example, your corporate network or your ISP. A login script is associated with a specific network service profile created in Network Preferences.

A login script is something that you are likely to receive from your system administrator if your company has a system in which you log in to the corporate servers from your handheld by using a modem or network connection. The script is generally prepared by the system administrator and distributed to users who need it. It automates the events that must take place to establish a connection between your handheld and the corporate servers.

You can create login scripts in two ways:

- In a text editor on your desktop computer, in which you create a file with the extension PNC, which you then install on your handheld by using the Install Tool. (This method is not available to Mac computer users.)
- In the Login Script dialog box on your handheld, accessed from the Details dialog box in Network Preferences.

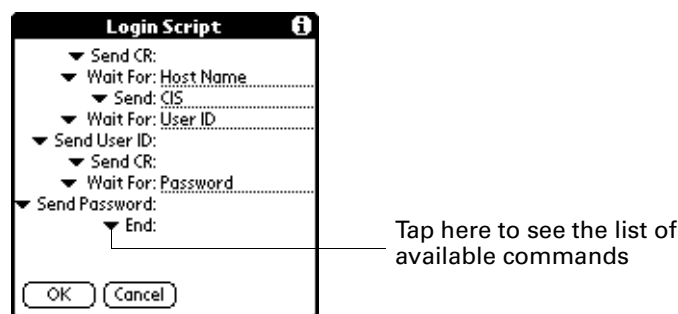

**NOTE** You can also use non-ASCII and literal characters in your login script.

### Creating a login script on your handheld

You can create login scripts by selecting commands from the Command pick list in the Login Script dialog box. Some commands, such as Send, require you to supply additional information. Those commands have a parameter field so that you can add the necessary data.

**To create a login script:**

1. Tap Script.
2. Tap the End pick list.

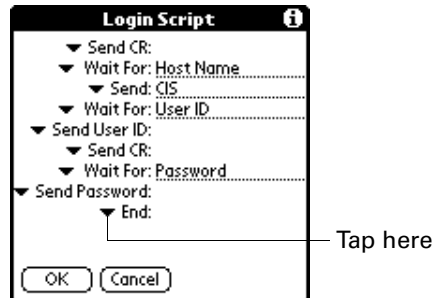

3. Select the command you want from the Command list. If the command requires additional information, a field appears to the right of it for you to enter the information. The following commands are available:

<b>Wait For</b>	Tells your handheld to wait for specific characters from the TCP/IP server before executing the next command.
<b>Wait For Prompt</b>	Detects a challenge-response prompt coming from the server and then displays the dynamically generated challenge value. You then enter the challenge value into your token card, which in turn generates a response value for you to enter on your handheld. This command takes two arguments, separated by a vertical bar ( ) on the input line.
<b>Send</b>	Transmits specific characters to the TCP/IP server to which you are connecting.
<b>Send CR</b>	Transmits a carriage return or line feed (LF) character to the TCP/IP server to which you are connecting.
<b>Send User ID</b>	Transmits the user ID information entered in the User ID field of the Network Preferences screen.
<b>Send Password</b>	Transmits the password entered in the Password field of the Network Preferences screen. If you did not enter a password, this command prompts you to enter one. The Password command is usually followed by a Send CR command.
<b>Delay</b>	Tells your handheld to wait a specific number of seconds before executing the next command in the login script.
<b>Get IP</b>	Reads an IP address and uses it as the IP address for your handheld. This command is used with SLIP connections.

---

<b>Prompt</b>	Opens a dialog box and prompts you to enter certain text (for example, a password or a security code).
<b>End</b>	Identifies the last line in the login script.

4. Repeat steps 2 and 3 until the login script is complete.
5. Tap OK.

### Creating plug-in applications

You can create plug-in applications containing script commands that extend the functionality of the built-in script commands. A plug-in application is a standard PRC application that you install on your handheld just like any other application. After you install the plug-in application, you can use the new script commands in a login script.

Plug-in applications have the following characteristics:

- Written in C language
- Compiled into a device executable
- Called properly from a login script
- Able to return control to a login script after it terminates
- Created with the use of a development environment that supports Palm OS software, such as Metrowerks CodeWarrior for Palm™ Platform

For additional information on creating plug-in applications, send e-mail to Palm Developer Support at [devsupp@palm.com](mailto:devsupp@palm.com).

## Deleting a network service profile

There is only one way to delete a network service profile: Use the Delete command from the Service menu.

**To delete a network service profile:**

1. From the Communications Preferences list, select Network.
2. Tap the Service pick list.
3. Select the network service profile you want to delete.
4. Tap the Menu icon .
5. Select Delete from the Service menu.
6. Tap OK.
7. Tap Done.

## TCP/IP troubleshooting

If you have problems establishing a network connection using TCP/IP, check the troubleshooting tips in this section and try the suggestions listed.

### Displaying expanded Service Connection Progress messages



It's helpful to identify at what point in the login procedure the connection fails. An easy way to do this is to display the expanded Service Connection Progress messages. These messages describe the current stage of the login procedure. Press Down on the navigator at any point during login to display these messages.

### Viewing the Network Log

If viewing the expanded Service Connection Progress messages does not give you enough information to find out why you cannot connect to your ISP or dial-in server, take a look at the Network Log. The Network Log lists all of the communication that occurs between your modem and your dial-in server during the login procedure. The information in the Network Log can help your ISP or your system administrator pinpoint where the login procedure communication fails and why.

#### To view the Network Log:

1. From the Network Preferences screen, tap the Menu icon .
2. Select Options, and then select View Log.
3. Tap the up and down arrows of the scroll bar to see the entire Network Log.
4. Tap Done.

### Adding a DNS number

If your ISP or dial-in server requires a DNS number and you did not enter that information in the Network Preferences screen, it will appear that you successfully logged in to your network. When you try to use an application or look up information, however, the connection fails. If this occurs, try adding a DNS IP address. Ask your ISP or your system administrator for the correct primary and secondary DNS IP address.

## Owner Preferences

The Owner Preferences screen enables you to update the name, company name, phone number, or any other information that you want to associate with your handheld. This information could help someone contact you if you ever lose your handheld and there is sufficient battery power to turn it on.

By default the Owner Preferences screen contains the information that you supplied when you installed the Palm Desktop software and set up your handheld.

If you use Security Preferences to turn off and lock your handheld with a password, the first three lines that you entered in the Owner Preferences appear the next time you turn on your handheld. See [“Security Preferences”](#) earlier in this chapter for additional information.

**To customize the Owner Preferences:**

1. From the Personal Preferences list, select Owner.
2. Modify or enter the text that you want to associate with your handheld.

If you enter more text than can fit on one screen, a scroll bar automatically appears on the right side of the screen.

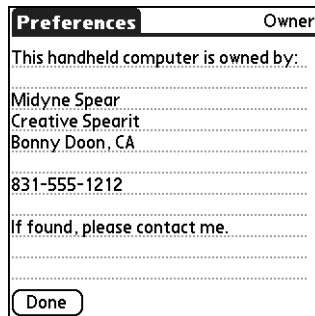

If you assign a password using Security Preferences, the information on the Owner Preferences screen cannot be changed. In this case an Unlock button appears at the bottom of the screen.

3. Tap Done.

**To unlock the Owner Preferences screen:**

1. From the Personal Preferences list, select Owner.
2. Tap Unlock.
3. Enter the password that you defined in Security Preferences.
4. Tap OK.
5. Tap Done.

## Phone Preferences

The Phone Preferences setting enables you to configure your handheld to exchange SMS messages and to dial phone numbers when your handheld is connected to a GSM mobile phone (sold separately). To use this feature, you must first install the appropriate files for your carrier and phone. For more information, see [Chapter 12](#).

**To set Phone Preferences:**

1. From the Communications Preferences list, select Phone.
2. Tap the Connection pick list.

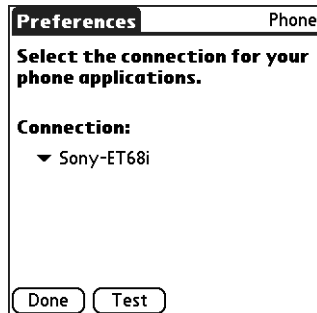

3. Select the appropriate connection for your phone.  
If you do not see a connection for your phone, see [“Setting up a phone connection”](#) in [Chapter 12](#) for instructions.
4. Tap Test to confirm that the selected driver works properly with your phone.
5. Tap Done.

## Power Preferences

The Power Preferences screen enables you to set power consumption options.

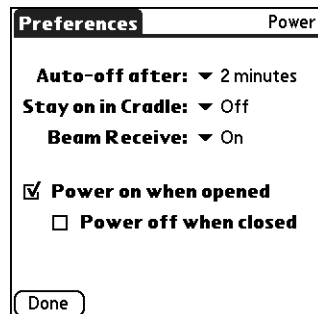

### Auto-off after

Your handheld has an automatic shutoff feature that turns off the power after a period of inactivity. This feature helps conserve battery power in case you forget to turn off your handheld.

If you find that your handheld shuts itself off before you finish reviewing the information on the screen, you can increase the time setting of the automatic shutoff feature.

**To set the Auto-off after interval:**

1. From the General Preferences list, select Power.
2. Tap the Auto-off after pick list.
3. Select the setting you want to use for the automatic shutoff feature: 30 seconds, 1 minute, 2 minutes, or 3 minutes.
4. Tap Done.

## Stay on in Cradle

You can choose to leave your handheld on when it is in the cradle/cable, so that you can continue to view your data. By default, your handheld remains on when it is in the cradle/cable and is connected to a power source.

**To change the cradle/cable setting:**

1. From the General Preferences list, select Power.
2. Tap the Stay on in Cradle pick list.
3. Select Off to turn off your handheld when it is in the cradle/cable.
4. Tap Done.

## Beam Receive

You can choose to turn off the Beam Receive feature. This prohibits anyone from beaming information to your handheld. It also results in a slight saving of battery power. By default, Beam Receive is enabled.

**To turn off the Beam Receive feature:**

1. From the General Preferences list, select Power.
2. Tap the Beam Receive pick list.
3. Select Off to disable receiving beamed information.
4. Tap Done.

## Power on when opened and Power off when closed

You can choose to automatically turn your handheld on and off when you open and close the Graffiti 2 input area. By default, your handheld turns on when you open it and remains on when you close it. The Power off option is available only when the Power on when opened setting is active.

**To change the power-on setting:**

1. From the General Preferences list, select Power.
2. Tap the Power on when opened check box to deselect it.
3. Tap Done.

**To change the power-off setting:**

1. From the General Preferences list, select Power.
2. Tap the Power off when closed check box to select it.
3. Tap Done.

## Security Preferences

Security Preferences help you prevent unauthorized users from viewing entries that you want to protect. Use Security Preferences to do the following:

- Lock and turn off your handheld so that it does not operate until you enter the correct password.
- Mask all records that you mark as private so that the information appears as gray bars.
- Hide all records that you mark as private so that they do not appear on any screen.

You can mask and hide private records with or without a password. Without a password, private records are hidden or masked until you set Security Preferences to show them. With a password, you must enter the password to view private entries.

### Assigning a password

You can assign a password to protect your private records and to lock your handheld.

**To assign a password:**

1. From the General Preferences list, select Security.
2. Tap the Password box.
3. Enter a password.
4. Enter a hint to help you remember your password if you forget it. This is optional.

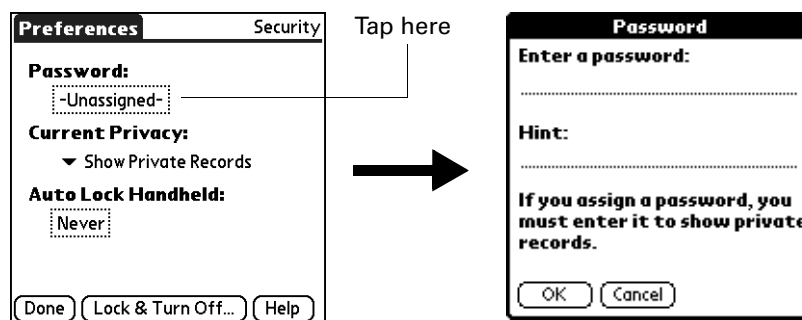

5. Tap OK.



6. Enter the *same* password a second time, and then tap OK.
7. Tap Done.

### Changing or deleting a password

Once you define a password for your handheld, you can change or delete it at any time. You must enter the current password before you can change or delete it.

To change or delete your password:

1. From the General Preferences list, select Security.
2. Tap the Password box.
3. Enter the current password.

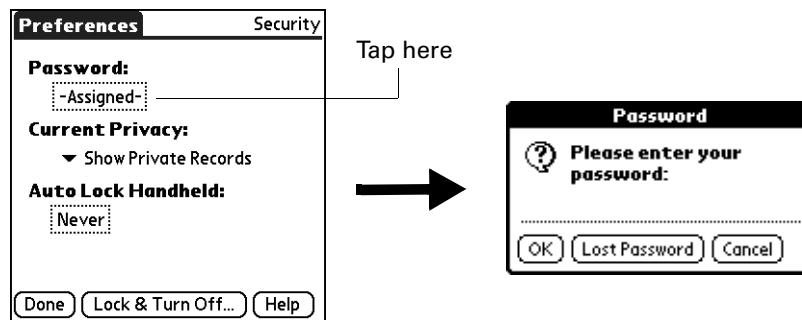

4. Tap OK.
5. Do one of the following:
  - To change the password and hint, enter the new password and hint, and tap OK.
  - To remove the password, tap Unassign.



6. Tap Done.

### Locking your handheld

You can lock your handheld so that it cannot be operated until your password is entered. If your handheld is lost or stolen, this helps protect your data from unauthorized use. You can set your handheld to lock automatically, or you can lock it manually.

You can set your handheld to lock automatically when any one of the following occurs:

- When you turn off the power
- At a time you specify
- After a period of inactivity you specify

**To set your handheld to lock when you turn it off:**

1. From the General Preferences list, select Security.
2. Tap the Auto Lock Handheld box, enter your password, and then tap OK.



3. Select On power off.
4. Tap OK, and then tap Done.

**To set your handheld to lock at a preset time:**

1. From the General Preferences list, select Security.
2. Tap the Auto Lock Handheld box, enter your password, and then tap OK.
3. Select At a preset time, and then use the arrows to set the time.

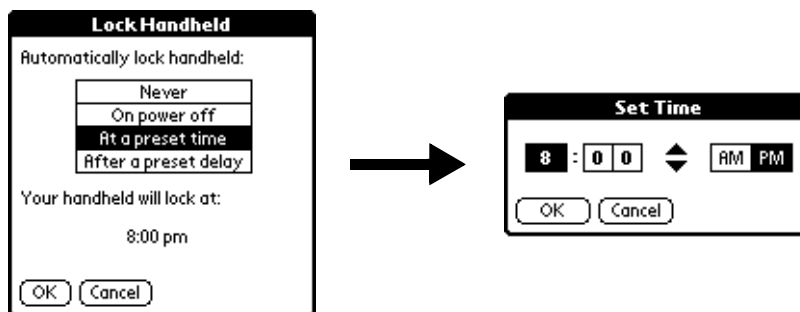

4. Tap OK, and then tap Done.

**To set your handheld to lock after a period of inactivity:**

1. From the General Preferences list, select Security.
2. Tap the Auto Lock Handheld box, enter your password, and then tap OK.
3. Select After a preset delay.

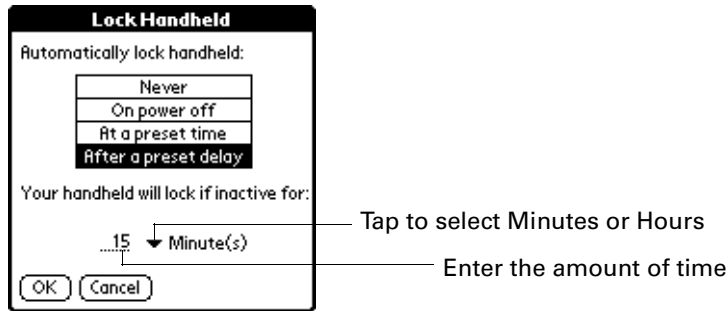

4. Enter the inactive period, and then select Minute(s) or Hour(s) from the pick list.
5. Tap OK, and then tap Done.

**CAUTION** If you lock your handheld, you must enter the exact password to reactivate your handheld. If you forget the password, your handheld will present the hint you entered to help you remember the password. If you still cannot remember the password, you must perform a hard reset to resume using your handheld. Performing a hard reset deletes all the records on your handheld; however, you can restore all synchronized data at the next HotSync operation. See [“Performing a hard reset”](#) in [Appendix A](#) for more information.

**To lock and turn off your handheld manually:**

1. From the General Preferences list, select Security.
2. Tap Lock & Turn Off.

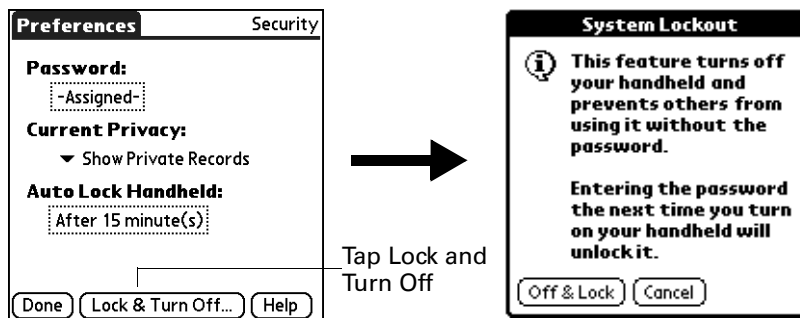

3. Tap Off & Lock.
4. To start your handheld, turn it on, and then enter the password.
5. Tap Done.

### Recovering from a forgotten password

If you forget your password, your handheld will display the password hint, if you entered one, to help you remember the password. If you are still unable to remember the password, you can delete it from your handheld. Deleting a forgotten password also deletes all entries and files marked Private.

---

**IMPORTANT** If you synchronize with your computer before deleting a forgotten password, your handheld restores your private entries the next time you perform a HotSync operation, but it does not restore the password.

---

#### To delete a forgotten password:

1. From the General Preferences list, select Security.
2. Tap the Password box.
3. Tap Lost Password.
4. Tap Yes.

### Making records private

In many applications, you can make individual records private. Private records remain visible and accessible, however, until you select the Security setting to hide or mask all private records. Masked records appear as gray placeholders in the same position in which they would appear if they were not masked, and are marked with a lock icon. Hidden records disappear completely from the screen. If you define a password for your handheld, you must enter it to display private records.

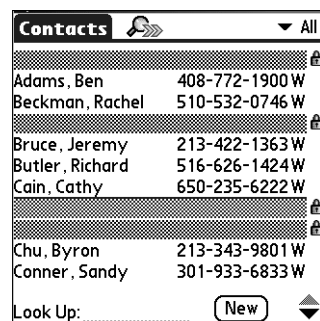

**To hide all private records:**

1. From the General Preferences list, select Security.
2. Tap the Current Privacy pick list, and then select Hide Private Records.

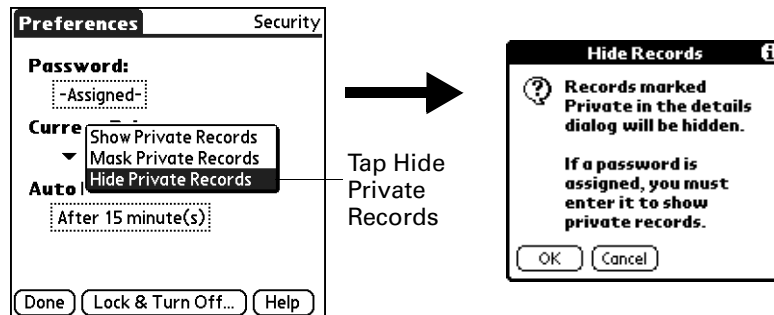

3. Tap OK to confirm that you want to hide private records.
4. Tap Done.

**To mask all private records:**

1. From the General Preferences list, select Security.
2. Tap the Current Privacy pick list, and then select Mask Private Records.

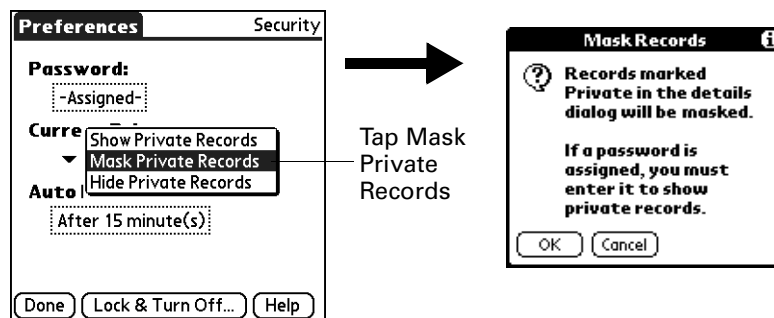

3. Tap OK to confirm that you want to mask private records.
4. Tap Done.

**To display all private records:**

1. From the General Preferences list, select Security.
2. Tap the Current Privacy pick list, and then select Show Private Records.

If you do not have a password, hidden and masked records become visible. If you have a password, the Show Private Records dialog box appears. Enter your password, and then tap OK.

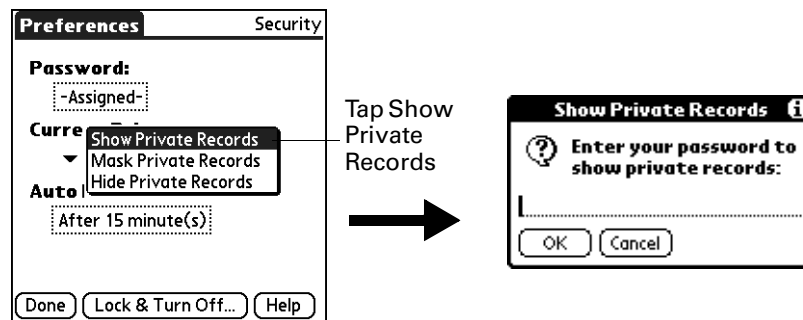

3. Tap Done.

**To unmask individual records:**

1. Select a masked record.

If you do not have a password, a masked record becomes visible. If you have a password, the Show Private Records dialog box appears. Go to step 2.

2. Enter your password, and then tap OK.

**To make a record private:**

1. Display the entry that you want to make private.
2. Tap Details.
3. Tap the Private check box to select it.
4. Tap OK.

## ShortCuts Preferences

The ShortCuts Preferences screen enables you to define abbreviations for entering text with Graffiti 2 strokes. This section describes how to create, edit, and delete a ShortCut.

### Creating a ShortCut

You can create a ShortCut for any words, letters, or numbers. For example, you might create a ShortCut for your name or for the header of a memo. All ShortCuts you create appear on the list in the ShortCut Preferences screen. All the ShortCuts

are available in any of your handheld applications and are backed up on your computer when you perform a HotSync operation.

**To create a ShortCut:**

1. From the Personal Preferences list, select Shortcuts.
2. Tap New.
3. On the ShortCut name line, enter the letters you want to use to activate the ShortCut. Each ShortCut can represent up to 45 characters.

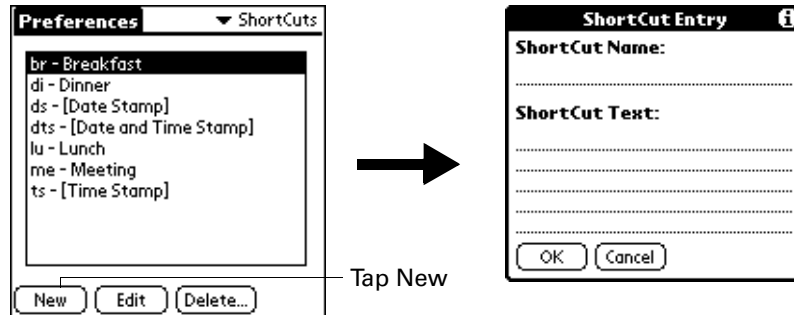

4. Tap the ShortCut Text area, and enter the text that you want to appear when you write the ShortCut characters.

**TIP** You may want to add a space character after the last word in your ShortCut text. This way, a space automatically follows the ShortCut text.

5. Tap OK.

To use a ShortCut, draw the ShortCut stroke followed by the ShortCut characters. When you draw the ShortCut stroke, the ShortCut symbol appears at the insertion point to show that you are in ShortCut mode.



6. Tap Done.

## Editing or delete a ShortCut

After you create a ShortCut, you can modify it at any time. If you no longer need a ShortCut, you can delete it from the list of ShortCuts.

**To edit or delete a ShortCut:**

1. From the Personal Preferences list, select Shortcuts.
2. Select a ShortCut.

3. Perform one of the following:
  - Tap Edit, make the changes you want, and then tap OK.
  - Tap Delete and then tap Yes.
4. Tap Done.

## Sounds & Alerts Preferences

You can choose from three Sound & Alert profiles:

- |                |  |
|----------------|--|
| <b>Custom</b>  | Configure this profile with your own personal settings.                          |
| <b>Silent</b>  | Select this profile to use the vibrate and indicator light alerts without sound. |
| <b>All Off</b> | Select this profile to turn off all sounds and alerts.                           |

**TIP** When you connect a headset to your handheld, the external speaker is automatically silenced, the Sounds & Alerts settings are maintained, and all volume levels are automatically adjusted for use with a headset.

**To select a profile:**

1. From the General Preferences list, select Sound & Alerts.
2. Tap the Custom, Silent, or All Off profile box.



**TIP** You can also press Right or Left on the navigator to select a profile box.

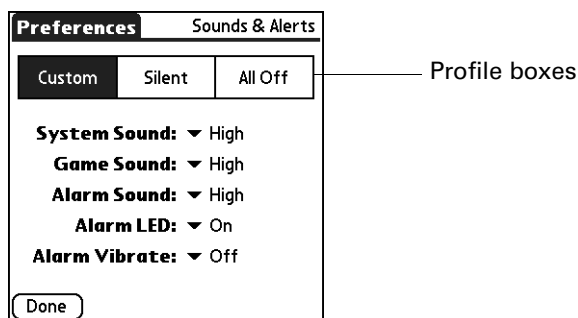

3. Tap Done.

## System Sound, Game Sound, and Alarm Sound settings

Your handheld uses a variety of sounds. The System Sound, Game Sound, and Alarm Sound settings enable you to turn the sounds on or off and to adjust the volume level.



**To set the sound settings:**

1. From the General Preferences list, select Sound & Alerts.
2. Tap Custom.
3. Tap the System Sound pick list and select the sound level.

---

**IMPORTANT** When you turn off the System Sounds, you also turn off the “chime” tones associated with the HotSync operation.

---

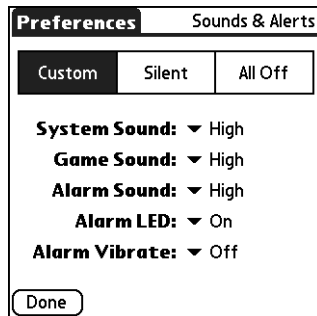

4. Tap the Game Sound pick list and select the sound level.
5. Tap the Alarm Sound pick list and select the sound level.
6. Tap Done.

The Game Sound setting works only with games that are programmed to respond to this setting. Older games typically do not respond to this setting.

## Alarm LED and Alarm Vibrate settings

You can set alarms in Calendar, World Clock, Note Pad, and Voice Memo to remind you of important meetings or notes. When you enable the Alarm Vibrate and indicator light settings, your handheld vibrates and the indicator light blinks to notify you. This is useful when you want to turn the Alarm Sound off but still be notified by alarms.

**To set the Alarm LED and Alarm Vibrate settings:**

1. From the General Preferences list, select Sound & Alerts.
2. Tap Custom.

3. Tap the Alarm LED pick list and select On or Off.

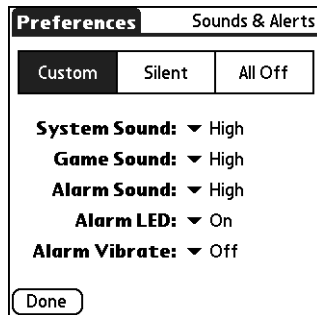

4. Tap the Alarm Vibrate pick list and select On or Off.
5. Tap Done.

# Maintaining Your Handheld

This appendix provides information on the following:

- Caring for your handheld
- Prolonging battery life
- Resetting your handheld

## Caring for your handheld

Your handheld is designed to be rugged and reliable and to provide years of trouble-free service. Observe the following general tips when using your handheld:

- Take care not to scratch the screen of your handheld. Keep the screen clean. When working with your handheld, use the supplied stylus or plastic-tipped pens intended for use with a touch-sensitive screen. Never use an actual pen or pencil or other sharp object on the surface of the handheld screen.
- Your handheld is not waterproof and should not be exposed to rain or moisture. Under extreme conditions, water may enter the circuitry through the front panel buttons. In general, treat your handheld as you would a pocket calculator or other small electronic instrument.
- Take care not to drop your handheld or subject it to any strong impact. Do not carry your handheld in your back pocket; if you sit on it, you may damage it.
- Protect your handheld from temperature extremes. For example, do not leave your handheld on the dashboard of a car on a hot day or on a day when temperatures are below freezing, and keep it away from heaters and other heat sources.
- Do not store or use your handheld in any location that is extremely dusty, damp, or wet.
- Use a soft, damp cloth to clean your handheld. If the surface of the handheld screen becomes soiled, clean it with a soft cloth moistened with a diluted window-cleaning solution.

## Prolonging battery life

Note the following considerations for the battery in your handheld:

- Under normal conditions your handheld battery should remain charged when you place it in the cradle/cable for just a few minutes each day. You can conserve battery life by doing any of the following:
  - Change the Auto-off setting that automatically turns the handheld off after a period of inactivity. See “Auto-off after” in [Chapter 21](#) for more information.
  - Turn off the Bluetooth™ feature when you’re not using it. See “Bluetooth Preferences” in [Chapter 21](#) for more information.
  - Minimize accessing the expansion card slot.
  - Moderate how often you access multimedia files, such as MP3™ files (expansion card required, sold separately), photos, and video files.
- If the battery becomes low in the course of normal use, an alert appears on the handheld screen, describing the low battery condition. If this alert appears, perform a HotSync® operation to back up your data; then leave your handheld in the cradle/cable to recharge the unit. This helps prevent accidental data loss.
- If the battery drains to the point where your handheld does not operate, it stores your data safely for about a week. In this case there is enough residual energy in the battery to store the data, but not enough to turn on your handheld. If your handheld does not turn on when you press the power button, you should recharge the unit immediately. The battery may not have enough residual energy to power the indicator light, which is normally green when the battery is charging.
- If your battery drains and you have the unit in an uncharged state for an extended period of time, you can lose all your stored data.
- There are no serviceable parts inside your handheld, so do not attempt to open the unit.
- If you ever dispose of your handheld, please dispose of it without damaging the environment. Take your handheld to your nearest environmental recycling center.

## Resetting your handheld

Under normal circumstances you will not have to use the reset button. On rare occasions, however, your handheld may no longer respond to buttons or to the screen. In this case you need to perform a reset to get your handheld running again.

## Performing a soft reset

A soft reset tells your handheld to stop what it's doing and start over again. All records and entries stored in your handheld are retained with a soft reset. After a soft reset, the Preferences screen appears and the Date and Time option is highlighted so you can reset the date and time if needed.

### To perform a soft reset:

1. Open your handheld. See [“Opening and closing your handheld”](#) in [Chapter 2](#) for details.
2. Use the tip of your stylus or an unfolded paper clip (or similar object *without* a sharp tip), to gently press the reset button inside the hole on the back panel of your handheld.

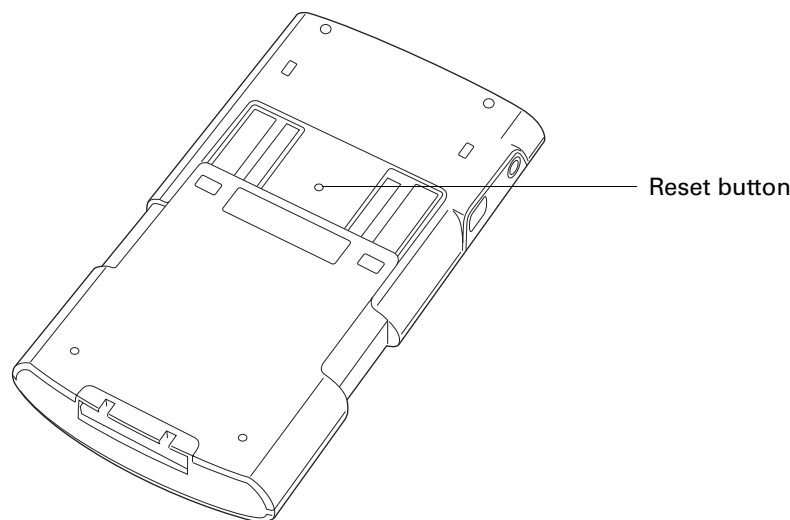

## Performing a hard reset

With a hard reset, all records and entries stored in your handheld are erased. Never perform a hard reset unless a soft reset does not solve your problem.

**NOTE** You can restore any data previously synchronized with your computer during the next HotSync operation.

### To perform a hard reset:

1. Open your handheld. See [“Opening and closing your handheld”](#) in [Chapter 2](#) for details.
2. Press and hold the power button on the top panel of the handheld.
3. While holding the power button, use the tip of your stylus or an unfolded paper clip (or similar object *without* a sharp tip) to gently press and release the reset button.
4. Wait for the Palm Powered™ logo to appear; then release the power button.

5. When a message appears on the handheld screen warning that you are about to erase all the data stored on your handheld, do one of the following:



- Press Up on the navigator to complete the hard reset and display the Digitizer screen.
- Press any other button to perform a soft reset.

**NOTE** With a hard reset, the current date and time are retained. Formats Preferences and other settings are restored to their factory default settings.

**To restore your data from a Windows computer after a hard reset:**

1. Click the HotSync icon  in the Windows system tray (lower-right corner of the taskbar).

You can also click the HotSync command on the Palm™ Desktop software menu bar.

2. From the HotSync Manager menu, select Custom.
3. Select the appropriate username from the list.
4. Select an application in the Conduit list.
5. Click Change.
6. Select Desktop overwrites handheld for each conduit.

Changing the HotSync setting from the default affects only the *next* HotSync operation. Thereafter, the HotSync Actions revert to their default settings. To use a new setting on an ongoing basis, select the Set As Default checkbox. Thereafter, whatever you selected as the default setting is used when you click the Default button in the Custom dialog box.

7. Click OK.
8. Repeat steps 4 through 6 to change conduit settings for other applications.
9. Click Done to activate your settings.
10. Perform a HotSync operation.

**To restore your data from a Mac computer after a hard reset:**

1. Double-click the HotSync Manager in the Palm folder.
2. From the HotSync menu, select Conduit Settings.
3. From the Users pop-up menu, select the appropriate username.
4. Select an application from the list.
5. Click Conduit Settings.

6. Click Macintosh overwrites handheld for each conduit.

Changing the HotSync setting from the default affects only the *next* HotSync operation. Thereafter, the HotSync Actions revert to their default settings. To use a new setting on an ongoing basis, click Make Default. Thereafter, whatever you selected as the default setting is used for HotSync operations.

7. Click OK.
8. Repeat steps 4 through 6 to change conduit settings for other applications.
9. Close the Conduit Settings window.
10. Perform a HotSync operation.





## Frequently Asked Questions

If you encounter a problem with your handheld, do not call Technical Support until you have reviewed the frequently asked questions in this appendix and you have also reviewed the following:

- The readme file located in the folder where you installed the Palm™ Desktop software on your Windows computer or on your installation CD for Mac users
- The Palm Desktop online Help
- The *Palm Desktop Software for the Macintosh User's Guide* located in the Documentation folder on your installation CD
- The *Palm Knowledge Library*, accessible at [www.palm.com/support](http://www.palm.com/support).
- The most recent Palm™ Tungsten™ T3 handheld HelpNotes on your regional web site

If you are still having problems, contact Technical Support or go to [www.palm.com/support](http://www.palm.com/support).

**NOTE** Palm works with developers of third-party add-on applications to ensure the compatibility of these applications with your new Palm™ handheld. Some third-party applications, however, may not have been upgraded to be compatible with your new Palm handheld. If you suspect that a third-party application is adversely affecting the operation of your handheld, contact the developer of the application. For more information, see “[Problems with incompatible applications](#)” later in this chapter.

## Software installation problems

<b>Problem</b>	<b>Solution</b>
The installation menu did not appear when I inserted the Software Installation CD-ROM (or the Software Essentials CD-ROM) into my Windows computer.	<ol style="list-style-type: none"><li>1. From the Windows desktop, click Start.</li><li>2. Select Run.</li><li>3. Click Browse.</li><li>4. Locate your CD-ROM drive, and select the Autorun file.</li><li>5. Click Open.</li><li>6. Click OK.</li></ol>
I cannot install Palm Desktop software on my Windows computer.	<p>Try each of these in turn:</p> <ul style="list-style-type: none"><li>■ Disable any virus-scanning software on your computer.</li><li>■ Close any open applications.</li><li>■ Make sure your computer has at least 50MB of disk space available.</li><li>■ Delete all temporary files.</li><li>■ Run ScanDisk (or another disk verification tool) on your computer.</li><li>■ Install the latest Windows software updates to your computer.</li><li>■ If you are upgrading from an older Palm™ handheld, or non-Palm branded handheld, remove any previous version(s) of Palm desktop software using Add or Remove Programs on the Window's Control Panel.</li><li>■ Uninstall and then reinstall Palm Desktop software.</li></ul>
I cannot install Palm Desktop software on my Mac computer.	<p>Try each of these in turn:</p> <ul style="list-style-type: none"><li>■ Disable any virus-scanning software on your computer.</li><li>■ Quit any open applications.</li><li>■ Make sure your computer has at least 50MB of disk space available.</li><li>■ Install the latest Mac software updates to your computer.</li><li>■ If you are upgrading from an older Palm handheld, or non-Palm branded handheld, remove any previous version(s) of Palm desktop software.</li><li>■ Uninstall and then reinstall Palm Desktop software.</li></ul>

---

My files didn't install during a HotSync® operation.	If files do not install after you perform a HotSync operation, the file type was not recognized. Try launching the associated application from your handheld and then performing another HotSync operation. If the files remain in the Quick Install list, they are not associated with an application on your handheld and cannot be installed.
I can't add more files to the Palm™ Quick Install list.	Make sure the dialog box that confirms where the files will be installed is closed. You cannot add more files to the list when the confirmation dialog box is open. For details, see <a href="#">"Installing applications and files on a Windows computer"</a> in <a href="#">Chapter 4</a> .
When I add a Zip file to Quick Install, no files appear in the Quick Install list.	Unzip the file with a file compression utility, such as WinZip, and then add the unzipped files to Quick Install.

## Operating problems

### Problem

I don't see anything on my handheld's screen.

### Solution

Try each of these in turn:

- Press an application button to ensure that your handheld is turned on.
- If your handheld was exposed to cold, make sure it is at room temperature.
- Charge your handheld.
- Perform a soft reset. If your handheld still doesn't turn on, perform a hard reset. See ["Resetting your handheld"](#) in [Appendix A](#).

---

**IMPORTANT** With a hard reset, all records and entries stored in your handheld are erased. Never perform a hard reset unless a soft reset does not solve your problem. You can restore any data previously synchronized with your computer during the next HotSync operation.

---

I get a warning message telling me my handheld memory is full.

- Purge records from Calendar and Tasks. This deletes Tasks items and past Calendar events from the memory of your handheld. See [“Purging records”](#) in [Chapter 4](#). You must perform a HotSync operation to recover the memory.
- Delete unused memos, photos, and records. If necessary, you can save these records. See [“Deleting records”](#) in [Chapter 4](#). You must perform a HotSync operation to recover the memory.
- If you have installed additional applications on your handheld, remove them to recover memory. See [“Removing applications”](#) in [Chapter 4](#).

My handheld keeps turning itself off.

Your handheld is designed to turn itself off after a period of inactivity. This period can be set at 30 seconds or at one, two, or three minutes. Check the Auto-off after setting on the Power Preferences screen. See [“Power Preferences”](#) in [Chapter 21](#).

My handheld is not making any sounds.

Check the System, Alarm, and Game Sound settings. See [“Sounds & Alerts Preferences”](#) in [Chapter 21](#).

My handheld’s indicator light is not blinking when alarms occur.

Check the Alarm indicator light setting. See [“Alarm LED and Alarm Vibrate settings”](#) in [Chapter 21](#).

My handheld does not vibrate when alarms occur.

Check the Alarm Vibrate setting. See [“Alarm LED and Alarm Vibrate settings”](#) in [Chapter 21](#).

My handheld has frozen.

- If a network connection was improperly terminated, your handheld may appear to be frozen for up to 30 seconds. If it is still frozen after 30 seconds, perform a soft reset.
- Perform a soft reset. See [“Resetting your handheld”](#) in [Appendix A](#).
- If your handheld continues to freeze after a soft reset, check your third-party applications for incompatible applications. See [“Problems with incompatible applications”](#) later in this chapter.

## Tapping and writing problems

<b>Problem</b>	<b>Solution</b>
When I tap the buttons or screen icons, my handheld activates the wrong feature.	Calibrate the screen. See <a href="#">“Digitizer Preferences”</a> in <a href="#">Chapter 21</a> .
When I tap the Menu icon  , nothing happens.	Not all applications or screens have menus. Try changing to a different application.
I can't get my handheld to recognize my handwriting.	<ul style="list-style-type: none"> <li>■ For your handheld to recognize handwriting input with the stylus, you need to use Graffiti® 2 writing. Use the Graffiti 2 help to learn how to write characters. For more information, see <a href="#">“Using Graffiti® 2 writing”</a> in <a href="#">Chapter 3</a>.</li> <li>■ Make the Graffiti 2 character strokes in the Graffiti 2 input area, not on the display part of the screen. If you want to write on the display part of the screen, tap the Full-screen Writing button on the status bar to turn Full-screen Writing on. For more information on Full-screen Writing, see <a href="#">“Using Full-screen Writing”</a> in <a href="#">Chapter 3</a>.</li> <li>■ Write Graffiti 2 strokes for lowercase letters in the left side, strokes for capital letters in the middle, and strokes for numbers in the right side of the Graffiti 2 writing area. For more information, see <a href="#">“Writing in Graffiti 2 input areas”</a> in <a href="#">Chapter 3</a>.</li> <li>■ Make sure that Graffiti 2 is not in shift mode. See <a href="#">“Symbols and other special characters”</a> in <a href="#">Chapter 3</a>.</li> </ul>

## Application problems

<b>Problem</b>	<b>Solution</b>
I tapped the Today button, but it does not show the correct date.	Your handheld is not set to the current date. Make sure the Set Date box on the Date and Time Preferences screen displays the current date. See <a href="#">“Date &amp; Time Preferences”</a> in <a href="#">Chapter 21</a> for more information.
I know I entered some records, but they do not appear in the application.	<ul style="list-style-type: none"> <li>■ Check the Categories pick list (upper-right corner). Select All to display all the records for the application.</li> <li>■ Check Security and confirm that Private Records is set to Show private records.</li> <li>■ In Tasks, tap Show and see if Show Only Due Items is selected.</li> </ul>

I'm having problems listing memos, notes, or voice memos the way I want to see them.

- If you cannot manually arrange the order of memos, notes, or voice memos on the list screen, select Preferences from the Options menu and make sure that Sort by is set to Manual.
- If you choose to view your memos, notes, or voice memos alphabetically on Palm Desktop software and then perform a HotSync operation, the memos on your handheld still appear in the order defined in the Preferences setting. In other words, the sort settings you use with Palm Desktop software *are not* transferred to your handheld.

I created an event in Calendar, but it doesn't appear in the Week View.

If you have two or more events with the same start time, the first event created appears as a gray bar, and any subsequent conflicting events appear as a single red bar. To see the overlapping events select the Day View. For more information, see ["Spotting event conflicts"](#) in [Chapter 5](#).

My vCard or vCal e-mail attachment isn't forwarding correctly.

Palm Desktop software provides several features that interact with e-mail client software on a Windows computer. For these features to work correctly, the e-mail client software must be properly configured. Follow these steps to check the configuration:

1. Click the Windows Start menu, and then select Settings.
2. Select Control Panel.
3. Select Internet Options, and then click the Programs tab.
4. Make sure that the E-mail field is set to the correct e-mail client software.
5. Click OK.
6. Start the e-mail client software and make sure it is configured as the default MAPI client. Consult the documentation for your desktop e-mail application for more information.

The current date and time are incorrect.

The current date and time are tied to the Location setting. If you change the date and time without changing the Location setting, the current date and time may appear incorrect. See ["Date & Time Preferences"](#) in [Chapter 21](#) for information on setting the current location, date, and time.

## HotSync problems

### Problem

I cannot perform a HotSync operation. What should I check to make sure I'm doing it correctly?

### Solution

- Make sure the HotSync cradle/cable is connected securely.

On a Windows computer try these steps:

1. Check the Windows system tray to make sure the HotSync Manager is running. If it is not, click Start on the Windows taskbar, and then select Programs. Navigate to the Palm Desktop software program group, and select HotSync Manager. You should also see [“Selecting HotSync setup options”](#) in [Chapter 20](#) for instructions on selecting the correct HotSync Manager settings.
2. Make sure you selected Local USB or Local Serial, as appropriate, from the HotSync Manager menu.
3. If you are using the serial cradle make sure you selected the correct serial port on the Local tab in the Setup dialog box. It should be set to the port where you connected the HotSync cradle/cable.

On a Mac computer try these steps:

1. Make sure HotSync Manager is enabled. If it is not, double-click the HotSync Manager icon  in the Palm folder and enable HotSync Manager on the HotSync Controls tab.
2. Disconnect the cradle/cable from your computer, and then reconnect the cradle/cable and restart your computer.

I did a HotSync operation, but one of my applications did not synchronize.

- On a Windows computer, click the HotSync Manager and select Custom. Check that the correct conduit is active.
- On a Mac computer, double-click the HotSync Manager icon . From the HotSync menu, select Conduit Settings. Select your username from the User pop-up menu, and be sure that the correct conduit is active.

I am using Outlook as my PIM, but I cannot do a HotSync operation.

- Click the HotSync Manager and select Custom. Be sure that the correct conduit is active.
- Be sure that the correct conduit is installed. Reinstall the HotSync Manager and make sure that the correct conduit is selected.
- Reinstall Palm Desktop software and select the option to synchronize with Microsoft Outlook.

I cannot launch the HotSync Manager.

- If you are using the optional serial cradle/cable, or if you are performing a HotSync operation using a modem, make sure you are not running another program, such as America Online, that uses the serial port you selected in the Setup dialog box.
- Make a backup copy of your Palm Desktop data, and then reinstall Palm Desktop software.

When I perform a HotSync operation on my Windows computer, I receive the 8009 error message: An application has failed to respond to a hotsync notification.

The 8009 error indicates that the Windows registry is corrupt. you need to rebuild the HotSync Manager registry entries. Information on rebuilding the registry entries, go to [www.palm.com/support](http://www.palm.com/support) and search the *Palm Knowledge Library* for “error 8009.”

I tried to do a local HotSync operation, but it did not complete successfully.

- Make sure your handheld is seated in the cradle/cable correctly.
- Check the connection between the HotSync cradle/cable and the USB or serial port on your computer.
- Make sure the username you selected in Palm Desktop software matches the username assigned to your handheld.
- Make sure the date on your computer matches the date on your handheld.
- Read the HotSync Log for the user account for which you are performing a HotSync operation.
- From the Palm Desktop home screen, click the HotSync Manager and then select Custom. Be sure that the conduits are set correctly.



I tried to do a local HotSync operation, but it did not complete successfully.  
(continued)



On a Windows computer, try each step in turn:

- Make sure that HotSync Manager is running. If it is running, close it and restart it.
- Make sure you selected Local USB or Local Serial, as appropriate, from the HotSync Manager menu.
- If you are using the serial cradle/cable, try the following:
  - Make sure you selected the correct serial port on the Local tab in the Setup dialog box. It should be set to the port where you connected the HotSync cradle/cable.
  - Try a lower baud rate setting on the Local tab in the Setup dialog box.
  - Make sure you aren't running a program, such as America Online, that uses the serial port you selected in the Setup dialog box.

On a Mac computer, try each step in turn:

- Make sure HotSync Manager is enabled on the HotSync Controls tab in the HotSync Software Setup window.
- If you are using the optional serial cradle/cable, try the following:
  - Double-click the HotSync Manager icon  in the Palm folder, and then click the Connection Settings tab. Make sure the port selection matches the port where your HotSync cradle/cable is attached.
  - Try a lower Speed setting on the Connection Settings tab.
  - Make sure you aren't running a program, such as America Online, fax or telephony software, or AppleTalk networking, that uses the serial port you selected in the Connection Settings tab.

When I press the HotSync button on the cradle/cable, nothing happens on Palm Desktop software, and my handheld times out.

- Make a copy of your Palm folder. Uninstall and then reinstall Palm Desktop software.
- Turn on your handheld, and tap the Home icon . Select the HotSync icon , and then tap Local.

When I perform a HotSync operation, my information does not transfer to Palm Desktop software.

- If you have performed a HotSync operation successfully but you cannot find the data from your handheld on Palm Desktop software, check to see that you have the correct username selected for viewing data.
- On a Windows computer, click the HotSync Manager and select Custom. Check that all conduits are set to synchronize files.
- On a Mac computer, double-click the HotSync Manager icon. From the HotSync menu, select Conduit Settings. Select your username from the User pop-up menu, and check that the correct conduit is active. If you have upgraded from a previous handheld, go to [www.palm.com/support/tungstenT3](http://www.palm.com/support/tungstenT3) and click on the Upgrading link.

I want to synchronize my computer with more than one handheld.

- If the computer running Palm Desktop software synchronizes with more than one handheld, each handheld must have a unique name. Assign a username to your handheld the first time you perform a HotSync operation.
- Be aware that synchronizing more than one handheld with the same username causes unpredictable results and, potentially, loss of your personal information.
- If you are synchronizing with MS Outlook, make sure the right profile is selected for the Conduits in HotSync Manager. From the Palm Desktop home screen, click the HotSync Manager and then select Custom.

I can't perform a Bluetooth™ HotSync operation.

- Make sure that Bluetooth communication is enabled on both your handheld and your computer.
- When you perform a Bluetooth HotSync operation, your handheld attempts to connect to a Bluetooth virtual serial port on your computer. First it looks for a Bluetooth serial HotSync port. If it cannot find that port, it then looks for a generic Bluetooth serial port. However, some generic Bluetooth serial ports do not support HotSync operations.
- Your handheld may not be able to recognize the virtual serial port on your Windows computer. Try validating the virtual serial port you're using, or create a different virtual port and change the HotSync Manager settings to use the new virtual port. Refer to the documentation that came with your computer operating system for instructions.

I can't perform a Bluetooth™ HotSync operation.  
(continued)

- Some computers have a dedicated virtual serial port number, such as COM5, and other computers enable you to choose a port number, such as COM8 or COM12. Refer to the documentation that came with your computer for information on dedicated versus flexible virtual ports.
- If the virtual serial port you want to use is used by other applications, exit those applications before setting up your computer for a Bluetooth HotSync operation.

I receive an authentication error when I try to perform a HotSync operation using Bluetooth and a wireless LAN access point.

- Make sure you entered the correct username and password for the selected network service profile in the Network Preferences screen. See “[Network Preferences](#)” in [Chapter 21](#) for details.

When I try to perform a HotSync operation using Bluetooth and a wireless LAN access point, it connects but nothing happens.

- Make sure that Network is selected on the HotSync Manager menu on your computer.
- Contact your system administrator to make sure your network computer is properly set up.

I tried to do a modem HotSync operation, but it did not complete successfully.

Check the following on your computer:

- Make sure your computer is turned on and that it does not shut down automatically as part of an energy-saving feature.
- Make sure the modem connected to your computer is turned on and is connected to the outgoing phone line.
- Make sure the modem you are using with your handheld has an on-off switch. Your handheld cannot “wake up” a modem that has an auto-off feature.
- Make sure the modem is connected properly to your computer and is connected to the incoming phone line.

For additional modem HotSync troubleshooting tips, go to [www.palm.com/support](http://www.palm.com/support).

I can't perform an IR HotSync operation.

- On a computer running Windows 98, be sure that the HotSync Manager is running, that Infrared is selected on the HotSync Manager menu, and that the Serial Port for local operations is set to the simulated port for infrared communication. See [“Conducting IR HotSync operations”](#) in [Chapter 20](#) for details.
- On a computer running Windows 2000/ME/XP, select IR in the HotSync Manager. See [“Preparing your computer for infrared communication”](#) in [Chapter 20](#) for details.
- On a Mac computer, make sure the infrared communications extensions have been installed in the Extensions folder inside the System folder. Next, open the HotSync Software Setup window, and be sure that HotSync Manager is enabled and that the Local Setup Port is set to Infrared Port. See [“Conducting IR HotSync operations”](#) in [Chapter 20](#) for more information.
- On your handheld, be sure the HotSync application is set to Local, with the option IR to PC/Handheld.
- Be sure the IR port of your handheld is aligned directly opposite to, and within a few inches of, the infrared device of your computer.
- IR HotSync operations do not work after you receive a low battery warning. Check the battery power of your handheld. Recharge the internal battery.
- Turn off some conduits to speed the HotSync. IR transfer speeds are much lower than USB transfer speeds. HotSync operations with photos, MP3, or video files can take up to an hour or more.

My handheld displays the message “Waiting for sender” when it's near my computer's infrared port.

- Your computer's infrared port may be set to search automatically for the presence of other infrared devices. Consult the documentation for your operating system for information about turning off this option.
- In some cases simply moving your handheld away from the computer's infrared port solves the problem.

My handheld appears to freeze when I place it near my computer.

Move your handheld away from the computer's infrared port.

## Beaming and sending problems



<b>Problem</b>	<b>Solution</b>
I cannot beam data to another device with an IR port.	<ul style="list-style-type: none"> <li>■ If you are beaming to another Palm handheld, confirm that your handheld and the other handheld are between ten centimeters (approximately 4 inches) and one meter (approximately 39 inches) apart and that the path between the two handhelds is clear of obstacles. Beaming distance to other devices with an IR port may be different.</li> <li>■ Move your handheld closer to the receiving device.</li> <li>■ Make sure the receiving device has beam receive enabled.</li> </ul>
When someone beams data to my handheld, I get a message telling me it is out of memory.	<ul style="list-style-type: none"> <li>■ Your handheld requires at least twice the amount of memory available as the data you are receiving. For example, if you are receiving a 30KB application, you must have at least 60KB free.</li> <li>■ Perform a soft reset. See <a href="#">“Performing a soft reset”</a> in <a href="#">Appendix A</a> for more information.</li> </ul>
I cannot send data to another Bluetooth device.	<ul style="list-style-type: none"> <li>■ Make sure that Bluetooth communication is enabled on both your handheld and the other device.</li> <li>■ Make sure that the receiving device has a compatible Bluetooth application installed.</li> </ul>

## Phone connection problems

<b>Problem</b>	<b>Solution</b>
My passkey is rejected when I attempt to pair (or bond) my mobile phone with my handheld.	<ul style="list-style-type: none"> <li>■ Some mobile phones require that you enter the passkey within a specific time frame. Make sure you have a passkey in mind and that you enter it immediately when prompted.</li> <li>■ If your passkey is rejected, your phone may have a preassigned passkey; see the documentation included with your phone for information. The documentation might refer to a Bluetooth connection as a Bluetooth pair or a Bluetooth link.</li> <li>■ If you need additional information about pairing your phone and handheld, refer to the <i>Phone Pairing Handbook</i> at <a href="http://www.palm.com/support">www.palm.com/support</a>.</li> </ul>

My handheld cannot connect to my mobile phone.

Use the following steps to test the connection:

1. Tap the Home icon .
2. Select the Phone Link icon .
3. Tap Connect.
4. If the connection is successful, open the application that requires the connection and complete the desired task.

If the connection is not successful, try the following steps:

- If you have a Bluetooth phone, you may need to go through the pairing process on both your handheld and your phone. See [“Setting up a phone connection”](#) in [Chapter 12](#) for information on completing the pairing process on your handheld. See the documentation included with your phone for assistance with completing the pairing process on your phone. If you need additional information about connecting your phone, refer to the *Phone Pairing Handbook* at [www.palm.com/support](http://www.palm.com/support).
- Make sure the Connection for your mobile phone is selected in the Connection Preferences screen and the Phone Preferences screen.
- If you are using a Bluetooth connection, make sure that your phone is equipped with Bluetooth technology, that Bluetooth is enabled, and that the power is on.

My phone connection drops before I finish using it.

- You need to increase the Idle timeout setting on the Network Preferences Details screen. See [“Adding detailed information to a network service profile”](#) in [Chapter 21](#) for instructions.

I get an error message when I try to dial a phone number using my handheld.

- Make sure that the proper phone driver is installed on your handheld. See [“Updating the phone files on your handheld”](#) in [Chapter 12](#) for instructions.
- You may need to go through the pairing process on both your handheld and your phone. See [“Connection Preferences”](#) in [Chapter 21](#) for information on completing the pairing process on your handheld. See the documentation included with your phone for assistance with completing the pairing process on your phone.
- Check the Phone Preferences screen and make sure the correct phone connection is selected.

## VersaMail™ e-mail software problems

### Problem

I am having problems accessing my account.

### Solution

Occasionally you may experience problems using an e-mail account after you set it up. Be sure to follow the account setup procedures in [Chapter 16](#). If you followed the procedure and are experiencing problems using the account, verify that the account complies with your e-mail provider's requirements by following these steps:

- Verify both your password and your username for your e-mail account.
- If you are connecting using an external modem device such as a PalmModem® accessory, verify that you have an account with an ISP and are able to dial in over a voice phone line.
- If you are connecting using a mobile phone through the built-in Bluetooth radio on your handheld, a cable, or the IR port on your handheld, verify that you have either a data-enabled GSM or a high-speed GPRS account with your wireless service provider.
- Some wireless service providers require you to be on their network to use your e-mail account. If this is the case, be sure to use your provider's network as the connection type for the account.
- Some wireless service providers have other requirements specific to their service. For example, Yahoo! requires you to set up POP mail forwarding for your Yahoo! account in order to download e-mail messages to your handheld. Check with your service provider to see if any provider-specific requirements exist.
- Service provider settings frequently change. If your e-mail account was working, but you are currently experiencing problems, check with your service provider to see if any of the account settings have changed.

I am having difficulty sending and receiving mail using a synchronize-only account.

Make sure you have chosen the same settings for the account on both your handheld and your desktop. For example, if the account is set up on the handheld to use the POP protocol, check the HotSync manager on the desktop to make sure that POP is selected as the protocol for that account.

## Recharging problems

### Problem

When I connect my handheld to the cradle/cable, it does not charge.

### Solution

- Confirm that your handheld is firmly connected to the cradle/cable.
- Confirm that your recharger cable is properly connected to the back of the cradle/cable's USB or serial port connector that plugs into your computer.
- Confirm that your recharger is plugged into an AC outlet that has power.
- If you have not used your handheld for a long period, such as an extended vacation, the battery may not contain enough charge to power the indicator light. After your handheld has recharged, the indicator light will function normally.

My battery drains too quickly.

Battery life varies with usage. If your battery drains quickly while not in use, your handheld may be turning on accidentally. You can prevent your handheld from accidentally turning on by setting the Keylock feature. See [“Keylock Preferences”](#) in [Chapter 21](#).

## Password problems

### Problem

I forgot the password, and my handheld is not locked.

### Solution

- First, use the password hint to try to remember the password. If this doesn't help or if you do not have a password hint, you can use Security to delete the password, but your handheld deletes all entries marked as private. However, if you perform a HotSync operation *before* you delete the password, the HotSync process backs up all entries, whether or not they are marked private. Then you can follow these steps to restore your private entries:
  - a. Use the Palm Desktop software and the cradle/cable or infrared communication to synchronize your data.
  - b. Tap Forgotten Password in Security to remove the password and delete all private records.
  - c. Perform a HotSync operation to synchronize your data and restore the private records by transferring them from your computer to your handheld.



- I forgot the password, and my handheld is locked.
- First, use the password hint to try to remember the password. If this doesn't help or if you do not have a password hint, you must perform a hard reset to continue using your handheld. See [“Performing a hard reset”](#) in [Appendix A](#) for more information.

## Problems with incompatible applications

Palm, Inc. works with developers of third-party add-on applications to ensure the compatibility of these applications with your new Palm Tungsten T3 handheld. Some third-party applications, however, may not have been upgraded to be compatible with your new Palm handheld.

Possible symptoms of incompatible applications include:

- Fatal errors needing resets
- Frozen handheld requiring a reset
- Slow performance
- Abnormal screen display
- Problems using Bluetooth or other features
- Uneven sound quality
- Problems opening an application
- Problems performing a HotSync operation

You can determine whether an incompatible application is causing problems by deleting the application and then operating your handheld. For instructions on deleting an application from your handheld, see [“Removing applications”](#) in [Chapter 4](#).

After you have deleted the application, try to replicate the operation that created the error. If removing the application solves your problem, contact the application developer for a solution.

### Finding a third-party application that is causing a problem

If you have multiple third-party applications installed on your handheld or have upgraded from an earlier model of a Palm handheld, perform the following procedure to remove all third-party applications from your handheld. Once you have removed all of the third-party applications, you can install one application at a time to determine which application is causing the problem.

---

**IMPORTANT** The following procedures erase all data from your handheld. Before removing the applications, perform a HotSync operation to backup your data.

---

**To remove all third-party applications:**

1. Open the Palm folder on your desktop computer.
2. Open the user folder for your handheld.  
User folder names are abbreviated as *lastname firstinitial*.
3. Select and drag the Backup folder to the Windows desktop.  
Make sure you see the Backup folder on the Windows desktop.
4. Close the Palm folder.
5. Perform a hard reset. See “[Performing a hard reset](#)” in [Appendix A](#) for details.
6. Perform a HotSync operation.
7. Operate your handheld and try to replicate problem operations.
8. Perform one of the following:
  - If your handheld still has problems, see the other sections in this chapter for solutions to the problem. Fix the problem before re-installing the third-party applications.
  - If your handheld no longer has problems, install the third-party applications one application at a time using the following procedure.

**To re-install third-party applications one at time:**

1. Open the Backup folder
2. Double-click on one .prc file.  
The Palm™ Quick Install window opens with the .prc file listed.
3. Click Done.
4. Perform a HotSync operation to install the files. See [Chapter 20](#) for details.
5. Operate your handheld and try to replicate problem operations.
6. Perform one of the following:
  - If installing the application recreates your problem, remove the application and contact the application developer for a solution. Continue to re-install your applications one application at a time to make sure another application is not creating a problem.
  - If installing the application does not cause a problem, got to step 1 and reinstall another application.



## Technical support

If, after reviewing the sources listed at the beginning of this appendix, you cannot solve your problem, go to [www.palm.com/support](http://www.palm.com/support) or send an e-mail to your regional Technical Support office.

Before requesting technical support, please experiment a bit to reproduce and isolate the problem. When you do contact Technical Support, please provide the following information:

- The name and version of the desktop operating system you are using
- The actual error message or state you are experiencing
- The steps you take to reproduce the problem
- The version of handheld software you are using and available memory

**To find version and memory information:**

1. Tap the Home icon .
2. Tap the Menu icon .
3. Select Info from the App menu.

**NOTE** Palm works with developers of third-party add-on applications to ensure the compatibility of these applications with your new Palm handheld. Some third-party applications, however, may not have been upgraded to be compatible with your new Palm handheld. If you suspect that a third-party application is adversely affecting the operation of your handheld, contact the developer of the application.



# Product Regulatory Information

## FCC Statement

This device complies with part 15 of the FCC rules. Operation is subject to the following two conditions: (1) This device may not cause harmful interference, and (2) this device must accept any interference received, including interference that may cause undesired operation.

**NOTE** This equipment has been tested and found to comply with the limits for a Class B digital device, pursuant to Part 15 of the FCC rules. These limits are designed to provide reasonable protection against harmful interference in a residential installation. This equipment generates, uses, and can radiate radio frequency energy and, if not installed and used in accordance with the instructions, may cause harmful interference to radio communications. However, there is no guarantee that interference will not occur in a particular installation. If this equipment does cause harmful interference to radio or television reception, which can be determined by turning the equipment off and on, the user is encouraged to try to correct the interference by one or more of the following measures:

- Reorient or relocate the receiving antenna.
- Increase the separation between the equipment and receiver.
- Connect the equipment into an outlet on a circuit different from that to which the receiver is connected.
- Consult the dealer or an experienced radio/TV technician for help.

The use of shielded I/O cables is required when connecting this equipment to any and all optional peripheral or host devices. Failure to do so may violate FCC rules.

**CAUTION** Changes or modifications not covered in this manual must be approved in writing by the manufacturer's Regulatory Engineering Department. Changes or modifications made without written approval may void the user's authority to operate this equipment.

### Responsible Party:

Palm Solutions Group  
400 N. McCarthy Boulevard  
Milpitas, California 95035  
United States of America  
(408) 503-7500

Palm™ Tungsten™ T3 Product Family

 Tested to Comply  
With FCC Standards

**FOR HOME OR OFFICE USE**

## Canadian IC Notice

To prevent radio interference to the licensed service, this device is intended to be operated indoors and away from windows to provide maximum shielding. Equipment that is installed outdoors is subject to licensing.

## Canadian ICES-003 Statement

This Class B digital apparatus meets all requirements of the Canadian Interference-Causing Equipment Regulations.

Cet appareil numérique de la classe B respecte toutes les exigences du Règlement sur le matériel brouilleur du Canada.

## FAA Statement

Whenever you use the wireless features of your handheld, please observe the guidelines or prohibitions on the use of wireless devices in your current location. For example, when you are on an airplane, do not use the Bluetooth™ communication features of your handheld at times when government or airline regulations prohibit the use of cellular phones. You can, of course, use all other applications on your handheld in accordance with airline regulations for electronic devices.

## Electrical Transmission Statement

This product has been certified as conforming to technological standards for a wireless device as a small electrical data transmission under electrical transmission law. Therefore, you do not need a license from a government agency to operate this product.

This product has been certified as conforming to technological standards. Therefore, the following action are punishable by law:

Disassembly or modification of this product.

Removal of identification labels on the back of this product.

## ARIB STD-T66 Statement (Japan)

This product uses a radio wave in the 2.4 GHz bandwidth. This frequency is also used by the microwave ovens industry, scientific and medical devices, in addition to wireless transmitters for motion detectors, such as those requiring licenses used on manufacturing lines or similar radio transmitters. It is also used in specified amateur radio stations or small radio stations not requiring licenses (all these wireless devices will be called “other wireless transmitters” below).

1. Before using this product, confirm that other wireless transmitters are not in use nearby.
2. In the unlikely event that there is electronic interference between this product and other wireless transmitters, quickly change the operating frequency of this product, change the location of operation, or stop operating the product (cease transmission of a signal).
3. If other electrical interference or related problems should occur, contact the responsible party.

## Europe R&TTE Directive (Europe)

### Declaration of Conformity

Application of Council Directive(s):

89/336/EEC EMC Directive

99/5/EC RTTE Directive

72/23/EEC Low Voltage Directive

Standards to which Conformity is Declared:

ETSI301 489-1 (Immunity)

EN60950 1992/A1:1993/A2:1993/A3:1995/A4:1997/A5:1998 (Safety)

EN55022:1994/A1:1995/A2:1997/A3:1998 Class B (Emissions)

The product is CE marked.

The product fulfills the essential requirements of the harmonized standards shown above.

Manufacturers Name: Palm Solutions Group

Manufacturers Location: 400 North McCarthy Blvd., Milpitas, CA 95035-5112, USA

Importers Name: Palm Germany GmbH

Importers Location: Landsberger Strasse 155, D-80687 Munchen, Germany

Type of Equipment: Handheld Computer

Model Number: Palm Tungsten T3

Year of Manufacture: 2003

I, the undersigned hereby declare that the equipment specified above conforms to the above Directive(s) and Standard(s)

Place: Milpitas, CA

Date: April 29, 2003

Name: David Woo

Title: Global Compliance Manager

## Taiwan Statement

Article 14: Unless approved, for any model accredited low power radio frequency electric machinery, any company, trader, or user shall not change the frequency, increase the power, or change the features and functions of the original design.

Article 17: Any use of lower power radio frequency electric machinery shall not affect the aviation safety and interfere with legal communications. In even that any interference is found, the use of such electric machinery shall be stopped immediately, and reusing of such products cannot be resumed until no interference occurs after improvement.

The legal communications mentioned in the above item refer to radio communications operated in accordance with telecommunication laws and regulations.

Low power radio frequency electric machinery shall resist against interference from legal communications or from industrial, scientific, and medical radio electric machinery.

## Battery Warning

Do not mutilate, puncture, or dispose of batteries in fire. The batteries can burst or explode, releasing hazardous chemicals. Discard used batteries according to the manufacturer's instructions and in accordance with your local regulations.

### Varning

Eksplotionsfara vid felaktigt batteribyte. Använd samma batterityp eller en ekvivalent typ som rekommenderas av apparattillverkaren. Kassera använt batteri enligt fabrikantens instruktion.

### Advarsel!

Lithiumbatteri—Eksplotionsfare ved fejlagtig håndtering. Udskiftning må kun ske med batteri af samme fabrikat og type. Levér det brugte batteri tilbage tilleverandøren.

### Varoitus

Paristo voi räjähtää, jos se on virheellisesti asennettu. Vaihda paristo ainoastaan valmistajan suosittelemaan tyyppiin. Hävitä käytetty paristo valmistajan ohjeiden mukaisesti.

### Advarsel

Ekspløsjonsfare ved feilaktig skifte av batteri. Benytt samme batteritype eller en tilsvarende type anbefalt av apparatfabrikanten. Brukte batterier kasseres i henhold til fabrikantens instruksjoner.

### Waarschuwing!

Bij dit produkt zijn batterijen geleverd. Wanneer deze leeg zijn, moet u ze niet weggooien maar inleveren als KCA.

### Uwaga

Nie kroić lub przekłuwać baterii, ani nie wrzucać ich do ognia. Mogą się rozerwać lub wybuchnąć wydzielając trujące środki chemiczne. Zużytych baterii należy pozbywać się w sposób opisany przez producenta i zgodnie z miejscowymi przepisami.

אזהרה  
יש סכנת התפוצצות אם מחליפים את הסוללה בצורה לא נכונה.  
יש להחליף את הסוללה בסוללה זהה או דומה, בהתאם להמלצת היצרן.  
יש להשליך סוללות משומשות בהתאם להוראות היצרן



## A

- ABA. *See* Contacts archive files
- Account. *See* E-mail account
- Action icons 238
- Add/Remove Programs icon 61
- Add-on applications 54–61
- Addressing e-mail
  - displaying another address 158
  - message 187–190
  - using Smart Addressing 189
- Addressing SMS messages 130
- Advanced preferences 211
- Agenda View
  - background image 64
  - display options 64
  - displaying 64
  - displaying tasks 64
- Alarm
  - indicator light 9
  - LED 347, 348
  - lists 53
  - preset 77
  - setting in Calendar 69
  - setting in Note Pad 107
  - setting in Voice Memo 234
  - setting in World Clock 267
  - sound 77, 171, 267, 346, 358
  - status bar button 17
  - Vibrate setting 347, 348
- Alerting for new mail 170
- Alphabet, Graffiti 2 24
- APOP
  - adding to an account 163
  - and synchronization 220
  - requirement 150
- Application buttons 8, 37, 63, 83, 105, 139, 306
- Applications
  - beaming 29–31
  - Calendar 63
  - Card Info 79
  - categories 39
  - Contacts 83
  - Dialer 93
  - Expense 97
  - font style 53
  - installing 54–60
  - Launcher 37
  - Memos 103
  - Note Pad 105
  - opening 38
  - Palm Photos 119
  - Palm VersaMail 147
  - Phone Link 109
  - plug-in 333
  - removing 60
  - sending data from 135
  - size in kilobytes 373
  - SMS 129
  - Tasks 139
  - version of 373
  - Voice Memo 229
  - Web Pro 237
  - World Clock 261
  - See also* Add-on applications
- Archive files
  - importing data from 33
  - for main applications 33
  - saving deleted records 44
  - saving purged records 45
- Attaching a signature to messages 158
- Attachments 133
  - attaching files from an expansion card 206
  - attaching files from applications 204
  - downloading 214
  - icon for 174
  - saving to expansion card 203
  - sending 190
- Audio files 54, 58

- Auto get mail 167
  - notification options 170
  - notifications 169
  - Reminders screen 171
  - resource issues 174
  - scheduling 167
  - VPN connections 152
- Autofill, enabling or disabling 254
- Automatic fill, in Expense 102
- Automatic sending of messages. *See* Send retry
- Auto-off delay 336

## B

- Background sending of messages. *See* Send retry
- Battery
  - charge light 9
  - conserving power 336
  - disposal 378
  - gauge 37
  - life and use 350
  - recharging 3
  - recycling 350
  - warning 378
- Bcc field 187
  - See also* Blind copies
- Beaming
  - information 29
  - location of IR port 10
  - pen stroke to activate 307
  - problems with 367
  - URLs 247
  - See also* Infrared
- Beep for new mail 169
- Blind copies 158, 188
- Blinking asterisk 171
- Bluetooth
  - entering passkey 112, 367
  - HotSync operations 287–289
  - making connections 305
  - phone connection 109–117
  - preferences 299–306
  - status bar button 17
- Bold font for text 52
- Bookmarking web pages 248–250
- Brightness control
  - Pen preferences 307
  - status bar 18

- Broken envelope icon 172, 192
- Browsing files on a card 244
- Browsing the web 239–241
- Business card for beaming 30
- Buttons preferences 306–307

## C

- Cache 256
  - clearing 256
- Calendar
  - adding Contacts data to records 50
  - Agenda View display options 64
  - alarm 69
  - archive files (.dba) 33
  - categories 71
  - category colors 72
  - changing event time 71
  - changing event to untimed 68
  - conduit for synchronizing 273
  - conflicting events 75
  - continuous events 69
  - creating records 43
  - Day View display options 65
  - display Week View 72
  - displaying Agenda View 64
  - displaying Day View 65
  - displaying e-mail messages 64
  - displaying tasks 64
  - end time for Day view 77
  - events spanning midnight 67
  - fonts 52
  - menus 77
  - Month view 73
  - notes for records 51–52
  - opening 63
  - private records 344
  - purging records 44–45
  - repeating events 69
  - scheduling events 69, 71
  - selecting dates 67
  - start time for Day view 77
  - Sunday or Monday to start week 317
  - untimed events 68
  - viewing appointment reminders 171
  - Week view 72, 317, 360
- Calibration 13, 316
- Call Waiting, disabling 285, 324

- Calling card, using in phone settings 285, 324
- Card Info 79
- Caring for the handheld 349
- Categories 132
  - assigning records to 45–46
  - beaming 29–31
  - creating 47
  - default 39, 45
  - displaying 46, 92, 359
  - event color codes 71
  - for bookmarks 248
  - for saved pages 244
  - merging 47
  - renaming 47
  - sending 32
  - using in Applications Launcher 39
- Cc field 188
- Changing
  - home page 253
  - image download preferences 251
  - saved page information 244
- Charging handheld 3
- Check boxes 14
- Clearing
  - cache 257
  - History list 251
  - reminders 172
- Color Theme preferences 308
- Combining categories 47
- Comma-delimited files, importing data from 33
- Command
  - buttons 14
  - equivalents (Graffiti 2 writing) 42
  - stroke 42
  - toolbar 42
- Command toolbar
  - activating 42
- Communication preferences 297
  - Bluetooth 299–306
  - Connection 308–314
  - Network 319–334
  - Phone 335
- Compression, of images 253
- Conduits
  - account information screens 224
  - for modem HotSync operations 286
  - for synchronizing applications 361
  - for synchronizing applications, Mac 274
  - shortcuts 225
  - SSL and 228
  - for synchronizing applications 273, 352
  - synchronizing multiple accounts 227
- Conflicting events 75
- Connecting
  - service templates 320
  - to server or ISP 325
  - to the Internet 238
  - with a GPRS network 311–312, 319–329
  - with a non-GSM phone 313–314
  - with a phone 311–314
- Connection
  - mobile phone 237
  - modifying Web Browser Pro preferences 257
  - preferences 308–314
  - preferences for Bluetooth 322
  - requirements 237
- Connection types
  - modem sled, prerequisite for 150
  - network connection 149
  - PalmModem accessory, prerequisite for 150
  - synchronize-only connection 149
- Contacts
  - \*If Found Call\* entry 85
  - adding custom fields 92
  - adding e-mail address from 188
  - adding entry from e-mail 214
  - archive files (.aba) 33
  - business card for beaming 30
  - conduit for synchronizing 273
  - creating records 43
  - displaying category 92
  - displaying data in the Address list 88
  - finding records 15–50
  - fonts 52
  - notes for records 51–52
  - opening 83
  - private records 344
  - sorting records 51
  - using to address e-mail 188
- Content
  - latest web page 245
  - old web page 245
- Controlling Internet access 257

- Cookies
    - definition 255
    - enabling or disabling 255
  - Country default setting 316
  - Cradle
    - connecting to computer 11
    - for local HotSync operations 275, 281
    - viewing data from 337
  - Creating
    - categories 39, 47
    - Contacts entries 83–85
    - currency symbols 100
    - custom fields in Contacts 92
    - Expense items 97
    - expense reports 101
    - notes for records 51
    - records 43
    - ShortCuts 344
    - signature 134
    - SMS messages 130
  - Currency
    - default 100
    - defining 100
    - for Expense items 99
  - Current date 359
  - Current time 37
  - Custom
    - currencies and symbols 100
    - fields in Contacts 92
  - Cycling through views 63, 83, 105, 139
- D**
- Data entry. *See* Entering data
  - Database
    - upgrading a MultiMail database 148
  - Databases, downloading 242
  - Date
    - displaying in World Clock 267
    - Expense item 98
    - setting current 262, 314, 359
    - Tasks record due 141
  - Date & Time preferences 314–315
  - Day (Calendar view) 66
  - Day View
    - display options 65
    - displaying 65
    - events spanning midnight 67
  - Daylight Saving
    - options 265
    - settings 264
  - DBA (Calendar archive file) 33
  - Decimal point 317
  - Default
    - categories 39, 45
    - currency in Expense 100
  - Deleted data, saving in archive files 44
  - Deleting
    - applications 60
    - bookmarks 250
    - Desktop software 61
    - e-mail 208–210
    - mail in the trash 210
    - old messages 209
    - passwords 339
    - records 44
    - saved pages 244
    - service templates 333
    - See also* Purging records
  - Desktop software
    - linking to external files 34, 293
    - removing 61, 62
    - saving deleted data in archive file 44
  - Device
    - assigning name 299
    - enabling/disabling the user cache 305
    - types with which you can connect 298
  - Digitizer 13, 316
    - calibrating your handheld 13
    - preferences 316
  - Disabling
    - autofill 254
    - cookies 254
    - JavaScript 255
  - Disconnecting
    - from the Internet 238
  - Discovery
    - and connection process 300
    - defined 300
    - enabling/disabling the user cache 305
  - display 39
  - DNS 330
  - Domain name system. *See* DNS
  - Double-booked events 75

- Download
    - attachments 174
    - message size 157
    - messages from phone 131
  - Downloading
    - files, all types 242
  - Drafts
    - creating 185
    - creating in SMS 133
    - saving 190, 193
  - Dragging
    - stylus to activate features 307
    - using the stylus 13
- E**
- Editing
    - bookmarks 249
    - records 43–44
    - saved pages 244
  - E-mail
    - adding attachments 204–206
    - adding Contacts entry from e-mail 214
    - addresses in Contacts 86
    - addressing 187
    - alert for new mail 170
    - attaching files 165
    - attaching files from an expansion
      - card 206
    - attaching files from applications 204
    - attachments 198–208
    - auto get notifications 169
    - beeping for new mail 169
    - buzzing or blinking for new mail 170
    - color selection 177
    - composing 190
    - creating new messages 186–190
    - days to synchronize 222
    - deleting messages on handheld 208–210
    - display options 177
    - displaying in Calendar 64
    - downloading large attachments 202–203
    - drafts 193
    - e-mailing URLs 247
    - emptying trash 210–211
    - font selection 177
    - forwarding 194, 195
    - forwarding attachments 208
    - getting entire message 165
    - getting on desktop 216–221
    - getting subject only 165
    - HTML 176
    - icons 174, 193
    - leaving mail on server 156
    - marking read and unread 211–213
    - maximum message size 157
    - message format 176
    - notification options 170
    - personal signature 193, 214
    - preferences 213–214
    - reading 164
    - replying to 195–197
    - saving attachments to expansion
      - card 203
    - scheduling auto get mail 167
    - send retry 192
    - sending 190
    - signature, adding 158
    - storing in Outbox 190
    - trash 210
    - URLs in messages 197
    - viewing attachments 198–201
  - E-mail account
    - auto get mail 167
    - before setting up 149
    - checking for new messages 164, 165
    - color selection 177
    - corporate 151
    - creating new 152–157
    - default mail service 161–162
    - deleting accounts 160–161
    - display options 177
    - displaying Inbox 164
    - editing accounts 160
    - font selection 177
    - incoming and outgoing server 154
    - notification option 169
    - password 154
    - problems with 164
    - synchronization options 216–221
    - synchronizing 215, 226–227
    - troubleshooting 164
    - username 154
  - Emptying the History list 251
  - Enabling
    - autofill 254
    - cookies 254
    - JavaScript 255

Entering data 21–35  
    importing from other applications 33–35  
    problems with 359  
    using the computer keyboard 32  
    using the onscreen keyboard 21

Envelope icon 174

Error log 216

ESMTP 150  
    adding to an account 163

Euro  
    in Expense 99, 100  
    in Graffiti 2 writing 27  
    in onscreen keyboard 22

Events, Calendar 63

Exclamation marks in Tasks 146

Expansion  
    adding hardware 11  
    using cards 79

Expansion Card  
    applications 38  
    copying applications 39  
    described 12  
    formatting 80  
    renaming 79

Expansion card 244

Expense  
    creating records 97  
    currency 99  
    date of item 98  
    defining new currency 100  
    menus 102  
    overview 97  
    receipt details 98  
    reports 101  
    type 99, 102  
    vendor 99

Extended MAPI 217

External keyboard 35

## F

FAQs. *See* Frequently asked questions

FCC Statement 375

File types that can be downloaded 242

Files

    error log 216  
    linking to external 34, 293

Finding

    information in applications 47

    phone numbers 50  
    status bar button 17  
    using the Find application 48

Folders

    creating new 185  
    viewing other 177

Fonts 53

    choosing fonts in applications 52  
    setting size in Web Pro 251

Formats preferences 316

Forwarding e-mail 194

Frequently asked questions

    application problems 359  
    beaming and sending problems 367  
    HotSync problems 361  
    operating problems 357  
    password problems 370  
    phone connection problems 367  
    recharging problems 370  
    software installation problems 356  
    tapping and writing problems 359  
    VersaMail problems 369

Frozen handheld 358

Full-screen Writing

    description 23  
    status bar button 17, 24  
    with keyboard 21

## G

Games 347

General preferences 170, 346–348

    alarm LED 347  
    alarm sounds 346  
    alarm vibrate 347  
    Date & Time 314–315  
    Digitizer 316  
    Formats 316–317  
    Graffiti 2 317  
    Power 336–338  
    Sounds & Alerts 346–348  
    system sounds 346

Getting e-mail

    checking for new messages 165

GPRS network

    connecting to 319–329  
    GPRS defined 311  
    loss of network connection 328

- sending an INIT string 327–328
    - service limitations 328
  - Graffiti 2
    - alphabet 24
    - Command stroke 42
    - designated input areas 23
    - Full-screen Writing 23
    - input areas 8, 22
    - menu commands 42
    - online Help 307
    - preferences 317
    - problems using 359
    - ShortCuts for entering data 344–346
    - symbols 27
  - Graphics pick list 253
  - GSM phones
    - accessing the Internet 326
    - and GPRS networks 311
    - connecting with 311–312
    - entering passkey 112, 367
    - requirement for SMS 129
- ## H
- Handheld
    - alarm 171
    - blinking 170
    - buzzing 170
    - increasing space on your handheld 12
    - vibrating 171
  - Hard reset 351, 357
  - Hardware add-ons 11
  - Help
    - online tips 15
  - Hiding records 342
  - History list
    - clearing 251
    - definition 250
    - limit 250
  - Home page
    - changing 253
    - returning to 241
    - status bar button 17
  - HotSync
    - Bluetooth operations 287–289
    - buttons preferences 306
    - conduits for synchronizing
      - applications 273, 352
      - conduits for synchronizing applications,
        - Mac 274
      - customizing 273, 274
      - first-time operation 274–278, 294–296
      - IR operation 278–281
      - linking to external files 34, 293
      - local operation 270, 275, 362, 363
      - local operation on Mac 277
      - modem operation 271, 282–287, 365
      - modem settings 283
      - network operation 290–293
      - operations using cradle 281, 309
      - operations using IR port 278–280, 310
      - performing wireless HotSync
        - operation 289
      - problems with 361–366
      - problems with IR 366
      - restoring data 352–353
      - selecting HotSync operations on your handheld 289
      - setting options 269–271
      - starting Manager 215
      - synchronize active accounts 215
      - synchronizing e-mail 227
      - user profiles 293
  - Hyperlink. *See* Link
- ## I
- Icon
    - Bookmark 249
    - broken envelope 172, 192
    - for e-mail messages 174, 193
    - HotSync Manager 215
    - paperclip 174
    - VersaMail e-mail 174
  - Icons
    - Add/Remove Programs 61
    - alarm 69
    - application 14
    - Back 241
    - Find 48
    - Forward 241
    - Home Page 241
    - HotSync Manager 59
    - lock 31
    - menu 42
    - note 52
    - on handheld buttons 8

- online Tips 15
  - Open URL 239
  - Quick Install 55
  - Refresh 245
  - repeating event 69, 143, 144
  - Stop 242
  - Tips 15
  - USB 3
  - Web 237
- Idle timeout of ISP or server connection 329
- Images
- changing download preferences in Web Pro 253
  - compression 253
  - copying from web pages 246
- IMAP
- adding an account 153
  - ESMTP synchronization in 220
  - server options 156
  - synchronize an account 220
- Importing data 33–35
- Inbox
- Reminders screen and 172
  - synchronizing 222
  - viewing mail 164–165
- Incoming mail server 154
- Indicator light 9, 347
- Infrared
- connections 309
  - HotSync operations 278–280, 310
  - port 10, 29, 278
  - problems with IR HotSync
    - operations 366
  - requirements for computer 278
- INIT string, sending 327–328
- Initialization string 310
- Input area location 8
- Installing
- applications 54–60
  - conduit to install applications 273
- Internet
- access 237, 257
  - entering ISP information 326
  - using non-GSM phones to access 313
- IP address 329, 330
- IR port 10
- See also* Beaming and Infrared
- IR. *See* Infrared
- IrCOMM 29, 278, 309
- IrDA (Infrared Data Association) 29, 278
- ISP
- changing 258
  - entering ISP information 326
  - login script 150
  - requirements for 149
  - requiring APOP 163
  - requiring ESMTP 163
- ## J
- JavaScript, enabling and disabling 255
- Jumping to another web page 241

## K

Keyboard

  - computer 32
  - onscreen 21, 307
  - onscreen types 22
  - portable 35

## L

LED 9, 347

Letters

  - font style 53
  - Graffiti 2 24
  - onscreen keyboard 21

Link

  - colors, changing 252
  - definition 241
  - downloading files 242
  - unvisited links 252
  - visited links 252
  - See also* Connection

Location

  - adding 264–266
  - deleting 266
  - displaying secondary 267
  - modifying 266
  - setting primary 262, 264, 314
  - setting secondary 264

Locking the handheld with a password 307, 335, 340–341

Logging informational errors 216

Login script 150

Login scripts

  - network 331–333



- 
- Looking up Contacts data
    - add to other records 50
    - scrolling in Address list 48
    - to add to other records 50
  - Lost
    - handheld, contact for 85
    - records 359
  - Lotus Notes, selecting as mail client 219
  - Lotus Organizer, importing data from 33
  
  - M**
  - Mail service, default service for e-mail
    - account 161–162
  - Mailbox, adding new 152
  - Mailto links 247
  - Maintenance information 349
  - Marking messages unread/read 211
  - Maximum cache size 257
  - Maximum message size
    - incoming e-mail 157
  - Memory
    - amount of free 373
    - for beaming 367
    - limitations on History list 241
    - regaining 44, 358
  - Memos
    - adding Contacts data to records 50
    - archive files (.mpa) 33
    - categorizing records 45
    - conduit for synchronizing 273
    - creating records 43
    - deleting records 44, 69
    - fonts 52
    - menus 104
    - opening 103
    - private records 344
    - reviewing memos 104
    - sorting records 51, 360
  - Menus 41–42, 138, 359
    - Calendar 77, 267
    - command equivalents (Graffiti 2 writing) 42
    - command toolbar 42
    - Edit menu 44
    - Expense 102
    - Memos 104, 108
    - menu bar 14, 41
    - Note Pad 108
    - Palm Photos 128
    - SMS 138
    - status bar button 17
    - Voice Memo 234
    - World Clock 267
  - Microsoft Exchange 5.0 218
  - Microsoft Outlook
    - connecting to 361
    - synchronizing with 218
  - Microsoft Outlook Express
    - selecting as mail client 218
  - MMC expansion card 9
  - Mobile phone. *See* Phone
  - Modem
    - HotSync operations via 282–287, 365
    - initialization string 310
  - Modem sled, prerequisite for
    - connection 150
  - Modifying
    - home page 253
    - image download preferences 251
  - Monday, to start week 317
  - Month (Calendar view) 73
  - MPA (Memos archive file) 33
  - Multiple addressees 188
  
  - N**
  - Navigator 8, 15, 130
    - deleting bookmarks 250
  - Netscape 217
  - Network
    - connecting 325
    - entering ISP information 326
    - HotSync operation 290–293
    - idle timeout 329
    - login scripts 331–333
    - password 321
    - phone settings 322
    - preferences 319–334
    - primary DNS 330
    - secondary DNS 330
    - selecting connection 322
    - selecting service 320
    - user name 321
  - Network connection 149
    - connection methods 149
-

- modem sled, prerequisite for 150
- PalmModem accessory, prerequisite for 150
- Network preferences
  - in Web Browser Pro 258
  - main handheld preferences 319–334
- Non-GSM phones, connecting 313–314
- Note Pad
  - alarm 107
  - menus 108
  - opening 105
  - reviewing notes 106
- Notes, attaching to records 51–52
- Notifications. *See* Auto get mail
- Numbers
  - decimal point and thousands separator 317
  - onscreen keyboard 21

**O**

- Old messages, deleting 208
- Old web page content, viewing if available 257
- Onscreen keyboard 21
  - pen stroke to open 307
- Opening
  - applications 37
  - bookmarked web pages 248
  - Calendar 63
  - Contacts 83
  - Dialer 93
  - Expense 97
  - handheld 7
  - HotSync Manager 269
  - Memos 103
  - Note Pad 105
  - Palm Photos 119
  - Phone Link 110
  - saved pages 243
  - SMS 129
  - Tasks 139
  - Voice Memo 229
  - Web Browser Pro 237
  - World Clock 261, 262
- Organizer (Lotus PIM) 33
- Outbox 185
  - storing e-mail 190
  - synchronizing 222
- Outgoing server, settings 154

- Outlook, connecting to 361
- Overlapping events 75
- Owner preferences 334–335

## P

- Pages. *See* Web pages
- Palm Photos
  - albums 126
  - beaming photos 126
  - copying photos 125
  - deleting photos 127
  - desktop software 127
  - List view 120
  - menus 128
  - opening 119
  - organizing photos 124–125
  - photo details 123
  - rotating photos 123
  - slide show 122
  - thumbnail view 119
- Palm Quick Install 55–58
- PalmModem accessory, prerequisite for connection 150
- Paperclip icon 174
- Passkeys 112
  - entering to create a trusted pair with a phone 112, 367
- Password 154
  - editing in account 160
- Passwords 338–342
  - changing 339
  - creating 338
  - deleting 339
  - entering in Web Pro 245
  - for network 321
  - forgotten 342, 370
- Payment, Expense item 99
- Pen stroke, full-screen 307
- Peripheral hardware 11
- Personal preferences 298
  - Buttons 306–307
  - Color Theme 308
  - Owner 334
  - Shortcuts 344
- Phone
  - connection problems 368
  - creating a trusted pair 313
  - downloading messages from 131
  - entering ISP information 326

- entering passkey 112, 367
  - Lookup 50
  - numbers, selecting for Address list 88
  - numbers, selecting types 86
  - preferences 335
  - settings for ISP or dial-in server 322–325
  - Phone Link
    - Bluetooth connection 109–117
    - creating connections with 113–115
    - entering passkey 367
    - overview 109–110
  - Phone preferences
    - Dialer 93
    - main handheld preferences 335
    - SMS 129
  - Photos
    - See* Palm Photos
  - Pick lists 15
  - Plug-in applications 333
  - POP accounts, APOP synchronization in 220
  - POP3 accounts 156
    - adding an account 153
  - Ports
    - IR on handheld 29, 278
    - serial 1, 2, 279, 281, 309
    - USB 1, 2, 3, 279, 281, 309
  - Power preferences 336–338
  - PPP 329
  - PRC (application file extension) 333
  - Preferences
    - Advanced 211
    - Bluetooth 298–306
    - Buttons 306–307
    - Color Theme 308
    - Communication 297
    - Connection 308–314, 319
    - cradle setting 337
    - Date & Time 314–315
    - deleting e-mail 213
    - Digitizer 316
    - Formats 316
    - General 297
    - getting mail 213
    - Graffiti 2 317
    - Network 319–334
    - Owner 334
    - Personal 298
    - Phone 335
    - Power 336–338
    - Security 338
    - ShortCuts 344
    - SMS 135–137
    - Sounds & Alerts 346–348
    - Trash 211
  - Primary DNS 330
  - Prioritizing Tasks records 140, 146
  - Private records
    - displaying and creating 342–344
    - lost with forgotten password 342
    - problems displaying 359
  - Problems
    - beaming and sending 367
    - connecting to a phone 367
    - entering data 359
    - installing software 356
    - operating handheld 357
    - performing HotSync operations 361–365
    - recharging handheld 370
    - tapping and writing 359
    - using applications 359–360
    - using Bluetooth 365, 368
    - using passwords 370
    - using VersaMail 369
  - Profile
    - HotSync user profile 293
    - VersaMail 221
  - Purging records 44
  - Push e-mail 172
- ## Q
- Quick Install 55–58
- ## R
- Range of times in Day view 77
  - Read messages, marking 211
  - Reading e-mail 164–175
  - Receipts, recording in Expense 98
  - Receiving data. *See* Beaming information
  - Receiving messages in SMS 131
  - Recharging the battery 337
  - Records
    - beaming 29–31
    - choosing categories 45
    - creating 43
    - deleting 44, 69
    - displaying a category of 46

- editing 43
- Expense 97
- fonts 52
- hiding private 338, 342
- lost 359
- masking private 338
- Memos 103
- notes for 51–52
- number of 373
- private 342–344
- purging 44
- sending 32
- sorting 50–51
- Tasks 139
- unmasking individual 344

Refreshing a web page 245

Reminder lists 53

Reminders screen

- send retry 192
- types of reminders 171
- using 172
- viewing 171

Removing

- applications 60
- bookmarks 250
- Desktop software 61
- saved pages 244

Renaming

- bookmarks 249
- categories 47
- saved pages 244

Replying to e-mail 195

Rescheduling events 71

Resetting handheld

- hard reset 351, 357
- location of reset button 10, 351
- soft reset 350

Restoring data

- Mac 352
- Windows 352

Returning

- to a page in the History list 251
- to a web page 241
- to a web page in the History list 250
- to your home page 241

## S

Saved pages

- deleting 244
- opening 243
- renaming 244
- timestamp 243

Saving

- data 44
- e-mail messages 209

Schedule an event 66

Scheduled retrieval of e-mail. *See* Auto get mail

Scheduling events 69–71

Screen 8

- blank 357
- calibrating 13, 316
- caring for 349
- rotating 17

Scroll bar 14

SD expansion card 9

SDIO expansion card 9

Searching. *See* Finding

Secondary DNS 330

Security preferences 338–342

- changing password 339
- deleting password 339
- forgotten password 342
- private records 342–344
- setting a password hint 338
- unmasking individual records 344

Selecting

- date for event 67
- phone numbers in Contacts 86
- text 44

Send

- e-mail 190

Send retry 191

- modifying messages during 193
- notifications 192
- VPN connections 152

Sending

- data from applications 135
- data using Bluetooth communication 32
- messages in SMS 131
- problems with 367
- requirements for e-mail or SMS communication 32

- 
- Serial
    - cradle/cable 271, 279, 281, 309
    - port 1, 2, 270, 279, 281, 282, 283, 309
    - troubleshooting 361, 362, 363, 366, 370
  - Server
    - deleting messages on 210, 213
  - Service
    - changing in Web Browser Pro 258
    - selecting for network 320
    - templates 320, 333
  - Settings. *See* Preferences
  - ShortCuts
    - backing up 273
    - managing 344–346
    - menu commands 42
    - predefined 29
  - Signature 134, 158
    - attaching personal 193–194, 214
  - SMAPI (Simple MAPI) 217
  - Smart Addressing
    - turning on 190
    - using 189
  - SMS
    - connecting to your mobile phone 129
    - creating messages 130
    - draft messages 133
    - Inbox 132
    - menus 138
    - overview 129
    - preferences 135–137
    - sending and receiving messages 131
    - sending data from another
      - application 135
    - signature 134
    - viewing messages 132–133
  - Soft reset 351
  - Sorting
    - applications 39
    - records 50–51, 360
  - Sound
    - alarm on handheld 171
  - Sounds & Alerts preferences 346–348
  - Sounds. *See* Alarm *and* System sounds
  - Speed, of image downloading 253
  - Starting applications 38
  - Status bar
    - button descriptions 17
    - location 14
  - Stopping a download 242
  - Stylus
    - dragging with 13
    - pen stroke to activate a feature 307
    - tapping with 13
  - Sunday, to start week 317
  - Symbols
    - for currency 99
    - in Graffiti 2 writing 27
  - Synchronize-only
    - connection 149
    - creating account 159
  - Synchronizing
    - an existing username 148
  - Synchronizing e-mail 226–227
    - account information screens 224
    - active accounts 226
    - e-mail applications for 218
    - HotSync operation 216
    - logging errors 216
    - setting how many days 222
    - shortcuts 225
    - SSL and 228
    - synchronizing multiple accounts 227
    - turn off synchronization 226
  - System
    - conduit 273
    - sounds 346
- T**
- Tab delimited files, importing data from 33
  - tap 71
  - Tapping 13
  - Tasks
    - adding Contacts data to records 50
    - archive files (.tda) 33
    - categorizing records 45, 146
    - checking off items 140
    - completed items 146
    - completion date 146
    - conduit for synchronizing 273
    - creating records 43
    - deleting records 44, 69
    - display options 145
    - displaying in Calendar 64
    - due date 141, 146
    - filtering options 144
    - fonts 52
    - notes for records 51–52
-

- opening 139
- prioritizing records 140, 146
- private records 344
- purging records 146
- sort order setting 146
- sorting records 51
- viewing reminders 171
- TCP/IP 319, 334
- TDA (Tasks archive file) 33
- Technical Support 355, 373
- Text
  - entry. *See* Entering data
  - files, importing data from 33, 34
  - fonts for 52
  - size setting in Web Pro 251
- Thousands separator 317
- Time
  - alarm setting 69
  - Daylight Saving settings and options 264–266
  - format 317
  - setting current 263, 315
  - setting event 66
  - start and end for Calendar Day view 77
- Time Zone 265
- Tips, online 15
- Title bar 238
- To field 188
- Today. *See* Current date
- Transmitting data. *See* Beaming, information *and* Sending, data using Bluetooth communication
- Trash
  - automatically emptying 211
  - creating other folders 185
  - emptying deleted e-mail 210–211
  - setting frequency in preferences 211
- Troubleshooting 366
- Trusted devices, adding trusted devices 303–304
- Trusted pairs, creating 313
- Turning off handheld
  - automatically 336
  - pen stroke for 307
  - problems with 358
- Turning on handheld
  - displaying owner's name 335
  - power button 9
  - problems with 357

## U

- Uninstalling Desktop software 61
- Universal connector 11, 309
- Unread mail 156
- Unread messages, marking 211
- Unresponsive handheld 358
- Untimed events 68, 70
- Upgrading
  - a MultiMail database 148
- URL
  - beaming 247
  - changing home page 253
  - e-mailing 247
  - entering in Palm Web Browser Pro 239
  - Entry field 238, 240
  - truncated 245
- URLs
  - in e-mail messages 197
- USB
  - cradle/cable 270, 272, 279, 281, 309
  - port 1, 2, 3, 279, 281, 309
  - troubleshooting 361, 362, 363, 370
- User cache, enabling/disabling 305
- User name
  - for ISP 321
  - identifying handheld 334
- User profiles, HotSync 294–296
- Username 154
  - editing in account 160
  - synchronizing existing 148

## V

- vCal 33, 34
- vCard 33, 34
- Vendor for Expense item 99
- VersaMail
  - application 147
  - icons 174, 193
  - launching from Palm Web Browser Pro 247
  - problems with 369
  - setting preferences for 213
- Vibrate alarm 171, 347
- Video files 55, 58
- Visiting
  - bookmarked web pages 248
  - web pages 239

---

Voice Memo  
alarms 234  
creating voice memos 230–232  
listening to voice memos 232–233  
menus 234  
opening 229  
overview 229  
reviewing voice memos 232  
VPN, access e-mail 151

## W

Web address  
*See* URLs

Web page  
displaying old content 257  
list of visited 250  
refreshing 245  
returning to 241  
viewing information about 245

Week (Calendar view) 72–73, 317, 360

Wireless  
LAN access point locations 326

World Clock  
adding locations 264–266  
alarm 267  
alarm preferences 267  
Daylight Saving settings and  
options 264–266  
display options 267  
menus 267  
opening 261  
Time Zone 265

Writing area  
Graffiti 2 input areas 23  
on handheld 8

Writing. *See* Entering data

