



Dolphin® 9500 Series
Mobile Computer
Windows Mobile™ 2003
Software for Pocket PCs



User's Guide

Disclaimer

Hand Held Products, Inc. ("Hand Held Products") reserves the right to make changes in specifications and other information contained in this document without prior notice, and the reader should in all cases consult Hand Held Products to determine whether any such changes have been made. The information in this publication does not represent a commitment on the part of Hand Held Products.

Hand Held Products shall not be liable for technical or editorial errors or omissions contained herein; nor for incidental or consequential damages resulting from the furnishing, performance, or use of this material.

This document contains proprietary information that is protected by copyright. All rights are reserved. No part of this document may be photocopied, reproduced, or translated into another language without the prior written consent of Hand Held Products.

© 2005 Hand Held Products, Inc. All rights reserved.

Web Address: www.handheld.com

Trademarks

Dolphin, HomeBase, Mobile Base, and QuadCharger are trademarks or registered trademarks of Hand Held Products, Inc.

Windows Mobile, Windows, Windows NT, Windows 2000, Windows ME, Windows XP, ActiveSync, Outlook, and the Windows logo are trademarks or registered trademarks of Microsoft Corporation.

Intel is a registered trademark of Intel Corporation.

Chapter 7 (pages 7-1–7-11) contains copyrighted information from SyChip, Inc.

Chapter 7 (pages 7-12–7-25) contains copyrighted information from Meetinghouse Corporation. Meetinghouse, the Meetinghouse logo, and all other Meetinghouse trademarks/service marks contained herein are trademarks or registered trademarks of Meetinghouse.

Chapter 8 is copyrighted information used by permission from Bluetooth SIG, Inc. The Bluetooth trademarks are owned by Bluetooth SIG, Inc., U.S.A. and licensed to Hand Held Products.

Chapter 9 (9-3–9-15 and 9-17–9-22) contains information with permission from INTRINSYC Software, Inc.

Other product names mentioned in this manual may be trademarks or registered trademarks of their respective companies and are hereby acknowledged.



Table of Contents

Chapter 1 - Introduction

Required Safety Labels	1-2
Dolphin 9500 Series Batch Terminal	1-3
Regulatory and Safety Approvals for all Dolphin 9500 Series Terminals	1-3
Dolphin 9500 Series WLAN or WPAN Radio.....	1-4
Dolphin 9500 WWAN Radio	1-5
FCC Compliance	1-6
Pacemakers, Hearing Aids and Other Electrically Powered Devices	1-8
Microwaves	1-8
Care and Cleaning of Dolphin 9500 Series Terminals.....	1-8

Chapter 2 - Getting Started

Overview	2-1
Dolphin 9500 Series Terminals.....	2-2
Dolphin 9500 Series Models and Options	2-2
Dolphin 9500 Series Peripherals	2-3
Dolphin 9500 Series Accessories.....	2-4
Image Engine Options and Specifications	2-5
Dolphin 9500 and Dolphin 9550 Terminals	2-5
Dolphin 9501 and Dolphin 9551 Terminals	2-5
Bar Code Symbolologies Supported	2-6
Using a Dolphin 9500 Series Terminal for the First Time.....	2-7
Charging with Dolphin Peripherals	2-8
Resetting the Terminal	2-12
Soft Reset (Warm Boot)	2-12
Hard Reset (Cold Boot)	2-12
Suspend Mode.....	2-12

Chapter 3 - Dolphin 9500 Series Hardware Overview

System Features	3-1
Front Panel Features.....	3-2
Back Panel Features	3-4
Dolphin 9500	3-4
Dolphin 9550	3-6
Dolphin 9501 and Dolphin 9551	3-7
Side Panel Features	3-8
Bottom Panel Features	3-9
Mechanical Connector	3-9
Batteries.....	3-10
Main Battery Pack	3-10
Internal Backup Battery.....	3-10
Managing Battery Power	3-11
Default Critical and Low Battery Points	3-11
Checking Battery Power.....	3-12
Storing Batteries	3-12
Guidelines for Battery Use and Disposal	3-12

Dolphin 9500 Series Technical Specifications	3-13
--	------

Chapter 4 - Using Dolphin 9500 Series Mobile Computers

Entering Data	4-1
Today Screen	4-2
Navigation Bar	4-2
Pop-Up Menus	4-3
Selecting Programs	4-3
Using the Image Engine	4-4
Decoding	4-4
Capturing Images	4-6
Using the Keyboards	4-7
Using the Function Keys	4-8
Using the Navigation Keys	4-8
Using the Modifier Keys	4-9
35-Key Numeric/Alpha Keyboard	4-10
43-Key Alpha/Numeric Keyboard	4-11
56-Key Full Alpha/Numeric Keyboard	4-12
Adjusting the Backlight	4-13
Color Display	4-13
Monochrome Display	4-13
Communication Media Options	4-15
Radio Options	4-16
Available Radio Combinations	4-16
Radio Driver Installation	4-16
The Radio Manager	4-16
Powering Up a Radio	4-17
Using the Soft Input Panel (SIP)	4-18
Input Panel Options	4-19
Writing on the Screen	4-20
Drawing on the Screen	4-20
Status Icons	4-22
Notifications	4-22
Finding and Organizing Information	4-23

Chapter 5 - Settings

Overview	5-1
Personal Tab	5-2
Modifying the Start Menu	5-3
Headset Control	5-5

System Tab	5-6
About	5-6
Backlight	5-6
ClearType Tuner	5-7
Clock	5-7
CPU Speed	5-7
Memory	5-8
Power	5-10
Regional Settings	5-12
Remove Programs	5-13
Screen	5-14
uPhone Settings	5-14
Connections Tab	5-15
Server-Assigned IP Addresses	5-15
Zero-Config Wi-Fi	5-15
Creating a Wireless Network Connection.....	5-15
Accessing the Connections Manager	5-16
Creating an External Modem Connection to an ISP	5-16
Creating an External Modem Connection to Your Work	5-19
Establishing Dialing Rules.....	5-24
Configuring Network Cards.....	5-26

Chapter 6 - Communications

Overview	6-1
Connecting	6-1
Installing Additional Software	6-1
Using ActiveSync	6-2
Additional Capabilities	6-2
Requirements	6-2
Setting Up Your Desktop Computer	6-2
Synchronizing from Your Desktop Computer	6-2
Synchronizing from the Terminal	6-3
Exploring Your Terminal from the Desktop Computer.....	6-3
Adding Programs to the Terminal Using ActiveSync	6-4
Using Infrared.....	6-5
Verify That the IrDA Port is Enabled	6-5
IrDA Port Location on the Terminal.....	6-5
Verify That Beam Settings Are Set to Receive.....	6-6
Sending Information	6-6
Receiving Information	6-6
Troubleshooting	6-7
Using an ISP	6-8
Adding Programs Directly from the Internet	6-8

Chapter 7 - Wireless LAN Communications with 802.11b

Overview	7-1
Powering Up the 802.11b Radio Driver.....	7-1
Configuration Utilities	7-1

802.11b Settings	7-2
Status Tab.....	7-3
Config Tab	7-5
Advanced Tab	7-9
About Tab	7-10
The Status Icon	7-11
802.11b Wireless Security Supplement.....	7-12
Required Network Configuration Information Worksheets.....	7-13
Opening the Client	7-17
The Main Screen	7-18
Configuring the Client	7-21
Logging	7-33
Installing Certificates with CertAdd	7-34
Advice and Workarounds.....	7-35

Chapter 8 - Wireless PAN Communications with Bluetooth

Overview	8-1
Powering Up the Bluetooth Radio Driver.....	8-1
Setting Up Your Bluetooth Card.....	8-1
Assign COM Ports.....	8-2
Discover Bluetooth Device(s)	8-2
Bond With Discovered Device(s)	8-3
View Device Properties	8-5
Set Up Your Favorite Device.....	8-6
Change Views	8-6
Delete a Device From the Folder	8-7
Turn Radio Transmitter ON/OFF	8-7
Bluetooth ActiveSync.....	8-8
Bluetooth LAN Access.....	8-10
OBEX	8-13
Exchange Business Cards	8-13
Send a Contact	8-14
Send a File.....	8-15
Browse Remote Device.....	8-17
Receive Contact or File.....	8-21
Enable File Sharing.....	8-21
Using the Dialer.....	8-22
Get Connected Wizard.....	8-23
Dial Up to Your Network	8-26

Chapter 9 - Wireless WAN Communications with GSM/GPRS

Overview	9-1
Powering Up the GSM/GPRS Radio Driver.....	9-1
Tri-Band Antenna	9-1
SIM Card Installation	9-2
Using uPhone.....	9-3

Using the Dialler.....	9-6
Making a Call.....	9-6
Receiving a Call.....	9-7
Ending a Call.....	9-8
Keyboard Combinations for Calls.....	9-8
Call Waiting.....	9-8
Making Conference Calls.....	9-9
Touchtones.....	9-9
Volume Control.....	9-9
Phonebook.....	9-10
Tools Menu.....	9-10
Settings Menu.....	9-11
Audio Modes.....	9-12
Handset.....	9-12
Headset.....	9-12
Hands-Free.....	9-12
Ringtone Configuration.....	9-12
Call Log.....	9-14
SMS Manager.....	9-16
Opening the SMS Manager.....	9-16
Sending an SMS Message.....	9-17
Icons at the Top of the Screen.....	9-18
Online Help.....	9-19
uPhone Configuration.....	9-20
Accessing.....	9-20
Requirements.....	9-20
General Tab.....	9-21
Network Tab.....	9-22
Divert Tab.....	9-22
Bar Tab.....	9-23
GPRS Settings.....	9-24
Requirements.....	9-24
To Select Pre-Configured GPRS Settings.....	9-24
To Add a GPRS Setting.....	9-25
GPRS Connection.....	9-25

Chapter 10 - Applications

Calendar.....	10-1
Contacts.....	10-3
Tasks.....	10-5
Notes.....	10-7
Inbox.....	10-7
Pocket Internet Explorer.....	10-10
Pocket Word.....	10-13
Pocket Excel.....	10-15
Windows Media Player for Pocket PC.....	10-17
MSN Messenger.....	10-18
Pictures.....	10-19

Chapter 11 - Dolphin 9501 and Dolphin 9551

Overview	11-1
Laser Engine Options and Specifications	11-1
Radio Options	11-2
Keyboard Options	11-2
Peripherals and Accessories	11-2
Front Panel Features	11-2
Dolphin 9551	11-3
Side Panel.....	11-3
Back Panel.....	11-4
Dolphin 9501	11-5
Side Panel.....	11-5
Back Panel.....	11-6
Hand Strap and Stylus.....	11-7
Bottom Panel Features.....	11-7

Chapter 12 - Dolphin 9500 Series HomeBase

Overview	12-1
Dolphin 9500 Series HomeBase Parts and Functions	12-2
Front Panel	12-2
Rear Panel	12-3
Powering the HomeBase	12-4
HomeBase Serial Connector.....	12-4
Charging the Main Battery	12-5
To Power a Terminal and Charge its Main Battery	12-5
Charging a Spare Battery in the Auxiliary Battery Well	12-5
Communications	12-6
Setting up the HomeBase for USB Communication.....	12-6
Communicating with the Dolphin 9500 Series Terminal.....	12-8
Setting up the HomeBase for RS-232 Communications.....	12-8
Mounting the HomeBase	12-11
Desk Mounting.....	12-11
Wall Mounting	12-12

Chapter 13 - Dolphin 9500 Series Mobile Base

Overview	13-1
Mobile Base Parts and Functions	13-2
Front Panel	13-2
Bottom Panel.....	13-3
Powering the Dolphin Terminal	13-4
Charging the Dolphin Terminal.....	13-4
Installing the Dolphin Mobile Base.....	13-5
Mounting the Mobile Base.....	13-5
Powering the Dolphin Mobile Base	13-6
Setting the Mobile Base Up for Communications.....	13-7
Connecting the Cables	13-7
Mobile Base Serial Connector	13-8
Configuring the Terminal for ActiveSync Communications.....	13-8

Chapter 14 - Dolphin 9500 Series ChargeBase

Overview	14-1
Dolphin ChargeBase Parts and Functions	14-1
Front Panel	14-1
Back Panel.....	14-2
Power Supply	14-2
Supplying Power to the ChargeBase	14-3
Inserting and Removing Terminals	14-3
Charging Terminals in the ChargeBase.....	14-4
Mounting the ChargeBase	14-4
Bottom Panel.....	14-4
Using the DIN Rail	14-5
Using the Wall Mount Kit.....	14-6

Chapter 15 - Dolphin 9500 Series QuadCharger

Overview	15-1
Dolphin QuadCharger Parts and Functions	15-2
Top Panel	15-2
Back Panel.....	15-3
Supplying Power to the QuadCharger	15-3
Inserting and Removing Battery Packs	15-4
Charging Batteries in the QuadCharger.....	15-4
Using the Battery Analyzer	15-5
Mounting the QuadCharger	15-6
Troubleshooting	15-8

Chapter 16 - Customer Support

Product Service and Repair	16-1
Online Product Service and Repair Assistance.....	16-1
Technical Assistance	16-2
Limited Warranty	16-3

Appendix A - Keyboard Combinations

General Windows Keyboard Shortcuts	A-1
43-Key Alpha/Numeric Keyboard	A-2
Blue Key Combinations	A-2
Red Key Combinations	A-3
Num Lock Key Combinations	A-3
35-Key Numeric/Alpha Keyboard.....	A-4
Blue Key Combinations	A-4
Alpha Mode Key Combinations	A-5
56-Key Full Alpha/Numeric.....	A-6
Blue Key Combinations	A-6
Red Key Combinations	A-7
SFT Key Combinations	A-8
Com Port Assignment Table	A-8



Congratulations on the purchase of your Dolphin 9500 Series mobile computer! You have made a wise choice in selecting the Dolphin, a device known worldwide for its ergonomic form factor, light-weight, rugged design and single-handed data collection capabilities.

The Dolphin 9500 Series consists of the following terminals:

Dolphin 9500	For details, see Dolphin 9500 on page 3-4.
Dolphin 9550	For details, see Dolphin 9550 on page 3-6.
Dolphin 9501	For details, see Dolphin 9501 on page 11-5.
Dolphin 9551	For details, see Dolphin 9551 on page 11-3.

Ergonomics

The patented shape of the Dolphin 9500 fits into either hand comfortably with major function keys that are easy to access. The adjustable hand strap on the back panel ensures a secure grip enabling true, one-handed operation. The integrated pistol-grip handle on the Dolphin 9550 provides intuitive point-and-shoot scanning over extended periods of use.

Rugged Design

Dolphin 9500 Series terminals are the most durable mobile computers on the market. Their rugged design can withstand repeated five-foot drops onto a concrete floor, extreme temperatures, and high humidity, moisture, and dust conditions. The terminals are independently tested to meet IP64 specifications.

Mobile Computing Features

- Low-power, high-resolution digital image engine for omni-directional and auto-discrimination decoding of most bar code symbologies; see [Bar Code Symbologies Supported](#) on page 2-6.
- Co-located and integrated 802.11b, GSM/GPRS, and Bluetooth™ wireless radios for real-time data collection applications
- Intel® X-Scale 400MHz RISC microprocessor for fast processing
- Microsoft Windows Mobile 2003 Software for Pocket PC platform - easily programmable with standard programming tools
- 64 MB RAM and 32 MB Flash memory configuration for ample and secure data storage
- Secure Digital (SD) memory interface enables additional memory installation

Additional Features

- Long-lasting Lithium Ion (Li-ion) batteries
- Large, easy-to-read 1/4 VGA (240 x 320) color or monochrome backlit touch screen that can display text or graphics
- Three keyboard options: 43-key alpha/numeric, 35-key numeric/alpha, and 56-key full alpha/numeric
- Industrial-grade connector that supports serial and USB communications, as well as power in and out
- Full suite of compatible peripheral devices
- Decoding of stacked linear and matrix codes with Optical Character Recognition (OCR) functionality
- Digital picture capability
- Audio jack for headset use
- IrDA port for fast infrared communications
- Speaker and microphone for advanced audio functionality

Application Development Tools

- Dolphin SDK Add-on for Pocket PC 2003 - supports Embedded Visual C++ 4.0
- Dolphin .NET SDK for Pocket PC 2002 and 2003 - supports Visual Studio.NET 2003 (VB.NET and C#.NET)
- Dolphin GSM/GPRS SDK Add-on for Pocket PC 2003 - supports Embedded Visual C++ 4.0 and Visual Studio.NET 2003

This User's Guide

The Dolphin 9500 Series Mobile Computer User's Guide provides you with the information you need to make the most of your Dolphin terminal.

Required Safety Labels

Dolphin 9500 Series mobile computer meets or exceeds the requirements of all applicable standards organizations for safe operation. However, as with any electrical equipment, the best way to ensure safe operation is to operate them according to the agency guidelines that follow. Please read these guidelines carefully before using your Dolphin mobile computer.

Location

Safety labels appear on the back panel of both terminals. On Dolphin 9500 terminals, the required information is contained in the label. On Dolphin 9550 and Dolphin 9551 terminals, safety information is embedded in the plastic.

Dolphin 9500

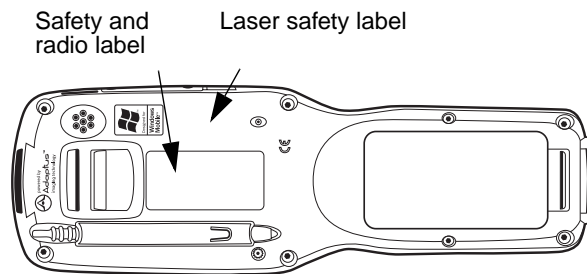

Dolphin 9550

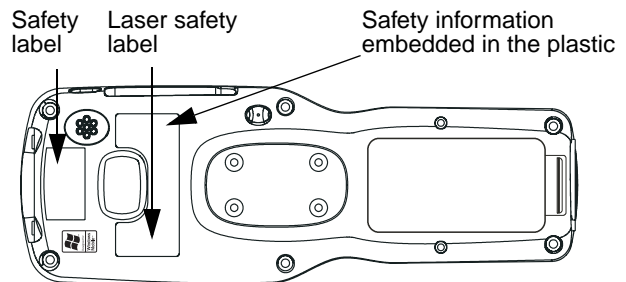

Dolphin 9501

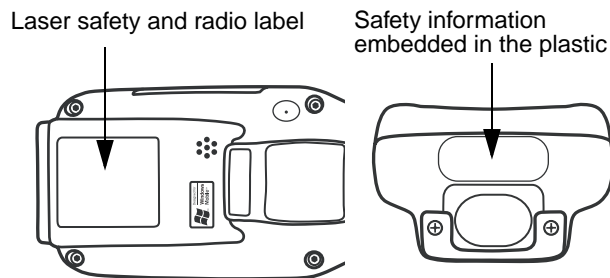

Dolphin 9551

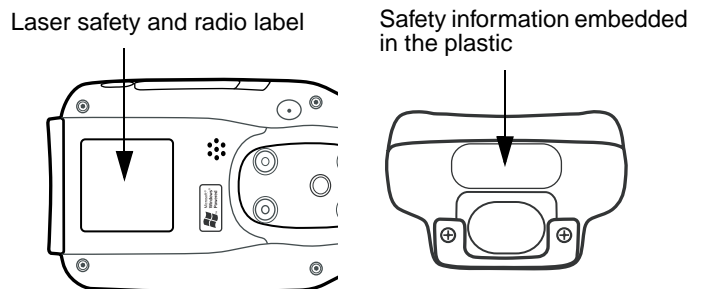

Embedded Safety Information Text

The Dolphin 9501, Dolphin 9550, and Dolphin 9551 have safety information embedded in the plastic. Regardless of the location on the terminal, this information is as follows:

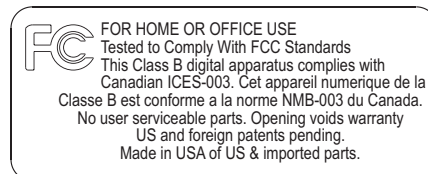

Laser Safety Label Text

Dolphin 9501 and the Dolphin 9551:

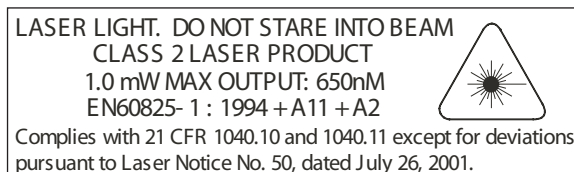

Dolphin 9500 and Dolphin 9550 with IT4300SF/SR Imager

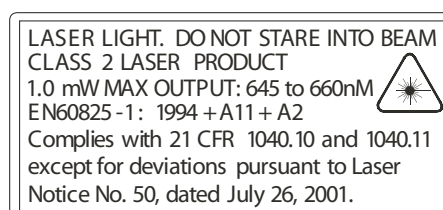

Dolphin 9500 Series Batch Terminal

The following are the required safety labels for batch terminals that appear on the back panel:

Dolphin 9500



Dolphin 9550



Dolphin 9501



Dolphin 9551



Regulatory and Safety Approvals for all Dolphin 9500 Series Terminals

Parameter	Specification
U.S.A	FCC Part 15, Class B
Canada	ICES-003
European Community	EN 55022 (CISPR 22) Class B EN60950 EN60825-1 EN55024:1998

 The CE Mark on the product indicates that the system has been tested to and conforms with the provisions noted within the 89/336/EEC Electromagnetic Compatibility Directive and the 73/23/EEC Low Voltage Directive.

For further information, please contact:

Hand Held Products, Inc.
Nijverheidsweg 9
5627 BT Eindhoven
The Netherlands

Hand Held Products shall not be liable for use of our product with equipment (i.e., power supplies, personal computers, etc.) that is not CE marked and does not comply with the Low Voltage Directive.

Dolphin 9500 Series WLAN or WPAN Radio

Dolphin 9500 Series RF terminals are designed to comply with the most current applicable standards on safe levels of RF energy developed by the Institute of Electrical and Electronics Engineers (IEEE) and the American National Standards Institute (ANSI) and has been recommended for adoption by the Federal Communications Commission (FCC).

802.11b

The following is the required safety label that appears on the back panel of Dolphin RF terminals equipped with an 802.11b radio:



Bluetooth

The following is the required safety label that appears on the back panel of Dolphin RF terminals equipped with a Bluetooth radio:



802.11b and Bluetooth

The following is the required safety label that appears on the back panel of the RF terminals equipped with an 802.11b and a Bluetooth radio combination:



Dolphin 9500 WWAN Radio

Dolphin 9500 Series RF terminals are designed to comply with the most current applicable standards on safe levels of RF energy developed by the Institute of Electrical and Electronics Engineers (IEEE) and the American National Standards Institute (ANSI) and has been recommended for adoption by the Federal Communications Commission (FCC).

Note: The Dolphin 9500 model is the only terminal in the Dolphin 9500 Series that can be equipped with a GSM/GPRS radio for WWAN functionality.

GSM

The following is the required safety label that appears on the back panel of a Dolphin 9500 terminal equipped with a GSM radio:



GSM and 802.11b

The following is the required safety label that appears on the back panel of a Dolphin 9500 terminal equipped with a GSM and 802.11b radio combination:



GSM and Bluetooth

The following is the required safety label that appears on the back panel of a Dolphin 9500 terminal equipped with a GSM and Bluetooth radio combination:



GSM, Bluetooth, and 802.11b

The following is the required safety label that appears on the back panel of a Dolphin 9500 terminal equipped with a GSM, Bluetooth, and 802.11b radio combination:



FCC Compliance

Dolphin mobile computers meet or exceed all applicable standards and have been manufactured to the highest level of quality.

Dolphin 9500 Series Batch Terminal

Dolphin 9500 Series Batch terminals comply with part 15 of the FCC rules. Operation is subject to the following two conditions: (1) this device may not cause harmful interference, and (2) this device must accept any interference received, including interference that may cause undesired operation.

Dolphin 9500 Series RF Terminal with 802.11b, Bluetooth, and/or GSM Radios

This device complies with Part 15 of the FCC Rules. Operation is subject to the following two conditions: (1) this device may not cause harmful interference, and (2) this device must accept any interference received, including interference that may cause undesired operation.

This equipment has been tested and found to comply with the limits for a Class B digital device pursuant to Part 15 of the FCC Rules. These limits are designed to provide reasonable protection against harmful interference in a residential installation. This equipment generates, uses, and can radiate radio frequency energy and, if not installed and used in accordance with the instructions, may cause harmful interference to radio communications. If this equipment does cause harmful interference to radio or television reception, which can be determined by turning the equipment off and on, the user is encouraged to try to correct the interference by one or more of the following measures:

- Reorient or relocate the receiving antenna.
- Increase the separation between the equipment and receiver.
- Connect the equipment into an outlet on a circuit different from that to which the receiver is connected.
- Consult the dealer or an experienced radio/TV technician for help.

If necessary, the user should consult the dealer or an experienced radio/television technician for additional suggestions. The user may find the following booklet helpful: "Something About Interference." This is available at FCC local regional offices. Our company is not responsible for any radio or television interference caused by unauthorized modifications of this equipment or the substitution or attachment of connecting cables and equipment other than those specified by our company. The correction is the responsibility of the user. Use only shielded data cables with this system.

In accordance with FCC 15.21, changes or modifications not expressly approved by the party responsible for compliance could void the user's authority to operate the equipment.

Note: Dolphin 9550, Dolphin 9501, and Dolphin 9551 terminals do not support GSM radios.



This device and its antenna must not be co-located or operating in conjunction with any other antenna or transmitter. To maintain compliance with FCC RF exposure guidelines for body-worn operation, do not use accessories that contain metallic components other than specified by the manufacturer.

Canadian Compliance

This Class B digital apparatus complies with Canadian ICES-003. Operation is subject to the following two conditions: (1) this device may not cause harmful interference, and (2) this device must accept any interference received, including interference that may cause undesired operation.

To prevent radio interference to the licensed service, this device is intended to be operated indoors and away from windows to provide maximum shielding. Equipment (or its transmit antenna) that is installed outdoors is subject to licensing.

Cet appareil numérique de la Classe B est conforme à la norme NMB-003 du Canada.

RF, Regulatory, and Safety Agency Approvals for 802.11b and Bluetooth

Parameter	Specification
RF Approvals U.S.A Canada	FCC Part 15.247 RSS 210

RF, Regulatory, and Safety Agency Approvals for GSM

Parameter	Specification
RF Approvals U.S.A Canada	FCC Part 24 RSS 133

Dolphin 9500 Series 802.11b and/or Bluetooth R&TTE Compliance Statement

Dolphin 9500 Series RF terminals are in conformity with all essential requirements of the R&TTE Directive (1999/5/EC). This equipment has been assessed to the following standards:

Parameter	Specification
R&TTE	EN 300 328-2:2000 EN 301 489-1 (2002-08) EN 301 489-17 (2002-08) EN 60950:2000 EN 50361:2001

This product is marked with **CE 0681** in accordance with the Class II product requirements specified in the R&TTE Directive, 1999/5/EC.

The equipment is intended for use throughout the European Community. Its authorization for use in France is restricted as follows:

PAN European Frequency Range: 2.402 - 2.480 GHz

Restrictions in France are as follows:

- Indoor use - Maximum power (EIRP*) of 100 mW for the entire 2400-2483.5 MHz

- Outdoor use - Maximum power (EIRP*) of 100 mW for the 2400-2454 MHz band and maximum power (EIRP*) of 10 mW for the 2454-2483 MHz band.

Dolphin 9500 Terminal GSM R&TTE Compliance Statement

Note: Dolphin 9550, Dolphin 9501, and Dolphin 9551 terminals do not support GSM radios.

The Hand Held Products Dolphin 9500RF terminals are in conformity with all essential requirements of the R&TTE Directive (1999/5/EC). This equipment has been assessed to the following standards:

Parameter	Specification
R&TTE	EN 301 511:2000 EN 301 489-1 (2002-08) EN 301 489-7 (2002-08) EN 60950:2000 EN 50361:2001

Pacemakers, Hearing Aids and Other Electrically Powered Devices

Most manufacturers of medical devices adhere to the IEC 601-1-2 standard. This standard requires devices to operate properly in an EM Field with a strength of 3V/m over a frequency range of 26 to 1000MHz.

The maximum allowable field strength emitted by the Dolphin is 0.3V/m according to Subpart B of Part 1 of the FCC rules. Therefore, the Dolphin RF has no effect on medical devices that meet the IEC specification.

Microwaves

The radio in the Dolphin RF terminal operates on the same frequency band as a microwave oven. Therefore, if you use a microwave within range of the Dolphin RF terminal you may notice performance degradation in your wireless network. However, both your microwave and your wireless network will continue to function.

The Dolphin Batch terminal does not contain a radio, and therefore, is not affected by microwave ovens.

Care and Cleaning of Dolphin 9500 Series Terminals

When needed, clean the image engine window and the LCD display with a clean, non-abrasive, lint-free cloth. The terminal can be cleaned with a damp cloth.

Overview

Dolphin 9500 Series terminals are Windows Mobile-based with a unique, ergonomic shape designed for single-handed use and 64 MB RAM and 32 MB non-volatile Flash memory. To install additional memory, you can use the Secure Digital (SD) memory interface.

The industrial, mechanical connector supports serial RS-232 up to 115 Kbps and USB communications up to 12 Mbps. The IrDA port enables you to exchange data with IrDA compliant devices, such as portable printers. For additional functionality, an integrated digital imager is available for imaging and decoding.

Operating System

The Dolphin 9500 Series is designed for easy, single-handed mobile data collection. Each mobile computer is equipped with an Intel PXA255 400MHz RISC processor for fast processing that is built for Windows Mobile-based Pocket PCs. The Dolphin 9500 Series is available with different types of 2D imagers and wireless radios to meet most any enterprise mobile data collection requirement.

Data Input Options

There are three keyboard options and a 240 x 320 pixel, backlit 1/4 VGA display available in color or monochrome.

Image Options

The Dolphin 9500 Series contains an integrated imager that can take digital images of damaged packages and recipient signatures, for example, in addition to decoding standard linear and two-dimensional symbologies.

Adapting the Dolphin to Your Environment

Dolphin 9500 Series terminals comprise one element of an enterprise data collection system that includes various models, peripherals, and accessories that you can combine to suit your exact needs.

Dolphin 9500 Series Terminals

There are four terminals in the Dolphin 9500 Series:

- Dolphin 9500** The Dolphin 9500 terminal offers an ergonomic form factor and is the only terminal of the series that can be configured with a GSM radio. For details, see [Dolphin 9500](#) on page 3-4.
- Dolphin 9550** The Dolphin 9550 terminal provides an integrated pistol grip handle for high-volume scanning applications. For details, see [Dolphin 9550](#) on page 3-6.
- Dolphin 9501** The Dolphin 9501 terminal offers the same flashlight form factor as the Dolphin 9500 with the added functionality of a laser scanner. For details, see [Dolphin 9501](#) on page 11-5.
- Dolphin 9551** The Dolphin 9551 terminal offers the same convenience of the integrated pistol-grip handle with the added functionality of a laser scanner. For details, see [Dolphin 9551](#) on page 11-3.

All models can be configured with the available options, except for GSM. Only the Dolphin 9500 terminal can be equipped with a GSM radio.

Dolphin 9500 Series Models and Options

Dolphin 9500 Series Batch

These terminals are optimal for fast, effective batch processing.

Dolphin 9500 Series WLAN (802.11b)

These terminals integrate the functionality of the Batch terminals with an integrated, IEEE 802.11b direct sequence radio that enable communication with a host computer through a wireless local area network (WLAN).

Dolphin 9500 Series WPAN (Bluetooth)

These terminals allow Bluetooth communications to Bluetooth enabled devices such as printers, mobile phones, access points, Bluetooth-enabled PCs, etc.

Dolphin 9500 Series WWAN (GSM/GPRS)

These terminals feature all the benefits of the Dolphin 9500 Series with the additional capabilities of GSM/GPRS technology.

Note: The Dolphin 9500 is the **only** one of the Dolphin 9500 Series that supports GSM/GPRS.

Dolphin 9500 Series WLAN and WPAN (802.11b and Bluetooth)

These terminals feature co-located 802.11b and Bluetooth radios, which means that your terminal contains the capabilities of both radios. You can operate the radios simultaneously or switch between them.

Dolphin 9500 Series WWAN and WLAN (GSM/GPRS and 802.11b)

These terminals feature the functionality of both GSM/GPRS and 802.11b radio and network technologies.

Dolphin 9500 Series WWAN and WPAN (GSM/GPRS and Bluetooth)

These terminals features the functionality of both GSM/GPRS and Bluetooth radio and network technologies.

Dolphin 9500 Series WWAN, WLAN, and WPAN (GSM/GPRS, 802.11b, and Bluetooth)

These terminals feature the functionality of GSM/GPRS, 802.11b, and Bluetooth radio and network technologies.

Dolphin 9500 Series Peripherals

Each of the following items is sold separately to enhance your Dolphin 9500 Series terminal's capabilities.

Dolphin HomeBase™

The Dolphin HomeBase charging and communication cradle supports both RS-232 and USB communications, which enable it to interface with the majority of PC-based enterprise systems. When a terminal is seated in the HomeBase, its main battery pack charges in less than four hours. In addition, the HomeBase contains an auxiliary battery well that charges a spare Li-ion battery.

For more information, see [Dolphin 9500 Series HomeBase](#) on page 12-1.

Dolphin Mobile Base™

The Dolphin Mobile Base charging and communication cradle is designed specifically for in-premise and in-transit data collection applications. It features a flexible mounting bracket, a cigarette lighter adapter or power cable to adapt it to your environment.

When a terminal is seated in the Mobile Base, its main battery pack charges in less than four hours. The serial connector supports RS-232 communication and power out to peripheral devices, such as hand held scanners.

For more information, see [Dolphin 9500 Series Mobile Base](#) on page 13-1.

Dolphin ChargeBase

The Dolphin ChargeBase is a four-slot charging cradle that holds, powers, and charges a terminal in each slot.

For more information, see [Dolphin 9500 Series ChargeBase](#) on page 14-1.

Dolphin Net Base

The Dolphin Net Base is a four-slot charging/communication cradle that holds, powers, charges, and communicates with the terminal in each slot. Ethernet communication occurs via statically and dynamically-assigned IP addresses.

For more information about the Dolphin Net Base, please consult the Dolphin 9500 Series Net Base Quick Start Guide.

Dolphin QuadCharger™

The Dolphin QuadCharger is a four-slot charging station for Dolphin Li-ion battery packs. It can charge each battery in less than four hours. The fourth slot features a battery analyzer that completely resets and re-calibrates a battery and displays its resulting capacity.

For more information, see [Dolphin 9500 Series QuadCharger](#) on page 15-1.

Dolphin 9500 Series Accessories

Each of the following items is sold separately to enhance your Dolphin 9500 Series terminal's capabilities.

Dolphin Mobile Charger

The Dolphin Mobile Charger is a charging cable that connects the terminal directly to a 12 Volt DC power source, such as a cigarette lighter port inside a vehicle, eliminating the need for a cradle. The cable powers the terminal and charges its main battery in less than four hours. Intelligent battery technology on-board the terminal ensures proper charging. The Dolphin Mobile Charger is an ideal low-cost charging solution for in-transit mobile applications.

Dolphin Mobile Mount

The Dolphin Mobile Mount, which holds a Dolphin 9500 terminal securely in place inside a vehicle, is an ideal, low-cost alternative to the Dolphin Mobile Base when communications are not required. When used in conjunction with the Dolphin Mobile Charger, the Dolphin Mobile Mount creates a complete mounting and charging solution for in-transit applications. The entire kit includes the Dolphin Mobile Mount and adjustable vehicle mounting bracket.

Charging/Communication Cables

Dolphin charging/communication cable kits are an all-in-one solution for mobile applications. Each cable kit powers the terminal, charges its main battery, and communicates with host or peripheral devices without the need for a cradle. Cable kits can support RS-232 or USB communications and are available with U.K. or European power cords.

Protective Holster

Holsters provide convenient storage for terminals and protect them from damage in mobile environments. Both holsters feature a front pocket that holds an extra battery, a side pocket to hold an extra stylus, and a belt loop to secure the holster to a belt.

Protective Enclosure

Protective enclosures help seal and protect terminals from damage while providing full access to all terminal parts and features. Dolphin 9500 Series enclosures feature a swivel clip on the back that enables you to secure the enclosure to a belt. Enclosures also come with an adjustable shoulder strap for added convenience.

Stylus Kits

There are two Dolphin 9500 stylus kits: one contains three styli and the other includes additional coiled tethers to secure the stylus to the terminal, which helps prevent loss. The Dolphin 9550 kit contains loops you can attach to the end of each stylus for easy access to the stylus stored in the pistol grip of the Dolphin 9550.

Li-ion Battery Pack

The 7.4v, 14.8 watt hour Li-ion rechargeable battery pack provides the main power supply for Dolphin 9500 Series terminals.

Image Engine Options and Specifications

Dolphin 9500 and Dolphin 9550 Terminals

Dolphin 9500 and Dolphin 9550 terminals can be equipped with one of the following image engines:

IMAGETEAM™ 4100 Standard Range (IT4100SR) IMAGETEAM™ 4300 Standard Range (IT4300SR)

Code	8 mil Linear	10 mil PDF417	13 mil UPC	15 mil PDF417	15 mil Data Matrix	35 mil MaxiCode
Working Range	(.020cm)	(.025cm)	(.033cm)	(.038cm)	(.038cm)	(.089cm)
Near	3.4 in. (8.6cm)	3 in. (7.6cm)	2.4 in. (6.1cm)	3.4 in. (8.6cm)	3.6 in. (9.1cm)	1.9 in. (4.8cm)
Far	7.5 in. (19cm)	8.9 in. (22.6cm)	12.4 in. (31.5cm)	11.1 in. (28.2cm)	6.4 in. (16.2cm)	12.9 in. (32.7cm)

IMAGETEAM™ 4100 Smart Focus (IT4100SF) IMAGETEAM™ 4300 Smart Focus (IT4300SF)

Code	6.6 mil PDF417	7.5 mil Linear	10 mil Linear	13 mil UPC	10 mil PDF417	15 mil Data Matrix
Working Range	(.017cm)	(.019cm)	(.025cm)	(.033cm)	(.025cm)	(.038cm)
Near	2.7 in. (6.8cm)	2.4 in. (6.1cm)	2.1 in. (5.3cm)	2.2 in. (5.6cm)	2.1 in. (5.3cm)	2.2 in. (5.6cm)
Far	5.9 in. (14.9cm)	6.4 in. (16.2cm)	7.5 in. (19cm)	8.8 in. (22.3cm)	7.5 in. (19cm)	5.9 in. (14.9cm)

Note: The IT4300SR image engine contains a high-visibility aimer that projects aiming brackets around the bar code or image preview for maximum viewability and aiming. For details, see [IT4300SF and IT4300SR with High-Vis Aiming Pattern](#) on page 4-5 and page 4-6.

IMAGETEAM™ 4100 High Density (IT4100HD)

Code	4 mil Linear	5 mil Linear	6.6 mil PDF417	9 mil Data Matrix	10 mil Data Matrix	10 mil QR
Working Range	(.010cm)	(.013cm)	(.017cm)	(.023cm)	(.025cm)	(.025cm)
Near	2.5 in. (6.4cm)	2.3 in. (5.8cm)	2 in. (5.1cm)	2.7 in. (6.8cm)	2.4 in. (6.1cm)	2.3 in. (5.8cm)
Far	3.5 in. (8.8cm)	4.2 in. (10.6cm)	4.9 in. (12.4cm)	3.7 in. (9.4cm)	4 in. (10.1cm)	3.4 in. (8.6cm)

For more information, see [Using the Image Engine](#) on page 4-4.

Dolphin 9501 and Dolphin 9551 Terminals

Dolphin 9501 and Dolphin 9551 terminals can be equipped with one of three laser engines. For details, see [Laser Engine Options and Specifications](#) on page 11-1.

Bar Code Symbologies Supported

Symbology type	Symbologies supported
1D Symbologies	Codabar Code 3 of 9 Code 11 Code 32 Pharmaceutical (PARAF) Code 93 Code 128 EAN with Add-On and EAN with Extended Coupon Code EAN-13 Interleaved 2 of 5 Matrix 2 of 5 Plessey PosiCode RSS Straight 2 of 5 IATA Straight 2 of 5 Industrial Telepen Trioptic Code UCC/EAN-128 UPC and UPC-A
2D Symbologies	Aztec Code 16K Composite Data Matrix MaxiCode OCR PDF417 QR Code RSS
Composite Codes	Aztec Mesa Codablock F EAN-UCC RSS-14
OCR Codes	OCR-A and OCR-B
Postal Codes	Postnet and most international 4 state codes Australian Post British Post Canadian Post China Post Japanese Post KIX (Netherlands) Post Korea Post Planet Code

Using a Dolphin 9500 Series Terminal for the First Time

1. Unpack the Carton and Verify its Contents
2. Install the Main Battery Pack
3. Charge the Main and Backup Batteries
4. Initialize the Mobile Computer
5. Align the Screen
6. Let Autoinstall Run
7. Set the Time and Date
8. Verify Imaging and Decoding with Demos

Step 1. Unpack the Carton and Verify its Contents

Verify that the carton contains the following items:

- Dolphin 9500 Series mobile computer (the terminal)
- Main battery pack (7.4v Li-ion)
- Microsoft Companion CD
- Dolphin 9500 Quick Start Guide

Be sure to keep the original packaging in the event that the Dolphin terminal should need to be returned for service. For details, see [Product Service and Repair](#) on page 16-1.

Each order includes a Dolphin Software Development Kit and User's Guide CD; verify that you received this CD with your order. If you ordered accessories for your terminals, verify that they are also included with the order.

The Dolphin 9500 Hand Strap

The Dolphin 9500 ships with the hand strap installed and fastened to the bottom panel with a clip; see [Bottom Panel Features](#) on page 3-9. To install the battery pack, you must detach the hand strap.

To detach the hand strap, push the hand strap clip down and away from the terminal. Move the strap up and away from the bottom panel.

To re-attach the hand strap, slide the clip back into place on the bottom panel.

The Dolphin 9501 has a special hand strap; see [Hand Strap and Stylus](#) on page 11-7.

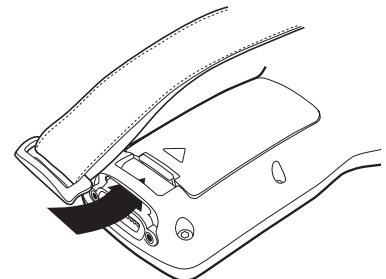

Step 2. Install the Main Battery Pack



Use only the Li-ion battery packs provided by Hand Held Products. The use of any battery pack not sold/manufactured by Hand Held Products in Dolphin 9500 Series terminals will void your warranty and may result in damage to the Dolphin terminal or battery.

1. Unpack the Li-ion battery pack. Hold the terminal with the front panel (keyboard) facing down.
2. Take the battery and insert the end without the locking tab into the top of the battery well and push down with a hinging motion until the locking tab snaps.

To Remove the Main Battery Pack

Put the terminal in suspend mode (see page 2-12). Press the locking tab on the battery pack away from the bottom panel, and pull the battery pack up with a hinging motion.

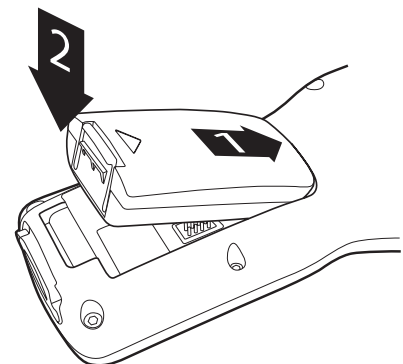

Step 3. Charge the Main and Backup Batteries

The power supply for the Dolphin mobile computer consists of two types of battery power: the main battery pack installed on the back panel and the backup battery that resides inside the terminal.

The main battery powers the terminal. The internal backup battery charges off the main battery and maintains the application data stored in RAM and system clock for up to 30 minutes when the terminal's main battery pack is completely discharged or removed.

Before Initial Use The terminals are shipped with both batteries discharged of all power. Charge the main battery pack for a minimum of four hours before initial use.

Time to Charge Four hours for the main battery pack, eight hours for the internal backup battery the first time.



Use only Dolphin 9500 Series peripherals, power cables, and power adapters. Use of peripherals, cables, or power adapters not sold/manufactured by Hand Held Products will void the warranty and may damage the terminal.

Charging with Dolphin Peripherals

When the battery is installed in the terminal, you can insert the terminal into any one of the following peripherals to charge the main battery pack:

- [Dolphin 9500 Series HomeBase](#) (see page 12-1)
- [Dolphin 9500 Series Mobile Base](#) (see page 13-1)
- [Dolphin 9500 Series ChargeBase](#) (see page 14-1)
- Dolphin 9500 Series Net Base
- Dolphin 9500 Series Charging/Communication Cable

To fully charge the Li-ion battery **before** installing it in the terminal, use the

- [Dolphin 9500 Series QuadCharger](#) (see page 15-1)
- [Auxiliary Battery Well](#) of the Dolphin HomeBase (see page 12-5)

Step 4. Initialize the Mobile Computer

1. Power on the terminal by pressing the POWER or SCAN key. The decode LED lights and the scan LED blinks for approximately three seconds. Do NOT press any keys while the terminal is booting up.
2. The terminal initializes and the splash screen displays for a few seconds. The Build numbers indicate the software version.

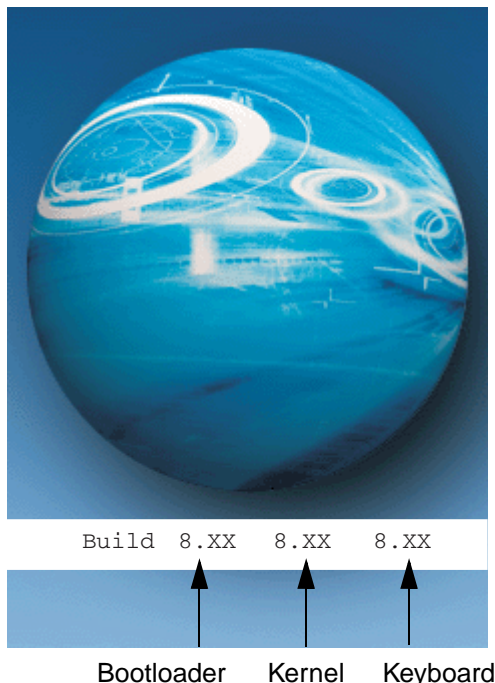

3. The system performs a hard reset. When the display activates again, follow the instructions that appear.

Step 5. Align the Screen

You are prompted to align the screen by tapping the target five times. Use the stylus provided by Hand Held Products.

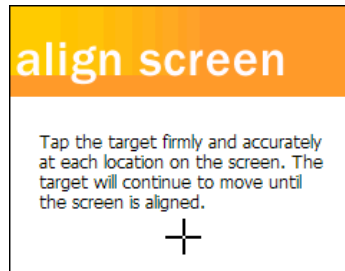

- Alignment should always be performed with a stylus designed for touch screen applications. The small point is required for accurate calibration.
- Press the stylus firmly into the center of the cross-hair target once and release. Do not “double-tap” the target.
- You can re-align the screen at any time by going to **Start > Settings > System tab > Screen**.

Step 6. Complete the Opening Screens

After aligning the screen, follow the directions on the screen which take you through a simple exercise showing how to use the stylus and pop-up menus.

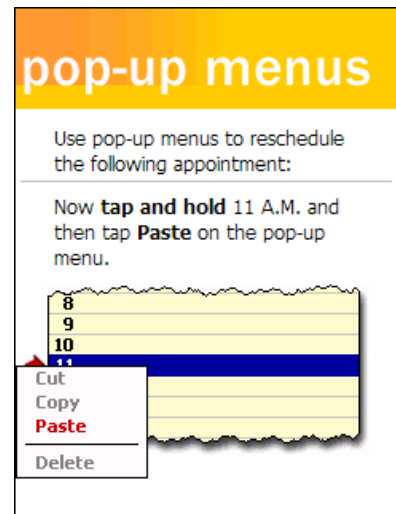
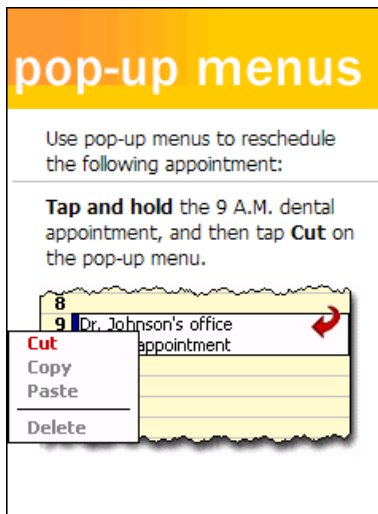
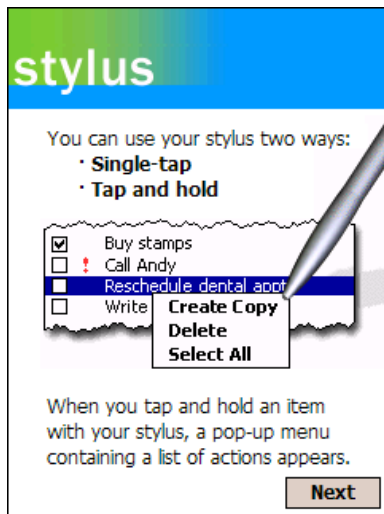

Note: Hand Held Products recommends using screen protectors for Dolphin terminals; especially for those terminals used within applications that require high-volume interfacing with the touch screen. Screen protectors help prevent damage to the touch screen and are easily installed. Screen protectors can be purchased at any major computer retail store or directly from Hand Held Products. Please contact Hand Held Products directly for part numbers and pricing.

Step 7. Set the Time Zone

After completing the screens, the Location screen shown below displays. Use the drop-down list to select your time zone, and tap Next.

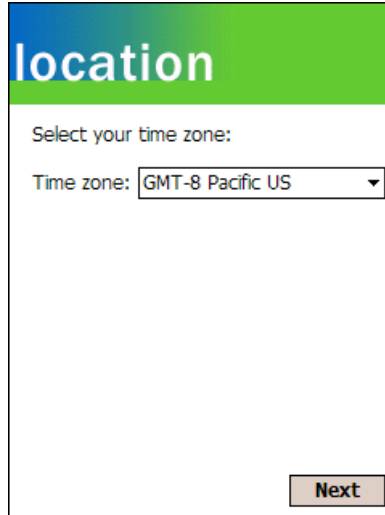

This does not set the correct time; only the time zone. You set the time and date manually. For details, see [Setting the Time and Date](#) on page 2-10. After setting the time zone, you are finished with the initial setup of your Dolphin mobile computer. The system begins autoinstalling.

Step 8. Let Autoinstall Run

For each program that loads, a status bar indicates that the program is loading. Autoinstall occurs after each hard reset. Do NOT touch the keyboard or the screen while programs are loading. All configurations of the Dolphin 9500 Series install Demos and Utilities. If the terminal is configured with a wireless radio, the appropriate radio drivers and utilities for each radio install.

After Autoinstall is complete, the terminal performs a soft reset automatically. When it finishes booting up after the soft reset, the Today screen appears; see [Today Screen](#) on page 4-2.

Step 9. Set the Time and Date

You need to re-set the time and date after every hard reset of the terminal. It is a good idea to set the time and date now before you begin using the device.

On the Today screen, tap the line that displays the time and date,

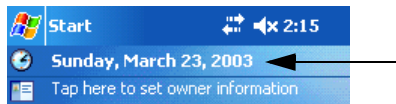

The Clock Settings screen appears.

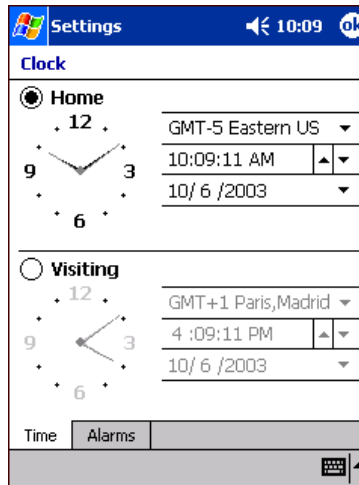

The time zone defaults to GMT-5 Eastern US; tap the arrow to select another time zone. Set the correct time and date in the remaining fields.

Step 10. Verify Imaging and Decoding with Demos

Dolphin 9500 Series mobile computers come loaded with Demos you can use to verify imaging and decoding.

Verify Imaging

The Image Demo enables you to use the imager to capture an image on the Dolphin 9500 and Dolphin 9550.

1. Go to **Start > Demos > Image Demo**. The image demo opens.
2. Point the terminal at an object and press the SCAN key. A preview of the object appears on the terminal screen.
3. Release the SCAN key. The image is captured. By default, the image saves to the My Device folder as "imagedemo.jpg." To save to a different location, go to **File > Save As** and select a new location.
4. Press the ESC key to close the demo.

For more information about taking an image, see [Using the Image Engine](#) on page 4-4.

Verify Decoding

The Scan Demo enables you to decode a sample bar code.

1. Go to **Start > Demos > Scan Demo**.
2. Aim the terminal at a bar code and press the SCAN key. The scan LED lights red, and a green aimer beam projects out from the scanner.
3. When a good scan is obtained, the decode LED lights solid green and the terminal beeps. The bar code readout appears on the screen.
4. Press the ESC key to close the demo.

Sample Bar Codes

You can use the following bar codes to verify decoding:

Sample 128



Code 128

Sample PDF417



PDF417 Test Message

Note: The Dolphin 9551 supports only 1D symbologies; use Code 128 to verify scanning.

For more information, see [Decoding](#) on page 4-4.

Resetting the Terminal

There are two ways to reset the terminal: a soft and a hard reset.

Soft Reset (Warm Boot)

A soft reset re-boots the device without losing RAM data. You would perform a soft reset when

- the terminal fails to respond.
 - after installing some software applications.
 - after making changes to certain system settings, such as network cards.
1. Press and hold the Control (CTRL) and the Shift (SFT) keys for approximately five seconds.
 2. The decode and scan LEDs flash for approximately three seconds as the terminal resets.
 3. When the reset is complete, the Today screen displays.

Hard Reset (Cold Boot)

A hard reset resets the operating system, restores the terminal back to factory defaults, and resets the terminal after a bootloader, keyboard, and kernel upgrade.



A hard reset erases all of the data stored in RAM memory and all RAM installed applications!

1. Press and hold the Control (CTRL) and the Escape (ESC) keys for approximately five seconds.
2. The decode and scan LEDs light for approximately three seconds.
3. The terminal re-initializes; see [Initialize the Mobile Computer](#) on page 2-8.

Suspend Mode

To put the Dolphin terminal into suspend mode manually, press and hold the POWER key. The terminal goes into suspend mode automatically when the terminal is inactive for a programmed period of time. For more information, see [Power](#) on page 5-10.

To wake the Dolphin terminal from suspend mode, press the Power or SCAN key.

System Features

Processor

Dolphin 9500 Series terminals are equipped with an Intel X-Scale 400MHz RISC microprocessor that runs on a 100 MHz RAM BUS, making it one of the most powerful Windows Mobile platforms on the market.

Operating System

The Windows Mobile platform provides a compact, highly efficient, scalable operating system. The open architecture facilitates the development of applications for energy-efficient data collection devices such as Dolphin 9500 Series terminals.

Memory

Main Board/IPSM The standard memory configuration is 64 MB RAM and 32 MB non-volatile Flash.

Secure Digital Card (SD) Dolphin 9500 Series terminals contain one Secure Digital (SD) memory interface for additional application and data storage. You can order memory upgrades of 64 MB, 128 MB, and 256 MB. Each terminal contains an access door that makes the SD memory user-accessible. However, when that access door is fastened securely and properly, the terminal's environmental rating is preserved.

For more information about each kind of memory, see [Memory](#) on page 5-8.

Wireless Radio Options

For more information, see [Radio Options](#) on page 4-16.

Front Panel Features

This section describes features on the front panel on Dolphin 9500 Series terminals.

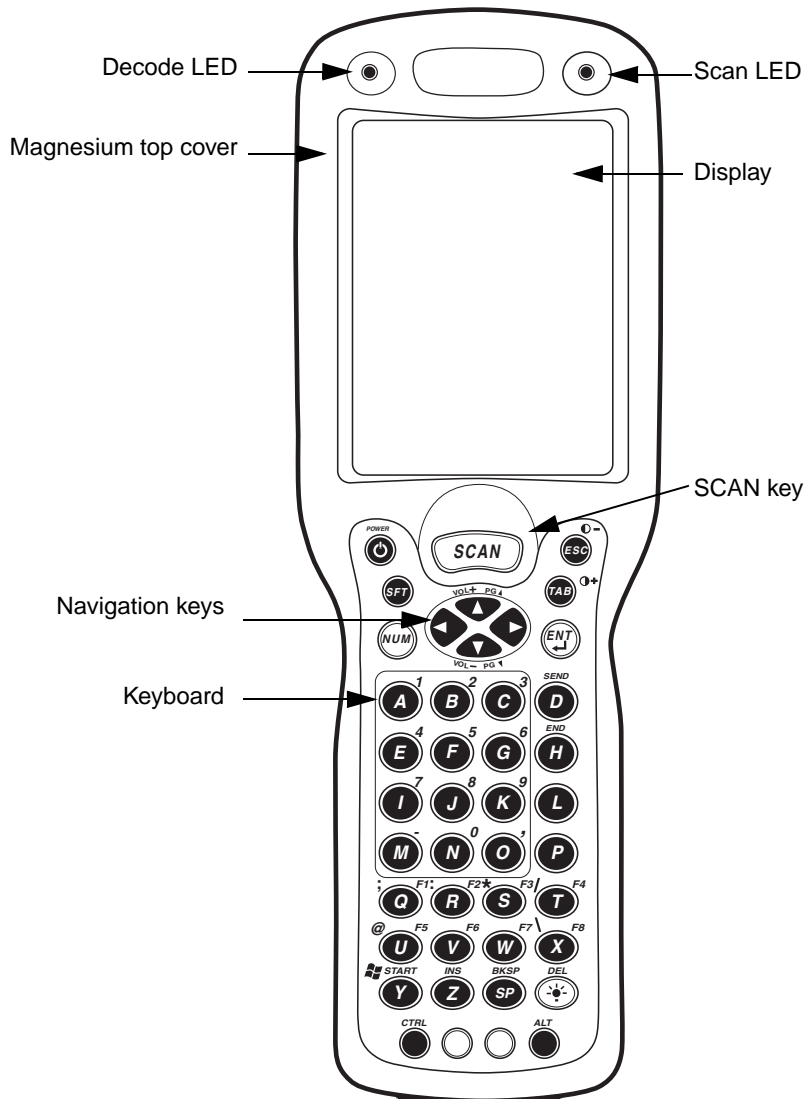

LEDs

The two light emitting diodes (LEDs) located at the top of the LCD display flash and illuminate during resets and scanning/imaging. Both can be programmed by various software applications.

Scan LED - Located in the upper right corner, this LED lights red when you press the SCAN key.

Decode LED - Located in the upper left corner, this LED lights green when a scanned bar code is successfully decoded.

Display

Dolphin 9500 Series terminals feature a 3.5" liquid crystal display (LCD) touch screen and is covered with an industrial, protective lens. The video graphic array (VGA) resolution is 1/4 (240 X 320 pixel). The touch screen is activated with the stylus (included with the terminal) or a finger. The LCD display is available in monochrome and color.

Color - The color LCD is 16 bits/pixel and uses active display or thin film transistor (TFT) technology. The backlight for the display illuminates when the screen is touched, but not when the Backlight key is pressed.

Monochrome - The monochrome LCD is grayscale and 4 bits/pixel. The backlight illuminates when the touch screen or the Backlight key is pressed. Monochrome units contain an additional contrast setting to enhance readability.

For more information about the Backlight, see [Adjusting the Backlight](#) on page 4-13.

SCAN Key

The SCAN key is centrally located for easy access with the right or left hand. When pressed, the SCAN key activates the scanner/imager. The SCAN key also functions as an on or system wakeup control for the terminal.

Navigation Keys

The centrally-located navigation keys enable you to move and position the cursor through software programs. The up and down arrows are programmed to perform specific functions when pressed in combination with the Blue and Red modifier keys.

Keyboard

The Dolphin 9500 Series feature three keyboard options: 35-key numeric/alpha keyboard, 43-key numeric/alpha keyboard, and 56-key full alpha/numeric keyboard. For a complete overview of each keyboard, see [Using the Keyboards](#) on page 4-7.

Each keyboard is backlit for easy viewing in various lighting conditions and contains centrally located keys for both right- and left-hand operation. The silver background of both the keys and the overlay enhances the readability of each. The overlay of all three keyboards are color-coded to indicate the functions performed or characters typed when the color-coded key is pressed immediately after the Red or Blue Modifier key at the bottom of the keyboard.

Back Panel Features

Because the back panel of the Dolphin 9500 and the Dolphin 9550 are different, each is featured in its own section.

Dolphin 9500

The following graphic describes features on the back panel of the Dolphin 9500 terminal.

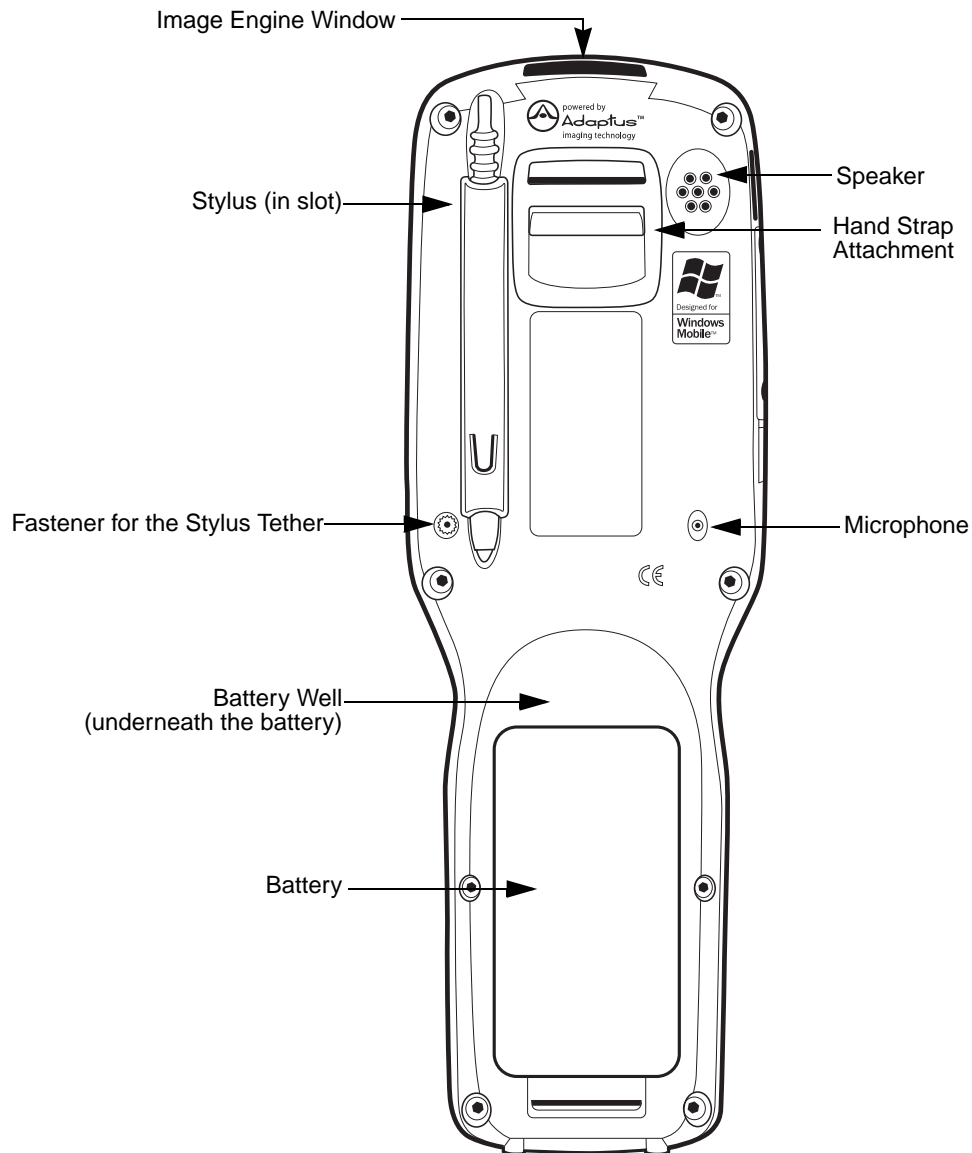

Image Engine Window

Dolphin 9500 Series terminals have an optional image engine that reads and decodes linear, stacked linear (PDF417), and 2D matrix bar code symbologies. With the latest CMOS-based technology, the engine works like a digital camera and enables digital image capture, signature capture, and reading of OCR characters.

Digital images taken with Dolphin 9500 Series terminals have a maximum image size of 640 x 480 pixels and may have up to a 256 grayscale image definition. File formats supported for image storage include Bitmap (.bmp), JPEG (.jpg) and Portable Network Graphics (.png).

For a view of the image engine window, see [Image Engine Window](#) on page 3-6.

Speaker

Dolphin 9500 Series terminals have an integrated speaker that sounds audio signals as you scan bar code labels and enter data. The operating frequency range is 500Hz at 71 dB up to 80 dB. The speaker can also be used for playing sounds (e.g., WAV or MP3 files) as well as voice communication in handset mode in a terminal equipped with a GSM/GPRS radio. For more information about handset use, see [Audio Modes](#) on page 9-12.

Hand Strap Attachment

The Dolphin 9500 has an adjustable, elastic hand strap to provide a comfortable, secure grip on the terminal. It is attached to the terminal with a clip on the bottom panel; see [Hand Strap Clip](#) on page 3-9. If desired, the strap may be adjusted or removed.

Microphone

Dolphin 9500 Series terminals feature an integrated microphone that provides audio input to the terminal when a headset is not plugged into the [Audio Jack](#), page 3-8. When a headset is plugged in, the terminal defaults to the microphone on the headset. For more information, see [Headset Control](#) on page 5-5.

Battery/Battery Well

The Battery Well is a recessed area on the back of the Dolphin that holds the Li-Ion battery pack. For more information, see [Batteries](#) on page 3-10.

Stylus and Fastener

The stylus is used to operate the touch screen. The back panel features this storage slot to hold the stylus when not in use. There is also a fastener on the back panel for stylus tethers.

Stylus tethers can be purchased separately to help you keep the stylus attached to the terminal when not in the slot to prevent loss. A stylus tether is a coiled elastic cord with one end to attach to the stylus and another to attach fasten to the back panel.

Dolphin 9550

This section describes the back panel of the Dolphin 9550. It contains the same features as the Dolphin 9500 described in the previous section with the additions of

- a pistol-grip handle to hold and maneuver the terminal with greater ease,
- a scanner/imager trigger on the handle that activates the scan, and
- rubber bumpers that enable the terminal to rest safely and securely when not in use.

The following is a graphic of the 9550 back panel.

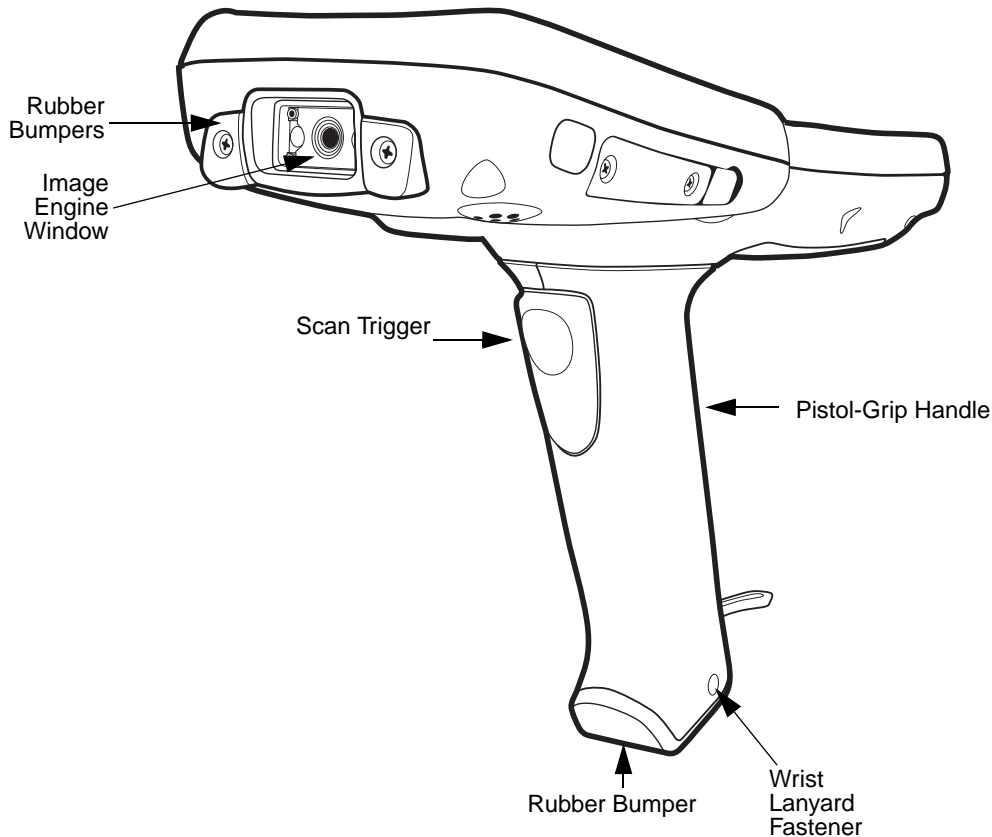

Image Engine Window

This is the front view of the window. For more information, see [Image Engine Window](#) on page 3-5.

Scan Trigger

The scan trigger provides comfortable scan activation for scan-intensive applications.

Pistol Grip Handle

The comfortable, ergonomic handle is integrated into the back panel to enhance the terminal's durability in rugged, real-world settings; the handle cannot be removed from the terminal. Designed specifically for rapid, high-volume scanning, the handle features rubber surface details to improve handle grip, comfort, and shock absorption.

Wrist Lanyard Fastener

A wrist lanyard is available for Dolphin 9550 terminals that you can attach to the handle in this location.

Rubber Bumpers

The following graphic shows the Dolphin 9550 in a nose-down position, resting on its rubber bumpers.

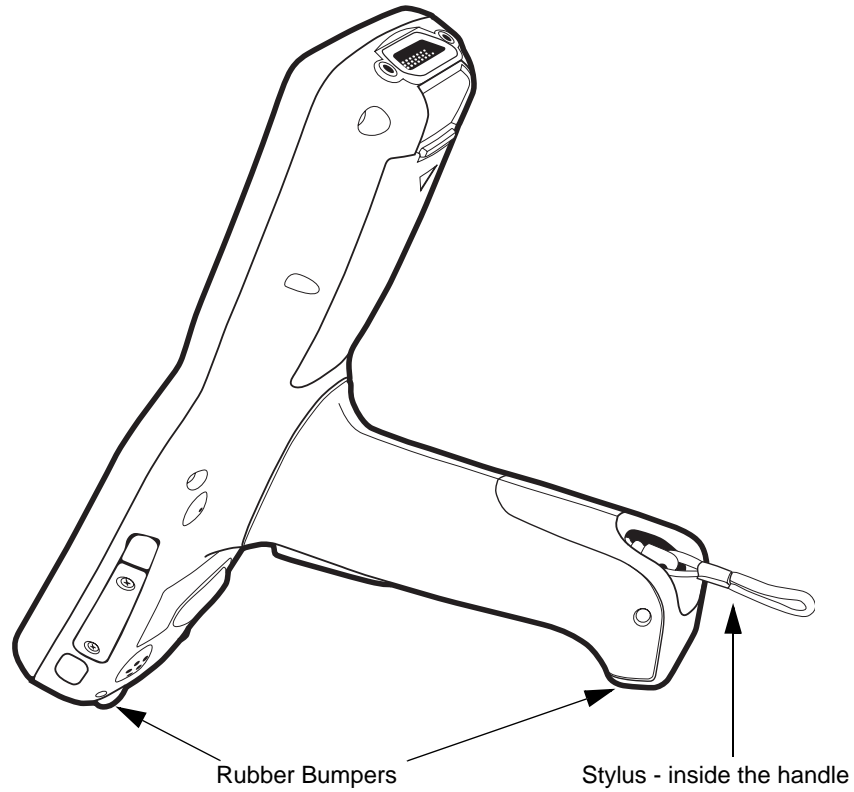

Stylus

The stylus is used to operate the touch screen display. The Dolphin 9550 stores the stylus inside the pistol-grip handle.

Dolphin 9501 and Dolphin 9551

See [Dolphin 9501 and Dolphin 9551](#) on page 11-1.

Side Panel Features

The following graphic shows the left, side panel:

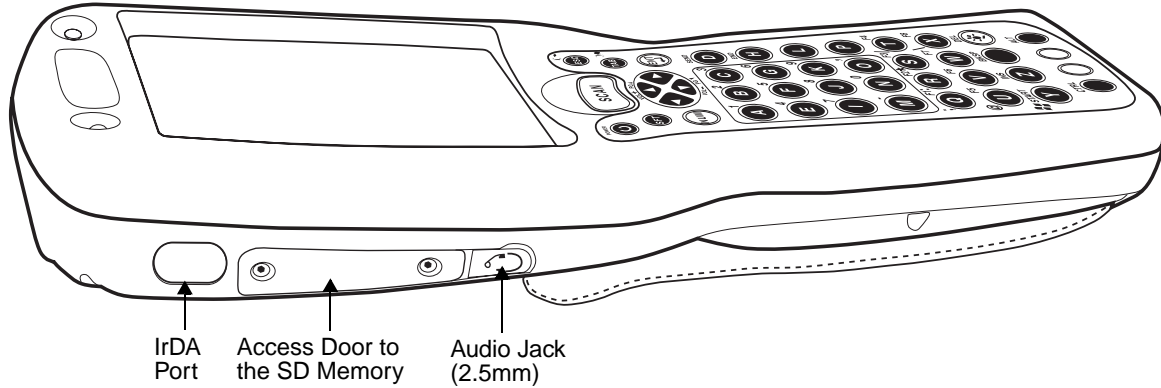

IrDA Port

The Infrared Data Association or IrDA port communicates with IrDA-enabled devices such as PC's, printers, modems, or other Dolphin 9500 Series terminals. The maximum speed is 115kbps.

SD Memory

Dolphin 9500 Series terminals contain an access door to an industry-standard SD memory interface. The secure digital access door seals the memory interface from moisture and particle intrusion and provides secure storage for read/write data. However, the user can open the access door manually to gain access to the SD.

You can custom-configure the terminal with SD memory of 64MB, 128MB, or 256MB. The SD memory interface does not support SDIO.

Audio Jack

Dolphin 9500 Series terminals contain a 2.5mm audio jack that supports both speaker (stereo) and microphone (mono) headsets.

Bottom Panel Features

This following graphics describe the bottom panel of the Dolphin 9500 Series.

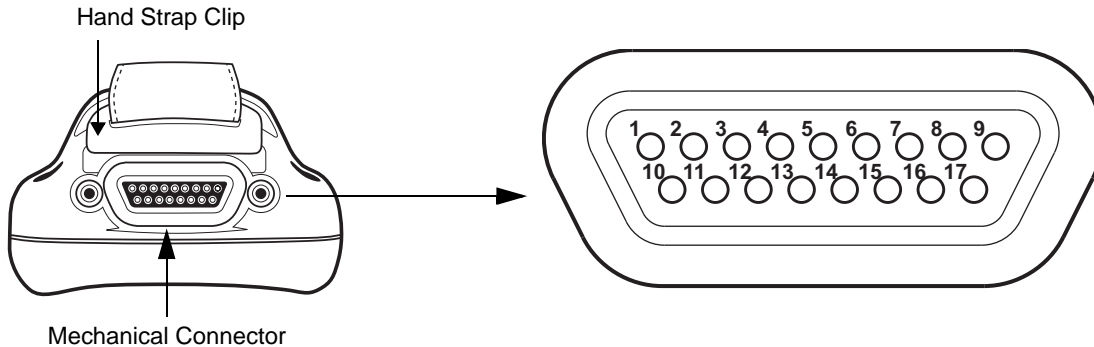

Pin # Description

1	+USB
2	PWR
3	N / C
4	N / C
5	N / C
6	N / C
7	GND
8	5V OUT
9	DTR
10	-USB
11	USB DET
12	RI
13	DSR
14	RXD
15	RTS
16	TXD
17	CTS

Note: Signals referenced are for a DTE device.

Mechanical Connector

The bottom panel of the Dolphin 9500 Series features a custom, industrial-grade connector with 17 pins. When seated in a Dolphin 9500 Series peripheral, the terminal is powered, the main battery charged, and communication occurs via this connector. All Dolphin 9500 Series peripherals are designed to work exclusively with this connector.

The 17-pin connector can communicate with Dolphin 9500 Series peripherals via RS-232 or USB. For RS-232, the maximum communication speed is 115 Kbps with seven baud rate settings. For USB, the communication speed is up to 12 Mbps. If the peripheral unit is connected to a PC, this connector also transmits data.

Powering Out

The mechanical connector also provides power out (to peripheral devices) 5V at 500mA. This means that, with the proper Hand Held Products' cable, the terminal can power another device. By default, power out is disabled. To enable power out, alter the registry as follows:

```
[HKEY_LOCAL_MACHINE\Drivers\BuiltIn\Serial4]
    Conn5Venable=1
```

Batteries

Dolphin 9500 Series features intelligent battery technology. There are two types of battery power: the main battery pack installed in the back panel and the backup battery located inside the terminal. They are designed to work together to prevent data loss when the terminal is in use over long periods. Both batteries must be completely charged before using a Dolphin terminal for the first time.

Main Battery Pack



Use only the Li-ion battery packs provided by Hand Held Products. The use of any battery pack not sold/manufactured by Hand Held Products in Dolphin 9500 Series terminals will void your warranty and may result in damage to the Dolphin terminal or battery.

The 7.4V, 14.8 watt hour Li-Ion battery pack is the primary power source for the Dolphin. The Li-Ion battery is designed to operate in a temperature range of -10 to 50° C (14 to 122° F). For the location of the Li-Ion battery on the terminal, see [Battery/Battery Well](#) on page 3-5.

Charging Options

When the Li-ion battery is installed in the terminal, use one of the following peripherals:

- [Dolphin 9500 Series HomeBase](#) (see page 12-1)
- [Dolphin 9500 Series Mobile Base](#) (see page 13-1)
- [Dolphin 9500 Series ChargeBase](#) (see page 14-1) or the Dolphin 9500 Series Net Base
- Dolphin Mobile Charger - connect the charger to the terminal and vehicle power port

Note: Make sure the mechanical connector on the terminal is properly connected to the peripheral and that the peripheral is connected to the appropriate power supply.

When the Li-ion battery is not installed in the terminal:

- Place the battery pack in the Dolphin QuadCharger - see [Charging Batteries in the QuadCharger](#) on page 15-3.
- Place the battery pack in the [Auxiliary Battery Well](#) of the Dolphin HomeBase (see page 12-5)

Charging Time

The Li-ion battery pack requires four hours to charge completely.

Internal Backup Battery

Located inside the terminal, the backup battery is a 3.6 Volt nickel metal hydride (NiMH) battery.

Purpose

The internal backup battery prevents the terminal from being reset if you need to remove and replace the main battery pack. It retains RAM data and allows the real-time clock to remain operational for up to 30 minutes when the main battery pack is removed. If the terminal is left without the main battery pack for more than 30 minutes, the internal backup battery needs to be recharged to function according to its specifications.

*Note: Data and programs stored in **Flash** memory are not lost even if the internal backup battery fails. However, you must reset the real-time clock; see [Set the Time and Date](#) on page 2-10.*

Charging

The internal backup battery is powered by the main battery pack. Therefore, charging the internal backup battery requires that the main battery pack be installed in the terminal and the terminal be connected to a charging device.

The internal backup battery must be fully charged before using the terminal for the first time. The initial charge cycle takes approximately eight hours. After that, if the internal backup battery becomes fully discharged of power, it requires a minimum of 10 hours of charging time to function normally.

Guidelines for Use

Follow these guidelines to maximize the life of the Dolphin's internal backup battery:

- Keep a charged Li-Ion battery pack in the Dolphin terminal. The internal battery prematurely discharges if there is not at least a partially charged battery in the terminal.
- Keep the Dolphin terminal connected to power when the terminal is not in use.

Managing Battery Power

Data and files saved on Dolphin 9500 Series terminals may be stored in RAM; therefore, to help prevent data loss, maintain a continuous power supply to the terminal. When the main battery pack becomes low, the Low Battery Charge icon appears in the notification tray at the top of the screen. The Critical icon appears when the battery is critically low. There is also a Low Battery icon that appears when the backup battery is low. For details about these icons, see [Status Icons](#) on page 4-22.

Letting the backup battery become fully discharged causes the terminal to lose all data in RAM. Therefore, you should keep a charged battery pack in the Dolphin at all times. The internal battery discharges prematurely if there is not at least a partially charged battery in the terminal. When you remove a battery pack, insert another charged battery pack in the Dolphin.

The battery status indicator displays in the notification tray when the battery is low or critically low. If there is no indicator, the battery is adequately charged. If the main battery is low and the terminal is in suspend mode, pressing the SCAN or Power button does not wake the Dolphin terminal; you must replace the discharged battery with a fully charged battery.

Default Critical and Low Battery Points

Dolphin 9500 Series terminals are programmed to display warnings when the battery reaches critical and low battery points. There are two DWORD value registry entries [**HKEY_LOCAL_MACHINE\System\CurrentControlSet\Control\Power**] that allow these warning points to be customized:

“**CriticalBatt**”=**a** (10%)

This sets the Critical Battery point to 10 percent (a hex = 10 decimal). The critical battery setting is the point at which the customer is warned that the battery charge is very low. This warning is posted every 3 minutes until the situation is corrected.

“**LowBatt**”=**19** (25%)

This sets the Low battery point to 25 percent (19 hex = 25 decimal). The low battery setting is the point at which the user is notified that the battery is low. The user is notified only once for a low battery.

Setting Critical and Low Battery Points

Developers can reset these parameters in the registry from 0 (no warning) to 99 (would nearly always warn). Warnings do not appear when the terminal is on external power.

You can also review and set these battery points in the RegEdit utility. Tap **Start > Utils > RegEdit**. Drill-down to **HKEY_LOCAL_MACHINE > System > CurrentControlSet > Control > Power**. The Battery Points appear in a list in the lower half of the window; tap on the Value Name to change the Value Data.

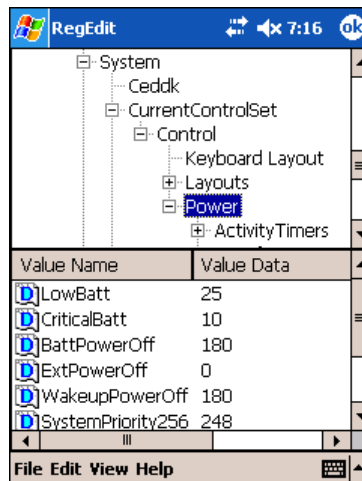

Checking Battery Power

Tap **Start > Settings > System tab > Power**. The Battery tab opens displaying the charge status of both the installed Li-ion battery pack and the NiMH backup battery inside the terminal.

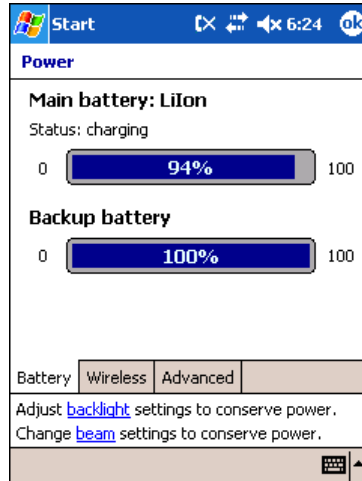

Power system settings contains three tabs: Battery, Wireless, and Advanced. For more information, see [Power](#) on page 5-10.

Storing Batteries

To maintain optimal battery performance, follow these storage guidelines:

- Avoid storing batteries outside the specified range of -4 to 104° F (-20 to 40°C) or in extremely high humidity.
- For prolonged storage, do not keep batteries stored in a charger that is connected to a power source.

Guidelines for Battery Use and Disposal

The following are general guidelines for the safe use and disposal of batteries:

- Use only the battery supplied, recommended, or approved by Hand Held Products.
- Replace defective batteries immediately; using a defective battery could damage the Dolphin terminal.
- Never throw a used battery in the trash. It contains heavy metals and should be recycled according to local guidelines.
- Don't short-circuit a battery or throw it into a fire. It can explode and cause severe personal injury.
- Excessive discharge damages a battery. Recharge the battery when your terminal indicates low battery power.
- Although your battery can be recharged many times, it will eventually be depleted. Replace it after the battery is unable to hold an adequate charge.
- If you are not sure the battery or charger is working properly, please send it to Hand Held Products or an authorized Hand Held Products service center for inspection.

Dolphin 9500 Series Technical Specifications

System Architecture	
Processor:	Intel X-Scale PXA255 400MHz
Development Environment:	Dolphin SDK Add-on for Pocket PC 2003 - supports Embedded Visual C++ 4.0 Dolphin .NET SDK for Pocket PC 2002 and 2003 - supports Visual Studio.NET 2003 (VB.NET and C#.NET) Dolphin GSM/GPRS SDK Add-on for Pocket PC 2003 - supports Embedded Visual C++ 4.0 and Visual Studio.NET 2003
Operating Platform:	Windows Mobile 2003 Software for Pocket PCs - Professional Edition
Third-Party Software:	Support for Connect Terminal Emulation software (TNVT, 3270, 5250) and Java Virtual Machine (JVM) runtime
Memory:	64MB RAM x 32MB non-volatile Flash
Data Inputs	
Imager/Scanner:	See Image Engine Options and Specifications on page 2-5.
1D Symbologies:	See 1D Symbologies on page 2-6.
2D Symbologies:	See 2D Symbologies on page 2-6.
Composite Codes	See Composite Codes on page 2-6.
OCR Fonts:	See OCR Codes on page 2-6.
Three Keyboard Options:	35-key numeric-shifted alpha, 43-key alpha-shifted numeric, and 56-key full alpha/numeric See Using the Keyboards on page 4-7.
Data Outputs	
Display:	See Display on page 3-3.
I/O Ports:	Custom, industrial-grade, mechanical connector supports <ul style="list-style-type: none"> • USB communications at 12Mbps • Serial RS-232 communication up to 115Kbps • Charging via peripheral cradles or AC adapter cables Integrated IrDA port, speaker, and microphone
Mass Storage:	User-accessible Secure Digital (SD) memory interface
Wireless Radio Options	
WLAN:	IEEE 802.11b DSSS Authentication Methodologies: LEAP, MD5, TLS, TTLS, PEAP, and WEP
WWAN: (9500 only)	GSM/GPRS Tri-band (900, 1800, 1900 MHz) radio with accessible SIM card interface
WPAN:	Bluetooth radio
Physical	
Dimensions:	9500/9550— 9.6"L x 3.45"W x 1.66"D at display (24.53 x 8.76 x 4.23 cm), 2.7"W x 1.5"D at grip (6.9 x 3.8 cm) 9501/9551 – 9.7"L x 3.45"W x 2.27"D at display (24.66 x 8.77 x 5.76 cm), 2.7"W x 1.5"D at grip (6.9 x 3.8 cm)

Dolphin 9500 Series Technical Specifications

Weight:	<p>9500 Terminal – Batch: 19.7 oz. (558 gm), WLAN: 20.2 oz. (573 gm), WPAN: 20 oz. (567 gm), WLAN/WPAN: 20.3 oz. (576 gm)</p> <p>9501 Terminal – 22.65 oz. (642 gm), all versions</p> <p>9550 Terminal – Batch: 23.4 oz. (663 gm), WLAN: 23.9 oz. (677.5 gm)</p> <p>9551 Terminal – 25.8 oz. (732 gm), all versions</p>
Operating Temperature:	<p>14 to 122°F (-10°C to 55°C)</p> <p>The terminal can operate in temperatures lower than -20°C with potential degradation in performance depending on the application</p>
Storage Temperature:	-22 to 176°F (-30°C to 80°C)
Humidity:	95% humidity, non-condensing
Electrical Static Discharge:	15 KVA on all surfaces
Impact Resistance:	Withstands multiple 5ft. (1.5m) drops onto concrete
Environmental Resistance:	Independently certified to meet IP64 standards for moisture and particle resistance
Power:	Lithium-Ion battery technology – 7.4V, 14.8 watt-hour main battery with hot-swappable design for fast replacement in the field
Other:	Integrated stylus with optional tether and adjustable, removable hand strap
Peripherals & Accessories	<p>See Dolphin 9500 Series Peripherals on page 2-3.</p> <p>See Dolphin 9500 Series Accessories on page 2-4.</p>
Regulatory Approvals	See Required Safety Labels on page 1-2.

Entering Data

To enter data, you may:

- Use the imager to capture images or scan bar code data into data fields
- Use the 35-key, 43-key, or 56-key keyboards
- Use the Soft Input Panel (SIP)
- Use Microsoft® ActiveSync® to synchronize or copy information from your desktop computer. For more information, see [Using ActiveSync](#) on page 6-2.

Touch Screen

Hand Held Products recommends using screen protectors to protect the touch screen; especially when used with applications that require high-volume interfacing with the touch screen. Screen protectors help prevent damage to the touch screen display and are easily installed. Screen protectors can be purchased at any major computer retail store or directly from Hand Held Products.



For touch screen input, use the included stylus or your finger. The method you choose depends on which one is appropriate for your application. While there is a great deal of variation in different applications, for buttons or icons that are close together, you generally achieve greater accuracy with the stylus. Use of other objects, such as paper clips, pencils, or ink pens can damage the input panel and will void the warranty.

Today Screen

After the Dolphin terminal initializes the first time, you see the Today screen. You can also display it by tapping **Start** and then **Today**. On the Today screen, you can see important information for the day at-a-glance.



Navigation Bar

The navigation bar is located at the top of the screen. It displays the active program and current time, and allows you to switch to programs and close screens.

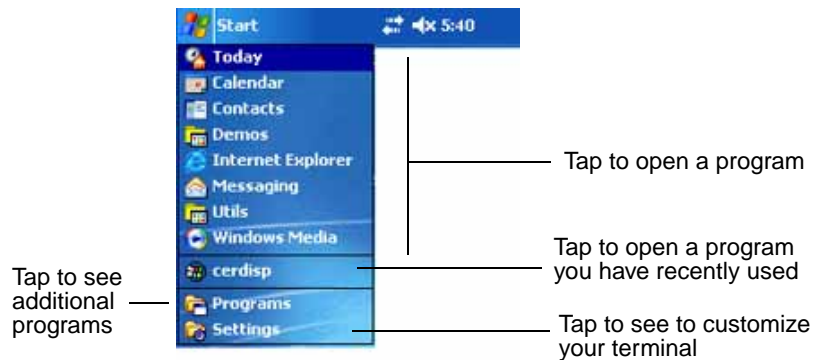

Command Bar

Use the command bar at the bottom of the screen to perform tasks in programs. The command bar includes menu names, buttons, and the Input Panel button. To create a new item in the current program, tap **New**. To see the name of a button, tap and hold the stylus on the button. Drag the stylus off the button so that the command is not carried out.

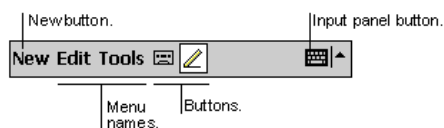

Pop-Up Menus

With pop-up menus, you can quickly choose an action for an item. For example, you can use the pop-up menu in the contact list to quickly delete a contact, make a copy of a contact, or send an e-mail message to a contact. The actions in the pop-up menus vary from program to program.

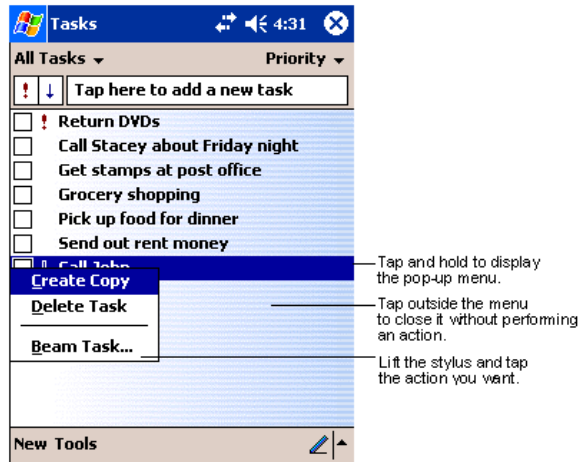

To access a pop-up menu, tap and hold the stylus on the item name of the action you want to perform the action. When the menu appears, lift the stylus, and tap the action you want to perform. Or tap anywhere outside the menu to close the menu without performing an action.

Selecting Programs

To see additional programs loaded on your terminal, tap **Start > Programs**. The Programs screen displays the programs that are not listed on the Start menu. To open a program, tap once on the icon.

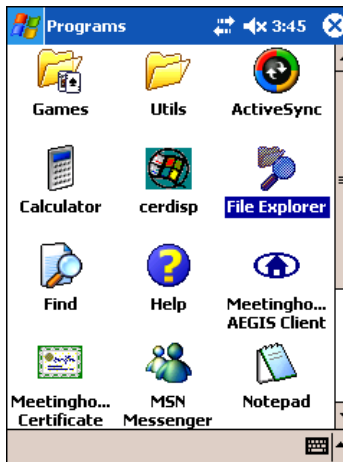

Note: Some programs have abbreviated labels underneath the icon. To see the full spelling of an abbreviated label, tap and hold the stylus on the label. Drag the stylus off the label so that the command is not carried out.

Using the Image Engine

The Dolphin terminal houses a compact image engine that instantly reads all popular 1D and 2D bar codes and supports omni-directional aiming and decoding for greater flexibility in real-world settings. The image engine can also capture digital images, such as signatures and pictures of damaged inventory.

The following table contains the available imaging/decoding options for each Dolphin 9500 Series terminal:

Terminal	1D	2D	Image Capture	Aiming	Omni-Directional Aiming	Engine Options
Dolphin 9500	Y	Y	Y	Green aiming beam or High-Vis aiming pattern	Y	IT4100SF, IT4100SR, IT4100HD, IT4300SF, IT4300SR
Dolphin 9550	Y	Y	Y		Y	
Dolphin 9501	Y	N	N	Long-range laser aimer	N	SE1200HP, SE1200LR, SE1200ALR
Dolphin 9551	Y	N	N		N	

For more information about the Dolphin 9500 and Dolphin 9550, see [Image Engine Options and Specifications](#) on page 2-5.

For more information about the Dolphin 9501 and Dolphin 9551, see [Laser Engine Options and Specifications](#) on page 11-1.

Decoding

The terminal supports two types of image decoding for use in various bar code reading and imaging applications: full-area imaging and Advanced Linear Decoding (ALD).

Full-Area Imaging

Full-area imaging provides omni-directional reading of linear and non-linear 1D and 2D bar codes, OCR, signature capture, and picture taking. When reading all bar code types using full-area imaging, a positive read can be obtained from many positions; see [Dolphin 9500/Dolphin 9550 Scanning Position Options](#) on page 4-5. To achieve the best read, the aiming beam should be centered horizontally across the bar code.

ALD

ALD provides fast reading of linear and stacked linear bar codes. To achieve a positive read when reading linear 1D and PDF417 bar codes, the green aiming beam should be centered horizontally across the bar code. When ALD is enabled, the reader does not read matrix or postal codes.

To Decode a Bar Code

1. Point the Dolphin terminal directly at the bar code. The imager faces straight out the top panel. The aiming beam should be oriented in line with the bar code to achieve optimal decoding. A range of 4-10 inches (10-25 cm) from the bar code is recommended.
2. Project the aiming beam or pattern by pressing and holding the SCAN key. On the Dolphin 9550 and the Dolphin 9551, you can also press the [Scan Trigger](#), page 3-6
3. The scan LED lights red.

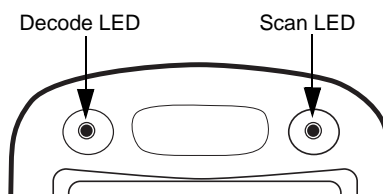

4. Center the aiming beam over the bar code; see [Dolphin 9500/Dolphin 9550 Scanning Position Options](#) on page 4-5.
5. When the bar code is successfully decoded, the decode LED lights green and the terminal beeps.
6. The bar code information is entered into the application in use.

Dolphin 9500/Dolphin 9550 Scanning Position Options

The aiming beams are smaller when the terminal is held closer to the code and larger when it is farther from the code. Symbologies with smaller bars or elements (mil size) should be read closer to the unit whereas symbologies with larger bars or elements (mil size) should be read farther from the unit.

IT4100SF, IT4100SR, and IT4100HD with Green Aiming Beam

Linear Bar Code



2D Matrix Symbol



IT4300SF and IT4300SR with High-Vis Aiming Pattern

If your Dolphin terminal is configured with the IT4300SF or IT4300SR imager, high-vis aimers frame the bar code for more intuitive aiming.



Dolphin 9501/Dolphin 9551 Scanning Position Options

For more information, see [Aiming Options](#) on page 11-2.

Capturing Images

The image-capture process is an intuitive, split-second operation for experienced users. By following the basic guidelines, new users can easily develop their own technique and, with practice, quickly learn to adapt it to different application environments.

Note: The Dolphin 9501 and Dolphin 9551 do not support image capture.

Image Preview When the imaging process is initiated, Dolphin touch screens display a preview of the object. This is a live video image of what the imager is currently viewing. The live video image has a slightly degraded appearance compared to the captured image. This is normal.

Scan Key The SCAN key captures images on both the Dolphin 9500 and Dolphin 9550 terminals. The SCAN key is the only way to capture an image on the Dolphin 9500; however, on the Dolphin 9550, you can also use the Scan Trigger on the pistol-grip handle.

Image Files The terminal is capable of saving images in a number of industry-standard file formats such as *.bmp, *.jpg and *.png. The default file format for images is a grayscale *.jpg.

The image quality and related file size are determined by the data compression method used by the software application used to take images. The average size of the image file is approximately 4-8K. However, the size of the image depends on the content of the image - the more complex the content, the larger the file size.

For the highest quality, take grayscale images.

Taking an Image

The following steps are basic guidelines for taking images:

1. Point the Dolphin terminal directly at the object. The imager points straight out the top panel.
2. To preview the image, press and hold the SCAN key.
On the Dolphin 9550, you can also press and hold the [Scan Trigger](#), page 3-6.
3. The touch screen displays a preview of the object, and the decode and scan LEDs light red.
4. Adjust the terminal's position until the object appears on the screen the way you want it to appear in the image.
5. Hold the terminal still and release the SCAN key or Scan Trigger. The scan and decode LEDs flash red, the screen flashes, and the captured image appears on the screen.



6. Unless otherwise specified by the application in use, the image is saved to the My Device folder (Start > Programs > File Explorer > My Device).

IT4300SF and IT4300SR with High-Vis Aiming Pattern

If your Dolphin terminal is configured with the IT4300SF or IT4300SR imager, you can enable the aiming pattern for imaging in the Demos.

1. Tap **Start > Demos > Imaging Demo > Options** menu > **Aimer**.
2. The aiming pattern is now enabled for imaging.

Uploading Images

Image files can be uploaded to a host PC via Microsoft ActiveSync and a Dolphin communication peripheral or your wireless radio connection.

Using the Keyboards

The Dolphin 9500 Series feature three keyboard options:

- 35-key numeric/alpha keyboard,
- 43-key alpha/numeric keyboard, and
- 56-key full alpha/numeric keyboard.

Each keyboard is backlit for easy viewing in various lighting conditions with centrally-located keys for both right- and left-hand operation. The silver background of both the keys and the overlay enhances readability.

The overlay of each keyboard is color-coded to indicate the functions performed or characters typed when the color-coded key is pressed immediately after the Red or Blue Modifier key. Each keyboard also contains function, navigation and modifier keys.

35-key numeric/alpha keyboard









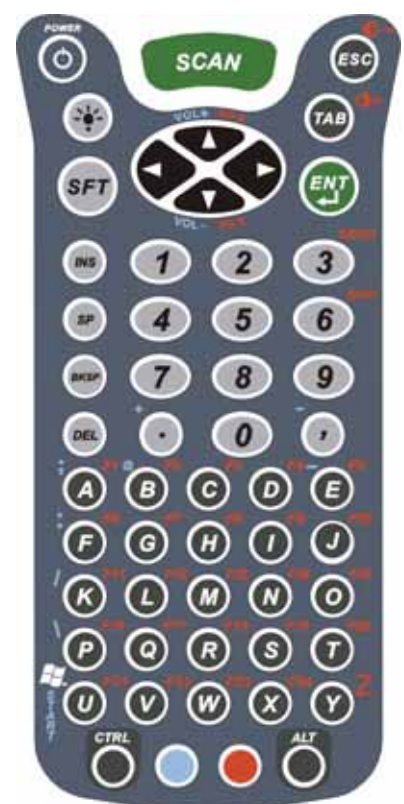

43-key alpha/numeric keyboard



56-key full alpha/numeric keyboard







Using the Function Keys

Name	Key	Function
Backlight		By default, the Backlight key turns the keyboard backlight on and off. See Adjusting the Backlight on page 4-13.
Backspace (BKSP)		This key appears on both the 35- and 56-key keyboards. The BKSP key moves the cursor back one space each time the key is pressed. If you are typing text, it deletes the previous character each time it is pressed. On the 43-key keyboard, the backspace is a shifted function; press Red + SP to backspace. To delete a single character, press Red + SP. To delete multiple characters, press Red + SP and hold the SP key.
Delete (DEL)		This key appears on both the 35- and 56-keyboard. The Delete key deletes the next character forward each time the key is pressed. On the 43-key keyboard, delete is a shifted function; press Red + the Backlight key to delete.
Enter (ENT)		The Enter key confirms data entry.
Escape (ESC)		The Escape key performs a cancel action.
Power Key		The Power key puts the terminal into and wakes the terminal from suspend mode.
SCAN Key		The SCAN key activates the scan and “wakes” the terminals from sleep mode. Its position allows convenient one-handed image-taking and/or bar code decoding.
Space (SP)		The Space key moves the cursor one space.
Tab		The Tab key moves the cursor to the next tab stop or the next control (on a form).

Using the Navigation Keys

Located in the center of each keyboard for easy access with either hand, the navigation keys enable you to navigate the cursor through an application screen. The up and down arrows can be used for page up and page down commands when pressed in combination with the red modifier key. Other functionality varies according to the application in use.

Press	To ...
	Move the cursor up one row or line.
	Move the cursor down one row or line.
	Move the cursor one character to the right.
	Move the cursor one character to the left.

Using the Modifier Keys

All three Dolphin 9500 Series keyboard options feature the standard PC keyboard modifier keys, Shift (SFT), Alt, and Control (CTRL) as well as Blue and Red modifier keys.

Name & Key	Function
Shift 	The SFT key modifies only the next key pressed; it must be pressed before each key you wish to modify. SFT toggles the keyboard between uppercase alphabet mode and lowercase alphabet mode. Use SFT toggle Caps Lock on and off by double-tapping it or by pressing SFT + the Red modifier key. When Caps Lock is toggled on, characters are uppercase; when toggled off, characters are lowercase.
CTRL and ALT	Functions of the ALT and CTRL keys depend on the software application in use and the keys pressed in combination with each.
Blue and Red	The blue and red keys are used in combination with other keys to type special characters and perform system functions. Each key modifies only the next key pressed. The overlay of each keyboard is color-coded to indicate the character typed or function performed when specific keys are pressed immediately after the blue or red modifier key.

35-Key Numeric/Alpha Keyboard

The following graphic displays the 35-key numeric/alpha keyboard.

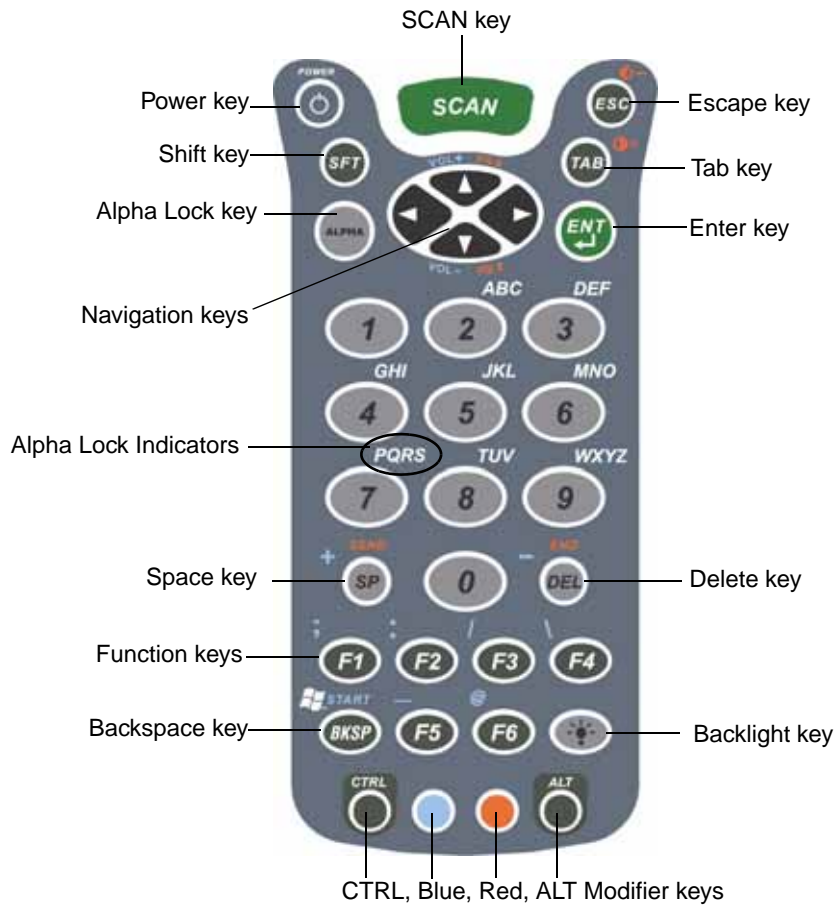

Alpha Lock Key (ALPHA)

Because the 35-key keyboard defaults to numeric mode, the Alpha Lock key appears only on the 35-key keyboard. The Alpha Lock key enables you to toggle between the numeric and alpha modes. Numeric mode is when you type numbers with the number keys. Alpha mode is when you type letters with the number keys.

On the overlay, there are alpha lock indicators above specific number keys that specify the letter that will be typed when you press that key in alpha mode. Please note that when typing in alpha mode, you must use the same multi-press method you would use when typing letters on a phone keypad. Each key press will type the next letter in the sequence as displayed in the alpha lock indicator.

43-Key Alpha/Numeric Keyboard

The following graphic displays the 43-key alpha/numeric keyboard.

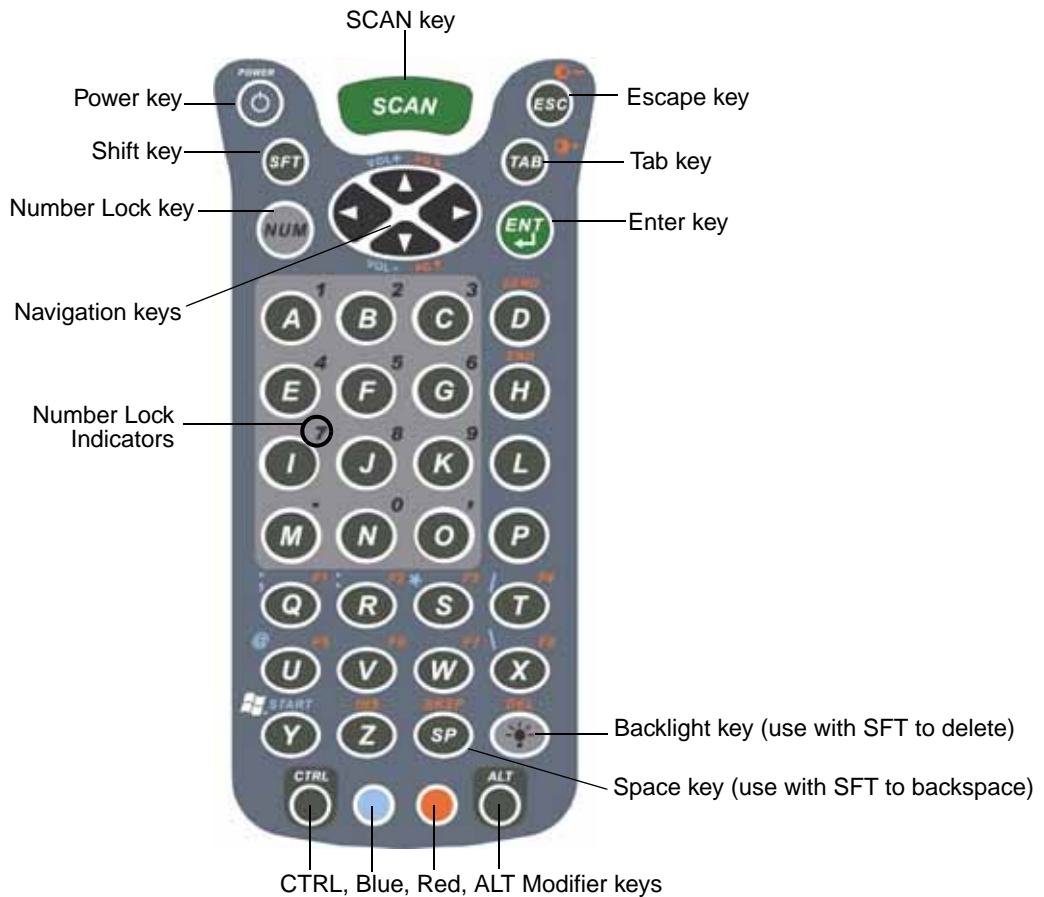

Number Lock (NUM)

Because the 43-key keyboard defaults to alpha mode, the Number Lock key appears only on the 43-key keyboard. The Number Lock key enables you to toggle between the alpha and numeric modes. Alpha mode is when you type letters with the letter keys. Numeric mode is when you type numbers with the letter keys.

The numbers on the overlay above specific letter keys indicate what number will be typed when you press that key in Numeric mode.

56-Key Full Alpha/Numeric Keyboard

The following graphic displays the 56-key alpha/numeric keyboard.

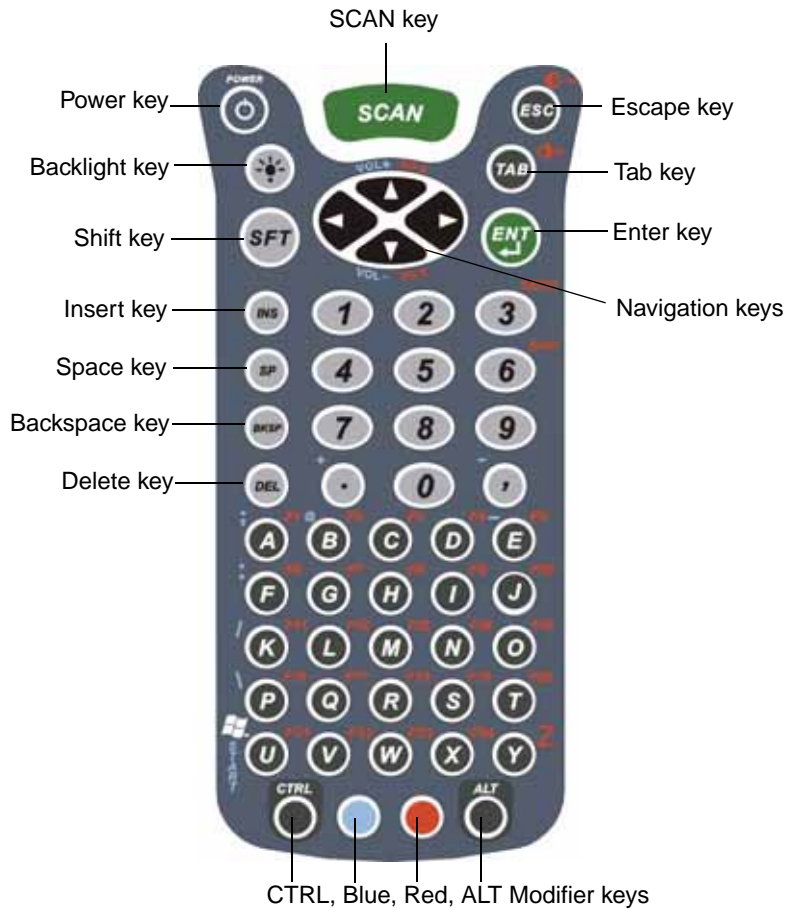

Note: To type a "Z" on this keyboard, press Red + Y.

Key Combinations

There are keyboard combinations for specific functions and special characters on each keyboard. For charts of the key combinations associated with each keyboard layout, see [Keyboard Combinations](#) on page A-1.

Adjusting the Backlight

Both the keyboard and the display are backlit to enable better viewing in low-light conditions. All keyboards contains a Backlight key that toggles the backlight on and off; see [Backlight](#) on page 4-8.

Keyboard By default, the Backlight key turns the keyboard backlight on and off for both color display and monochrome terminals.

Display Backlight functionality differs for color and monochrome displays.

Color Display

The backlight for the color display is user-defined. There are two tabs - one for Battery and the other for External power. The options on each tab are the same.

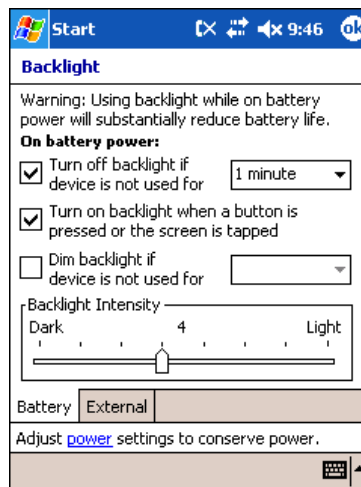

Go to **Start > Settings > System tab > Backlight**. Backlight settings open displaying the Battery tab.

From the **Turn off backlight...** drop-down list, select how many minutes you want to elapse before the backlight automatically turns off.

Select the **Turn on backlight...** option if you want the display backlight to turn on when the a button is pressed or the touch screen is tapped.

From the **Dim backlight if...** drop-down list, select how many minutes you want to elapse before the backlight dims.

Move the **Backlight Intensity** slider to set the intensity of the backlight.

Tap **OK** to save settings. The display backlight functions according to the settings saved here.

Monochrome Display

Backlight The backlight for monochrome displays turns on and off when you press the Backlight key, but not when you tap the screen.

Contrast In addition to the backlight, monochrome displays feature contrast adjustment. You can adjust the contrast using the keyboard or system settings.

Using the Keyboard

Press and hold the

- Red Modifier key + ESC to decrease the contrast
- Red Modifier key + TAB to increase the contrast



All three keyboards have red indicators over each key to indicate which key to press in combination with the red modifier key to adjust the contrast.

Using the System Settings

Tap **Start** > **Settings** > **System** tab > **Contrast**. The current settings are displayed.

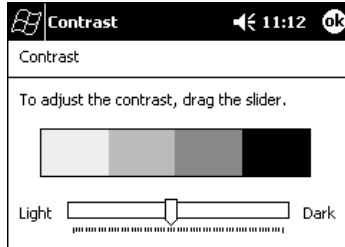

Use the slider to adjust the contrast to the desired setting.

Tap **OK** to save adjustments.

Communication Media Options

Mechanical Connector

The 17-pin, industrial-grade, mechanical connector on the bottom panel is designed to work only with communication and charging peripherals sold/manufactured by Hand Held Products. Via these peripherals, the connector supports USB and RS-232 communications, enabling the user to connect the Dolphin terminal to external devices such as scanners and printers.

For more information about the connector, see [Mechanical Connector](#) on page 3-9.

IrDA Port

The IrDA port enables the Dolphin terminals to transmit data via pulses of light to and from other IrDA-compliant devices, such as printers and PCs or to other Dolphin terminals.

For more information, see [Using Infrared](#) on page 6-5.

Wireless Radios

802.11b Radio

Dolphin 9500 Series terminals may be equipped with a WiFi®-compliant, interoperable 2.4 GHz 802.11b direct sequence spread spectrum wireless local area network (WLAN) radio.

For more information, see [Wireless LAN Communications with 802.11b](#) on page 7-1.

Bluetooth Radio

Dolphin 9500 Series terminals may be equipped with a Bluetooth wireless personal area network (WPAN) radio.

For more information, see [Wireless PAN Communications with Bluetooth](#) on page 8-1.

GSM/GPRS Radio

Dolphin 9500 Series terminals may be equipped with a GSM/GPRS wireless wide area network (WWAN) radio.

For more information, see [Wireless WAN Communications with GSM/GPRS](#) on page 9-1.

Software Communication Programs

Microsoft ActiveSync v3.7 or Higher

Microsoft ActiveSync is a tool that enables Windows Mobile devices, such as the Dolphin 9500 Series, to exchange and synchronize application data with a desktop computer.

For more information, see [Using ActiveSync](#) on page 6-2.

RAS

Short for Remote Access Services, RAS is a feature built into Windows NT that enables users to log into an NT-based LAN using a modem, X.25 connection or WAN link. RAS is fully supported and allows the use of PPP or SLIP connections for network connectivity.

Radio Options

Dolphin 9500 Series terminals can be configured with one or a combination of the following radios:

- 802.11b
- Bluetooth
- GSM/GPRS (Dolphin 9500 only)

Please note that the Dolphin 9550 supports all radio options and configurations EXCEPT FOR GSM/GPRS.

Available Radio Combinations

Dolphin 9500 Series terminals can be configured with more than one radio.

Co-located Radios

Some combinations are co-located, which means that you can use only one radio at a time. In this case, you can have both radios installed but need to power one up and the other down before operation.

- 802.11b and GSM/GPRS

Co-operational Radios

Some combinations are co-operational, which means that you can power up and operate both radios simultaneously.

- Bluetooth and 802.11b
- Bluetooth and GSM/GPRS

Radio Driver Installation

Radio drivers install during the autoinstall whenever the mobile computer is initialized; when first turned on or after a hard reset. Only the appropriate drivers for your terminal's radio configuration install. For example, if your terminal is configured only with an 802.11b radio, only the driver for that radio installs. For more information, see [Let Autoinstall Run](#) on page 2-10.

When a single radio installs, its radio driver is powered up automatically after initialization is complete. In general, when more than one radio installs, the terminal powers up the 802.11b radio. However, if a GSM radio is installed, the terminal powers up the GSM radio.

The Radio Manager

The Radio Manager is a control panel applet through which the radio power driver controls the radio state. It enables you to choose which radios on the terminal are powered up. When powered up, the radio is transmitting, when powered down, the radio is not transmitting.

Single Radio Configuration

If your terminal contains a single radio module and its associated driver is installed, operates by itself without any special configuration made to the device.

Multiple Radio Configuration

Configuration of simultaneous radio operation is done during the manufacturing process according to FCC regulations. If multiple radio modules are installed in your terminal, simultaneous operation must be configured on the device before the radio power driver allows it. In other words, verify which radio or radios are powered up or down.

Multiple Radio Operation

GSM and 802.11b are mutually exclusive. While they may both be present, they cannot be allowed to operate simultaneously. If you have modules and drivers for both radios installed on your terminal, you must ensure that one radio is powered down before using the other.

The Bluetooth radio is allowed to operate by itself or simultaneously with either of the GSM or 802.11b radios.

Powering Up a Radio

Requirements

To successfully power up a radio, both the hardware module and the software driver must be installed on the terminal. If the module is present, the radio appears in the Radio Manager. However if the driver is not installed, you cannot successfully power up the radio. Attempting to do so produces an error in the Status field that tells you that the driver is not installed.

To Power Up a Radio or Radio Combination

1. Open the Radio Manager by going to **Start > Settings > Connections tab > Radio Manager**. The Radio Manager appears identifying which radio modules are installed.
2. The highlighted entry is the radio mode that is currently enabled; its Status should be Ready.

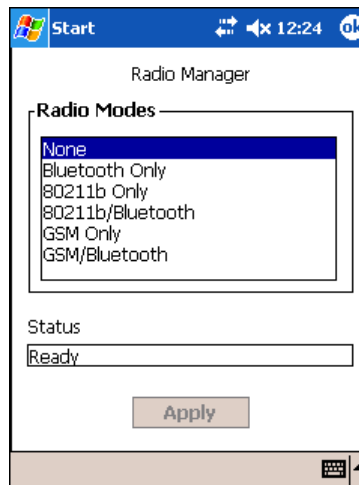

3. Select the radio in the Radio Modes list and tap **Apply**.

The radio drivers are powered down and powered up in the proper sequence. For example, if the radio powered up is Bluetooth Only and you try to switch to 802.11b Only, after **Apply** is tapped, the Radio Manager powers down the Bluetooth radio first, then powers up the 802.11b radio.

If an error occurs during this process, the radio mode change is abandoned. The resulting radio state is the status of the radios at the time the error occurred.

Radio Modes The Radio Modes section displays the radio hardware modules currently installed on the terminal. For example, if a working Bluetooth module is installed, the box contains the line Bluetooth Only whether or not that radio is currently powered up.

Status field The Status field provides feedback on the state of the radio. When it reads “Ready,” the radio selected in the Radio Modes box is powered up. The Status field displays error messages when a radio cannot be enabled.

To Power Down Radios

Radio drivers are automatically powered down if the radio or radio combination that is currently powered up requires it. To power down all radios, select **None** and tap **Apply**.

For more information about 802.11b radios, see [Wireless LAN Communications with 802.11b](#) on page 7-1.

For more information about Bluetooth radios, see [Wireless PAN Communications with Bluetooth](#) on page 8-1.

For more information about GSM/GPRS radios, see [Wireless WAN Communications with GSM/GPRS](#) on page 9-1.

Using the Soft Input Panel (SIP)

Use the SIP to enter information in any program on the Dolphin terminal. You can either type on the soft keyboard or write on the touch screen using Letter Recognizer or Block Recognizer. In either case, the characters appear as typed text on the screen.

To show or hide the SIP, tap the **Input Panel** button. Tap the arrow next to the Input Panel button to see your choices.

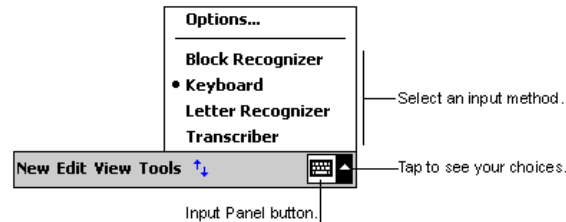

When you use the SIP, your terminal anticipates the word you are typing or writing and displays it above the input panel. When you tap the displayed word, it is inserted into your text at the insertion point. The more you use your Dolphin terminal, the more words it learns to anticipate.

To change word suggestion options, such as the number of words suggested at one time, tap **Start > Settings > Personal tab > Input > Word Completion** tab.

Using the SIP Keyboard

1. Tap the arrow next to the Input Panel button and select **Keyboard**.
2. On the soft keyboard that is displayed, tap the keys with your stylus.

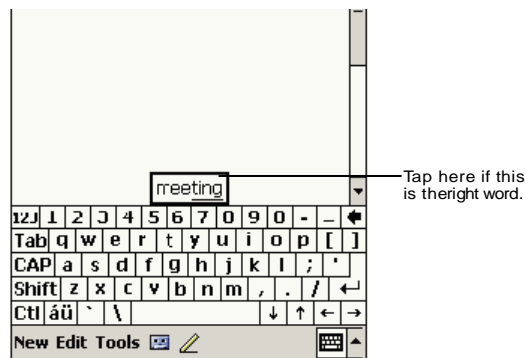

Using the Letter Recognizer

With Letter Recognizer you can write letters using the stylus just as you would on paper.

1. Tap the arrow next to the Input Panel button and then **Letter Recognizer**.
2. Write a letter in the box.

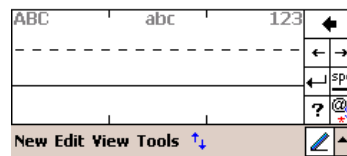

When you write a letter, it is converted to typed text that appears on the screen. For specific instructions on using Letter Recognizer, with Letter Recognizer open, tap the question mark next to the writing area .

Using the Block Recognizer

With Block Recognizer you can input character strokes using the stylus.

1. Tap the arrow next to the Input Panel button and then **Block Recognizer**.
2. Write a letter in the box.

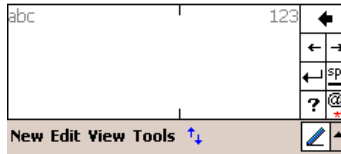

When you write a letter, it is converted to typed text that appears on the screen. For specific instructions on using Block Recognizer, with Block Recognizer open, tap the question mark next to the writing area.

Selecting Text

To edit or format typed text, select it by dragging the stylus across the text. Then, use the commands on the pop-up menu to cut, copy, and paste the selected text.

Input Panel Options

You can set input options by going to **Start > Settings > Personal tab > Input**. The following graphics are the tab windows where you can customize the input panel to your preferences:

Input Method tab

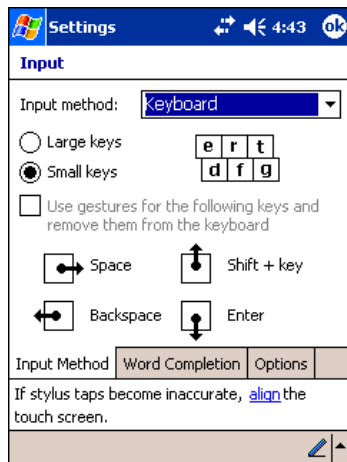

Word Completion tab

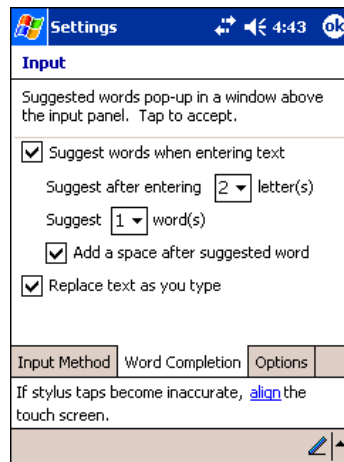

Options tab

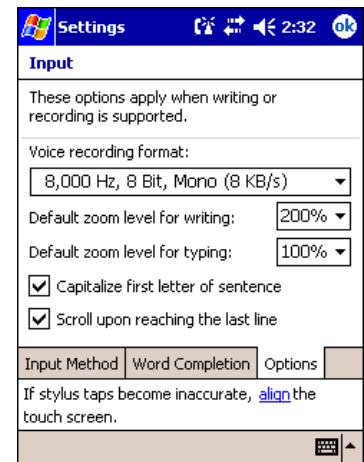

Writing on the Screen

In any program that accepts writing, such as the Notes program, and in the **Notes** tab in Calendar, Contacts, and Tasks, you can use your stylus to write directly on the screen as you would on paper. To write on the screen, tap the **Pen** button to switch to writing mode. This action displays lines on the screen to help you write.

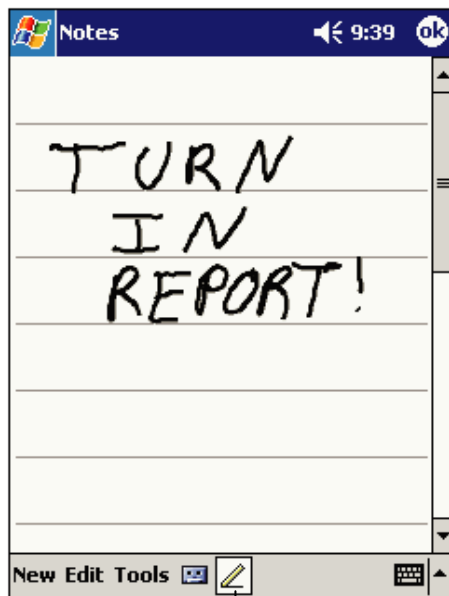

Tap the Pen button and use your stylus like a pen.

Note: Some programs that accept writing may not have the Pen button. See the documentation for that program to find out how to switch to writing mode.

To Select Writing

If you want to edit or format writing, you must select it first.

1. Tap and hold the stylus next to the text you want to select until the insertion point appears.
2. Without lifting, drag the stylus across the text you want to select.

If you accidentally write on the screen, tap **Tools**, then **Undo** and try again. You can also select text by tapping the **Pen** button to deselect it and then dragging the stylus across the screen.

You can cut, copy, and paste written text in the same way you work with typed text: tap and hold the selected words and then tap an editing command on the pop-up menu, or tap the command on the **Edit** menu.

Drawing on the Screen

Drawing on the screen is similar to writing on the screen. The difference between writing and drawing on the screen is how you select items and how they can be edited. To create a drawing, cross three ruled lines on your first stroke. A drawing box appears. Subsequent strokes in or touching the drawing box become part of the drawing. Drawings that do not cross three ruled lines will be treated as writing.

For example, selected drawings can be resized, while writing cannot.

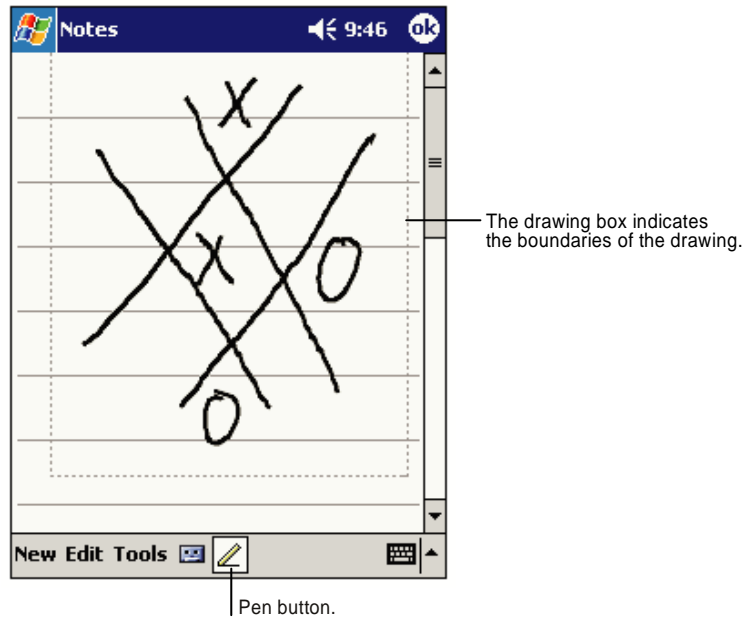









*Note: You may want to change the zoom level so that you can more easily work on or view your drawing. Tap **Tools** and then a zoom level.*

Selecting a Drawing

To edit or format a drawing, tap and hold the stylus on the drawing until the selection handle appears. To select multiple drawings, deselect the Pen button and then drag to select the drawings you want.

You can cut, copy, and paste selected drawings by tapping and holding the selected drawing and then tapping an editing command on the pop-up menu, or by tapping the command on the **Edit** menu. To resize a drawing, make sure the Pen button is not selected, and drag a selection handle.

Status Icons

Status Icon	Meaning
	Turns all sounds on and off
	Backup battery is low
	Main batteries are charging
	Main batteries are low
	Main batteries are very low
	Main batteries are full
	Synchronization is beginning or ending
	Notification that one or more e-mail messages were received

Note: The Notification icon  displays if more notification icons need to be displayed than there is room to display them. Tap the icon to view all notification icons.

Notifications

Notifications remind you when you have something to do. For example, if you've set up an appointment in Calendar, a task with a due date in Tasks, or an alarm in Clock, you'll be notified in any of the following ways:

- A message box appears on the screen.
- A sound, which you can specify, is played.

To choose reminder types and sounds, tap **Start > Settings > Personal tab > Sounds & Notifications** (see [Personal Tab](#) on page 5-2). The options you choose here apply throughout the terminal.

Finding and Organizing Information

The Find feature on your Dolphin mobile computer helps you quickly locate information. On the **Start** menu, tap **Find**. Enter the text you want to find, select a data type, and then tap **Go** to start the search.

To quickly find information that is taking up storage space, select **Larger than 64 KB in Type**.

You can also use the File Explorer to find files and organize these files into folders. On the **Start** menu, tap **Programs**, and then **File Explorer**.

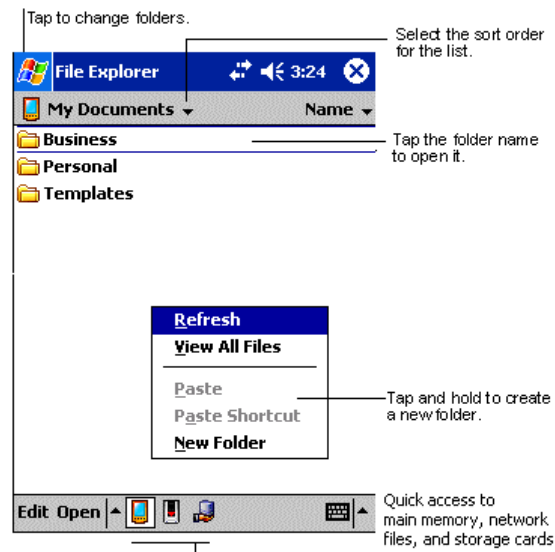

You can move files in File Explorer by tapping and holding the item you want to move, and then tapping **Cut** or **Copy** and **Paste** on the pop-up menu.



Overview

Customized settings are available on the Start menu - go to **Start > Settings** and settings screen opens. Settings consists of three tabs: Personal, System, and Connections.

Personal Tab

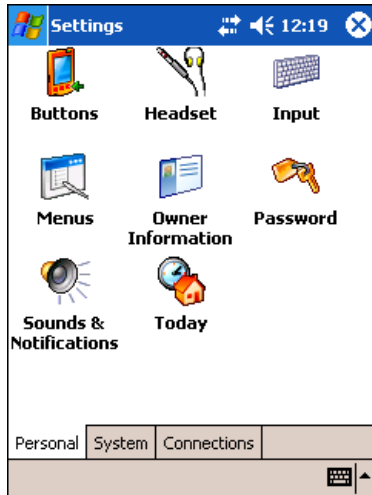

System Tab

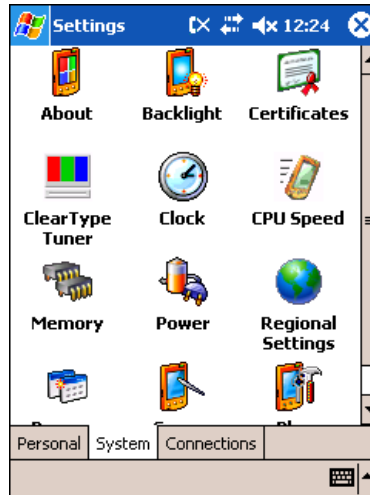

Connections Tab

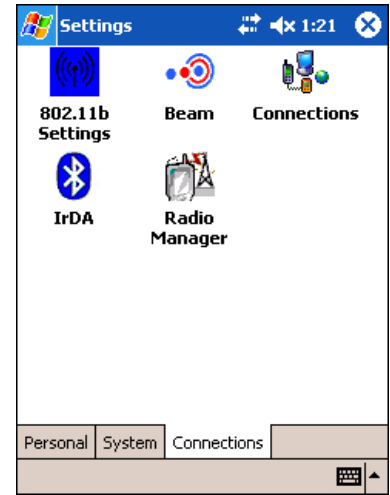

Tab

Personal

This tab enables you to ...

Customize buttons, set SIP options, and adjust headset settings; see [Personal Tab](#) on page 5-2..

System

Adjust system settings; see [System Tab](#) on page 5-6..

Connections

Establish network connections settings; see [Connections Tab](#) on page 5-15..

Personal Tab

To access the Personal tab, go to **Start > Settings**. The screen opens displaying the Personal tab.

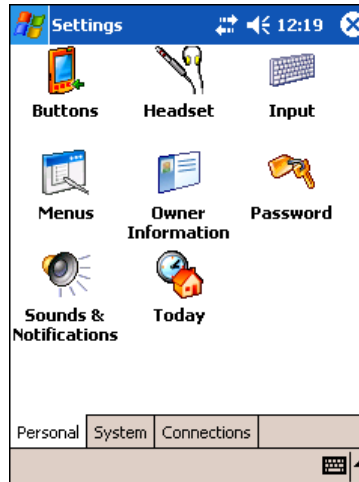

Button Name	Tapping this icon enables you to ...
Buttons	Customize buttons to perform functions. To use this setting, the HotKeys Utility must be initialized. Tap Start > Utils > HotKeys (the icon is the same). The HotKeys utility initializes. Return to the Personal tab and tap Buttons .
Headset	Adjust audio settings for headset use; see Headset Control on page 5-5..
Input	Customize the SIP. For details, see Input Panel Options on page 4-19.
Menus	Customize what appears on the Start and New menus; see Modifying the Start Menu on page 5-3..
Owner Information	Enter your contact information.
Password	Password protect the terminal to limit access to your device.
Sounds & Notifications	Set the sound volume, enable and disable sounds for specific actions, and set sound parameters for system notifications.
Today	Customize the look and information that is displayed on the Today screen.



Personal settings are stored in RAM memory. They are replaced by system defaults after each hard reset. For more information about resets, see [Soft Reset \(Warm Boot\)](#) on page 2-12..

Modifying the Start Menu

You can add existing programs you use often, such as File Explorer, to the Start menu for faster access. You are not installing or moving the program, you are simply creating a shortcut to it from the Start menu.

Using System Settings

1. Tap **Start > Settings > Personal tab > Menus > Start Menu** tab.



2. Select the program you want to add and tap **OK** to save.
3. Tap the **Start** menu.
4. Verify that the shortcut to the program appears on the Start menu.

*Note: You can also remove shortcuts from the Start menu by de-selecting them here and tapping **OK**.*

Using File Explorer

You can use File Explorer to place a shortcut to a program on the Start menu.

Note: We recommend that you Copy and Paste Shortcut so that you do not alter your program configurations by accident. If you Cut and Paste the program, you will be removing the program from its proper location. Using Copy and Paste Shortcut ensures that the program files remain where they need to be to function properly.

1. Tap **Start > Programs > File Explorer**. File Explorer opens to My Documents by default; to see a list of all folders, tap the folder name and then **My Device**.

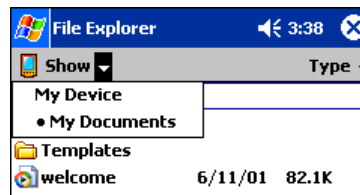

2. Navigate to the program.
3. Tap and hold on the program, then tap **Copy** on the pop-up menu.

-
4. Navigate to the Windows folder and open the Start Menu (**My Device > Windows > Start Menu**), tap and hold a blank area of the window, and tap **Paste Shortcut** on the pop-up menu.

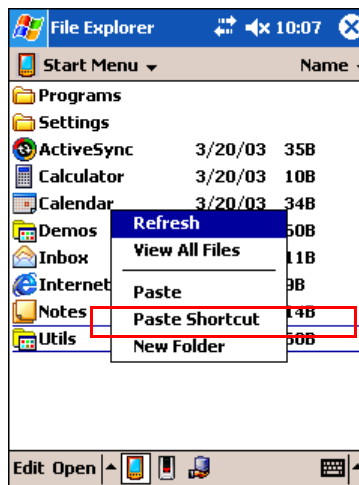

5. Tap the **Start** menu.
6. Verify that the shortcut to the program now appears on the Start menu.

Using ActiveSync on the Desktop Computer

You can use the Explore feature of ActiveSync on your desktop computer to navigate through the files on your Dolphin terminal. The process is essentially the same, except that you are using Windows Explorer utility to create and paste shortcut.

1. Go to **ActiveSync > Explore**.
2. Navigate to the program.
3. Right-click on the program and select **Create Shortcut**.
4. Select the shortcut, right-click, and select **Cut**.
5. Navigate to the **Start Menu** folder (Windows > Start Menu).
6. Right-click on an empty area and select **Paste**.
7. On the terminal, tap the **Start** menu.
8. Verify that program appears on the Start menu.

See ActiveSync Help for more information about using ActiveSync.

Headset Control

The Headset Control setting enables you to adjust audio settings while using a headset.

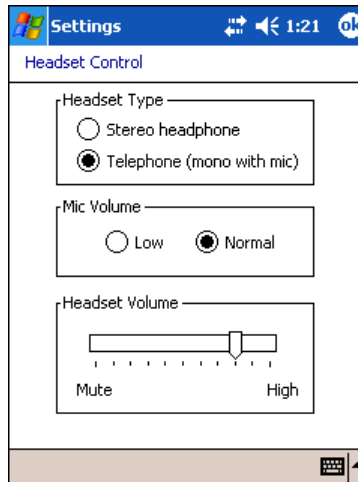

Headset Type

Stereo headphone

Select this option if you are using a headset for audio output only. If so, you need to use the microphone on the terminal ([Microphone](#), page 3-5) for audio input; i.e., listen via the headset and speak into the microphone. These types of headsets usually contain two earpieces for stereo sound. Tap **OK** to save your selection.

Telephone (mono with mic)

Select this option if you are using a headset that also contains a microphone. When this option is selected, you speak into the microphone on the headset and not the microphone on the terminal. These types of headsets usually have one earpiece for mono audio. Tap **OK** to save your selection.

Mic Volume

These options enable you to adjust the audio level of the microphone. Normal is the default setting. If this is too loud for the listener, you can change the setting to Low.

These settings apply to the selected Headset Type. When you select Stereo headphone, the volume on the terminal's microphone ([Microphone](#), page 3-5) adjusts. When you select Telephone (mono with mic), the volume on the headset's microphone adjusts.

This Mic Volume setting does **not** work if you are using a GSM radio for two-way voice communication. For more information about microphone volume with GSM, see [Settings Menu](#) on page 9-11..

Tap **OK** to save your selection.

Headset Volume

The slider enables you to adjust the speaker volume (audio output) of the headset. Move the slider from Mute to High depending on your preference. The volume adjusts automatically as you move the slider. These headset volume settings apply to both Headset Types.

System Tab

The System tab enables you to verify and sometimes alter system parameters. To access the System tab, go to **Start > Settings > System** tab. Tap the appropriate icon to open that system setting.

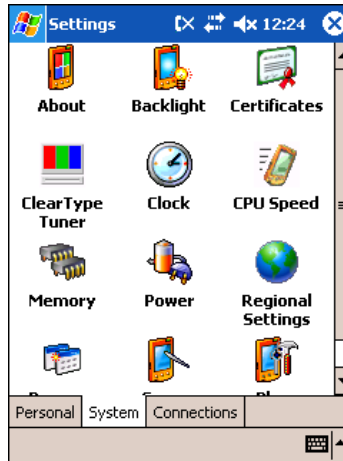

About

The About system setting displays specific information about what is loaded on the terminal. It contains three tabs: Version, Device ID, and Copyrights.

Version tab Displays the information about the software, operating system, and processor of the terminal.

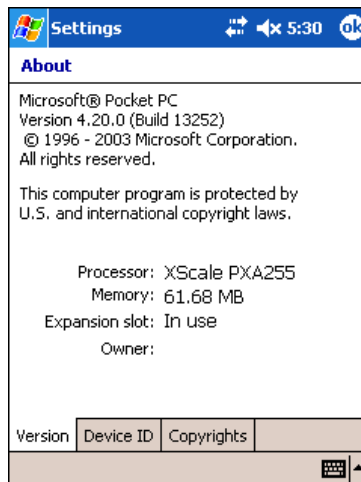

Device ID tab Displays the information the terminal uses to identify itself to other devices. It can be important to know this information if the Dolphin terminal is going to be part of a networked system of devices.

Device name: Displays the system's default name. This is the name used by ActiveSync.

Description: Displays the description of the device ID.

Copyrights tab Displays important copyright information.

Backlight

The Backlight system setting enables you to customize backlight functionality for the display. For more information, see [Adjusting the Backlight](#) on page 4-13.

ClearType Tuner

Dolphin 9500 Series terminals displays support ClearType font rendering. ClearType is a Microsoft technology that increases the readability of text on LCD displays.

After you enable ClearType font rendering in the Screen setting ([Screen](#), page 5-14), you can adjust the render level. Use the slider to adjust the appearance of the sample type on the screen and tap **OK**.

For more information about ClearType font rendering, visit: www.microsoft.com/typography/cleartype/what.htm?fname=%20&fsize=

Clock

This setting sets the system clock. Appointments, scheduled events, and any function on a schedule runs off this setting. You need to set the time zone and time after each hard reset; see [Set the Time and Date](#) on page 2-10.

CPU Speed

This system setting enables you to see and change the current speed of the Central Processing Unit (CPU).

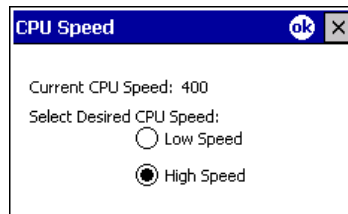

The default is **High Speed** at 400MHz. **Low Speed** is 200MHz. To change the default, select Low Speed and tap **OK**. A message appear confirming the changed and now current CPU speed.

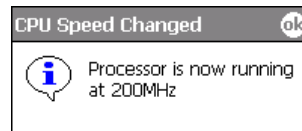

Tap **OK** to save the change.

Memory

The Memory system setting enables you to review and manage both RAM (volatile) and IPSM/Storage Card (non-volatile) memory. Dolphin 9500 Series terminals contain 64MB of on-board, volatile RAM memory.

Open the Memory setting whenever you receive system messages about memory.

There are three tabs: Main, Storage Card, and Running Programs.

Main tab This tab displays the available, in use, and remaining RAM memory used for running and storing programs as well as storing program data.

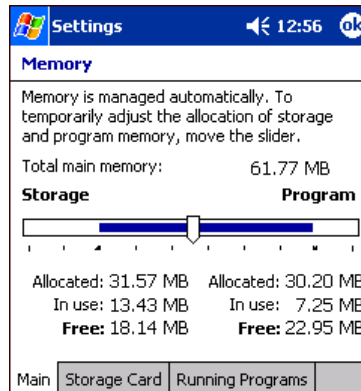

Field	Description
Total main memory	Total RAM memory.
Storage	RAM memory being used for storing programs and program data.
Program	RAM memory being used to run programs.
Fields Under Storage and Program	
Allocated	Displays the current amount of RAM memory allocated for Storage vs. Program use.
In use	Displays the current amount of RAM memory being used by Storage vs. Program memory functions.
Free	Displays the current amount of RAM memory available for Storage and Programs use.

To Increase/Decrease RAM Memory

To increase Program or Storage memory, tap, hold, and drag the slider towards the kind of memory you want to increase. The three fields adjust automatically; Program memory decrease when you increase Storage memory and vice versa.

Storage Card tab

This tab displays the current capacity and usage statistics of the selected memory type - IPSM or Storage Card. Select the memory type from the drop-down list; IPSM is selected by default.

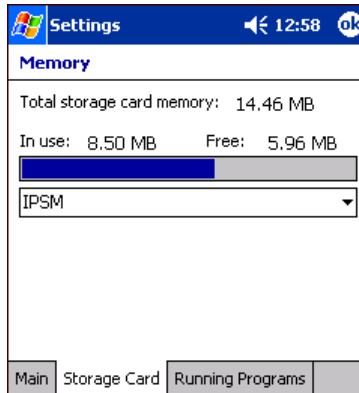

Total storage card memory

The total memory of the memory type selected in the drop-down list.

In use

The amount of memory being used by the selected memory type.

Free

The free memory available of the selected memory type.

IPSM

Short for Intel Persistent Storage Manager, this is the 14MB of on-board Flash memory that is non-volatile. Because this memory is non-volatile, data or programs stored in IPSM are not affected when power is removed. Autoinstall programs, for example, are stored in IPSM so that they are always installed at cold-boot startup.

When IPSM is selected in the drop-down list, the Storage Card tab displays the IPSM memory capacity and usage statistics.

Storage Card

You can install additional memory in Dolphin terminals - see [SD Memory](#) on page 3-8. If a storage card is installed in the terminal, Storage Card appears in the drop-down list.

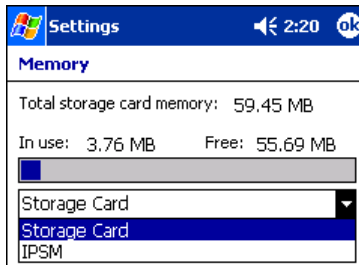

Select **Storage Card** and the Storage Card tab displays the current capacity and usage statistics of the installed storage card.

Running Programs tab

Displays the software programs currently using Storage memory.

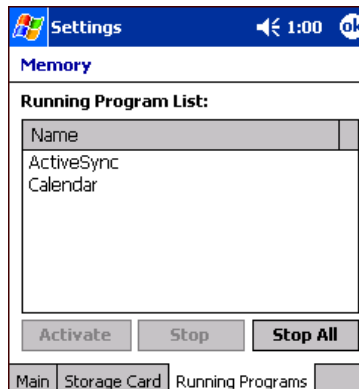

Check this tab when you are receiving out of memory errors or when the mobile computer is running slowly. You can

- Select a program in the list and tap **Stop** to stop it from running (and therefore from using memory), or
- Tap **Stop All** to automatically stop all running programs.



Anytime you stop a running program, it frees up RAM memory. Be advised that, when you stop a program here, any unsaved data in that program is lost. To free up memory without risking data loss, return to the running program, save your data, and close the application.

Links at the Bottom of the Memory Tabs

At the bottom of all three Memory tabs are two links:

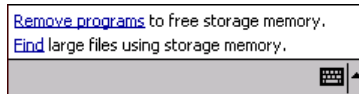

Remove programs

Opens the Remove Programs system setting. For details, see [Remove Programs](#) on page 5-13.

Find

Enables you to search for large files using storage memory. It opens the Find screen with **Larger than 64KB** already selected in the **Type** field.

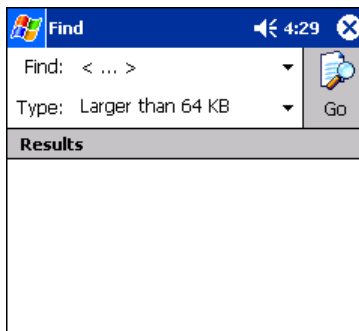

Power

Power system settings contains three tabs: Battery, Wireless, and Advanced.

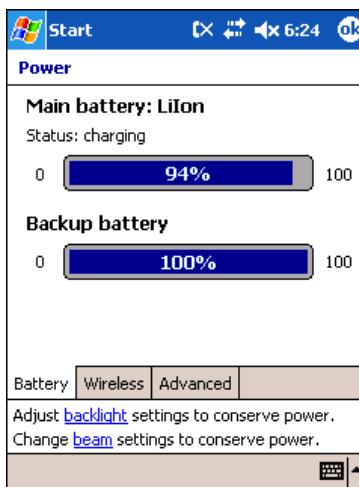

Tab

This tab enables you to ...

Battery Tab

Check the remaining charge of both the main and backup batteries. For more information about the terminal's batteries, see [Batteries](#) on page 3-10.

Tab

This tab enables you to ...

Wireless Tab

Determine the power settings for your wireless connection.

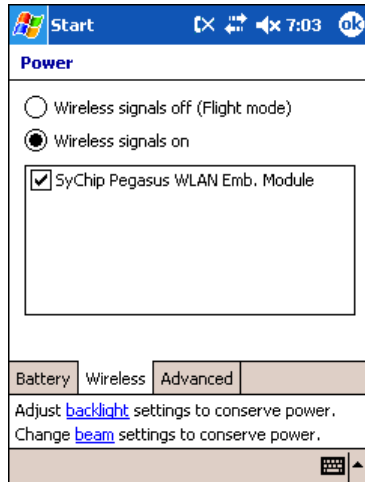

Select **Wireless signals off...** when you don't want to use system power to power up the radio(s).

Select **Wireless signals on** when you want the radio to use system power to transmit. This is the default setting. The list contains the radio firmware installed in the terminal. The selected items are the items using system power.

Advanced Tab

Determine power time-outs.

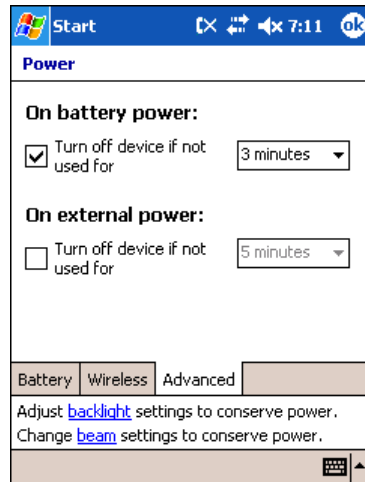

For **On battery power**, select from the drop-down list, the number of minutes of inactivity you want to pass before the terminal powers off when running on battery power.

For **On external power**, select from the drop-down list, the number of minutes of inactivity you want to pass before the terminal powers off when running on external power.

Options below the tabs

Adjust backlight... opens the Backlight settings so that you can make adjustments to conserve power usage; see [Backlight](#) on page 5-6..

Change beam... opens beam settings so that you can make adjustments to conserve power usage; see [Using Infrared](#) on page 6-5.. (You would turn off receiving capabilities to conserve power.)

You can also set automatic turn-off times for the terminal to conserve power. When the device is "turned off," that means that it goes into suspend mode. For more information on suspend mode, see [Suspend Mode](#) on page 2-12.

Regional Settings

Regional Settings enables you to customize the appearance and formatting to your geographic region. Specifically, you can customize numbers (number of decimal places allowed, for example), currency (using the \$ or € symbol, for example), time, and date. These specifications apply to all screens, including the Today screen.

The Region tab displays an overview of the region selected in the drop-down list at the top.

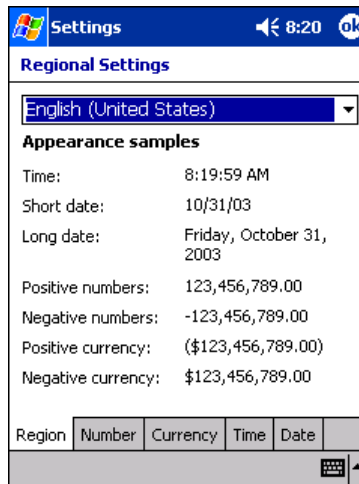

The terminal is loaded with a number of pre-programmed regional settings. Select one from the list.

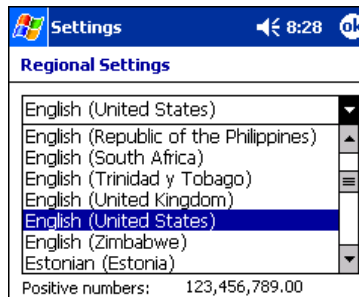

The results appear on the screen.

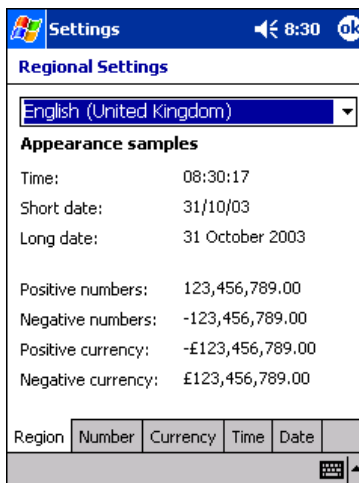

To see specific settings or change a specific setting, tap on one of the tabs, make the change and tap **OK** to save it.

Remove Programs

The Remove Programs settings enables you to remove programs installed on the terminal. Use this setting to troubleshoot when you receive messages that the device is out of memory. The programs removed are removed from RAM memory. Any program (usually *.cab or *.dll files) stored in the Autoinstall folder (My Device > IPSM > Autoinstall) will re-install after the next hard reset.

For information about the Autoinstall process, see [Let Autoinstall Run](#) on page 2-10.

For information about the hard reset process, see [Hard Reset \(Cold Boot\)](#) on page 2-12.

To Remove Programs

1. Tap **Remove Programs**. In the list, select the program you want to remove.

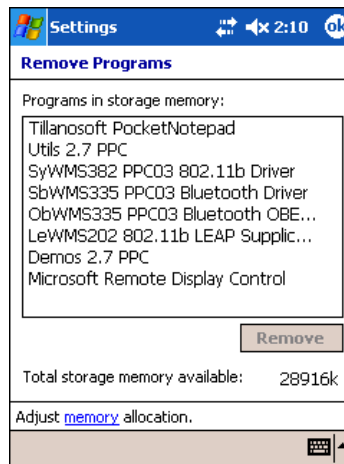

2. Tap **Remove**. The following message appears:

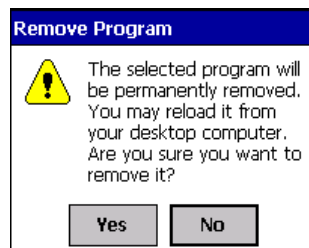

3. Tap **Yes**. Wait while the program is removed.
4. Verify that the program no longer appears in the list.

Memory

For more detailed memory information, tap **memory** of "Adjust memory allocation." The Memory system setting opens. For information about memory settings, see [Memory](#) on page 5-8.

Screen

The Screen setting enables you to re-align the screen at any time. You would need to re-align the screen if tapping buttons or icons with the stylus no longer seems to work appropriately.



Align Screen

Tap this button to re-align the screen; see [Align the Screen](#) on page 2-9..

ClearType

Select **Enable ClearType** to enable ClearType font rendering. You will need to perform a soft reset for the change to take effect. After ClearType font rendering is enabled, you can adjust the render level in the ClearType Tuner setting. For more information, see [ClearType Tuner](#) on page 5-7..

Input Options

Tapping **input** opens the input panel settings; see [Input Panel Options](#) on page 4-19..

uPhone Settings

If you have a GSM/GPRS radio installed on your terminal the uPhone Settings icon appears on the System tab. For details, see [uPhone Configuration](#) on page 9-20..

Connections Tab

The Connections tab enables you to manage your network connections.

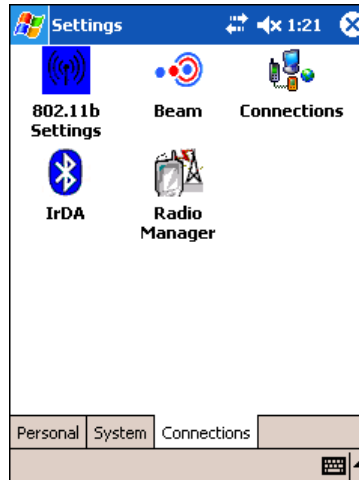

- Beam** Enables you to verify and adjust the infrared settings of the IrDA port. For details, see [Using Infrared](#) on page 6-5..
- Connections** Enables you to configure network connections; this is the connections manager. For details, see [Connections Tab](#) on page 5-15..
- Radio Manager** Enables you to power up and power down the radios installed on the terminal. For details, see [The Radio Manager](#) on page 4-16.
- 802.11b Settings** This icon appears **only** if an 802.11b radio is installed on the terminal. Tapping the icon enables you to configure your 802.11b radio. For details, see [Wireless LAN Communications with 802.11b](#) on page 7-1.
- IrDA** This icon appears **only** if a Bluetooth radio is installed on the terminal. Tapping the icon enables you to disable or enable the IrDA port. For details, see [Verify That the IrDA Port is Enabled](#) on page 6-5..
- uPhone GPRS** This icon appears **only** if a GSM/GPRS radio is installed on the terminal. Tapping the icon opens GPRS settings. For details, see [GPRS Connection](#) on page 9-25..

Server-Assigned IP Addresses

Please note that all server-assigned IP addresses use Dynamic Host Configuration Protocol (DHCP).

Zero-Config Wi-Fi

Please note that the zero-config Wi-Fi feature of Windows Mobile is **disabled** on Dolphin 9500 series mobile computers.

Creating a Wireless Network Connection

On Dolphin 9500 Series terminals, wireless networks need to be configured according to the radio installed in the terminal.

For more information about 802.11b radios, see [Wireless LAN Communications with 802.11b](#) on page 7-1..

For more information about Bluetooth radios, see [Wireless PAN Communications with Bluetooth](#) on page 8-1..

For more information about GSM/GPRS radios, see [Wireless WAN Communications with GSM/GPRS](#) on page 9-1..

Accessing the Connections Manager

To open the connections manager, tap the **Connections** icon. The connection manager opens displaying the Tasks tab.

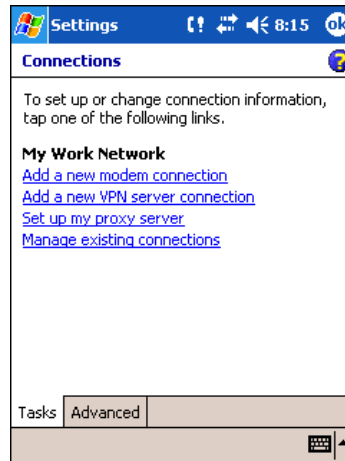

The connections manager consists of two tabs: Tasks and Advanced

Task tab The Task tab enables you to configure and manage your My Work Network settings. Click on the link to setup or manage existing network accounts.

Advanced tab The Advanced tab enables you to configure and manage network parameters and network cards.

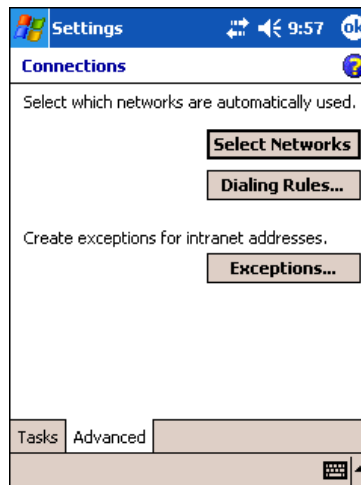

Creating an External Modem Connection to an ISP

1. Obtain the following information from your ISP:
 - ISP dial-up access telephone number,
 - user name,
 - password, and
 - TCP/IP settings.
2. Use a NULL modem cable to connect to an external modem.
3. Tap **Start > Settings > Connections** tab > **Connections > Task** tab.

4. Tap **Add a new modem connection**. The Make New Connection screen appears.

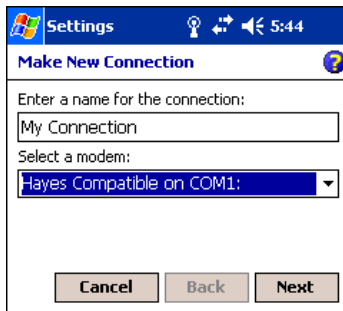

5. **Enter a name for the connection**, such as "My Connection."
6. In the **Select a modem** list, select the external modem by selecting **Hayes Compatible on COM1**.
7. Tap **Next**. The My Connection screen appears.

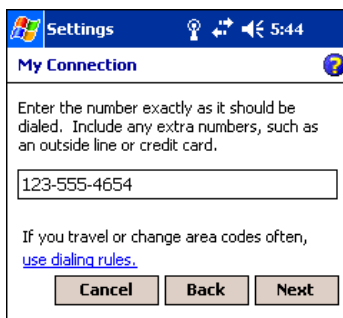

8. Enter the number that should be dialed when connecting to your ISP. Include any special digits such as "*" or "#" (see [Establishing Dialing Rules](#) on page 5-24.). Tap **Next**.

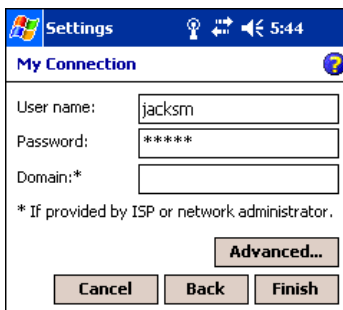

9. Now enter any authentication information your ISP requests.
10. You should not need to change any settings in **Advanced** because most ISPs now use a dynamically-assigned addresses. See [Advanced Settings](#) on page 5-18.
11. Tap **Finish** to complete this wizard.

Advanced Settings

General Tab

Use the General tab to change the connection speed of your connection. Wait for dial tone before dialing, then wait for credit card, add dial-string modem commands, or cancel call after a set number of seconds.

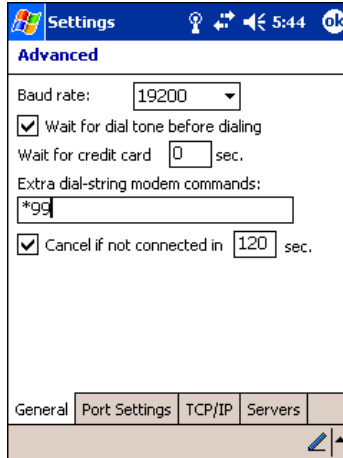

Port Settings Tab

The Port Settings tab has options that should be left alone unless indicated otherwise by your ISP.

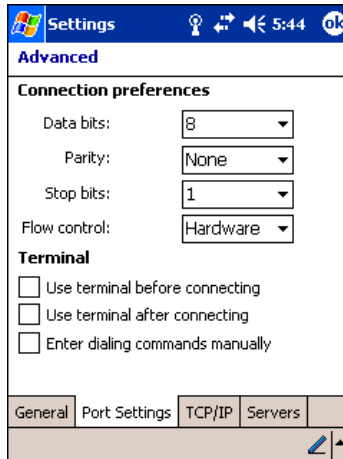

TCP/IP Tab

If your ISP does not use a dynamically-assigned address, enter that information into the TCP/IP tab.

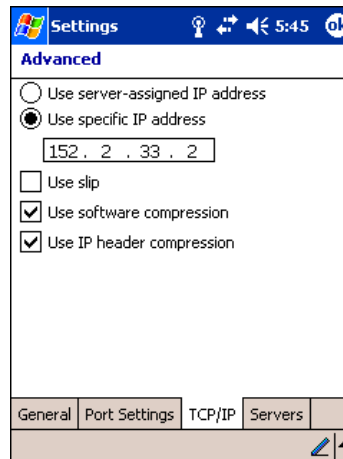

Servers Tab

Finally, if your ISP requires special DNS or WINS information, enter it into the Servers tab.

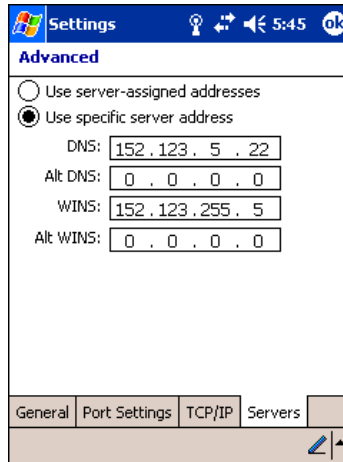

Connecting to Your ISP

1. Tap **Start > Settings > Connections** tab > **Connections** to open the connections manager.
2. Tap **Manage existing connections**.



3. Tap and hold on the applicable dial-up settings and select **Connect**.
(You can delete the connection by selecting Delete.)
4. Your modem will dial-out and attempt to create the connection.

Creating an External Modem Connection to Your Work

Follow the instructions for [Connecting to Your ISP](#), but select **Add a new modem connection** under **My Work Network**.

Establishing Exceptions for Work URLs

Some companies use periods in their intranet URLs (for example, intranet.companyname.com). If you attempt to connect to one of these URLs, Pocket Internet Explorer will search for the website on the Internet rather than the company's intranet.

To connect to such intranet URLs, they need to be entered as Work URL exceptions in the connections manager.

1. Go to **Start > Settings > Connections** tab > **Connections > Advanced** tab (see page 5-16).
2. Tap **Select Networks**.

3. Tap **Exceptions**. The Work URL Exceptions screen opens.

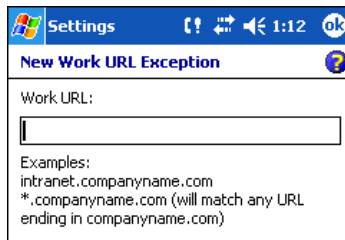

4. Tap **Add new URL** to add a new exception.

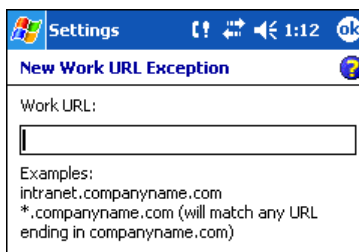

5. Enter the **Work URL** and tap **OK**.

Setting up a Proxy Server Connection for Work Connections

If you are connected to your ISP or private network during synchronization, the terminal should download proper proxy settings during synchronization from your PC. If these settings are not on your PC or need to be changed, ask your ISP or network administrator for the proxy sever name, server type, port, type of Socks protocol used, and your user name and password.

1. Go to **Start > Settings > Connections** tab > **Connections**.
2. Under the My Work Network heading, tap **Set up my proxy server**.

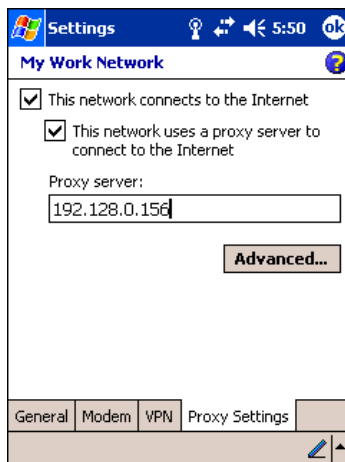

3. Select **This network connects to the Internet** and **This network uses a proxy server...**
4. In the **Proxy server** field, enter the proxy server name.

- Tap **Advanced** for advanced settings. This information can be provided only by your network administrator.

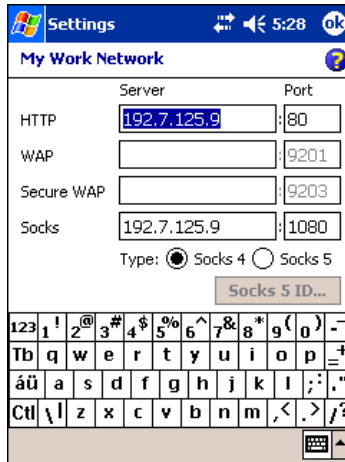

5. To change existing settings, under My Work Network, tap **Manage existing connections** and tap the **Proxy** tab.

Setting Up a VPN Connection for Work Connections

A VPN connection helps you securely connect to servers, such as a corporate network, via the Internet. Ask your network administrator for your user name, password, domain name, TCP/IP settings, and host name or IP address of the VPN server.

1. Go to **Start > Settings > Connections** tab > **Connections**.
2. Under the My Work Network heading, tap **Add a new VPN server connection**.

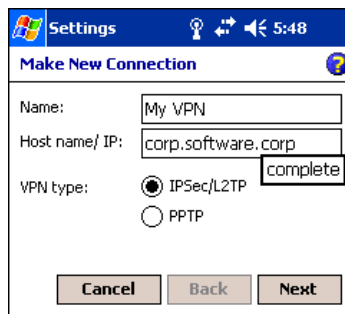

3. Enter the requested information including VPN type and tap **Next**.



4. Indicate whether a pre-installed certificate should be used or rather a pre-shared key and tap **Next**.

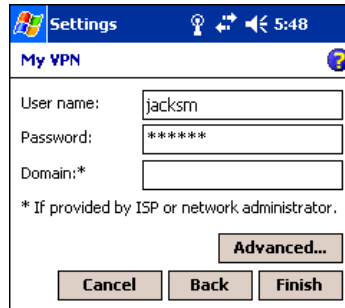

5. Enter your login details. If finished, tap **Finish** to complete VPN setup.

6. Otherwise, tap **Advanced** to access more options.

- Enter **TCP/IP** settings in the first tab; server-assigned IP addresses use DHCP.

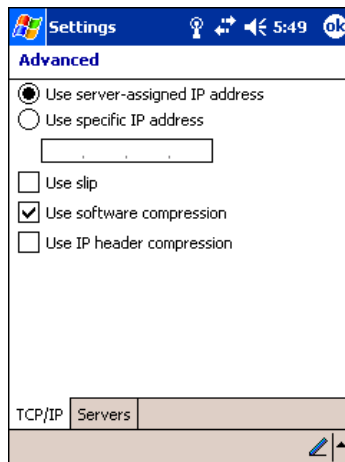

- Enter Server DNS/WINS information in the **Servers** tab.

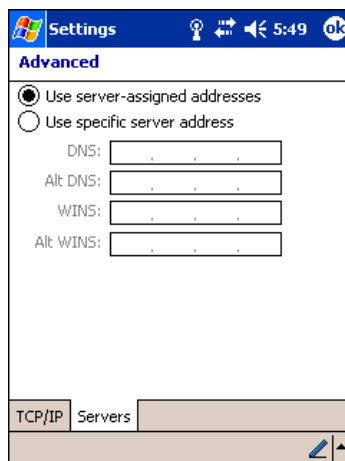

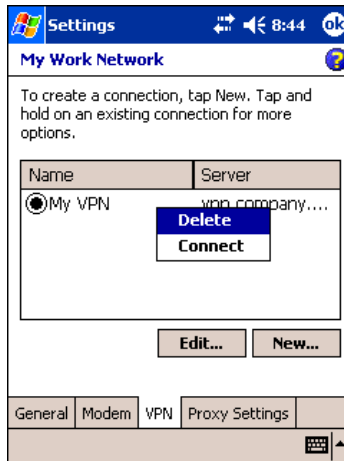

Connecting to a VPN Server

1. Go to **Start > Settings > Connections** tab > **Connections**.
2. Select **Edit my VPN servers**.

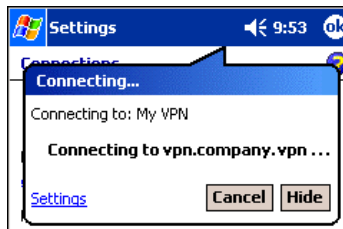

3. Tap and hold on the server, then select **Connect** on the popup menu.
(Note that through this screen you can delete your VPN server connection.)



1. Your VPN Server is accessed. When connected, tapping on the  icon displays the following bubble:

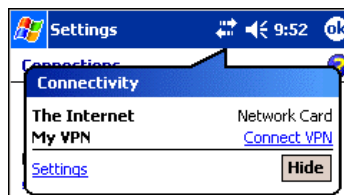

Establishing Dialing Rules

1. Tap **Start > System > Connections** tab > **Connections > Advanced** tab (see page 5-16).
2. Tap **Select Location**.

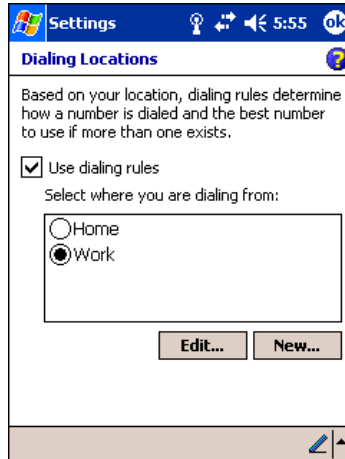

3. Select **Use dialing rules**. By default two dialing rules profiles exist: Home and Work.
4. Tap **Edit** to configure either profile.
(You can define your own dialing profile by tapping **New**. A warning appears that your existing modem connections must include the correct country and region area code settings.)



5. Tap **OK** to confirm. Enter the appropriate information on the next screen.

The screenshot shows a mobile settings application. At the top, the title bar reads 'Settings' with a Windows logo on the left and signal, Wi-Fi, and battery icons on the right, along with the time '5:55' and an 'ok' button. Below the title bar, the screen is titled 'Work'. There are several input fields: 'Name:' with the text 'Work', 'Country code:' with '1', and 'Area code:' with '123'. Below these are two checkboxes: 'Disable call waiting:' which is checked and has a dropdown menu showing '*70,', and 'Pulse dialing' which is unchecked. At the bottom of the main content area is a button labeled 'Dialing Patterns...'. At the very bottom of the screen is a bar with the word 'Edit' and a pencil icon.

6. Tap **Dialing Patterns** to change how dialing occurs.

The screenshot shows the 'Dialing Patterns' settings screen. The title bar is the same as in the previous screenshot. The screen is titled 'Dialing Patterns'. It contains three input fields: 'For local calls, dial:' with the text '9,G', 'For long distance calls, dial:' with '9,1FG', and 'For international calls, dial:' with '9,011,EFG'. At the bottom, there is a legend: '(E,e = country code; F,f = area code; G,g = number)'. The screen also has the same 'Edit' bar at the bottom.

7. Following the format of "e" represents country code, "f" represents area code, and "g" represents the number, enter how local, long distance, and international calls should be dialed. Tap **OK** to save your changes.

Configuring Network Cards

To see the network cards installed on your terminal, tap **Start > Settings > Connections > Advanced** tab (see page 5-16) > **Network Card**.

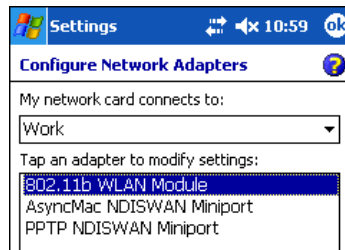

Tap on an adapter to review its settings. Server-assigned IP addresses use DHCP.

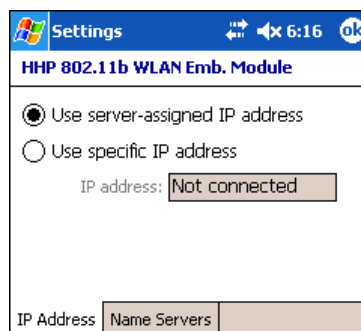

If you make any changes on these tabs, you must tap **OK** to save the changes, then perform a soft reset to update the registry. After you tap **OK**, the following message appears:

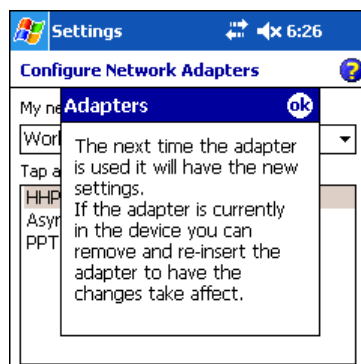

Tap **OK** again to save any changes.

For details about performing a soft reset, see [Soft Reset \(Warm Boot\)](#) on page 2-12.. During the soft reset, the new registry entries created by the changes can be read by the applications that need them.



Do **NOT** perform a hard reset (see [Hard Reset \(Cold Boot\)](#) on page 2-12) after modifying an adapter here. Hard resets return the terminal to factory defaults.

Overview

You can exchange information between your Dolphin 9500 Series terminal and other mobile devices, a desktop computer, a network, or the Internet. You have the following connection options:

- Connect to your desktop computer and synchronize via Microsoft ActiveSync v3.7 or higher.
- Use the infrared (IrDA) port to send and receive files between two devices.
- Connect to your ISP.

Connecting

More information on the procedures described here, as well as information on additional procedures, can be found in the following locations:

- ActiveSync Help on the desktop computer. In ActiveSync, click **Help > Microsoft ActiveSync Help**.
- See [Inbox](#) on page 10-7.
- Online Help. Tap **Start > Help > View menu > All Installed Help > Inbox or Connections**.

For more information, go to the Windows Mobile software website at: www.microsoft.com/windowsmobile/products/pocketpc/

Installing Additional Software

In addition to the default programs installed on your terminal when it is first booted up, you can install any program (created for a Windows Mobile device), as long as the terminal has enough memory to store the program and the program has an *.exe, *.cab, or *.dll extension.

The most popular place to find software on the Windows Mobile website: www.microsoft.com/windowsmobile/products/pocketpc/



*When selecting programs, verify that the program and version of the program are designed for the Windows Mobile and your processor. You can verify your processor by tapping **Start > Settings > System tab > About > Version tab**. Make a note of the information in the **Processor** field.*

You can install additional software via:

- ActiveSync - see page 6-4.
- Infrared - see page 6-5.
- The Internet (via wireless radio) - see page 6-8.

Using ActiveSync

Using Microsoft ActiveSync, you can synchronize information in Microsoft Outlook or Microsoft® Exchange Server on your desktop computer with your Dolphin 9500 Series terminal. You can also synchronize this information directly with a Microsoft Exchange server.

Synchronization compares the data on the desktop computer and the terminal and updates both with the most recent data so that the information on both is identical.

You can:

- Update the information in Microsoft Pocket Outlook® on your device by synchronizing it with Microsoft Outlook on your desktop computer.
- Synchronize Microsoft Word and Microsoft Excel files between your device and desktop computer. Your files are automatically converted to the correct format.

The most current version of ActiveSync can be downloaded from www.microsoft.com.

Additional Capabilities

With ActiveSync, you can also:

- Back up and restore your device data.
- Copy (rather than synchronize) files between your device and desktop computer.
- Control when synchronization occurs by selecting a synchronization mode. For example, you can synchronize continually while connected to your desktop computer or only when you choose the synchronize command.
- Select which information types are synchronized and control how much data is synchronized. For example, you can choose how many weeks of past appointments you want synchronized.

Requirements

To synchronize, ActiveSync version 3.7 or higher *must* be installed on both your desktop computer and Dolphin 9500 Series terminal. Dolphin 9500 Series terminals ship with ActiveSync 3.7 already installed. Therefore, you must install ActiveSync 3.7 on your desktop computer from the Microsoft Companion CD that came with your terminal.

To install ActiveSync on your desktop computer, insert the Microsoft Companion CD into the CD-ROM drive of your desktop computer. Click the **yellow arrow**, then **Start Here**, and follow the directions on your screen.



When communicating via ActiveSync, your terminal must be connected to the host PC with a peripheral device sold/ manufactured by Hand Held Products, such as the Dolphin HomeBase, Dolphin Mobile Base, Dolphin Net Base, Dolphin Mobile Charger or other Dolphin 9500 Series charging/communication cable. Use of any peripheral not sold/ manufactured by Hand Held Products may damage your terminal and will void the warranty.

For more information about communication peripherals, see [Dolphin 9500 Series HomeBase](#) on page 12-1 and [Dolphin 9500 Series Mobile Base](#) on page 13-1.

Setting Up Your Desktop Computer

When installation of ActiveSync is complete on your desktop computer, the ActiveSync Setup Wizard helps you

- connect your terminal to your desktop computer,
- set up a partnership so you can synchronize information, and
- customize your synchronization settings.

Synchronizing from Your Desktop Computer

Because ActiveSync is already installed on the Dolphin 9500 Series terminal, your first synchronization process begins automatically when you finish setting up your desktop computer in the wizard and your terminal is connected to the host PC.

After your first synchronization, look at Calendar, Contacts, and Tasks on the terminal. Notice that the same information from Microsoft Outlook on your desktop computer is now on the terminal. Simply remove the Dolphin from the communication peripheral and you're ready to use it.

By default, ActiveSync does **not** automatically synchronize all types of information. Use **ActiveSync Options** to specify the types of information you want to synchronize. The synchronization process makes the data (in the information types you select) identical on both your desktop computer and your device.

For more information about using ActiveSync on your desktop computer, open **ActiveSync**, then open **ActiveSync Help**.

Synchronizing from the Terminal

ActiveSync **must** be setup on your desktop computer and the first synchronization process completed *before* you initiate synchronization from the terminal for the first time.

To initiate synchronization the first time, tap **Start > ActiveSync**. The synchronization process begins.

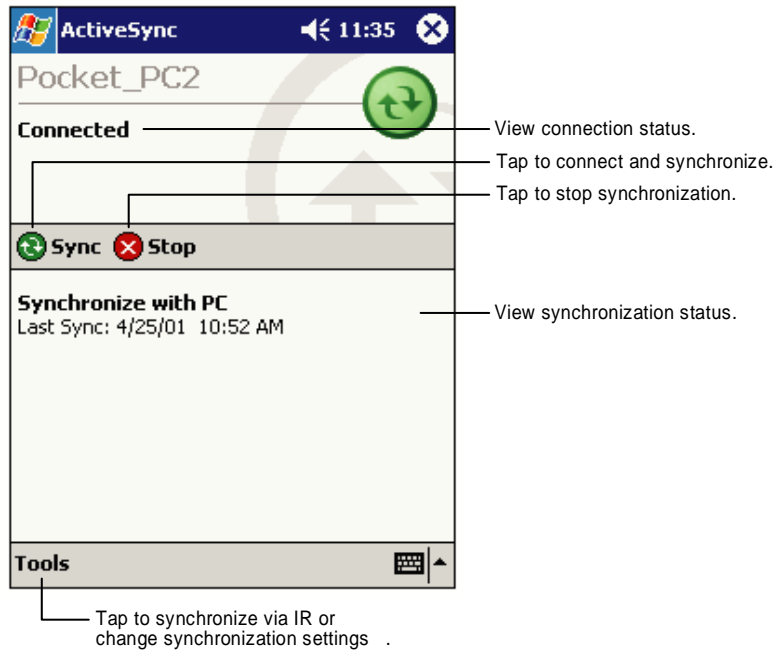

Note: If you have a wireless LAN card, you can synchronize remotely.

After the first synchronization, when using Dolphin peripherals such as the HomeBase or Mobile Base, synchronization begins automatically whenever a terminal is properly seated in the terminal well. For more information, see [Dolphin 9500 Series HomeBase](#) on page 12-1 or [Dolphin 9500 Series Mobile Base](#) on page 13-1.

Exploring Your Terminal from the Desktop Computer

When the terminal and desktop computer are connected, open the main ActiveSync window (on the desktop), and click **Explore**.

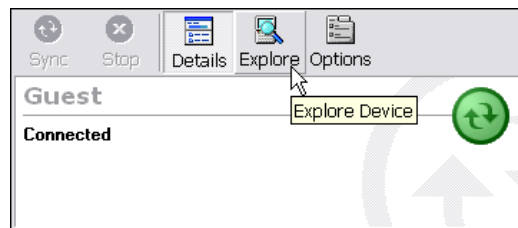

The Mobile Device folder opens in Windows Explorer.

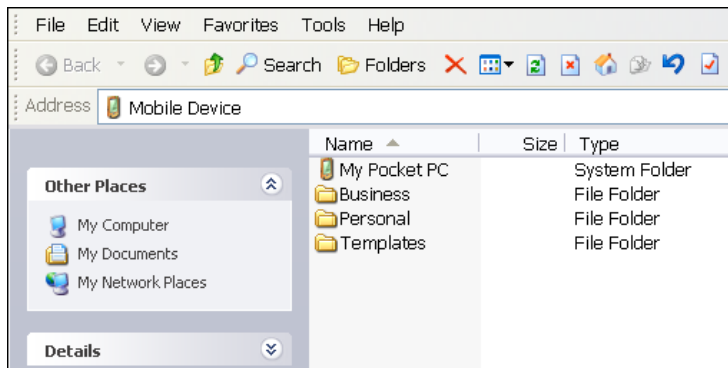

The terminal is now treated as a mass storage device, and transferring files is as simple as dragging and dropping or copying and pasting as you would for moving files between folders on your hard drive.

Adding Programs to the Terminal Using ActiveSync



When selecting programs, verify that the program and version of the program are designed for the Windows Mobile and your processor. You can verify your processor by tapping Start > Settings > System tab > About > Version tab. Make a note of the information in the Processor field.

Depending on the application, the software must be stored or installed on the host PC.

1. Download the program to your desktop computer from either the Internet or the CD or disk that contains the program. You may see a single *.exe or setup.exe file, a *.cab file, or *.dll. There may also be several versions of files for different device types and processors.
2. Read any installation instructions, Read Me files, or documentation that comes with the program. Many programs provide special installation instructions.
3. Connect the terminal to the desktop computer via a Hand Held Products communication peripheral.

If the File is an Installer:

An installer program is one that installs on the PC and the terminal simultaneously; one process installs to both devices.

1. On the PC, double-click the *.exe or *.setup.exe file. The installation wizard begins.
2. Follow the directions on the PC screen. The installation process includes transferring the software to the terminal.

If the File is Not an Installer:

Some programs cannot be installed on PCs because they are designed for terminals. In these cases, the appropriate files must be stored on the host PC, transferred via ActiveSync, and installed on the terminal. You will know the program cannot be installed on the PC if an error message appears when you try to install it stating that the program is valid but designed for a different type of computer.

1. If you cannot find any installation instructions for the program in the Read Me file or documentation, open **ActiveSync** and click **Explore**.*
2. Navigate to the **My Pocket PC** folder and copy the program file or files to the **Program Files** folder on the terminal.
 - If you want the program to be part of the Autoinstall that occurs after every hard reset, place the program file in the **Autoinstall** folder (My Pocket PC > IPSM > Autoinstall).
3. Depending on the program, you may need to open **File Explorer** on the terminal, navigate to the folder where the program is located, and tap on the program file to install it.
 - If you copied the file to the **Autoinstall** folder, you can either tap on the program inside the Autoinstall folder or perform a hard reset and the program will install as part of the regular Autoinstall; see [Let Autoinstall Run](#) on page 2-10. Remember, a hard reset erases RAM data! For more information, see [Hard Reset \(Cold Boot\)](#) on page 2-12.

After installation on the terminal is complete, tap **Start > Programs** and the program and its icon appears on the Programs screen. Tap it to open the program.

Using Infrared

Dolphin 9500 Series terminals contain infrared or IrDA ports on the left side panel (see [IrDA Port](#) on page 3-8). Using these ports, you can send and receive data between the terminal and other devices equipped with infrared. This can include, but is not limited to, Windows Mobile information such as Contacts and Tasks, as well as software upgrades.

Verify That the IrDA Port is Enabled

The IrDA port must be enabled to transmit data. By default, the IrDA port is assigned to Com port 6 and is enabled. When a Bluetooth radio is installed, the IrDA port can be disabled to free up a Com port for Bluetooth devices.



To verify that the IrDA port is enabled, tap **Start > Settings > Connections tab > IrDA IrDA**.

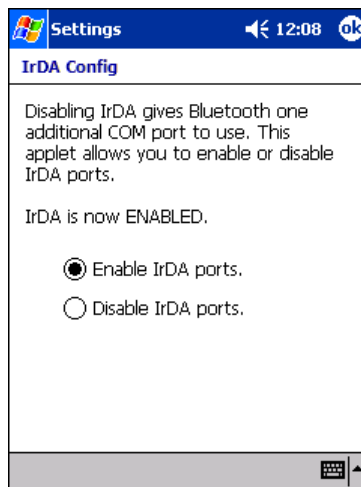

If **Enable IrDA ports** is selected, then the IrDA port is active.

*Note: The IrDA icon appears on the Connections tab **only** if there is a Bluetooth radio installed on the terminal.*

IrDA Port Location on the Terminal

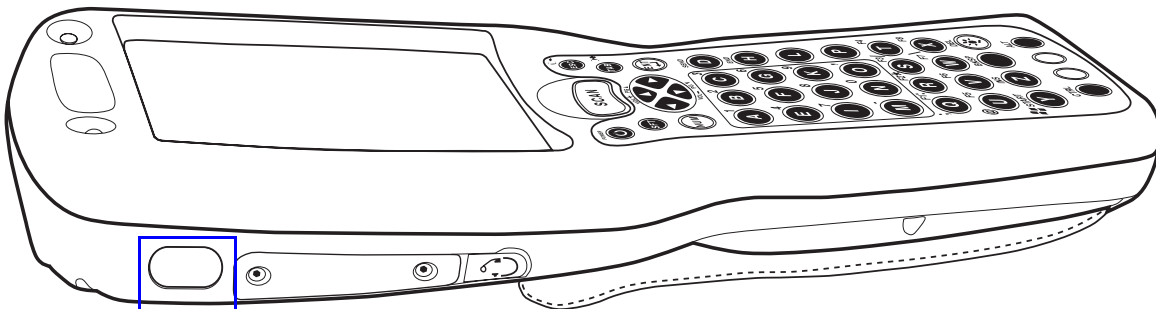

The above graphics shows the left side panel of the Dolphin 9500 terminal. The location of the IrDA port is the same on both Dolphin 9500 and Dolphin 9550 terminals. For more information, see [IrDA Port](#) on page 3-8.

Verify That Beam Settings Are Set to Receive

The Beam Settings must be set to receive for the terminal to receive data from other infrared devices. To verify, tap **Start > Settings > Connections** tab > **Beam**. The Beam Settings window should appear as follows:

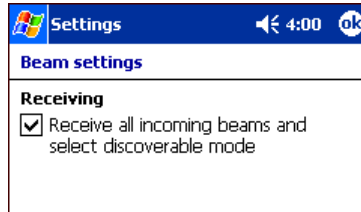

Sending Information

To send or receive, the IrDA ports of both devices - whether it's two terminals, or a terminal and a host device - must be aligned with each other and within a close range. The maximum data-transfer speed is 115 Kbps.

1. Align the IrDA ports.
2. Open the program where you created the item you want to send and locate the item in the list. You can also beam files, but not folders, from File Explorer.
3. Tap and hold the item. A pop-up menu appears.

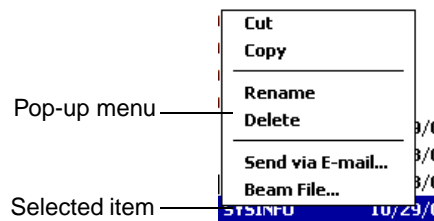

4. Select **Beam File**. The information begins transmitting to the other device.

Receiving Information

1. Align the IrDA ports.
2. Have the owner of the other device send the information to you.
3. Your terminal automatically begins receiving it.

Troubleshooting

If the Beam Settings are not set to receive or you've aligned two IrDA ports and the terminal is still not receiving, go to **Start > Programs > Infrared Receive**. The terminal searches for the sending device.



If the terminal cannot find the sending device, the following message appears:



Using an ISP

The communication software for creating an ISP connection is already installed on your device. Your service provider should provide the software needed to install other services, such as paging and fax services.

After you are connected, you can send and receive e-mail messages by using Inbox and view web pages using Pocket Internet Explorer. For more information, see [Inbox](#) on page 10-7. You can also download software applications from the web.

Adding Programs Directly from the Internet



When selecting programs, verify that the program and version of the program are designed for the Windows Mobile and your processor. You can verify your processor by tapping Start > Settings > System tab > About > Version tab. Make a note of the information in the Processor field.

1. Determine your device and processor type so that you know which version of the software to install. Go to **Start > Settings > System tab > About**. On the **Version** tab, make a note of the information in the **Processor** field.
2. Download the program to your device straight from the Internet using Pocket Internet Explorer. You may see a single *.exe or setup.exe file, or several versions of files for different device types and processors.
3. Read any installation instructions, Read Me files, or documentation that comes with the program. Many programs provide special installation instructions.
4. Tap the file, such as an *.exe file. The installation wizard begins. Follow the directions on the screen.

For more information about working with Pocket Internet Explorer, see [Pocket Internet Explorer](#) on page 10-10.

Overview

Dolphin 9500 Series terminals are available with an on-board 2.4 GHz 802.11b (Wireless Local Area Network) WLAN radio that uses Direct Sequence Spread Spectrum (DSSS) technology to spread the signal continuously over a wide frequency band at a data rate of up to 11 Mbps. In addition, the open software architecture makes the Dolphin 9500 Series a complete solution for a variety of wireless mobile data collection applications.

The Dolphin 9500 Series is interoperable with other 802.11b Wi-Fi-compliant products including Access Points (APs), printers, PCs (via PC card adapters) and other wireless portable terminals.

Powering Up the 802.11b Radio Driver

The radio driver for 802.11b is installed when the Dolphin terminal is first initialized. The 802.11b radio must be powered up before you can configure it. For more information, see [Powering Up a Radio](#) on page 4-17.

Configuration Utilities

There are two configuration utilities for the 802.11b radio: 802.11b Settings and 802.11b Wireless Security Supplement.

802.11b Settings Use this configuration utility when you are not using Wired Equivalent Privacy (WEP) or standard WEP (64/128 bit) with no authentication. For more details, see [802.11b Settings](#) on page 7-2.

802.11b Wireless Security Supplement Use this configuration utility when you are using WEP (beyond the standard), Wi-Fi Protected Access (WPA), and authentication. For details, see [802.11b Wireless Security Supplement](#) on page 7-12.

802.11b Settings









You can access the configuration utility two ways:

1. Tap **Start > Settings > System tab > 802.11b Settings**.
This icon appears on the System tab only if there is an 802.11b radio installed on the terminal.
2. Tap the **Status** icon  in the system tray - see [The Status Icon](#) on page 7-11.

The 802.11b Settings utility consists of four tabs: Status, Config, Advanced, and About. Each tab is described in its own section in this chapter.

Icons

This configuration utility contains icons that indicate the status of the network.

Icon	This icon means...
	Excellent signal strength. Excellent connection.
	Poor signal strength. Poor connection.
	Radio disabled. No radio connection.
	Access Point, AP Mode.
	Peer Station, Peer-to-Peer Mode.
	WEP enabled. Network needs a WEP Key to connect.
	WEP disabled. Network does not need a WEP Key to connect.
	Mismatched WEP Key configuration with your network.
	Online help button.

Status Tab

802.11b Settings always opens to the Status tab, which displays the current 802.11b settings.

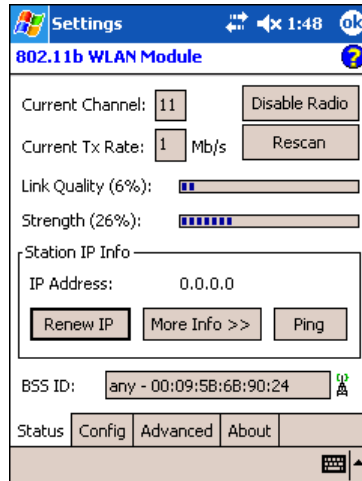

Field	Description
Current Channel	Shows the RF channel currently used by the radio.
Current TX Rate	Shows the current transmit rate. This can be 1 Mbps, 2 Mbps, 5.5 Mbps, or 11 Mbps.
Disable/Enable Radio	Tap this button to disable/enable the radio.
Rescan	Tap this button to start a rescan process to search for an AP with a stronger signal in the network.
Link Quality	Displays the signal to noise ratio.
Strength	Displays the signal strength of the receiver.
IP Address	Displays the IP address of the radio. Verify configuration information with your network administrator.
Renew IP	Tap this button to reapply IP the address from the DHCP server when automatic DHCP is enabled.
State	Displays the Network Name and the MAC address of: <ul style="list-style-type: none">- the access point the radio is associated with in AP mode, or- the creator of IBSS into which the radio is joined in peer-to-peer (Ad-Hoc) mode. After an SSID is chosen, this field name changes to "IBSS ID."

Field

Description

Tap this button to display detailed TCP/IP information as shown in the following screen:

More Info

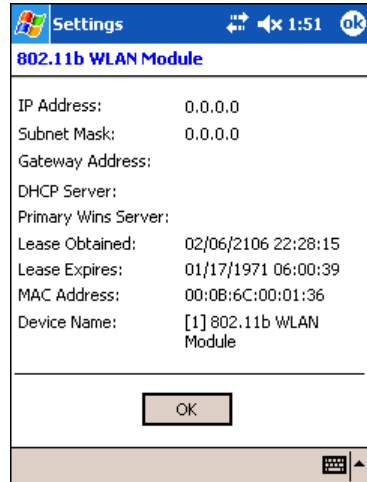

Tap this button to open the Ping Utility.

Ping

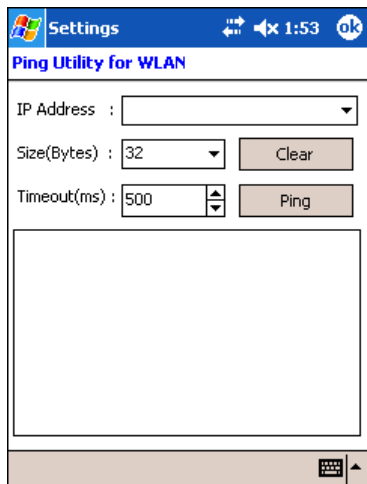

Field	Description
IP Address	Displays the current IP address. You can enter another IP address to ping it.
Size (Bytes)	Displays the current size in bytes; 32 is the default. You can select up to 8192 bytes in the drop-down list.
Timeout (ms)	Displays the current timeout; 500 is the default. Increase or decrease it by tapping the up and down arrow buttons.
Clear	Tap this button to clear IP Address input and the ping statistics field.
Ping	Tap this button to ping the IP address entered in the input field.
Ping Statistics	This section lists the pinging IP address and the pinging results.

Config Tab

The Config tab provides a list of all access points (APs) and peer stations in range. You can create and edit SSID profiles for access points that you want your station to associate with.

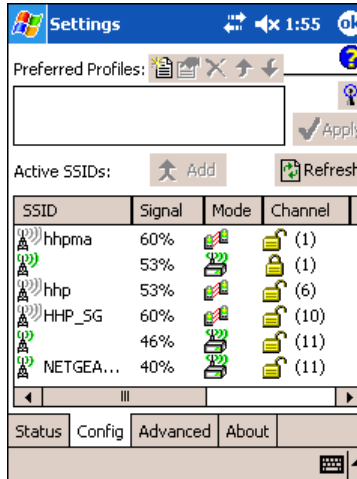

Preferred Profiles

This section displays a list of preferred profiles for APs in the network, created by the user, or added from the Active SSIDs table. When turned on, the radio searches for the APs in the exact order shown in the list of profiles. This section is blank after the initial installation and each hard reset. It will remain blank if there no automatic association preference selected.

This section contains several icons that enable you to add and configure APs.

Icon	Name	Description
	New	This button is always active. Tap it to create a new profile on a series of screens; for instructions, see To Create a New Profile on page 7-7.
The following buttons activate only when an Active SSID in the Preferred Profile list is selected.		
	Edit	Tap this button to open the configuration screens for the selected SSID.
	Delete	Tap this button to delete the selected SSID from the Preferred Profile list.
	Up	Tap this button to move the selected SSID up one place in the Preferred Profile list.
	Down	Tap this button to move the selected SSID down one place in the Preferred Profile list.



Remember that the terminal accesses the SSIDs in this list in the exact order that they appear; moving an SSID up or down in the list determines the order of contact.

Active SSIDs

The Active SSIDs table lists all access points or peer stations (creator of IBSS) in the vicinity of the host. It displays only those SSIDs that accept broadcast associations.

Each record displays information in the following six columns (The screen may not display all the fields in the following table. Use horizontal scroll bar to view all):

Column	This column displays...
SSID	The Network Name of the access point or peer station. An icon with signal strength is also shown.
Signal	Strength in percentage for the selected SSID.
Mode	Access Point Peer Station

Column	This column displays...
Channel	The channel in use and the WEP method it applies, if any.  WEP Key-On  WEP Key-Off.
SupRate	Supported data rate of the access point or the peer station.
BSSID (MAC Addr)	BSSID or MAC Address of the access point or the peer station.

- Add**  Tap this button to add an Active SSID to the Preferred Profiles list. Select and active SSID in the list, tap **Add**, and the profile moves to the Preferred Profiles list.
- Apply** Tap **Apply** to associate your station with a selected SSID. The SSID selected can be in the Preferred Profile or Active SSIDs lists. When applied, the Status tab opens displaying the status of the wireless connection. If the association fails, a search for another AP in the Preferred Profile list automatically takes place, and the radio attempts to associate with the station, in order of preference.
- Refresh** Tap **Refresh** to start a new search for all available access points or peer stations in the vicinity.

To Add an Active SSID to the Preferred Profile Table

An SSID needs to be in the Preferred Profile list to be edited.

1. Select an SSID in the Active SSID list and tap **Add**. If the SSID has the WEP Key turned on, the Settings window displays and prompts you to enter the WEP Method, Encryption Key, and Key ID.
2. Now, you need to configure its profile.
3. In the Preferred Profile list, select the SSID and tap **Edit** ; see [To Create a New Profile](#) on page 7-7.
4. When configuration is complete, tap **OK**. The SSID and its profile are added into the Preferred Profiles list. If adding an SSID with the WEP Key turned off, the Settings window does not display and the SSID is added directly to the Preferred Profile table.

To Create a New Profile

In the Preferred Profiles section, tap the **New** button . A screen opens with two tabs windows: Network Profile and Authentication.

Network Profile Tab

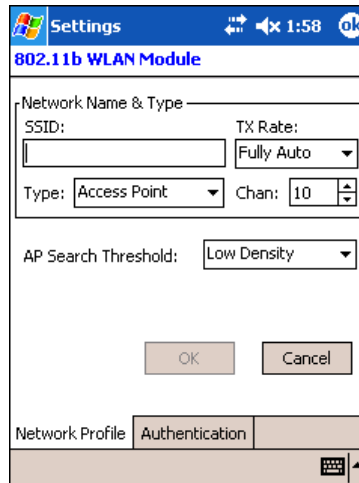

The screenshot shows a settings window titled "802.11b WLAN Module". It contains the following fields and controls:

- Network Name & Type** section:
 - SSID: [Empty text field]
 - TX Rate: [Fully Auto] (dropdown menu)
 - Type: [Access Point] (dropdown menu)
 - Chan: [10] (numeric spinner)
- AP Search Threshold: [Low Density] (dropdown menu)
- Buttons: [OK] and [Cancel]
- Bottom tabs: [Network Profile] and [Authentication]

Field	Description
-------	-------------

Network Name & Type Section

SSID	Enter an SSID, which is the Network Name. Check with your network administrator for Network Name (SSID).
TX Rate	Choose the transmit rate from the drop-down list - 1MB, 2 MB, Auto 1/2 MB, 5.5 MB, 11 MB, or Fully Auto. The transmit rate is set to Fully Auto by default. From the drop-down list, select
Type	Peer-to-Peer – This mode used for communication between two (or more) radio stations (cards) without an access point. Access Point (AP) – This mode is also called “Infrastructure” mode.
Chan	Scroll to select a channel for communication.
AP Search Threshold	Select Low Density (default), Medium Density , or High Density from the drop-down list and tap OK . AP search thresholds are used for wireless client roaming between APs. In general, the higher the density selected here, the easier your WLAN card roams between APs with the same SSID in the same network. Roaming also depends on the relative signal strength of the AP.
OK	Tap this button to save the profile or changes to the profile.
Cancel	Tap this button to close the window without saving or modifying the profile.

Note: The SSID, Type, TX Rate, and Channel fields are unchangeable in Access Point mode, whereas TX Rate and Channel fields can be changed in Peer-to-Peer mode.

Authentication Tab

On the Authentication tab, you configure the WEP encryption key for secure wireless communication.

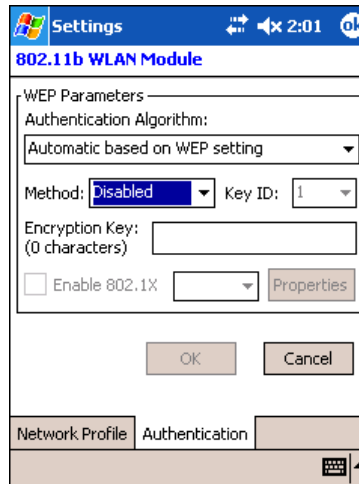

To use WEP, the encryption key must be configured as part of the profile before connecting. For more information about configuring a profile, see [To Create a New Profile](#) on page 7-7.

Field	Description
*Authentication Algorithm	<p>This drop-down list is active and configurable only when the WEP Key is enabled for the selected SSID profile. If this drop-down list is active, select one of the following options:</p> <p>Automatic based on WEP setting – The algorithm automatically matches the AP's setting. This is the default selection.</p> <p>WECA Compliant (always use Open) – The algorithm should match the AP's setting for "Open."</p> <p>Must use Shared with WEP – The algorithm should match the AP's setting for "Shared."</p>
Method	<p>The options in this drop-down list determine what characters can be used to create the WEP encryption key. Select one of the following five:</p> <p>Disabled – WEP Key is off</p> <p>64 bit (HEX) – You can use up to 10 characters in Hexadecimal in the Encryption Key field</p> <p>64 bit (ASCII) – You can use up to 5 characters in ASCII in the Encryption Key field</p> <p>128 bit (HEX) – You can use up to 26 characters in Hexadecimal in the Encryption Key field</p> <p>128 bit (ASCII) – You can use up to 13 characters in ASCII in the Encryption Key field</p>
Key ID	<p>HEX – Hexadecimal is a set of 16 characters from 0-9 and from A(a)-F(f).</p> <p>ASCII – ASCII means any printable ASCII character can be typed.</p> <p>Choose from the available Key IDs: 1 (Default), 2, 3, or 4. Check with your network administrator for the WEP Key and Key ID you need to use for your network.</p>
Encryption Key	Type in the encryption key for your wireless connection. The format allowed in this field depends on the character set and format selected in the Method field.
*Enable 802.1X	<p>This option and drop-down list is active only when the WEP Key is enabled.</p> <p>Select this option if access to the network needs group authentication, then select the 802.1X security standard - PEAP or TLS - from the drop-down list.</p>
*Properties	Tap the Properties button to choose the certificate that applies. Accessing 802.1x networks require personal certificates for authentication.
<p>*Please note that 802.11b Settings does not support authentication; therefore, these fields are not active. If you are using authentication in your wireless 802.11b connection, you must configure that connection in the 802.11b Wireless Security Supplement. For more information, see 802.11b Wireless Security Supplement on page 7-12.</p>	

Field	Description
OK	Tap this button to save the profile or changes to the profile.
Cancel	Tap this button to close the window without saving or modifying the profile.

To Delete a Profile

Profiles may be deleted either from the Preferred List or from the Preferred List and Registry. To delete a profile, select (highlight) a profile and tap the **Delete** button and the following screen displays:

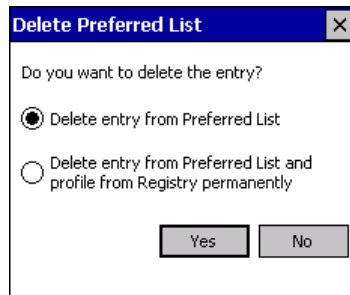

From the pop-up window select the option of your choice and tap **Yes** to confirm or **No** to cancel.

Advanced Tab

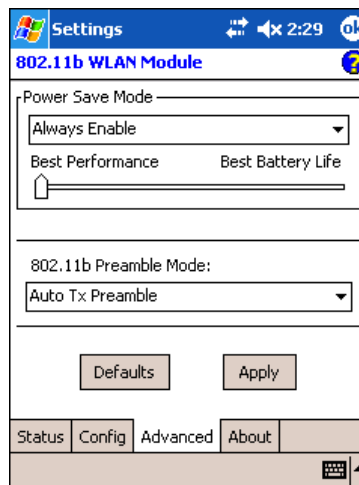

Field	Description
Power Save Mode	This drop-down list determines the settings for Power Save Mode. Disable – Disables the Power Save mode. Always Enable – Enables Power Save mode. This is the default setting. Auto Enable – Automatically enables the Power Save mode when the terminal is running on battery power and automatically disables Power Save mode when the terminal is running on external power.
Slider	The slider is active only if Power Save Mode is enabled. Move the slider between Best Performance and Best Battery Life. The setting here modulates Power Save Mode to achieve maximum performance and maximum battery life.

Field	Description
	A preamble consists of a Synchronization (Sync) field and a 16-bit Start Frame Delimiter (SFD) field.
Preamble Mode	Long TX Preamble – Where Sync field consists of 128 bits.
	Short TX Preamble – Where Sync field consists of 56 bits.
	Auto TX Preamble – Automatically changes between long and short preamble mode transmission based on AP configurations. This is the default Preamble Mode.
	Resets all the settings to default values
Defaults	<ul style="list-style-type: none"> • Always Enable for Power Save Mode, • Automatic based on WEP setting for Authentication Algorithm, and • Auto TX Preamble (for Preamble Mode).
Apply	Applies changes. This button is active only when a change has been made on the tab.

About Tab

This window provides Version Number and time of build for Network Driver, Configuration Utility, and NIC Firmware.

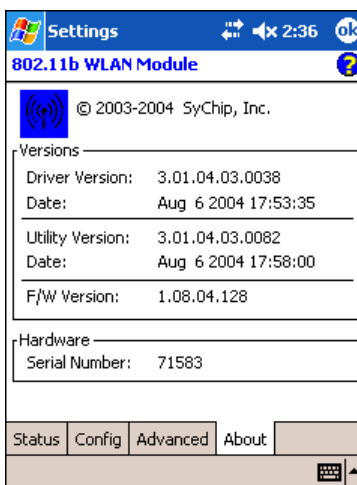

The Status Icon

You access the 802.11b Settings by tapping and holding on the **Status** icon  in the task tray at the bottom of the Today screen. The following menu pops up:



Menu Option

Selecting This Option...

Wireless Radio On

Turns on the radio. LED is on and the Link Icon displays with signal strength.

Wireless Radio Off

Turns off the radio. A pop-up window will ask for your confirmation. If confirmed, the LED will be off and the Status icon will change color from green to red on the top without signal strength displayed. The WLAN card/module will stop functioning.

Remove Status Icon

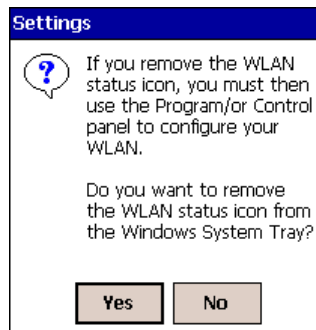

Removes the Status Icon from the bottom tray. A pop-up window asks you to confirm. Click **Yes** to confirm, or **No** to cancel.

If confirmed, the Status icon does not display in the task tray, and you will need to go to **Start > Programs > 802.11b Settings** in the future.

Wireless Network Status Configuration

Opens the Status tab of the configuration utility; see [Status Tab](#) on page 7-3.

Advanced Configuration

Opens the Config tab of the configuration utility; see [Config Tab](#) on page 7-5.

Version Information

Opens the Advanced tab of the configuration utility; see [Advanced Tab](#) on page 7-9.

Opens the About tab of the configuration utility; see [About Tab](#) on page 7-10.

Note: The Status Icon changes to a crossed lock  as a warning that you may have entered a wrong key (WEP Key mismatch) for the WEP-On AP or a station.

802.11b Wireless Security Supplement

AEGIS Client® offers the most comprehensive IEEE 802.1X supplicant for securing wired and wireless networks. The Client is a standards-based implementation of IEEE 802.1X and can be configured to work with almost any network equipment - wired or wireless - that supports the 802.1X authentication standard. The Client is interoperable with 802.1X-capable wireless access points and authentication servers including Microsoft's IAS and Cisco's ACS.

The Client solves the problem of key distribution in wireless LANs by using public key authentication and encryption between Wireless Access Points (WAP) and roaming stations to exchange dynamic Wired Equivalent Privacy (WEP) keys. In addition, network managers can control 802.1X user profiles from a centralized RADIUS server or, in the case of TTLS, from a RADIUS Diameter or other AAA servers. The Client supports both wireless (802.11a/b/g) and Ethernet interfaces.

System Requirements

You need the following equipment and software to run AEGIS Client software:

- A computer with a network interface card and/or wireless network interface card installed that support the NDIS 5.1 standard for 802.11 WLAN object identifiers (OID). The AEGIS Client software installation routine expects to find your computer's wireless card properly installed, even if it isn't connected to a network. If the card isn't in the computer, the installation program can't make the proper program and protocol associations. **Be sure your wireless card is installed!**
- The appropriate version of the AEGIS Client software package for your operating system. Contact Hand Held Products for the correct version for your company.

Platforms Supported

There are several versions of AEGIS Client software for computers using a wide variety of operating systems. Specific capabilities of a particular version of AEGIS Client may vary according to the operating system. This is due to varying levels of support for different EAP types by manufacturers. Drivers for some types of network hardware and operating system combinations don't support as many EAP types as others combinations.

The following platforms are supported:

- Windows Mobile Software 2003 [OS version "Pocket PC Version 4.20.1081 (Build 13100)"]
- Pocket PC 2002 [OS version "Pocket PC Version 3.0.11171 (Build 11178)"]
- CE.NET 4.1 [OS version "CE .NET Version 4.10 (Build 908)"]
- CE.NET 4.2 [OS version "CE .NET Version 4.20 (Build 1088)"]

Note: Verify the operating system version by tapping **Start > Settings > System tab > About**.

802.1X Supplicant Protocol Support

Support for the Extensible Authentication Protocol (EAP) - RFC 2284

Supported authentication methods are as follows:

- CHAP/MD5 - RFC 1994
- EAP TLS Authentication Protocol - RFC 2716
- EAP Tunneled TLS (TTLS) - Internet Draft February 2002
- Cisco LEAP and PEAP
- Microsoft PEAP

Tested against the following servers:

- Funk Odyssey 3.2 using TLS, LEAP and TTLS
- AEGIS Client 1.1.4 using MD5, TLS, TTLS, LEAP and PEAP
- Cisco ACS 3.2 using MD5, TLS, LEAP and PEAP



If you are using one of these authentication methodologies, you need to configure your 802.11b connection here, NOT through 802.11b Settings. However, if you want to set the AP Search Threshold above the default setting of Low Density, you do need to change that setting in 802.11b Settings; for details, see [Network Profile Tab](#) on page 7-7.

Required Network Configuration Information Worksheets

Because AEGIS Client enables your terminal to access a network that is protected by the IEEE 802.1X protocol, you must configure EAP data communication to match your network server parameters. If the EAP configuration doesn't match your network configuration, you can't access the network.

Installing and configuring the Client usually takes less than 15 minutes, provided you have the required equipment, software, and configuration information. You need clear information from the network administrator about how the network's authentication works.

The worksheets on the following pages provide space to record the required Client configuration information to set up the Client to match specific Extensible Authentication Protocols (EAP). The forms are designed so that hard copies can be filled out, copied, and distributed.

The client software supports the following EAP authentication methods:

- MD5
- LEAP
- TLS/SmartCard
- TTLS
- PEAP

There is a worksheet for each method. Complete the worksheet for the method you choose.

MD5 Worksheet

To configure AEGIS Client to use MD5 authentication, you need to know:

1. Will you use your Windows user name and password for network authentication? (Applies only to Windows clients.)
2. If not, what is your unique user name/password combination?

If a second set of credentials is required, you need to know the exact user name and password. These are typically case-sensitive.

User name: _____

Password: _____

LEAP Worksheet

To configure AEGIS Client to use LEAP authentication, you need to know:

1. Will you use your Windows user name and password for network authentication? (Applies only to Windows clients.)
2. If not, what is your unique user name/password combination?

If a second set of credentials is required, you need to know the exact user name and password. These are typically case-sensitive.

User name: _____

Password: _____

TLS/SmartCard Worksheet

To configure AEGIS Client to use TLS/SmartCard authentication, you need to know:

1. Is a client certificate required?

No.

Yes. This file needs to be installed on your machine by your network administrator.

2. Should the AEGIS Client validate the server certificate chain?

No. Skip Questions 3-4.

Yes.

3. Will the server accept any trusted Certificate Authority (CA), or is a particular CA required?

Any trusted CA is acceptable.

A particular CA is required: _____

4. Are intermediate certificates allowed?

No.

Yes.

5. What is the name of the server? _____

This usually includes the server's domain, for example: server.big_school.edu.

TTLS Worksheet

To configure with TTLS authentication, you need to know:

1. Use Windows user name and password for authentication? (Applies only to Windows clients.)

2. If not, what is your unique user name? If a second set of credentials is required, you need to know the exact user name. This is usually case-sensitive.

User name: _____

3. Is a client certificate required?

No.

Yes. This file needs to be installed on your machine by your network administrator.

4. What is the user name (identity) and password for the tunnel authentication?

User name: _____

Password: _____

5. What is the tunnel authentication protocol?

CHAP (Challenge Handshake Authentication Protocol)

MS-CHAP (Microsoft CHAP Extensions)

MS-CHAP v2 (Microsoft CHAP Extensions v. 2)

PAP

EAP-MD5

6. Is a server certificate is required?

- No.
 Yes.

7. Should the Aegis Client validate the server certificate chain?

- No. Skip Questions 8-9.
 Yes.

8. Will the server accept any trusted Certificate Authority (CA), or is a particular CA required?

- Any trusted CA is acceptable.
 A particular CA is required: _____

9. Are intermediate certificates allowed?

- No.
 Yes.

10. What is the name of the server?

This usually includes the server's domain, for example: server.big_school.edu. _____

PEAP Worksheet

To configure AEGIS Client with PEAP Authentication, you need to know:

1. Use Windows user name and password for authentication? (Applies only to Windows clients.)
2. If not, what is your unique user name? If a second set of credentials is required, you need to know the exact user name. This is usually case-sensitive.

User name: _____

3. Is a client certificate required?

- No.
 Yes. If it is, this file needs to be installed on your machine by your network administrator.

4. What is the user name (identity) and password for the tunnel authentication?

User name: _____

Password: _____

5. What is the tunnel authentication protocol?

- MS-CHAP v2 (Microsoft CHAP Extensions v. 2)
 EAP TLS/SmartCard
 Generic Token Card

6. Is a server certificate is required?

- No.
 Yes.

7. Should the Aegis Client validate the server certificate chain?

No. Skip Questions 8-9.

Yes.

8. Will the server accept any trusted Certificate Authority (CA), or is a particular CA required?

Any trusted CA is acceptable.

A particular CA is required: _____

9. Are intermediate certificates allowed?

No.

Yes.

10. What is the name of the server?

This usually includes the server's domain, for example: server.big_school.edu. _____

Opening the Client

To access the client the first time, tap **Start > Programs > Meetinghouse AEGIS Client**.

After the Client has been activated, you can:

1. Tap **Start**. The icon appears in the quick start tray on the Start menu. Tap the icon to open the Client.

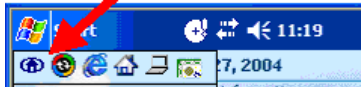







2. Tap the icon in the lower left corner of the command bar.



Icon Indicators

The color of the icon indicates the status of the controlled ports.

Icon	Color	This color icon indicates that ...
	Green	Authentication succeeded.
	Yellow	Authentication is in process.
	Red	Authentication failed.
If there is no yellow, red or green in the icon then either the ports are not being controlled by 802.1X, or there is no authentication activity on the controlled ports. The absence of yellow, red or green may also indicate that the network access server is not an 802.1X aware device.		
	Gray	The port is not in use or is disabled. Either the Client isn't running, or the port is not bound to the 802.1X protocol.
	Orange	The port is associated, but there is no response to 802.11b packets. If using WEP without 802.1x authentication, this will be the final state when the connection is complete. If using 802.1x authentication, it is either a transient condition or can indicate that attempts to authenticate have timed out as there was no response to 802.1X packets.
	Blue	There is no 802.11b activity. The port may not be connected to an 802.1X-aware entity.

Note: Different parts of the icon can have different colors if more than one interface on the system is running 802.1X. For example, if your terminal has more than one active network interface card (NIC) then different parts of the icon will have different colors corresponding to the state of each NIC.

The Main Screen

On the terminal, open the Client. The main screen opens displaying a list of ports on the system's network interface cards. You manage ports on this screen.

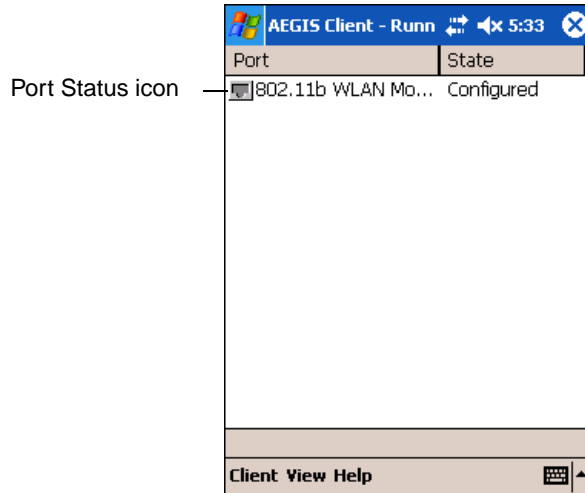

Port Status Icon

The main screen contains a port status icon to the left of each port listed. The color of this icon indicates the status of the port. The color of the icon changes as the port starts authentication, negotiates with the access point and/or authentication server, and then joins the network. As the network interface starts or stops, the color of the port icon and the status field in the Interface List updates to reflect the current state of the interface.

For details about what each color means, see [Icon Indicators](#) on page 7-17.

Client Menu

To open the client menu, tap **Client**.

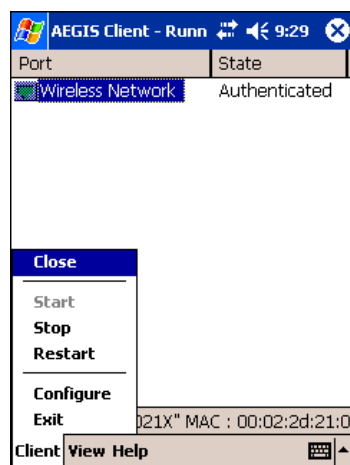

Menu Item

Close

Start/Stop

Tapping this item...

Closes the Client's interface, while leaving the client running.

Starts or stops 802.1X authentication. After you finish the initial configuration, tap the network interface and tap **Start**. If the port is already active, tap **Stop** first, then **Start** to force the program to read the new configuration file.

Restart

Same as a Stop followed by Start. Tap this when you receive a notice such as the following:

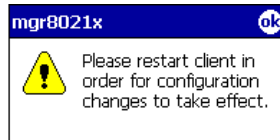

Configure

Opens the Configuration screen displaying the User tab.

Install Protocol

Selecting this option binds the 802.1X protocol to the WLAN adapter currently installed on the device. The WLAN adapter then appears in the port list. For more information about network adapters, see [Configuring Network Cards](#) on page 5-26.

Exit

Terminates the client, which stops the 802.1X protocol.

View Menu

To access the View menu, tap **View**.

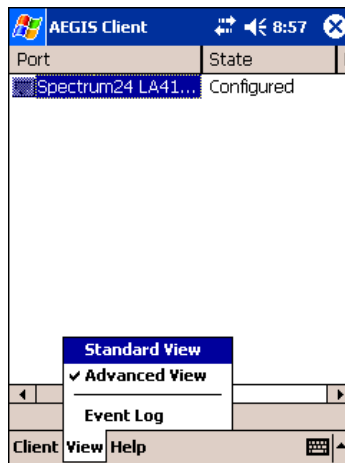

The Standard and Advanced Views control the number of columns displayed in the main menu.

Menu Item

Tapping this item...

Standard View

Displays the **Port** (adapter name) and **State** columns. This is the default view.

Advanced View

Displays the Port (adapter name), **State**, **Primary Wireless Network**, **Wireless Network**, and **MAC Address of AP** columns. Scroll right to see all columns.

Event Log

The Event Log is a text file that contains status information from the logging function. Each entry is listed sequentially with a time stamp and a text message.

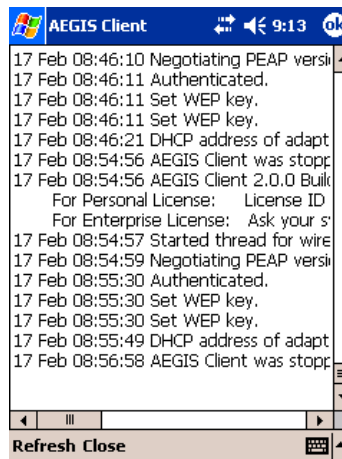

Tap **Refresh** to retrieve the most current information and display it in the log immediately.

Tap **Close** to return to the main screen.

Help Menu

Tapping Help opens the help menu. Select **Online Help** to access online help. Select **About** to review software version information.

Status Bar

The status bar is displayed at the bottom of the main screen and indicates the connection status between the network card and the access point.

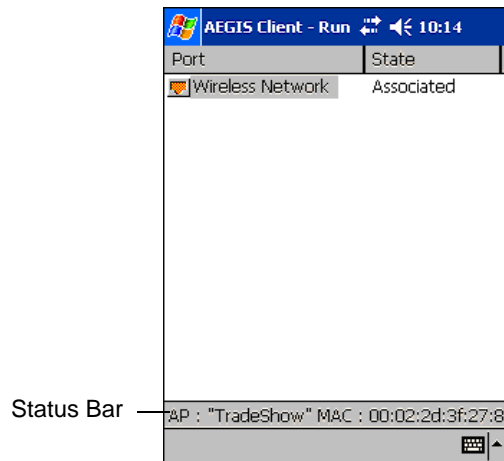

The status bar displays one of the following depending on the status of connectivity:

- "Not Associated"
- "AP : [Name of the SSID] MAC : [MAC address]."

Port Menu

On the main screen, tapping on a port opens a popup menu that allows the port to be enabled or disabled, configured, or deleted.

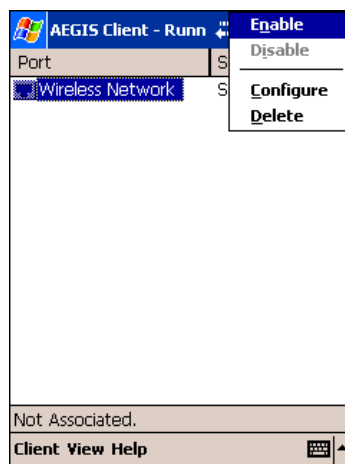

The port menu enables you to use 802.1X authentication, change the port configuration, or remove it from the port list. If there are no entries in the Port list, follow the advice in the troubleshooting section to resolve the problem.

Enable and Disable These commands enable or disable 802.1X authentication on the port. The port should be enabled before the protocol is started. Enabling a port is not the same as starting it (see [Client Menu](#) on page 7-18); however, both actions are required for the Client to work.

Configure

Opens the port configuration screen.

Delete

Removes an adapter from the port list. An unused port may be deleted from the port list. The radio card must not be in the device or the radio must be turned off.

Ports appear in the list only when the 802.1X protocol binds to the adapter. The protocol binds to the adapter when the adapter is in the device and the Client software is installed, or Install Protocol is selected from the Client menu (see [Client Menu](#) on page 7-18).

Configuring the Client

The Client is configured in two separate areas:

1. **Client Configuration** area - enables you to configure user settings and is accessed from the Client menu in the command bar.
2. **Port Settings** area - enables you to configure Network Properties settings for individual wireless networks and is accessed from the Port menu.

Configuration Screens

Both Client Configuration and Port Settings areas lead you through a series of setup screens. The following diagram displays the different screens and how they are related:

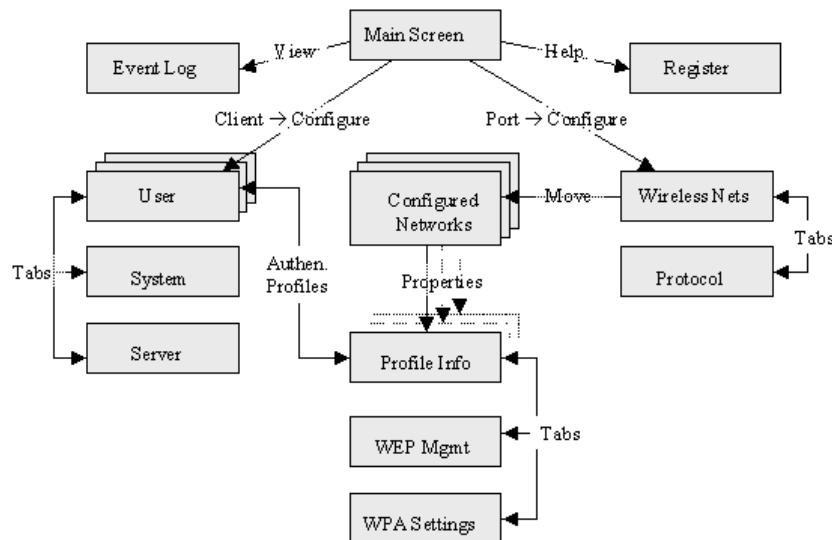

Client Configuration Area

Each user account needs to define the protocol and the credentials used to authenticate a user. Because Windows Mobile devices are usually small devices with a single NIC and, usually, a single user, the initial configuration is usually the only time the software needs to be set up. The Client will need to be reconfigured if the device is used on multiple networks, or if different users share the computer.

Note: Fields are grayed out if not relevant to the selected protocol.

Accessing the Client Configuration Area

On the main screen, tap **Client > Configure** (see [Client Menu](#) on page 7-18). The Client Configuration screen opens displaying the User tab.

The screenshot shows the AEGIS Client configuration interface. At the top, the title bar reads 'AEGIS Client' with a Windows logo on the left and signal, volume, and time (5:20) indicators on the right. Below the title bar, there is a 'Profile:' dropdown menu set to 'default', with 'Add' and 'Delete' buttons to its right. The main configuration area is divided into sections: 'Identity' with 'myname' in the text box and 'Password' with '****' in the text box; 'Authentication type:' with a dropdown menu set to 'MD5-Challenge'; a 'Use certificate' checkbox which is unchecked, with an empty text box and a 'Change...' button below it; and 'Tunneled authentication' with 'Identity' and 'Password' text boxes and a 'Protocol:' dropdown menu. At the bottom, there are three tabs: 'User' (selected), 'System', and 'Server'. The bottom-most bar contains 'OK Cancel' buttons and a keyboard icon.

On this tab,
User Settings Tab
System Settings Tab
Server Identity Tab

You...

Configure authentication credentials and profiles.

Set the level of detail that the Client will provide in the system log and zero-config options.

Control how the Client authenticates the server that handles the 802.1X protocol on the network side. This applies only to the TLS, TTLS, and PEAP authentication methods and is used to tell the Client what server credentials to accept from the authentication server to verify the server.

User Tab

The User settings tab defines the protocol and the credentials used to authenticate a user.

Field

Description

Multiple user credential profiles can be created for use when the user roams from one network to another. The drop-down list contains existing authentication credential profiles. Select a profile from the list to edit it in the fields that follow.

Profile

Tapping **Add** permits new profiles to be added to the list. A screen appears where you can enter a name for the new profile.

Enter a **Profile name** and tap **OK**. The name entered appears in the Profile drop-down list.

Tapping **Delete** deletes authentication profiles. To be deleted, a profile **cannot** be assigned to a configured network.

Identity

This is the 802.1X identity supplied to the authenticator. The identity value can be up to 63 ASCII characters and is case-sensitive.

For tunneled authentication protocols such as TTLS and PEAP, this identity (called the Phase 1 identity) is sent outside the protection of the encrypted tunnel. Therefore, it is recommended that this field not contain a true identity, but instead the identity "anonymous" and any desired realm (e.g. anonymous@myrealm.com). For TTLS and PEAP, true user credentials (Phase 2 identity) are entered in the Tunneled authentication section.

Note: When used with PEAP and the .NET Enterprise Server Version 5.2, this field must contain the identity used in both Phase I and Phase II. The Phase II identity field is ignored.

Password

This is the password used for MD5-Challenge or LEAP authentication. It may contain up to 63 ASCII characters and is case-sensitive. Asterisks appear instead of characters for enhanced security.

Authentication type

This is the authentication method to be used - MD5-Challenge, LEAP, PEAP, TLS, or TTLS.

Your network administrator should let you know the protocols supported by the RADIUS server. The RADIUS server sits on the network and acts as a central credential repository for Access Servers that receive the radio signals and ultimately block or allow users to attach to the network.

Field**Description**

This is the certificate to be used during authentication. A certificate is required for TLS, optional for TTLS and PEAP, and unused by MD5 and LEAP. Therefore, this option becomes active only when TLS, TTLS, or PEAP is selected as the Authentication type.

If **Use certificate** is enabled, the client certificate displayed in the field is the one that is passed to the server for verification.

Use certificate

To select a client certificate, tap **Change** and select the certificate from the list that appears.

To appear in this list, certificates must be installed in the system, for a description of this process see [Installing Certificates with CertAdd](#) on page 7-34.

The **Issued to** field should match the **Identity** field and the user ID on the authentication server (i.e., RADIUS server) used by the authenticator.

Your certificate must be valid with respect to the authentication server. This generally means that the authentication server must accept the issuer of your certificate as a Certificate Authority.

Note: When obtaining a client certificate, do not enable strong private key protection. If you enable strong private key protection for a certificate, you will need to enter an access password for the certificate each time this certificate is used.

Tunneled authentication area

Tunneled authentication parameters are used by only by TLS, TTLS and PEAP protocols, in Phase 2 of authentication, and after the secure tunnel has been established. The fields in this section are active only if TLS, TTLS, or PEAP is selected as the Authentication type.

Identity

The user identity used in Phase 2 authentication. The identity specified may contain up to 63 ASCII characters, is case-sensitive and takes the form of a Network Access Identifier, consisting of <name of the user>@<user's home realm>. The user's home realm is optional and indicates the domain to which the tunneled transaction is to be routed.

Note: Because Microsoft .NET Enterprise Server Version 5.2 does not use this parameter for PEAP, This field will have no effect for PEAP at this time. Phase 1 identity is used instead.

Password

The password used for the tunneled authentication protocol specified. It may contain up to 63 ASCII characters and is case-sensitive. Asterisks appear instead of characters for enhanced security.

This parameter specifies the authentication protocol operating within the secure tunnel.

Protocol

The following protocols are currently supported for TTLS: EAP-MD5, CHAP, PAP, MS-CHAP and MS-CHAP-V2.

The following protocols are currently supported for PEAP: EAP-MS-CHAP-V2, TLS/Smartcard, and Generic Token Card (EAP-GTC).

System Tab

The System Settings tab controls logging and the port manager timeout period.

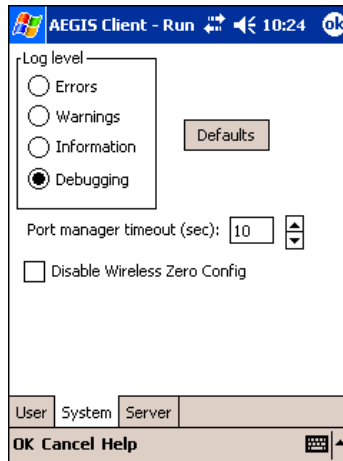

Field

Description

These settings control the detail of the log messages generated by the Client. Each level is cumulative. By default, all errors, warnings, and information events are logged. Each entry records a severity code (of one [debug message] to four [error] asterisks), a time stamp, and a message.

Errors - only the most severe conditions are logged.

Log Level

Warnings - less severe conditions are logged.

Information - all errors, warnings, and information events are logged. This is the default setting.

Debugging - creates a log message each time the Client detects or reacts to an event. Be advised that log entries fill memory quickly if the Debugging level is chosen. Do not use the Debugging option for a significant length of time because most internal operations generate messages.

Defaults

Tap this button to return log settings to the default settings.

Use this option only as directed by technical support.

Disable Wireless Zero Config

Selecting this option disables other wireless utilities whether the Client is running or not. If not selected, other wireless utilities cannot apply their settings to the wireless card while the Client is running (although their status displays are usually unaffected). You will need to perform a soft reset whenever this setting is changed.

Port Manager Timeout

The interval at which the client polls the ports. This is used under different circumstances, for instance after physical changes such as card removal or insertion have been detected. This value should not be changed from the 10-second default unless so advised by technical support.

Server Tab

The Server identity tab defines the credentials the client uses to authenticate the server during TLS/TTLS/PEAP authentication message exchange. The Client uses this information to verify that the Client is communicating with a trusted server.

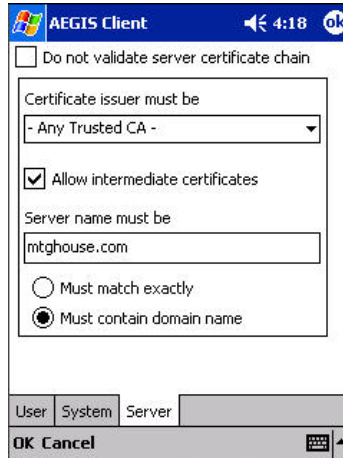

Field	Description
Do not validate server certificate chain	If this option is selected, the server certificate received during the TLS/TTLS/PEAP message exchange is not validated.
Certificate issuer must be	This is the certificate authority used during TLS/TTLS/PEAP message exchange. Any Trusted CA is the default selection and means that any certificate authority can be used during authentication.
Allow intermediate certificates	Both trusted intermediate certificate authorities and root authorities whose certificates exist in the system store are available for selection in the drop-down list.
Server name must be	This option is selected by default. It enables a number of unspecified certificates to be in the server certificate chain between the server certificate and the certificate authority indicated in the Certificate issuer must be field. This allows the server certificate received during negotiation to be issued directly by the certificate authority or by one of its intermediate certificate authorities. If disabled, then the selected Certificate issuer must have directly issued the server certificate.
Must match exactly	This is either the server name or the domain the server belongs to, depending on which option is selected below the text field.
Must contain domain name	During authentication, this name will be compared to the server certificate's Subject: CN field.
	When selected, the server name entered must match the server name found on the certificate exactly.
	When selected, the server name field identifies a domain and the certificate must have a server name belonging to this domain or to one of its sub-domains (e.g., zeelans.com, where the server is blueberry.zeelans.com).

Port Settings Area

In the Port Settings area, you configure network parameters for each port listed on the main screen; see [The Main Screen](#) on page 7-18.

Accessing the Port Settings Area

1. On the main screen, tap and hold on a port. The Port popup menu appears; see [Port Menu](#) on page 7-20.

2. Tap **Configure**. The Port Settings Configuration screen opens displaying the Wireless Networks tab.

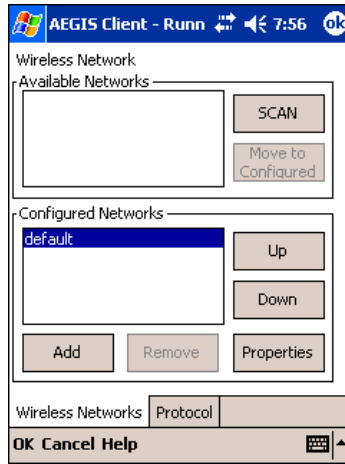

On this tab,
Wireless Networks Tab
Protocol Tab

You...
Set the parameters for Network Access Points and underlying protocol.
Configure common protocols that apply to any network the port connects to.

Wireless Networks Tab

Field **Description**

Available Networks Section

This section displays the networks the terminal recognizes as available to connect to. When the Client is first installed, there are no entries in the Available Networks list.

Tap this button to see a list of networks broadcasting their availability.

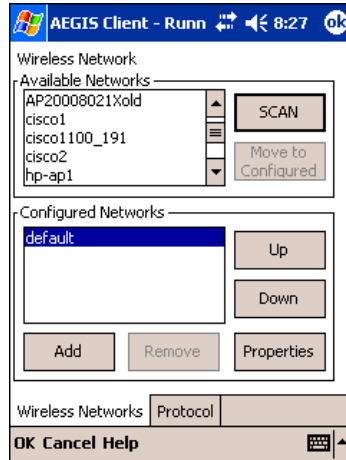

Scan

Note: You can also attach to networks who are not broadcasting.

This button activates only after **Scan** has been tapped and available networks have been retrieved.

Move to Configured

In the list of networks retrieved, select the network you wish to connect to, and tap **Move to Configured**. This selects the network, which now appears in the Configured Networks section.

Configured Networks section

This section displays the networks your terminal is connected to. This section enables you to add or remove networks as well as review and edit the properties of existing configured networks.

Default

When the Client is first installed, there is a Configured Network named "default" in the list. This profile has **Associate with any network** selected in its Properties selection screen.

If you are going to be in a location with only one access point (or more than one access point that attaches to the same network), the default profile may be sufficient for you needs, without necessitating the selection of a specific network or networks.

If **default** is last in the list, it can act as a wildcard should you be out of the range of your primary networks (which are listed first). Do not place **default** at the top or middle of the list because, if it is, connection to the other list entries will never be attempted.

Up

Tapping this button moves a selected network up one place in the list.

Down

Tapping this button moves a selected network down one place in the list.

Note: The order of the networks in this list is the exact order that connections will be attempted. The network listed first will be attempted first and so on. Place your primary networks first.

Tap this button to manually add a network to the Configured Networks list if

Add

- the access point does not broadcast its SSID or
- you are pre-configuring the client for an access point that is not currently in range.

For more information, see [Adding a Wireless Network Configuration](#) on page 7-30.

Remove

Tap this button to remove a selected network in the list.

Field **Description**

Properties

Tap this button to review the properties of a network selected in the list. This button opens the same network configuration screen as the **Add** button does; use it to edit network configuration properties.

Protocol Tab

The Protocol tab enables you to configure parameters that will apply to all the networks the selected port connects to.

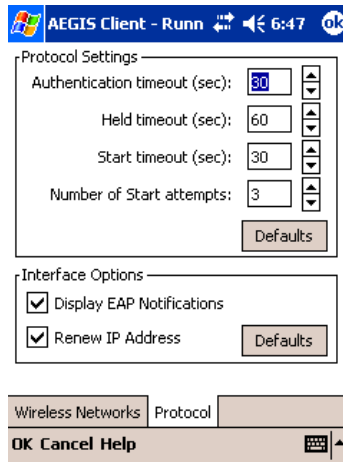

Field **Description**

Protocol Settings

These are the timer intervals and retry settings defined in the 802.1X standard. They determine how long the supplicant state machine will wait in a given state. These parameters shouldn't be modified without an understanding of the supplicant state machine. For more information about the supplicant state machine, obtain its 802.1X protocol specification.

The parameters are:

- **Authentication Timeout** - The period of time the Client remains in the authenticating or acquired state without receiving a response from the access point or switch.
- **Held Timeout** - The period of time the Client remains in the held state after failing authentication.
- **Start Timeout** - The period of time the Client remains in the connecting state before restarting when there is no response.
- **Number of Start Attempts** - The number of times the Client restarts before giving up. At that point, the Client then defaults to the authenticated state, but there will be no network connectivity because the protocol exchange was never completed.

Display EAP notifications

This option specifies that the EAPOL notification message will be displayed to the user. An authenticator may use such notification to inform you, for example, about a near password expiration. However, some authenticators send chatty and annoying notifications that may, for the convenience of the user, be suppressed. Note that all notifications are written to the event log even if they are not displayed.

Renew IP address

Select this option to initiate a DHCP request to obtain a dynamic IP address after a successful authentication, but only if the client detects that the connected network (the SSID) has changed. The result is that renewal should not occur upon re-authentication, but does occur at boot or when connecting to a different network. If you have a slow authenticator, you may wish to enable this option when configuring the service because a slow authenticator may prevent you from getting a DHCP-assigned IP address upon boot-up. This option is ignored if the given adapter has a static IP address.

Adding a Wireless Network Configuration

To add a wireless network configuration, on the main screen, tap and hold on the port, tap **Configure** on the Port popup menu, then tap **Add** in the Network Configurations section of the Wireless Networks tab. The Network Profile screen opens displaying the Profile Info tab.

The screenshot shows a window titled "AEGIS Client - Runn" with a status bar at the top showing signal strength, battery, and time (9:20). The main content area is titled "Profile Info" and contains the following fields and options:

- Network Profile:
- Network Name:
- Peer-to-Peer Group (ad hoc mode)
- Associate with any available network
- Do active scan
- Authentication profile:

At the bottom, there is a tabbed interface with three tabs: "Profile Info" (selected), "WEP Mgmt", and "WPA Settings". Below the tabs is a navigation bar with "OK", "Cancel", and "Help" buttons, and a keyboard icon.

On this tab,
Profile Info
WEP Mgmt
WPA Settings

You...
Enter basic profile information for your wireless connection.
Enter the WEP settings for your wireless connection - see page 7-31.
Enter the WPA settings for your wireless connection - see page 7-32.

Profile Info Tab

Field	Description
Network Profile	Enter the name of this record. This is the name that appears in the Configured Networks list and, by default, is the same as the broadcast SSID. Note that there is nothing special about the name "default." You could configure any other record similarly and it would behave the same way.
Network Name	This is the SSID of the access point. If the access point broadcasts its SSID, then this value may be derived from the Available Networks list. If the SSID does not broadcast, then you must manually enter the value here.
Peer-to-Peer Group (ad hoc mode):	Select this option to have two or more client workstations communicate with each other without the benefit of an access point. You should also select Do Active Scan and, in the WEP Management page, enable Use key for data encryption while entering a common key for both sides. WPA is not supported in this mode.
Do active scan	Select this option whenever the access point (or client, for ad hoc mode) is not broadcasting its SSID.
Authentication Profile	Select the Client Configuration (user) profile associated with this network. The drop-down list contains client profile names created in the User tab of the Client Configuration Area; see User Tab on page 7-23. To open the selected profile, select it in the drop-down list and tap View . The User tab opens displaying the profile details. If you tap OK (to save changes) or Cancel , you are returned to the Profile Info tab.

WEP Mgmt Tab

The WEP Mgmt tab enables you to set WEP parameters for each port.

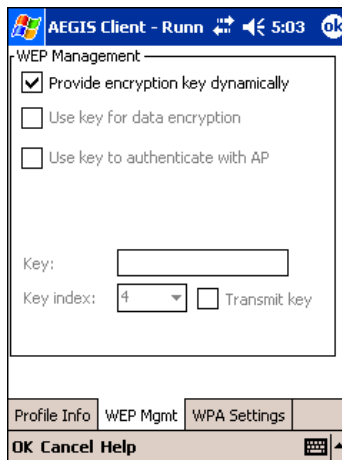

Note: The settings on this tab window are interrelated. This means that selecting one may disable access to others.

Field	Description
Provide encryption key dynamically	This option is selected by default. If this option is selected, the other WEP settings on this page are disabled. To enter a custom WEP, de-select this option. The other fields become active.
Use key for data encryption	Select this option to manually enter a WEP key to encrypt your data to the access point. You enter that key in the Key field below.
Use key to authenticate with AP	Select this option if your network does not support 802.1x authentication and you need to connect to the access point without username and password authentication. The key entered below is used to authenticate instead.

Field

Description

Key

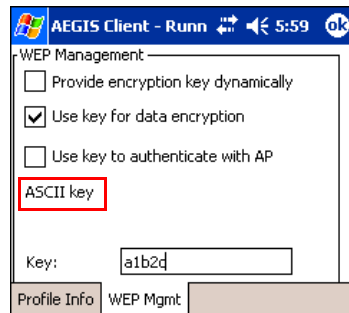

In this field, enter the WEP key:

ASCII - 5 or 13 characters

Hexadecimal - 10 or 26 characters.

When the key entered is in the correct format, the screen changes to display the type - ASCII or Hexadecimal.

Key Index/Transmit Key

The Key Index drop-down list contains the available keys. You may enter up to four keys for reception; the Client will try all four to find one that works with the access point.

From the drop-down list, select the key to be used for transmission as well. If the key selected is the transmit key, the **Transmit key** box is checked.

To change the transmit key, select another key and check the **Transmit key** box. The check box of the original transmit key will be automatically de-selected.

WPA Settings Tab

The WPA Settings tab enables you to configure WPA settings.

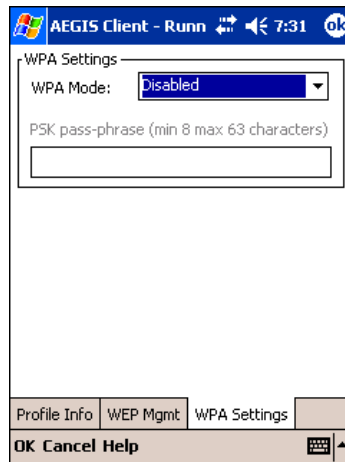

Field

Description

WPA Mode

This drop-down list contains the following options:

- **Disabled** - Do not enable WPA mode. This is the default selection.
- **WPA 802.1x** - Enable WPA and obtain key information through the 802.1x protocol.
- **WPA PSK** - Enable WPA with Pre-Shared Key (PSK) information entered in the field below. This mode is used if the 802.1x protocol is not being used for authentication.

PSK pass-phrase

This field activates if you select WPA PSK in the WPA Mode drop-down list.

Enter between 8 and 63 characters for your pass phrase. Asterisks appear as you type for increased security.

Logging

The event log is an ASCII text file named "LOG8021X.TXT" located in the directory defined by the WINDIR environment variable (usually the Windows directory). The information the log records is determined by the log settings on the System tab of the Client Configuration Area; see [System Tab](#) on page 7-25.

The format of the entries is

Time Stamp Message Text

The **Refresh** button at the bottom of the screen is used to update the log file while you are reading it. If the file gets too large, old entries are automatically deleted.

If you wish to start with a blank file, exit from the Client (so the icon no longer appears at the lower right of the screen) and delete the log file (log8021x) in File Explorer; see [Finding and Organizing Information](#) on page 4-23.

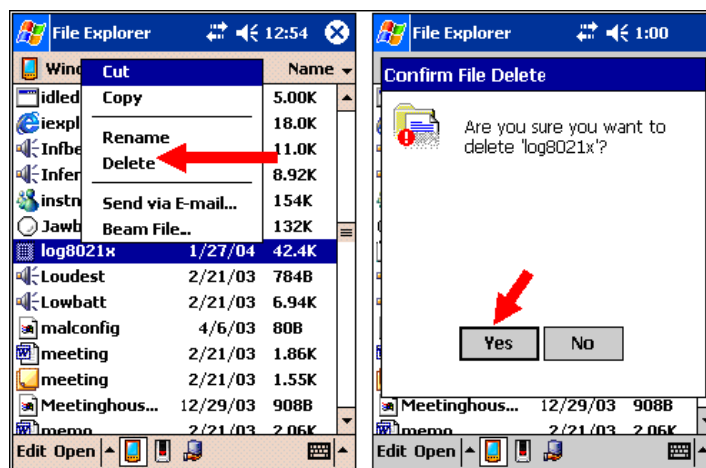

When you restart the Client, a new log file is created.

Installing Certificates with CertAdd

Certificate Requirements

During configuration, you may have specified one or two certificates to use during the authentication process. The specified identity should match the **Issued to** field in the certificate and should be registered on the authentication server (i.e., RADIUS server) that is used by the authenticator. In addition, your certificate must be valid on the authentication server. This requirement depends on the authentication server and generally means that the authentication server must know the issuer of your certificate as a trusted Certificate Authority.

If the selected certificate does require a password or pass phrase to decode the private key, enter this value in the “Certificate Pass Phrase” field. This value will be encrypted when the configuration is saved. However, on some systems, there may not be a certificate. If that is the case, you can use the section below as a primer on OS X certificate management.

About CertAdd

CertAdd is a stand-alone utility included with the Client that allows certificates to be selected and installed on a Windows Mobile device.

Installing Certificates with CertAdd

Client or Certificate Authority (CA) certificates can be imported from *.cer (same as *.der), *.p7b, or *.pfx files.

1. Download the certificate file to the My Documents folder. The location isn't critical, although you may want to create a standard folder for consistency.
2. Go to **Start > Programs > Meetinghouse Certificate Installer**. The opening screen is displayed. All valid certificate file types located in the My Documents folder appear in the list.

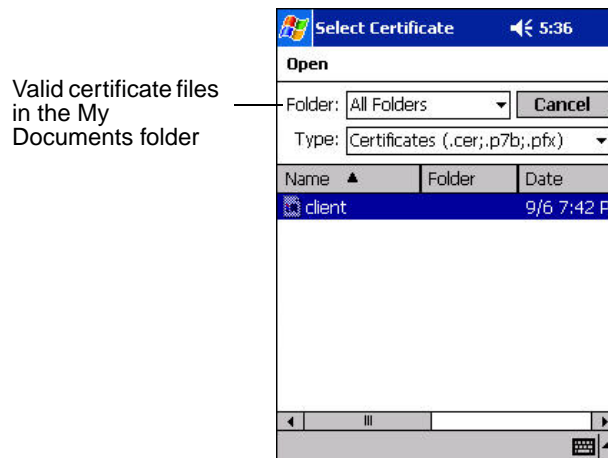

3. Tap and hold on a certificate in the list. A pop-up appears asking if you want to install the certificate.
4. Tap **OK**. The certificate is loaded into the correct certificate store.

Advice and Workarounds

Issue	Possible Causes and Solutions
The Client will not start on the device with an error message about missing files.	Perform a soft reset.
The wireless network interface (port) does not appear in the main AEGIS screen.	<ul style="list-style-type: none"> • The license is not valid (If you have entered a time-limited license, is your clock on the device correct?). • Restart the client - on the main screen tap Client > Restart. • Perform a soft reset. • If the radio is turned off or the radio card is not present, this will sometimes cause the port name to not appear. • If the radio driver is very old and does not support NDIS 5.1 commands, the Client may not be able to detect it.
The wireless network interface appears, but when I select it and go to the "configure" menu, the Scan button is disabled.	Power up the radio; see Powering Up a Radio on page 4-17.
The client is not attaching to the correct access point.	<p>The default network profile instructs the client to attach to the first available access point. You must select a network, move it to the Configured Networks list, and then move it above default in the list using the up arrow buttons.</p> <p>For more information, see Wireless Networks Tab on page 7-28.</p>
The Client is failing authentication even though all my information was entered correctly.	<ol style="list-style-type: none"> 1. Verify that the network profile for the access point corresponds to the authentication profile you created for it. <ul style="list-style-type: none"> • Select the network profile in the Configured Networks list. • Tap Properties. The Profile Info tab opens - see page 7-31. • In the Authentication profiles drop-down list, select the profile you want to review. • Tap View. The User tab appears displaying the profile's information. 2. Verify that you have configured the identity and password into the correct fields on the User tab (page 7-31) in the authentication profile. If you are using PEAP or TTLS, the username and password are entered in the Tunneled authentication section.
My Access Point does not broadcast its SSID. Even though I have manually configured an access point with that name, the Client won't associate with it.	<ul style="list-style-type: none"> • Make sure that the desired SSID is listed as the Network Name, not the Network Profile (which is a screen label) • Verify that Do Active Scan is selected on the Profile Info tab; see Do active scan on page 7-31. Otherwise, the Client will not attempt to find the access point.
I am authenticated, but I don't get an IP address through DHCP.	On the main screen, tap and hold on your access point, tap Configure on the popup menu, and select the Protocol tab. Verify that Renew IP Address is selected; see Renew IP address on page 7-29.
I cannot attach to my old network that does not support 802.1x authentication, but is using WEP encryption.	<ul style="list-style-type: none"> • Verify that you can see your SSID in the Available Networks list on the Wireless Networks tab. Move the SSID to the top of the Configured Networks list so that it is accessed first. If the SSID is not there, you can add it manually and enter the SSID as the network name - page 7-28 • Select the SSID and tap Properties. • On the Profile Info tab, select Do active scan if your access point does not broadcast its SSID. • On the WEP Mgmt tab, select Use key for data encryption and Use key to authenticate with AP. • Enter the WEP Key - see Key on page 7-32. • On the Protocol tab, select Renew IP Address (unless you have entered one manually separate from the Client) • Note that the port status indicator in the main screen reads "Associated," not "Authenticated" when the connection is complete; although the log file will indicate "Entered AUTHENTICATED state."

Advice and Workarounds

Issue	Possible Causes and Solutions
I made changes, but they do not appear to have taken effect.	Always tap OK before exiting a screen you have changed. Then restart the Client from the Client menu on the main screen.
How do I enable peer-to-peer (ad-hoc) mode to have two clients communicate without an access point?	<ul style="list-style-type: none"> • On the Wireless Networks tab, add a new profile to the Configured Network list. • On the Profile Info tab, give each side the same network name (SSID). • Select Peer-to-Peer Group (ad hoc mode) and Do active scan. • On the WEP management section, select Use key for data encryption and enter an identical key for both clients. • Verify that this network profile is the first (or only) one in the Configured Network list and try to restart both clients at roughly the same time.

How 802.1X Works

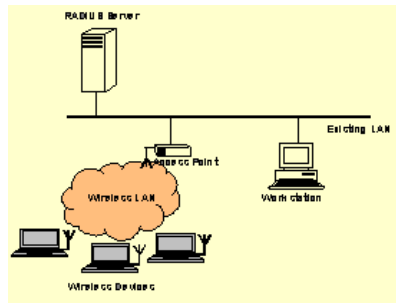

The network elements in the above graphics are those involved in a typical wireless LAN. When 802.1X is running, a wireless device must authenticate itself with the access point in order to get access to the Existing LAN. With respect to the terms used in the 802.1X standard, access points (APs) function as authenticators and wireless devices function as supplicants. The authenticator keeps a control port status for each Client it is serving. If a Client has been authenticated, its control port status is said to be Authorized, and the Client can send application data to the LAN through the AP. Otherwise, the control port status is said to be Unauthorized, and application data cannot traverse the AP.

Typical Message Exchange Using MD5 or TLS

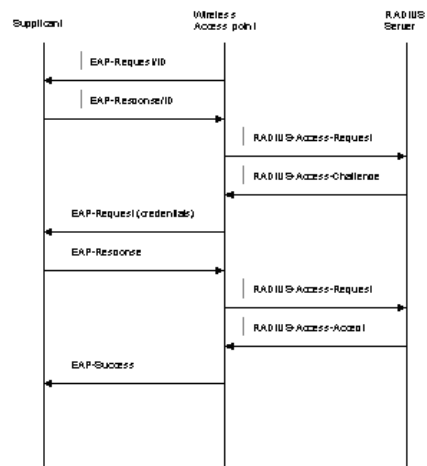

The above graphic displays the typical message exchange when the device and the AP support 802.1X. When an AP acting as an authenticator detects a wireless station on the LAN, it sends an EAP-Request for the user's identity to the terminal. In turn, the terminal responds with its identity, and the AP relays this identity to an authentication server, which is typically an external RADIUS server.

The RADIUS server can then act as a central repository of user profile information. Such use of a centralized authentication server allows the user to access wireless LANs at many different points, but still be authenticated against the same server. In response to the Access-Request, the RADIUS server sends an Access-Challenge to the AP, which is then relayed in the form of an EAP-Request to the device. The device sends its credentials to the AP, which in turn relays them to the RADIUS server. The RADIUS server determines whether access to the network is accepted or denied based on the Client's credentials.

Typical Message Exchange Using TTLS and PEAP

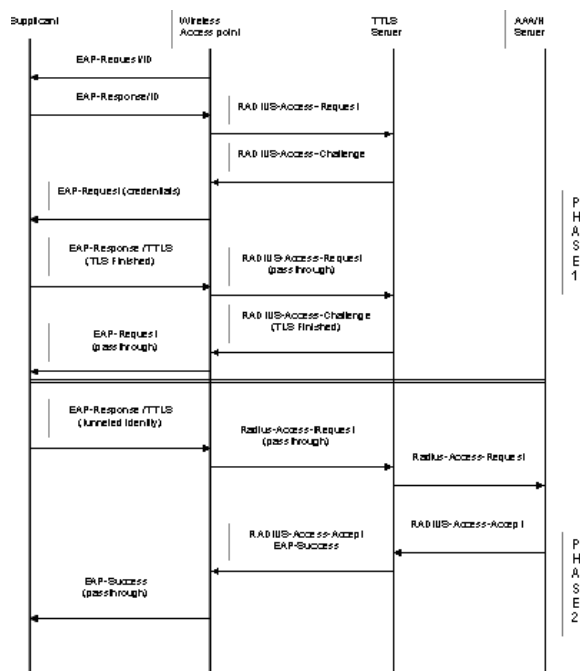

The above graphic shows a typical message flow for a TTLS transaction. TTLS authentication comprises two phases. In Phase 1, TLS is used to authenticate the TTLS server to the client. The TTLS server may optionally request authentication of the client's certificate, but by default the client verifies only the server's certificate. The TLS handshake is negotiated between the client and the TTLS server. Following the TLS handshake, Phase 2 may proceed using a secure channel (tunnel) provided by the TLS record layer. The secure tunnel is then used to exchange information for the negotiation of the following legacy protocols: EAP-MD5, PAP, CHAP, MS-CHAP, or MS-CHAPV2 (subject to support by the AAA server). A TTLS server may perform the authentication, or the information may be de-tunneled and passed on to an AAA server. The AAA server is the server in the user's home domain where authentication and authorization are administered.

PEAP works in the same manner as TTLS. However, supports different legacy protocols within the encrypted Phase 2 tunnel. Currently the tunneled protocols are EAP-MSChapV2 and EAP-TLS/SmartCard. Like TTLS, the use of a client certificate is optional, if one is used, the same certificate is used for Phase 1 and Phase 2. The client certificate is optional for both phases.

Benefits of 802.1X

Central User Administration

The Client allows network administrators to continue to use RADIUS or another AAA server as their centralized authentication server. In 802.11b, where authentication took place between the access point and the station, there was no concept of passing credentials from the access point to an authentication server. For LANs this was fine. However, as users began to use their devices in remote locations, the security provided became inadequate. 802.1X solves this problem by allowing access points to pass client credentials to the appropriate authentication server.

For example, the following graphic displays the authentication flow for a mobile user who wishes to create a virtual private network with his home office.

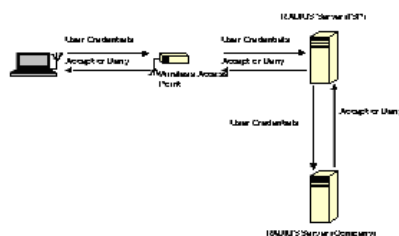

By using the Client, the user can associate with a wireless network provided by a third party, in this case the ISP. We assume that the company and the ISP have established a service relationship beforehand. When the ISP receives the user's credentials, the ISP proxies the credentials to the company's AAA server, which returns a message telling the ISP to either accept or deny the user access. This response is then propagated to the remote user.

Dynamic Session Specific Wireless Encryption Keys

There have been many published reports recently about the lack of security provided by the Wired Equivalent Privacy (WEP) protocol. One of the problems with WEP is that the shared key used by the station and the access point is inherently static. That is, this shared key will only change if it is manually reconfigured on both devices. The Client remedies this by supporting the Transport Layer Security (TLS) protocol. TLS ensures that a new shared key is generated each time a station associates itself with an access point. TLS has proven itself an excellent authentication and encryption protocol in commercial environments. The Client also supports the MD5 and TTLS security protocols.

Additional Advantages of TTLS and PEAP

The Client provides the advantage of Tunneled TLS (TTLS) and PEAP support. These protocols provide the security of TLS with greatly reduced administrative load. Security is enhanced by never passing user ID and password in the clear. No "real" user ID or password is required in Phase 1. After the secure tunnel is established, Phase 2, user credentials are passed in safe, encrypted form. To further enhance security, the WEP keys, which encrypt the data between the wireless card and the AP, may be automatically changed on a per-session basis, limiting the time available to an unauthorized sniffer to crack the keys. By limiting the session time (the reauthentication period), the keys can essentially be made uncrackable.

Administration is eased by greatly reduced certificate requirements in comparison to TLS. In TLS, each client must have a client certificate to pass to the server, and a CA certificate with which to verify a server certificate, while the server must have a client certificate from each user and CA certificates for each possible CA chain and its own server certificate. TTLS and PEAP require only that a single server certificate be created for the server to present to the client, and that the client have a CA certificate to verify the server. Because these are the same for each client on the network, they are easily managed, unlike TLS, where every client certificate is unique. TTLS and PEAP thus provide the security of a TLS channel without the need for managers to distribute and manage client certificates. Lastly, TTLS allows for the use of existing legacy authentication protocols. Administrators may continue to use established authentication databases.

Cisco LEAP

The message exchange used by Cisco LEAP is proprietary. This protocol is not a standard EAP type, but is supported by the Client through a licensing arrangement with Cisco.

Relative Merits of Authentication Protocols

MD5 is the least secure of the EAP protocols as it only does a one-way authentication, and does not support automatic distribution and rotation of WEP keys, increasing the administrative burden of manual WEP key maintenance.

TLS, while the most secure EAP protocol, requires client certificates to be installed on each wireless client. Establishing and maintaining this PKI infrastructure is normally a burden most administrators do not feel is worth the extra level of security gained.

TTLS and PEAP bypassed the certificate issue by tunneling TLS, and thus eliminating the need for a certificate on the client side. PEAP supports only EAP-compliant authentication protocols within the tunnel structure, and is rapidly becoming the most widely supported of the EAP methods. TTLS supports pre-EAP authentication protocols within the tunnel structure, and should be used in those circumstances when pre-EAP interior protocols are desirable.

LEAP is a pre-EAP, Cisco-proprietary protocol, with many of the features of EAP protocols. Cisco controls the ability of other vendors to implement this protocol, so it should be selected for use only when limited vendor choice for client, access-point, and server products is not a concern.

Differences Between Protocols

Security Feature	MD5 Challenge	TLS	TTLS	PEAP	LEAP
Client -side certificate required?	No	Yes	No	No	No
Server-side certificate required?	No	Yes	No	Yes	No
Dynamic WEP Re-keying	No	Yes	Yes	Yes	Yes
Mutual or One-way Authentication?	One-way	Mutual	Mutual	Mutual	Mutual
Support of non-EAP protocols within a secure tunnel?	N/A	N/A	Yes	No	N/A
Relative Deployment Complexity	Simple	Difficult	Moderate	Moderate	Moderate
Relative Security	Poorest	Highest	High	High	High

Overview

Dolphin 9500 Series terminals are available with a Bluetooth radio for WPAN (Wireless Personal Area Network) usage. When the mobile computer is first initialized, the *.cab file and module for Bluetooth are installed.

Powering Up the Bluetooth Radio Driver

Before using the radio, make sure that the Bluetooth radio is powered up. When the radio driver is powered up, the Bluetooth icon appears in the task tray on the Today screen.



Radios are powered up in the Radio Manager utility; see [Powering Up a Radio](#) on page 4-17.

Setting Up Your Bluetooth Card

Note: If you use the Get Connected! Wizard, which is recommended for normal usage, then this step is not necessary. This step would be used to change the friendly name of your mobile computer.

1. Tap the Bluetooth icon that appears in the task tray on the Today screen.
2. In the pop-up menu, select **Advanced Features**, then **My Bluetooth Device**. (If you installed OBEX, the menu also lists Transfer via Bluetooth.)



3. In the **My Bluetooth Device** screen, you can modify the **Friendly Name** and make any desired configuration changes. When done, tap **OK**.



- In normal phone connect operation, **Discoverable** mode is not needed and should be disabled.
- If you do enable **Discoverable** mode (e.g., for ActiveSync), note that it does not shut off by itself. To save power, remember to disable it when not needed.
- **Connectable**, **Use Authentication**, and **Use Encryption** are also not required for printing or dial-up networking applications.
- Check Use **Authentication** to enable the **Use Encryption** option.

Assign COM Ports

Follow these steps to view and/or modify the Bluetooth COM ports. If you are not going to use the IrDA port, you can disable it to free up a port for Bluetooth devices; see [Using Infrared](#) on page 6-5.

1. Tap on the Bluetooth icon on the Today screen. Select **Advanced Features** then **My Bluetooth Device**.

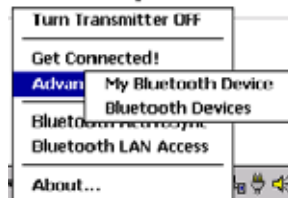

Note: If you installed OBEX, the menu also lists Transfer via Bluetooth.

2. The **My Bluetooth Device** screen appears. Tap on the **COM Ports** tab.



3. As needed, view and/or enable/disable the Bluetooth COM port assignments. Tap **OK**.



Note: The Bluetooth Phone port cannot be disabled. For more information about COM ports, see the [Com Port Assignment Table](#) on page A-12.

Discover Bluetooth Device(s)

Follow these steps to discover other Bluetooth devices nearby, including non-phone devices. The Device Discovery Wizard is a more detailed alternative to using the Bluetooth "Get Connected!" Wizard or Bluetooth ActiveSync or Bluetooth LAN Access options. The Device Discovery Wizard allows you to discover any type of Bluetooth device.

1. If not open, launch the **Bluetooth Devices** folder. Tap on the Bluetooth icon on the **Today** screen. Select **Advanced Features** then **Bluetooth Devices**.

- In the **Bluetooth Devices Folder**, tap on the **Device Discovery** icon. Or you can tap on **Tools**. In the pop-up menu, select Device Discovery.
- Follow the Bluetooth Device Discovery Wizard to search for Bluetooth devices nearby. When prompted, select the device type you seek.



- When the search is complete, a screen reports the discovered Bluetooth devices. Check the box next to any device you wish to save information about, (i.e., any devices you wish to connect to). Tap **Next**.

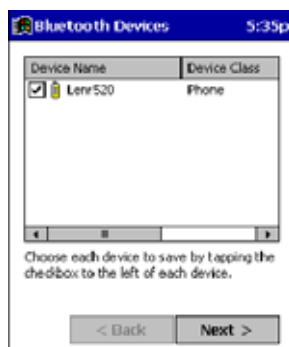

- A service discovery phase begins, 5-10 seconds per chosen device.
- In the next screen, tap **Finish**.

Bond With Discovered Device(s)

Follow these steps to bond with an already discovered Bluetooth device. In most cases, bonding is for establishing secure communications with a Bluetooth-enabled phone. This is a more detailed alternative to using the Bluetooth "Get Connected! Wizard."

Important!

- Do not try to bond with a Motorola Timeport 270C or Nokia 6310!
 - Do not use this method to bond with a printer! The third-party printing software included on the installation CD also handles bonding.
- If not open, launch the **Bluetooth Devices** folder. Tap on the Bluetooth icon in the Today screen. Select **Advanced Features**, then **Bluetooth Devices**.

-
2. Tap and hold your stylus on the Bluetooth device you want to bond with. In the pop-up menu, select **Bond**.



3. Alternatively, after selecting a device, tap on the **Bond** icon. Or tap on **Device**, then select **Bond**.

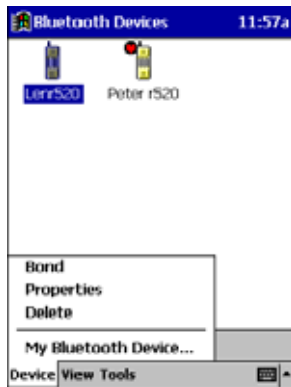

4. The **Bluetooth Device Bonding Wizard** launches. Follow the wizard to bond with your selected device.



5. As prompted, make sure the Bluetooth device that you want to bond with is in *Bondable* mode.



6. If the remote device is set up to accept bonding, a **Bluetooth Passkey** screen appears. To continue bonding, enter the correct passkey and tap **Reply**.



7. When you have successfully bonded with the other device, tap **Finish**.

View Device Properties

Follow these steps to view the properties of an already discovered device.

1. If not open, launch the **Bluetooth Devices** folder. Tap on the Bluetooth icon on the Today screen. Select **Advanced Features** then **Bluetooth Devices**.
2. Select a device. Tap on the **Properties** icon, or tap on **Device** then select **Properties**. Alternatively, you can tap and hold your stylus on the Bluetooth device you want to view information about. In the pop-up menu, select **Properties**.



- Use the **General** and **Services** screens to research device properties. If needed, assign a new device type icon by tapping on the arrow buttons in the **General** screen. You can also use the **Device name** field to rename the device. When done, tap **OK** for the setting to take effect.



Set Up Your Favorite Device

Follow these steps to set up default devices in the **Bluetooth Devices** folder. Please note that the Get Connected! Wizard automatically assigns the favorite phone.

Complete these steps:

- Tap on **Tools** and select **My Favorites**.
- Tap on the tab for the type of device you would like to set a favorite for. If needed, use the arrow buttons to scroll and find the tab you need.

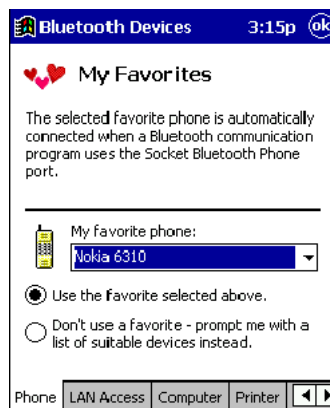

Note: Tabs appears only for COM ports you have enabled. To enable a port, refer to the "Assign COM Ports" section earlier in this chapter.

- To select a favorite device, select **Use the favorite selected above**. In the drop-down list, select your device. Tap **OK**.
- After setting a device as your favorite, its icon appears in the Bluetooth Devices folder with a heart next to it.

Change Views

You can switch between the **Large Icons** or **Details** views for the **Bluetooth Devices** folder.

- In Bluetooth Devices, tap on **View**.

2. In the pop-up menu, choose between **Large Icons** or **Details**.

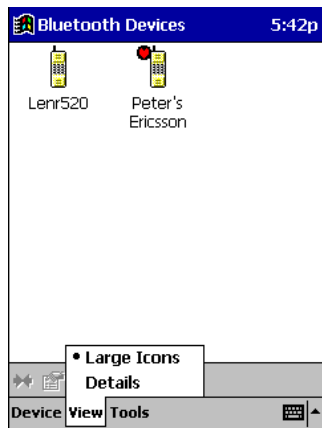

Large Icons

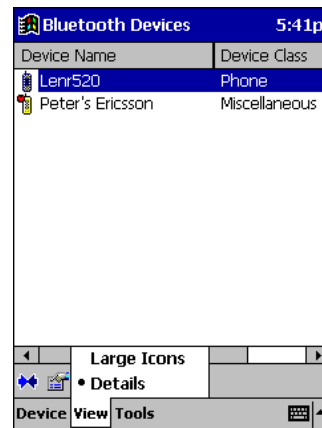

Details

Note: In Details view, you can see the Device Class and scroll right to see the current Bonded status.

Delete a Device From the Folder

If you no longer plan to connect with it, you can delete a device from the **Bluetooth Devices** folder.

1. If not open, launch the **Bluetooth Devices** folder.
2. Tap and hold your stylus on the device you wish to delete. In the pop-up menu, select **Delete**.



3. Alternatively, after selecting a device, tap on the **Delete** icon. Or tap on **Device** then select **Delete**.
4. A Confirm screen appears. Tap **Yes**.

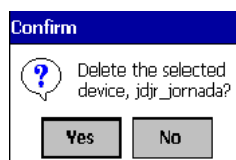

Turn Radio Transmitter ON/OFF

You may want to turn off the radio transmitter to save power or if you are entering an area with radio restrictions (e.g., an airplane).

1. The Bluetooth icon should appear in the task tray on the **Today** screen. Tap on the icon.

-
- In the pop-up menu, select **Turn Transmitter OFF**.

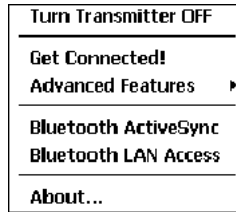

- The Bluetooth Card radio transmitter shuts off. The Bluetooth icon in the task tray becomes gray, as well as relevant menu options (e.g., Get Connected!).
- To turn the radio transmitter back on, tap on the gray **Bluetooth** icon. In the pop-up-menu, select **Turn Transmitter ON**.

Bluetooth ActiveSync

This section explains how to use the Bluetooth ActiveSync feature. It helps you quickly and easily ActiveSync to a notebook or desktop computer with ActiveSync v3.x installed.

- Tap on the **Bluetooth** icon. In the pop-up menu, select **Bluetooth ActiveSync**.

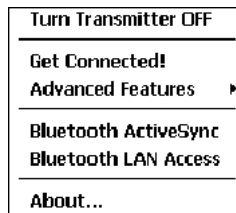

- The next screens varies depending on if your Bluetooth Devices folder contains any computers, and if one is chosen as your favorite. Please refer to the appropriate scenario:

SCENARIO #1: Your Bluetooth Devices folder contains a favorite desktop computer.

- When you tap **Bluetooth ActiveSync**, your mobile computer automatically tries to connect to your favorite computer.
- The Connect To screen appears, reporting that it is trying to connect to Wireless ActiveSync.

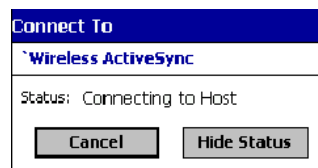

- After a successful connection is made, the status screen reports Connected. Now you are ready to synchronize files, if desired.

SCENARIO #2: Your Bluetooth Devices folder contains no favorite desktop computer.

- (a) When you tap on **Bluetooth ActiveSync**, a screen appears that allows you to choose which computer to connect to in your Bluetooth Devices folder. Choose a computer from the list and tap **Select**, or tap **Find** to search for another computer.



*Note: If the computer you want to connect to is not listed, tap **Find** to begin a search. Proceed as described in Scenario #3 on page 8-9.*

- (b) Your mobile computer attempts to connect to your selected computer.

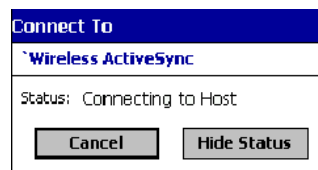

- (c) After a successful connection is made, the status screen reports Connected. Now you are ready to synchronize files, if desired.



SCENARIO #3: Your Bluetooth Devices folder contains no computers.

- (a) When you tap on **Bluetooth ActiveSync**, a Bluetooth Device Search automatically begins.

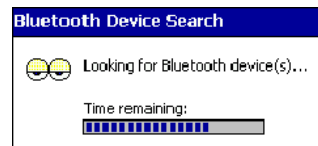

Note: You can also start the device search by tapping Find in the Bluetooth Devices screen.

- (b) After the search is complete, select the computer you wish to ActiveSync with and tap **Select**. If the computer is not listed, make sure the computer is discoverable and tap **Refresh** to search again.

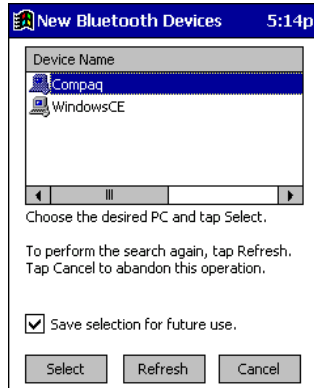

- (c) After you tap **Select**, a service discovery phase begins.
(d) The Connect To screen appears, reporting that it is trying to connect to Wireless ActiveSync.

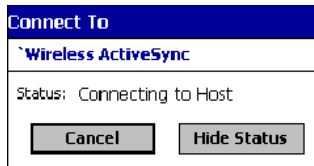

- (e) After a successful connection is made, the status screen reports Connected. Now you are ready to synchronize, if desired.

Bluetooth LAN Access

This section explains how to use the Bluetooth LAN Access feature to quickly and easily connect to a Bluetooth-enabled LAN access point.

1. Tap on the **Bluetooth** icon. In the pop-up menu, select **Bluetooth LAN Access**.

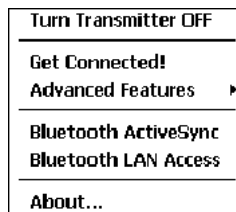

2. The next screens varies depending on if your Bluetooth Devices folder contains any access points, and if one is chosen as your favorite. Please refer to the appropriate scenario:

SCENARIO #1: Your Bluetooth Devices folder contains no favorite access point.

- (a) When you tap Bluetooth LAN Access, a screen appears that allows you to choose which access point to connect to in your Bluetooth Devices folder. Choose an access point from the list and tap **Select**.



Note: If your access point is not listed, tap Find and proceed as described in Scenario #3.

- (b) Your mobile computer tries to connect to the selected access point.

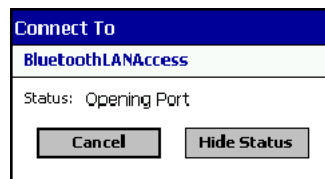

- (c) If your LAN requires a passkey, a screen appears asking for the passkey. Enter the passkey, then tap **OK**.
(d) After a successful connection is made, the status screen reports Connected.



- (e) Now you are ready to access your LAN for Internet access, files, etc.

SCENARIO #2: Your Bluetooth Devices folder contains a favorite access point.

- (a) When you tap **Bluetooth LAN Access**, your mobile computer automatically tries to connect with your favorite access point.

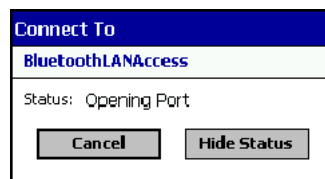

- (b) If your LAN requires a passkey, a screen appears, asking for the passkey. Enter the passkey, then tap **OK**.

(c) After a successful connection is made, the status screen reports Connected.

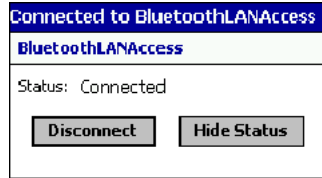

(d) Now you are ready to access your LAN for Internet access, files, etc.

SCENARIO #3: Your Bluetooth Devices folder has no access points.

(a) When you tap **Bluetooth LAN Access**, the mobile computer automatically begins to search for new Bluetooth devices.

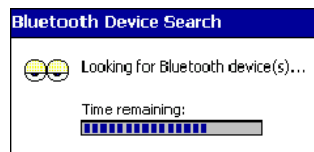

Note: You can also start the device search by tapping Find in the Bluetooth Devices screen. See Scenario #2 on page 8-8.

(b) After the search is complete, select the access point you wish to connect to. Tap **Select**. If the access point is not listed, tap **Refresh** to search again.



(c) After you tap **Select**, a service discovery phase begins.



(d) If the LAN requires a Passkey, a screen appears, asking for the Passkey. Enter the passkey, then tap **OK**.

(e) After a successful connection is made, the screen reports Connected.



(f) Now you are ready to access your LAN for Internet access, files, etc.

OBEX

This section explains how to use the OBEX (object exchange) application to trade business cards, contacts or files with another Bluetooth device that supports OBEX.

Bluetooth OBEX application supports five operations:

- Exchange Business Cards
- Send a Contact
- Send a File
- Browse Remote Device
- Receive Contact or File
- Enable File Sharing

The first four operations - exchange business cards, send a contact, send a file, and browse remote device - are client-oriented. They involve initiating an object exchange.

The last two operations - receive contact or file and enable file sharing - are server-oriented. They involve accepting objects in an exchange initiated by another Bluetooth device.

Exchange Business Cards

1. Make sure both Bluetooth devices have a business card assigned to them.

Note: If each device does not have a business card assigned to it, you cannot exchange business cards.

To assign a business card to your mobile computer, do the following:

- Tap on the **Bluetooth** icon. In the pop-up menu, tap **Advanced Features > My Bluetooth Device**.
- Tap on the **Object Sharing** tab. Under My business card, tap **Assign**



- In the next screen, select your business card and tap **OK**. If your business card is not listed, tap **Contacts** to create one.

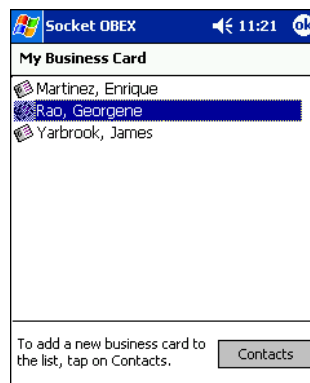

When you return to the Object Sharing screen, tap **OK**.

2. Make sure the other Bluetooth device is set up to receive a contact. The device must support the OBEX Object Push profile.

*Note: If the other device is also using the Bluetooth Connection Kit, you can set it up to receive a contact by tapping the **Bluetooth** icon. In the pop-up menu, tap **Transfer via Bluetooth > Receive Contact or File**.*

3. Now you are ready to exchange business cards. Tap on the **Bluetooth** icon. In the pop-up menu, tap **Transfer via Bluetooth > Exchange Business Cards**.



4. If your mobile computer has no devices in the Bluetooth Devices Folder, then it begins to search for Bluetooth devices nearby.
5. Select the Bluetooth device you wish to exchange business cards with. If the device is not listed, tap **Find**.



6. Your mobile computer begins to exchange business cards. After the exchange, the new business card should appear in your Contacts list.

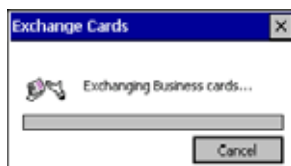

Send a Contact

1. Make sure the other Bluetooth device is set up to receive a contact. It must support the OBEX Object Push server profile. Refer to the documentation that came with the device for instructions.

*Note: If the other device is also using the Bluetooth Connection Kit, you can set it up to receive a contact by tapping the **Bluetooth** icon. In the pop-up menu, tap **Transfer via Bluetooth > Receive Contact or File**.*

2. Now you are ready to send a contact. Go to your Contacts folder.

3. Tap and hold your stylus on the contact(s) you would like to send. In the pop-up menu, select **Send Via Bluetooth**.

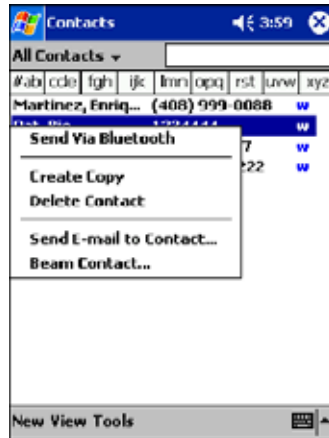

4. If your mobile computer has no devices in the Bluetooth Devices Folder, then it begins to search for Bluetooth devices nearby.

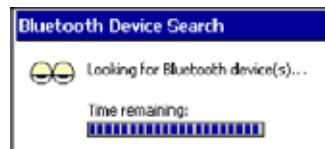

5. Select the Bluetooth device you wish to send the contact(s) to. If the desired device is not listed, tap **Find**.



6. Your mobile computer processes and send the contact(s).

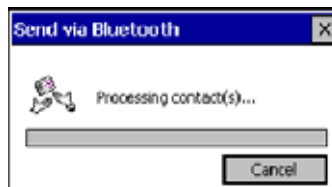

Send a File

1. Make sure the other Bluetooth device is set up to receive a file. It must support the OBEX Object Push server profile. Refer to the documentation that came with the device for instructions.

Note: If the other device is also using the Bluetooth Connection Kit, you can set it up to receive a file by tapping the **Bluetooth** icon. In the pop-up menu, tap **Transfer via Bluetooth > Receive Contact or File**.

- Now you are ready to send a file. Tap on the **Bluetooth** icon. In the pop-up menu, tap **Transfer via Bluetooth > Send a File**.

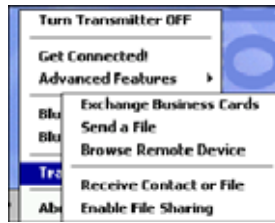

- If your mobile computer has no devices in the Bluetooth Devices Folder, then it begins to search for Bluetooth devices nearby.

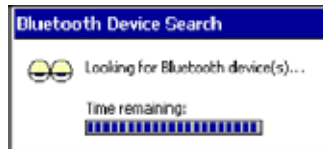

- Select the Bluetooth device you wish to send a file. If the desired device is not listed, tap **Find**.



- In the next screen, tap on the file you wish to send. You can use the **Folder** and **Type** drop-down menus to search for your file. Also, you can scroll horizontally to view the folder, date, size, type, and location of each file.

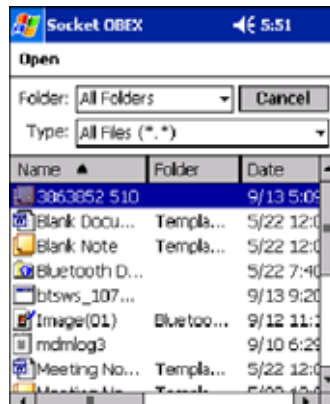

6. Your mobile computer sends the file.



Browse Remote Device

The Bluetooth File Explorer lets your mobile computer share files with another Bluetooth device. The other device must support the OBEX File Transfer server profile.

This section covers the following file transfer operations:

- Prepare for file transfer
- Send/receive file(s) or folder(s)
- Create a folder
- Delete file(s) or folder(s)
- Refresh remote view
- Connect/disconnect
- Exit the program

Note: "Local device" refers to the mobile computer you are running the OBEX from. "Remote device" refers to the Bluetooth device you are trying to transfer files with.

Prepare for File Transfer

1. Make sure the remote device has file sharing enabled. It must support the OBEX File Transfer server profile.

*Note: If the other device is also using the Bluetooth Connection Kit, you can enable file sharing by tapping the **Bluetooth** icon. In the pop-up menu, tap **Transfer via Bluetooth > Enable File Sharing**.*

2. Now you are ready to browse the remote device. Tap on the **Bluetooth** icon. In the pop-up menu, tap **Transfer via Bluetooth > Browse Remote Device**.

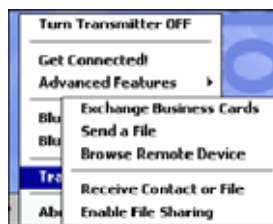

3. If your mobile computer has no devices in the Bluetooth Devices Folder that supports OBEX File Transfer, then it begins to search for Bluetooth devices nearby.



4. Select the Bluetooth device you wish to browse. If the desired device is not listed, tap **Find**.



5. Your mobile computer begins to establish a file sharing connection.



6. After the devices successfully connect, the Bluetooth File Explorer appears. Half of the screen shows contents of the remote device, while the other half shows contents of your device (the local device). The very bottom of the screen reports the connection status.

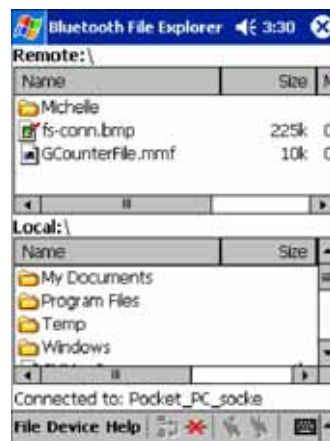

Send/Receive File(s) or Folder(s)

- Single-tap items to select them for transfer.
- Double-tap on a folders to open it and see its contents.

1. Select the file(s) or folder(s) that you wish to transfer. You can select items from only one device per transfer session.

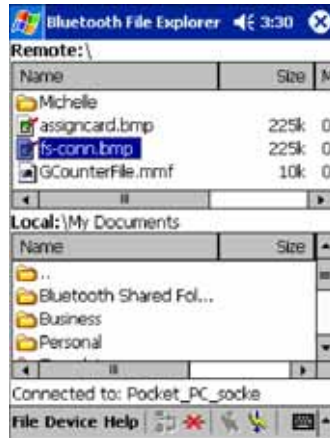

2. There are two different ways to initiate the transfer:
 - Tap on the **File** menu. Select **Send to remote** or **Get from remote**, as applicable. The inappropriate option should be gray.
 - Tap on the **Send to remote** icon or **Get from remote** icon, as applicable. The inappropriate icon should be gray.
3. A screen reports the status of the transfer.



4. After the transfer, a copy of each selected item should appear in the other device.

Create a Folder

1. Tap on the **File** menu. Select **Remote device** or **Local device**, wherever you want to create a folder, then tap **Create remote folder** or **Create local folder**, as applicable.

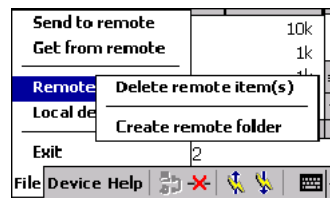

2. You can also tap and hold your stylus on an item in either the remote or local device that you wish to put in a new folder. In the pop-up menu, select **Create folder**.

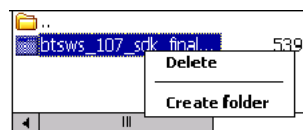

3. In the next screen, enter a name for your new folder. Tap **OK**.



4. The new folder should be listed under the appropriate device.

Delete File(s) or Folder(s)

1. Select item(s) that you wish to delete. You can only delete item(s) from one device at a time.
2. Tap on the **File** menu. Select **Remote device** or **Local device**, wherever the item(s) are located, then tap **Delete remote item(s)** or **Delete local item(s)**, as applicable.

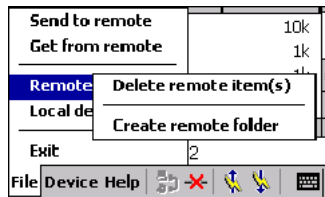

3. Tap and hold your stylus on an item in either the remote or local device that you wish to put in a new folder. In the pop-up menu, select **Delete folder**.

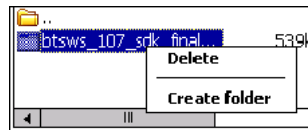

4. In the Confirm screen, tap **Yes**.

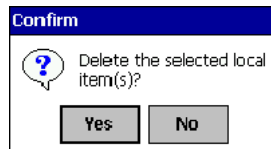

Refresh Remote View

1. Tap on the **Device** menu. Select **Refresh remote view**.



2. Your local device begins to read the contents of the remote device.
3. After a few seconds, the contents view of the remote device is refreshed.

Connect/Disconnect

To connect to the remote device, do the following:

1. Make sure the remote device has file sharing enabled.
2. Start the connection process by either of two methods:
 - Tap on the Device menu. Select Connect.
 - Tap on the Connect icon.
3. In the next screen, select the device you wish to connect to. Tap **Select**. Your mobile computer attempts to connect to the device selected.

To disconnect from the remote device, do the following:

1. Start the disconnection process by either of two methods:

- Tap on the **Device** menu. Select **Disconnect**.
- Tap on the **Connect** icon.

2. Your mobile computer disconnects from the remote device. Afterwards, no contents are listed for the remote device.

Exit Bluetooth File Explorer

To exit the Bluetooth File Explorer, tap **File > Exit**.

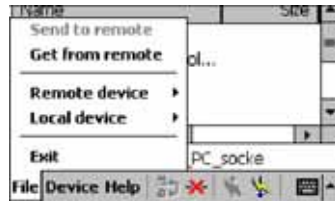

Receive Contact or File

1. Tap on the **Bluetooth** icon. In the pop-up menu, tap **Transfer via Bluetooth > Receive Contact or File**.

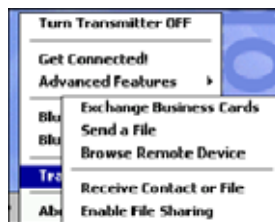

2. The Receive Contact or File status screen appears. Your mobile computer waits two minutes for the contact or file.

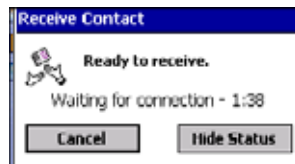

3. After successfully connecting to the remote device, the screen reports Connected then disappear. The new contact or file should now be on your device.

4. If two minutes passes before you receive the item, tap **Wait Again**.

5. After you receive the file or contact, the "Receive Contact or File" feature is automatically disabled.

Enable File Sharing

1. Tap on the **Bluetooth** icon. In the pop-up menu, tap Transfer via **Bluetooth > Enable File Sharing**.

2. The Enable File Sharing status screen appears. Your mobile computer waits two minutes for the remote device to connect.



3. After successfully connecting to the remote device, the screen report Connected.

4. If two minutes passes before you connect, tap **Wait Again**.

5. File sharing is enabled until you end it by tapping **Cancel**.

Using the Dialer

This section explains how to assign a dialing prefix and use the Dialer to dial a number directly from your Contacts list. The Dialer makes it quick and easy to perform dial-up networking.

Note: The Dialer has been verified to work with Nokia and Ericsson phones and is known not to work with the Motorola 270c, NTT Docomo Paldio 633S or Sony au C413S phone. Results may vary with other phones that are not listed as being supported by the Bluetooth system.

Assign a Dialing Prefix

If you have not already assigned a dialing prefix during the install process, you can do so by following these steps:

1. Go to **Start > Settings > System** tab. Tap on **Dialer**.
2. Select the appropriate Dialing Prefix, then tap **OK**.



Using the Dialer

1. To use the dialer, the mobile computer must already be connected to the Bluetooth phone. You can use the Get Connected! Wizard to do this. Also, the Bluetooth phone must be selected as your favorite.
2. Go to **Start > Contacts**.
3. Tap and hold your stylus on the contact you wish to dial to. In the pop-up menu, select **Dial Contact**. Alternatively, you can tap on **Tools** and select **Dial Contact**.

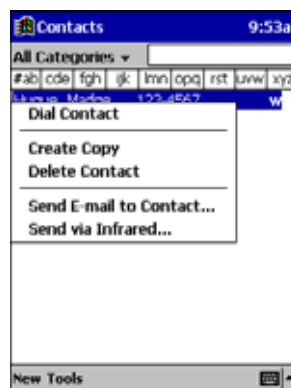

-
4. If you have multiple phone numbers for a contact, a screen appears listing them, including any dialing prefix you may have assigned. Select the phone number you wish to dial.



5. Your mobile computer connects to your phone and begins dialing.

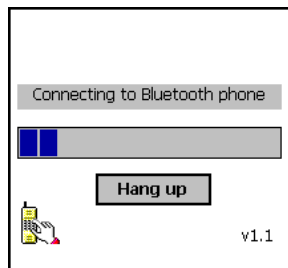

The Dialer can dial a phone number containing any of the following non-numeric characters:

* # + . / ! @ - \ space A B C D T P W

The following string can also be included in a phone number: (',')

The Dialer cannot dial a phone number containing non-numeric characters other than those listed above. Hand Held Products recommends that you follow the standard Microsoft Outlook format for phone numbers.

Get Connected Wizard

The Get Connected! Wizard guides you through a one-time setup process that prepares the mobile computer and phone for Bluetooth connections. The wizard varies depending on what phone you want to connect to.

Ericcson, Nokia 6210, NTT DoCoMo, Sony Phones

1. Tap on the **Bluetooth** task tray icon. In the pop-up menu, select **Get Connected!**

2. Follow the Bluetooth “Get Connected!” Wizard. In the second screen, use the drop-down list to select your Bluetooth phone. The wizard provides tailored instructions based on your selection.

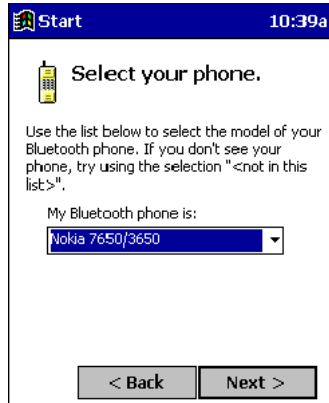

3. Follow the next screen(s) to prepare your specific phone for Bluetooth connections. You may need to do 1, 2 or all of the following steps:
 - (a) Naming your Bluetooth phone
 - (b) Setting your Bluetooth phone in Discoverable mode
 - (c) Preparing your Bluetooth passkey.

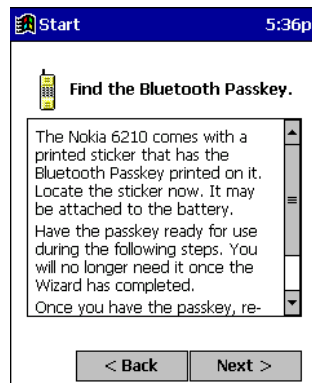

1. When the search is complete, a list of the discovered Bluetooth phones appears. Choose the phone you wish to connect to, and tap **Select**. A service discovery phase begins, about 5-10 seconds.

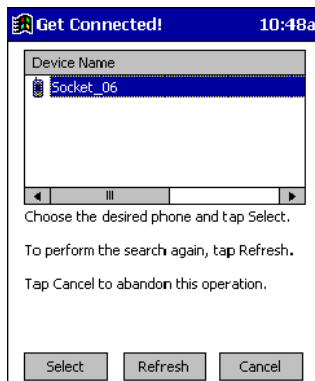

2. As prompted in the next screen, prepare your phone for bonding. For instructions on setting your phone to “Bondable” or “Pairable” mode, refer to your phone manual. Have your passkey ready, then tap **Next>**.

3. In the next screen, enter the passkey. Tap **Reply**.

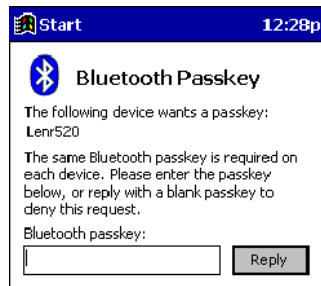

4. The mobile phone may then either automatically accept the passkey or ask you to enter one. If prompted for a passkey, use the same one you entered on the mobile computer.

Ericsson T68/T68i only: When the phone asks you if you want to bond, select 2: Add to paired devices. Do not tap ACCEPT.

5. Tap **Finish**. After successfully connecting, the phone appears in the Bluetooth Devices folder. On the Today screen, the Bluetooth icon blinks. You do not need to run the Get Connected! Wizard again unless you plan to switch between different phones.

Note: You may also switch between different phones by assigning a new "favorite phone" in the Bluetooth Devices folder.

Motorola Timeport 270C, Nokia 3650/6310/7650/8910/8910i

1. Tap on the **Bluetooth** task tray icon. In the pop-up menu, select **Get Connected!**
2. Follow the Bluetooth "Get Connected!" Wizard. In the second screen, use the drop-down list to select your Bluetooth phone. The wizard provides tailored instructions for your phone.

Note: The screens below are for the Nokia 7650.

3. As directed on the next two screens, assign the phone a unique name, set the phone to Discoverable mode, and tap **Next**.
4. The mobile computer searches for the phone. When the search is over, a list of the discovered Bluetooth phones appears.

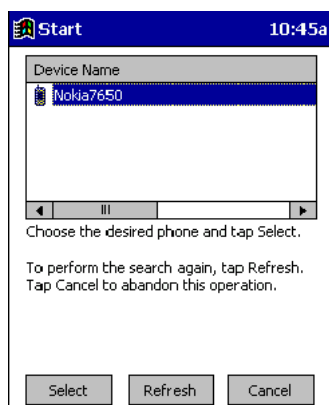

5. Choose the phone you want to connect to, and tap **Select**. A service discovery phase begins, about 5-10 seconds.
6. The next two screens describe procedures you complete outside of the wizard. Read through each screen but do not complete the described procedures until you exit the wizard.

Bonding with your phone - This must be completed to establish the Bluetooth connection and involves dial-up networking.

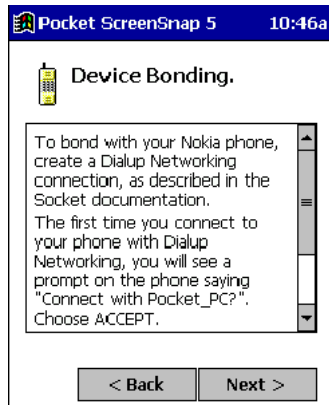

Automatic Connections - This procedure is optional but makes future Bluetooth connections more convenient.

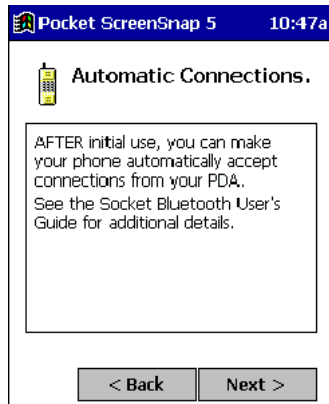

7. Continue to the last screen of the wizard and tap **Finish**. Now proceed to STEP 6 to complete the bonding process and, if desired, set up automatic connections.

Dial Up to Your Network

Complete the following steps to create a new Bluetooth internet connection. Before setting up dial-up networking, prepare yourself with dial-up information and other necessary settings from your office network or ISP.

Note: For more information about modem connections, see [Creating an External Modem Connection to an ISP on page 5-16](#).

1. Go to **Start > Settings > Connections** tab > **Connections**.
2. In the top field, select **Internet Settings** and tap **Modify**. Then, tap **New**.



3. **Enter a name for the connection.** Remember what you name the connection. In the future, you will need to select it to start the connection.
For the modem, select **Bluetooth Phone**.
For the Baud Rate, select **115200**.
If you want to configure Port Settings, TCP/IP, or Name Server settings, navigate to the setting and tap **Advanced**.
4. Tap **Next**.
5. In the Phone number field, enter the dial-up number. Tap **Next**.
6. Uncheck **Wait for dial tone before dialing**. Tap **Finish**.



7. Now you are ready to start the connection. In the Connections screen, under Internet Settings, tap **Connect**. In Network Log On, verify the dialing settings. Tap **OK**.



ONLY FOR MOTOROLA TIMEPORT 270C OR NOKIA 3650/6310/7650/8910/8910i:

- h) After you tap **Connect** for the first time, the phone displays a message asking if you want to bond. On Motorola, enter GRANT; on Nokia, enter ACCEPT.
- i) Make up a 4-16 digit passkey, enter it on the phone, then enter it on the Dolphin terminal.



Note: The Bluetooth icon on the Today screen blinks to indicate a connection.

- j) After successfully bonding, you can set up the phone to automatically connect to your Dolphin terminal without requiring a passkey.

Automatic Connections for Motorola Timeport 270C:

- On the phone, press MENU.
- Scroll to Settings, then press SELECT.
- Scroll to Connection, then press ON.

-
- On Bluetooth Link, press SELECT.
 - Scroll to Devices, then press SELECT.
 - Choose your mobile computer, then press EDIT.
 - Scroll to Access:Ask, then press CHANGE.
 - Scroll to Automatic, then press SELECT. Press DONE.

Automatic Connections for Nokia 3650/7650:

- On the phone, press MENU.
- Scroll to Connectivity, then press OPTIONS.
- The Open option should be highlighted. Press SELECT.
- The Bluetooth option should be highlighted. Press OPTIONS.
- The Open option should be highlighted. Press SELECT.
- Scroll to the right tab to access the Paired devices list. Highlight your mobile computer, then press OPTIONS.
- Scroll to Set as authorized, then press SELECT.
- In the confirmation screen, press YES.

Automatic Connections for Nokia 6310/8910/8910i:

- On the phone, press MENU.
- Scroll to 10 Bluetooth, then press SELECT.
- Scroll to 4 View Paired Devices, then press SELECT.
- Highlight the Dolphin terminal, then press OPTIONS.
- Scroll to 3 Request Connection Authorization, then press NO.

To use a different Bluetooth phone for dial-up networking, you can use the same connection setup, but you must make the new phone your favorite. Just run the Get Connected! Wizard again, select the new phone, and make it your new Favorite when prompted.

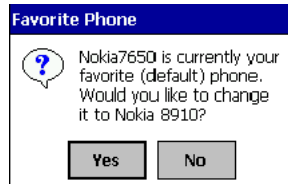

Overview

Dolphin 9500 terminals are the only terminals in the Dolphin 9500 Series that can be configured with Wireless Wide Area Network (WWAN) via an integrated Siemens® GSM/GPRS tri-band radio module.

Note: Dolphin 9550 mobile computers with pistol-grip do NOT support GSM/GPRS.

GSM	GSM stands for Global System for Mobile communications. It is an open, non-proprietary wireless wide area networking system that is constantly evolving and growing. One of its great strengths is international roaming capability, which provides standardized dialing in more than 170 countries.
GPRS	GPRS stands for General Packet Radio Service. It is a non-voice value added service that allows packet switched data and information to be instantly sent and received across a mobile telephone network.

Powering Up the GSM/GPRS Radio Driver

When the mobile computer is first initialized, the radio driver for the GSM module is installed. Before using the radio, make sure that the GSM radio is powered up. For more information, see [The Radio Manager](#) on page 4-16.

Tri-Band Antenna

Dolphin 9500 terminals configured with a GSM/GPRS radio feature a tri-band antenna that supports 900, 1800 and 1900 MHz frequencies for worldwide mobile applications.

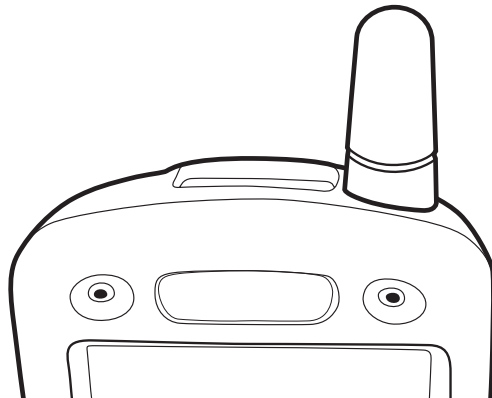

Requirements

Using GSM/GPRS on a Dolphin 9500 terminal requires:

- a network subscription to a GSM/GPRS network (you need to know what service providers are in your geographic area), and
- a SIM card that has been activated by the network service provider installed on the terminal.

Capabilities

Dolphin 9500 computers with integrated GSM/GPRS WWAN radios are optimized for the following two-way voice and data communications:

- GSM voice data ("dial-up")
- SMS (Short Message Service) text messages
- GPRS Class 10 - data transmissions average. 40-60 Kbps (wireless network carrier dependent)

SIM Card Installation

SIM stands for Subscriber Information Module. A SIM card stores the subscriber's personal information, GSM/GPRS radio settings, security key, contacts, etc. SIM cards can be installed and removed from compatible mobile devices, enabling you to switch devices without losing your personal information. SIM cards are obtained and activated by the network provider that supports your GSM/GPRS network.

On the Dolphin 9500 terminal, the SIM card door is located in the battery well on the back panel. This enables easy access to the SIM card while securing it under an installed battery.

To Install a SIM Card:

Note: You need a metric .050 Hex head wrench to open the SIM card door. The SIM card must be activated by the service provider prior to installation.

1. Turn off your terminal and lay it face-down on a flat surface.
2. Remove the battery pack. For details, see [To Remove the Main Battery Pack](#) on page 2-7.

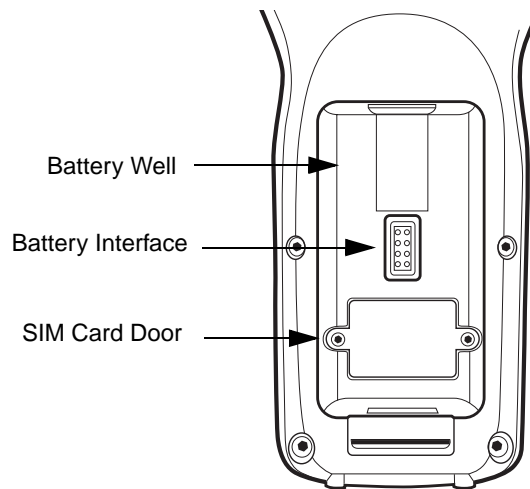

3. Using the Hex head wrench, unscrew the faceplate of the SIM card door.
4. Insert your SIM card. Make sure the interface on the card is connected to the SIM Card interface in the slot; the beveled corner is in the upper right corner.
5. Place the SIM card door over the secured SIM card and secure the allen screws.

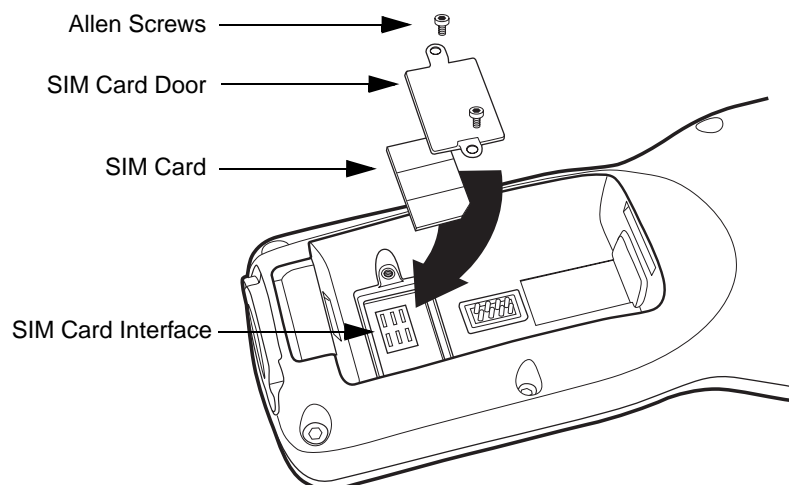

6. Install the battery pack and turn on the terminal.

Using uPhone

The uPhone Application Suite contains three programs that function together to provide a complete voice, data, and text messaging solution for a mobile device fitted with a radio modem:

- **Dialler** emulates a mobile phone and is used to make and receive telephone calls - [Using the Dialler](#), page 9-6.
- **Call Log** enables you to view and manipulate a list of the most recent calls - [Call Log](#), page 9-14.
- **SMS Manager** provides a text message handler similar to many email programs - [SMS Manager](#), page 9-16.

Accessing uPhone

Go to **Start > Programs > uPhone**. Tap one of the icons to launch the program.



Navigation Bar



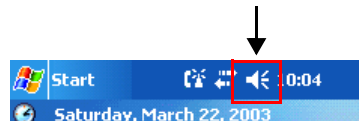





When the Dialler or SMS Manager applications are not open, the icons in the Navigation bar at the top of the screen indicates the status of the phone and messaging system. Each icon indicates a specific action and, when tapped, displays a bubble window that lets you know what is happening.

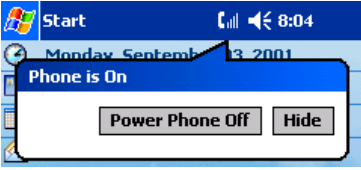

Status Icons and Bubble Options

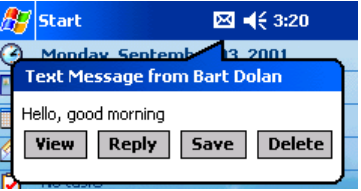
Icon	This icon means...	Tapping this icon displays this bubble:	Bubble Options
	The phone is off.		Tap Power Phone On to turn the phone on and close the bubble. Tap Hide to leave the phone off and close the bubble.
	The phone can only make emergency calls. This usually means there is no SIM card installed or PIN number established.		Tap Hide to dismiss the bubble. This icon will appear in the Navigation bar until a SIM card is installed or a PIN is entered.
	The phone is registering on the network.		Tap Hide to dismiss the bubble. This is a temporary state. This icon appears only until the phone is registered on the network.

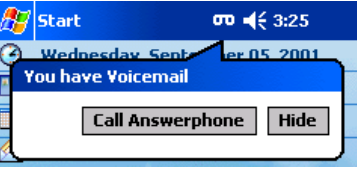
Status Icons and Bubble Options

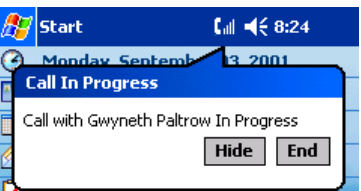
Icon	This icon means...	Tapping this icon displays this bubble:	Bubble Options
	The phone is on and registered. To the right of the phone is a bar that indicates signal strength.		Tap Hide to dismiss the bubble. Tap Power Phone Off to turn off the phone. The icon in the Navigation bar changes to indicate the phone is now off.
	Indicates medium signal strength.		
	Indicates good signal strength.		
	Indicates full signal strength.		
	Incoming SMS message available.	This bubble appears automatically when a new SMS message is received. It contains the sender's information and the first line of the text message. 	Tap View to display the full message in SMS Manager. Tap Reply to switch to the SMS Manager Compose screen. The 'To:' field is auto-filled with the sender's address. Tap Save to put the message in the SMS Manager Inbox. Tap Delete to delete the message. Tapping each button closes the bubble.
	A new voicemail message is available.	This bubble appears automatically when a voicemail notification is received. 	Tap Call Answerphone to dial the Answerphone service and retrieve voicemail messages. To set up Answerphone, see, uPhone Configuration, General Tab , page 9-21. Tap Hide to close the bubble.
	There is a call in progress to the name or number shown in the bubble. (This icon is showing full signal strength; the icon will change according to the current signal strength.)		Tap Hide to close the bubble. Tap End to end the call.

Status Icons and Bubble Options

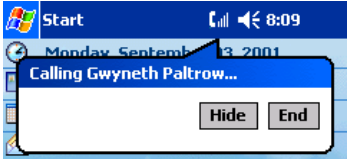
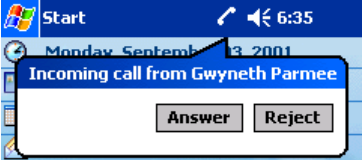
Icon	This icon means...	Tapping this icon displays this bubble:	Bubble Options
	<p>This icon appears when there is a call coming in or going out.</p> <p>A different bubble displays for each circumstance.</p> <p>If the incoming call is a conference call, a different bubble displays.</p>	<p>For a call going out</p> 	<p>Tap Hide to close the bubble.</p> <p>Tap End to end the call.</p>
		<p>When a call is coming in, this bubble displays while the ringtone sounds.</p> 	<p>If the caller is in the Phonebook, the name displays. If not in the Phonebook, the caller's number displays; if the number can't be read, "no number" displays.</p> <p>Tap Answer to answer the call; this places any current call on hold.</p> <p>Tap Reject to reject the call.</p>

Using the Dialler

The Dialler is the program that manages your GSM/GPRS cell phone calls.

To launch the Dialler, tap **Start > Programs > uPhone > Dialler**. The program launches and the uPhone Dialler screen opens:

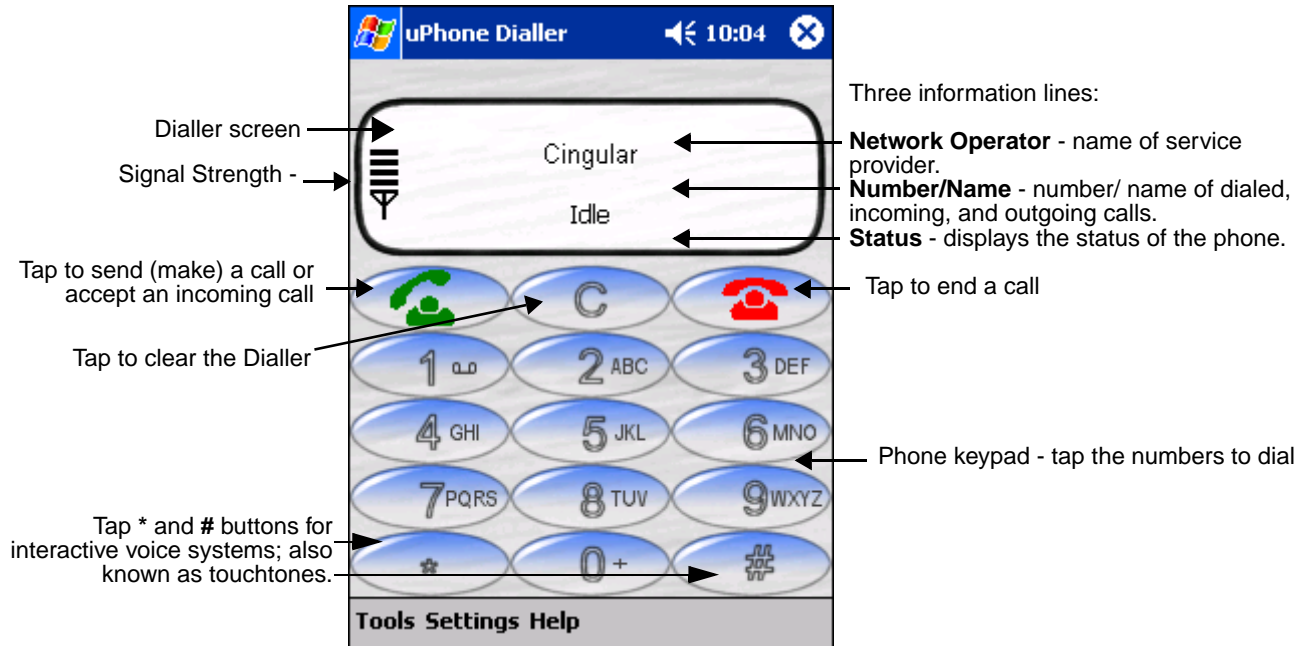

Making a Call

To Enter a Number

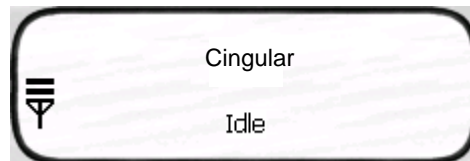

You can:

- Enter the numbers manually using the phone keypad on the Dialler screen, the SIP, or the Dolphin keyboard.
As you enter each number, the digits appears on the Dialler screen in the **Name/Number** line. If a contact matching the entered number is found in the Phonebook, the name of the contact appears in the **Name/Number** line as you type; tapping on the name enters the rest of the number automatically.
- Use the Phonebook - [Phonebook](#), page 9-10 - to
 - Select an existing contact.
Tap **Tools > Phonebook**, select a name or number in the list, and tap **OK** (you can also tap and hold on the entry). The number is automatically entered in the Dialler and appears on the screen.
 - Use speed dial.
Tap and hold on the list to see a popup menu of speed dial numbers.
- Use the Call Log - [Call Log](#), page 9-14.
When the phone is in Idle status, you can tap the **Send** button on the screen , press the ENTER key, or tap **Tools > Call Log** to see a list of the last 20 calls made or received. Tap and hold on an entry in the list and select **Dial**.
Pressing the **Send** button or ENTER key performs this function only when the phone is in an Idle Status.

To Send a Call To a Dialed Number

You can:

- Tap the **Send** button .
- Press the ENTER key on the keyboard.
- Press the appropriate key combination on the keyboard - [Keyboard Combinations for Calls](#), page 9-8.

When the call is connected, the three information lines display the following:

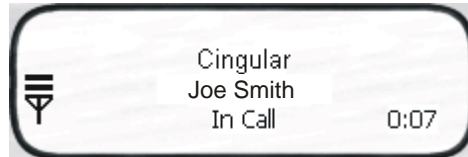

Network Operator	Displays the name of the service provider you are using.
Name/Number	Displays the name and/or number you called. If the number is from your Phonebook, that entry displays.
Status	The status of the call. Idle - means no calls are incoming or outgoing. In Call - means a phone call is in progress. Incoming Call - means that a call is coming in.
0:00	The numbers in the lower, right corner display the minutes:seconds that have elapsed.

Receiving a Call

When the Dialler screen is open and an incoming call is detected, text is displayed on the Dialler screen. If the Dialler is not visible at the time of the incoming call, a Navigation Bar notification appears; see [Status Icons and Bubble Options](#) on page 9-3.

When a call is coming in, the ringtone sounds and the three information lines on the Dialler screen display the following:



Network Operator	Displays the name of the service provider you are using.
Name/Number	Displays the name and/or number calling in. If the number is in your Phonebook, that entry displays.
Status	Incoming Call.

To Answer a Call

To answer a call, you can:

- Tap the **Send** button .
- Press the ENTER key on the keyboard.
- Press the appropriate key combination on the keyboard - [Keyboard Combinations for Calls](#), page 9-8.

To Reject a Call

You can:

- Tap the **End** button .
- Press the appropriate key combination on the keyboard - [Keyboard Combinations for Calls](#), page 9-8.

Call Waiting

If call waiting is enabled, a second incoming call can be received while a first call is in progress. The second incoming call uses a different ringtone but displays the same incoming call notification.

If a second call is coming in, answering it (see [To Answer a Call](#) on page 9-7) automatically places the first call on hold. You can also reject the second call; see [To Reject a Call](#) on page 9-7.

Ending a Call

To end or reject a call, you can:

- Tap the **End** button .
- Press the appropriate key combination on the keyboard.

Call Waiting If two calls are in progress, the above options end the active call and place the other on hold. To activate the call on hold, tap **Send** or press ENTER or the key combination to send calls. To end the call on hold, tap **End** or press the key combination to end calls on the keyboard.

Conference Call If a conference call is in progress, tap **End** or the key combination to end calls.

Keyboard Combinations for Calls

Each keyboard option contains a key combination to send and end a call using the Red modifier key.

Keyboard	To Send, Press...	To End (reject), Press...
35-key keyboard	Red + SP	Red + DEL
43-key keyboard	Red + D	Red + H
56-key keyboard	Red + 3	Red + 6

Call Waiting

The uPhone Dialler supports call waiting functionality. This means that you can receive a second call while on a first call.

Placing a Current Call on Hold

When a second call is coming in, to place the current call on hold

- Tap the **Send** button .
- Press the ENTER key on the keyboard.
- Press the key combination for sending calls on the keyboard.

The Status line of the first call changes to **Call on Hold**.

Tapping **Send**  again restores the call on hold.

Making a Second Call To make a second call, place the current call on hold, then dial the second number. When there are two calls (one active and one held) the status line displays **In Call, Call on Hold**.

Switching Between Calls To switch between the active and held call, tap **Send**, press ENTER, or the appropriate key combination to send calls. The display is updated to show the active call details, and that the other call is on hold.

Making Conference Calls

In addition to supporting call waiting functionality, the uPhone Dialler enables you to join two calls into a conference call. When two calls are in progress, tap the phone icon on the Navigation bar. This opens a bubble dialog that enables you to conference both calls into one.



Button	Tapping this button...
Hold Active and Accept Held	Swaps between the currently held and active calls. Tapping Send or pressing ENTER performs the same function without opening this bubble dialog.
End Active and Accept Held	Drops the current active call and connects the held call.
Join Held in Conference Call	Connects the held call and the currently active call in a three-way conference call. More than three parties can join a conference call via networking; each of the other parties can add another call to the conference, and so on.
End Held	Drops the held call, and continues with the currently active call.
Hide	Closes the bubble.

Touchtones

To transmit touchtones for interactive voice systems while in a call, you can

- Tap the **0-9**, *****, and **#** buttons on the uPhone Dialler screen.
- Press 0-9 keys on the Dolphin keyboard; use the uPhone Dialler screen buttons for ***** and **#**.

Volume Control

Use the Dolphin keyboard to manually adjust the volume.

To raise the volume, press the Blue modifier key +  (VOL+)

To lower the volume, press the Blue modifier key +  (VOL-)

Phonebook

The Phonebook contains the contacts from the SIM card and Pocket Contacts. If fixed dialing is set in the SIM, then only those numbers in the fixed dialing list are shown in the Phonebook, and only these numbers can be called from the Dialler.

You can access the Phonebook manually by opening the Dialler and going to **Tools > Phonebook**. When you tap and hold on an entry, a popup menu displays.

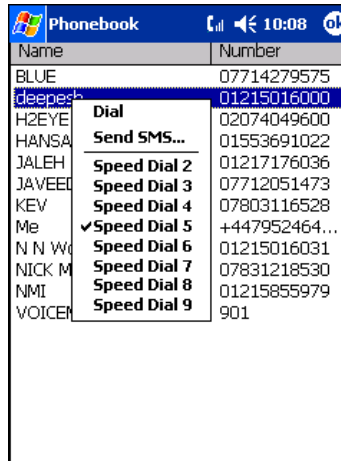

Dial

Opens the Dialler with the number entered ready for dialing.

Send SMS

Opens the SMS Manager in the Compose screen with the 'To:' field populated with the number.

Speed Dial 2-9

These eight slots are used to assign the Dialler Speed Dial keys. To assign a number to a Speed Dial slot, tap on an entry to assign the number. Tapping and holding the associated button when in Dialler will automatically dial the assigned contact.

Tools Menu

The Tools menu provides the following options:

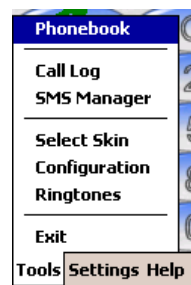

Select this item

To...

Phonebook

Display the Phonebook.

Call Log

Switch to the Call Log.

SMS Manager

Switch to the SMS Manager Inbox.

Select Skin

Allow selection of a new skin for the uPhone Dialler application.

Configuration

Open the uPhone Configuration control panel

Ringtones

Switch to the ring tone selection control panel.

Exit

Exit the uPhone Dialler.

Settings Menu

The Settings menu provides the following options:



Speakerphone Toggles speakerphone mode on and off. When an audio plug (for a headset) is inserted into the audio jack (2.5mm), Speakerphone is inactive on this menu.

Mic mute Toggles microphone mute on and off (the other party cannot hear a private conversation when the microphone is muted). This mode is active only during a call and automatically cancelled at the end of a call.

A checkmark to the left of the entry indicates that the mode is active. When the entry is grayed-out, it is unavailable and cannot be selected.

Audio Modes

The back panel of the Dolphin 9500 contains both a speaker and a microphone that you can use to send and receive audio signals over the GSM network. For details about the microphone and speaker on the back panel of the Dolphin 9500, see [Back Panel Features](#) on page 3-4.

There are three audio modes: Handset, Headset, and Hands-free (speakerphone).

Handset

Handset mode is when you use the back panel of the terminal just as you would a cell phone, holding the speaker to your ear to receive audio information and the your mouth over the microphone to send audio information.

This is the default audio mode.

Headset

Headset mode is when you plug a headset into the audio jack and speak into the microphone. You must use a 2.5mm plug; no other audio plug will fit.

Hands-Free

Hands-free mode is when you use the back panel of the Dolphin 9500 as a speakerphone.

To switch the back panel to speakerphone, in the Dialler, tap **Settings > Speakerphone**. The audio levels adjust appropriately for speakerphone use. For more information, see [Settings Menu](#) on page 9-11.

Ringtone Configuration

Different ringtones, with individual volume settings, can be set for the following:

Ring Tone	Sounds on an incoming call.
Message Tone	Sounds on an incoming SMS or Voicemail notification.
Call Waiting Tone	Sounds to indicate an incoming call while you are already on a voice call.

Accessing Ringtone Configuration

You can access Ringtones two ways:

1. Go to **Start > Settings > Personal tab > Ringtones** icon OR
2. Open the Dialler (tap **Start > Programs > uPhone > Dialler**) and go to **Tools > Ringtones**.

The Ringtones screen opens displaying the current settings.

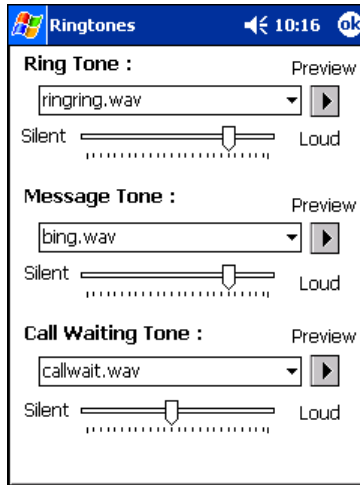

Select the desired ringtone for each type of tone in the drop-down lists. Tapping **OK** saves any changes. Opening another screen without tapping **OK** discards any changes.

WAV Files

You can customize your ringtones with *.wav files installed on your terminal. To appear here, *.wav files must be stored in the **Programs Files > uPhone > Ring Tones** folder.

Previewing Tones

You can preview each tone by selecting the *.wav file in the drop-down list and tapping the **Preview** button. Use the slider to set the volume for each tone.

While the tone is playing, the Preview button changes to a **Stop** button; tap it to stop the preview.

Call Log

The Call Log maintains a list of the last 20 calls made or received in each of the following categories:

- Voice Calls In
- Voice Calls Out
- Voice Calls Missed
- GPRS Data

Voice Call In is the default display whenever the Call Log is opened.

Call Log Options

Voice Calls Out and Voice Calls Missed are available from the drop-down list. Select the option you want to view.

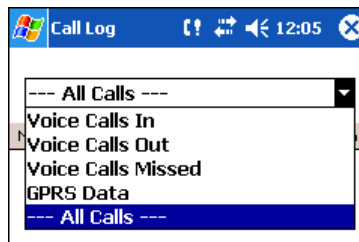

To see everything, select **All Calls**.

Opening the Call Log

You can access the Call Log two ways:

1. Go to **Start > Programs > uPhone > Call Log**) OR
2. Open the Dialler (go to **Tools > Call Log**).

The Call Log opens displaying the last few Voice Calls In; the most recent call always appears at the top.

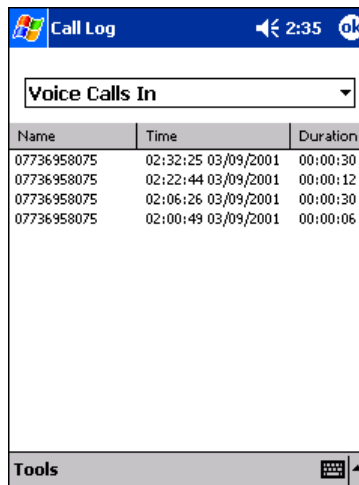
A screenshot of the 'Call Log' application window showing a list of calls. The title bar shows 'Call Log' and the time '2:35'. A drop-down menu is set to 'Voice Calls In'. The list has three columns: 'Name', 'Time', and 'Duration'.

Name	Time	Duration
07736958075	02:32:25 03/09/2001	00:00:30
07736958075	02:22:44 03/09/2001	00:00:12
07736958075	02:06:26 03/09/2001	00:00:30
07736958075	02:00:49 03/09/2001	00:00:06

The bottom of the window shows a 'Tools' bar with a keyboard icon and an arrow.

This column

Name

Displays the ...

The phone number or the name if the call was from or to a matching entry in the Phonebook.

Time

Time and date the call started. This is the local time and date.

Duration

Duration of the call (hours:minutes:seconds). The clock starts when the call connects, not when dialed.

Tools Menu



The Tools menu in the Call Log provides the following options:

Select this menu option To...

- | | |
|--------------|-----------------------------|
| Clear | Delete the entire Call Log. |
| Exit | Close the Call Log. |

SMS Manager

Abbreviated for Short Message Service, SMS enables the transmission of short messages (140-160 characters) to and from a cell phone. SMS messages travel over the system's control channel, which is separate from the voice channel.

The SMS Manager on the Dolphin 9500 supports creation, sending, receiving, and storing of SMS text messages. Text messages sent or received can be up to 160 characters long.

Opening the SMS Manager

You can access the SMS Manager two ways:

1. Go to **Start > Programs > uPhone > SMS Manager**, OR
2. Open the Dialler (**Start > Programs > uPhone > Dialler**) and go to **Tools > SMS Manager**. The SMS Manager opens displaying a list of your most recent text messages. Tap the Inbox and the SMS folders drop-down.

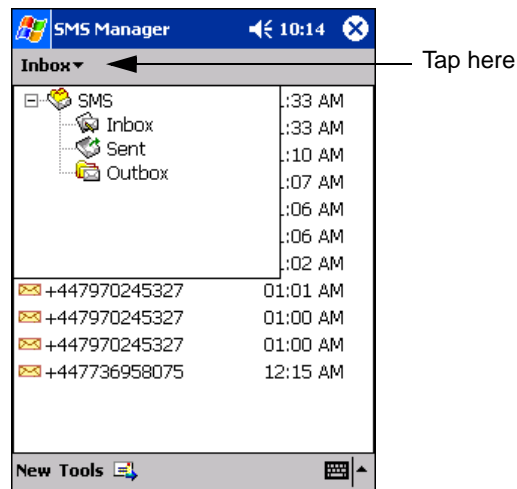

Three folders are available from the Inbox menu:

Select this folder	To see...
Inbox	Received text messages.
Sent	Sent text messages.
Outbox	Text messages waiting to be sent (messages are moved to the Sent folder automatically after transmission).

When the folder is selected, the messages in it appear in the list. The name of the folder appears in the gray bar just under the title bar.

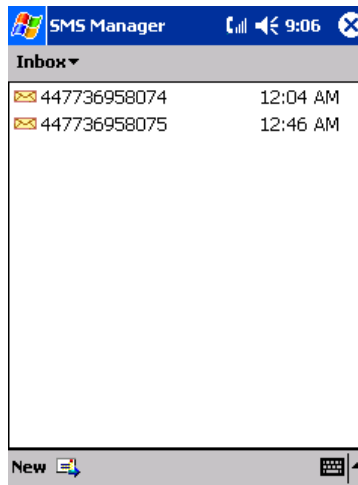

To

- Open a message
- Delete a message

Do this...

- Tap on it in the list.
- Tap and hold on it in the list. A popup menu appears that enables you to delete the message.

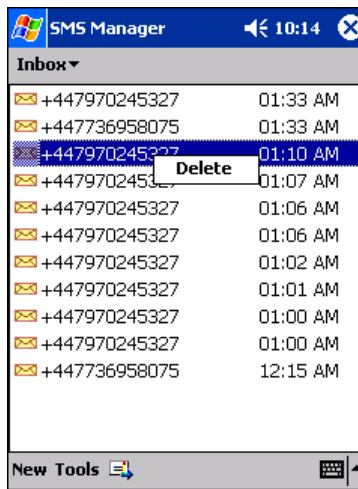

Sending an SMS Message

1. In the task tray at the bottom of the screen, tap **New**. The new message screen opens with the cursor active in the text area.
2. Tap inside the **To:** field. To add the number, you can type it in or tap **To:** to select an entry from your Phonebook.
 - You must type a number that is in the appropriate international ISDN format for the country you are dialing. However, you can dial a local number without the country code.
 - Destination numbers can start with a “+” sign.



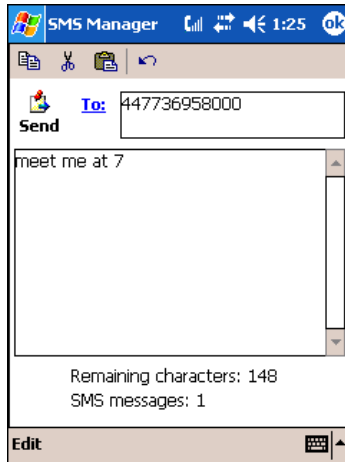

3. Tap inside the text area. To write a message, you can use the SIP or the keyboard.



The Remaining characters field displays how many characters you can type. It counts backwards from 160 as you type each character.

4. When finished typing, tap the **Send** icon to transmit the message  **Send** .
If you tap **OK** before tapping send, the program requests confirmation before discarding the message.

Icons at the Top of the Screen

Tap this icon	To...
At the top of the window:	
	Copy selected text.
	Cut selected text.
	Paste text.
	Undo the previous action.
In the task tray at the bottom of the window:	
	Send all messages in the Outbox.

Edit Menu

The Edit menu in the command bar provides the same options as the icons at the top of the screen, with the following additional options:

Select All Selects all text in the active message section.

Clear Selection

De-selects all text in the active message section.

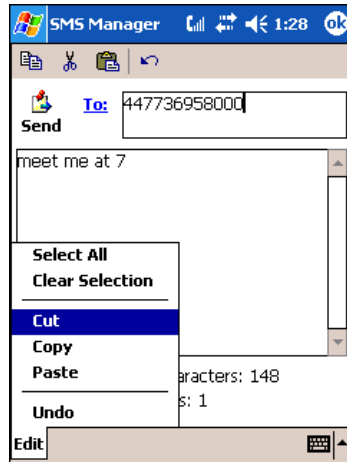

Online Help

Tapping **Help** > **About** provides information about the uPhone applications.

uPhone Configuration

uPhone Settings enable you to establish the normal operating parameters for uPhone applications.

Accessing

You can access uPhone Settings two ways:

1. Go to **Start > Settings > System** tab > **uPhone** icon  **Settings**.
2. In the Dialler application, selecting **Tools > Configuration**.

Requirements

Because this control panel adjusts network settings, the GSM radio **must** be powered up, and a SIM must be installed for it to open correctly. If not, you will receive a notification message when you try to open the control panel.

If the radio is powered up and a SIM installed, an animated wait icon displays the following message while the system accesses the network: "Settings on the Network are being accessed. Please wait..."

If there is no response from the network within 60 seconds, this message times-out and the control panel closes. Otherwise, the uPhone Settings screen displays; the General tab appears first by default.

General Tab

uPhone Settings consists of four tabs: General, Network, Divert and Bar. The tabs move up the screen if the SIP is opened for text or number entry. Tapping **OK** accepts any changes and exits the control panel.

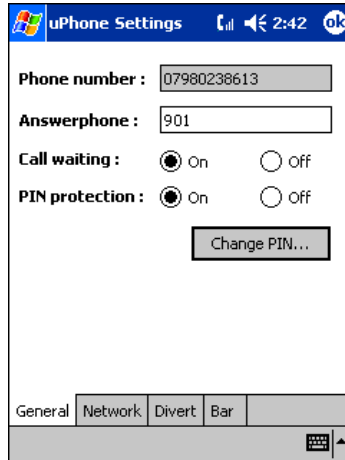

Field	Description
Phone Number	This is the phone number stored on the SIM. It is displayed here for information only.
Answerphone	This is the number to dial to retrieve voicemail messages. To enter a new number, tap on this field and enter the digits.
Call waiting	Select On or Off to enable or disable call waiting functionality. Call waiting must be set to On for conference calls.
PIN protection	Select On or Off to enable or disable PIN protection. If enabled, a PIN number is requested when the phone is switched on.
Change PIN	This button is active only if PIN protection is set to On. Otherwise, the button is grayed-out. If you tap Change PIN , a dialog box appears enabling you to change the PIN.

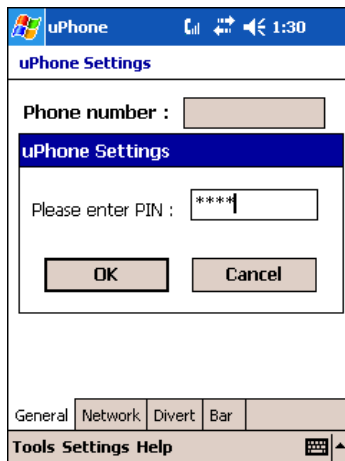

In the **Old PIN** field, enter the current PIN, then enter the new PIN in the **New PIN** and **Confirm PIN** fields. Tap **OK** to save the change. If you do not tap **OK**, the old PIN remains in effect.

While typing, the numbers appear as asterisks to protect the number from observation by third parties.

Network Tab

The Network tab provides the ability to choose between **Automatic** and **Manual** network selection.

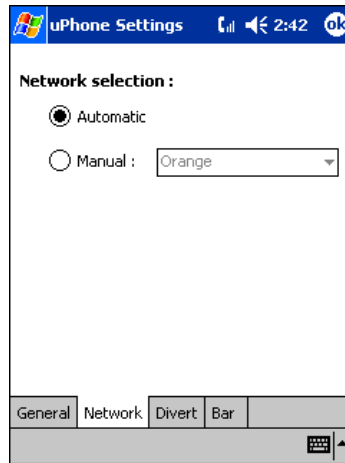

If you choose **Manual** network selection, the drop-down list of available networks activates. Choose a network from this list and tap **OK**. A wait icon appears while the system accesses the selected network.

Divert Tab

The divert tab enables you to select divert options for incoming calls when you are unavailable to answer; e.g., when the phone is off, you are out of network coverage, busy, or not able to answer.

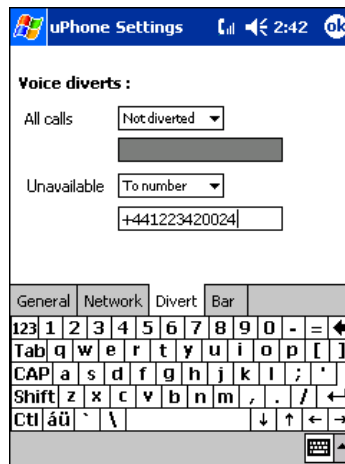

Select an option from the **All Calls** drop-down list to divert all incoming calls automatically.

Select an option from the **Unavailable** drop-down list to divert incoming calls when you are unavailable.

The options in both lists are as follows:

- | | |
|---------------------|--|
| Not Diverted | Select this option to not divert calls. This is the default setting. |
| Answerphone | Select this option to divert calls to voicemail. |
| To number | Select this option to forward incoming calls to another number. Enter that number in the field below the drop-down list. |

Bar Tab

The Bar tab sets enables you to bar both incoming and outgoing calls.

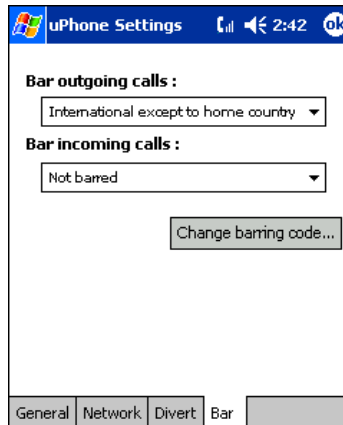

Bar outgoing calls

Select one of the following options from the drop-down list:

- | | |
|---|--|
| Not barred | No restrictions on outgoing calls. |
| International calls | Bar international calls. |
| International except to home country | Only international calls to the home country designated on the SIM card can be made. |
| All outgoing calls | Bar all outgoing calls. |

Bar incoming calls

Select one of the following options from the drop-down list:

- | | |
|------------------------------------|--|
| Not barred | No restrictions on incoming calls. |
| Incoming calls when roaming | Bar incoming calls when the network coverage is in roaming status. |
| All incoming calls | Bar all incoming calls. |

Change barring code

Tap this button to change the barring code. A dialog box appears that enables you to change the barring code.

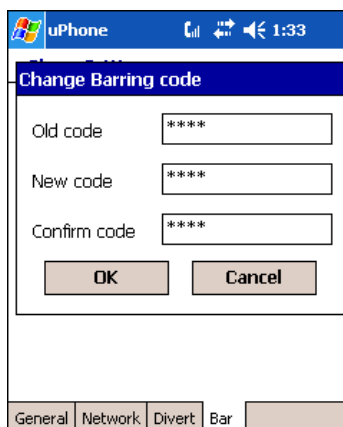

In the **Old code** field, enter the current code, and enter the new code in the **New code** and the **Confirm code** fields. Tap **OK** to save the change.

While typing, the numbers appear as asterisks to protect the number from observation by third parties. To save the barring options, tap **OK**. The system displays a dialog requesting the barring password before sending the updated settings to the network. Type in the password and tap **OK**.

GPRS Settings

After subscribing to a GPRS network and installing your SIM card, you can load the parameters of your GPRS subscription into the terminal. However, some subscriptions load automatically when you install your SIM card. If the GPRS settings do not load automatically, you must enter them manually.

uPhone includes a pre-configured GPRS connection in Internet Settings. You need to select or create GPRS settings prior to making a GPRS call for the first time. You can also configure GPRS settings for browsing the web via a VPN or Proxy Server.

Requirements

Make sure that you are not using ActiveSync when configuring the connection settings.

To establish a GPRS connection, you need to review the information from your network service provider. Given that there can be so many different configurations, such as VPN or Proxy Server connections, see [Connections Tab](#) on page 5-15 for instruction about how to set up each kind of connection.

To Select Pre-Configured GPRS Settings

1. Tap **Start > System > Connections** tab > **uPhone GPRS**. The GPRS Settings screen appears displaying the default settings.

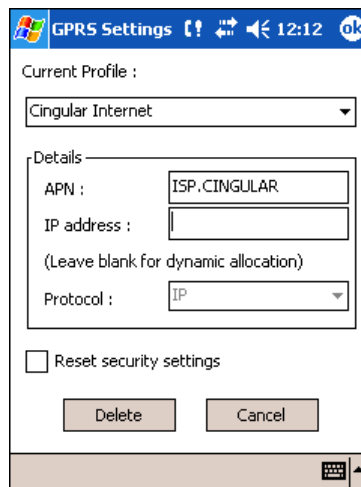

The **Current Profile** drop-down list contains a number of pre-configured connection profiles.

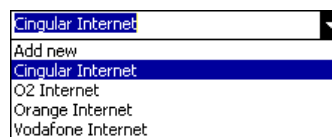

2. If the profile associated with your account appears in the list, select it. If it does not appear in the Current Profile list, you need to create one. For details, see [To Add a GPRS Setting](#) on page 9-25.
3. In the Details section
 - Type in the **APN** number
 - Type in the **IP address**
 - Select the **Protocol**
4. Tap **OK** to save.

Note: Select **Reset security settings** to reset the username and password, see [To Add a GPRS Setting](#) on page 9-25.

To Add a GPRS Setting

1. On the GPRS Settings screen, in the Current Profile drop-down list, select **Add new**.

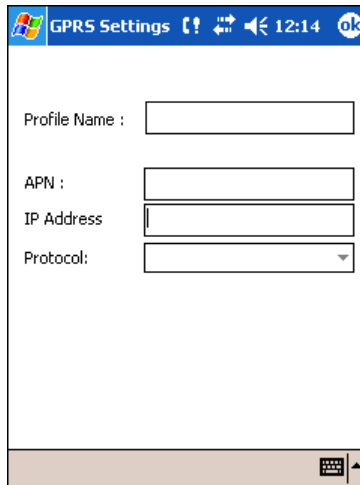

2. Type in the **Profile Name, APN, IP Address**, and select the **Protocol**.
3. Tap **OK**. You return to the settings screen. The Profile Name you selected now appears in the Current Profiles list.

GPRS Connection

When a GPRS connection is required - e.g., by navigating to a web site - a Network Log On screen is automatically displayed.

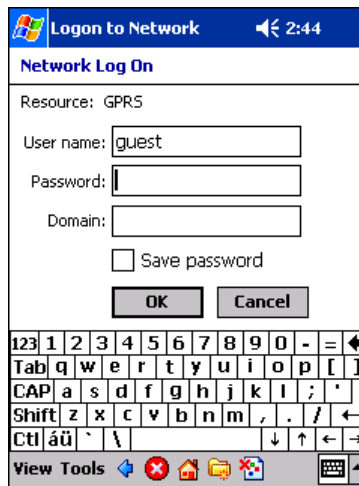

Enter the **Password** and **Domain**, then tap **OK** to connect.

You have the option of disconnecting by tapping on the GPRS connection icon in the navigation bar and tapping **End**.

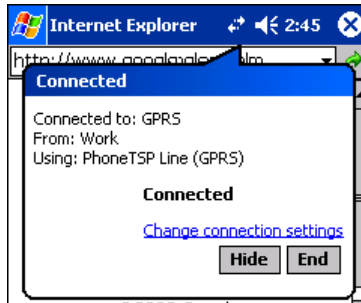

Dolphin 9500 Series terminals ship with the following Microsoft applications installed:

- Calendar
- Contacts
- Tasks
- Notes
- Inbox
- Pocket Internet Explorer
- Pocket Word
- Pocket Excel
- Windows Media Player for Pocket PC
- MSN Messenger
- Pictures

Note: Microsoft® Money, Microsoft® Reader are NOT installed on Dolphin terminals when shipped but may be installed from the Microsoft Companion CD.

Calendar

Use Calendar to schedule appointments, including meetings and other events. You can check your appointments in one of several views (Agenda, Day, Week, Month, and Year) and easily switch views by using the **View** menu.

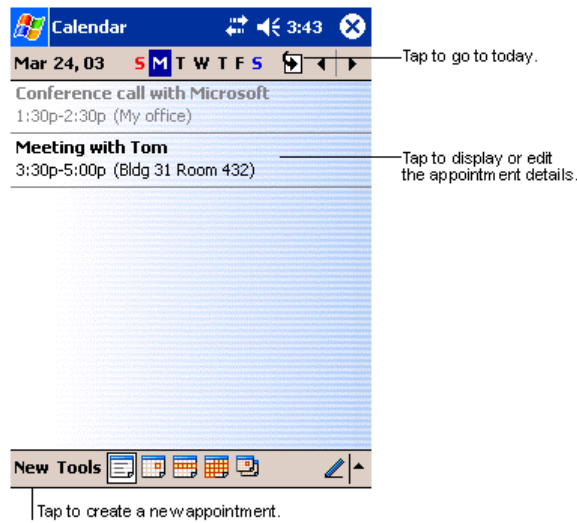

Note: You can customize the Calendar display, such as changing the first day of the week, by tapping **Options** on the **Tools** menu.

To Create an Appointment

1. If you are in Day or Week view, tap the desired date and time for the appointment.
2. Tap **New**.

3. Using the input panel, enter a description and a location. Tap first to select the field.

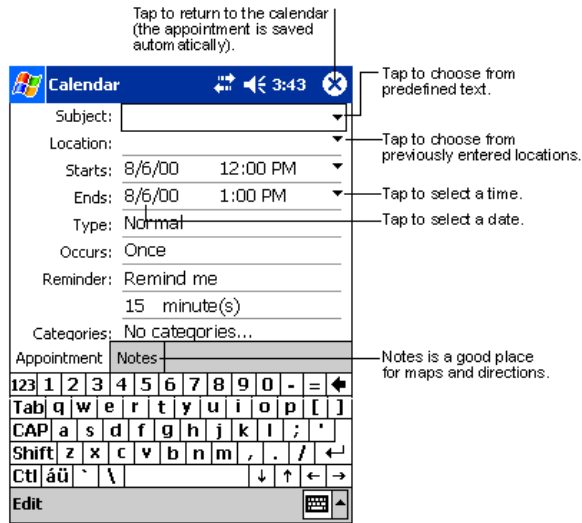

4. If needed, tap the date and time to change them.

5. Enter other desired information. To see all available fields, hide the input panel.

6. To add notes, tap the **Notes** tab. You can enter text, draw, or create a recording. For more information on creating notes, refer to [Notes](#) on page 10-7.

7. When finished, tap **OK** to return to the calendar.

*Note: If you select **Remind me** in an appointment, you will be reminded according to the options set in **Start > Settings > Personal tab > Sounds & Reminders**.*

Using the Summary Screen

When you tap an appointment in Calendar, a summary screen displays the details of the appointment.

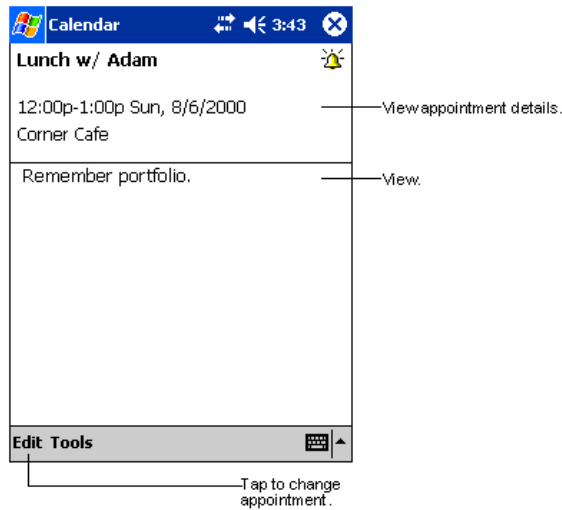

Creating Meeting Requests

You can use Calendar to set up meetings with users of Outlook or Pocket Outlook. The meeting request is created automatically and sent either when you synchronize Inbox or when you connect to your e-mail server. Indicate how you want meeting requests sent by tapping **Tools** and then **Options**. If you send and receive e-mail messages through ActiveSync, select **ActiveSync**.

To Schedule a Meeting

1. Create an appointment.
2. In the appointment details, hide the input panel, and then tap **Attendees**.
3. From the list of e-mail addresses you've entered in Contacts, select the meeting attendees. The meeting notice is created automatically and placed in the Outbox folder.

For more information on sending and receiving meeting requests, see Calendar Help and Inbox Help.

Contacts

Contacts maintains the contact information - phone numbers, e-mails, addresses, etc. - you need on your terminal.

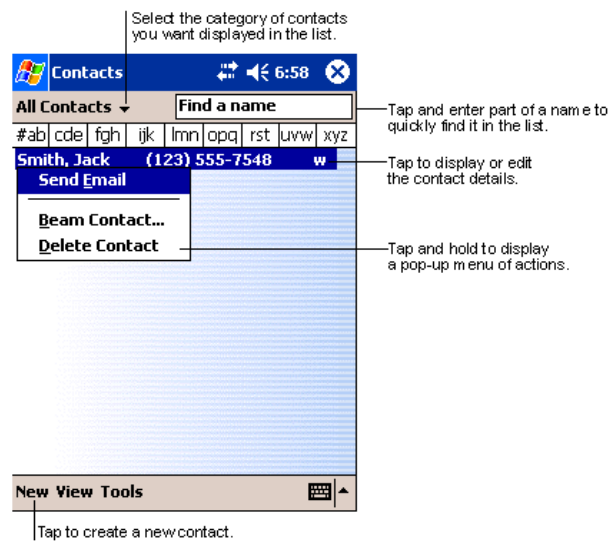

Note: To change the way information is displayed in the list, tap **Tools > Options**.

To Create a Contact

1. On the Contacts screen, tap **New**.

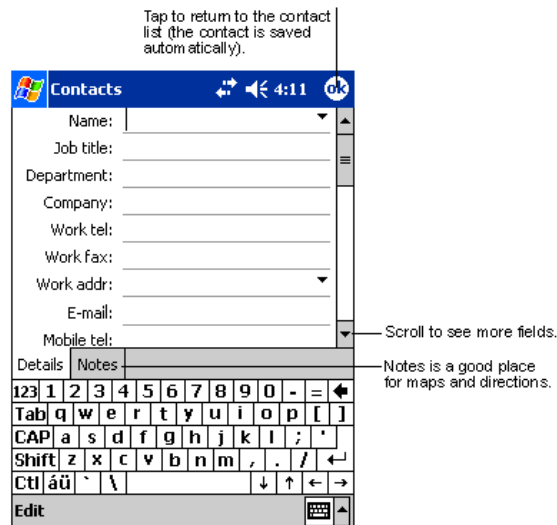

2. Using the SIP or Dolphin keyboard, enter the contact's information. Scroll down to see all available fields.
3. To assign the contact to a category, scroll to and tap **Categories**, then select a category from the list. (In the contact list, you can display contacts by category.)
4. To add notes about this contact, tap the **Notes** tab. For more information on creating notes, refer to [Notes](#) on page 10-7.
5. When finished, tap **OK** to return to the contact list.

To Search for Contacts

There are four ways to find a contact:

- In the contact list, enter a contact name in the box under the navigation bar. To show all contacts again, clear text from the box or tap the button to the right of the box.
- In the contact list, tap the category list (labeled **All Contacts** by default) and select the type of contact that you want displayed. To show all contacts again, select **All Contacts**. To view a contact not assigned to a category, select **None**.
- To view the names of companies your contacts work for, in the contact list, tap **View > By Company**. The number of contacts that work for that company are displayed to the right of the company name.
- Tap **Start > Find**, enter the contact name, select **Contacts** for the type, and then tap **Go**.

Using the Summary Screen

When you tap a contact in the contact list, a summary screen displays their information.

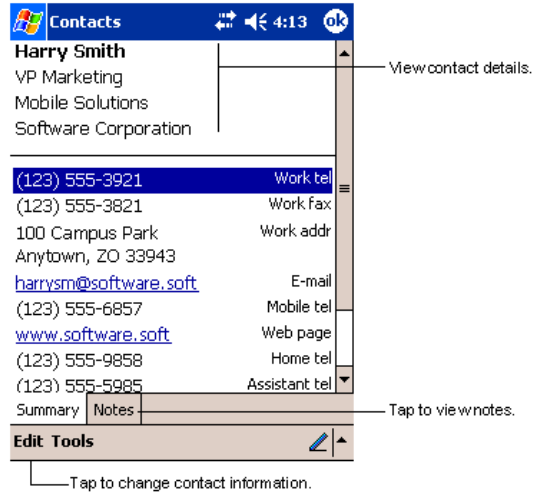

Tasks

Use Tasks to keep track of what you have to do.

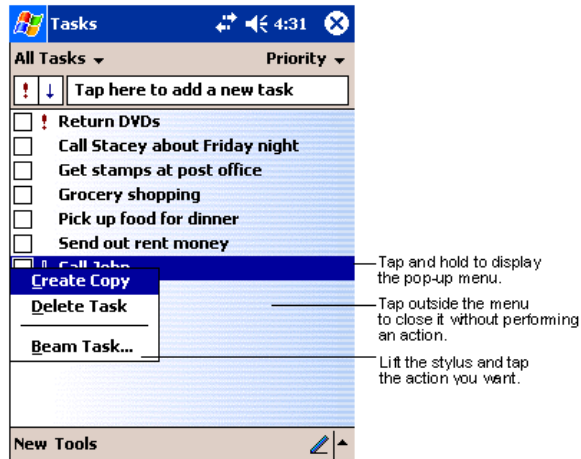

Note: To change the way information is displayed in the list, tap **Tools > Options**.

To Create a Task

1. Tap **New**.

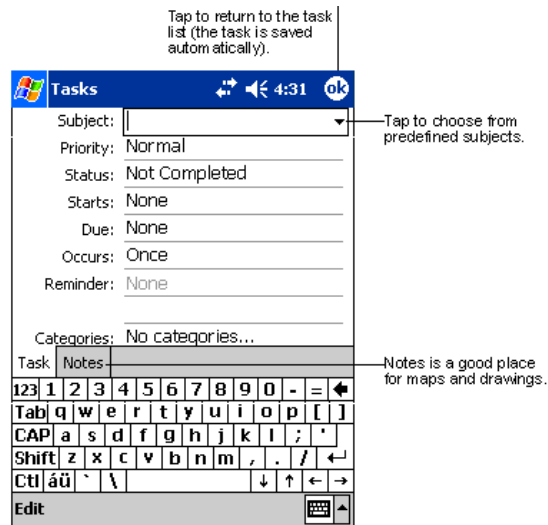

2. Using the SIP or Dolphin keyboard, enter the task information.
If the input panel is open, you need to hide it to see all available fields.
3. Tap **Starts** to enter a start date and/or **Due** to enter a due date for the task.
4. To assign the task to a category, tap **Categories** and select a category from the list.
In the task list, you can display tasks by category.
5. To add notes, tap the **Notes** tab.
For more information on creating notes, refer to [Notes](#) on page 10-7.
6. When finished, tap **OK** to return to the task list.

Note: To quickly create a task with only a subject, tap **Entry Bar** on the **Tools** menu. Then, tap **Tap here** to add a new task and enter your task information.

Using the Summary Screen

When you tap a task in the task list, a summary screen displays the task information.

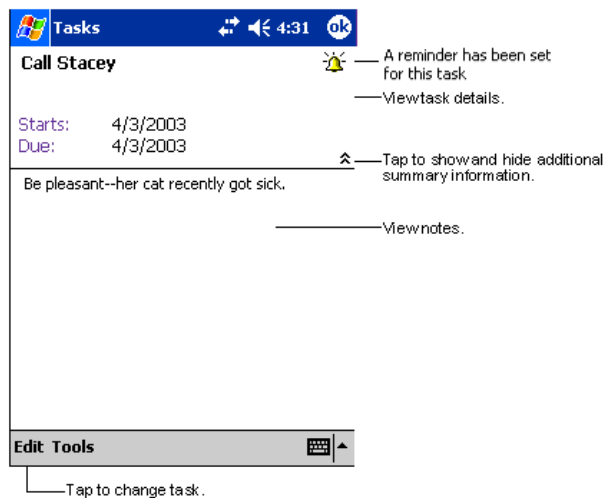

Notes

Quickly capture thoughts, reminders, ideas, drawings, and phone numbers with Notes. If a note is open when you create the recording, it will be included in the note as an icon.

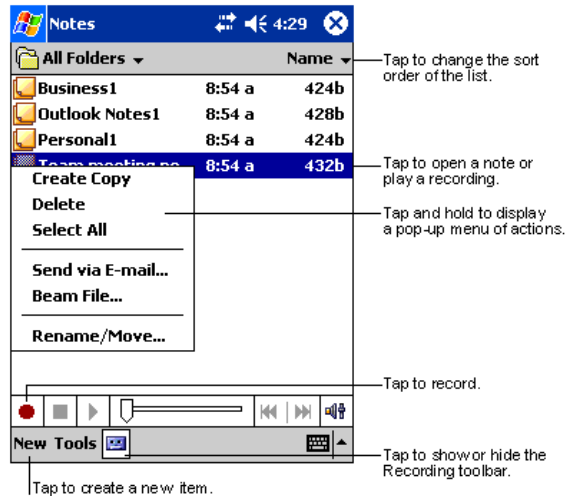

To Create a Note

1. Tap **New**.

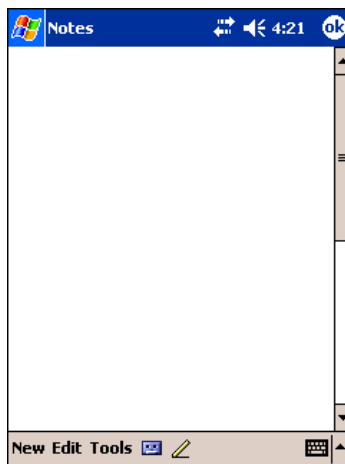

2. Type your note using the SIP or the Dolphin keyboard.

Inbox

Use Inbox to send and receive e-mail messages in either of these ways:

- Synchronize e-mail messages with Microsoft Exchange or Microsoft Outlook on your desktop computer.
- Send and receive e-mail messages by connecting directly to an e-mail server through an ISP or a network.

Synchronizing E-mail Messages

E-mail messages can be synchronized as part of the general synchronization process. You need to enable Inbox synchronization in ActiveSync. For information on enabling Inbox synchronization, see ActiveSync Help on the desktop computer.

During synchronization:

-
- Messages are copied from the mail folders of Exchange or Outlook on your desktop computer to the ActiveSync folder in Inbox on the terminal. By default, you will receive messages from the past three days only, the first 100 lines of each message, and file attachments of less than 100 KB in size.
 - E-mail messages in subfolders must be selected in ActiveSync on your desktop computer to be transferred.
 - E-mail messages in the Outbox folder on the terminal are transferred to Exchange or Outlook, and then sent from those programs.

Note: You can also synchronize e-mail messages with your desktop computer from a remote location. For more information, see Chapter 7.

Connecting Directly to an E-mail Server

In addition to synchronizing e-mail messages with your desktop computer, you can send and receive e-mail messages by connecting to an e-mail server. When you connect the terminal to the e-mail server, new messages are downloaded to the Inbox folder, messages in the Outbox folder are sent, and messages that have been deleted on the e-mail server are removed from the Inbox folder.

Messages received directly from an e-mail server are linked to your e-mail server rather than your desktop computer. When you delete a message on the terminal, it is also deleted from the e-mail server the next time you connect the terminal to the e-mail server according to the settings selected in ActiveSync.

You can work online or offline. When working online, you read and respond to messages while connected to the e-mail server. Messages are sent as soon as you tap **Send**, which saves space on the terminal. When working offline, after you've downloaded new message headers or partial messages, you can disconnect from the e-mail server and then decide which messages to download completely. The next time you connect, Inbox downloads the complete messages you've marked for retrieval and sends the messages you've composed.

Receiving Messages

When you connect to your e-mail server or synchronize with your desktop computer, by default, you'll receive messages from the last five days only, the first 100 lines of each new message, and file attachments of less than 100 KB in size. The original messages remain on the e-mail server or your desktop computer.

You can mark the messages that you want to retrieve in full during your next synchronization or e-mail server connection. In the message list, tap and hold the message you want to retrieve. On the pop-up menu, tap **Mark for Download**. The icons in the Inbox message list give you visual indications of message status.

You specify your downloading preferences when you set up the service or select your synchronization options. You can change them at any time:

- Change options for Inbox synchronization using ActiveSync options. For more information, see ActiveSync Help.
- Change options for direct e-mail server connections in Inbox on the terminal. Tap **Tools** and then tap **Options**. On the **Service** tab, tap the service you want to change. Tap and hold the service and select **Delete** to remove a service.

Using the Message List

Messages you receive are displayed in the message list. By default, the most recently received messages are displayed first in the list and unread messages are displayed in bold type.

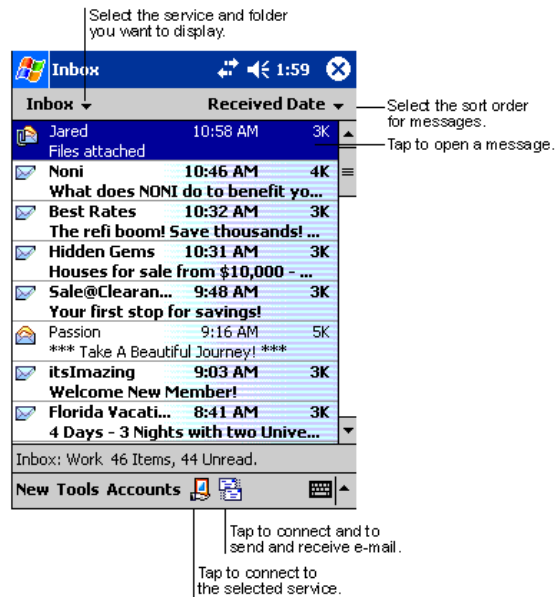

When you tap on a message to open it, the following screen appears:

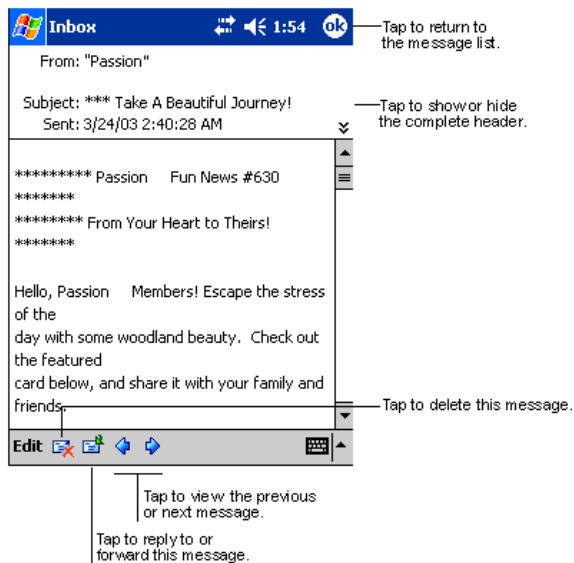

Composing Messages

1. Tap **New**.
2. In the **To** field, enter the e-mail or SMS address of one or more recipients, separating them with a semicolon (;), or select a name from the contact list by tapping the **Address Book** button.
All e-mail addresses entered in the e-mail fields in Contacts appear in the Address Book.
3. Compose your message. To enter preset or frequently used messages, tap **My Text** and select a message.
4. Tap **Send** when you've finished the message.
If you are working offline, the message is moved to the Outbox folder and will be sent the next time you connect.

-
5. If you are sending an SMS message and want to know if it was received, tap **Edit, Options**, and select **Request SMS text message delivery notification** before sending the message.

Managing E-mail Messages and Folders

Messages are displayed in one of five folders for each service you have created: Inbox, Deleted Items, Drafts, Outbox, and Sent Items.

The Deleted Items folder contains messages that have been deleted on the device. The behavior of the Deleted and Sent Items folders depends on the selected options. To select these options, tap **Tools > Options > Message** tab.

To move a message to another folder, in the message list, tap and hold the message, tap **Move to** on the pop-up menu, and select the desired folder.

To create additional folders, tap **Tools > Manage Folders**.

Folder Behavior with a Direct Connection to an E-mail Server

The behavior of the folders you create depends on whether you are using ActiveSync, SMS, POP3, or IMAP4.

ActiveSync

If you use ActiveSync, e-mail messages in the Inbox folder in Outlook on your desktop computer are automatically synchronized with the terminal. You can select to synchronize additional folders by designating them for ActiveSync. The folders you create and the messages you move will then be mirrored on the server.

For example, if you move two messages from the Inbox folder to a folder named Family, and you have designated Family for synchronization, the server creates a copy of the Family folder and copies the messages into that folder. You can then read the messages while away from your desktop computer.

SMS

If you use SMS, messages are stored in the Inbox folder.

POP3

If you use POP3 and you move e-mail messages to a folder you created, the link is broken between the messages on the terminal and their copies on the mail server. The next time you connect, the mail server will see that the messages are missing from the terminal Inbox and delete them from the server. This prevents you from having duplicate copies of a message, but it also means that you will no longer have access to messages that you move to folders created from anywhere except the terminal.

IMAP4

If you use IMAP4, the folders you create and the e-mail messages you move are mirrored on the server. Therefore, messages are available to you anytime you connect to your mail server, whether it is from the terminal or desktop computer. This synchronization of folders occurs whenever you connect to your mail server, create new folders, or rename/delete folders when connected.

Pocket Internet Explorer

Use Microsoft Pocket Internet Explorer to view Web or WAP pages in either of these ways:

- During synchronization with your desktop computer, download your favorite links and mobile favorites that are stored in the Mobile Favorites subfolder in Internet Explorer on the desktop computer.
- Connect to an ISP or network and browse the Web.

When connected to an ISP or network, you can also download files and programs from the Internet or intranet.

Accessing Pocket Internet Explorer

To switch to Pocket Internet Explorer, tap **Start** and then Internet Explorer.

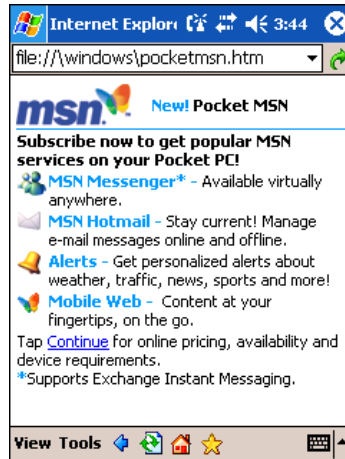

You can use Pocket Internet Explorer to browse Mobile Favorites and channels that have been downloaded without connecting to the Internet. You can also connect to the Internet through an ISP or a network connection and browse the Web.

Browse the Internet on Your Terminal

You must set up a connection to your ISP or corporate network using Connections before browsing; see [Using an ISP](#) on page 6-8.. If you select Pocket Internet Explorer before setting up the network connections, a screen may appear allowing you to proceed to the connection settings screen.

After you select the settings, return to Pocket Internet Explorer.

1. Open Internet Explorer (**Start > Internet Explorer**).
2. To connect and start browsing, tap **View** and then **Address Bar**.
3. In the address bar that appears at the top of the screen, enter the Web address you want to visit and then tap **Go**.
4. Tap the arrow to choose from previously entered addresses.

If Mobile Favorites have been set up, you can tap one of them to start browsing. See [The Mobile Favorites Folder](#) on page 10-11.

To add a favorite link while browsing, go to the page you want to add, tap and hold on the page, and tap **Add to Favorites** on the pop-up menu.

The Mobile Favorites Folder

Purpose

The Mobile Favorites folder was created on your desktop computer when you installed ActiveSync. It enables you to create Favorite Links on your desktop computer that you can transfer to your Dolphin 9500 Series terminal. Those Favorite Links are then available for selection when browsing the internet on your terminal.

Process

First, you create your Favorite Links in the Mobile Favorites folder on your desktop computer. Then, the next time you sync your desktop computer with your terminal, those Mobile Favorites are transferred to the Mobile Favorites folder on your terminal.

Only items stored in the Mobile Favorites subfolder in the Favorites folder in Internet Explorer on your desktop computer are synchronized with the Mobile Favorites folder on your terminal.

Note: Unless you mark a Favorite Link as a mobile favorite, only the link downloads to your terminal, and you will need to connect to your ISP or network to view the content. For more information on synchronization, see *ActiveSync Help* on the desktop computer.

Creating and Synchronizing Mobile Favorites

If you are using Microsoft Internet Explorer 5.0 or later on your desktop computer, you can download Mobile Favorites to the terminal. Synchronizing mobile favorites downloads Web content to your device so that you can view pages while you are disconnected from your ISP and desktop computer.

Use the Internet Explorer plug-in installed with ActiveSync to create mobile favorites

1. On your desktop computer, open Internet Explorer, click **Tools > Create Mobile Favorite**.

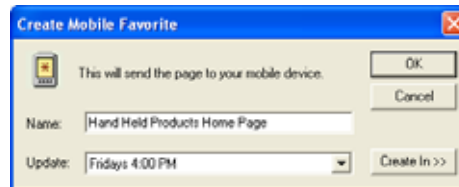

2. To change the link name, enter a new name in the **Name** box.
3. Optionally, in **Update**, select a desired update schedule.
4. Tap **OK**. Internet Explorer downloads the latest version of the page to your desktop computer.
5. If you want to download the pages that are linked to this mobile favorite, in Internet Explorer on the desktop computer, right-click the mobile favorite and then click **Properties**. On the **Download** tab, specify the number of links down that you want to download. To conserve memory, go only one level down.
6. Synchronize the terminal and desktop computer. Mobile favorites that are stored in the Mobile Favorites folder in Internet Explorer are downloaded to the terminal.

If you did not specify an update schedule in Step 3, you will need to manually download content to keep the information updated on your desktop computer and terminal. Before synchronizing, in Internet Explorer on your desktop computer, click **Tools** and then **Synchronize**. You will see the last time content was downloaded to the desktop computer, and you can manually download content if needed.

You can add a button to the Internet Explorer toolbar for creating mobile favorites. In Internet Explorer on your desktop computer, click **View, Toolbars**, and then **Customize**.

View Mobile Favorites and Channels on the Terminal

1. Access Pocket Internet Explorer.
2. Tap the Favorites button to display your list of favorites .

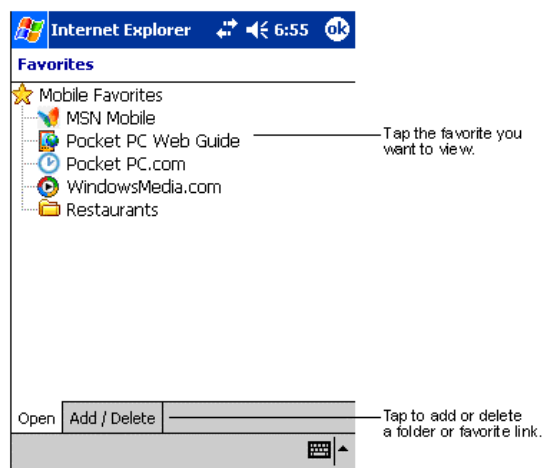

3. Tap the page you want to view.

You'll see the page that was downloaded the last time you synchronized with your desktop computer. If the page is not on the terminal, the favorite will be dimmed. You will need to synchronize with your desktop computer again to download the page to the terminal, or connect to the Internet to view the page.

Mobile favorites take up storage memory on the terminal. To minimize the amount of memory used:

- In the settings for the Favorites information type in ActiveSync options, turn off pictures and sounds, or stop specific mobile favorites from being downloaded to the terminal. For more information, see **ActiveSync Help**.
- Limit the number of downloaded linked pages. In Internet Explorer on the desktop computer, right-click the mobile favorite you want to change and then Properties. On the Download tab, specify 0 or 1 for the number of linked pages you want to download.

Using AvantGo® Channels

AvantGo is a free interactive service that provides access to personalized content and thousands of popular web sites. Subscribe to AvantGo channels directly from the terminal. For more information, visit: <http://avantgo.com/frontdoor/index.html>.

To Sign Up for AvantGo

1. In ActiveSync options on the desktop computer, turn on synchronization for the AvantGo information type.
2. In Pocket Internet Explorer, tap the **Favorites** button to display your list of favorites .
3. Tap the **AvantGo Channels** link.
4. Tap **Activate** and follow the directions on the screen. Synchronize the terminal with your desktop computer and then tap the **My Channels** button to complete the AvantGo setup.
5. When synchronization is complete, tap the **AvantGo Channels** link in your list of favorites to see a few of the most popular channels. To add or remove channels, tap the **Add** or **Remove** link.

Pocket Word

Pocket Word works with Microsoft Word on your desktop computer to give you easy access to copies of your documents. You can create new documents on the terminal, or you can copy and paste documents from your desktop computer. Synchronize documents between your desktop computer and your device so that you have the most up-to-date content in both locations.

You can open only one document at a time; when you open a second document, you'll be asked to save the first. You can save a document you create or edit in a variety of formats, including Word (.doc), Pocket Word (.psw), Rich Text Format (.rtf), and Plain Text (.txt).

Using Pocket Word

Pocket Word contains a list of the files stored on the terminal. Tap a file in the list to open it. To delete, make copies of, and send files, tap and hold a file in the list. Then, select the appropriate action on the pop-up menu.

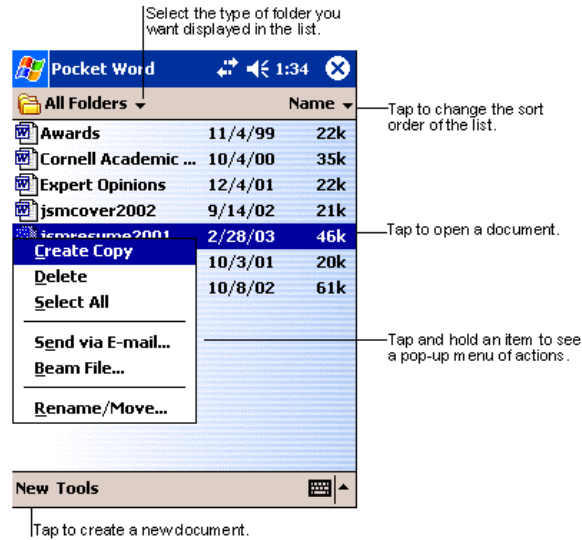

You can change the zoom magnification by tapping **View > Zoom**, and then selecting the percentage you want. Select a higher percentage to enter text and a lower one to see more of your document.

If you're opening a Word document created on a desktop computer, select **Wrap to Window** on the **View** menu so that you can see the entire document.

Creating a Word File

To create a new file, tap **Start > Programs > Pocket Word > New**. A blank document appears. If you've selected a template for new documents in the Options dialog box, that template appears with appropriate text and formatting already provided.

You can enter information in Pocket Word in one of two modes (typing on the SIP or keyboard and drawing), which are displayed on the **View** menu.

Typing Mode

Using the SIP or Dolphin keypad, enter typed text into the document.

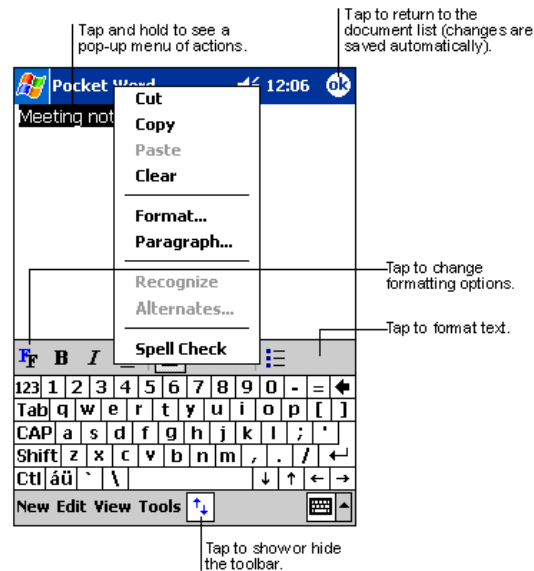

To format existing text and to edit text, first select the text. You can select text as you do in a Word document, using your stylus instead of the mouse to drag through the text you want to select. You can search a document to find text by tapping **Edit** and then **Find/Replace**.

Drawing Mode

In drawing mode, use your stylus to draw on the screen. Gridlines appear as a guide. When you lift your stylus off the screen after the first stroke, you'll see a drawing box indicating the boundaries of the drawing. Every subsequent stroke within or touching the drawing box becomes part of the drawing.

For more information on using Pocket Word, tap **Start** and then **Help**.

Pocket Excel

Pocket Excel works with Microsoft Excel on your desktop computer to give you easy access to copies of your workbooks. You can create new workbooks on the terminal, or you can copy and paste workbooks from your desktop computer. Synchronize workbooks between your desktop computer and the terminal so that you have the most up-to-date content in both locations.

You can open only one workbook at a time; when you open a second workbook, you'll be asked to save the first. You can save a workbook you create or edit in a variety of formats, including Pocket Excel (.pxl) and Excel (.xls).

Pocket Excel contains a list of the files stored on your device. Tap a file in the list to open it. To delete, make copies of, and send files, tap and hold a file in the list. Then select the appropriate action from the pop-up menu. Pocket Excel provides fundamental spreadsheet tools, such as formulas, functions, sorting, and filtering. To display the toolbar, tap **View > Toolbar**.

Creating an Excel File

To create a new file, tap **Start > Programs > Pocket Excel > New**. A blank workbook appears. If you've selected a template for new workbooks in the Options dialog box, that template appears with appropriate text and formatting already provided.

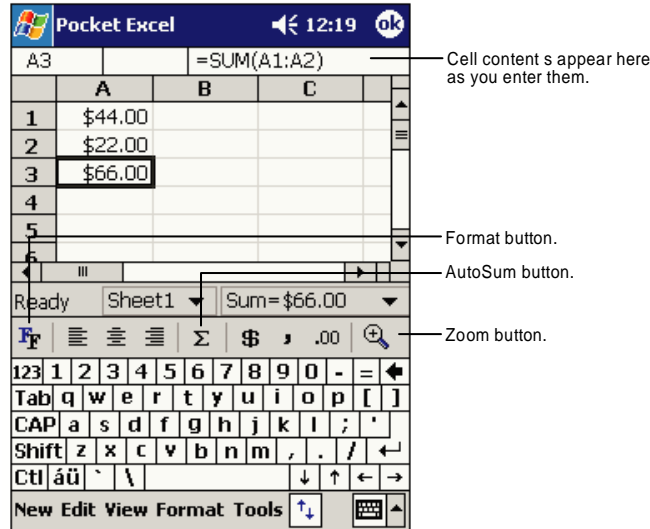

If your workbook contains sensitive information, you can protect it with a password. To do so, open the workbook, tap **Edit**, and then **Password**. Every time you open the workbook, you will need to enter the password, so choose one that is easy for you to remember but hard for others to guess.

Tips for Working in Pocket Excel

- View in full-screen mode to see as much of your worksheet as possible. Tap **View** and then **Full Screen**. To exit full-screen mode, tap **Restore**.
- Show and hide window elements. Tap **View** and then tap the elements you want to show or hide.
- Freeze panes on a worksheet. First select the cell where you want to freeze panes. Tap **View > Freeze Panes**. You might want to freeze the top and left-most panes in a worksheet to keep row and column labels visible as you scroll through a sheet.
- Split panes to view different areas of a large worksheet. Tap **View > Split**. Then drag the split bar to where you want it. To remove the split, tap **View > Remove Split**.
- Show and hide rows and columns. To hide a hidden row or column, select a cell in the row or column you want to hide. Then tap **Format > Row or Column > Hide**. To show a hidden row or column, tap **Tools > Go To**, and then type a reference that is in the hidden row or column. Then tap **Format > Row or Column > Unhide**.

For more information on using Pocket Excel, tap **Start > Help**.

Windows Media Player for Pocket PC

Use Microsoft Windows Media Player (WMP) for Pocket PC to play digital audio and video files stored on the terminal. To switch to Windows Media Player for Pocket PC, tap **Start > Windows Media**.



After a media file has been loaded, you can play, pause, stop, song advance/reverse, mute sound, or adjust volume.

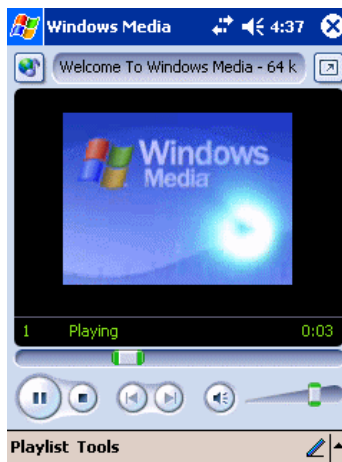

Tools Menu

The tools menu allows you to perform several important functions.

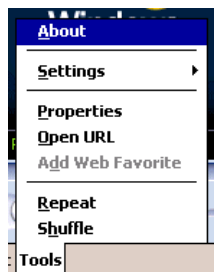

About gives you information about the codecs used in your version of WMP.

Settings allows you to configure several important aspects of WMP.

Properties gives a detailed listing of a media file's attributes.

Open URL allows you to open WMP-compliant media from a network or Internet resource.

Add Web Favorite adds a streaming media file that is currently playing to web favorites.

Repeat plays a playlist repeatedly.

Shuffle plays items in a playlist in a random order.

MSN Messenger

MSN Messenger is an instant messaging program that lets you:

- See who is online.
- Send and receive instant messages.
- Have instant message conversations with groups of contacts.

Note: To use MSN Messenger, you must have a Microsoft Passport™ account or a Microsoft Exchange e-mail account. You must have a Passport to use MSN Messenger Service. If you have a Hotmail or MSN account, you already have a Passport account. Sign up for a Microsoft Passport account at www.passport.com.

Setting Up

Before you can connect for the first time, you must enter the information from your Passport or Exchange account. After you set up your account information on the terminal for the first time, you will go directly to login when you access MSN Messenger.

To Set Up an Account and Sign In

Note: Ensure that you are connected to the Internet (see [Connections Tab](#) on page 5-15).

1. Tap **Start > Programs > MSN Messenger**



2. Tap **Tools > Options > Account** tab.



3. In the Accounts tab, enter your Passport or Exchange account information.
Be sure to indicate the service you're using to connect - Messenger or Exchange.
4. When complete, tap **OK**. You are returned to the sign-in screen.
5. To sign in, tap the sign-in screen and enter your e-mail address and password.

Note: If you already use MSN Messenger, your contacts will show up on your device without being added again.

Pictures

Use Pictures to view JPEG pictures stored on the terminal or storage card.

To begin, tap **Start > Programs > Pictures**.

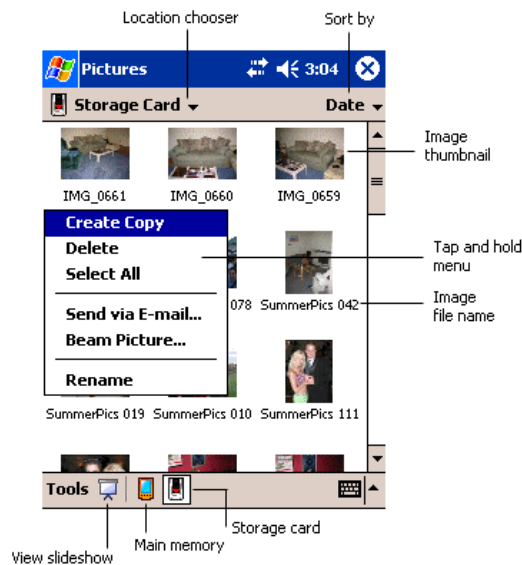

Choose to view main memory or storage card contents. By tapping and holding on an image, you can create a clone of that file, delete that file, select all files, send file via e-mail, beam picture, or rename the image.



Dolphin 9501 and Dolphin 9551

Overview

As part of the Dolphin 9500 Series, the Dolphin 9551 and Dolphin 9501 terminals contain the same robust features, such as the Windows Mobile platform and rugged ergonomics. In addition, the Dolphin 9501 and Dolphin 9551 offer laser engine support, which enables you to scan and decode linear bar codes from greater distances.

The expanded scanning and decoding capabilities combined with the terminal's durability make Dolphin 9551 and Dolphin 9501 terminals ideal for in-premise mobile application environments.

Laser Engine Options and Specifications

Dolphin 9551 and Dolphin 9501 terminals may be equipped with one of the following SE 1200 laser engines:

- High Performance (HP)** The HP non-decoded engine reads
- 5 mil bar codes from 2.75 to 7 in (0.07 to 0.17 m) and
 - 55 mil reflective bar codes from 5 to 50 in (.13 to 1.27 m).
- Long Range (LR)** The LR non-decoded engine reads
- 10 mil bar codes from 10 to 24 in (0.25 to .6 m) and
 - 100 mil reflective bar codes from 66 to 232 in (1.67 to 5.9 m).
- Advanced Long Range (ALR)** The ALR non-decoded engine reads
- 13 mil bar codes from 18 to 39 in (0.45 to 1 m) and
 - 100 mil reflective bar codes from 102 to 363 in (2.6 to 9.2 m).

Note: Dolphin 9501 and Dolphin 9551 terminals do not support image capture.

Bar Code Symbologies Supported

Laser engines support only the decoding of linear bar codes. For a complete list of these codes, see [1D Symbologies](#) on page 2-6.

Laser Engine Location

The laser engine points straight out of the contoured casing on both the Dolphin 9501 and Dolphin 9551.

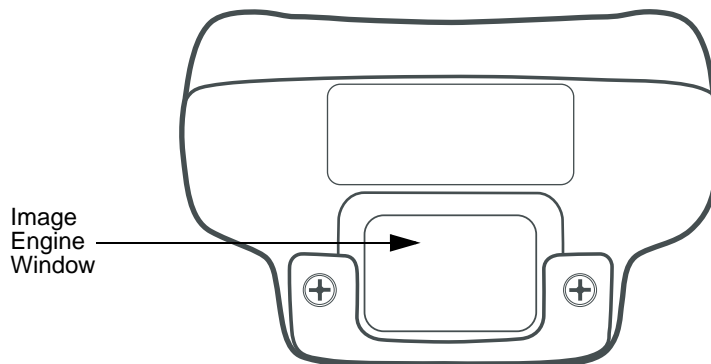

Aiming Options

Laser engines do **not** support omni-directional scanning. To achieve an optimal scan, center the red aiming beam across the bar code horizontally as shown below.



Radio Options

Dolphin 9551 and Dolphin 9501 terminals can be configured with one or a combination of the following radios:

- 802.11b
- Bluetooth

Please note that 802.11b and Bluetooth radios are co-operational. For more information about radio operations, see [The Radio Manager](#) on page 4-16.

Keyboard Options

Dolphin 9551 and Dolphin 9501 terminals can be configured with any of the Dolphin 9500 Series keyboards. For more information, see [Using the Keyboards](#) on page 4-7.

Peripherals and Accessories

Because Dolphin 9551 and Dolphin 9501 terminals have the same mechanical connector ([Mechanical Connector](#), page 3-9), they are compatible with all Dolphin 9500 Series peripherals ([Dolphin 9500 Series Peripherals](#), page 2-3) and accessories ([Dolphin 9500 Series Accessories](#), page 2-4). However, due to their different shape, both the Dolphin 9501 and Dolphin 9551 terminals have their own enclosures.

Note: The Dolphin 9551 requires the Dolphin 9550 Mobile Base to accommodate the handle.

Front Panel Features

Dolphin 9500 Series terminals contain the same front panel features; see [Front Panel Features](#) on page 3-2.

Dolphin 9551

The Dolphin 9551 terminal features the same integrated pistol grip as the Dolphin 9550 for secure and versatile handling in scan-intensive applications. The front end of the bottom housing accommodates the laser engine.

Side Panel

The following graphic shows the left, side panel of the Dolphin 9551.

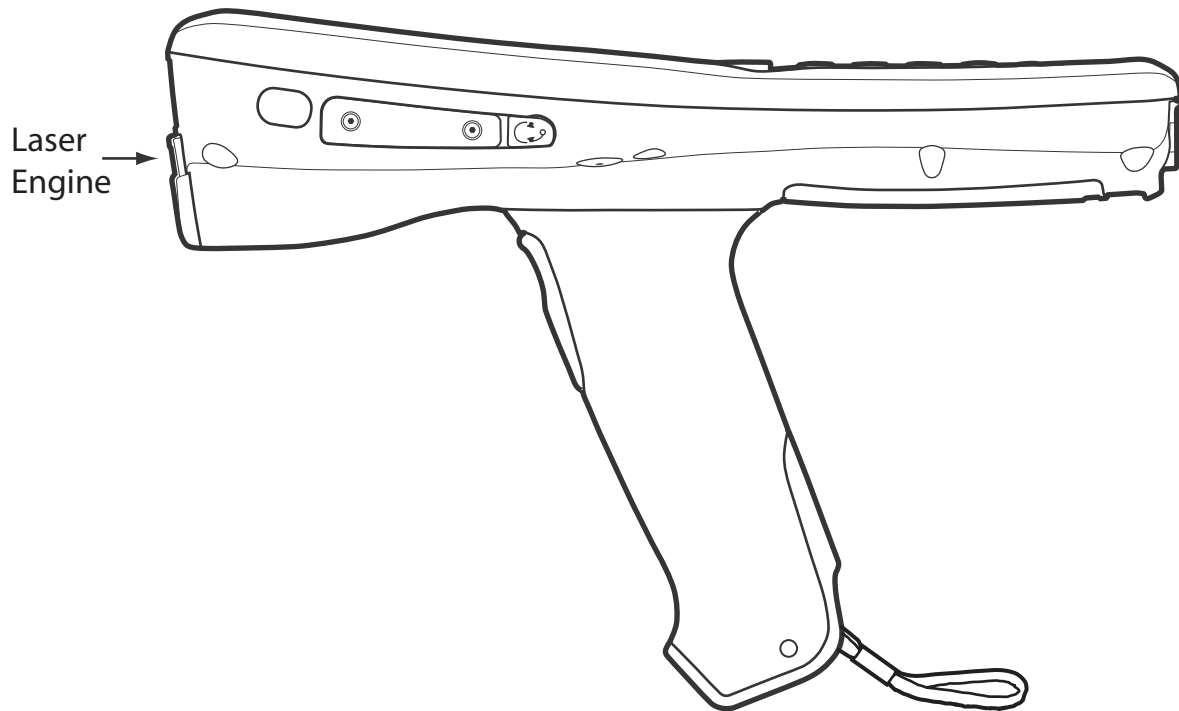

Just like the Dolphin 9550, the stylus is stored in the pistol-grip handle.

Back Panel

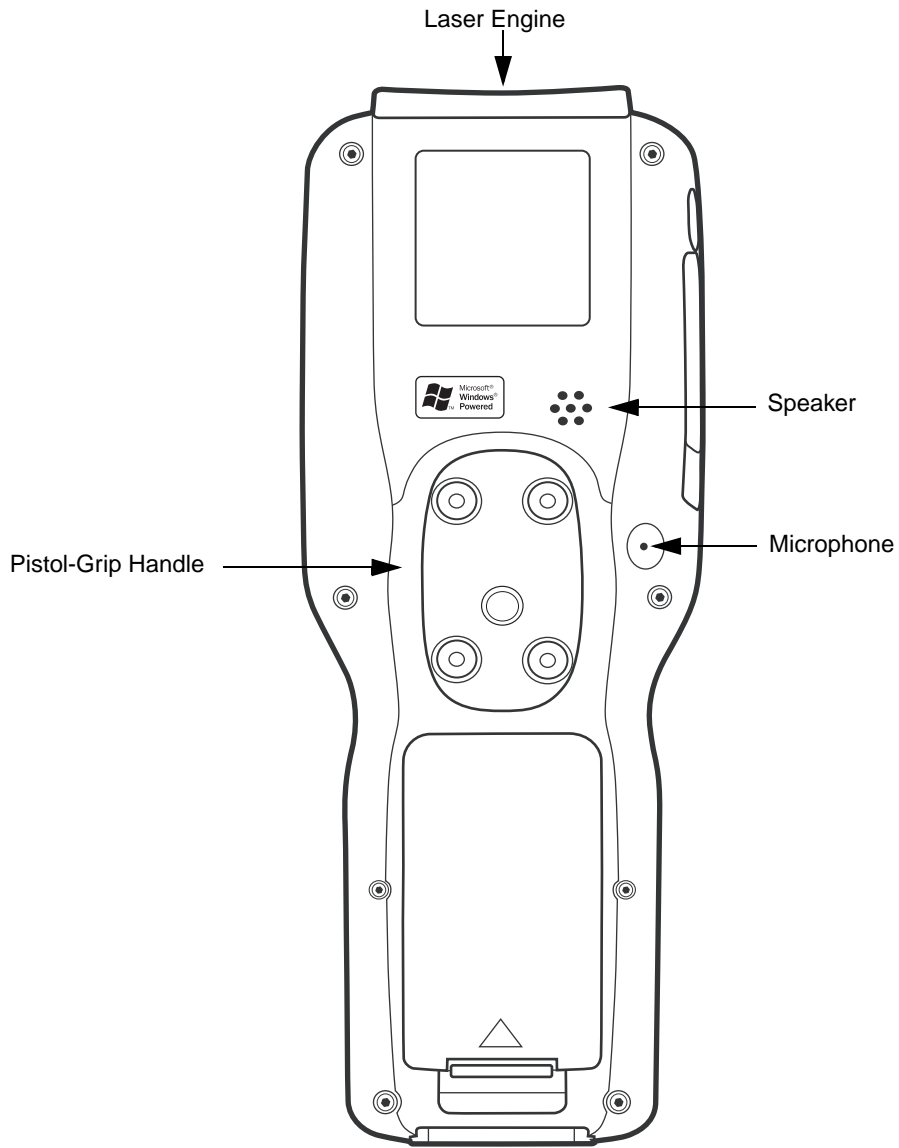

Dolphin 9501

The Dolphin 9501 contains a powerful laser engine inside a solid, flashlight form factor.

Side Panel

Like the Dolphin 9551, the front end of the bottom housing accommodates the laser engine.

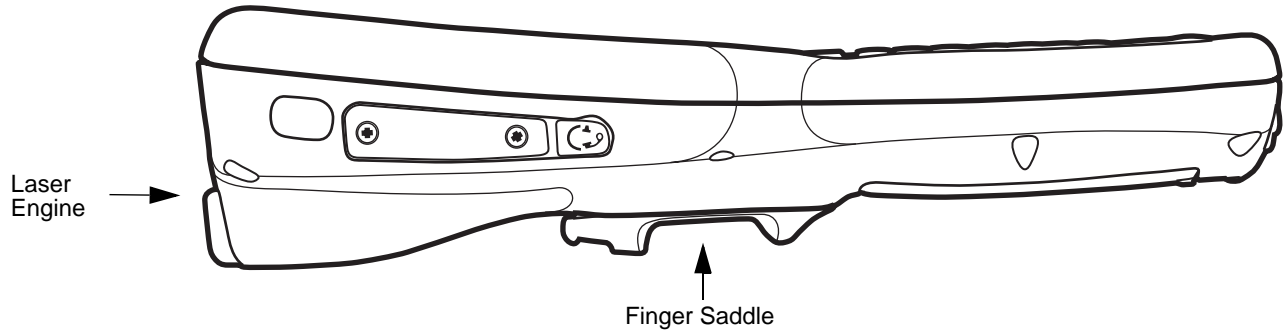

Back Panel

For secure handling in the field, the back panel of the Dolphin 9501 contains a finger saddle.

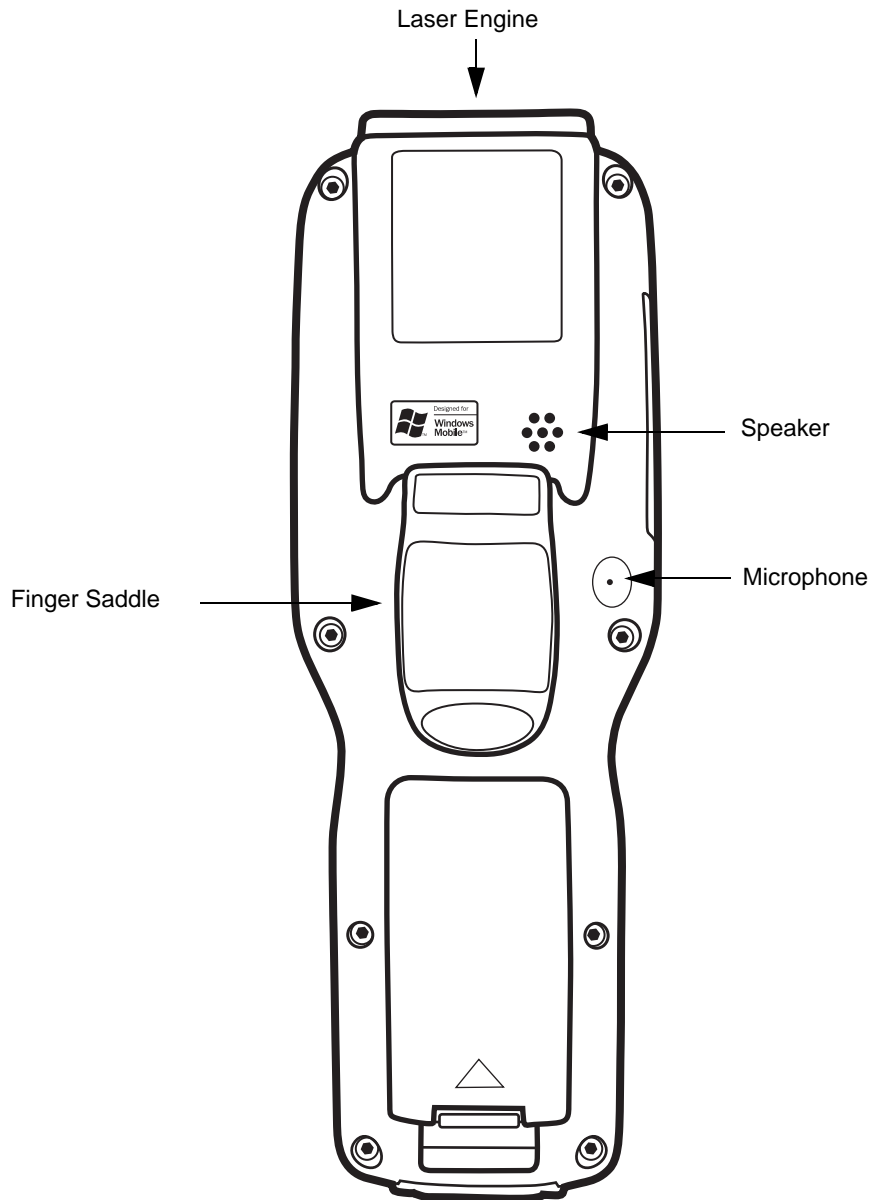

Hand Strap and Stylus

The hand strap is attached to the finger saddle and contains two stylus loops, one on either side of hand strap.

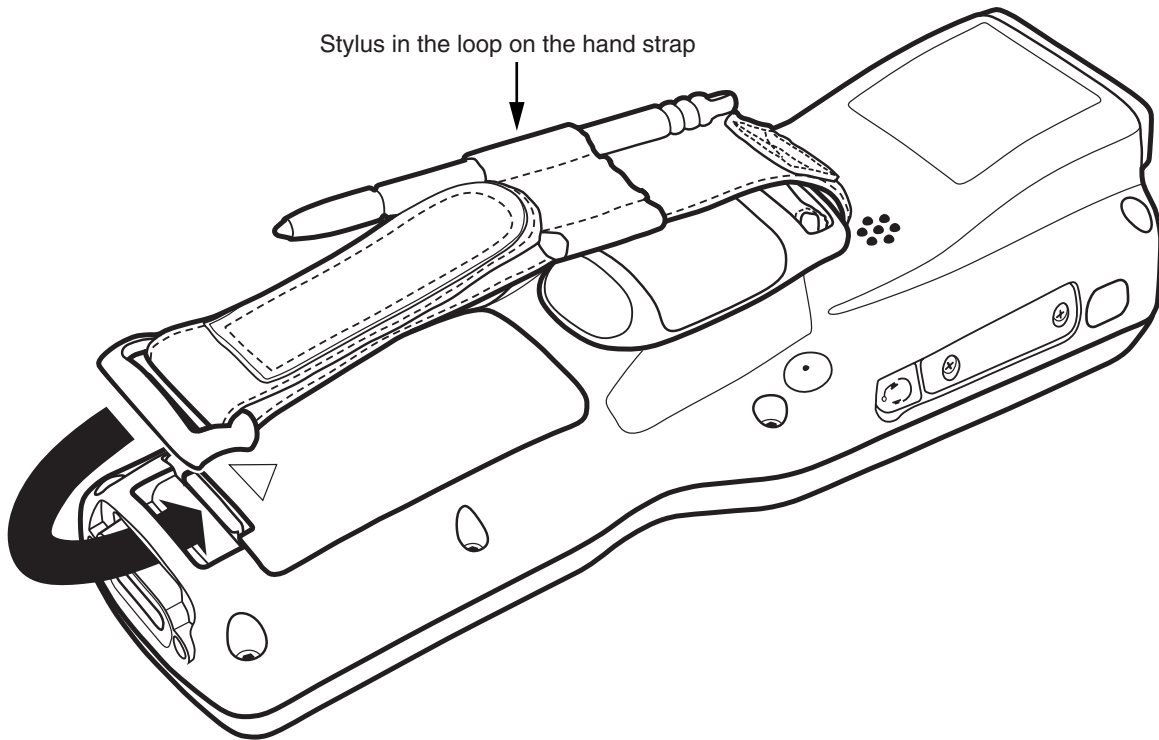

Note: By contrast, on the Dolphin 9500, the hand strap is attached to the top portion of the back panel ([Hand Strap Attachment](#), page 3-4) and the stylus is stored in a slot in the back panel ([Stylus \(in slot\)](#), page 3-4).

Bottom Panel Features

All Dolphin 9500 series terminals contain the same industrial-grade, mechanical connector on the bottom panel; see [Bottom Panel Features](#) on page 3-9.



Overview

As the hub of your Dolphin 9500 Series system, the Dolphin HomeBase charging and communication cradle supports both RS-232 and USB communications, which make it able to interface with the majority of PC-based enterprise systems. When a terminal is seated in the HomeBase, its main battery pack charges in less than four hours.

Power

The HomeBase completes a full charge of the main battery pack in less than four hours. The HomeBase also provides power to the intelligent battery charging system in all Dolphin terminals that senses when a full charge has been achieved and switches to a trickle charge to maintain the full charge.

Communications

Reliable data communications at speeds of up to 115k baud can be transmitted by the HomeBase through the RS-232 serial port. Using the full-speed USB port, the data transmission rate goes up to 12 Mbps.

HomeBases cannot be physically connected to each other - sometimes referred to as "daisy-chained" - but can be networked together via a serial or USB hub.

Convenient Storage

Intelligent battery charging makes the Dolphin HomeBase a safe and convenient storage receptacle for your Dolphin terminal.

Capacity

The Dolphin HomeBase holds one terminal and features an auxiliary battery well behind the terminal well that can charge a battery pack independently of the terminal well. This means that one HomeBase can charge two battery packs: the one installed in the terminal and a spare.



Use only Dolphin 9500 Series peripherals, power cables, and power adapters. Use of peripherals, cables, or power adapters not sold/manufactured by Hand Held Products will void the warranty and may damage the terminal.



Use only the Li-ion battery packs provided by Hand Held Products. The use of any battery pack not sold/manufactured by Hand Held Products in the Dolphin 9500 Series terminals will void your warranty and may result in damage to the Dolphin terminal or battery.

Dolphin 9500 Series HomeBase Parts and Functions

Front Panel

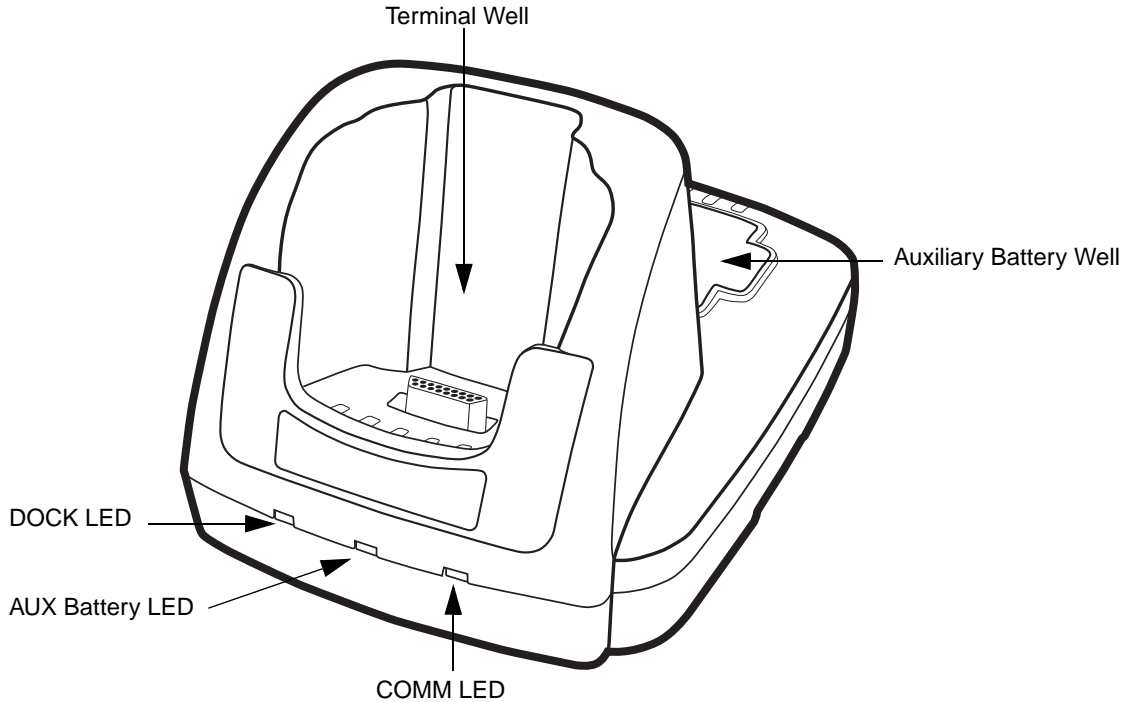

Terminal Well

Place the Dolphin terminal in this well to communicate with a host device, power the terminal, and charge its battery pack. If the host device is a desktop computer that uses ActiveSync, synchronization begins immediately. While seated in the terminal well, the main battery installed in the terminal charges. The HomeBase completely charges a battery pack in less than four hours.

Auxiliary Battery Well

See [Auxiliary Battery Well](#) on page 12-3.

DOCK LED

Turns solid green when the Dolphin terminal is properly seated in the Dolphin HomeBase. When this light is on, the terminal is connected to the base.

AUX Battery LED

Indicates status of the battery charging in the auxiliary battery well.

This color	means...
Orange	The auxiliary battery is charging.
Green	The auxiliary battery has completed charging and is ready for use.

To see the auxiliary battery well, see [Rear Panel](#) on page 12-3.
For information about charging a battery in the auxiliary battery well, see page 12-5

COMM LED

This is the communication LED. It indicates the status of data transfer between the Dolphin terminal and the host device. The color of this LED differs if the HomeBase is using the serial or USB port connection.

If using the serial port

This color	means...
Red	Serial data is being sent from the Host Device to the Dolphin HomeBase.
Green	Serial data is being sent from the Dolphin HomeBase to the Host Device.
Orange	Serial data is being sent at high data rates.

If using the USB port

This color	means...
Green LED	A USB Connection is established with the host computer.

Rear Panel

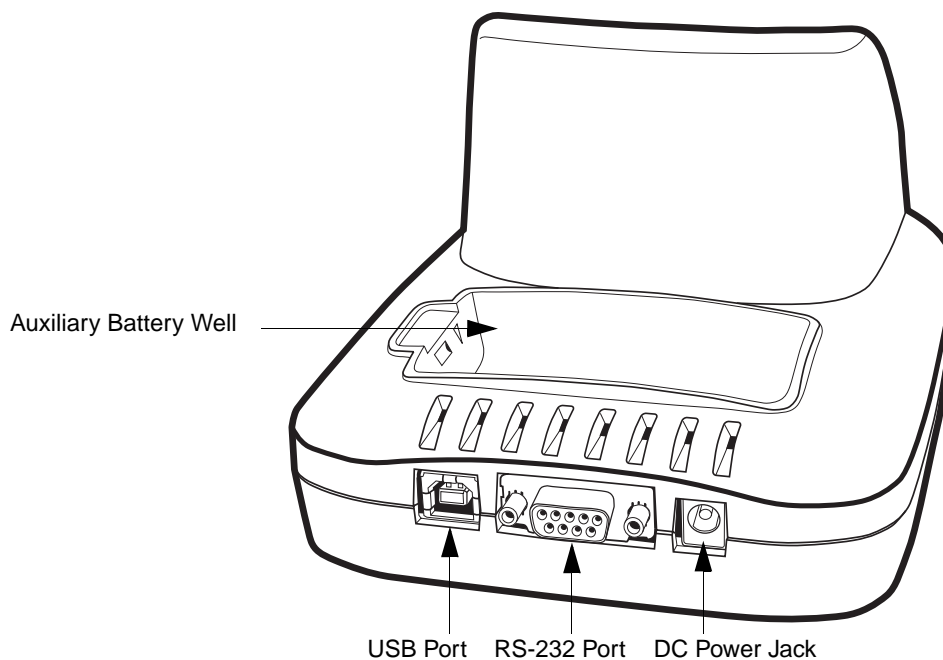

Auxiliary Battery Well

The HomeBase enables you to charge an additional Li-ion battery pack independently of the terminal well. This feature ensures that you can always have a fully-charged battery for your Dolphin terminal. See [Charging a Spare Battery in the Auxiliary Battery Well](#) on page 12-5.

USB Port

This USB Port is full-speed and 2.0 compliant. Using a USB cable, you can connect the HomeBase to a peripheral device, such as a desktop computer or printer. When the Dolphin terminal is seated in the terminal well, it is connected to the peripheral device via the HomeBase. The USB port on the HomeBase requires that you use ActiveSync 3.7 or higher.

RS-232 Port

Use a 9-pin, RS-232 cable from Hand Held Products to connect this port to a peripheral device for RS-232 data communication. For more information, see [HomeBase Serial Connector](#) on page 12-4.

DC Power Jack

Use a power cable from Hand Held Products to supply power to this power jack. For more information, see [Powering the HomeBase](#) on page 12-4.

Powering the HomeBase

The terminal requires 9.5 Volts DC input for communications and battery charging; the Hand Held Products' power cable contains a power adapter that converts the power source voltage accordingly. **Only** the power adapter cable from Hand Held Products converts the voltage appropriately.

Hand Held Products recommends that you leave the Dolphin HomeBase connected to its power source at all times, so that it is always ready to use.

1. Connect the Hand Held Products' power cable to the DC jack on the rear panel of the HomeBase.
2. Connect the Hand Held Products' power cable to the power adapter.
3. Plug the power adapter cable into the power source. The HomeBase is now powered.

HomeBase Serial Connector

The following diagram displays the pin diagram of the serial connector of the HomeBase.

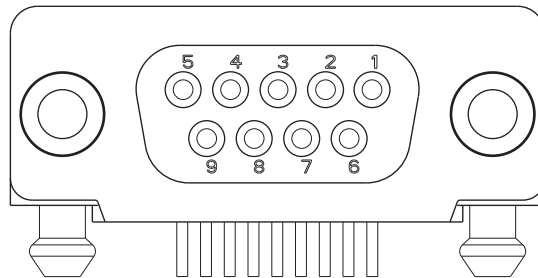

<u>Pin #</u>	<u>Description</u>
1	Internal Jumper to Pin 6
2	TXD
3	RXD
4	DSR
5	GND
6	DTR
7	CTS
8	RTS
9	RI

Note: Signals referenced are for a DTE device. The HomeBase is at a right-angle to the printed circuit board (PCB). The ninth pin has a ring indicator (RI).

Charging the Main Battery

The Dolphin HomeBase powers the terminal and fully charges its main battery pack in less than four hours. The HomeBase contains an intelligent battery charging system that protects the battery from being damaged by overcharging; the unit senses when a battery pack is fully charged and automatically switches to a trickle charge that maintains the battery at full capacity. Therefore, Dolphin terminals may be stored in the HomeBase without damage to the terminals, battery packs, or peripherals.

To check battery power, use the Power system setting; see [Power](#) on page 5-10.

For more information about Hand Held Products Li-ion batteries, see [Batteries](#) on page 3-10.

To Power a Terminal and Charge its Main Battery

1. Install the battery pack in the terminal; see [Install the Main Battery Pack](#) on page 2-7.
1. Connect the HomeBase to the power supply provided by Hand Held Products.
2. Slide the terminal into the terminal well until the Dock LED lights green to indicate that the terminal is properly seated.
3. The battery pack begins charging.

Charging a Spare Battery in the Auxiliary Battery Well

The auxiliary battery well located on the back of the HomeBase charges a spare battery independently of the terminal well. The Aux Battery LED on the front panel indicates the status of the battery in this well.

Charge time is less than four hours; see [Auxiliary Battery Well](#) on page 12-3.

1. Insert the end of the battery without the locking tab into the bottom of the auxiliary well opening.
2. Snap the battery into place with a hinging motion. The Aux Battery LED lights orange.
3. Use the AUX Battery LED to monitor charging progress.

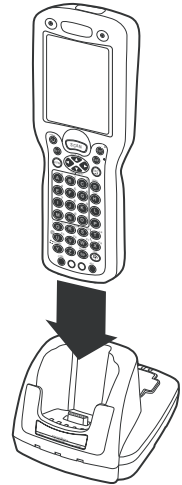

Communications

There are two types of communication available: USB and RS-232.

USB

The HomeBase also supports USB communications via the USB port located on the back. The HomeBase acts as a USB device by interfacing the USB signals of the Dolphin terminal to the USB of the host computer. Using a standard USB cable, the HomeBase's USB interface allows the Dolphin terminal to communicate with a personal computer or to be networked through a USB hub.

RS-232

The HomeBase supports RS-232 communications via the RS-232 Communications Port located on the back of the device. This port enables the Dolphin terminal to communicate to a personal computer, modem, or any RS-232 device using a standard serial cable and communications software.

Note: The HomeBase should have only one type of interface cable connected at a time, either USB or RS-232. You must be using ActiveSync, version 3.7 or higher.

Equipment Requirements

To use the HomeBase for communications, you need the following equipment:

- A HomeBase powered by a power cable and power adapter cable from Hand Held Products
- For RS-232 communications, a Serial cable
- For USB communications, a USB cable

Setting up the HomeBase for USB Communication

Dolphin 9500 Series terminals support USB communications out of the box.

Required Equipment:

- HomeBase with power supply
- USB Cable
- ActiveSync v3.7 or above
- Windows® 98 second edition*, Windows® Me, Windows® 2000, or Windows® XP computer.

Note: The HomeBase does not support Windows NT® when using a USB connection. This is because Windows NT does not support USB.

*Windows® 98 second edition provides full USB support.

To Install the HomeBase Using USB

Note: You must be using ActiveSync 3.7 or higher.

1. Plug in the power supply and connect it to the back of the HomeBase.
2. Plug the USB cable into the back of the HomeBase.
3. At this point, the hardware is installed and operating. You may need to reboot your PC to complete the installation process.

Setting up the Terminal for ActiveSync Communications

1. On the terminal, tap **Start > ActiveSync > Tools > Options**. Activesync opens displaying the PC tab.

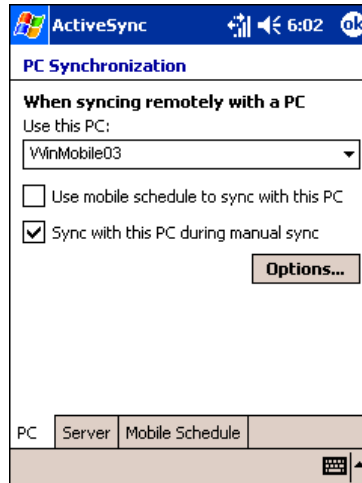

2. In the **Use this PC** drop-down list, select the name of the host PC.
3. Select **Sync with this PC during manual sync** to indicate that the terminal syncs with the selected host PC when synchronization is run from the terminal.
4. Tap **Options**.

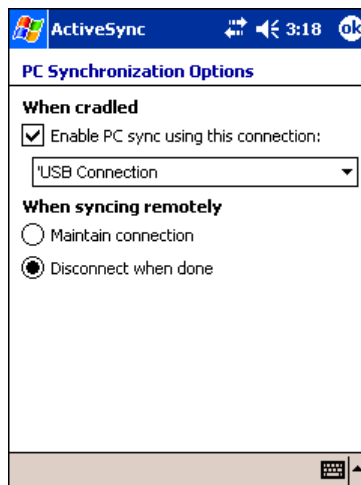

5. Select **Enable PC sync using this connection**, then select 'USB Connection' from the drop-down list.
6. Tap **OK**.
7. Place the Dolphin terminal in the HomeBase. The Dolphin terminal attempts to start an ActiveSync connection with the desktop computer automatically.

Setting up the Desktop Computer for ActiveSync Communications

After the USB HomeBase is installed, you can use ActiveSync to connect to a Dolphin terminal that is properly seated in the HomeBase. These instructions assume that ActiveSync v3.7 is installed on your PC.

The ActiveSync Connection Settings must be set as the following graphic indicates.

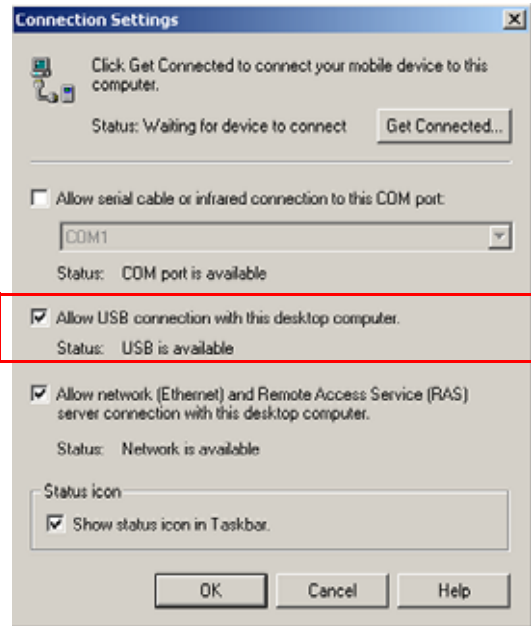

The **Allow USB connection with this desktop computer** box must be checked. Do *not* check the serial cable box.

Communicating with the Dolphin 9500 Series Terminal

To initiate communications between the Dolphin 9500 Series terminal and peripheral, complete these steps:

1. Insert the Dolphin terminal into the terminal well of the HomeBase.
 - The DOCK LED illuminates green. If the DOCK LED does not illuminate, make sure that the terminal is properly seated. You may need to remove and re-insert the terminal.
 - The Dolphin terminal activates; if the power is off, the terminal automatically powers on. If the terminal does not power on, verify that the Hand Held Products power supply is properly connected to the cradle and plugged into a functioning outlet.
 - The Dolphin terminal automatically opens ActiveSync to establish a connection.
2. The HomeBase can now transfer data between the terminal and the host device. If communication does not occur, check the port connections to ensure that the cradle is correctly configured.

Setting up the HomeBase for RS-232 Communications

Connecting the Cables

Connect the HomeBase to the host computer or other device by plugging an RS-232 serial cable into the RS-232 Communications Port on the rear of the HomeBase. The wiring of your cable depends on whether the other device is set up as a Data Communications Equipment (DCE) or Data Terminal Equipment (DTE) device.

The HomeBase Communication Port is configured as a DCE device. To communicate with a DCE device, use either a null modem adapter in line with a standard RS-232 cable, or a null-modem serial cable. To communicate with a DTE device such as a computer, use a standard (or straight-through) RS-232 cable.

You can make your own cables by following the pin configuration in the chart below. To do so, you must determine if your host RS-232 device is 9-pin or 25-pin, and whether it is configured as a DCE or DTE device.

RS-232 Pin Configuration

HomeBase /Host Port (DCE)	IBM AT DB9 (DTE)	IBM XT DB25 (DTE)	Modem DB25 (DCE)
------------------------------	---------------------	----------------------	---------------------

Pin / Input Signal			
2 / (RD)	2	3	2
3 / (TD)	3	2	3
5 / (SG)	5	7	7
4 / (DTR)	4	20	6
6 / (DSR)	6	6	20
7 / (RTS)	7	4	5
8 / (CTS)	8	5	4

Note: The HomeBase **cannot** be daisy-chained.

Setting up the Terminal for ActiveSync Communications

1. On the terminal, tap **Start > ActiveSync > Tools > Options**. Activesync opens displaying the PC tab.

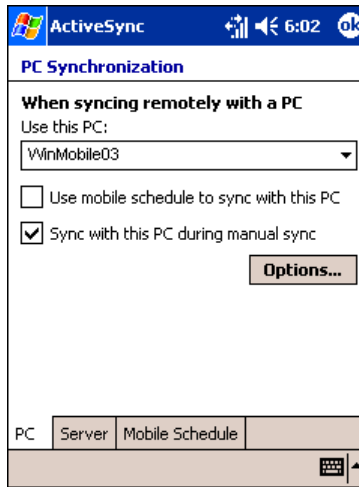

2. In the **Use this PC** drop-down list, select the name of the host PC.
3. Select **Sync with this PC during manual sync** to indicate that the terminal syncs with the selected host PC when synchronization is run from the terminal.
4. Tap **Options**.

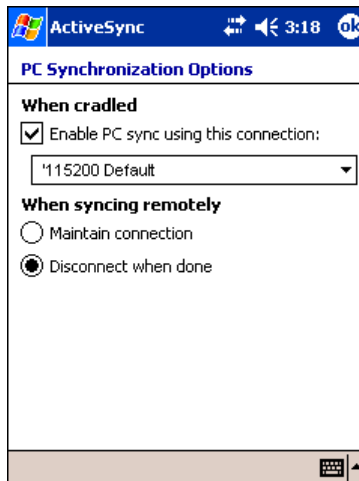

-
- Under **When cradled**, select **Enable PC sync using this connection**, and select **'115200 Default** from the drop-down list. '115200 baud is recommended for RS-232 communication.
 - Tap **OK**.
 - Place the Dolphin in the HomeBase. The terminal attempts to start an ActiveSync connection with the desktop computer automatically.

Setting up the Desktop Computer for ActiveSync Communications

ActiveSync must be installed and configured for RS-232 on the desktop computer to sync successfully with a Dolphin terminal configured for RS-232 communication.

The following graphic displays the correct ActiveSync Connection Settings on the desktop computer for an RS-232 connection.



Note: You can have the USB connection box checked in addition to the serial cable box without affecting processing. However, you would most likely use one or the other.

Verifying Communication

You can verify that the USB driver is functioning by watching the COMM LED on the USB HomeBase. When the COMM LED illuminates solid green, the HomeBase is communicating with the host device.

Verifying Data Transfer

The COMM LED flashes when data is being transferred via the HomeBase. For an RS-232 connection, the COMM LED flashes red and green. For a USB connection, the COMM LED flashes green.

Mounting the HomeBase

Set the Dolphin HomeBase on a dry, stable surface, such as a desktop or workbench near an electrical outlet. Be sure to provide enough workspace with good lighting for the user to view and operate the Dolphin terminal while it is in the HomeBase.

When choosing a location, bear in mind that:

- the mounting location must allow users easy access to the Auxiliary Battery Well, and
- the serial and USB ports as well as the power jack face straight out of the rear panel, and you will most likely want easy access to them in the future.

Desk Mounting

Dolphin charging/communication cradles have a DIN rail (7.5 X 35 mm) slot on the bottom to allow for secure desk attachment of the unit if desired.

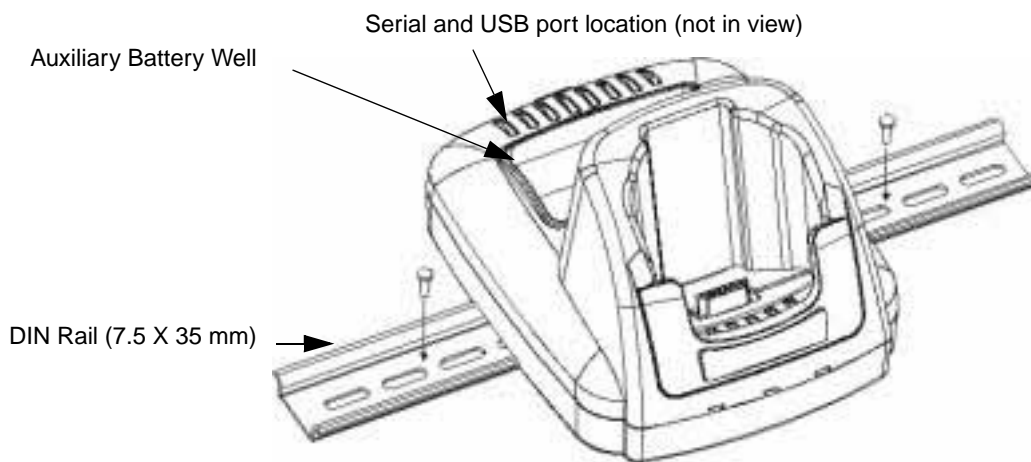

To mount the HomeBase, you slide the DIN rail slot along the bottom panel and secure it. Then, using the appropriate nuts and bolts, secure the DIN rail to the desk or flat surface.

Wall Mounting

You can purchase a wall mount kit that contains

- a mounting bracket,
- three screws, and
- six washer/nut sets.

1. Insert a screw into the round end of each screw slot on the bottom panel. Slide each screw towards the narrow end of the slot. Then, use a washer/nut set on each screw to secure the screw in the slot.

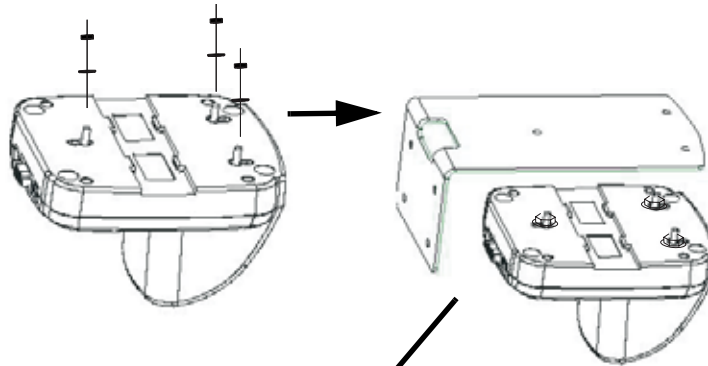

2. Attach the bottom panel to the mounting bracket; match the holes to the secured screws.

3. Use the remaining washer/nut sets to secure the mounting brackets to the bottom panel.

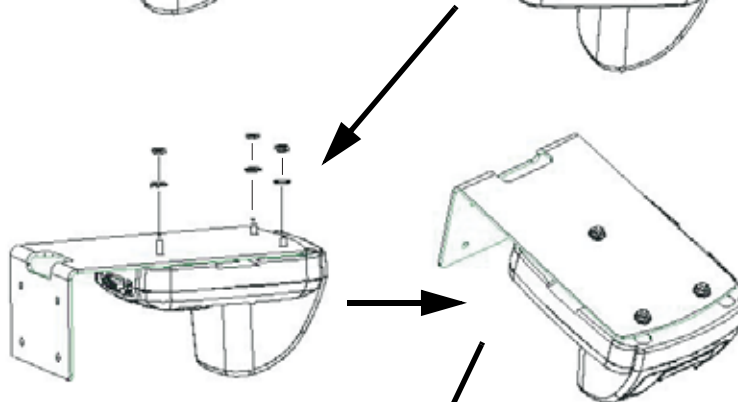

4. Turn the secured HomeBase right side up.

5. Secure the back wedge of the mounting brackets to a stable vertical surface.

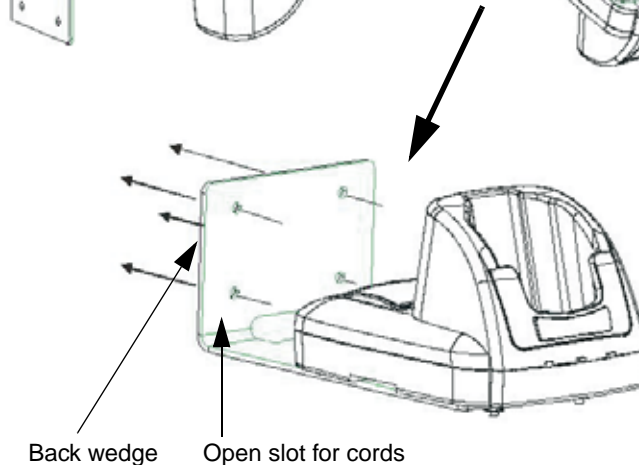

The back wedge of the mounting bracket contains an open slot for the power and communications cables. There is an extra space between this slot and the rear panel of the HomeBase to allow easy access to the power and communications ports. For more details on both ports, see [Rear Panel](#) on page 12-3..

Overview

The Dolphin Mobile Base charging and communication cradle is designed specifically for in-premise and in-transit data collection applications. It features a flexible mounting bracket, a cigarette lighter adapter, and a power cable to adapt it to your environment.

When a terminal is seated in the Mobile Base, its main battery pack charges in less than four hours. The serial connector supports RS-232 communication and power out to peripheral devices, such as hand held scanners.

As the hub of your Dolphin 9500 Series mobile data collection system, the Mobile Base performs three important functions: charging, communications, and storage.

Charging

The Dolphin Mobile Base completes a full charge of the main battery pack in less than four hours. The Mobile Base also provides power to the intelligent battery charging system in all Dolphin terminals that senses when a full charge has been achieved and switches to a trickle charge to maintain the full charge.

Communications

The Mobile Base transmits data to other devices at speeds of up to 115K baud via its RS-232 serial port.

Convenient Storage

Intelligent battery charging makes the Mobile Base a safe and convenient storage receptacle for your Dolphin terminal.

Capacity

The Mobile Base holds one terminal.



Use only Dolphin 9500 Series peripherals, power cables, and power adapters. Use of peripherals, cables, or power adapters not sold/manufactured by Hand Held Products will void the warranty and may damage the terminal.



Use only the Li-ion battery packs provided by Hand Held Products. The use of any battery pack not sold/manufactured by Hand Held Products in Dolphin 9500 Series terminals will void your warranty and may result in damage to the Dolphin terminal or battery.

Mobile Base Parts and Functions

Front Panel

The front panel of the Mobile Base has one slot. The following graphic features the Mobile Base with the Dolphin 9500 inserted into the terminal well.

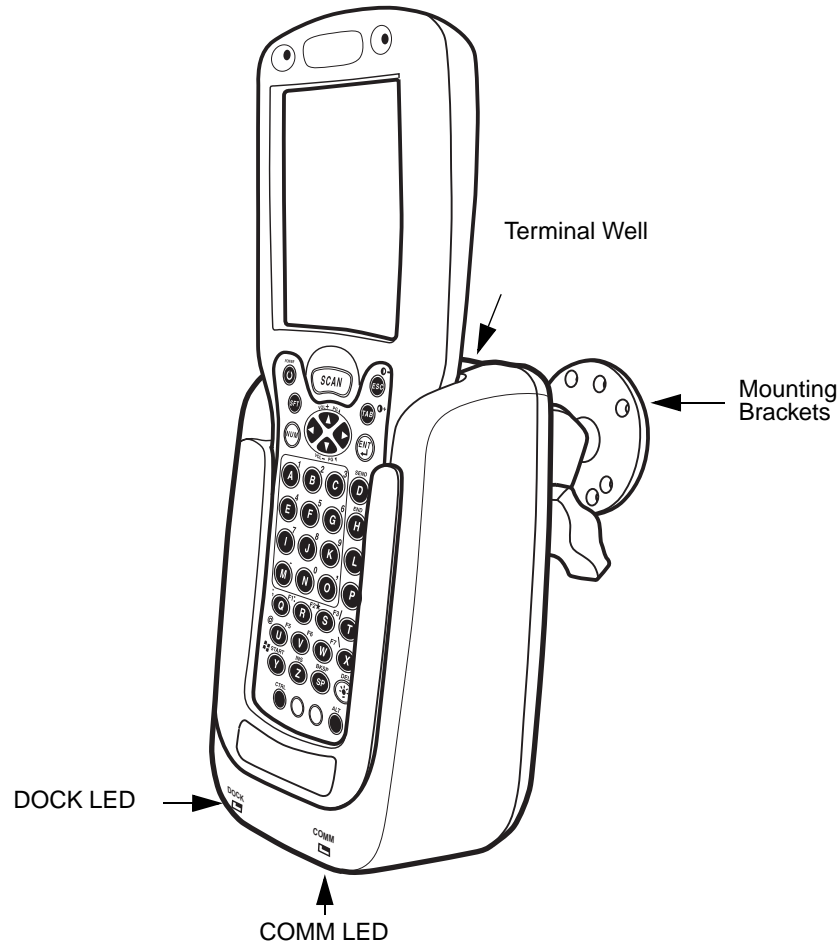

Terminal Well

Place the terminal in this well to communicate with a host device and charge the main battery pack.

Mounting Brackets

Use these to mount the Mobile Base to a fixed location.

DOCK LED

Illuminates solid green when the Dolphin terminal is properly seated in the terminal well.

COMM LED

Indicates the status of data transfer between the host device and the Dolphin terminal

COMM LED color Indicates that...

- Red** Data is being sent from the Host Device to the Dolphin Mobile Base.
- Green** Data is being sent from the Dolphin Mobile Base to the Host Device.
- Orange** Data is being sent at high data rates.

Bottom Panel

The power supply and RS-232 connectors are located on the bottom of the unit.

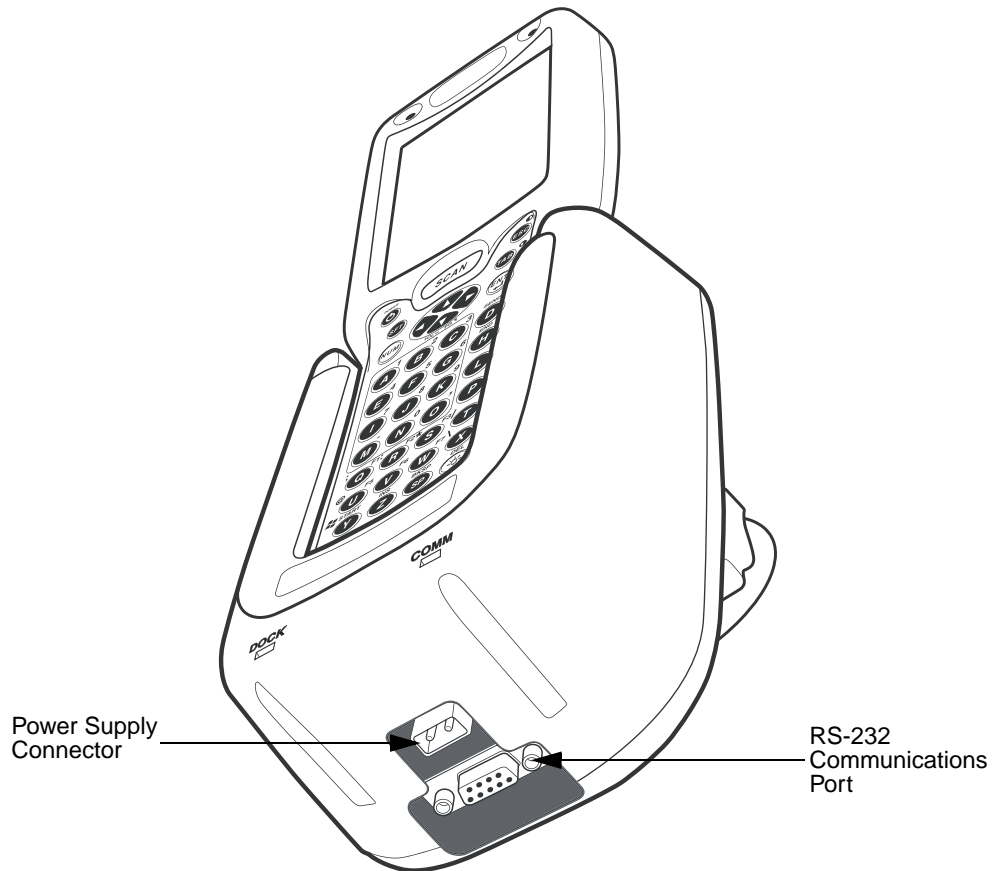

Power Supply Connector

Use this connector to attach a Hand Held Products power cable to the Dolphin 9500 Series Mobile Base. The Mobile Base can be powered by an external DC power source of between 11 VDC to 48 VDC.

To run on vehicle power, you can use the 12 VDC cable or 24 VDC cable option. The appropriate cable comes with the kit you ordered. The 12 VDC cable can be used with a cigarette lighter outlet. The 24 VDC, pigtail cable can be used to “hard-wire” into the vehicle power bus.



Verify that the power source is always within the specified range and observe correct input voltage polarity. An improper input voltage range (above the 48 VDC maximum) or reverse polarity could damage the power conversion circuitry.

RS-232 Communications Port

Use a standard serial cable to connect the unit to a host device via RS-232; see [Mobile Base Serial Connector](#) on page 13-8.

Powering the Dolphin Terminal

When seated in a Mobile Base that is connected to the appropriate power source, the Dolphin terminal receives the power to charge its main battery and run its internal circuitry. Keep the Mobile Base plugged into the power source so that the Dolphin terminal battery pack stays fully charged.

For more information about powering the Mobile Base, see [Powering the Dolphin Mobile Base](#) on page 13-6.

Charging the Dolphin Terminal

The Mobile Base supplies charging power to the Dolphin terminal so that the terminal can monitor the charging of its battery pack. This charging method protects the battery from being damaged by overcharging. Therefore, the Dolphin terminal may be stored indefinitely in the Mobile Base without damage to the terminal, the battery pack, or the Mobile Base.

To charge a Dolphin terminal, complete these steps:

1. Insert a battery pack into the Dolphin terminal.
2. Slide the terminal, imager window up and the LCD visible, into the terminal well of the Mobile Base until it stops.
3. When the Dolphin terminal is properly seated, the DOCK LED on the Mobile Base illuminates solid green. The terminal begins charging automatically.

Installing the Dolphin Mobile Base

To install the Dolphin Mobile Base, you need to mount it securely to an appropriate location and supply it with power.

Mounting the Mobile Base

The adjustable mounting bracket holds the terminal securely in place and gives the user a variety of options for mounting the Mobile Base. When selecting a location, keep in mind that the power supply and serial connectors point straight out the bottom panel.

Back Panel and Brackets

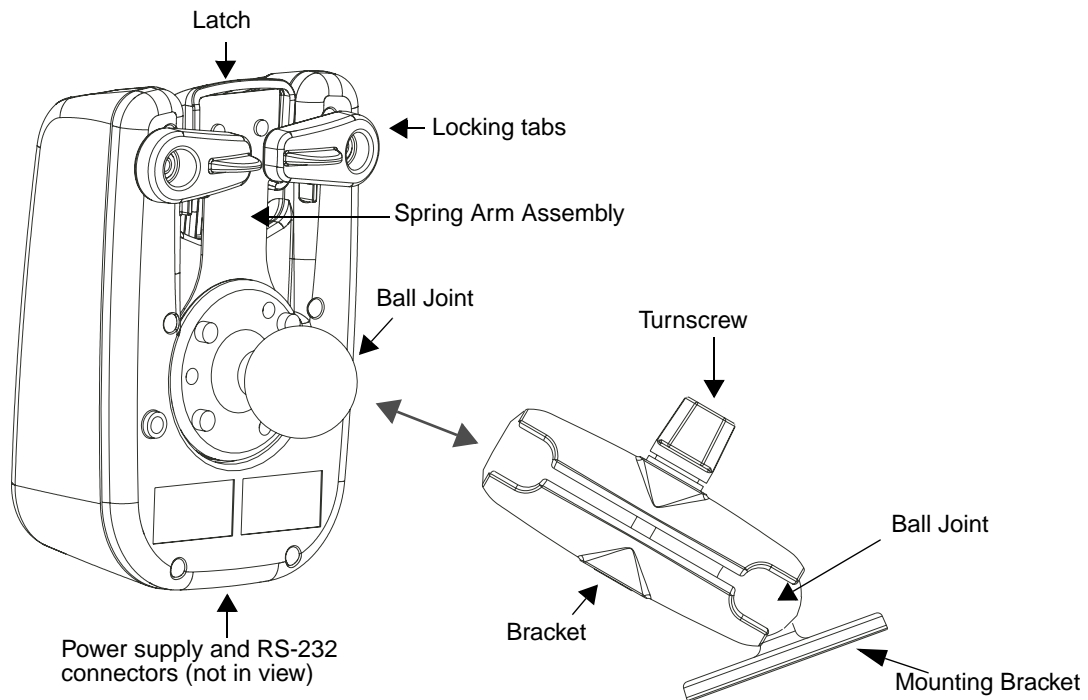

1. Loosen the turnscrew.
2. Insert the ball joint of the mounting bracket to the back of the bracket.
3. Insert the ball joint on the back of the Mobile Base into the other side of the bracket.
4. Tighten the turnscrew to secure both ball joints.
5. Secure the mounting bracket to the appropriate location.

Back Panel

Latch

The latch sits on top of the spring arm assembly and holds the back of the terminal securely in place. The graphic above displays the mounting of a Dolphin 9500 terminal. There is another Dolphin Mobile Base that contains a special latch to accommodate the pistol-grip handle on the Dolphin 9550.

Locking Tabs

When positioned as shown in the above graphic, the locking tabs secure the spring arm assembly, latch, and terminal in place. When seating a terminal, turn both arms up to allow the spring arm to move as necessary while the terminal is being inserted. After the terminal is seated, turn both arms toward the center to lock them.

The both locking tabs must be pointing up to insert or remove a terminal in the Mobile Base.

Spring Arm Assembly

The spring arm assembly is the column that connects the latch to the back of the Mobile Base.

Ball Joints

There are two ball joints: one on the back of the Mobile Base and one on the mounting bracket. Both ball joints are inserted into the bracket and secured to mount the Mobile Base.

Connectors

The power and RS-232 connectors are located on the bottom panel. For more information, see [Bottom Panel](#) on page 13-3.

Brackets

Bracket

The bracket contains the turn screw and two slots. Ball joints are inserted into each slot and secured with the turn screw.

Turn screw

The turn screw is located on the top of the bracket. Rotate the turn screw to secure or loosen the ball joint slots.

Mounting Bracket

The mounting bracket is what you attach to the mounting surface. It is comprised of a ball joint and flat disk. The disk contains drill holes you use to secure the Mobile Base to the mounting surface.

Powering the Dolphin Mobile Base

Note: Hand Held Products recommends that you leave the Mobile Base connected to its power source at all times.

The Mobile Base is powered via the power connector on the bottom panel; see [Bottom Panel](#) on page 13-3.. Both the power and serial connectors are straight out, not at an angle. The Mobile Base must be powered by a 12 to 48 volt DC source.

Setting the Mobile Base Up for Communications

The Mobile Base RS-232 interface allows the Dolphin terminal to communicate to a personal computer, modem, or any standard RS-232 device using a standard serial cable and communications software.

Connecting the Cables

Connect the Mobile Base to the host computer or other device by plugging an RS-232 serial cable into the RS-232 Communications Port on the bottom of the Mobile Base. Plug the other end of the RS-232 serial cable into the correct port on the host RS-232 device.

The wiring of your cable depends on whether the other device is set up as a Data Communications Equipment (DCE) or Data Terminal Equipment (DTE) device.

The Mobile Base Communication Port is configured as a DCE device. To communicate with a DTE device such as a computer, use a standard (or straight-through) RS-232 cable. To communicate with a DCE device, use either a null modem adapter in line with a standard RS-232 cable, or a null-modem serial cable.

RS-232 Pin Configuration

Mobile Base /Host Port (DCE)	IBM AT DB9 (DTE)	IBM XT DB25 (DTE)	Modem DB25 (DCE)
Pin / Input Signal			
2 / (RD)	2	3	2
3 / (TD)	3	2	3
5 / (SG)	5	7	7
4 / (DTR)	4	20	6
6 / (DSR)	6	6	20
7 / (RTS)	7	4	5
8 / (CTS)	8	5	4

Refer to this table if you want to make your own cables. To do so, you must determine if your host RS-232 device is

- 9-pin or 25-pin and
- configured as a DCE or DTE device.

Mobile Base Serial Connector

The following diagram displays the pin diagram of the serial connector of the bottom panel of the Mobile Base.

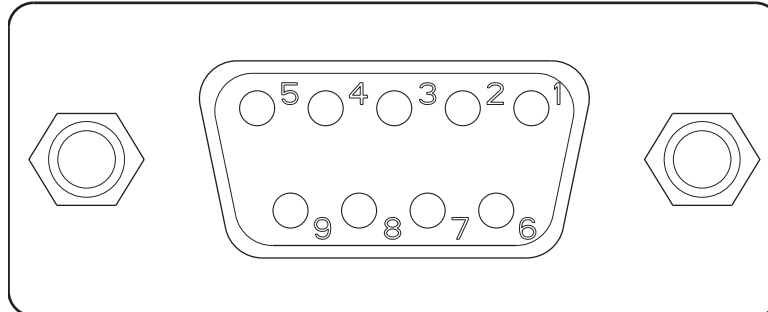

Pin #	Description
1	Internal Jumper to Pin 6
2	TXD
3	RXD
4	DSR
5	GND
6	DTR
7	CTS
8	RTS
9	5 VOLT OUT

Note: Signals referenced are for a DTE device.

The Mobile Base connector is straight to the printed circuit board (PCB). The ninth pin sends 500mA at 5V power out. This can power a peripheral device, such as a mobile printer, as long as that peripheral device can accept 500mA at 5V.

Configuring the Terminal for ActiveSync Communications

1. On the terminal, tap **Start > ActiveSync > Tools > Options**. ActiveSync opens displaying the PC tab.

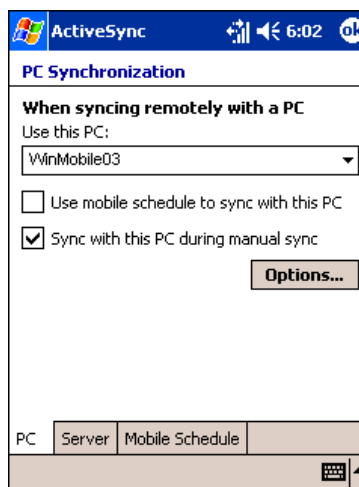

2. In the **Use this PC** drop-down list, select the name of the host PC.

3. Select **Sync with this PC during manual sync** to indicate that the terminal syncs with the selected host PC when synchronization is run from the terminal.

4. Tap **Options**.

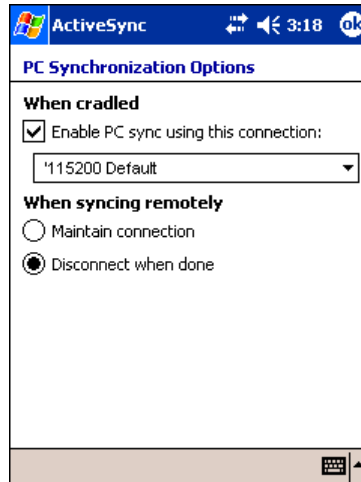

5. Select **Enable PC sync using this connection**, then select ***115200 Default** from the drop-down list. *115200 baud is recommended for RS-232 communication.

6. Tap **OK**.

7. Place the Dolphin terminal in the Mobile Base. The Dolphin terminal attempts to start an ActiveSync connection with the desktop computer automatically.



Overview

The Dolphin ChargeBase is a four-slot charging cradle that can power four Dolphin terminals, and charge their main batteries in less than four hours.

Charging

The Dolphin ChargeBase completes a full charge of the main battery pack in less than four hours. The ChargeBase also provides power to the intelligent battery charging system in all Dolphin terminals that senses when a full charge has been achieved and switches to a trickle charge to maintain the full charge.

As battery packs charge, the charging circuitry follows the two-step charging process (CC-CV) that is recommended for Li-Ion batteries. The process monitors changes in temperature, current, and voltage.

Convenient Storage

Intelligent battery charging makes the Dolphin ChargeBase a safe and convenient storage receptacle for your Dolphin terminal.

Capacity

The ChargeBase can hold up to four Dolphin 9500 Series terminals. Each charging slot charges each terminal independently of the other slots.



Use only Dolphin 9500 Series peripherals, power cables, and power adapters. Use of peripherals, cables, or power adapters not sold/manufactured by Hand Held Products will void the warranty and may damage the terminal.



Use only the Li-ion battery packs provided by Hand Held Products. The use of any battery pack not sold/manufactured by Hand Held Products in Dolphin 9500 Series terminals will void your warranty and may result in damage to the Dolphin terminal or battery.

Dolphin ChargeBase Parts and Functions

Front Panel

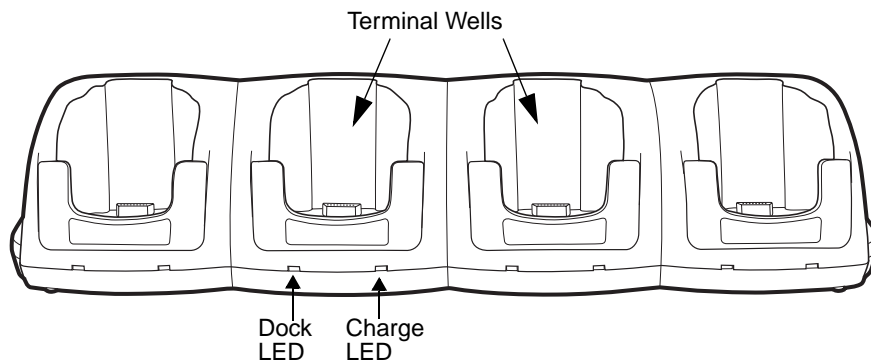

Terminal Wells

The ChargeBase contains four terminals wells. Each well

- Holds and charges the main battery pack of one Dolphin terminal.
- Contains the companion to the industrial-grade, 17-pin connector on the bottom panel of Dolphin terminals.
- Has two LEDs on the front: the Dock LED and the Charge LED.

Dock LED

Each terminal well displays a Dock LED on the front that lights solid green when a terminal is properly seated, which means that the terminal and the base are connected.

Charge LEDs

Each terminal well displays a Charge LED on the front that lights green to indicate charging. For details, see [Charging Terminals in the ChargeBase](#) on page 14-4.

Back Panel

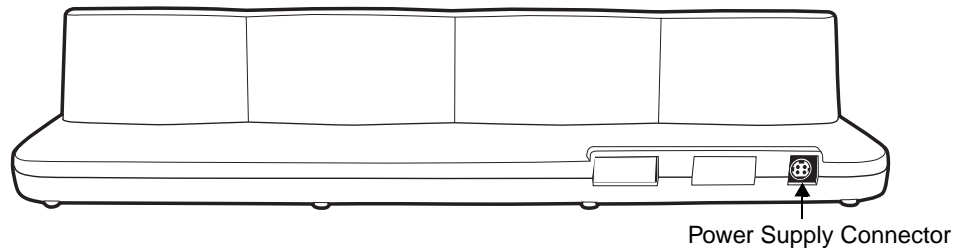

Power Supply Connector

This connector receives input from the power adapter. Plug the power connector cable from the power adapter into this connector. There is no ON/OFF switch on the back panel of the ChargeBase. The power switch is on the power adapter.

Power Supply

The ChargeBase includes a power supply that contains a power adapter to ensure the proper voltage. The power adapter is plugged into standard AC/DC outlets.

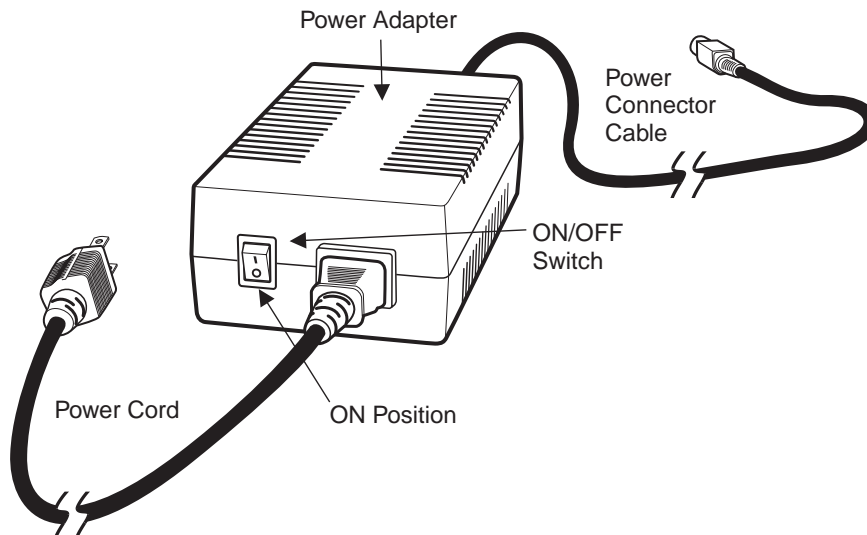

Supplying Power to the ChargeBase



Using a non-Hand Held Products power adapter voids your warranty and could result in serious damage to the circuitry of the Dolphin ChargeBase.

1. Be sure the power switch on the power adapter is in the OFF position.
2. Plug the power cord into the power adapter.
3. Plug the power connector cable into the power connector on the back panel of the ChargeBase.
4. Plug the power cord into a standard wall outlet.
5. On the power adapter, turn the power switch to the ON position. The LEDs illuminate as the ChargeBase powers up.
6. The ChargeBase is ready to begin charging terminals.

Inserting and Removing Terminals

1. To insert the terminal, hold the terminal with the bottom panel perpendicular to the base.

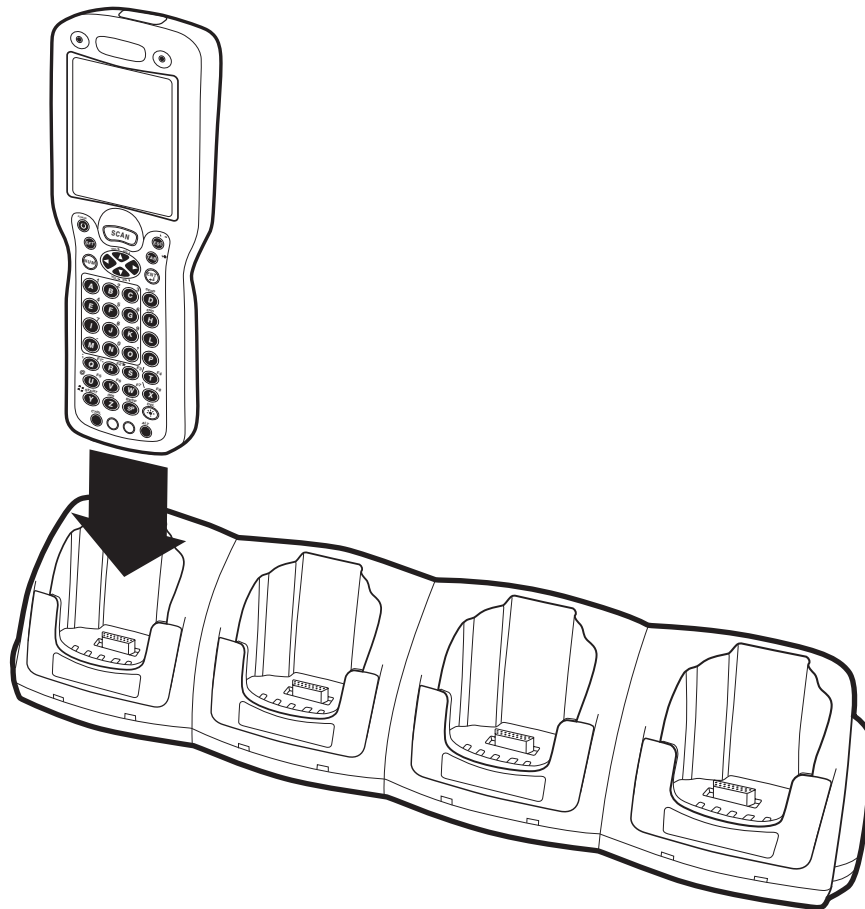

2. Slide the terminal into the well until the Dock LED lights solid green.
3. Charging begins immediately.

Note: To remove a terminal, grasp it firmly in your hand and lift it up and out of the terminal well. The LEDs for the terminal well turns off.

Charging Terminals in the ChargeBase

The Dolphin ChargeBase charges the main battery of each terminal in less than four hours. The ChargeBase uses the intelligent battery charging system incorporated into all Dolphin terminals that prevents overcharging. This means that Dolphin terminals may be stored in the ChargeBase indefinitely without damage to the terminals, battery packs, or the ChargeBase.

1. Power the ChargeBase; see [Supplying Power to the ChargeBase](#) on page 14-3.
2. Insert a terminal into a terminal well; see [Inserting and Removing Terminals](#) on page 14-3.
3. The Charge LED lights green to indicate that the terminal is powered and charging.

Mounting the ChargeBase

The Dolphin ChargeBase should be mounted to a dry, stable surface. When choosing a location, always bear in mind that

- The mounting location must allow users easy access to the power connector.
- The ChargeBase should be oriented so that users can easily read the labels.

Bottom Panel

The bottom panel of the Dolphin 9500 Series ChargeBase offers two mounting options: insert a DIN Rail for desk mounting or use mounting brackets with the available screw slots for wall mounting.

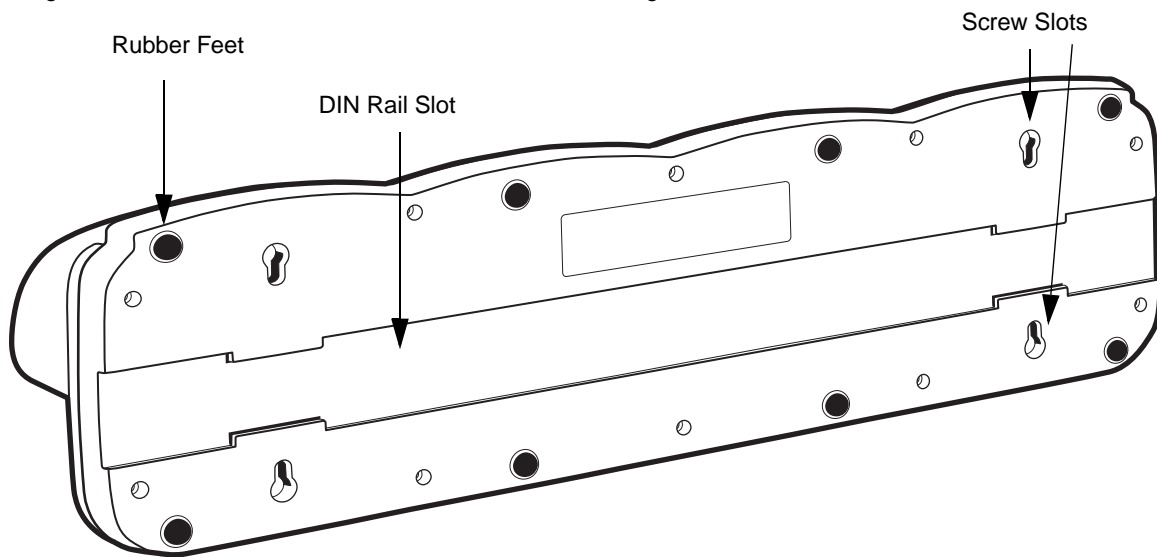

Using the DIN Rail

All Dolphin charging/communication cradles have a DIN rail (7.5 X 35 mm) slot on the bottom panel to enable secure mounting.

1. Slide the DIN Rail into the DIN Rail slot on the bottom panel.

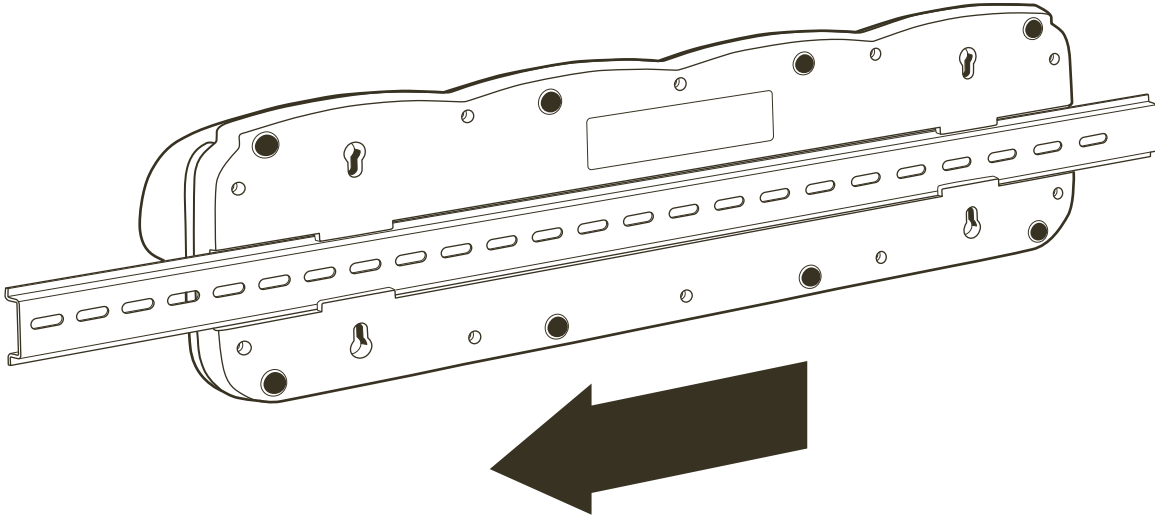

2. Turn the ChargeBase and DIN Rail right side up.
3. Secure the DIN Rail to a stable, flat horizontal surface.

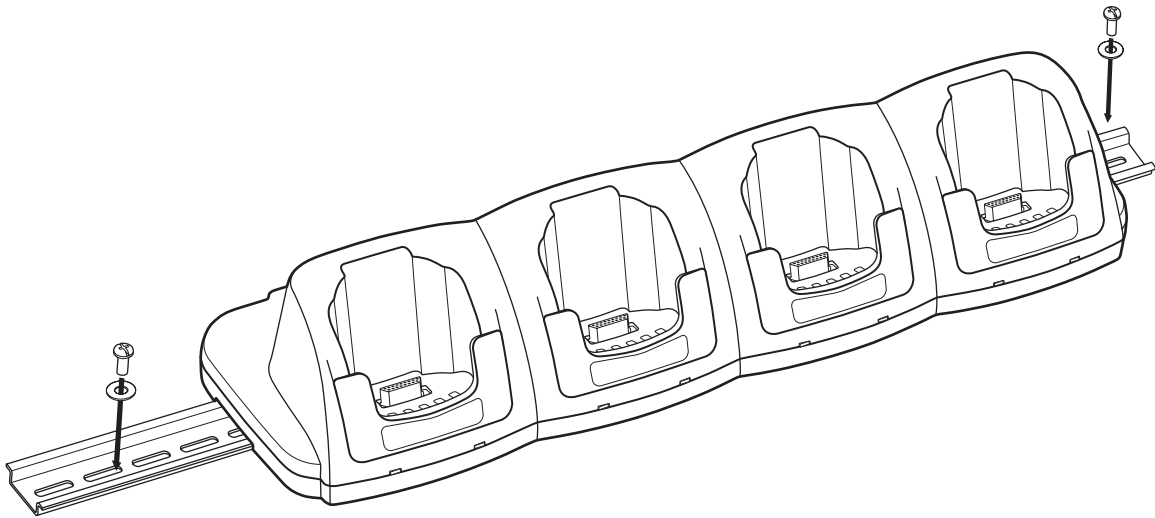

Using the Wall Mount Kit

Wall mount kits can be purchased separately to secure the ChargeBase to a wall or other vertical surface. For the ChargeBase, you need to purchase two kits so that you have two mounting brackets, one for each end of the ChargeBase. Each mounting bracket contains an open slot in the back to accommodate the connector cables.

Each mounting bracket contains an open slot in the back to accommodate the connector cables.

1. Insert the head of each screw into the round end of each of the four screw slots on the bottom panel. Slide each screw towards the narrow end of the screw slot.

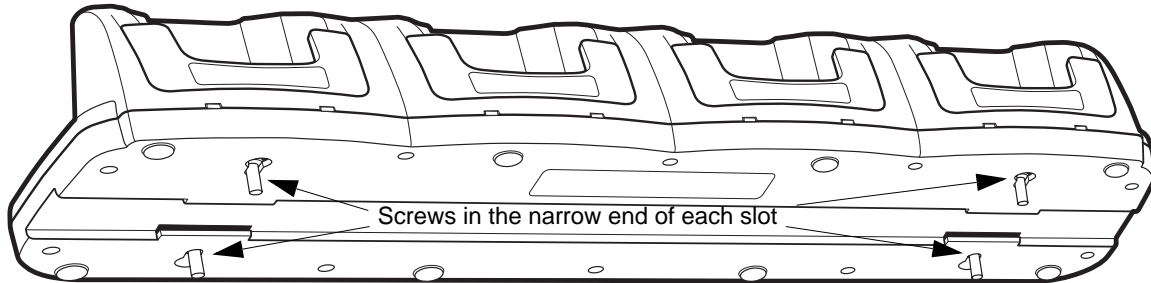

2. Use a washer/nut set on each screw to secure the screw in each slot.
3. Attach the bottom panel to the two mounting brackets.

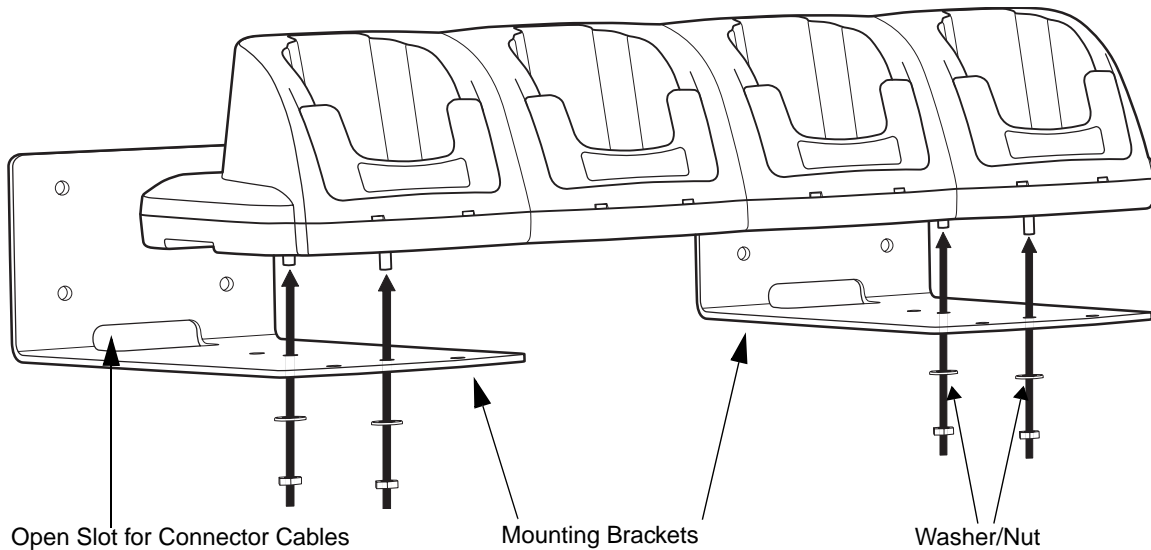

4. Using the remaining washer and nut sets, secure the mounting brackets to the bottom panel.

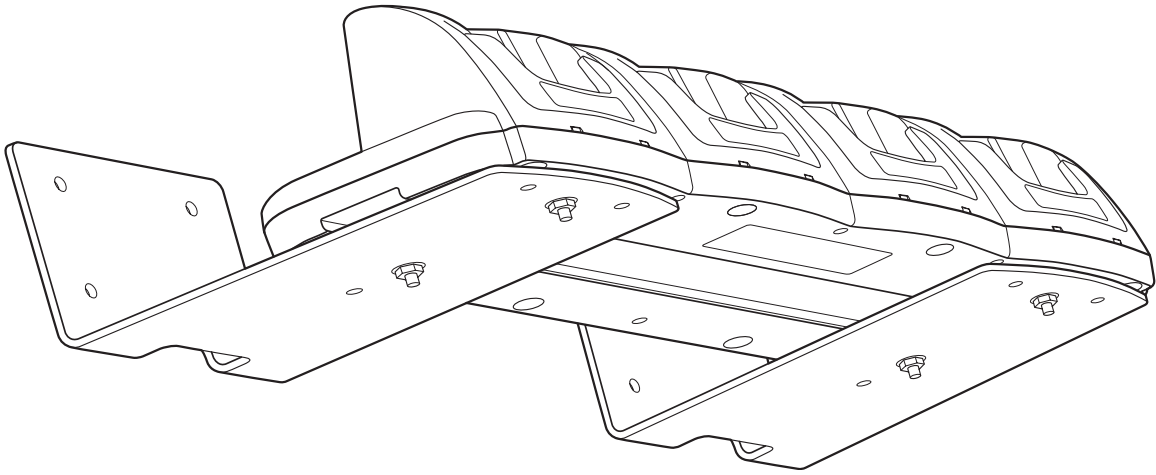

5. Secure the mounting brackets to an appropriate vertical surface.

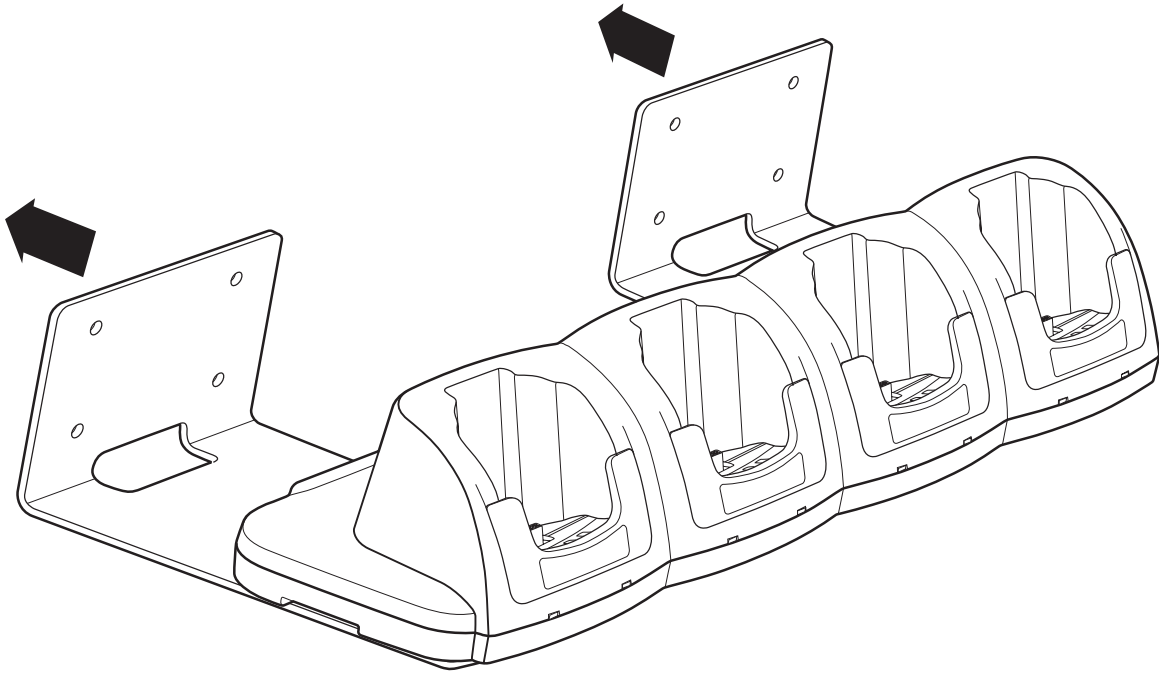



Overview

The Dolphin QuadCharger is a four-slot charging station that provides intelligent battery management for the Li-ion battery packs used in Dolphin 9500 Series terminals. Batteries charge in less than four hours. The fourth slot features a battery analyzer that completely resets a battery, then displays its remaining capacity.

Compatibility

The QuadCharger is compatible with the Li-ion batteries that power the Dolphin 9500 Series of mobile computing devices.

Charging Process

Each charging slot works independently of the other three. As battery packs charge, the charging circuitry follows the two-step charging process (CC-CV) that is recommended for Li-Ion batteries. The process monitors changes in temperature, current, and voltage and resets the battery pack.

Capacity

The Dolphin QuadCharger holds four Li-ion batteries.



Use only Dolphin 9500 Series peripherals, power cables, and power adapters. Use of peripherals, cables, or power adapters not sold/manufactured by Hand Held Products will void the warranty and may damage the terminal.



Use only the Li-ion battery packs provided by Hand Held Products. The use of any battery pack not sold/manufactured by Hand Held Products in Dolphin 9500 Series terminals will void your warranty and may result in damage to the Dolphin terminal or battery.

Dolphin QuadCharger Parts and Functions

Top Panel

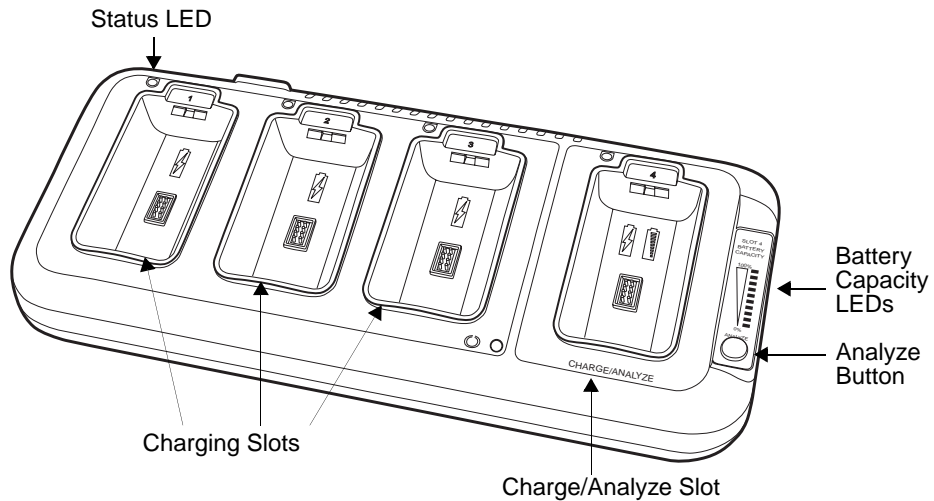

Charging Slots

The QuadCharger contains four charging slots. Each slot holds one Li-ion battery and charges it independently of the other slots. When a battery is placed in each slot, it immediately begins charging.

Charge/Analyze Slot

This is the fourth slot and the only one that can be used to analyze a battery. When a battery is placed in this slot, it begins charging just as it does in the other three slots. However, if you press the ANALYZE button, it runs the battery in this slot through the complete Analyze cycle. For more information, see [Using the Battery Analyzer](#) on page 15-5.

Battery Capacity Indicator LEDs

These LEDs give a readout of the remaining battery capacity after it has run through a complete analyze cycle. For more information, see [Battery Capacity Indicator LEDs](#) on page 15-2.

Analyze Button

Press this button to start a battery analyze cycle. For more information, see [Using the Battery Analyzer](#) on page 15-5.

Status LEDs

A status LED is located above each of the four battery slots. The color of the LED indicates the charge status of the batteries in its slot.

Status LED color	This color indicates that the battery in the slot...
Green	Has completed its charge cycle and is ready for use.
Orange	Is being charged at a maximum charge rate.
Red	Encountered an error during the most recent charge cycle.

Back Panel

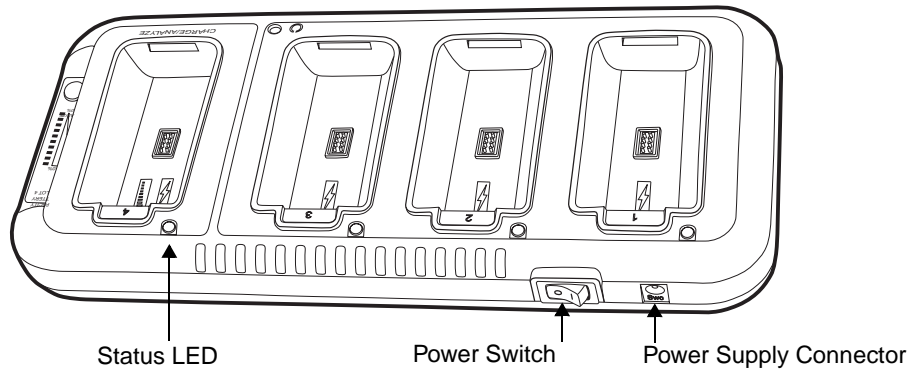

Power Switch

Toggle the power switch to turn the QuadCharger on and off.

Power Supply Connector

Use this connector to attach the power supply to the QuadCharger. The universal power supply accepts input voltages between 90-265 volts.

Supplying Power to the QuadCharger

The QuadCharger must be connected to a power source via the Hand Held Products power adapter cable so that voltage is adjusted appropriately.

1. Locate the AC power adapter cable and plug it into the power source.
2. Connect the power cable to the power adapter.
3. Connect the power cable to the supply connector on the back of the QuadCharger.

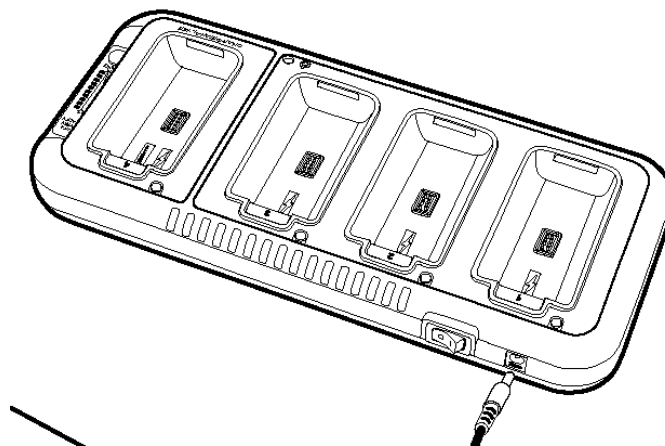

4. Press the power switch to the ON position.
The power LED illuminates green, and the charger performs a self-diagnostic test that lasts approximately five seconds.

Inserting and Removing Battery Packs

To insert a battery pack, place the end of the battery without the locking tab into the bottom of the charging pocket and snap the battery into place with a hinging motion. The Status LED for that particular slot illuminates orange when the battery has been properly inserted.

To remove a battery pack, push the locking tab down and pull the battery out from the charging slot with a hinging motion.

Storing Batteries

Recommendations

To maintain top performance from batteries, follow these storage guidelines:

- Avoid storing batteries outside of the specified temperature range of -4 to 104° F (-20 to 40°C) or in extremely high humidity.
- For prolonged storage, do not keep batteries stored in a charger that is connected to a power source.

Charging Batteries in the QuadCharger

For best results, battery packs should be at room temperature before recharging them; temperature has a marked effect on charging. The recommended temperature range is 50° to 95° F (10° to 35° C).

1. Set up the QuadCharger.
2. Supply the QuadCharger with power and turn the power switch on.
3. Insert batteries into the appropriate slots.
The Status LED for each slot turns orange to indicate that the battery has begun a charge cycle.
4. When the Status LED turns green, the battery in the slot has completed charging.

Using the Battery Analyzer

Location

The battery analyzer is located in the fourth slot - named the Charge/Analyze slot - of the ChargeBase. Only a battery placed in this slot can be run through an Analyze cycle. This slot contains Battery Capacity LEDs along the right side.

Purpose

Using the Charge/Analyze slot helps you monitor the charge capacity of Li-ion batteries over time.



Analyze Cycle

The Analyze cycle is initiated when a battery is placed in the Charge/Analyze slot and the ANALYZE button is pressed. In an Analyze cycle, batteries are completely discharged, then recharged to capacity. The length of time it takes for a battery to complete the Analyze cycle varies depending on the initial state of the battery's charge. Minimum time is 8 hours, maximum time is 12 hours.

Battery Capacity LEDs

The Battery Capacity LEDs are located along the right side of the Charge/Analyze slot. Each LED equates to 10% battery capacity. These LEDs display the capacity of the battery at the end of the Analyze cycle. Battery capacity is displayed as a percentage of measured capacity/rated capacity.

Status LED

The Charge/Analyze slot also contains a standard status LED in the upper, left corner of the slot. When this slot is used for regular charging, this LED operates in the usual manner; see [Status LEDs](#) on page 15-2..

When this slot is being used to analyze a battery, the Status LED functions as follows:

Status LED color	Indicates that the battery in the slot...
Solid Green	Has completed the Analyze cycle.
Flashing Orange	Is being analyzed.
Solid Red	Encountered an error during the Analyze cycle.

To Analyze a Battery

1. Insert the battery into the Charge/Analyze slot (the fourth).
2. Press the ANALYZE button. The Status LED flashes orange to indicate that the analyzing cycle has begun.



The Dolphin QuadCharger is accumulating battery pack information during the entire Analyze cycle. Do NOT remove the battery until the cycle has been completed.

3. Upon completion of the Analyze cycle, the Status LED lights solid green, and the Battery Capacity Indicator LEDs display the battery's capacity.

You can verify a battery's capacity by installing the battery in a terminal and checking the power; see [Power](#) on page 5-10. for details.

Mounting the QuadCharger

The Dolphin QuadCharger should be on a dry, stable surface. To easily adapt the QuadCharger to your environment, it can be mounted on a flat, horizontal surface such as a desktop or workbench, or a flat, vertical surface such as a wall.

When choosing a location, always bear in mind that

- the mounting location must allow users easy access to power switch and power connector.
- the QuadCharger should be oriented so that users can easily insert and remove battery packs and read the labels, especially for the Battery Analyzer.

Desk Mounting

All Dolphin charging/communication cradles have a DIN rail (7.5 X 35 mm) slot on the bottom panel to enable secure mounting.

To mount the QuadCharger, you slide the DIN rail slot along the bottom panel and secure it. Then, using the appropriate nuts and bolts, secure the DIN rail to the desk or wall.

The following graphic displays how to mount the QuadCharger to a desk:

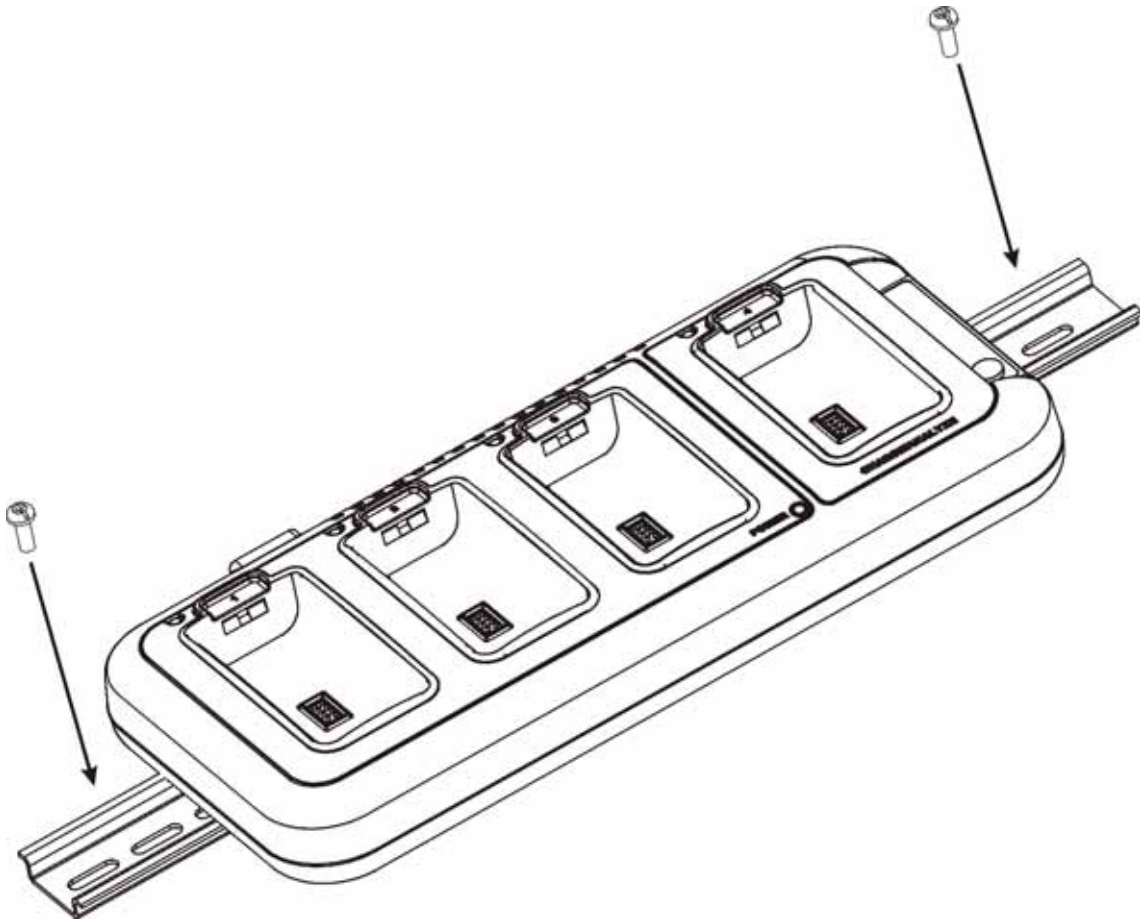

Wall Mounting

The following graphic displays how mount a QuadCharger to a wall:

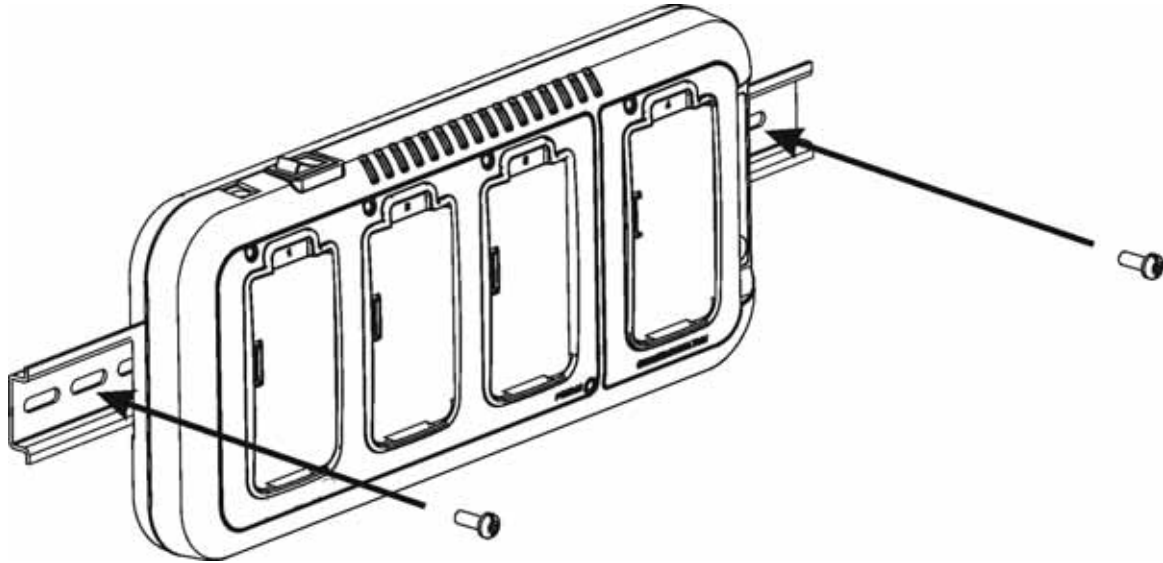

Troubleshooting

If you encounter problems with your Dolphin QuadCharger, refer to chart below for possible solutions. If problems persist, please contact Hand Held Products Technical Support.

Problem	Issue
The Status LED does not come on when I insert a battery pack into the Dolphin QuadCharger	Check the power connections on the Dolphin QuadCharger; make sure the POWER switch is ON and the battery pack is properly seated.
The Status LED lights red during charging.	Try to charge the battery in one of the other charging slots. If the red Status LED comes on again, then the problem is associated with the battery pack. If the red status stays with the charging slot, the problem is associated with the charging circuitry.
The Status LED lights red and stays on without a battery in the charging slot.	An error occurred during the self-diagnostic test for that particular charging pocket. Call Hand Held Products Product Service and request an RMA. For additional warranty and return information, see Customer Support on page 16-1.

Product Service and Repair

Hand Held Products provides service for all its products through service centers throughout the world. To obtain warranty or non-warranty service, return the unit to Hand Held Products (postage paid) with a copy of the dated purchase record attached. Contact the appropriate location below to obtain a Return Material Authorization number (RMA #) before returning the product.

North America

Hand Held Products Corporate Offices
Telephone: (800) 782-4263, Option 3
Fax: (704) 566-6015
E-mail: naservice@handheld.com

America Latina

Hand Held Products America Latina
Teléfono: (239) 263-7600
Fax: (239) 263-9689
E-mail: laservice@handheld.com

Brazil

Hand Held Products Brazil
Telephone: +55 (21) 2176-0250
Fax: +55 (21) 2176-0249
E-mail: suporte@handheld.com

Europe, Middle East, and Africa

Hand Held Products Europe
Telephone: + 31 (0) 40 29 01 633
Fax: + 31 (0) 40 2901631
E-mail: euservice@handheld.com

Asia Pacific

Hand Held Products Asia/Pacific
Telephone: +852-2511-3050
Fax: +852-2511-3557
E-mail: apservice@handheld.com

Japan

Hand Held Products Japan
Telephone: +81-3-5770-6312
Fax: +81-3-5770-6313
E-mail: apservice@handheld.com

Online Product Service and Repair Assistance

You can also access product service and repair assistance online at www.handheld.com.

Technical Assistance

If you need assistance installing or troubleshooting your scanner, please call your Distributor or the nearest Hand Held Products technical support office:

North America/Canada:

Telephone: (800) 782-4263, option 4 (8 a.m. to 6 p.m. EST)
Fax number: (315) 685-4960
E-mail: natechsupport@handheld.com

Europe, Middle East, and Africa:

Telephone-
European Ofc: Int+31 (0) 40 29 01 600
U.K. Ofc: Int+44 1925 240055
E-mail: eutechsupport@handheld.com

Asia Pacific:

Telephone: Int+852-3188-3485 or 2511-3050
E-mail: aptechsupport@handheld.com

America Latina:

Teléfono: (704) 998-3998, opción 8
E-mail: latechsupport@handheld.com

Online Technical Assistance

You can also access technical assistance online at: www.handheld.com.

Limited Warranty

Hand Held Products, Inc. ("Hand Held Products") warrants its products to be free from defects in materials and workmanship and to conform to Hand Held Products's published specifications applicable to the products purchased at the time of shipment. This warranty does not cover any Hand Held Products product which is (i) improperly installed or used; (ii) damaged by accident or negligence, including failure to follow the proper maintenance, service, and cleaning schedule; or (iii) damaged as a result of (A) modification or alteration by the purchaser or other party, (B) excessive voltage or current supplied to or drawn from the interface connections, (C) static electricity or electro-static discharge, (D) operation under conditions beyond the specified operating parameters, or (E) repair or service of the product by anyone other than Hand Held Products or its authorized representatives.

This warranty shall extend from the time of shipment for the duration published by Hand Held Products for the product at the time of purchase ("Warranty Period"). Any defective product must be returned (at purchaser's expense) during the Warranty Period to Hand Held Products' factory or authorized service center for inspection. No product will be accepted by Hand Held Products without a Return Materials Authorization, which may be obtained by contacting Hand Held Products. In the event that the product is returned to Hand Held Products or its authorized service center within the Warranty Period and Hand Held Products determines to its satisfaction that the product is defective due to defects in materials or workmanship, Hand Held Products, at its sole option, will either repair or replace the product without charge, except for return shipping to Hand Held Products.

EXCEPT AS MAY BE OTHERWISE PROVIDED BY APPLICABLE LAW, THE FOREGOING WARRANTY IS IN LIEU OF ALL OTHER COVENANTS OR WARRANTIES, EITHER EXPRESSED OR IMPLIED, ORAL OR WRITTEN, INCLUDING, WITHOUT LIMITATION, ANY IMPLIED WARRANTIES OF MERCHANTABILITY OR FITNESS FOR A PARTICULAR PURPOSE.

HAND HELD PRODUCTS' RESPONSIBILITY AND PURCHASER'S EXCLUSIVE REMEDY UNDER THIS WARRANTY IS LIMITED TO THE REPAIR OR REPLACEMENT OF THE DEFECTIVE PRODUCT. IN NO EVENT SHALL HAND HELD PRODUCTS BE LIABLE FOR INDIRECT, INCIDENTAL, OR CONSEQUENTIAL DAMAGES, AND, IN NO EVENT, SHALL ANY LIABILITY OF HAND HELD PRODUCTS ARISING IN CONNECTION WITH ANY PRODUCT SOLD HEREUNDER (WHETHER SUCH LIABILITY ARISES FROM A CLAIM BASED ON CONTRACT, WARRANTY, TORT, OR OTHERWISE) EXCEED THE ACTUAL AMOUNT PAID TO HAND HELD PRODUCTS FOR THE PRODUCT. THESE LIMITATIONS ON LIABILITY SHALL REMAIN IN FULL FORCE AND EFFECT EVEN WHEN HAND HELD PRODUCTS MAY HAVE BEEN ADVISED OF THE POSSIBILITY OF SUCH INJURIES, LOSSES, OR DAMAGES. SOME STATES, PROVINCES, OR COUNTRIES DO NOT ALLOW THE EXCLUSION OR LIMITATIONS OF INCIDENTAL OR CONSEQUENTIAL DAMAGES, SO THE ABOVE LIMITATION OR EXCLUSION MAY NOT APPLY TO YOU.

All provisions of this Limited Warranty are separate and severable, which means that if any provision is held invalid and unenforceable, such determination shall not affect the validity of enforceability of the other provisions hereof.

The limited duration of the warranty for Dolphin 9500 Series is as follows:

- Dolphin 9500 and Dolphin 9550 terminals with an integrated imager are covered by a two-year limited warranty.
- Dolphin 9501 and Dolphin 9551 terminals with an integrated laser engine are covered by a one-year limited warranty.
- Touch screens are covered by a one-year limited warranty.
- The limited duration of the warranty for the Dolphin HomeBase, Mobile Base, ChargeBase, Net Base, Mobile Charger, and QuadCharger is one year.
- The limited duration of the warranty for batteries is one year. Use of any battery not sold/manufactured by Hand Held Products may damage the terminal and/or the battery and will void the warranty. Batteries returned to Hand Held Products in a reduced state may or may not be replaced under this warranty. Battery life will be greatly increased when following the battery instructions in this user's guide.
- Use of any peripheral with the Dolphin terminal not manufactured/sold by Hand Held Products will void the warranty. This includes but is not limited to: cables, power supplies, cradles, and docking stations.
- Use only power adapters approved for use by Hand Held Products. Failure to do so may result in improper operation or damage to the unit and will void the warranty.

Hand Held Products, Inc. extends these warranties only to the first end-users of the products. These warranties are non-transferable.

How to Extend Your Warranty

Hand Held Products offers a variety of service plans on our hardware products. These agreements offer continued coverage for your equipment after the initial warranty expires. For more information, contact your Hand Held Products Sales Representative, Customer Account Representative, the Product Service Marketing Manager, or your Authorized Reseller.



General Windows Keyboard Shortcuts

Use the keyboard shortcuts in the chart below to navigate the Dolphin 9500 and Dolphin 9550 terminal keyboards. These are standard keyboard shortcuts for Windows applications.

Press these keys,	To...
CTRL + C	Copy
CTRL + X	Cut
CTRL + V	Paste
CTRL + Z	Undo
DELETE	Delete
CTRL + RIGHT ARROW	Move the insertion point to the beginning of the next word.
CTRL + LEFT ARROW	Move the insertion point to the beginning of the previous word.
CTRL + DOWN ARROW	Move the insertion point to the beginning of the next paragraph.
CTRL + UP ARROW	Move the insertion point to the beginning of the previous paragraph.
SHIFT with any of the arrow keys	Select more than one item in a window or on the desktop, or select text within a document.
CTRL+ A	Select all.
ALT + ENTER	View properties for the selected item.
ALT + TAB	Switch between open items.
ALT + ESC	Cycle through items in the order they were opened.
ALT + Tap on Touch screen	Right-click
CTRL + ESC	Display the Start menu.
ALT + Underlined letter in a menu name	Display the corresponding menu.
Underlined letter in a command name on an open menu	Carry out the corresponding command.
BACKSPACE	View the folder one level up in My Computer or Windows Explorer.
ESC	Cancel the current task.

43-Key Alpha/Numeric Keyboard



Blue Key Combinations

Key Combination	Function/Special Character
Blue key + D	-
Blue key + H	_
Blue key + L	=
Blue key + P	+
Blue key + Q	;
Blue key + R	:
Blue key + S	*
Blue key + T	/
Blue key + U	@
Blue key + X	\
Blue key + Y	START

Red Key Combinations

Key Combination	Function/Special Character
Red key + ESC	Lightens Contrast*
Red key + TAB	Darkens Contrast*
Red key + SFT	Toggles on Caps Lock
Red key + Q	F1
Red key + R	F2
Red key + S	F3
Red key + T	F4
Red key + U	F5
Red key + V	F6
Red key + W	F7
Red key + X	F8
Red key + Z	Insert
Red key + SP	Backspace
Red key + BKSP	Delete

* Exit the mouse utility prior to adjusting the contrast.

Num Lock Key Combinations

The 43-key keyboard defaults to alpha mode. To switch to num lock mode, press the NUM key once. In Num Lock mode, when you press a letter key, you type the number indicated by the num lock indicators over the key.

Key/Key Combination	Function/Special Character
 Press the NUM key only once to switch to num lock mode.	
NUM + SFT + A	!
NUM + SFT + B	@
NUM + SFT + C	#
NUM + SFT + E	\$
NUM + SFT + F	%
NUM + SFT + G	^
NUM + SFT + I	&
NUM + SFT + J	*
NUM + SFT + K	(
NUM + SFT + M	>
NUM + SFT + N)
NUM + SFT + O	<

35-Key Numeric/Alpha Keyboard



Blue Key Combinations

Key Combination	Function/Special Character
Blue key + SP	+
Blue key + DEL	-
Blue key + F1	;
Blue key + F2	:
Blue key + F3	/
Blue key + F4	\
Blue key + BKSP	START
Blue key + F5	-
Blue key + F6	@

Alpha Mode Key Combinations

The 35-key keyboard defaults to numeric mode. To switch to alpha mode, press the ALPHA key once. In alpha mode, when you press a number key, you type the letter indicated by the alpha lock indicators over the key.

Key/Key Combination	Function/Special Character
 Press the ALPA key only once to switch to alpha mode.	
ALPHA + 1	When you press 1 repeatedly, the 1 key produces the following characters in the following sequence: . , ' ? ! -
ALPHA + SFT + 1	! < >
ALPHA + SFT + 2	@
ALPHA + SFT + 3	#
ALPHA + SFT + 4	\$
ALPHA + SFT + 5	%
ALPHA + SFT + 6	^
ALPHA + SFT + 7	&
ALPHA + SFT + 8	*
ALPHA + SFT + 9	(
ALPHA + SFT + 0)

Please note that when typing in alpha mode, you must use the same multi-press method you would use when typing letters on a phone keypad. Each key press will type the next letter in the sequence as displayed by the alpha lock indicators over the number keys.

56-Key Full Alpha/Numeric

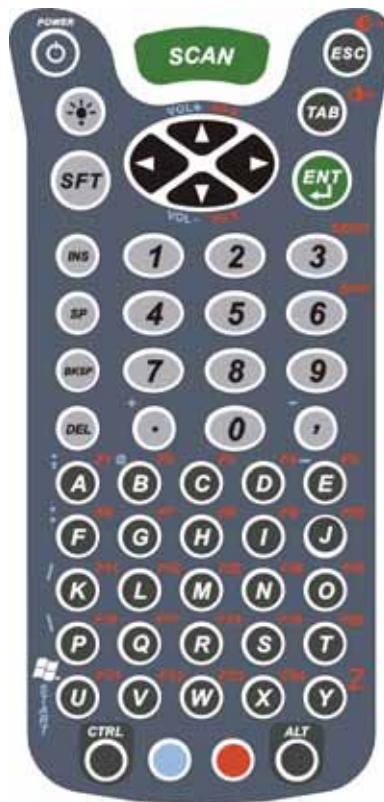

Blue Key Combinations

Key Combination	Function/Special Character
Blue key + .	+
Blue key + ,	-
Blue key + A	;
Blue key + B	@
Blue key + E	-
Blue key + F	:

Red Key Combinations

Key Combination	Function/Special Character
Red key + ESC	Lightens Contrast*
Red key + TAB	Darkens Contrast*
Red key + SFT	Toggles on Caps Lock
Red key + A	F1
Red key + B	F2
Red key + C	F3
Red key + D	F4
Red key + E	F5
Red key + F	F6
Red key + G	F7
Red key + H	F8
Red key + I	F9
Red key + J	F10
Red key + K	F11
Red key + L	F12
Red key + M	F13
Red key + N	F14
Red key + O	F15
Red key + P	F16
Red key + Q	F17
Red key + R	F18
Red key + S	F19
Red key + T	F20
Red key + U	F21
Red key + V	F22
Red key + W	F23
Red key + X	F24
Red key + Y	Z

* Exit the mouse utility prior to adjusting the contrast.

SFT Key Combinations

Key Combination	Function/Special Character
SFT + 1	!
SFT + 2	@
SFT + 3	#
SFT + 4	\$
SFT + 5	%
SFT + 6	^
SFT + 7	&
SFT + 8	*
SFT + 9	(
SFT + 0)
SFT +.	>
SFT +,	<

Com Port Assignment Table

Com Port	Assignment
Com Port 1	Serial port. This is the 17-pin connector on the bottom panel of Dolphin 9500 Series terminals.
Com Port 2	Bluetooth Module If there is no Bluetooth hardware installed on the terminal, this com port is unassigned.
Com Port 3	Raw Infrared
Com Port 4	
Com Port 5	USB virtual serial port
Com Port 6	IrDA, if IrDA is enabled. If IrDA is disabled, this com port becomes available. See Verify That the IrDA Port is Enabled on page 6-5.
Com Ports 7-9	Unassigned. These are available for selection only when connecting to devices that use virtual com ports, such as Bluetooth.



Hand Held Products, Inc.
700 Visions Drive
P.O. Box 208
Skaneateles Falls, NY 13153-0208