



DLL6000-R/OM6010-R

System Manual

DATALOGIC DL
Bar Code & More
.....

DLL6000-R/OM6010-R SYSTEM MANUAL



This manual refers to
software version 1.05
and later

Datalogic reserves the right to make modifications and improvements without prior notification.

Product names mentioned herein are for identification purposes only and may be trademarks and or registered trademarks of their respective companies.

© - 1999 Datalogic S.p.A.

(Rev. C)

CONTENTS

General View.....	vi
How To Use This Manual.....	viii
1 INTRODUCTION.....	1.1
1.1 DLL6000-R Series Laser Scanners	1.1
1.1.1 Description And Use	1.1
1.1.2 Reading Diagram	1.2
1.1.3 DLL6000-R Indicators	1.3
1.2 OM6010-R Cradle / C6010 Cradle.....	1.4
1.2.1 LA6010 Accessory	1.4
1.2.2 OM6010-R / C6010 Indicators	1.4
2 MOUNTING AND SYSTEM CONNECTIONS.....	2.1
2.1 Mounting The OM6010-R / C6010 Cradle	2.1
2.1.1 Portable Desktop Use	2.2
2.1.2 Fixed Desktop Use.....	2.3
2.1.3 Wall Mounting	2.4
2.1.4 Alignment Plate Installation.....	2.5
2.2 Basic System Layouts.....	2.6
2.2.1 Stand Alone Layouts	2.6
2.2.2 Multidrop Layouts.....	2.11
2.3 DLL6000-R Battery Maintenance.....	2.15
2.3.1 Battery Type.....	2.15
2.3.2 Battery Charging	2.16
2.3.3 Replacing DLL6000-R Batteries.....	2.16
3 SYSTEM CONFIGURATION	3.1
3.1 System Start-Up.....	3.2
3.1.1 Using Multiple Guns With Same Cradle.....	3.5
3.1.2 Gun Default Configuration.....	3.6
3.1.3 Cradle Default Settings	3.7
3.2 Changing System Configuration	3.8
RS232	3.10
WEDGE.....	3.14
PEN EMULATION.....	3.18

CRADLE OPERATING PARAMETERS	3.22
BATTERY CHARGING	3.25
NETWORK PARAMETERS.....	3.27
GUN OPERATING PARAMETERS	3.30
READING PARAMETERS.....	3.33
DECODING PARAMETERS.....	3.37
GUN DISPLAY PARAMETERS.....	3.39
CODE SELECTION	3.42

4	REFERENCES	4.1
4.1	RS232 Parameters	4.1
4.1.1	Handshaking.....	4.1
4.1.2	Radio RX Lock.....	4.1
4.1.3	RX Timeout.....	4.2
4.2	Wedge Parameters	4.2
4.2.1	IBM AT - Alt Mode Interface	4.2
4.2.2	Inter-character Delay	4.2
4.3	Pen Emulation Parameters.....	4.3
4.3.1	Minimum Output Pulse	4.3
4.3.2	Overflow.....	4.3
4.3.3	Output And Idle Levels	4.4
4.4	Cradle And Gun Operating Parameters	4.4
4.4.1	Output Data Format	4.4
4.4.2	Radio Timeout	4.7
4.5	Reading Parameters.....	4.8
4.5.1	Trigger Signal	4.8
4.5.2	Trigger Timeout	4.8
4.5.3	Reads Per Cycle.....	4.8
4.5.4	Safety Time.....	4.9
4.5.5	Single-Store	4.9
4.5.6	Power-Off Timeout	4.10
4.6	Decoding Parameters	4.10
4.6.1	Ink-Spread	4.10
4.6.2	Overflow Control	4.10
4.6.3	Interdigit Control	4.11
4.7	Gun Display Parameters.....	4.11
4.7.1	Display Mode	4.11
4.8	Software Release	4.12

5	COMMUNICATION AND MESSAGE FORMATTING	5.1
5.1	Messages From Host To Gun	5.1
5.1.1	Cursor Control.....	5.2
5.1.2	Font Selection	5.3
5.1.3	Clearing Display	5.3
5.1.4	LED And Beeper Control.....	5.4
5.1.5	Setting RTC.....	5.4
5.2	Messages From Gun Keys.....	5.5
6	TECHNICAL FEATURES	6.1
6.1	DLL6000-R Technical Features	6.1
6.2	OM6010-R Technical Features	6.2
6.3	System Features	6.3
	APPENDIX A HOST CONFIGURATION STRINGS.....	A.1
	APPENDIX B C6010 CONFIGURATION	B.1
	APPENDIX C HEX AND NUMERIC TABLES.....	C.1

GENERAL VIEW

DLL6000-R GUNS



Figure A – DLL6000-R series guns without display

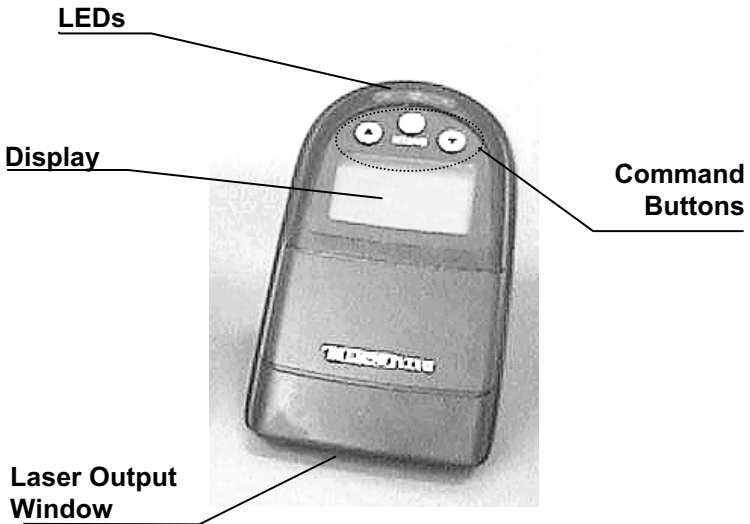

Figure B – DLL6000-R series guns with display

OM6010-R / C6010 CRADLES

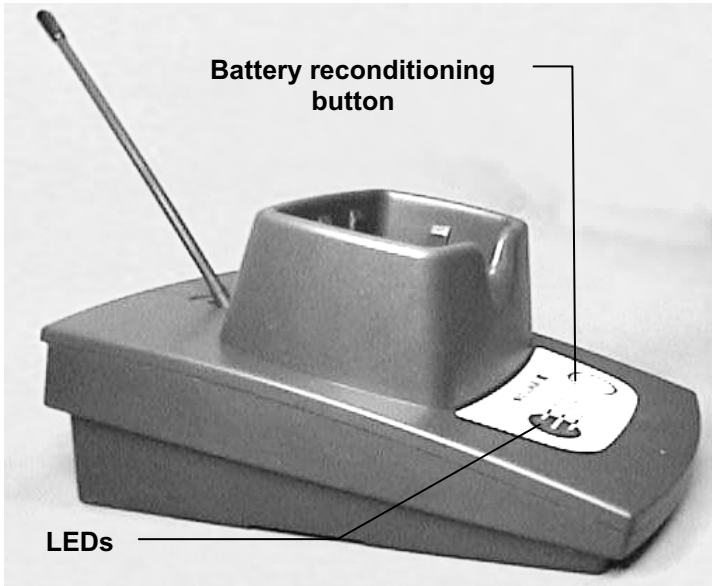

Figure C – OM6010-R

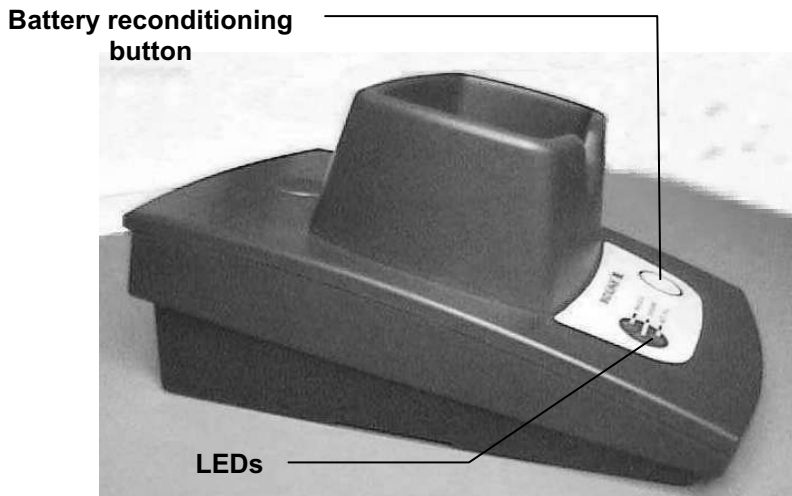

Figure D – C6010

HOW TO USE THIS MANUAL

CONNECTIONS

- To make system connections see **CHAPTER 2**.

CONFIGURATION

- To configure the system see **CHAPTER 3**.
- To change the default settings:
 - 1) Open the folded page in Appendix C with the hex-numeric table and keep it open during the device configuration
 - 2) Go to the section of the desired group to modify
 - 3) Follow the procedure for that section modifying the desired parameters.

DESCRIPTIONS

- For device information read **CHAPTER 1**.
- For information on barcode reading parameters and reference tables see **CHAPTER 4**.
- For communication between Host and gun, refer to **CHAPTER 5**.

1 INTRODUCTION

The Cordless Reading System is composed of one or more DLL6000-R series laser scanners and one or more OM6010-R cradles, which communicate through a low-power radio.

Optional elements are the C6010 battery charger and the LA6010 interface module.

Thanks to its robustness, durability and reliability, the Cordless Reading System is the ideal solution in all **industrial** applications where large quantities of information need to be collected rapidly, easily and reliably in relatively harsh or dirty environments.

1.1 DLL6000-R SERIES LASER SCANNERS

DLL6000-R LASER SCANNERS are hand-held barcode readers with built-in decoder and radio.

The scanning system of the reader uses visible laser diode (VLD) technology and the high quality of internal parts guarantees constant reliability and superior performance.

1.1.1 Description And Use

DLL6000-R laser scanners automatically scan barcodes at a distance; simply aim and pull the trigger. Code scanning is performed along the scan line which must pass through the entire code.



Figure 1.1 - Code reading example

Successful scanning is obtained by tilting the scanner with respect to the barcode to avoid direct reflections which impair the reading performance, see Figure 1.2.



OK



Not Advised

Figure 1.2 - Code reading position

Adapt the reading distance to the code features and operating needs.

NOTE

During configuration keep the scanner close enough to the codes to assure the selection of the correct code.

1.1.2 Reading Diagram

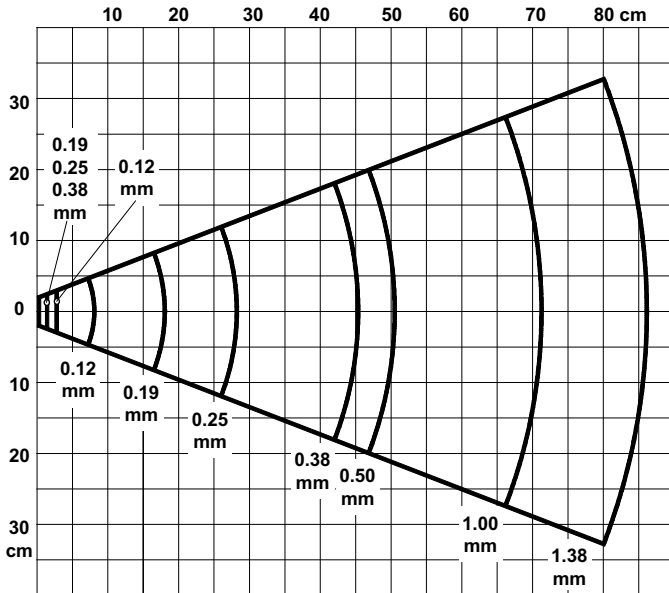

1.1.3 DLL6000-R Indicators

DLL6000-R series readers have two LEDs and a beeper. They signal several operating conditions which are described in the tables below.

POWER UP

Beeper	Meaning
L L L L	Parameters loaded correctly
H H H H Long tones	Parameter loading error, reading or writing error in the non-volatile memory
H L H L	Hardware error in EEPROM

CONFIGURATION

Beeper	Meaning
H H H H	Correct entry or exit from configuration mode
L°	Good read of a command
L L L°	Command read error

DATA ENTRY

Red LED	Green LED	Beeper	Meaning
ON			Laser active
Flashing		HHHH....	Low battery
	Pulse	L°	Good read
	Pulse	L°*	Good transmission
		H L Long tones	TX failure

BIND AND JOIN COMMANDS

Green LED	Beeper	Meaning
ON		Command accepted; Gun ready to be inserted in the cradle
	L°	Success
	H L Long tones	Failure

° tone and intensity are user-configurable

* the good transmission beeper can be disabled.

H = high tone

L = low tone

1.2 OM6010-R CRADLE / C6010 CRADLE

The OM6010-R is a cradle with radio which allows wireless communication between one or more DLL6000-R series scanners and a Host computer.

The OM6010-R also provides battery recharging for the scanners.

The C6010 is the charger-only version of the cradle. When several scanners use the same OM6010-R, the battery recharging operation can be speeded up by employing one C6010 for each scanner which does not have a dedicated OM6010-R.

1.2.1 LA6010 Accessory

The LA6010 LAN interface module can be mounted to the OM6010-R to connect several cradles in a multidrop network. Refer to Chapter 2 for LA6010 mounting.

1.2.2 OM6010-R / C6010 Indicators

Both the OM6010-R and the C6010 are equipped with three LEDs which signal the operating conditions described in the tables below.

CHARGE STATUS

Red LED	Green LED	Meaning
ON	OFF	Charging
OFF	ON	End of charge
OFF	OFF	No battery inserted
Flashing	OFF	Discharging (see "Battery Maintenance" section)
Flashing	Flashing	Shorted or open battery

POWER / COMMUNICATION

Yellow LED	Meaning
ON	Power applied, no communication
OFF	Error in reading EEPROM parameters
OFF pulse	Transmission over the Host port*

* N.A. on C6010

2 MOUNTING AND SYSTEM CONNECTIONS

The installation of the Cordless Reading System requires mounting each cradle, connecting the interface cable to the Host, and connecting the power supply to the cradle.

2.1 MOUNTING THE OM6010-R / C6010 CRADLE

The cradle package contains the following devices:

OM6010-R / C6010 Cradle with Base

OM6010-R Quick Reference / C6010 Quick Reference

OM6010-R Antenna 2 adhesive strips

3 mounting screws 4 rubber feet

3 threaded dowels 1 alignment plate

The cradle (either OM6010-R or C6010) can be mounted for portable or fixed desktop usage, or it can be fixed to a wall:



Desktop Use



Wall-mount Use

2.1.1 Portable Desktop Use

For desktop use, the OM6010-R is already correctly positioned on the base.



1. Carefully clean the rubber feet seat of the base to remove any impurities that could reduce adhesion.
2. Remove the protective plastic from the rubber feet and stick them onto the bottom surface of the base.

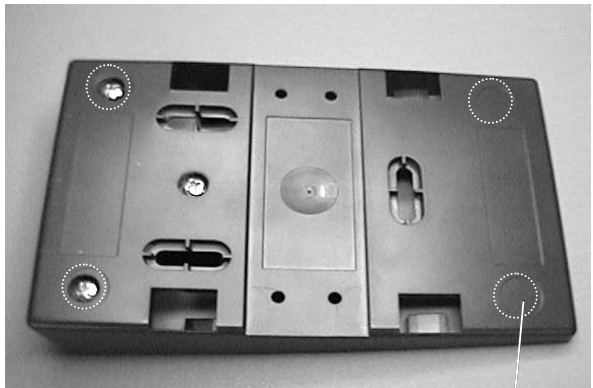

Rubber foot seat (4)

Figure 2.1 – Rubber foot placement

3. Insert the antenna in the appropriate hole on the body of the cradle and screw it clockwise until tight.

2.1.2 Fixed Desktop Use

For fixed desktop installation, use the adhesive strips.

1. If you are installing several cradles and you desire to align them, you can use the alignment plate (see Alignment Plate Installation), otherwise continue with step 2.
2. Carefully clean the adhesive strip seat of the base to remove any impurities that could reduce adhesion.

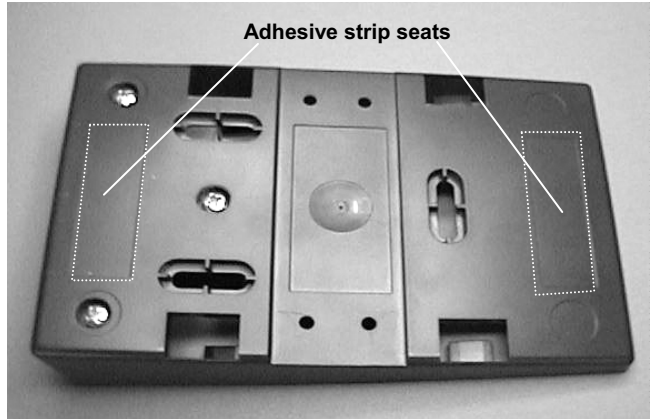

Figure 2.2 – Adhesive strip placement

3. Remove the protective plastic from one side of the adhesive strips and stick them onto the base surface.
4. Remove the plastic from the other side of the strips and affix the base to the table.



5. Insert the antenna in the appropriate hole on the body of the cradle and screw it clockwise until tight.

2.1.3 Wall Mounting

For wall mounting, the base is positioned as shown in Figure 2.4.

1. Unscrew the cradle fixing screw and detach the cradle from the base by holding the base tight and pushing the cradle backwards.
2. If you are installing several cradles and you desire to align them, you can use the alignment plate (see Alignment Plate Installation), otherwise continue with step 3.
3. Using the mounting holes on the base as a pattern, mark the wall where you desire to mount the OM6010-R.
4. Drill three appropriate size holes.
5. Insert the threaded dowels into the holes.
6. Position the base on the wall and affix it by means of the three screws.
7. Reattach the cradle body by sliding it along the mounting tabs until aligned.
8. Fix the cradle to the base by means of the fixing screw (see Figure 2.3).
9. Insert the antenna in the appropriate hole on the body of the cradle and screw it clockwise until tight.



Figure 2.3 - OM6010-R / C6010 top view

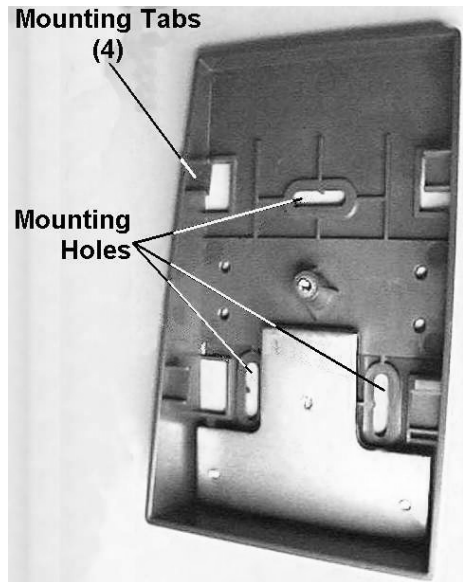

Figure 2.4 - OM6010-R wall mounting

2.1.4 Alignment Plate Installation

1. Snap the Alignment Plate into the holes provided on the base so that the plate remains extended from the side of the base.

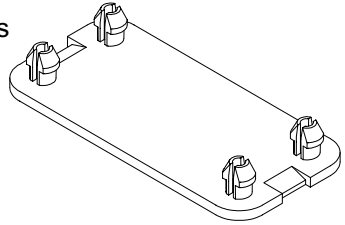

Figure 2.5 – Alignment Plate

2. Snap the next base onto the remaining pins of the Alignment Plate.

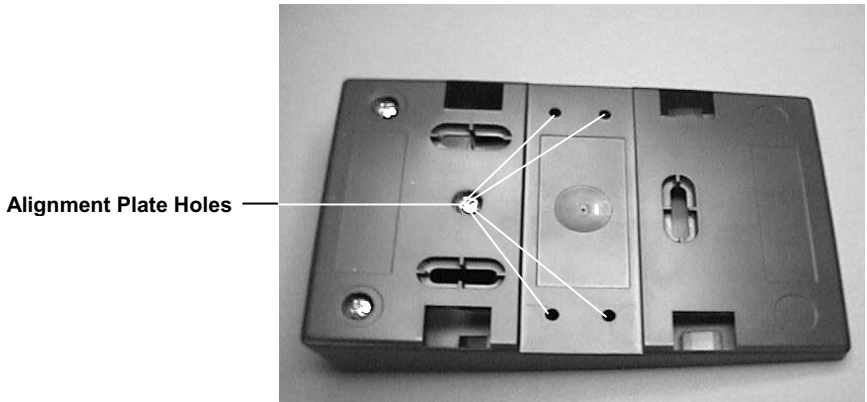

Figure 2.6 – Alignment Plate Holes

2.2 BASIC SYSTEM LAYOUTS

There are two basic system layouts that can be employed: stand alone systems and multidrop systems.

2.2.1 Stand Alone Layouts

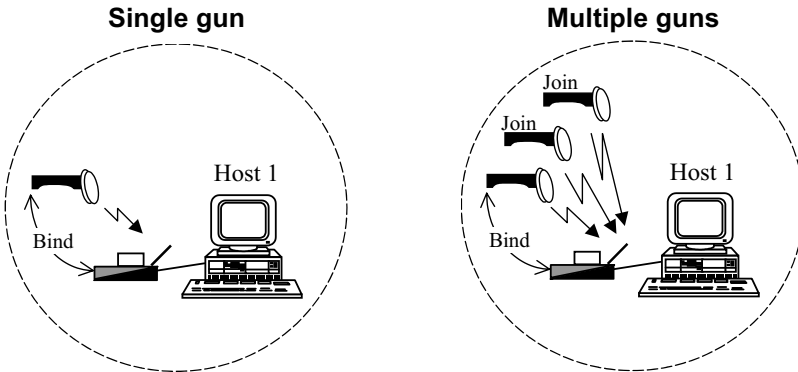

Figure 2.7 - Stand Alone Connections

In stand alone systems, each cradle is connected to a single Host. Many stand alone connections can operate in the same physical area without interference, provided all guns in the system have different addresses.

Since the cradles can communicate to multiple DLL6000-R scanners, you might find it useful to employ one or more C6010 battery chargers in addition to the OM6010-R cradle, so that the battery re-charging operation can be performed for several scanners at the same time.

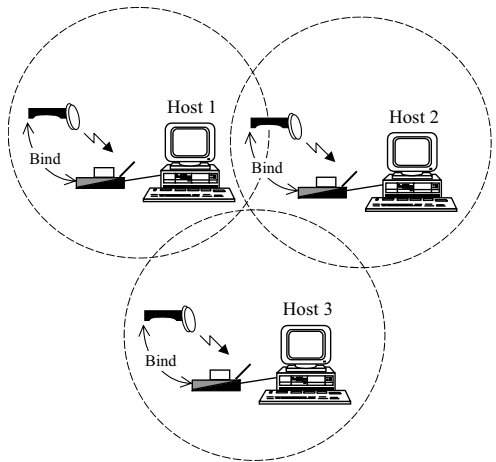

Figure 2.8 - Multiple Stand Alone Systems in the Same Area

CAUTION

Connections should always be made with power OFF!

Connecting / Disconnecting The OM6010-R Interface Cable

The OM6010-R incorporates a multistandard interface which can be connected to a Host by simply plugging an RS232, Wedge or Pen emulation cable into the Host connector, visible on the rear panel of the cradle.

To disconnect the cable, insert a paper clip or other similar object into the hole corresponding to the Host connector on the body of the cradle. Push down on the clip while unplugging the cable.



**OM6010-R interface
cable to Host**

Figure 2.9 – Disconnecting the cable.

RS232 CONNECTION

Power Supply

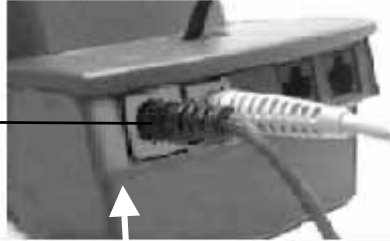

WEDGE CONNECTION

Power Supply

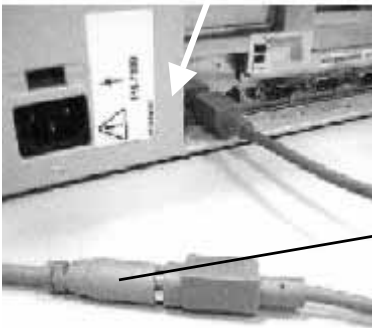
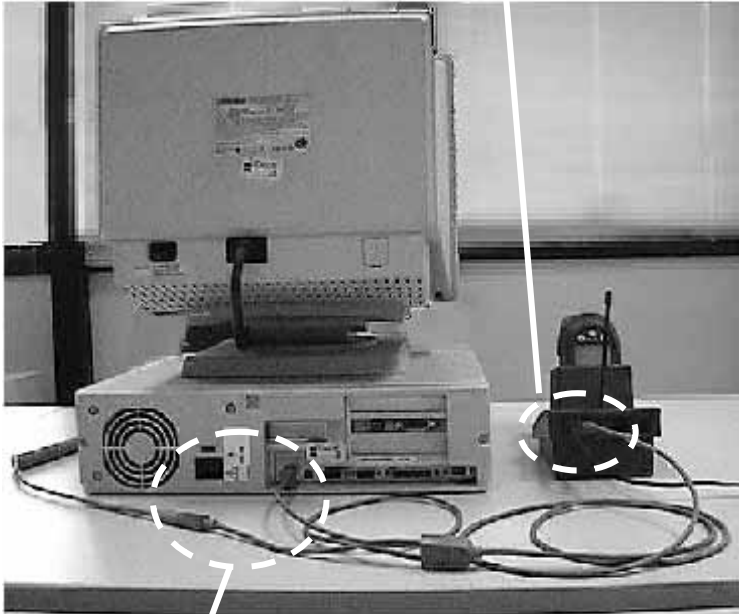
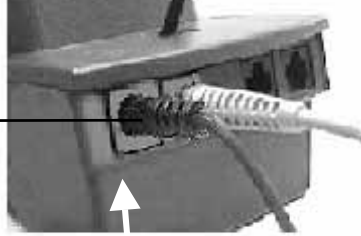

**Keyboard
cable**

PEN EMULATION CONNECTION

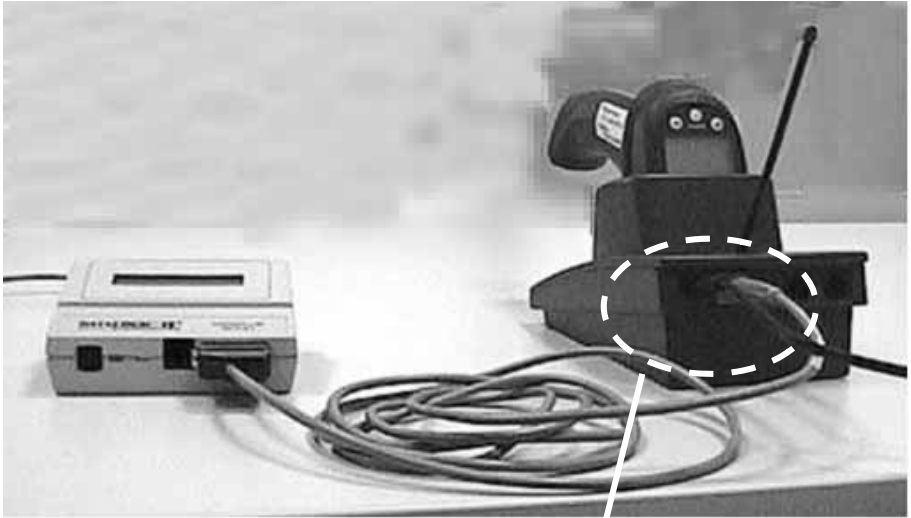

Power Supply

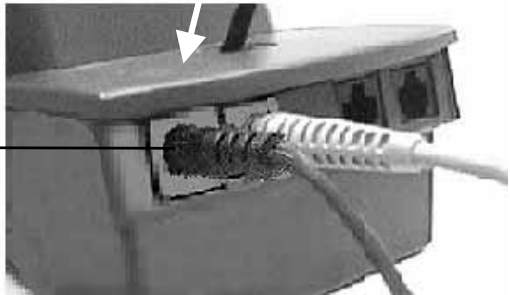

2.2.2 Multidrop Layouts

Even though many stand alone systems can operate in the same physical area without interfering with each other, it may be desirable to bridge data from multiple cradles in a network to a single Host. Each OM6010-R cradle is designed to connect with other cradles in order to build a Multidrop cradle network. The Multidrop system requires the installation of the LA6010 Multidrop module in each cradle.

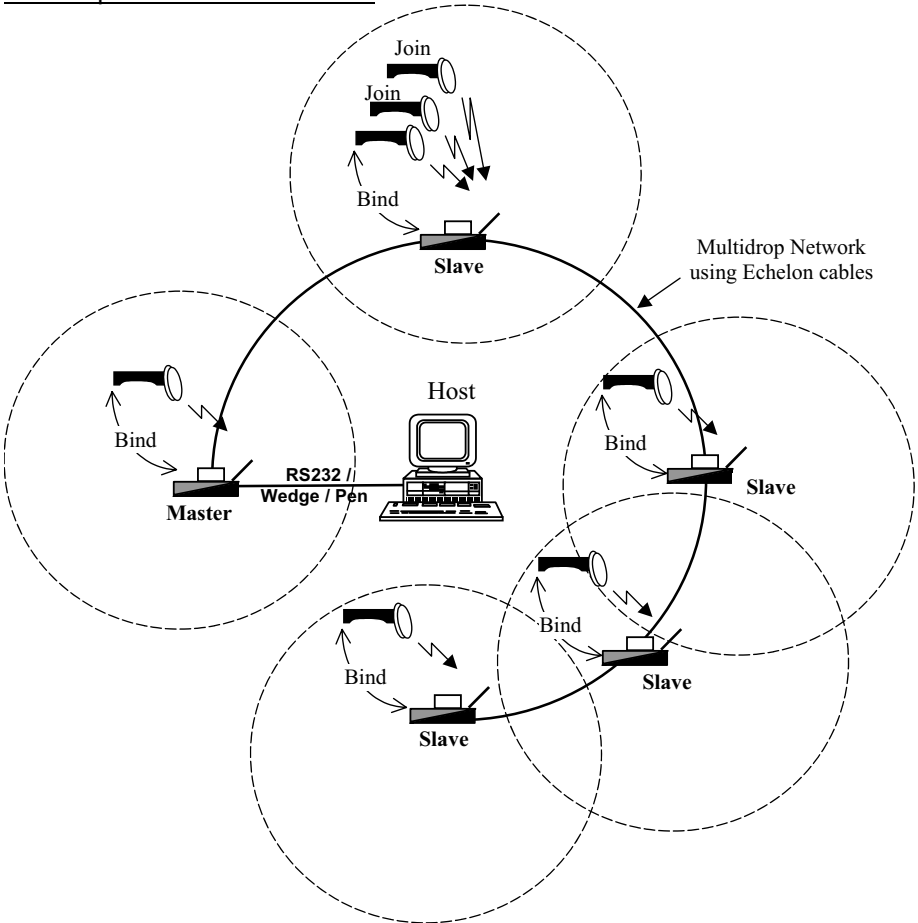

Figure 2.10 - Multidrop system

The multidrop system allows several cradles to be chained together in a Master/Slave Multidrop network configuration. The Master is connected to the

Host through the multistandard interface by connecting an RS232, Wedge or Pen emulation cable into the Host connector (as in the stand alone system).

The Master cradle bridges data from the Slave cradles to the Host. In this way the Master cradle provides communications between a single Host and all guns in the system (those **Joined** or **Bound** to the Master and to the Slaves).

See par. 6.3 for system configuration specifications.

Roaming

Furthermore, to increase the flexibility of the system, guns can be easily joined to different cradles in the system without having to go through the Join procedure. This facilitates "roaming", in which any given gun may be used in areas covered by other cradles.

To do this, scan a Code 128 Subset B barcode with the following contents: **\$+HQxxx\$-**, where xxx is the 3-digit address of the cradle (previously set through the *bind* procedure) which the gun must be joined to.

Mounting LA6010 Multidrop Module

When building a Multidrop network among several OM6010-Rs, you must install one LA6010 interface module inside each cradle.

1. Remove the OM6010-R from its mounting base: unscrew the cradle fixing screw and detach the cradle from the base by holding the base tight and pushing the cradle backwards.



Figure 2.11 - OM6010-R top view

2. Turn the OM6010-R upside-down and open it by unscrewing the four fixing screws:

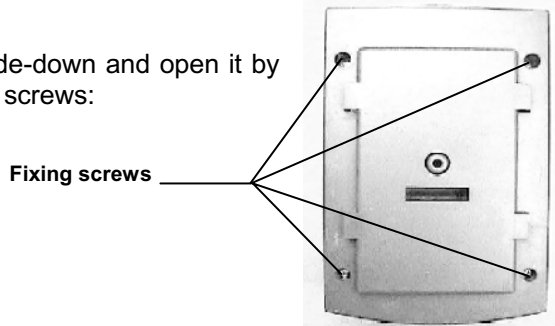

Figure 2.12 – OM6010-R – bottom surface

3. Insert the LA6010 into the connector provided on the PCB, orienting it exactly as shown in the figure on the right:

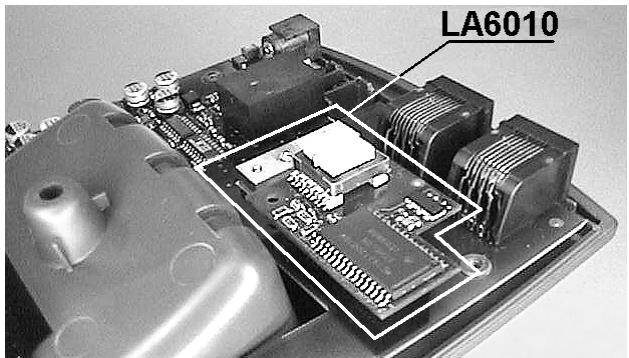

Figure 2.13 – OM6010-R – inside

4. Close the OM6010-R and tighten the fixing screws.
5. Reattach the cradle body to the mounting base by sliding it along the mounting tabs until aligned.
6. Fix the cradle to the base by means of the fixing screw (see Figure 2.11).

In case you are installing the LA6010 in a cradle which has already been configured, you must re-send the address to the cradle. To do this you can choose either of the following methods:

- a) Send the string **\$+HFxxx\$-** to the cradle over the serial interface, where xxx = previous cradle address.
- b) Use the gun **bound** to the cradle to repeat the **bind** procedure as described in step 7 of the configuration procedure on page 3.3.

Network Connections

The multidrop network is a bus system which is propagated from one cradle to another using stand alone cables. This is possible thanks to the two echelon connectors on the rear panel of the cradle.

The two echelon connectors are identical in every respect so that the point-to-point cables can be chained together without limitations concerning the bus wiring. Obviously cable length is to be kept to a minimum as with all bus systems.

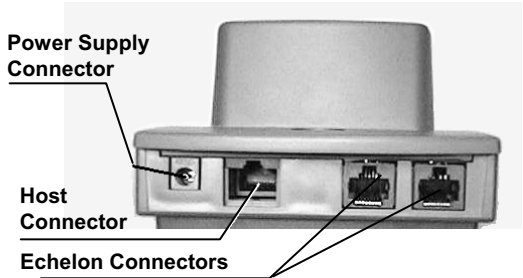

Figure 2.14 - OM6010R rear panel

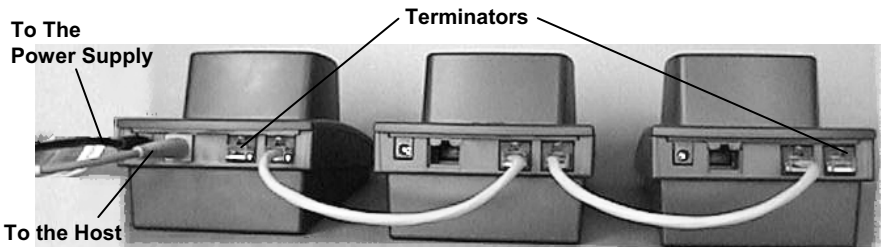

Figure 2.15 – Multidrop network connections with terminators

The Multidrop line is made using any category 5 UTP cable and RJ45 connectors. The maximum network cable length is **1300 meters** from terminator to terminator.

Pin	Function
1	Power Supply +
2	Power Supply +
3	Power Supply -
4	Power Supply -
5	Terminator
6	Terminator
7	Data (non-polarized)
8	Data (non-polarized)

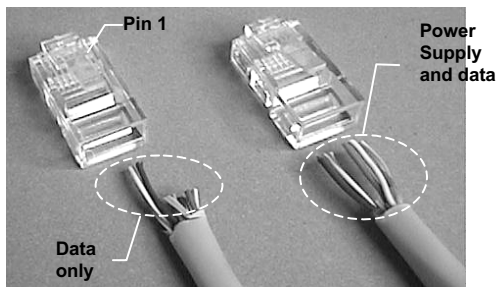

Figure 2.16 – Multidrop Cables

When wiring the multidrop cables, note the following:

Pins 5 and 6 should not be connected (for network termination only) and pins 1 to 4 should be connected only if the power has to be propagated from one cradle to the other via the cable.

Pins 1 to 4 can provide power for all cradles connected through the Multidrop line. The total number of devices which can be connected to a single power supply depends on the power supply voltage, the wire length and resistance and therefore the voltage drop.

Typically, higher power supply voltages allow longer cable connections. Since the cradle draws the same power, (8W) regardless of the supply voltage, with higher voltages the current flowing in the supply cable and the voltage drop are much less.

You must take into account the maximum allowable current on the connectors (4 amps). At the maximum cradle input voltage (28V), the maximum power becomes $4A * 28V = 112W$, and at 12V, 48W. Therefore you can propagate the power to 14 cascaded OM6010-Rs at 28V and to 6 OM6010-Rs at 12V (provided the cable voltage drop is very low). If you have more cradles than this you can power them in groups and connect the groups via cables with unconnected power.

Network Termination

The first and last cradles of the chain (the two ends of the bus) must be properly terminated. The cradle has an internal terminator that can be connected to the bus by shorting pins 5 and 6 of any one of the two network connectors. The easiest way of terminating the network is to insert a connector with pins 5 and 6 connected by a short wire.

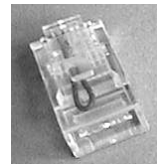

Figure 2.17 – Terminator for Multidrop Network

2.3 DLL6000-R BATTERY MAINTENANCE

2.3.1 Battery Type

According to the DLL6000-R model, you can install the following battery types:

2 NiMh, NiCd or Alkaline AA batteries

1 Li-ION battery

2.3.2 Battery Charging

Once the system is connected and powered, you can place the DLL6000-R into the cradle to charge the battery.

When the scanner is correctly inserted in the cradle, the red LED on the cradle goes on to indicate that the battery is charging. The green LED on the cradle goes on when the battery is completely charged.

When using NiCd or NiMh batteries, frequent recharging before fully discharging can cause a “memory effect” in which the batteries assume a reduced capacity.

Since it is not practical to wait for the gun to be fully discharged before recharging it, the OM6010-R and the C6010 are provided with a battery-reconditioning feature which overcomes the “memory effect” problem.

To perform battery reconditioning, simply press the battery-reconditioning key on the cradle control panel: the battery will be fully discharged in a short period of time (red LED flashing), then automatically recharged.

We recommend performing the battery reconditioning once every few months or whenever you feel the battery capacity has decreased.

NOTE

Reconditioning cycles only have effect for NiCd and NiMh batteries. Li-Ion batteries do not have a “memory effect” problem and the reconditioning cycle has no effect on them.

2.3.3 Replacing DLL6000-R Batteries

To change the batteries in your DLL6000-R scanner, proceed as follows:

1. Unscrew the battery cover screw.

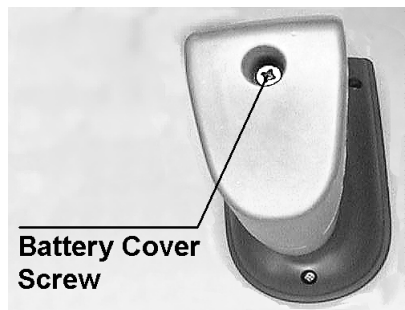

- Open the battery cover.

NOTE

When the batteries are extracted from the scanner, the timer maintains the current hour and date for about 1 minute.

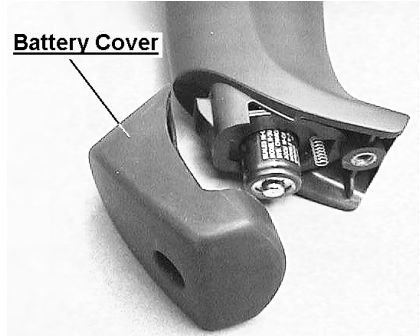

- Replace the old batteries with new ones, then screw the battery cover back into place.

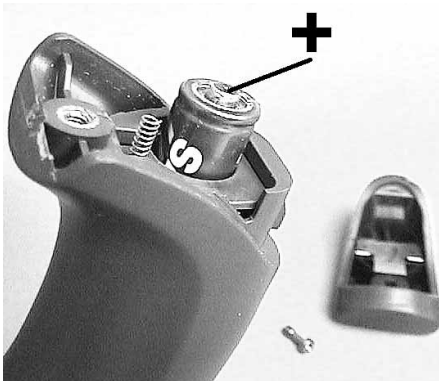

NiMh, NiCd, or Alkaline AA batteries



Li-Ion battery

CAUTION

Dispose of used batteries properly.

When employing Lithium batteries, do not disassemble, modify, heat or throw them into fire. This could cause leakage of liquid, generation of heat or, in extreme cases, explosion.

Replace only with the same type recommended.

3 SYSTEM CONFIGURATION

To start the system up, perform the operations represented in the flow-chart below, following the given sequence.

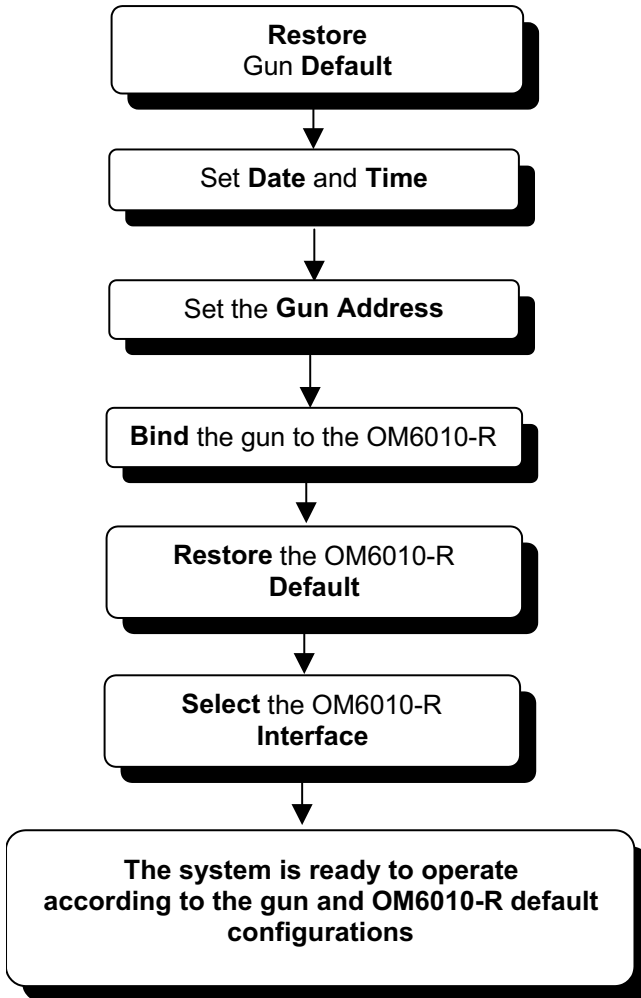

3.1 SYSTEM START-UP

When the OM6010-R is connected and powered, configure the DLL6000-R by reading the following codes in the given sequence and follow the instructions.

Note: Open the folded page at the end of this Manual for the Numeric code selections.

1. **Restore DLL6000-R default**



Default parameter settings are listed in par. 3.1.2.

2. **Enter configuration**



3. **Set Date**



+
six digits for Day, Month and Year (DDMMYY).

4. **Set Time**



+
four digits for Hours and Minutes (HHMM).

5. **Set Gun Address**



+
three digits for the DLL6000-R Address (from 000 to 126).

All guns used in the same area must have different addresses.

Exit and Save configuration

6.



7. Read the **Bind** code to pair the DLL6000-R to the OM6010-R:
The reader is dedicated to the cradle. Any previously **bound** reader will be excluded.

To connect several guns to the same cradle see the following paragraph 'Using Multiple Guns with Same Cradle'.

Bind



The green LED on the DLL6000-R will go on: the scanner is ready to be inserted into the cradle.

8. Firmly insert the scanner into the OM6010-R: a beep will be emitted, signaling that the OM6010-R has been paired to the DLL6000-R.



9. Read the Restore Cradle default code

Restore Cradle default



Default parameter settings are listed in par.3.1.3.

10. Read the Interface Selection code for your particular application:

RS232 Interface

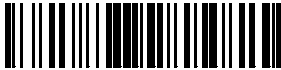

PEN EMULATION Interface



WEDGE Interface

IBM AT or PS/2 PCs



IBM AT - Alt Mode *



IBM XT



IBM SURE1



IBM Terminal 3153



IBM Terminals: 31xx, 32xx, 34xx, 37xx

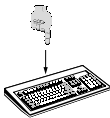

make-only keyboard



KEY TRANSMISSION

or



make-break keyboard



KEYBOARD TYPE

advanced keyboard



typewriter keyboard



You can change any interface selection by simply reading another interface selection code.

RS232 and WEDGE interface selection codes automatically restore header and terminator default values (see par. 4.4.1).

* See par. 4.2.1.

11.

Test



123456

- Test O.K.:** two short beeps
- Test Failure:** no beep or a long high-tone beep followed by a long low-tone beep.

3.1.1 Using Multiple Guns With Same Cradle

If you want to use several guns associated with the same cradle, you must first **Bind** the cradle with one of the guns (see the previously described configuration procedure).

Successive guns can be associated with this same cradle by following the configuration procedure substituting the Bind command with **Join**.

In this case the procedure ends with step **8**.

7.

Join



WARNING

If the cradle is not **Bound** to a gun, its address assumes a random value which can cause conflicts and malfunctions to other cradles within its range.

3.1.2 Gun Default Configuration

Reading Parameters	
Trigger signal	<i>level</i>
Trigger timeout	<i>10 sec.</i>
Reads per cycle	<i>one</i>
Safety time	<i>.5 sec</i>
Single-store	<i>disabled</i>
Power-off timeout	<i>8 hours</i>
Beeper intensity	<i>high</i>
Beeper tone	<i>2</i>
Good transmission beep	<i>enabled</i>
Decoding Parameters	
Ink spread	<i>enabled</i>
Overflow control	<i>enabled</i>
Interdigit control	<i>enabled</i>
Gun Operating Parameters	
Code identifier	<i>disabled</i>
Time stamping format	<i>disabled</i>
Time stamping delimiter	<i>none</i>
* Radio timeout	<i>1/2 sec.</i>
Display parameters	
Font size	<i>small</i>
Display timeout	<i>8 sec.</i>
Backlight	<i>off</i>
Contrast	<i>normal</i>
Display DLL mode	<i>normal</i>
Code Selection	
EAN 8/EAN 13 / UPC A/UPC E	<i>Check digit transmission, no conversions.</i>
Interleaved 2/5	<i>Check digit control and transmission, variable length code: 4-55 characters.</i>
Standard Code 39	<i>No check digit control, variable length code: 1-32 characters.</i>
Code 128	
Code 93; Codabar	<i>Disabled</i>

* The restore default command does not affect the selection made for this parameter.

3.1.3 Cradle Default Settings

RS232 Parameters	
Baud rate	9600
Parity	disabled
Data bits	8
Stop bit	1
Handshaking	disabled
Radio RX lock	disabled
Inter-character delay	disabled
Rx timeout	5 sec.
Pen Emulation Parameters	
Conversion to code 39	disabled
Output level	normal
Idle level	normal
Minimum output pulse	600 μ s
Overflow	medium
Wedge Parameters	
Keyboard nationality	USA
Caps lock	off
Delays	disabled
Num lock	off
Cradle Operating Parameters	
* Header	none
* Terminator	CR-LF (RS232), CR (Wedge)
Address stamping	disabled
Address delimiter	disabled
Battery Parameter	
Battery type	auto-detect
Network Parameter	
Echelon network	disabled

* The restore default command does not affect the selection made for these parameters.

3.2 CHANGING SYSTEM CONFIGURATION

The DLL6000-R and OM6010-R default parameters can be changed by following the procedure below.

1. Open the folded page in Appendix C with the Hex-Numeric table and keep it open during configuration.
2. Go to the section of the group to modify.
3. Follow the procedure for that section.

System parameters are grouped according to the following figure:

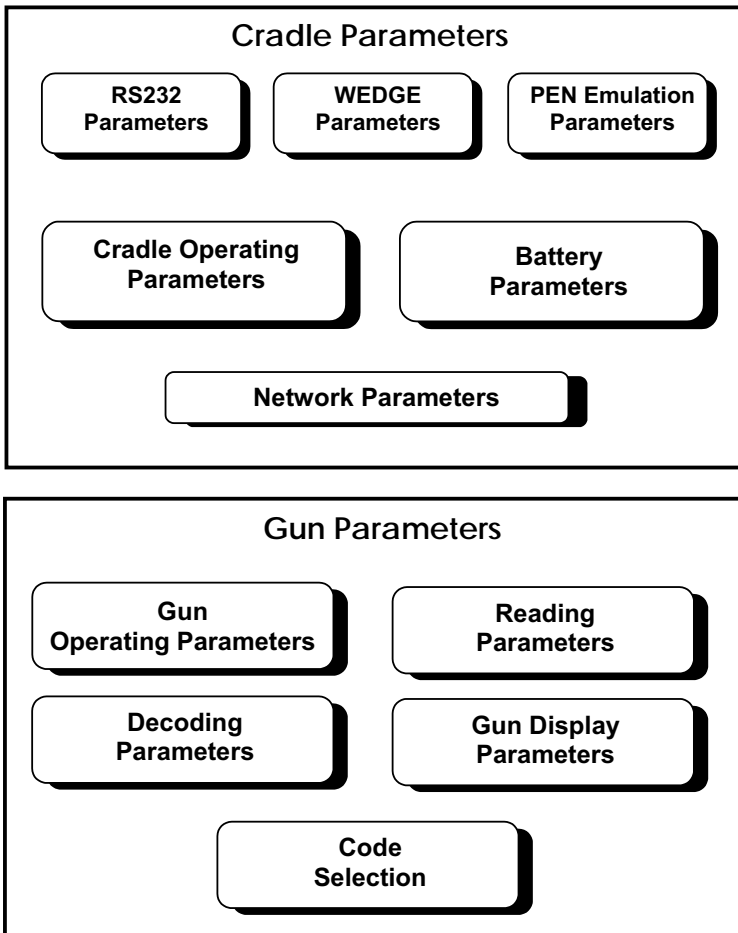

CRADLE

PARAMETERS

RS232 PARAMETERS

PARAMETERS	DEFAULT
<input type="text" value="BAUD RATE"/>	9600
<input type="text" value="PARITY"/>	disabled
<input type="text" value="DATA BITS"/>	8
<input type="text" value="STOP BITS"/>	1
<input type="text" value="HANDSHAKING"/>	disabled
<input type="text" value="RADIO RX LOCK"/>	disabled
<input type="text" value="INTER-CHARACTER DELAY"/>	disabled
<input type="text" value="RX TIMEOUT"/>	5 sec.

TO CHANGE THE DEFAULT VALUES

1. Read the **Enter Configuration** code ONCE, available at the top of each page.
2. Read configuration codes from the desired groups 
 = Choose only one code from each selected group
 = Follow the procedure given for this code group
3. Read the **Exit and Save Configuration** code ONCE, available at the top of each page.



RS232

BAUD RATE

150 baud



300 baud

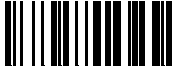

600 baud



1200 baud



2400 baud



4800 baud

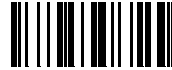

9600 baud



19200 baud



PARITY

disabled



odd parity



even parity





RS232

DATA BITS

7 bits

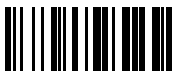

8 bits



9 bits



STOP BITS

1 stop bit



2 stop bits



HANDSHAKING

disabled



hardware (RTS/CTS)



software (XON/XOFF)



See par. 4.1.1 for details.



RS232

RADIO RX LOCK

disabled



enabled



See par. 4.1.2 for details.

INTER-CHARACTER DELAY

delay between characters
transmitted to Host



Read 2 numbers from the table where:

00 = DELAY disabled

01-99 = DELAY from 1 to 99 milliseconds

RX TIMEOUT

timeout control in reception from Host



Read 2 numbers from the table where:

00 = TIMEOUT disabled

01-99 = TIMEOUT from .1 to 9.9 seconds

See par. 4.1.3 for details.

WEDGE PARAMETERS

PARAMETERS	DEFAULT
KEYBOARD NATIONALITY	USA
CAPS LOCK	OFF
NUM LOCK	OFF
INTER-CHARACTER DELAY	disabled
INTER-CODE DELAY	disabled

TO CHANGE THE DEFAULT VALUES

1. Read the **Enter Configuration** code ONCE, available at the top of each page.

2. Read configuration codes from the desired groups



 = Choose only one code from each selected group

 = Follow the procedure given for this code group

3. Read the **Exit and Save Configuration** code ONCE, available at the top of each page.



WEDGE

KEYBOARD NATIONALITY

NOTE

When IBM AT - Alt Mode Interface is selected, it is not necessary to set the Keyboard Nationality.

English

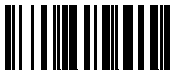

German



Swedish



Spanish



Japanese

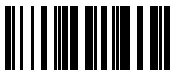

French



Italian



USA



Belgian





WEDGE

KEYBOARD NATIONALITY

(continued)

NOTE

When IBM AT - Alt Mode Interface is selected, it is not necessary to set the Keyboard Nationality.

Russian (Cyrillic)



Yugoslavian

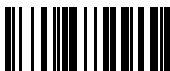

Czechoslovakian

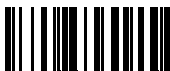

Russian (Latin)



Hungarian



Rumenian



CAPS LOCK

Caps lock OFF

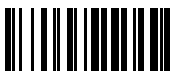

Caps lock ON



Select the appropriate code to match your keyboard caps lock status.



WEDGE

NUM LOCK

Toggle Num lock



use if Num lock key status is OFF

Num lock unchanged

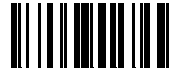

use if Num lock key status is ON

This selection is used together with the Alt Mode interface selection for AT PCs. It changes the way the Alt Mode procedure is executed, therefore it should be set to the same condition as used by your keyboard. In this way the device will execute the Alt Mode procedure correctly for your application.

INTER-CHARACTER DELAY

delay between characters
transmitted to Host



Read 2 numbers from the table where:

00 = DELAY disabled

01-99 = DELAY from **1** to **99** milliseconds

For more details, see par. 4.2.2.

INTER-CODE DELAY

delay between codes
transmitted to Host



Read 2 numbers from the table where:

00 = DELAY disabled

01-99 = DELAY from **0.1** to **9.9** seconds

PEN EMULATION PARAMETERS

PARAMETERS	DEFAULT
<input type="text" value="OPERATING MODE"/>	interpret
<input type="text" value="MINIMUM OUTPUT PULSE"/>	600 μ s
<input type="text" value="CONVERSION TO CODE 39"/>	disabled
<input type="text" value="OVERFLOW"/>	medium
<input type="text" value="OUTPUT LEVEL"/>	normal
<input type="text" value="IDLE LEVEL"/>	normal

TO CHANGE THE DEFAULT VALUES

1. Read the **Enter Configuration** code ONCE, available at the top of each page.
2. Read configuration codes from the desired groups 
 = Choose only one code from each selected group
3. Read the **Exit and Save Configuration** code ONCE, available at the top of each page.

PEN EMULATION

The values of the operating mode parameter are complete commands and do not require reading the Enter and Exit configuration codes.

OPERATING MODE

interpret mode



Interprets commands without sending them to the decoder.

transparent mode



sends commands to the decoder without interpreting them.



PEN EMULATION

MINIMUM OUTPUT PULSE

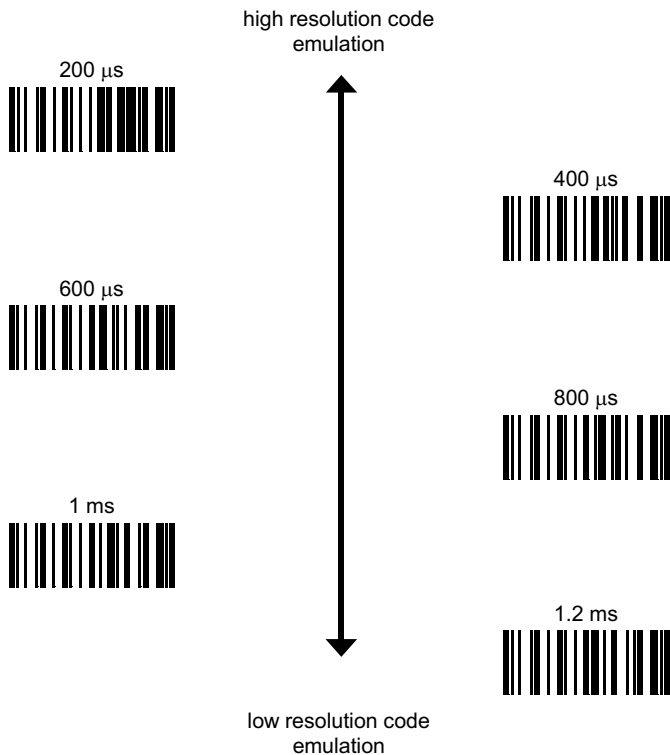

See par. 4.3.1 for details.

CONVERSION TO CODE 39

disabled



transmits all codes in their original format.

enabled



converts all codes read into Code 39 format.



PEN EMULATION

OVERFLOW

narrow



medium



wide



See par. 4.3.2 for details.

OUTPUT LEVEL

normal

(white = logic level 0)



inverted

(white = logic level 1)



See par. 4.3.3 for details.

IDLE LEVEL

normal

(black level)



inverted

(white level)



See par. 4.3.3 for details.

CRADLE OPERATING PARAMETERS

PARAMETERS	DEFAULT
HEADER	no header
TERMINATOR	RS232: CR-LF WEDGE: CR
ADDRESS STAMPING	disabled
ADDRESS DELIMITER	disabled

TO CHANGE THE DEFAULT VALUES

1. Read the **Enter Configuration** code ONCE, available at the top of each page.

2. Read configuration codes from the desired groups



 = Choose only one code from each selected group

 = Follow the procedure given for this code group

3. Read the **Exit and Save Configuration** code ONCE, available at the top of each page.



Cradle Operating Parameters

HEADER

no header



one character header

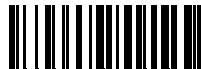

two character header



three character header



four character header



TERMINATOR

no terminator



one character terminator



two character terminator



three character terminator



four character terminator



After selecting the desired Header/Terminator code, read the character(s) from the HEX table.

EXAMPLE: ^{four character header}
 + 41 + 42 + 43 + 44 = Header **ABCD**

For more details about default values, see par. 4.4.1.

For Terminals see also table in par. 4.4.1, Extended Keyboard To Hex Conversion Table.



Cradle Operating Parameters

ADDRESS STAMPING

Gun Address Stamping disabled



Gun Address Stamping enabled



Cradle Address Stamping disabled



Cradle Address Stamping enabled



ADDRESS DELIMITER

Gun Address Delimiter disabled



Gun Address Delimiter enabled



**Read 2 HEX characters
in the range 00-FE**

Cradle Address Delimiter disabled



Cradle Address Delimiter enabled



**Read 2 HEX characters
in the range 00-FE**

For more details, see par. 4.4.1.

BATTERY CHARGING

PARAMETER	DEFAULT
OM6010-R BATTERY TYPE	Auto-detect

TO CHANGE THE DEFAULT VALUES

1. Read the **Enter Configuration** code ONCE, available at the top of the page.

2. Read configuration codes from the desired groups



= Choose only one code from each selected group

3. Read the **Exit and Save Configuration** code ONCE, available at the top of the page.



Battery Charging

OM6010-R BATTERY TYPE

auto-detect



Alkaline



NiMh/NiCd



Li-Ion



It is strongly recommended to configure the cradle with the dedicated battery type code. This will also slightly reduce charging time.

Select the Auto-detect code to charge different type battery guns with the same cradle.

NETWORK PARAMETERS

FOR MULTIDROP NETWORK SYSTEMS ONLY

PARAMETER	DEFAULT
ECHELON FIELDBUS	disabled

TO CHANGE THE DEFAULT VALUES

1. Read the **Enter Configuration** code ONCE, available at the top of the page.

2. Read configuration codes from the desired groups



= Choose only one code from each selected group

3. Read the **Exit and Save Configuration** code ONCE, available at the top of the page.

Enter configuration



Exit and Save configuration



Network Parameters

ECHELON FIELDBUS

disabled



Master

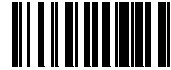

Slave



To configure the network communications correctly, the cradle connected to the Host must be configured as the **Master** and all other cradles connected to the multidrop line must be configured as **Slaves**.

After reading the Exit and Save Configuration code, you must power the cradle(s) off and then on again for the configuration to be recognized.

GUN

PARAMETERS

GUN OPERATING PARAMETERS

PARAMETERS	DEFAULT
<input type="checkbox"/> CODE IDENTIFIER	disabled
<input checked="" type="checkbox"/> RADIO TIMEOUT	1/2 sec.
<input checked="" type="checkbox"/> SET DATE AND TIME	
<input type="checkbox"/> TIME STAMPING FORMAT	disabled
<input checked="" type="checkbox"/> TIME STAMPING DELIMITER	disabled

TO CHANGE THE DEFAULT VALUES

1. Read the **Enter Configuration** code ONCE, available at the top of each page.
2. Read configuration codes from the desired groups 
 = Choose only one code from each selected group
 = Follow the procedure given for this code group
3. Read the **Exit and Save Configuration** code ONCE, available at the top of each page.



Gun Operating Parameters

CODE IDENTIFIER

disabled



AIM standard



DATALOGIC standard



For more details, see par. 4.4.1.

RADIO TIMEOUT



Read 3 numbers in the range 000-255:

000 = disables Radio Timeout (always on).

001 to 255 = timeout from .063 to 16 seconds.

For more details about default values, see par. 4.4.2.

SET DATE AND TIME

set time



Read 4 numbers for HHMM

set date



Read 6 numbers for DDMMYY



Gun Operating Parameters

TIME STAMPING FORMAT

disabled



hour/minutes/seconds
month/day/year



hour/minutes/seconds
day/month/year

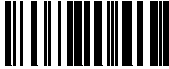

hour/minutes/seconds



month/day/year



day/month/year

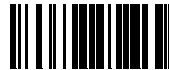

For more details, see par. 4.4.1.

TIME STAMPING DELIMITER

disabled



select delimiter

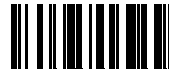



Read 2 HEX characters in the range 00-FE

For more details, see par. 4.4.1.

READING PARAMETERS

PARAMETERS	DEFAULT
TRIGGER SIGNAL	level
TRIGGER TIMEOUT	10 sec.
READS PER CYCLE	1
SAFETY TIME	.5 sec.
SINGLE-STORE	disabled
POWER-OFF TIMEOUT	8 hours
GOOD TRANSMISSION BEEP	enabled
BEEPER INTENSITY	high
BEEPER TONE	2

TO CHANGE THE DEFAULT VALUES

1. Read the **Enter Configuration** code ONCE, available at the top of each page.
2. Read configuration codes from the desired groups 
 = Choose only one code from each selected group
 = Follow the procedure given for this code group
3. Read the **Exit and Save Configuration** code ONCE, available at the top of each page.



Reading Parameters

TRIGGER SIGNAL

trigger active level



trigger active pulse



See par. 4.5.1 for details.

TRIGGER TIMEOUT

auto-off timeout



Read 2 numbers in the range 00-99:

00 = disables the trigger timeout

01-99 = corresponds to a max. 99 sec. delay after the trigger press before turning the laser off automatically.

See par. 4.5.2 for details.

READS PER CYCLE

one read per cycle



multiple reads per cycle



See par. 4.5.3 for details.

SAFETY TIME

safety time



Limits same code consecutive reading.

Read 2 numbers in the range 00-99:

00 = no same code consecutive reading until reader is removed (no decoding) for at least 400 ms.

01 to 99 = timeout from .1 to 9.9 seconds before a consecutive read on same code.

See par. 4.5.4 for details.



Reading Parameters

SINGLE-STORE

disabled



enabled

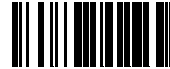

See par. 4.5.5 for details.

POWER-OFF TIMEOUT

power-off timeout

**Read 2 numbers in the range 00-99:**

00 =	disables power-off
01 - 99 =	delays from 1 to 99 hours before implementing power-off

See par. 4.5.6 for details.

GOOD TRANSMISSION BEEP

disabled



enabled





Reading Parameters

BEEPER INTENSITY

beeper off



low intensity



medium intensity



high intensity



BEEPER TONE

tone 1



tone 2



tone 3



tone 4



DECODING PARAMETERS

PARAMETERS	DEFAULT
<input type="checkbox"/> INK SPREAD	enabled
<input type="checkbox"/> OVERFLOW CONTROL	enabled
<input type="checkbox"/> INTERDIGIT CONTROL	enabled

CAUTION

Before changing these parameter values read the descriptions in par. 4.6.

TO CHANGE THE DEFAULT VALUES

1. Read the **Enter Configuration** code ONCE, available at the top of each page.

2. Read configuration codes from the desired groups



= Choose only one code from each selected group

3. Read the **Exit and Save Configuration** code ONCE, available at the top of each page.



Decoding Parameters

INK-SPREAD

disabled



enabled



See par. 4.6.1 for details.

OVERFLOW CONTROL

disabled



enabled



See par. 4.6.2 for details.

INTERDIGIT CONTROL

disabled



enabled





See par. 4.6.3 for details.

GUN DISPLAY PARAMETERS



PARAMETERS	DEFAULT
DISPLAY FONT SIZE	small
DISPLAY TIMEOUT	8 sec.
DISPLAY BACKLIGHT	off
DISPLAY CONTRAST	normal
DISPLAY MODE	normal

TO CHANGE THE DEFAULT VALUES

1. Read the **Enter Configuration** code ONCE, available at the top of each page.
2. Read configuration codes from the desired groups 
 = Choose only one code from each selected group
 = Follow the procedure given for this code group
3. Read the **Exit and Save Configuration** code ONCE, available at the top of each page.



Gun Display Parameters

DISPLAY FONT SIZE

small font (6 x 8)



16 x 4 characters on display

medium font (8 x 8)



12 x 4 characters on display

large font (12 x 16)



8 x 2 characters on display

DISPLAY TIMEOUT

timeout



Read 2 numbers in the range 00-99:

- 00 = disables Display Timeout (always on).
- 01 to 99 = timeout from 1 to 99 seconds.

DISPLAY BACKLIGHT

backlight off



backlight on





Gun Display Parameters

DISPLAY CONTRAST

lighter



darker



Read the code until the desired contrast is reached.

DISPLAY MODE

Normal



Clear display after decode



Local echo



For further details, see par. 4.7.1.

CODE SELECTION

PARAMETERS	DEFAULT
<input checked="" type="checkbox"/> EAN/UPC FAMILY	EAN 8/EAN13 UPC A/UPC E check digit transmitted no conversions
<input checked="" type="checkbox"/> 2/5 FAMILY	Interleaved 2/5 check digit control and transmission variable length code: 4-55 characters
<input checked="" type="checkbox"/> CODE 39 FAMILY	Standard Code 39 no check digit control variable length code: 1-32 characters
<input checked="" type="checkbox"/> CODE 128 FAMILY	Code 128
<input type="checkbox"/> CODE 93	not enabled
<input checked="" type="checkbox"/> CODABAR FAMILY	not enabled

TO CHANGE THE DEFAULT VALUES

1. Read the **Enter Configuration** code ONCE, available at the top of each page.
2. Read configuration codes from the desired groups 
 = Choose only one code from each selected group
 = Follow the procedure for this code group
3. Read the **Exit and Save Configuration** code ONCE, available at the top of each page.



Code Selection

DISABLES ALL CODE FAMILIES



NOTE

The reader allows up to 5 code selections. This does not limit the number of CODES enabled to 5, as it depends on the code family:

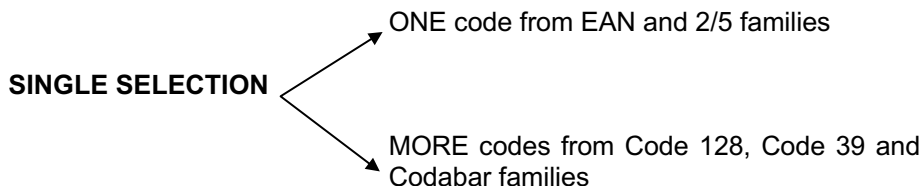

Example

5 code selections:

1. **2/5 Interleaved**
2. **2/5 Industrial**
3. Code 128 + EAN 128
4. Code 39 Full ASCII + Code 32
5. **UPC A/UPC E**

In this section all **SINGLE** code selections are **underlined and in bold.**



Code Selection

EAN/UPC FAMILY

disables the family



Read a single code or combination code selection

EAN 8

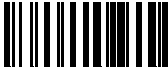

EAN 13



UPC A



UPC E



EAN 8/EAN 13/UPC A/UPC E
with and without ADD ON



WITHOUT ADD ON

EAN 8/EAN 13/UPC A/UPC E



EAN 8/EAN 13



UPC A /UPC E



WITH ADD ON

EAN 8/EAN 13/UPC A/UPC E



EAN 8/EAN 13



UPC A /UPC E





Code Selection

EAN/UPC CHECK DIGIT TX SELECTIONS

For each code type in this family you can choose to transmit the check digit or not

EAN 8



EAN 13



check digit transmission



UPC A



no check digit transmission



UPC E



CONVERSION OPTIONS

UPC E to UPC A conversion



UPC E to EAN 13 conversion



UPC A to EAN 13 conversion



EAN 8 to EAN 13 conversion





Code Selection

2/5 FAMILY

disables the family

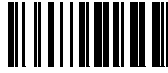

① Read the desired family code

Interleaved 2/5



Normal 2/5 (5 Bars)



Industrial 2/5 (IATA)



Matrix 2/5 (3 Bars)



② Read a check digit selection

no check digit control



check digit control and
transmission



check digit control
without transmission



The pharmaceutical code below is part of the 2/5 family but has no check digit nor code length selections.

Code CIP/HR



French pharmaceutical code

③ Read 4 numbers
for the code length where:

First 2 digits = minimum code length.

Second 2 digits = maximum code length.

The maximum code length is 55 characters.

The minimum code length must always be less than or equal to the maximum.

Examples:

0155 = variable from 1 to 55 digits in the code.

1010 = 10 digit code length only.



Code Selection

CODE 39 FAMILY

disables the family



- ① Read the desired family code

Standard Code 39



Full ASCII Code 39



- ② Read a check digit selection

CHECK DIGIT TABLE

no check digit control



check digit control and transmission



check digit control without transmission



The pharmaceutical codes below are part of the Code 39 family but have no check digit selections.

Code CIP39



French pharmaceutical code

Code 32



Italian pharmaceutical code

CODE LENGTH (optional)

The code length selection is valid for the entire Code 39 family.

set code length



Read 4 numbers for the code length where:

First 2 digits = minimum code length.

Second 2 digits = maximum code length.

The maximum code length is 32 characters. The minimum code length must always be less than or equal to the maximum.

Examples:

0132 = variable from 1 to 32 digits in the code.

1010 = 10 digit code length only.



Code Selection

CODE 128 FAMILY

disables the family

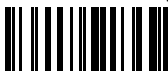

Code 128



control without transmission of check digit

EAN 128



control without transmission of check digit

CODE 93

disables the code



Code 93



control without transmission of check digit



Code Selection

CODABAR FAMILY

disables the family



For Standard Codabar:

① Read the desired equality control code

Standard Codabar



no start/stop character equality control

Standard Codabar



start/stop character equality control

② Read a start/stop transmission selection

no transmission



transmission



The Codabar ABC code below uses a fixed start/stop character transmission selection.

Codabar ABC



no start/stop character equality control
but transmission.

CODE LENGTH (optional)

The code length selection is valid for the entire Codabar family.

set code length



Read **4** numbers for the code length where:

First 2 digits = minimum code length.

Second 2 digits = maximum code length.

The maximum code length is 44 characters. The minimum code length must always be less than or equal to the maximum.

Examples:

0144 = variable from 1 to 44 digits in the code.

1010 = 10 digit code length only.

4 REFERENCES

4.1 RS232 PARAMETERS

4.1.1 Handshaking

Hardware handshaking (RTS/CTS)

The RTS line is activated by the decoder before transmitting a character. Transmission is possible only if the CTS line (controlled by the Host) is active.

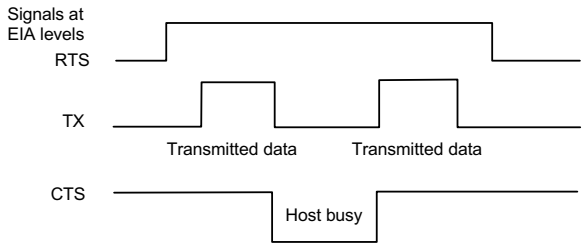

RTS/CTS handshaking

Software handshaking (XON/XOFF)

During transmission, if the Host sends the XOFF character (13 Hex), the decoder interrupts the transmission with a maximum delay of one character and only resumes when the XON character (11 Hex) is received.

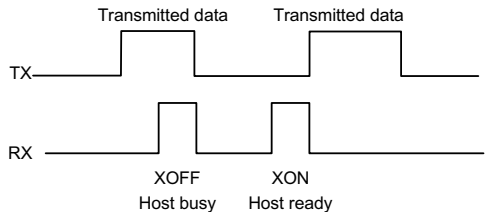

XON/XOFF handshaking

4.1.2 Radio RX Lock

This parameter is used to control radio reception from the guns to the cradle when the Host uses either RTS/CTS or XON/XOFF Handshaking.

If enabled, this command blocks radio reception to the cradle when the Host has interrupted RS232 data communication (CTS low or XOFF). The effect is that guns cannot send data to the cradle until the Host resumes data communication (CTS high or XON). This is similar to FIFO buffering

disabled, where data can be collected only when communication is possible. In any case, prior to interruption, data is buffered in the cradle.

This command is only effective if handshaking is enabled. If used in a Multidrop Network, it only works for the Master cradle.

If disabled, guns continue to send data to the cradle which buffers them even if data communication has been interrupted by the Host (CTS low or XOFF). If the buffer becomes full, the gun signals an error and any further data is discarded until communication is restored. This is similar to FIFO enabled where data collection continues even though communication is interrupted.

4.1.3 RX Timeout

The timeout in data reception can be used to automatically end data reception after the specified period of time. If no character is received from the Host, after the timeout expires, any incomplete string (any string not terminated by <CR>) is flushed from the Cradle receive buffer and if being configured, the Cradle exits configuration mode.

4.2 WEDGE PARAMETERS

4.2.1 IBM AT - Alt Mode Interface

The IBM AT - Alt Mode interface allows barcodes sent to the PC to be interpreted correctly independently from the Keyboard nationality used, therefore no keyboard nationality selection is required.

When selecting the IBM AT - Alt Mode interface, make sure the Num lock parameter selection matches the Num lock key status on your keyboard.

4.2.2 Inter-character Delay

When IBM SURE1 interface is selected, the default value for the Inter-character Delay is forced to 5 msec. With this interface no lower value can be programmed for this parameter.

4.3 PEN EMULATION PARAMETERS

4.3.1 Minimum Output Pulse

This parameter sets the duration of the output pulse corresponding to the narrowest element in the barcode. In this way the code resolution is controlled by the signal sent to the decoder, independently of the physical resolution of the code read.

The shortest pulse (200 μ s) corresponds to a high resolution code emulation and therefore a shorter transfer speed to the decoder (for decoders able to work on high resolution codes). Likewise, longer pulses correspond to low resolution code emulation and therefore a longer transfer time to the decoder.

4.3.2 Overflow

This parameter generates a white space before the first bar and after the last bar of the code. The selections are as follows:

- narrow = space 10 times the minimum output pulse.
- medium = space 20 times the minimum output pulse.
- wide = space 30 times the minimum output pulse.

4.3.3 Output and Idle Levels

The following state diagrams describe the different output and idle level combinations for Pen emulation:

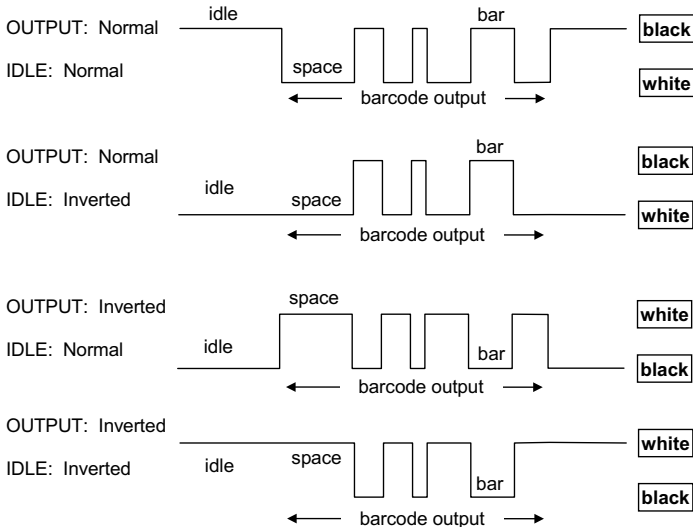

Output and Idle Levels

4.4 CRADLE AND GUN OPERATING PARAMETERS

4.4.1 Output Data Format

The output data format towards the Host is:

[Header] [Gun_Addr] [Gun_Addr_delimiter] [Cradle_Addr] [Cradle_Addr_delimiter]
 [Time stamp] [Ts_delimiter] [Code ID] **CODE** [Terminator]

[Items in square brackets are optional.]

Header/Terminator Selection

The header/terminator selection is not effected by the reading of the restore default code.

In fact, header and terminator default values depend on the interface selection:

- RS232: no header, terminator CR-LF
- WEDGE: no header, terminator CR

These default values are always restored through the reading of RS232 or WEDGE interface selection code, step **10** of the System Start Up procedure.

EXTENDED KEYBOARD TO HEX CONVERSION TABLE				
HEX	IBM AT	IBM 3153	IBM XT	IBM 31xx, 32xx, 34xx, 37xx
	KEY	KEY	KEY	KEY
83	ENTER	ENTER	ENTER	FIELD EXIT
84	TAB	TAB	TAB	TAB
85	F1	F1	F1	F1
86	F2	F2	F2	F2
87	F3	F3	F3	F3
88	F4	F4	F4	F4
89	F5	F5	F5	F5
8A	F6	F6	F6	F6
8B	F7	F7	F7	F7
8C	F8	F8	F8	F8
8D	F9	F9	F9	F9
8E	F10	F10	F10	F10
8F	F11	ESC	ESC	F11
90	F12	BACKSPACE	BACKSPACE	F12
91	HOME	HOME	HOME	ENTER
92	END	END	END	RESET
93	PG UP	PG UP	PG UP	INSERT
94	PG DOWN	PG DOWN	PG DOWN	DELETE
95	↑	↑	↑	FIELD -
96	↓	↓	↓	FIELD +
97	←	←	←	ENTER (Paddle)
98	→	→	→	PRINT
99	ESC	ESC	ESC	
9A	CTRL (Right)	CTRL (Right)	CTRL (Right)	

Gun/Cradle Address Stamping

It is possible to include the gun and cradle addresses in the message sent to the host. The Gun Address Stamping and the Cradle Address Stamping parameters consist of a 3-digit number in the range 000 to 126. For message output format, refer to the example on page 4.4.

Gun/Cradle Address Delimiter

The Address Delimiters allow a character to be included to separate the Gun and Cradle Address stamping fields from the next fields in the message. Any character can be included in the hexadecimal range from 00 to FE. For message output format, refer to the example on page 4.4.

Time Stamping Format

The Time Stamping parameter sets the format for hour and date information. It consists of 1 or 2 groups of numbers, each one made up of 6 decimal digits.

For example, setting the Hour/Minutes/Seconds/Month/Day/Year format, the information *17:03:16 on June 12, 2000* will be formatted as 170316061200.

Time Stamping Delimiter

The Time Stamping Delimiter allows a character to be included to separate the Time Stamping field from the next field in the message. Any character can be included in the hexadecimal range from 00 to FE.

Code Identifier

CODE IDENTIFIER TABLE		
CODE	DATALOGIC STANDARD	AIM STANDARD
2/5 interleaved	N]I y
2/5 industrial	P]X y
2/5 normal 5 bars	O]S y
2/5 matrix 3 bars	Q]X y
EAN 8	A]E 4
EAN 13	B]E 0
UPC A	C]X y
UPC E	D]X y
EAN 8 with 2 ADD ON	J]E 5
EAN 8 with 5 ADD ON	K]E 6
EAN 13 with 2 ADD ON	L]E 1
EAN 13 with 5 ADD ON	M]E 2
UPC A with 2 ADD ON	F]X y
UPC A with 5 ADD ON	G]X y
UPC E with 2 ADD ON	H]X y
UPC E with 5 ADD ON	I]X y
Code 39	V]A y
Code 39 Full ASCII	W]A y
CODABAR	R]F y
ABC CODABAR	S]X y
Code 128	T]C 0
EAN 128	k]C 1
Code 93	U]G y
CIP/39	Y]X y
CIP/HR	e]X y
Code 32	X]X y

NOTE

AIM standard identifiers are not defined for all codes:
 the X identifier is assigned to the code for which the standard is not defined,
 y value depends on the selected options (check digit tested or not, check digit tx or not, etc.).

4.4.2 Radio Timeout

After a code has been read and transmitted, the radio remains active for the amount of time set by the Radio Timeout parameter. This is particularly useful when the Host is expected to send a reply message to the gun. This parameter depends heavily on the application and is therefore provided here for system optimization according to your application.

The default value for this parameter is 008 (about 1/2 sec.). This is a reasonable value for most applications, but it could need to be changed according to the following considerations:

- If your application does not require the host to send messages to the gun(s), (which is true for all Wedge applications), the best setting for the radio timeout is the minimum value 001, which is about 1/16 of a second. This allows maximum battery autonomy.
- When your application requires bi-directional communications, the radio timeout must be set according to the number of guns and the amount of traffic so that no messages are lost.

NOTE

Setting the Radio Timeout to 000 causes the radio to always be ON. If you do this, the gun will accept messages from the host at any time, but the batteries will discharge quickly.

4.5 READING PARAMETERS

4.5.1 Trigger Signal

Trigger signal is useful to determine the modality of the reader ON state:

- trigger level: the reader goes ON when the trigger is pressed and goes OFF when it is released;
- trigger pulse: the reader goes ON at the first trigger press and goes OFF only at a second press.

4.5.2 Trigger Timeout

When this timeout is selected, the reader which is triggered ON but not decoding turns the laser OFF automatically after the desired period of time.

4.5.3 Reads per Cycle

A reading cycle depends on the trigger signal selection (see par. 4.5.1) and on the trigger timeout selection (see par. 4.5.2).

When one read per cycle is selected, the scanner turns off as soon as a valid code is decoded. To turn the reader on again, release and again press the trig-

ger in case the scanner is operating in 'trigger level mode', pull the trigger if the reader is operating in 'trigger pulse mode'.

When multiple reads per cycle is selected, the scanner turns off after a good decoding for the time necessary to transmit the code and activate the beeper, then it turns on again. The scanner turns off after a trigger press according to the 'trigger signal' selection or when the timeout expires.

The Safety Time parameter can be used in this case to avoid unwanted multiple reading of the same code, see safety time below.

4.5.4 Safety Time

Safety time prevents the device from immediately decoding the same code more than once. Same code consecutive reading can be disabled requiring the reader to be removed from the code (no decoding) for at least 400 ms, or a timeout can be set up to 9.9 seconds before the decoder will accept the same code. Reading is immediate if the code changes.

4.5.5 Single-Store

When single-store mode is enabled, if the DLL6000-R fails to transmit a code to the cradle, it enters a special operating mode that prevents the user from reading barcodes. When such operating mode is entered, the trigger no longer enables barcode reading but is used to retry the transmission itself. Once the transmission is successful the gun returns to the standard mode.

Single-store may be useful if you often read codes at the limit of the coverage area and there is a chance that code transmission can fail. In such case single-store allows you to move to a more favorable position or location (i.e. closer to the cradle) and retry transmission without the necessity of re-reading the code since it is already stored in the gun.

Conversely, if single-store is disabled, and the user wants to retry transmission, the code must be read again, and therefore the attempt must be made from basically the same location. If the user gives up, he doesn't know if the transaction was successful. (Actually the transmission could have been successful but the cradle may have been unable to acknowledge the message). There are applications in which there is no risk of transmission failure. In such cases it may be

better to disable single-store so that the user perceives a more consistent behaviour of the trigger in that it always corresponds to code reading.

4.5.6 Power-Off Timeout

With Ni-MH, NiCd, or AA batteries, when this timeout is set, a gun which is left unused will power-off after the selected time. The gun will power-up again upon a trigger press. This will save battery power. This parameter is not valid for Li-Ion batteries.

4.6 DECODING PARAMETERS

CAUTION

These parameters are intended to enhance the decoding capability of the reader for particular applications. Used incorrectly, they can degrade the reading performance or increase the possibility of a decoding error.

4.6.1 Ink-Spread

The ink-spread parameter allows the decoding of codes which are not perfectly printed because the page texture tends to absorb the ink.

4.6.2 Overflow Control

The overflow control parameter can be disabled when decoding codes printed on small surfaces, which don't allow the use of an overflow space. This command does not effect code families 2/5, Code 128 and Code 93.

For the EAN/UPC code family, do not use code combinations. Each code must be selected singularly if this control is disabled.

For example, to read EAN8 and EAN13 without overflow control select two codes: EAN8 and EAN13; do not select the EAN8/EAN13 combination.

4.6.3 Interdigit Control

The interdigit control parameter verifies the interdigit spacing for code families Code 39 and Codabar.

4.7 GUN DISPLAY PARAMETERS

4.7.1 Display Mode

The user can control the gun display behavior according to the following selections:

Normal mode: When a barcode is read with the gun:

- The code is sent to the Host.
- The gun display is not cleared. Therefore if any previous data was displayed on the gun screen it remains.
- There is no Local Echo to the gun display.

Clear Display After Decode mode: When a barcode is read with the gun:

- The code is sent to the Host.
- The gun display is cleared. Therefore if any previous data was displayed on the gun screen it is cancelled and the screen remains blank.
- There is no Local Echo of the code to the gun display.

Local Echo mode: When a barcode is read with the gun:

- The code is sent to the Host.
- The gun display is cleared.
- The code is also sent to the gun display (Local Echo).
- The cursor is positioned after the last printed character on the gun display.

Host messages sent to the gun are always written to the gun display.

4.8 SOFTWARE RELEASE

The following codes cause the gun and the cradle to transmit the respective software release to the Host:



5 COMMUNICATION AND MESSAGE FORMATTING

The system always provides gun to host data communication using the message formatting described in par. 4.4.1.

However, if the RS232 interface is selected for communication between the Host and the OM6010-R cradle, then the following additional communications between Host and Gun can occur:

- The Host can send messages to any gun associated with that cradle to control the Gun's display, LEDs and beeper.
- The Gun can send up to 3 user-defined characters to the Host using the 3 command keys on the gun.

These communications and their relative message formatting are detailed in the following paragraphs.

5.1 MESSAGES FROM HOST TO GUN

The general format is:

```
[Gun_Address][Gun_Add_delimiter]<Message>CR
```

NOTE:

- If you have enabled the Gun Address Stamping or the Gun Address Delimiter, you **must** specify them in every message.
- If you have **not** enabled the Gun Address Stamping or the Gun Address Delimiter, you **must not** specify them. In this case all messages will be implicitly addressed to the 'binded' gun of the cradle directly connected to the serial line.
- Messages cannot start with '\$+' because they would be interpreted as a configuration command.
- You can send a message to the gun only while it is on. This happens when it has sent a message to the host and the radio timeout has not yet expired. (See par. 4.4.2, "Radio Timeout"; command is on page 3.31).

- If you want to control the gun's beeper from the host, you will also probably want to disable the good transmission beep that is emitted when the code is received from the cradle. (See command on page 3.35).

The message field can store plain text and escape sequences.

- Escape sequences are interpreted as commands.
- Plain text is directly printed on the display. If writing beyond the end of line, the display does not wrap automatically. Extra characters are ignored. Control characters are not interpreted (i.e. LF, FF, etc.).

5.1.1 Cursor Control

ESC [n A	Up <i>n</i> rows, no scroll
ESC [n B	Down <i>n</i> rows, no scroll
ESC [n C	Right <i>n</i> columns
ESC [n D	Left <i>n</i> columns
ESC [G	CR
ESC [r ; c H	Move to row <i>r</i> , column <i>c</i> (ESC[1;1H is the upper left character position of the display)
ESC D	Down 1 row, with scroll
ESC E	CR and cursor down 1 row with scroll
ESC M	Up 1 row and scroll

NOTE:

- Since CR is used as the message terminator, you must use ESC [G or ESC E to print a CR.
- The cursor row position **is not** affected by the currently selected font. The display always has 4 rows, so when writing with the large font, actually two rows are written to: the current one and the one below it. You will need two ESC E commands to step from one row to the next when using the large font.
- The cursor column position **is** affected by the currently selected font. Therefore, column 6 is 36 pixels from the left border only if you last selected the 6x8 font; otherwise it could be 48 or 72 pixels from the left border.

5.1.2 Font Selection

- ESC [0 m** Normal mode
- ESC [7 m** Reverse mode
- ESC # 4** Large font: subsequent characters are written on the current row and the row below it using the 12x16 font which allows for two rows of eight characters on the display.
- ESC # 5** Normal font: subsequent characters are written using the 6x8 font which allows for four rows of sixteen characters on the display.
- ESC # 7** Medium font: subsequent characters are written using the 8x8 font which allows for four rows of twelve characters on the display.

5.1.3 Clearing Display

- ESC [0 K** From cursor position to end of line inclusive
- ESC [1 K** From beginning of line to cursor position (not inclusive)
- ESC [2 K** Entire line
- ESC [0 J** From cursor position to end of display inclusive
- ESC [1 J** From beginning of display to cursor position (not inclusive)
- ESC [2 J** Entire display; moves cursor to upper left corner on display

5.1.4 LED and Beeper Control

ESC [0 q	Emit short High tone + short delay
ESC [1 q	Emit short Low tone + short delay
ESC [2 q	Emit long Low tone + short delay
ESC [3 q	Emit good read tone
ESC [4 q	Emit bad tx tone
ESC [5 q	Wait 100 ms
ESC [6 q	Turn on the green LED
ESC [7 q	Turn off the green LED
ESC [8 q	Turn on the red LED
ESC [9 q	Turn off the red LED

The LED control escape sequences are intended to activate the LEDs for short periods of time and can be used in combination with the Beeper. The LED and Beeper will be controlled by the system after the entire command sequence is interpreted.

Example:

ESC [6 qESC [3 qESC [7 q Turns on the green LED, emits a good read tone, and turns off the green LED.

ESC [6 qESC [5 qESC [7 q Turns on the green LED for 100 ms and then turns off the green LED.

5.1.5 Setting RTC

ESC [0 p d d m m y y	Set date to day, month, year
ESC [1 p h h m m	Set time to hours, minutes; seconds are automatically set to 00.

5.2 MESSAGES FROM GUN COMMAND KEYS

The DLL6000-R series guns with display have 3 command keys that can each be associated with a character to send to the host.

By pressing the keys on the gun, the associated character with its relative message formatting is sent to the Host. For example, keys can be used to select items from a menu sent to the gun display by the application program.

The general format is:

[Header] [Gun_Addr] [Gun_Addr_delimiter]] [Cradle_Addr] [Cradle_Addr_delimiter]
 [Time stamp] [Ts_delimiter] [Code ID] **KeyID** [Terminator]

The messages are handled by the system as if they were barcodes, that's why **KeyID** can have so many fields appended to it. If in your application there is some chance of reading a 1-char barcode identical to **KeyID**, the way you can distinguish between the two is to enable the Code ID: The **KeyID** is the only 1-character long EAN 8 code.

Refer to par. 4.4.1 for a complete description of the optional message fields in square brackets.

The default characters associated with each key (**KeyID**) are shown in the following table:

Default Key Identifiers		
	Key	KeyID
▲	(left) Key	'<'
ENTER	(center) Key	'='
▼	(right) Key	'>'

The Key Identifier values can be customized by using the configuration procedure below:

Enter
Configuration



Key Identifier



+ **xxyyzz**

where: **xx** = left-key Identifier
yy = center-key Identifier
zz = right-key Identifier
xxyyzz are hexadecimal values representing ASCII characters in the range **00-FE**.
FF = Key Identifier disabled.

Exit and Save
Configuration



The keypad can be disabled by reading the following code:

Keypad disabled



6 TECHNICAL FEATURES

6.1 DLL6000-R TECHNICAL FEATURES

Electrical Features	
Battery Type	2 AA NiMh* batteries or 1 Lithium-Ion Sanyo UR-110 battery
Time of recharge NiMh	2 hours
Time of recharge Li-Ion	5 hours
Operating autonomy (typ. continuous reading)	60,000 reads - NiMh 75,000 reads - Li-Ion
Display (Only available with some models)	LCD 4 lines x 16 chars Programmable font and backlight
Indicators	Laser On / battery low LED (red) Good Read LED (green) Programmable Beeper
Laser Features	
Power (typical) in mW	0.8 mW
Light Source	VLD 670 nm
Scan rate	36 ± 3 scans/sec
Reading field width	see reading diagram (par. 1.1.2)
Max. resolution	0.12 mm, 5 mils
PCS minimum	15% (Datalogic Test Chart)
Scan angle	42°
Laser Safety Class	2 (IEC 825-1 / CDRH)
Environmental Features	
Working Temperature	-10 °C to + 40 °C
Storage Temperature	-20 °C to + 50 °C
Humidity	90% non condensing
Drop resistance (on concrete) with display	1.5 m
without display	1.8 m
Protection	sealed against rain and dust
Mechanical Features	
Weight (with batteries)	about 340 g.
Dimensions	203 x 117 x 69 mm
Material	ABS and Polycarbonate molded with rubber

* It is possible to employ also NiCd or non-chargeable Alkaline AA batteries.

6.2 OM6010-R / C6010 TECHNICAL FEATURES

	OM6010-R	C6010
Electrical Features		
Supply voltage	10..28 Vdc	
Power consumption	max. 8 W (charging) *	
Indicators	Charger on (red) Charge completed (green) Power / Data (yellow)	Charger on (red) Charge completed (green) Power (yellow)
Time of recharge	NiMh / NiCd batteries: 2 hours Li-Ion batteries: 5 hours	
Host interfaces		
RS232	300..19200 baud	
WEDGE	IBM AT, XT, IBM SURE1, IBM 3153, 31xx, 32xx, 34xx, 37xx terminals supported	
PEN Emulation	Selectable minimum pulse from 200 μ S to 1.2 mS	
Environmental Features		
Working temperature	-10 to +40 °C	
Storage temperature	-10 to +60 °C	
Humidity	90 % non condensing	
Protection	IP40	
Mechanical Features		
Weight with mounting support	about 600 g.	
Dimensions (without antenna)	185 x 115 x 104 mm	
Material	ABS	

* Having a switching regulator inside, the OM6010-R and C6010 draw the same power, regardless of the supply voltage. i.e. as the input voltage increases the current drawn decreases.

6.3 SYSTEM FEATURES

	European Models	USA Models
Radio Features		
Working Frequency	433.92 MHz	910 MHz
Bit rate	19200 baud	36800 baud
Range	50 m open air	
Max number of guns per cradle	32	
Echelon Network Features		
Max. number of cradles per system	64	
Max number of devices per system	127	
Echelon bit rate	78 Kbaud	
Max system cable length	1300 meters	

APPENDIX A HOST CONFIGURATION STRINGS

In this section we provide a description of how to modify the configuration using serial command strings sent from the Host.

This method requires the RS232 interface.

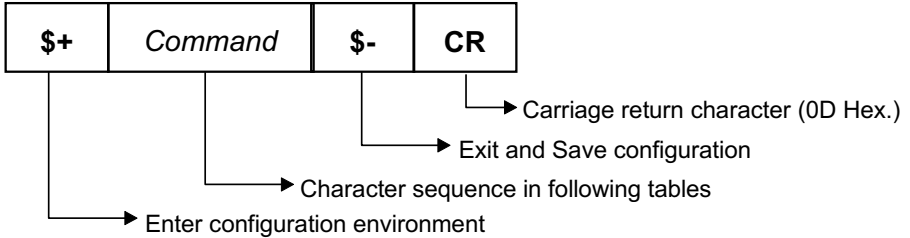

For RS232 user's, the configuration can be changed by receiving commands from the Host through the serial interface. When this method is used, the programming sequence format is the following:

Example:

Multiple command programming sequence:

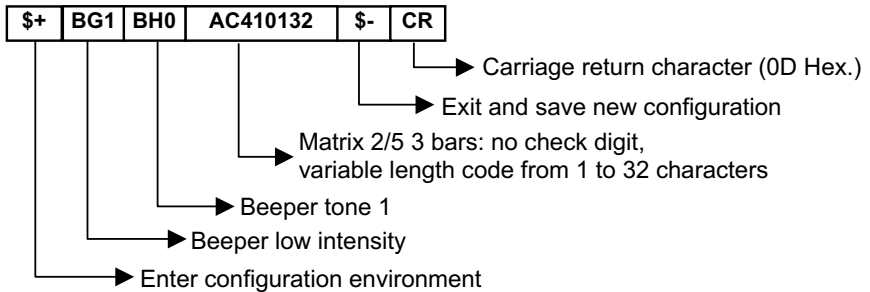

Each configuration parameter setting removes the condition previously active for that parameter.

NOTE

The buffer can contain a maximum of 256 characters. If your programming string goes over this value, you must split it into separate groups, according to the following rules:

- all gun commands must reside in one single string;
- consecutive string transmission must occur after a delay of at least 3 seconds to give the cradle time to process each string.

Many of the following tables list gun parameters.

If you include **gun configuration commands** in your configuration string:

1. Send the string to the cradle.
2. Read the following code with the gun to be programmed:

Get Gun Configuration from Cradle



The green LED will light, signaling the gun has recognized the command.

3. Insert the gun into the cradle. The LED will turn off and you will hear a short beep. Now the gun has accepted the configuration.
4. If you do not turn the cradle off, you can repeat steps 2 and 3 with all the guns you want to configure with the same string.

SERIAL CONFIGURATION STRINGS	
CONFIGURATION COMMANDS	
DESCRIPTION	STRING
Restore factory default configuration	\$*
Transmit the Cradle Software release	\$!

The above commands do not require \$- to exit.

Cradle Parameters

INTERFACE SELECTION		
DESCRIPTION	STRING	
RS232 interface	CP0	
PEN emulation interface	CP6	
WEDGE	for IBM AT	CP500
	for IBM AT – Alt Mode	CP507
	for IBM XT	CP503
	for IBM SURE1	CP506
	for IBM Terminal 3153	CP504
	for IBM Terminals 31xx, 32xx, 34xx, 37xx; make-break keyboard	CP501
	for IBM Terminals 31xx, 32xx, 34xx, 37xx; make only keyboard	CP502

RS232 PARAMETERS		
DESCRIPTION	STRING	
Baud rate	150	CD0
	300	CD1
	600	CD2
	1200	CD3
	2400	CD4
	4800	CD5
	9600	CD6
	19200	CD7
Parity	Disabled	CC0
	Even	CC1
	Odd	CC2
Data bits	7	CA0
	8	CA1
	9	CA2
Stop bits	1	CB0
	2	CB1
Handshaking	Disabled	CE0
	RTS/CTS	CE1
	XON/XOFF	CE2
Radio RX lock	Disabled	EC1
	Enabled	EC0
Inter-character Delay	CK00 - CK99	
RX Timeout	CL00 - CL99	

WEDGE PARAMETERS		
DESCRIPTION		STRING
Keyboard Type for IBM Terminals 31xx, 32xx,34xx, 37xx:	Typewriter	FK0
	Advanced	FK1
Keyboard Nationality	English	FJ4
	French	FJ2
	German	FJ3
	Italian	FJ1
	Swedish	FJ5
	USA	FJ0
	Spanish	FJ6
	Belgian	FJ7
	Japanese	FJ8
	Russian (Latin)	FJ9
	Russian (Cyrillic)	FJA
	Hungarian	FJB
	Yugoslavian	FJC
	Rumenian	FJD
Czechoslovakian	FJE	
Caps Lock	Caps Lock ON	FE1
	Caps Lock OFF	FE0
Num Lock	Num Lock unchanged	FL1
	Toggle Num Lock	FL0
Inter-character Delay		CK00 - CK99
Inter-code Delay		FG00 - FG99

PEN PARAMETERS		
DESCRIPTION		STRING
Conversion to Code 39	Disabled	DA0
	Enabled	DA1
Operating mode	Interpret (does not require \$+ or \$-)	\$]
	Transparent (does not require \$+ or \$-)	\$[
Output level	Normal	DD0
	Inverted	DD1
Idle level	Normal	DE0
	Inverted	DE1
Minimum output pulse	200µs	DG0
	400µs	DG1
	600µs	DG2
	800µs	DG3
	1 ms	DG4
	1.2 ms	DG5
Overflow	Narrow overflow	DH0
	Medium overflow	DH1
	Wide overflow	DH2

CRADLE OPERATING PARAMETERS		
DESCRIPTION		STRING
Headers	No header	EA00
	One character	EA01x
	Two characters	EA02xx
	Three characters	EA03xxx
	Four characters	EA04xxxx
Terminators	No terminator	EA10
	One character	EA11x
	Two characters	EA12xx
	Three characters	EA13xxx
	Four characters	EA14xxxx
Address stamping	Gun Address stamping enabled	HU1
	Gun Address stamping disabled	HU0
	Cradle Address stamping enabled	HU3
	Cradle Address stamping disabled	HU2
Address delimiter	Gun Address delimiter select	HV1y
	Gun Address delimiter disabled	HV0
	Cradle Address delimiter select	HY1y
	Cradle Address delimiter disabled	HY0

x = a HEX value representing the ASCII character.

For RS232 from 00 to 7F Hex

For WEDGE from 00 to 9A Hex

y = a HEX value in the range from 00 to FE representing the ASCII character.

BATTERY CHARGING		
DESCRIPTION		STRING
OM6010-R Battery selection	Autodetect	HT0
	Alkaline battery	HT1
	Li-Ion battery	HT2
	NiMh or NiCd battery	HT3

MULTIDROP NETWORK PARAMETERS		
DESCRIPTION		STRING
Echelon fieldbus	Disabled	HW0
	Slave	HW1
	Master	HW2

Gun Parameters

GUN OPERATING PARAMETERS		
DESCRIPTION		STRING
Code Identifier	Disabled	EB0
	Datalogic standard	EB1
	AIM standard	EB2
Time Stamping Format	Disabled	HL0
	Hour/minutes/seconds/month/day/year	HL1
	Hour/minutes/seconds/day/month/year	HL2
	Hour/minutes/seconds	HL3
	Month/day/year	HL4
	Day/month/year	HL5
Time Stamping Delimiter	Disabled	HM0
	Select delimiter	HM1x
Radio Timeout	Tout (range is 000 to 255)	HH000-HH255
Set Time		HDhmm
Set Date		HEddmmy

x = a HEX value in the range from 00 to FE representing the ASCII character.

hmm, ddmmy = ASCII numbers.

READING PARAMETERS		
DESCRIPTION		STRING
Trigger Signal	Level	BA0
	Pulse	BA1
Trigger Timeout		BD00 - BD99
Reads Per Cycle	One read	BC0
	Multiple reads	BC1
Safety Time		BE00 - BE99
Single-Store	Disabled	HO2
	Enabled	HO3
Power-Off Timeout		HPxx
Beeper Intensity	Beeper off	BG0
	Low intensity	BG1
	Medium intensity	BG2
	High intensity	BG3
Beeper Tone	Tone 1	BH0
	Tone 2	BH1
	Tone 3	BH2
	Tone 4	BH3
Good Transmission Beep	Disabled	HO0
	Enabled	HO1

xx = ASCII numbers in the range 00 - 99.

DECODING PARAMETERS		
DESCRIPTION		STRING
Ink-Spread	Disabled	AX0
	Enabled	AX1
Overflow Control	Disabled	AW1
	Enabled	AW0
Interdigit Control	Disabled	AV0
	Enabled	AV1

GUN DISPLAY PARAMETERS		
DESCRIPTION		STRING
Display Font Size	Small	HA0
	Medium	HA1
	Large	HA2
Display Timeout		HB00-HB99
Display Backlight	Disabled	HC0
	Enabled	HC3
Display Contrast	Lighter	HO7
	Darker	HO6
Display Mode	Normal	HJ0
	Local Echo	HJ1
	Clear display after decode	HJ2
Keypad Setting	Disabled keypad	HK0
	Key Identifier	HK1xxyyzz

- xx = left-key Identifier
- yy = center-key Identifier
- zz = right-key Identifier

xyyyzz are hexadecimal values representing ASCII characters in the range00-FE.
 FF = Key Identifier disabled.

CODE SELECTION			
DESCRIPTION		STRING	
Disable ALL family codes		AZ0	
EAN/UPC	Disable EAN/UPC family		
	EAN 8	AA2	
	EAN 13	AA9	
	UPC A	AAF	
	UPC E	AAE	
	EAN 8/EAN 13/UPC A/UPC E	without ADD ON	AA1
		with ADD ON	AA5
		with and without ADD ON	AA8
	EAN 8/EAN 13	without ADD ON	AA3
		with ADD ON	AA6
	UPC A/UPC E	without ADD ON	AA4
		with ADD ON	AA7
	EAN 8 check digit transmission	disabled	AAG0
		enabled	AAG1
	EAN 13 check digit transmission	disabled	AAH0
		enabled	AAH1
	UPC A check digit transmission	disabled	AAI0
		enabled	AAI1
	UPC E check digit transmission	disabled	AAJ0
		enabled	AAJ1
Conversions	UPC E to UPC A	AAA	
	UPC E to EAN 13	AAB	
	UPC A to EAN 13	AAC	
	EAN 8 to EAN 13	AAD	
Code 39	Disable Code 39 family		
	Standard	no check digit control	AB11
		check digit control and transmission	AB12
		check digit control without transmission	AB13
	Full ASCII	no check digit control	AB21
		check digit control and transmission	AB22
		check digit control without transmission	AB23
	CIP/39		AB3
Code 32		AB4	
Code length (<i>max</i> 32)		AB* xxxx	

CODE SELECTION (continued)			
DESCRIPTION		STRING	
2/5	Disable Code 2/5 family		AC0
	Interleaved 2/5 (max code length 55)	no check digit control	AC11xxxx
		check digit control and transmission	AC12xxxx
		check digit control without transmission	AC13xxxx
	Normal 2/5 5 bars (max code length 55)	no check digit control	AC21xxxx
		check digit control and transmission	AC22xxxx
		check digit control without transmission	AC23xxxx
	Industrial 2/5 (IATA) (max code length 55)	no check digit control	AC31xxxx
		check digit control and transmission	AC32xxxx
		check digit control without transmission	AC33xxxx
	Matrix 2/5 3 bars (max code length 55)	no check digit control	AC41xxxx
check digit control and transmission		AC42xxxx	
check digit control without transmission		AC43xxxx	
	CIP/HR	AC5	
Codabar	Disable Codabar family		AD0
	Standard	no start/stop character equality control nor transmission	AD111
		no start/stop character equality control but transmission	AD112
		start/stop character equality control but no transmission	AD121
		start/stop character equality control and transmission	AD122
	ABC CODABAR	no start/stop character equality control but transmission	AD212
	Code length (max 44)		AD*xxxx
Code 128	Disable Code 128 family		AI0
	Code 128		AI11
	EAN 128		AI21
Code 93	Disable Code 93 family		AK0
	control without transmission of check digit		AK1

xxxx = ASCII numbers that define the code length where:

- First 2 digits = minimum acceptable code length.
- Second 2 digits = maximum acceptable code length.

The minimum code length must always be less than or equal to the maximum.

Examples

- 0132 = variable length from 1 to 32 digits in the code.
- 1010 = 10 digit code length only.

APPENDIX B C6010 CONFIGURATION

It is possible to configure the C6010 battery type to charge through any DLL6000-R gun.

1. Read one of the following labels:



The green LED will light, signaling the gun has accepted the command.

2. Insert the gun in the cradle. The LED turns off and a short beep is emitted.

APPENDIX C HEX AND NUMERIC TABLES

**OPEN THIS PAGE TO READ THE DESIRED
HEX AND NUMERIC SELECTIONS**

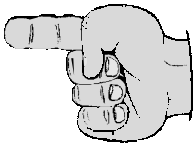

HEX TABLE

CHARACTER TO HEX CONVERSION TABLE					
char	hex	char	hex	char	hex
NUL	00	*	2A	U	55
SOH	01	+	2B	V	56
STX	02	,	2C	W	57
ETX	03	-	2D	X	58
EOT	04	.	2E	Y	59
ENQ	05	/	2F	Z	5A
ACK	06	0	30	[5B
BEL	07	1	31	\	5C
BS	08	2	32]	5D
HT	09	3	33	^	5E
LF	0A	4	34	~	5F
VT	0B	5	35	a	61
FF	0C	6	36	b	62
CR	0D	7	37	c	63
SO	0E	8	38	d	64
SI	0F	9	39	e	65
DLE	10	:	3A	f	66
DC1	11	;	3B	g	67
DC2	12	<	3C	h	68
DC3	13	=	3D	i	69
DC4	14	>	3E	j	6A
NAK	15	?	3F	k	6B
SYN	16	@	40	l	6C
ETB	17	A	41	m	6D
CAN	18	B	42	n	6E
EM	19	C	43	o	6F
SUB	1A	D	44	p	70
ESC	1B	E	45	q	71
FS	1C	F	46	r	72
GS	1D	G	47	s	73
RS	1E	H	48	t	74
US	1F	I	49	u	75
SPACE	20	J	4A	v	76
!	21	K	4B	w	77
"	22	L	4C	x	78
#	23	M	4D	y	79
\$	24	N	4E	z	7A
%	25	O	4F	{	7B
&	26	P	50		7C
'	27	Q	51	}	7D
(28	R	52	~	7E
)	29	S	53	DEL	7F
		T	54		



0



2



4



6



8



A



C



E



1



3



5



7



9



B



D



F

Backspace



Cancels an incomplete configuration sequence