

FRONT PANEL

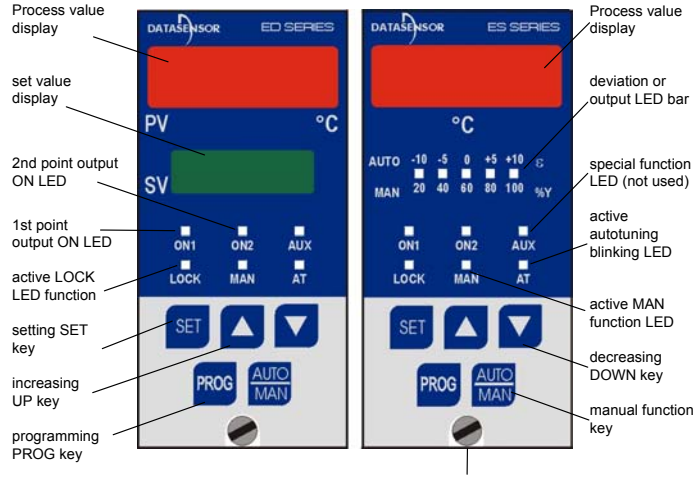

TECHNICAL DATA

Power supply:	version 12 ... 24 Vdc/Vac ± 10%, 50/60 Hz; or version 80 ... 240 Vac ± 10%, 50/60 Hz.
Power consumption:	5VA max.
Sensor input:	thermocouple type J, K, E, T, R, S, L; with reference junction compensation; RTD Pt100 Ω/0 °C according to standard DIN43760; with 2 or 3 wires connection.
Measurement precision *:	RTD ± 0.3% fs, TC ± 0.4% fs, ± 1 digit; (tc-r, tc-S ± 1% fs from 0 to 200°C) temperature drift 0.01% fs/°C of Tamb.
1st point control action:	automatic direct or reverse, ON/OFF or PID with autotuning; manual with output setting from 0 to 100%.
1st point output:	relay version SPDT 250 Vac, 5 A on resistive load; or transistor version with 15 Vdc ± 20%, 20 mA short-circuit protected.
2nd point control action:	ON/OFF with hysteresis ± 0.2 °C, direct or reverse, dead zone on or off, stand-by option; alarm or fixed point.
2nd point output:	relay SPDT 250 Vac, 5 A on resistive load.
Refresh time:	input, output and indication every 500 ms.
Data retention:	non volatile memory type EEPROM.
Insulation resistance:	minimum 20 MΩ at 500 Vdc.
Operating temperature:	-10 ... +55 °C.
Storage temperature:	-20 ... +65 °C.
Humidity:	35 ... 85% rH non condensing.
Vibration resistance:	0.35 mm amplitude, 10...55 Hz frequency for every axis (EN60068-2-6)
Shock resistance:	18 ms (30 G) for every axis (EN60068-2-27)
Housing:	ABS
Mechanical protection:	IP50 front panel, IP20 case, IP00 contacts
Connection leads:	screw terminals for cables up to 2.5 mm ² .
Dimensions:	1/8 DIN; 48x96x125 mm
Weight:	400 g.

* Radiated radio-frequency electromagnetic fields (see ENV 50140), or conducted disturbances induced by radio-frequency fields (see ENV 50141), can be the cause of process value variations in any case not higher than ± 2 % fs.

DECLARATION OF CONFORMITY
We DATASENSOR S.p.A. declare under our sole responsibility that these products are conform to the 2004/108/CE, 2006/95/CE Directives and successive amendments.



DATASENSOR S.p.A. Via Lavino 265
40050 Monte S. Pietro - Bologna - Italy
Tel: +39 051 6765611 Fax: +39 051 6759324
http://www.datasensor.com e-mail: info@datasensor.com

WARRANTY
DATASENSOR S.p.A. warrants its products to be free from defects. DATASENSOR S.p.A. will repair or replace, free of charge, any product found to be defective during the warranty period of 36 months from the manufacturing date. This warranty does not cover damage or liability deriving from the improper application of DATASENSOR products.

STANDARD CONFIGURATION

Settings: 1st pt.=0 °C; 2nd pt.=10 °C.
Autotuning: AtOF = not active.
1st point action: automatic Pidd max. action.
PID values: P=20 °C; I=120 s.; D=30 s.
Cycle time: 20 s. relay vers.; 12 s. transistor vers.
Adt function: Adt0 = not active.
2nd point action.: AL21 = alarm minimum action.
Sensor: tc-J = thermocouple type J.
Scale and unity: -50...+760 °C, without digital filter.
Correction: 0.0 °C
LFA function: LFA0 = not active.
LOCK level: LOC3 = levels 1 and 2 free, level 3 locked.

CONNECTIONS

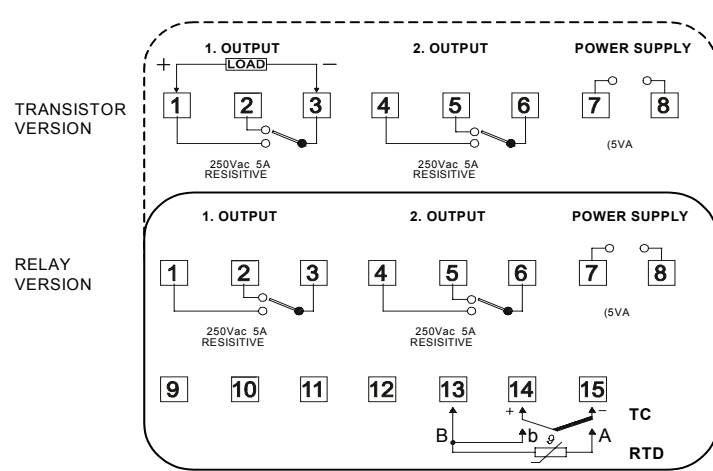

Power supply input:
do not supply the temperature controller directly through power lines and avoid installing near electric motors or other sources of electrical disturbance.

Resistance thermometer input (RTD):
ensure all conductors used to attach the resistance thermometer are alike and with a resistance less than 4 ohms/each; when using a 2 wire resistance thermometer, link terminals 13 and 14 together.

Thermocouple input (TC):
connect the sensor using the correct compensated extension cable for the utilized thermocouple.

Relay output:
in case of connected inductive loads, the maximum current permitted through the contacts decreases in relation to the power factor.

Transistor output:
when the output is high, the ON1 LED lights, the terminals 1 (+) and 3 (-) have a rating of 15 Vdc 20 mA, protected and suitable to drive a Solid State Relay (SSR), recommended in case of high currents or frequent switching.

DIMENSIONS AND INSTALLATION

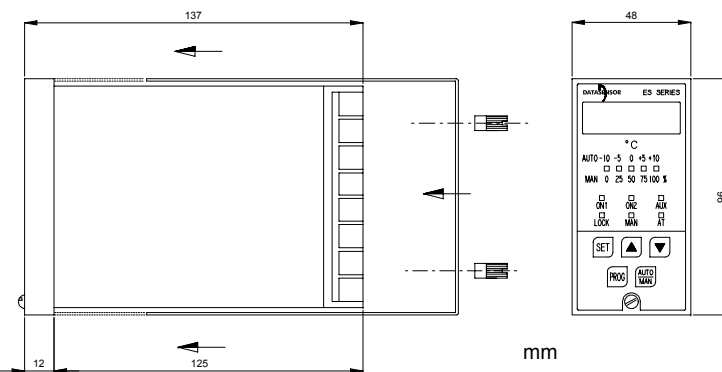

Panel cut-out: 45.5x91 mm
Panel thickness (suggested): 1 ... 4 mm
Insert the controller from panel front face, fix the metallic bracket on the rear of the controller with the proper nuts.

VIEWING AND SETTING OF THE 1st SET POINT

1st configuration level
To view the set point in the single display version, depress the SET key. To modify the set point act directly on the UP/DOWN keys, the new value is updated automatically when the indication UPDT appears or the SET key is pressed. By keeping the UP or DOWN keys depressed, the value will change at first slowly and then quickly. During the setting operations, regulation continues with the last stored value. The setting is locked if the option LOC1 is selected and the LOCK LED is lit up.

MANUAL REGULATION OF THE OUTPUT POWER

To change from automatic regulation (closed loop) to manual (open loop), keep the AUTO/MAN key depressed until the MAN LED turns on. The output power is at zero, make the 1st point setting operations to set the value from M0 to M100%. The regulator maintains the set value if switched off in manual regulation. To return to automatic regulation, keep the AUTO/MAN key depressed until the MAN LED turns off.

VIEWING AND SETTING OF THE 2nd SET POINT

2nd and 3rd configuration levels (see the diagram on the right)
To enter the 2nd and 3rd configuration levels, keep the PROG key depressed for more than 2 seconds. To change the values or the selections, use the UP/DOWN keys. To confirm and continue the configuration, depress the PROG key; to confirm and exit, depress the SET key. At the end of each level [End2] or [End3], you can repeat it by depressing the PROG key for less than 2 seconds or you can change the level by depressing the PROG key for more than 2 seconds. During the program scrolling the regulation continues, but it stops when a modification occurs. The setting exits automatically if no key is depressed within 30 seconds.

PROGRAMMING NOTES

- in case of second point with dead zone, the indication [2 LO] will appear followed by the lower limit value, then [2 HI] followed by the higher limit value; the autotuning selection will appear only in case of PID control action.
- in case of relay 1st point output, a minimum cycle time of 20 seconds [t 20] is recommended.
- adaptive function to improve the response to frequent or fast variations of the load, i.e. start and stop process.
- settings not included in the sensor scale or in the setting limits, are automatically corrected with the nearest threshold limit value.
- in case of Fahrenheit degrees selection, please cover the °C symbol on the front panel with the label °F which is supplied with the controller.

ALARM	FIXED POINT	2ND POINT CONTROL ACTION
AL20	FP20	Output blocked with relay off
AL21	FP21	Minimum action
AL22	FP22	Maximum action
AL23	FP23	Dead zone on
AL24	FP24	Dead zone off
AL25	FP25	Minimum action with stand-by
AL26	FP26	Maximum action with stand-by
AL27	FP27	Dead zone on with stand-by
AL28	FP28	Dead zone off with stand-by

■ In this area the relay contact is closed.
■ In this area the relay contact is closed when the alarm set-point or fixed point is passed for the second time.

Table 1

CODE	SENSOR	°C SCALE	°F SCALE
r t l	RTD Pt100 ohm/0°C	int.	-150 ... 450
r t d	RTD Pt100 ohm/0°C	dec.	-99.9 ... 450.0
t c S	TC Pt10%Rh-Pt,	type S	0 ... 1700
t c r	TC Pt13%Rh-Pt,	type R	0 ... 1700
t c t	TC Cu-CuNi,	type T	-100 ... 400
t c E	TC NiCr-CuNi,	type E	0 ... 600
t c C	TC NiCr-NiAl,	type K	-100 ... 1250
t c J	TC Fe-Cuni,	type J	-50 ... 760
t c L	TC Fe-Cuni,	type L	-50 ... 760

Table 2

ERROR AND TEST MESSAGES

UnFL	Underflow, indication below the sensor range. Short circuit of the sensor RTD Pt100 or interruption of the compensation connection.
OvFL	Overflow, indication over the sensor range. RTD Pt100 or TC sensor broken or interruption of the main connection.
8888	Au...-test, if the message remains fixed the controller must be repaired.
FAIL	General failure; the controller must be repaired.
LFA1	LFA: DETECTION OF FAULTS IN THE REGULATION LOOP Loop Fault Alert: with the 1st point output 100% ON state the measured temperature is not changed according ... the control action within the s...red integral time; a fault in the regulation loop is possible: wrong configuration, lack of power, heater or cooler broken, thermocouple short-circuited or polarity reversed, etc. ... reset the LFA function, please modify the configuration or the set-point, or switch the temperature controller off and then on again. The function LFA is not active in the following cases: with output lower than 100% ON, with integral time at zero, during the au...tuning, in manual position.
LFA2	

NOTE: In case of OvFL, UnFL, 8888, FAIL, LFA2, the first point output is turned off.

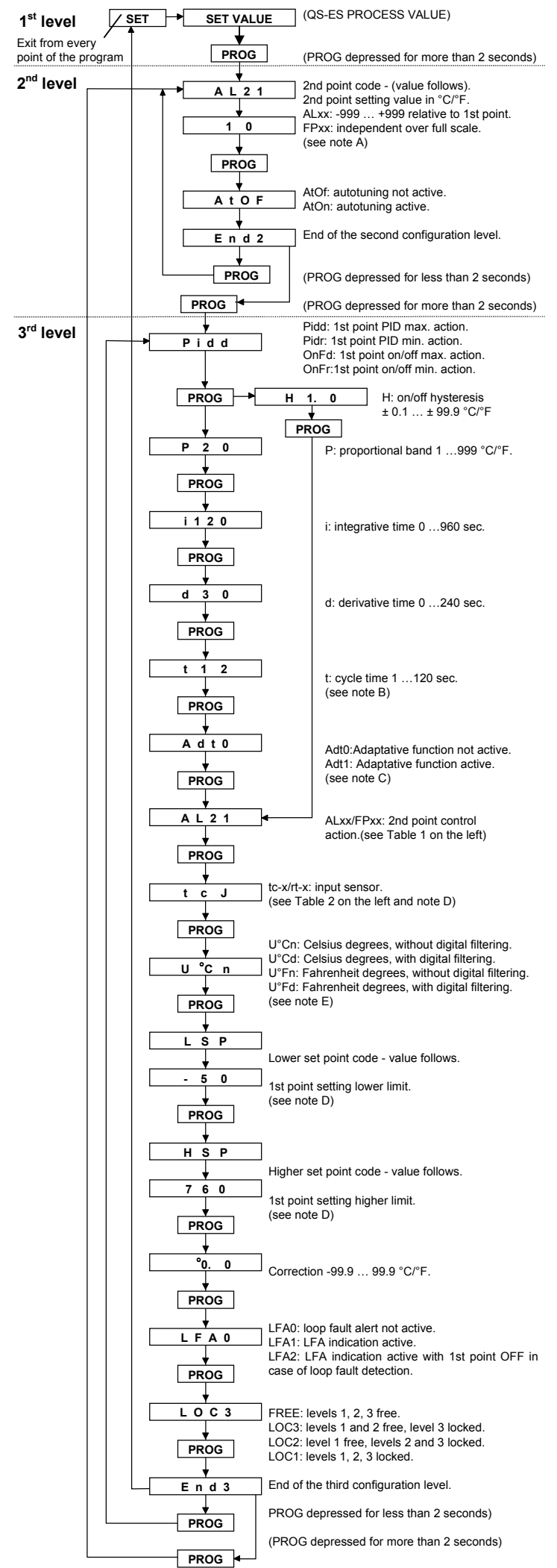

FRONT PANEL

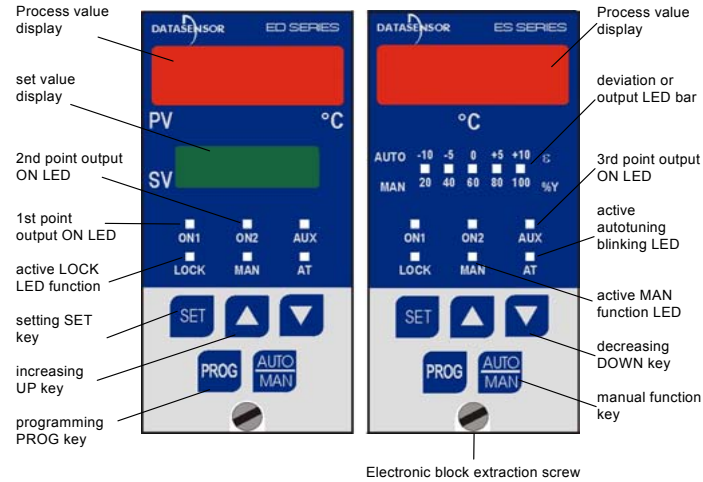

Electronic block extraction screw

TECHNICAL DATA

Power supply: version 12 ... 24 Vdc/Vac ± 10%, 50/60 Hz; or version 80 ... 240 Vac ± 10%, 50/60 Hz.

Power consumption: 5VA max.

Sensor input: thermocouple type J, K, E, T, R, S, L; with reference junction compensation; RTD Pt100 Ω/0 °C according to standard DIN43760; with 2 or 3 wires connection.

Measurement precision *: RTD ± 0.3% fs, TC ± 0.4% fs, ±1 digit; (tc-r, tc-S ± 1% fs from 0 to 200°C) temperature drift 0.01% fs/°C of Tamb.

1st point control action: automatic direct or reverse, ON/OFF or PID with autotuning; manual with output setting from 0 to 100%.

1st point output: relay version SPDT 250 Vac, 5 A on resistive load; or transistor version with 15 Vdc ± 20%, 20 mA short-circuit protected.

2nd point control action: ON/OFF with hysteresis ± 0.2 °C, direct or reverse, dead zone on or off, stand-by option; alarm or fixed point.

2nd point output: relay SPDT 250 Vac, 5 A on resistive load.

3rd point control action: ON/OFF with hysteresis ± 0.2 °C, direct or reverse, dead zone on or off, stand-by option; alarm or fixed point.

3rd point output: relay SPST 250 Vac, 5 A on resistive load.

Refresh time: input, output and indication every 500 ms.

Data retention: non volatile memory type EEPROM.

Insulation resistance: minimum 20 MΩ at 500 Vdc.

Operating temperature: from -10 ... +55 °C.

Storage temperature: from -20 ... +65 °C.

Humidity: from 35 ... 85% rH non condensing.

Vibration resistance: 0.35 mm amplitude, 10...55 Hz frequency for every axis (EN60068-2-6)

Shock resistance: 18 ms (30 G) for every axis (EN60068-2-27)

Housing: ABS

Mechanical protection: IP50 front panel, IP20 case, IP00 contacts

Connection leads: screw terminals for cables up to 2.5 mm².

Dimensions: 1/8 DIN; 48 x 96 x 125 mm

Weight: 400 g.

* Radiated radio-frequency electromagnetic fields (see ENV 50140), or conducted disturbances induced by radio-frequency fields (see ENV 50141), can be the cause of process value variations in any case not higher than ± 2 % fs.

DECLARATION OF CONFORMITY
We DATASENSOR S.p.A. declare under our sole responsibility that these products are conform to the 2004/108/CE, 2006/95/CE Directives and successive amendments.



DATASENSOR S.p.A. Via Lavino 265
40050 Monte S. Pietro - Bologna - Italy
Tel: +39 051 6765611 Fax: +39 051 6759324
http://www.datasensor.com e-mail: info@datasensor.com

DATASENSOR S.p.A. cares for the environment: 100% recycled paper.
DATASENSOR S.p.A. reserves the right to make modifications and improvements without prior notification.

STANDARD CONFIGURATION

Settings: 1st pt.=0 °C; 2nd pt.=10 °C; 3rd pt.=10 °C.
Autotuning: AtOF = not active.
1st point action: automatic Pidd max. action.
PID values: P=20 °C; I=120 s.; D=30 s.
Cycle time: 20 s. relay vers.; 12 s. transistor vers.
Adt function: Adt0 = not active.
2nd point action.: AL21 = alarm minimum action.
3rd point action.: AL31 = alarm minimum action.
Sensor: tc-J = thermocouple type J.
Scale and unity: -50 ... +760 °C, without digital filter.
Correction: 0.0 °C
LFA function: LFA0 = not active.
LOCK level: LOC3 = levels 1 and 2 free, level 3 locked.

CONNECTIONS

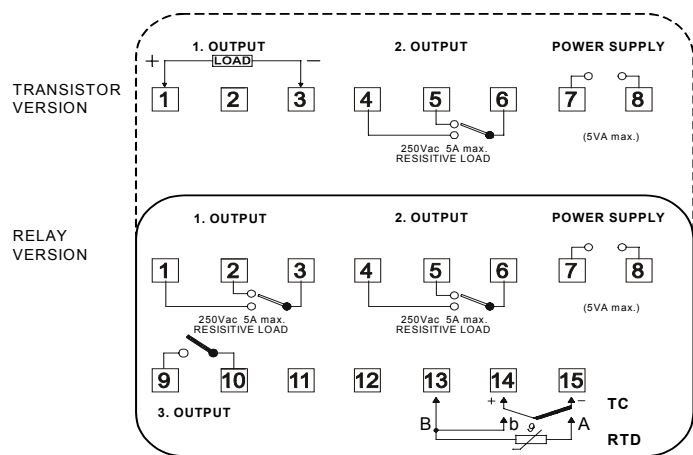

Power supply input: do not supply the temperature controller directly through power lines and avoid installing near electric motors or other sources of electrical disturbance.

Resistance thermometer input (RTD): ensure all conductors used to attach the resistance thermometer are alike and with a resistance less than 4 ohms/each; when using a 2 wire resistance thermometer, link terminals 13 and 14 together.

Thermocouple input (TC): connect the sensor using the correct compensated extension cable for the utilized thermocouple.

Relay output: in case of connected inductive loads, the maximum current permitted through the contacts decreases in relation to the power factor.

Transistor output: when the output is high, the ON1 LED lights, the terminals 1 (+) and 3 (-) have a rating of 15 Vdc 20 mA, protected and suitable to drive a Solid State Relay (SSR), recommended in case of high currents or frequent switching.

DIMENSIONS AND INSTALLATION

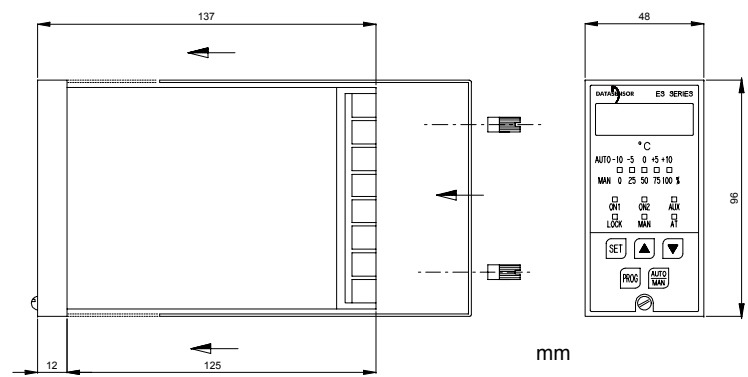

Panel cut-out: 45.5 x 91 mm
 Panel thickness (suggested): 1 ... 4 mm
 Insert the controller from panel front face, fix the metallic bracket on the rear of the controller with the proper nuts.

WARRANTY
DATASENSOR S.p.A. warrants its products to be free from defects. DATASENSOR S.p.A. will repair or replace, free of charge, any product found to be defective during the warranty period of 36 months from the manufacturing date. This warranty does not cover damage or liability deriving from the improper application of DATASENSOR products.

VIEWING AND SETTING OF THE 1st SET POINT

1st configuration level
To view the set point in the single display version, depress the SET key. To modify the set point act directly on the UP/DOWN keys, the new value is updated automatically when the indication UPDT appears or the SET key is pressed. By keeping the UP or DOWN keys depressed, the value will change at first slowly and then quickly. During the setting operations, regulation continues with the last stored value. The setting is locked if the option LOC1 is selected and the LOCK LED is lit up.

MANUAL REGULATION OF THE OUTPUT POWER
To change from automatic regulation (closed loop) to manual (open loop), keep the AUTO/MAN key depressed until the MAN LED turns on. The output power is at zero, make the 1st point setting operations to set the value from M0 to M100%. The regulator maintains the set value if switched off in manual regulation. To return to automatic regulation, keep the AUTO/MAN key depressed until the MAN LED turns off.

VIEWING AND SETTING OF THE 2nd AND 3rd SET POINTS

2nd and 3rd configuration levels (see the diagram on the right)
To enter the 2nd and 3rd configuration levels, keep the PROG key depressed for more than 2 seconds. To change the values or the selections, use the UP/DOWN keys. To confirm and continue the configuration, depress the PROG key; to confirm and exit, depress the SET key. At the end of each level [End2] or [End3], you can repeat it by depressing the PROG key for less than 2 seconds or you can change the level by depressing the PROG key for more than 2 seconds. During the program scrolling the regulation continues, but it stops when a modification occurs. The setting exits automatically if no key is depressed within 30 seconds.

- PROGRAMMING NOTES**
- A) in case of second point with dead zone, the indication [2 LO] will appear followed by the lower limit value, then [2 HI] followed by the higher limit value.
 - B) in case of third point with dead zone, the indication [3 LO] will appear followed by the lower limit value, then [3 HI] followed by the higher limit value; the autotuning selection will appear only in case of PID control action.
 - C) in case of relay 1st point output, a minimum cycle time of 20 seconds [t 20] is recommended.
 - D) adaptive function to improve the response to frequent or fast variations of the load, i.e. start and stop process.
 - E) settings not included in the sensor scale or in the setting limits, are automatically corrected with the nearest threshold limit value.
 - F) in case of Fahrenheit degrees selection, please cover the °C symbol on the front panel with the label °F which is supplied with the controller.

ALARM	FIXED POINT		2ND, 3RD POINT CONTROL ACTION
AL20 / AL30	FP20 / FP30	[Symbol]	Output blocked with relay off
AL21 / AL31	FP21 / FP31	[Symbol]	Minimum action
AL22 / AL32	FP22 / FP32	[Symbol]	Maximum action
AL23 / AL33	FP23 / FP32	[Symbol]	Dead zone on
AL24 / AL34	FP24 / FP34	[Symbol]	Dead zone off
AL25 / AL35	FP25 / FP35	[Symbol]	Minimum action with stand-by
AL26 / AL36	FP26 / FP36	[Symbol]	Maximum action with stand-by
AL27 / AL37	FP27 / FP37	[Symbol]	Dead zone on with stand-by
AL28 / AL38	FP28 / FP38	[Symbol]	Dead zone off with stand-by

[Symbol] In this area the relay contact is closed.
 [Symbol] In this area the relay contact is closed when the alarm set-point or fixed point is passed for the second time.

Table 1

CODE	SENSOR		°C SCALE	°F SCALE
rt I	RTD Pt100 ohm/0°C	int.	-150 ... 450	-200 ... 850
rt d	RTD Pt100 ohm/0°C	dec.	-99.9 ... 450.0	-99.9 ... 850.0
tc S	TC Pt10%Rh-Pt,	type S	0 ... 1700	30 ... 3000
tc r	TC Pt13%Rh-Pt,	type R	0 ... 1700	30 ... 3000
tc t	TC Cu-CuNi,	type T	-100 ... 400	-150 ... 750
tc E	TC NiCr-CuNi,	type E	0 ... 600	0 ... 1100
tc C	TC NiCr-NiAl,	type K	-100 ... 1250	-150 ... 2300
tc J	TC Fe-Cuni,	type J	-50 ... 760	-50 ... 1400
tc L	TC Fe-Cuni,	type L	-50 ... 760	-50 ... 1400

Table 2

ERROR AND TEST MESSAGES

- UnFL** Underflow, indication below the sensor range. Short circuit of the sensor RTD Pt100 or interruption of the compensation connection.
- OvFL** Overflow, indication over the sensor range. RTD Pt100 or TC sensor broken or interruption of the main connection.
- 8888** Au...-test, if the message remains fixed the controller must be repaired.
- FAIL** General failure; the controller must be repaired.
- LFA1** LFA: DETECTION OF FAULTS IN THE REGULATION LOOP
Loop Fault Alert: with the 1st point output 100% ON state the measured temperature is not changed according ... the control action within the s...red integral time; a fault in the regulation loop is possible: wrong configuration, lack of power, heater or cooler broken, thermocouple short-circuited or polarity reversed, etc. ... reset the LFA function, please modify the configuration or the set-point, or switch the temperature controller off and then on again. The function LFA is not active in the following cases: with output lower than 100% ON, with integral time at zero, during the au...tuning, in manual position.
- LFA2**

NOTE: In case of OvFL, UnFL, 8888, FAIL, LFA2, the first point output is turned off.

