

**Bar Code  
and  
Magnetic Stripe Reader**

**Models 2000/2002**

**USER'S MANUAL**



2190 Regal Parkway  
Euless, TX 76040  
(817)571-9015  
**(800)648-4452**  
FAX (817)685-6232

## FCC NOTICE

WARNING: This equipment generates, uses and can radiate radio frequency energy and if not installed and used in accordance with the instruction manual, may cause interference to radio communications. It has been tested and found to comply with the limits for a Class A computing device pursuant to Subpart J of Part 15 FCC Rules, which are designed to provide reasonable protection against such interference when operated in a commercial environment. Operation of this equipment in a residential area is likely to cause interference in which case the user at his own expense will be required to take whatever measures may be required to correct the interference.

# TABLE OF CONTENTS

Introduction .....	1
Installation Instructions .....	2
Scanning Bar Codes .....	7
Wand Scanning .....	7
Scanning With Trigger Type Lasers .....	8
Installing and Using the MS941 Triggerless Laser .....	10
CCD Scanning .....	16
Slot Reader (Badge Reader) .....	17
Scanning Magnetic Stripes/Cards .....	18
Default Settings .....	19
Changing the Default Settings .....	21
Programming Guide .....	23
Code 39 .....	24
UPC .....	25
EAN .....	26
UPC/EAN Supplements .....	27
Interleaved 2 of 5 .....	28
Codabar .....	29
Code 128 .....	29
Code 93 .....	30
Code 11 .....	30
MSI/Plessey .....	31
Serial Port .....	32
Baud Rate .....	34
Parity .....	34
Data Bits .....	34
Preambles .....	35
Postambles .....	36
Termination Character .....	37
Beep Length & Tone .....	37
Mag Stripe Options #1 .....	38
Mag Stripe Options #2 .....	40
Computer Type .....	42
Transmit Speed .....	42
Bar Code Edit .....	43
Options #1 .....	44
Options #2 .....	46
Diagnostics .....	48

## TABLE OF CONTENTS (Cont)

Cloning Setup Information .....	49
Cloning From Computer to Reader .....	49
Cloning From Reader to Reader .....	51
RS-232C Serial Port .....	52
Connecting an Electronic Scale to the Bar Code Reader .....	52
Specifications .....	54
Signal Definitions .....	55
Appendix A - Function & Special Keys .....	A-1
Appendix B - External Power Supply Requirements .....	B-1
Appendix C - Code 39 Specifications .....	C-1
Appendix D - Full ASCII Extension to Code 39 .....	D-1
Appendix E - UPC Specifications .....	E-1
Appendix F - EAN Specifications .....	F-1
Appendix G - Interleaved 2 of 5 Specifications .....	G-1
Appendix H - Codabar Specifications .....	H-1
Appendix I - Code 128 Specifications .....	I-1
Appendix J - Code 93 Specifications .....	J-1
Appendix K - Card Data Format for Transaction Cards .....	K-1
Appendix L - Sources of Bar Code and Magnetic Stripe Standards .....	L-1

# INTRODUCTION

The Model 2000/2002 bar code and magnetic stripe reader combines features found in a variety of readers into one compact, easy to use system. The reader installs quickly between the keyboard and personal computer. Data is sent to the computer as if it was typed in from the keyboard. No hardware or software changes are necessary.

The reader accepts a wide variety of input devices such as a LASER, CCD, WAND, MAGNETIC STRIPE READER, SLOT READER, and RS-232 SERIAL INPUT. The Model 2000/2002 allows up to four input devices, maximizing the versatility of the reader system.

Tailor the reader to individual applications by simply scanning a bar code from the menu. It's that simple! All these features make the Model 2000/2002 an ideal data collection device that provides quality and performance in one package.

## FEATURES:

Bar Code, Magnetic Stripe, and Serial Data appear as Keyboard Input to the PC.

Reader Automatically Recognizes and Reads the following Bar Code Types:

- Code 39
- Extended Code 39 (Full ASCII)
- Interleaved 2 of 5
- UPC-A, UPC-E(0), UPC-E(1)
- EAN-8, EAN-13
- UPC & EAN Supplements  
(2 and 5 character)
- Codabar
- Code 128
- Code 93
- Code 11
- MSI/Plessey

Power/Ready Light Indicates Scanner Status

Reads Magnetic Stripes (Credit Cards, ID Cards, etc.)

Supports Multiple Input Devices (Laser, CCD, Wand, Slot Reader)

Accepts Data from the RS-232 Input Port (Electronic Scales, Portable Terminals, etc.)

# INSTALLATION INSTRUCTIONS

## OVERVIEW

Installation requires connecting cables between the reader and your computer.

- Step 1: Turn OFF the power to the computer.
- Step 2: Unplug the KEYBOARD cable from the back of the computer and plug it into the connector labeled "KEYBOARD" on the rear panel of the reader.

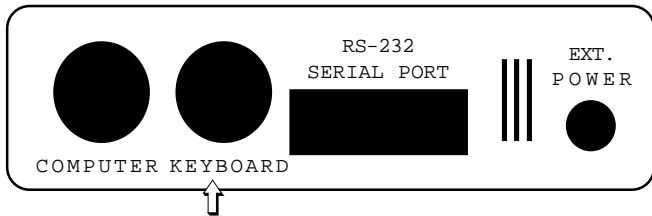

- Step 3: Plug one end of the cable (supplied with the reader) into the connector labeled "COMPUTER" on the rear panel of the reader.

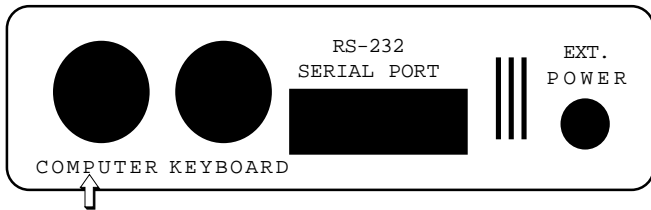

- Step 4: Plug the other end of the cable (supplied with the reader) into the KEYBOARD connector located on the back of your computer.

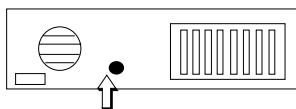

Step 5: CONNECTING INPUT DEVICES:

Installing A Wand

Plug the end of the WAND cable into the circular connector labeled "WAND" on the front panel of the reader.

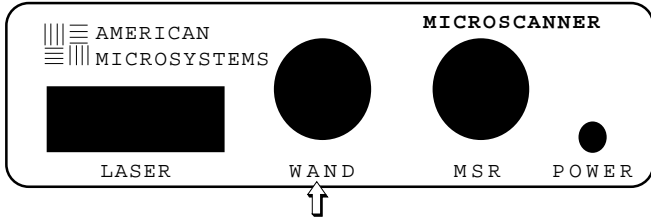

Installing A Laser Scanner

Plug the end of the LASER cable into the square connector labeled "LASER" located on the front panel of the reader.

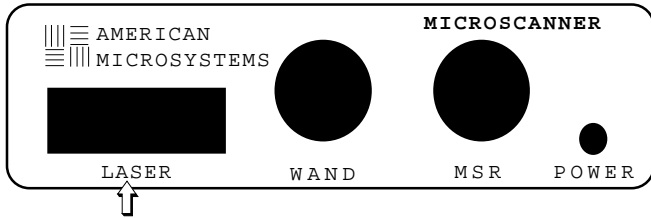

Installing An External Power Supply (If Required)

Plug the external power supply cable into the connector labeled "EXT. POWER" located on the rear panel of the reader.

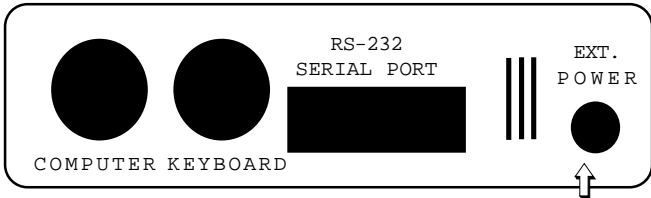

**NOTE:** An external power supply is not required for a 5V LASER. A 12V LASER will require an external power supply. See the APPENDIX at the back of this manual for a description of "External Power Supply Requirements".

### Installing A CCD Scanner

Plug the end of the CCD cable into the connector labeled "LASER" located on the front panel of the reader.

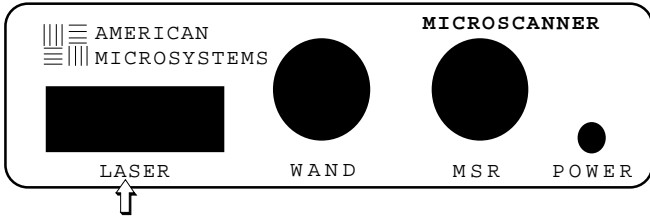

### Installing A Magnetic Stripe Reader

For a MAGNETIC STRIPE READER with an 8 pin DIN connector, plug the connector into the circular connector labeled "MSR" on the front panel of the reader.

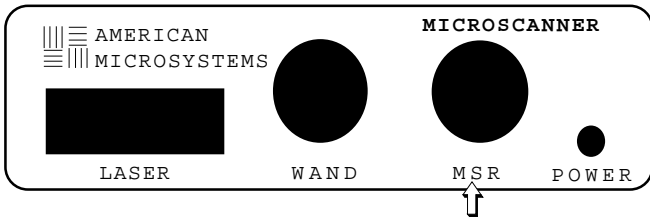

### Installing a Slot Reader (*Badge Reader*)

Plug the end of the SLOT READER cable into the circular connector labeled "WAND" on the front panel of the reader.

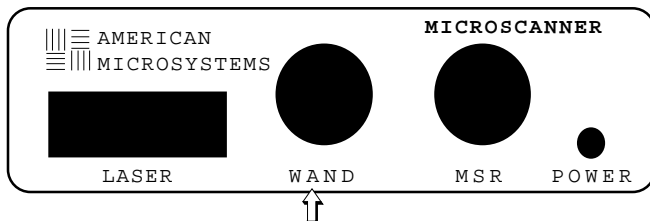



Step 6: Verify that the cables are connected as shown below:

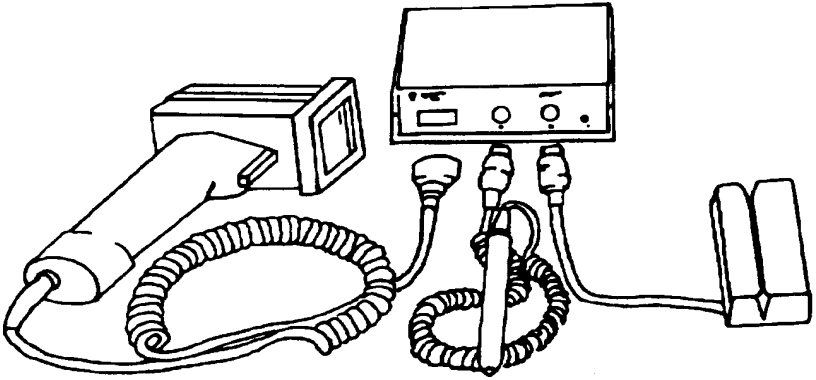

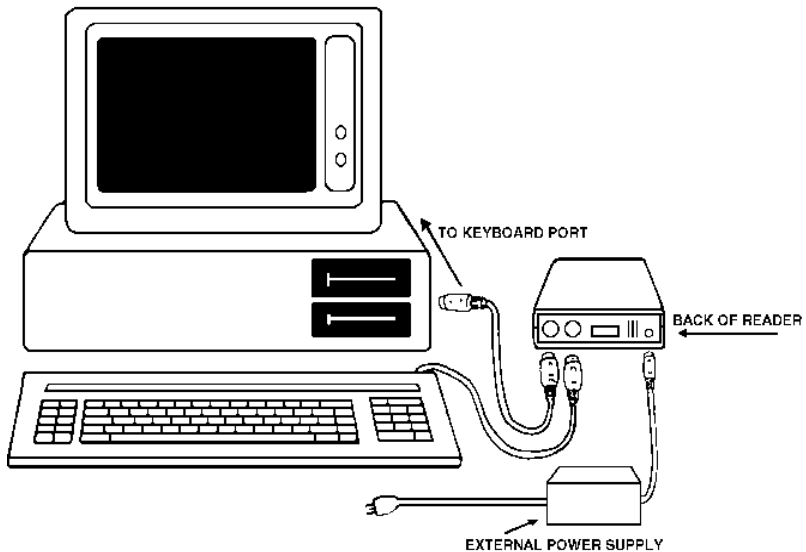

**NOTE:** An external power supply is NOT required for a 5V LASER.

- Step 7: Turn ON the power to the computer. (The reader receives its power from the computer just like the keyboard.)
- Step 8: The "POWER" display light on the front panel of the reader will display RED and the reader will BEEP twice. Approximately 1/2 second later the display will change to GREEN.
- Step 9: The GREEN color indicates the reader is ready to use. The keyboard remains fully functional and you may enter data as before.

# SCANNING BAR CODES

## WAND SCANNING

- Step 1: HOLD THE WAND LIKE A PENCIL, tilted at an angle of 10° to 30° from vertical.
- Step 2: TOUCH the wand tip to the WHITE SPACE before the label.
- Step 3: Move the wand QUICKLY across the label as if you were drawing a straight line through the middle of it.
- Step 4: Begin and end your stroke in the WHITE SPACE. Maintain a smooth, even stroke while scanning. You can read labels bi-directionally (either left-to-right or right-to-left) and the data will output correctly to your computer.
- Step 5: If you scanned the label correctly, you will hear a short BEEP. When the "POWER" light turns GREEN the reader is ready to scan another label.

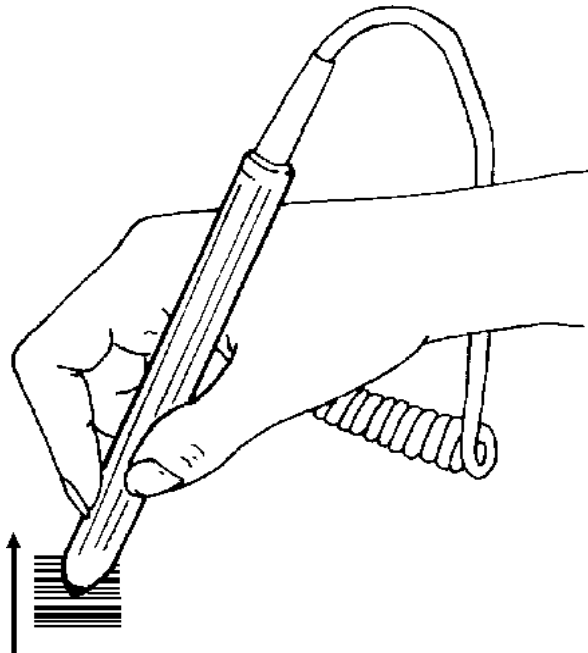

## SCANNING WITH TRIGGER TYPE LASERS

**\*\*CAUTION\*\***

*ALTHOUGH THE LIGHT EMITTED FROM CLASS II AND CLASS IIA LASERS IS NOT CONSIDERED HAZARDOUS, AVOID STARING DIRECTLY INTO THE LIGHT BEAM. EXTENDED EXPOSURE MAY CAUSE DAMAGE TO YOUR EYES.*

Step 1: AIM the LASER at a bar code label. Hold the LASER approximately 3 to 6 inches from the label.

NOTE: The maximum scanning distance depends on the label density. Typical scanning distances vary from 3 to 18 inches.

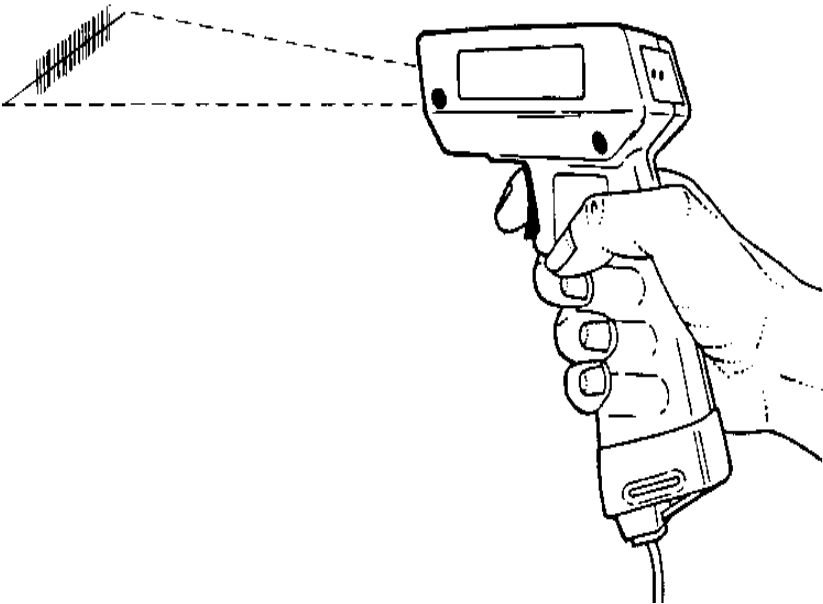

Step 2: SQUEEZE the TRIGGER on the laser. The front panel "POWER" light on the reader will change to RED and the "SCAN" light on the back of the laser will turn on. Simultaneously the laser will emit a thin red beam of light. The beam must cover the entire bar code label and part of the white area on both sides.

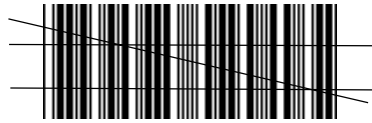

RIGHT

123456



WRONG

123456

Step 3: After a successful read the following will occur:

- The reader will BEEP.
- The "DECODE" light on the back of the laser will turn on.
- The reader will turn off the red beam of light.
- The bar code data is transmitted to the computer.

**NOTE:** If the laser has not read the label within approximately one second, it will turn off the beam. Try moving the laser closer to the bar code label and adjusting the pointing angle.

Step 4: When the front panel "POWER" light changes to GREEN, the reader is ready to scan another label.

**NOTE:** If the LASER/CCD CONTINUOUS RUN option is OFF, the trigger must be released between scans.

# INSTALLING AND USING THE MS941 TRIGGERLESS LASER

## INSTALLATION

After installing the decoder box according to the instructions in the general "Installation Instructions" section, you are ready to connect the laser.

Step 1: Plug the end of the laser's cable into the square connector labeled "LASER" located on the front panel of the reader. See the diagram below:

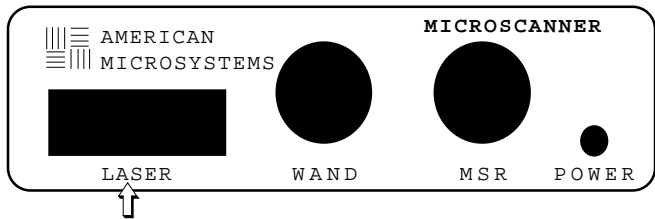

Step 2: For "hands-free" scanning, note the following:

The cradle can be removed from the stand and set on a horizontal surface (on its rubber feet), or mounted directly to a horizontal or vertical surface.

The cradle has magnets which hold the LASER in place.

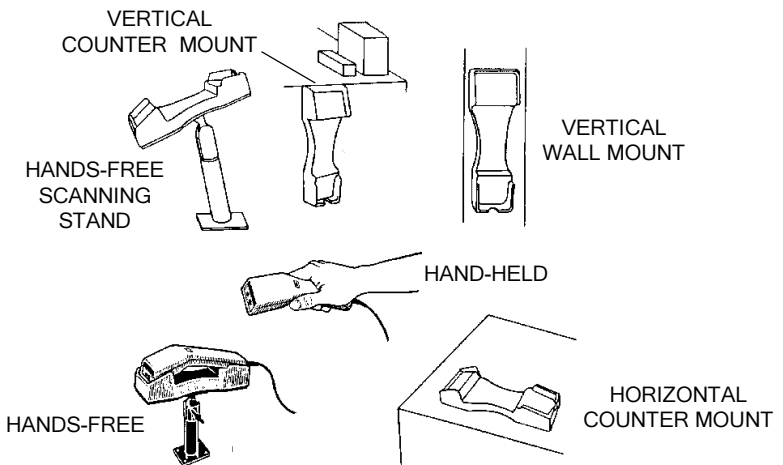

## *SCANNING WITH THE MS941 TRIGGERLESS LASER*

The MS941 is a triggerless laser activated by a bar code or reflective object passing through its beam. It can be set in its cradle for "hands-free" operation, or held in the hand.

See the following steps for scanning instructions:

- Step 1: Point the LASER at a bar code label or, for hands-free scanning, bring the bar code to the laser beam. The distance from the MS941 laser to the bar code should be approximately 1 to 5 inches.

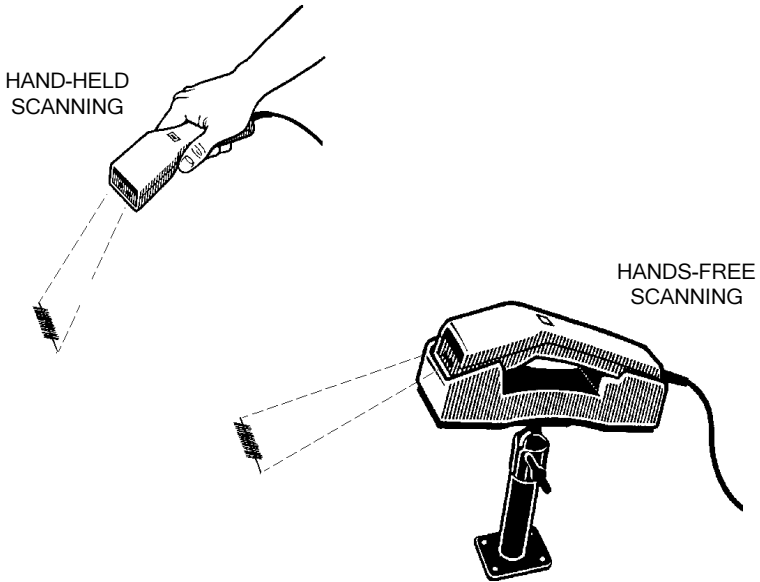

**\*\*CAUTION\*\***

*ALTHOUGH THE LIGHT EMITTED FROM CLASS II LASERS IS NOT CONSIDERED HAZARDOUS, AVOID STARING DIRECTLY INTO THE LIGHT BEAM. EXTENDED EXPOSURE MAY CAUSE DAMAGE TO YOUR EYES.*

Step 2: The laser will begin scanning as soon as the bar code is brought within 5 inches of the front of the laser. The red light on the back of the LASER's handle will stay on as long as it is attempting a read. The laser beam must cover the entire bar code label and part of the blank area on both sides. Examples of bar code scans are shown below:

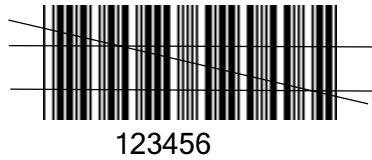

RIGHT



WRONG

Step 3: After a successful read the following will occur:

- The decoder will BEEP.
- The red light on the back of the laser will turn off.
- The green light on the back of the laser will turn on for duration of the decoder's beep.
- The bar code data is transmitted to the computer.



## *SCANNING THE READER SETUP MENU WITH THE MS941 TRIGGERLESS LASER*

In setting up the MS941 laser, using a wand or trigger-activated input device is recommended for scanning the READER SETUP MENU. If you do not have such an input device, you can use the MS941 Laser.

To facilitate using the MS941 in reading the MENU, the following suggestions are provided:

- 1) Curl the READER SETUP MENU from right to left (or the reverse), such that only one column of bar codes is exposed to the laser at a time.  

OR
- 2) Use sheets of paper to cover bar codes adjacent to the one that is to be scanned.

**NOTE:** See the *"Changing the Default Settings"* section for detailed instructions on changing the settings.

## *SETTING UP THE MS941 TRIGGERLESS LASER*

There are three separate modes of operation for the MS941 Laser. Descriptions of the operation and setup of each mode follow:

### *NON-CONTINUOUS SCANNING - DEFAULT MODE*

Recommended Usage:

Recommended for general use. However, this mode requires the laser beam to be removed from any reflective surface between scans.

Operation Description:

The laser will power ON when it is brought to within 5 inches of a reflective surface, and will scan until it reads the bar code, or reaches the time period specified in the LASER/CCD TIMEOUT option (the default is 1 second) before shutting off. For the next scan, the laser must momentarily be pointed away from any reflective surface, then brought back.

RE-READS: Accepts a re-read in the same manner as any other read.

**Settings:**

The following settings, which are the defaults, apply to this mode of operation:

Laser/CCD Timeout	1-9 sec
Laser/CCD Trigger Shutoff	ON
Laser/CCD Continuous Run	OFF

*CONTINUOUS SCANNING - REFLECTIVE SURFACE REQUIRED*

**Recommended Usage:**

Recommended for most applications; a highly efficient mode. Note that it is NOT recommended if the laser is constantly exposed to a reflective surface, such as a white counter top.

**Operation Description:**

The laser will power ON when it is brought within 5 inches of a reflective surface, and will continuously scan and read one bar code after another, until pointed away from any reflective surface. When away from a reflective surface, the laser will continue to scan for the number of seconds specified in the LASER/CCD TIMEOUT option (the default is 1 second) before it shuts off.

**RE-READS:** Accepts a re-read after the amount of time specified in the CONTINUOUS RUN READ DELAY option (the default is 1 second) has passed.

**Settings:**

The following settings apply to this mode of operation:

Laser/CCD Timeout	1-9 sec
Laser/CCD Trigger Shutoff	ON
Laser/CCD Continuous Run	ON
Continuous Run Read Delay	0.1-9.9 sec

For optimum "hands-free" performance, set the LASER/CCD TIMEOUT option at 3-4 seconds.

*CONTINUOUS SCANNING*

*NON-REFLECTIVE SURFACES ACCEPTED, "BLINK" MODE*

Recommended Usage:

Recommended to be especially useful when there are non-reflective or colored scanning surfaces, or when bar code tags are small in size. Note that with this mode, any other bar code input devices that are connected to the decoder box will NOT operate.

Operation Description:

The laser will pulse on and off approximately two times a second. It will stop pulsing and scan continuously whenever it is brought within 5 inches of a bar code, and it will immediately read one bar code after another. When the laser is not exposed to any bar codes, it will continue to scan for the number of seconds specified in the LASER/CCD TIMEOUT option (the default is 1 second) before it resumes pulsing the beam on and off.

RE-READS: Accepts a re-read after the amount of time specified in the CONTINUOUS RUN READ DELAY option (the default is 1 second) has passed.

Settings:

The following settings apply to this mode of operation:

Laser/CCD Timeout	1-9 sec
Laser/CCD Trigger Shutoff	OFF
Laser/CCD Continuous Run	ON
Continuous Run Read Delay	0.1-9.9 sec

For optimum "hands-free" performance, set the LASER/CCD TIMEOUT option at 3-4 seconds.

## CCD SCANNING

- Step 1: Place the CCD scanner on the label or close to it (within one inch). Make sure the bar code label fits completely within the frame of the CCD opening.

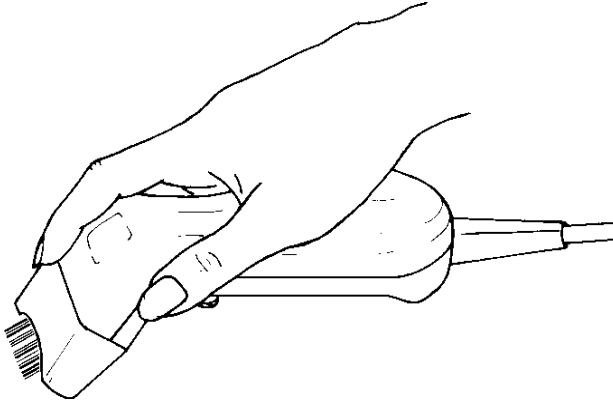

- Step 2: PRESS the button on the CCD scanner. The front panel "POWER" light on the reader will change to RED.
- Step 3: After a successful read the following will occur:
- The reader will BEEP.
  - The reader will turn off the red CCD light.
  - The bar code data is transmitted to the computer.

NOTE: If a read does not occur immediately, try moving the CCD closer to the bar code label and adjusting the pointing angle. If the reader has not read the label within the time period specified in the LASER/CCD TIMEOUT option (the default is 1 second), it will turn off the light beam.

- Step 4: When the front panel "POWER" light changes to GREEN, the reader is ready to scan another label.

NOTE: For triggerless operation, refer to "LASER/CCD CONTINUOUS RUN and LASER/CCD TRIGGER SHUTOFF" options.

## SLOT READER (Badge Reader)

Step 1: Hold the CARD so that the bar code label is on the bottom and FACES the ARROW on the slot reader.

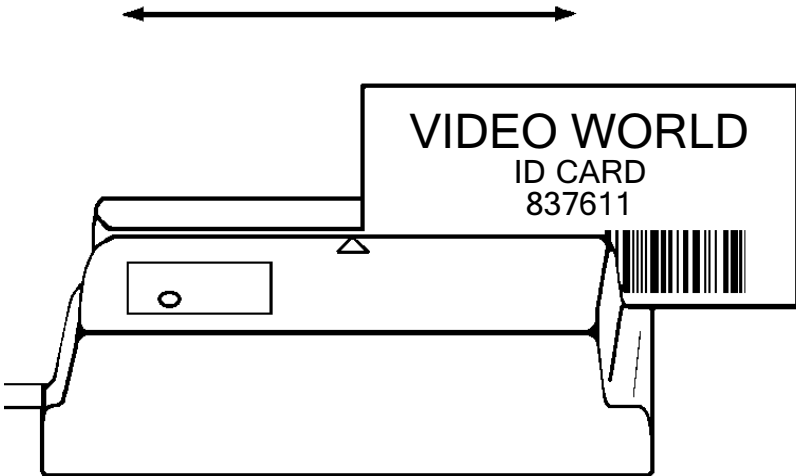

Step 2: Insert the CARD into the opening on either side of the reader.

Step 3: Holding the CARD flat against the bottom of the reader, SLIDE the card through the opening. You can slide the CARD bi-directionally (either left-to-right or right-to-left) and the data will output correctly to your computer. The CARD must maintain contact with the base of the reader while scanning. The front panel "POWER" light will change to RED while the card is being pulled through the SLOT READER.

**NOTE:** The center of the bar code must be positioned 0.5" from the bottom edge of the card.

Step 4: After a successful read the following will occur:

- The decoder will BEEP.
- The bar code data is transmitted to the computer.

Step 5: When the front panel "POWER" light changes to GREEN, the reader is ready to scan another card.

## SCANNING MAGNETIC STRIPES/CARDS

To read a bar code label with a magnetic stripe reader, see the following steps:

Step 1: Hold the CARD so that the magnetic stripe is on the bottom and faces you.

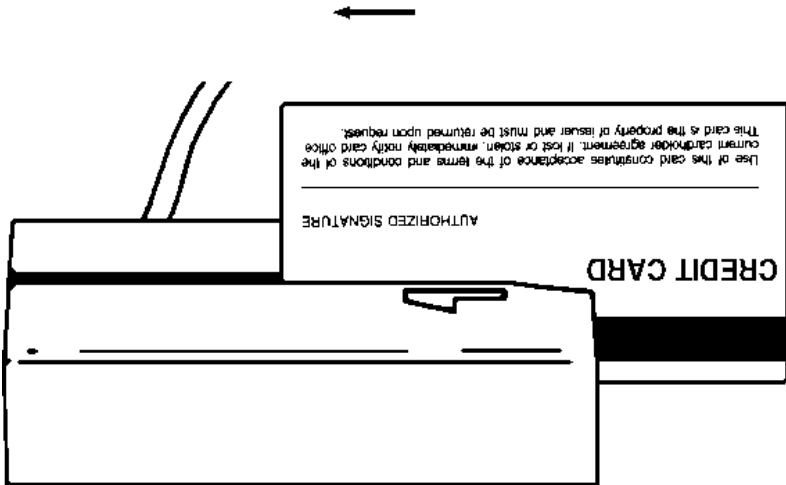

Step 2: Insert the CARD into the enlarged opening.

Step 3: Holding the CARD flat against the bottom of the reader, SLIDE the card in the direction of the arrows. The CARD must maintain contact with the base of the reader while scanning. The front panel "POWER" light on the reader will change to RED while the card is pulled through the reader.

Step 4: After a successful read the following will occur:

- The decoder will BEEP.
- The magnetic stripe data is transmitted to the computer.

Step 5: When the front panel "POWER" light changes to GREEN, the reader is ready to scan another card.

# DEFAULT SETTINGS

The Model 2000/2002 is shipped from the factory with the following default settings:

## CODE 39

CODE 39 DECODER	ON
FULL ASCII	OFF
MOD 43 CHECK DIGIT	OFF
SEND CHECK DIGIT	OFF
CONCATENATE MODE	OFF

## UPC

UPC DECODER	ON
CONVERT UPC-E TO UPC-A	OFF
CONVERT UPC-A TO EAN-13	OFF
SEND UPC-A NUMBER SYSTEM	ON
SEND UPC-E NUMBER SYSTEM	ON
SEND UPC-A CHECK DIGIT	ON
SEND UPC-E CHECK DIGIT	ON

## EAN

EAN DECODER	ON
ZERO FILL EAN-8 TO EAN-13	OFF
SEND EAN-13 COUNTRY CODE	ON
SEND EAN-8 COUNTRY CODE	ON
SEND EAN-13 CHECK DIGIT	ON
SEND EAN-8 CHECK DIGIT	ON
ISBN CONVERSION	OFF

## UPC/EAN SUPPLEMENTS

SUPPLEMENTS DECODER	OFF
ALLOW 2 DIGIT SUPPLEMENTS	ON
ALLOW 5 DIGIT SUPPLEMENTS	ON
REQUIRE SUPPLEMENTS	OFF
SEND SEPARATOR SPACE	

## INT. 2 OF 5

1 2 OF 5 DECODER	ON
CHECK DIGIT	NONE
SEND CHECK DIGIT	OFF
FIXED LENGTH	OFF
SET FIXED LENGTH #1	06
SET FIXED LENGTH #2	00

## CODABAR

CODABAR DECODER	ON
SEND START/STOP	OFF
CLSI FORMATTING	OFF
CLSI CHECK DIGIT	OFF

## CODE 128

CODE 128 DECODER	ON
UCC-128 VERIFICATION	OFF
SEND MOD 10 CHECK DIGIT	ON

## CODE 93

CODE 93 DECODER	ON
CONCATENATE MODE	OFF

## MSI/PLESSEY

MSI/PLESSEY DECODER	OFF
TWO CHECK DIGITS REQUIRED	OFF
FIRST CHECK DIGIT MOD 11	OFF
SEND 1ST CHECK DIGIT	OFF
SEND 2ND CHECK DIGIT	OFF
ISBN PLESSEY	OFF

## CODE 11

CODE 11 DECODER	OFF
TWO CHECK DIGITS REQUIRED	OFF
SEND 1ST CHECK DIGIT	OFF
SEND 2ND CHECK DIGIT	OFF

## SERIAL PORT

MODE	BATCH
PROTOCOL	NONE
RECORD TERMINATOR CHAR	OFF
SEND RECORD TERMINATOR CHAR	OFF
ENTER RECORD TERMINATOR CHAR	CR
TIMEOUT DELAY	0.0 SEC.
ENTER SERIAL COMMAND STRING	NONE
BAUD RATE	9600
PARITY	NONE
DATA BITS	8
READER OUTPUT	KEYBOARD ONLY
SERIAL CONTROL	NONE

## POSTAMBLES

ENTER BAR CODE POSTAMBLE	NONE
ENTER MAG STRIPE POSTAMBLE	NONE
ENTER SERIAL PORT POSTAMBLE	NONE
BAR CODE SEND DELAY	0.0 SEC.
MAG STRIPE SEND DELAY	0.0 SEC.
SERIAL PORT SEND DELAY	0.0 SEC.
ACTIVE	ALL

## MAG STRIPE #1

SEND ACCOUNT NUMBER	ON
SEND NAME (TRACK 1 ONLY)	ON
SEND EXPIRATION DATE	ON
SEND ALL TRACK DATA	ON
ENTER TRK 1 SEP CH	^
FORMAT EXP. DATE MMY	OFF
ENTER TRKS 2&3 SEP CH	=

## COMPUTER TYPE

COMPUTER TYPE	IBM AT
KEYBOARD TYPE	USA
KEYBOARD INSTALLED	ON

## TRANSMIT SPEED

TRANSMIT SPEED	FAST
----------------	------

## OPTIONS # 1

SEND BAR CODE TYPE ID	OFF
DUPLICATE READS ALLOWED	ON
LASER/CCD TIMEOUT	1.0 SEC
LASER/CCD TRIGGER SHUTOFF	ON
LASER/CCD CONTINUOUS RUN	OFF
CONTINUOUS RUN READ DELAY	1.0 SEC
BAR CODE FUNCTION KEYS	OFF
KEYBOARD CAPS LOCK STATUS	ON

## DIAGNOSTICS

DIAGNOSTIC SELF TEST	OFF
KEYBOARD CAPS LOCK STATUS	ON

## PREAMBLES

ENTER BAR CODE PREAMBLE	NONE
ENTER MAG STRIPE PREAMBLE	NONE
ENTER SERIAL PORT PREAMBLE	NONE
BAR CODE SEND DELAY	0.0 SEC.
MAG STRIPE SEND DELAY	0.0 SEC.
SERIAL PORT SEND DELAY	0.0 SEC.
ACTIVE	ALL

## TRANSMIT

BAUD RATE	9600
PARITY	NONE
DATA BITS	8
READER OUTPUT	KEYBOARD ONLY
SERIAL CONTROL	NONE

## TERMINATION CHARACTER

TERMINATION CHARACTER	CR
-----------------------	----

## BEEP

LENGTH	MEDIUM SHORT
TONE	MEDIUM HIGH

## MAG STRIPE #2

OUTPUT	BOTH
REQUIRE TWO TRACKS	OFF
SEND START & END SENTINELS	ON
BETWEEN TRACKS/FIELDS TERM CHAR	OFF
SEND ENDING TERMINATION CHAR	ON
STRIP SPACES	ON

## DATA EDIT

DATA EDITING	OFF
ENTER # OF LEADING STRIP CHAR'S	0
ENTER # OF TRAILING STRIP CHAR'S	0
ENTER DATA TYPE TO EDIT	ALL
STRIP LEADING & TRAILING SPACES	OFF

## OPTIONS # 2

BAR CODE SPECIAL KEYS	OFF
KEYBOARD NUM LOCK STATUS	OFF
KEYBOARD AUTO CAPS/NUM LOCK	ON
ALTERNATE KEYBOARD SCAN CODES	OFF
MAG STRIPE SPECIAL/FUNCTION KEYS	OFF
SERIAL DATA SPECIAL/FUNCTION KEYS	OFF
BAR CODE TERM CHAR OVERRIDE	OFF



## CHANGING THE DEFAULT SETTINGS

You can easily change the default settings by simply scanning the bar code options located on the READER SETUP MENU. The READER SETUP MENU is a laminated sheet of bar codes supplied with this manual.

The basic programming sequence is:

START / CATEGORY / OPTION (0-9) / ON/OFF (or) NUMBER ONLY / EXIT

Follow the instructions below to change the settings.

- Step 1: Scan the START label at the top left corner of the SETUP MENU. This puts the reader into the program mode.
- Step 2: Scan one of the CATEGORY labels (i.e. Code 39, UPC, Baud Rate, Computer Type).
- Step 3: Select the desired option by scanning one of the numeric labels (0 - 9).
- Step 4: If there is an (ON/OFF) next to the description, scan an ON label to enable or OFF label to disable the option.

EXAMPLE: To enable the MOD 43 check digit on Code 39, perform the following:

- 1) Scan the "CODE 39" category label.
- 2) Scan the option (2) label to select the "MOD 43 CHECK DIGIT" option.
- 3) Scan the "ON" label to enable option (2).

If there is a range of numbers next to the option, then scan one of the numeric labels (0 - 9).

EXAMPLE: To select the OPCC check digit for Interleaved 2 of 5, perform the following:

- 1) Scan the "INT. 2 OF 5" category label.
- 2) Scan the (1) label to select the "CHECK DIGIT" option.
- 3) Scan the numeric "2" label to select OPCC.

Step 5: If you want to make another change within the SAME CATEGORY, you can scan another option number (i.e., return to *"Step 3"* above). If you want to make a change in a DIFFERENT CATEGORY you MUST scan the new CATEGORY (i.e., return to *"Step 2"* above and repeat the steps).

Step 6: When you have finished making all of the changes, you can either:

- 1) SCAN the EXIT (Save Changes) label to save all the changes
- OR
- 2) SCAN the EXIT (Ignore Changes) label to exit without saving any changes.

NOTE: You can reset the reader to the default setting by performing the following:

- 1) Scan the START label.
- 2) Scan the RESET ALL DEFAULTS label.
- 3) Scan the EXIT (Save Changes) label.

# PROGRAMMING GUIDE

## START

The START bar code places the reader into the program mode. After scanning this label, the reader will emit three short BEEPS to indicate that it is in the program mode.

## EXIT (SAVE CHANGES)

Scan this bar code to EXIT the program mode and save all of the changes. After scanning this label, the reader will BEEP twice then delay approximately one second and emit three short BEEPS to indicate that it accepted the changes.

## EXIT (IGNORE CHANGES)

Scan this bar code to EXIT the program mode and DISCARD all of the current changes. The reader will use the settings that were in effect before entering the program mode.

## RESET ALL DEFAULTS

Scan this bar code to RESET all options to their DEFAULT settings.

NOTE: Defaults are marked with "\*".

## 0-9 BAR CODES

These bar codes are scanned to select various options and enter programmable data into the reader.

NOTE: Scan option (9) to reset all of the options within the current CATEGORY back to their defaults.

## ON

If the OPTION has an (ON/OFF) beside the description, scan the ON bar code to turn ON the current option.

## OFF

If the OPTION has an (ON/OFF) beside the description, scan the OFF bar code to turn OFF the current option.

## FULL ASCII CHART

The FULL ASCII CHART is located on the back of the READER SETUP MENU. This chart contains the entire ASCII character set (128 characters). Use this chart to enter PREAMBLE and POSTAMBLE character strings as well as the RECORD TERMINATOR and SEPARATOR characters.

## ADDITIONAL NOTES:

If the description beside the OPTION contains:

(ON/OFF) Then scan either an ON or OFF label to set the option.

(CHART) Then scan one or more characters from the Full ASCII Chart.

(0-9) Scan the desired character from the 0-9 labels.

(0.0-9.9) Scan two characters from the 0-9 labels to set the time from 0 to 9.9 seconds.

## CODE 39

### *0) CODE 39 DECODER*

ON\* Enable reading CODE 39 labels.

OFF Disable reading CODE 39 labels.

### *1) FULL ASCII*

ON Enable the FULL ASCII EXTENSION to CODE 39. Option #0 above must be set ON.

OFF\* Disable the FULL ASCII EXTENSION to CODE 39. This sets the reader to the standard CODE 39 mode.

### *2) MOD 43 CHECK DIGIT*

ON Enable the MOD 43 CHECK DIGIT for CODE 39. When this option is enabled, only CODE 39 labels that contain a valid check digit will be read.

OFF\* Disable the MODE 43 CHECK DIGIT. Check digit verification will not be performed.

### *3) SEND CHECK DIGIT*

ON Transmit the MOD 43 CHECK DIGIT with the bar code data. Requires option #2 above to be set ON.

OFF\* Do not transmit the MOD 43 CHECK DIGIT.

### *4) CONCATENATE MODE*

ON Enable CONCATENATE MODE. The concatenate mode allows the reader to accumulate multiple bar codes in its buffer, then send them to the computer just like they were a single bar code. When a Code 39 label containing a leading space is read, the reader emits two short beeps and buffers the data without transmission. This process continues until a Code 39 label without a leading space is read or 128 characters are buffered. A Code 39 bar code label that only contains a single or multiple dashes (minus sign) will clear the buffer.

OFF\* Disable CONCATENATE MODE.

*0) UPC DECODER*

- ON\* Enable reading UPC-A and UPC-E labels.
- OFF Disable reading UPC-A and UPC-E labels.

*1) CONVERT UPC-E TO UPC-A*

- ON Convert all UPC-E labels to their UPC-A equivalents before transmission. After conversion, the reader will follow the UPC-A programming options.
- OFF\* No conversions will be performed.

*2) CONVERT UPC-A TO EAN-13*

- ON Convert all UPC-A labels to an equivalent EAN-13 format by inserting a leading zero. After conversion, the reader will follow the EAN-13 programming options.
- OFF\* No conversions will be performed.

*3) SEND UPC-A NUMBER SYSTEM*

- ON\* Transmit the UPC-A NUMBER SYSTEM character.
- OFF Do not transmit the UPC-A NUMBER SYSTEM character.

*4) SEND UPC-E NUMBER SYSTEM*

- ON\* Transmit the UPC-E NUMBER SYSTEM character.
- OFF Do not transmit the UPC-E NUMBER SYSTEM character.

*5) SEND UPC-A CHECK DIGIT*

- ON\* Transmit the UPC-A CHECK DIGIT character.
- OFF Do not transmit the UPC-A CHECK DIGIT character.

*6) SEND UPC-E CHECK DIGIT*

- ON\* Transmit the UPC-E CHECK DIGIT character.
- OFF Do not transmit the UPC-E CHECK DIGIT character.

## EAN

### 0) EAN DECODER

ON\* Enable reading EAN-8 and EAN-13 labels.

OFF Disable reading EAN-8 and EAN-13 labels.

### 1) ZERO FILL EAN-8 TO EAN-13

ON Add five leading zeroes to EAN-8 labels. After conversion, the reader will follow the EAN-13 programming options.

OFF\* No conversion is performed.

### 2) SEND EAN-13 COUNTRY CODE

ON\* Transmit the EAN-13 COUNTRY CODE.

OFF Do not transmit the EAN-13 COUNTRY CODE.

### 3) SEND EAN-8 COUNTRY CODE

ON\* Transmit the EAN-8 COUNTRY CODE.

OFF Do not transmit the EAN-8 COUNTRY CODE.

### 4) SEND EAN-13 CHECK DIGIT

ON\* Transmit the EAN-13 CHECK DIGIT character.

OFF Do not transmit the EAN-13 CHECK DIGIT character.

### 5) SEND EAN-8 CHECK DIGIT

ON\* Transmit the EAN-8 CHECK DIGIT character.

OFF Do not transmit the EAN-8 CHECK DIGIT character.

### 6) ISBN CONVERSION

ON Convert 13 DIGIT BOOKLAND/EAN (978 prefix) to its corresponding 10 DIGIT ISBN number.

EXAMPLE: BAR CODE DATA = 9780806957906
ISBN OUTPUT DATA = 0806957905

OFF\* Do not convert Bookland/EAN to an ISBN number.

## UPC/EAN SUPPLEMENTS

### *0) SUPPLEMENTS DECODER*

ON Enable reading UPC & EAN supplements.

OFF\* Disable reading UPC & EAN supplements.

### *1) ALLOW 2 DIGIT*

ON\* Enable reading 2 digit supplements. Option (0) above must be set ON.

OFF Disable reading 2 digit supplements.

### *2) ALLOW 5 DIGIT*

ON\* Enable reading 5 digit supplements. Option (0) above must be set ON.

OFF Disable reading 5 digit supplements.

### *3) REQUIRE SUPPLEMENTS*

Specifies how the reader will handle various supplements.

0)\* UPC/EAN bar codes will be read with or without valid supplements.

1) UPC bar codes will not be read unless they are accompanied by a valid supplement.

2) EAN bar codes will not be read unless they are accompanied by a valid supplement.

3) Bookland EAN bar codes will not be read unless they are accompanied by a valid supplement.

4) All UPC/EAN bar codes will not be read unless they are accompanied by a valid supplement.

### *4) SEND SEPARATOR SPACE*

ON Insert a space between the standard bar code data and the supplemental data.

OFF\* No separator space is inserted.

## INTERLEAVED 2 OF 5

### *0) 1 2 OF 5 DECODER*

- ON\* Enable reading INTERLEAVED 2 of 5 labels.
- OFF Disable reading INTERLEAVED 2 of 5 labels.

### *1) CHECK DIGIT: 0=NONE, 1=USS, 2=OPCC*

Specifies which type of check digit will be used with INTERLEAVED 2 of 5:

- 0\* = NONE (no check digit required)
- 1 = UNIFORM SYMBOLOGY SPECIFICATION  
(3-1-3 MOD 10)
- 2 = OPTICAL PRODUCT CODE COUNCIL  
(2-1-2 MOD 10)

### *2) SEND CHECK DIGIT*

- ON Transmit the INTERLEAVED 2 of 5 check digit with the bar code data.
- OFF\* The check digit is not transmitted.

### *3) FIXED LENGTH*

- ON Read only FIXED LENGTH INTERLEAVED 2 of 5 bar code labels that match the lengths defined in options (4) & (5) below. The check digit can be on or off.
- OFF\* Disable FIXED LENGTH mode. Read all INTERLEAVED 2 of 5 labels without regard to length.

### *4) SET FIXED LENGTH #1 (02-60)*

Sets the first valid FIXED LENGTH for Interleaved 2 of 5. Scan a two digit value to enter the length. Valid lengths are 02 to 60 characters. By definition, the length of Interleaved 2 of 5 labels are an even number of characters. The default FIXED LENGTH is 6 characters.

### *5) SET FIXED LENGTH #2 (02-60)*

Sets a second valid fixed LENGTH for Interleaved 2 of 5. Scan a two digit value to enter the length. The default length is set to 0 characters (i.e. the second FIXED LENGTH is disabled).



## CODABAR

### 0) CODABAR DECODER

ON \* Enable reading CODABAR labels.

OFF Disable reading CODABAR labels.

### 1) SEND START/STOP

ON Transmit the CODABAR start/stop characters.

OFF \* Do not transmit the CODABAR start/stop characters.

### 2) CLSI FORMATTING

ON The reader will insert a blank after the 1st, 5th, and 10th characters of a 14-character CODABAR label. The label length does not include the start and stop characters.

OFF \* Disable CLSI formatting.

### 3) CLSI CHECK DIGIT

ON Enable the CLSI check digit. When this option is enabled, all fourteen digit numeric bar codes must contain a valid check digit.

OFF\* Disable the CLSI check digit. Check digit verification will not be performed.

## CODE 128

### 0) CODE 128 DECODER

ON \* Enable reading Code 128 labels.

OFF Disable reading Code 128 labels.

### 1) UCC-128 VERIFICATION

ON A valid MOD 10 CHECK DIGIT is required on UCC-MOD 10 bar codes. (Applies to 20-digit serial shipping container bar codes.)

OFF \* UCC-MOD 10 bar codes are accepted without valid MOD 10 CHECK DIGITS.

### 2) SEND MOD 10 CHECK DIGIT

ON \* Transmit the MOD 10 CHECK DIGIT with the bar code entry.

OFF Do not transmit the MOD 10 CHECK DIGIT.

CODE 93

*0) CODE 93 DECODER*

ON\* Enable reading Code 93 labels.

OFF Disable reading Code 93 labels.

*1) CONCATENATE MODE*

ON Enable CONCATENATE MODE. The concatenate mode allows the reader to concatenate multiple bar codes in its buffer, then send them to the computer just like they were a single bar code. When a Code 93 label with a leading space is read, the reader emits two short beeps and buffers the data without transmission. This process continues until a Code 93 label without a leading space is read or 128 characters are buffered. A Code 93 bar code label that only contains a single or multiple dashes (minus sign) will clear the buffer.

OFF\* Disable CONCATENATE MODE.

CODE 11

*0) CODE 11 DECODER*

ON Enable reading CODE 11 labels.

OFF \* Disable reading CODE 11 labels.

*1) TWO CHECK DIGITS REQUIRED*

ON Two valid CHECK DIGITS are required for each label.

OFF \* One valid CHECK DIGIT is required for each label.

*2) SEND FIRST CHECK DIGIT*

ON Transmit the FIRST CHECK DIGIT.

OFF \* Do not transmit the FIRST CHECK DIGIT.

*3) SEND SECOND CHECK DIGIT*

ON Transmit the SECOND CHECK DIGIT.

OFF \* Do not transmit the SECOND CHECK DIGIT.

## MSI/PLESSEY

### *0) MSI/PLESSEY DECODER*

ON Enable reading MSI/PLESSEY labels.

OFF \* Disable reading MSI/PLESSEY labels.

### *1) TWO CHECK DIGITS REQUIRED*

ON Two valid CHECK DIGITS are required for each label.  
The first check digit is defined by option (2) below.  
The second check digit is always MOD 10.

OFF \* One valid CHECK DIGIT is required for each label.  
The CHECK DIGIT must be MOD 10.

### *2) FIRST CHECK DIGIT MOD 11*

ON The FIRST CHECK DIGIT must be MOD 11.

OFF \* The FIRST CHECK DIGIT must be MOD 10.

### *3) SEND FIRST CHECK DIGIT*

ON Transmit the FIRST CHECK DIGIT.

OFF \* Do not transmit the FIRST CHECK DIGIT.

### *4) SEND SECOND CHECK DIGIT*

ON Transmit the SECOND CHECK DIGIT.

OFF \* Do not transmit the SECOND CHECK DIGIT.

### *5) ISBN PLESSEY*

ON Enable reading of Modified Plessey ISBN bar codes.  
Only eleven digit ISBN bar codes will be read.

OFF\* Do not read Modified Plessey ISBN bar codes.

## SERIAL PORT

The reader's RS-232C serial port accepts serial input data and re-transmits it to the computer through the keyboard interface.

### *0) MODE: 0=BATCH, 1=PASS THROUGH*

This option selects the mode of operation for serial input port.

- 0 \*      Selects the BATCH MODE of operation. The reader buffers the data until it finds a valid RECORD TERMINATOR CHARACTER or a TIMEOUT occurs. The serial buffer can contain a maximum of 256 characters. The serial PREAMBLE and POSTAMBLE can be enabled with MODE 0. (See options (2), (3), (4), and (5) for more information on RECORD TERMINATOR and TIMEOUT DELAY.)
  
- 1         Selects the PASS THROUGH MODE of operation. The reader simply transmits each character that it receives from the serial port to the computer. Note that with MODE 1, the PREAMBLE, POSTAMBLE, RECORD TERMINATOR CHARACTER, and TIMEOUT DELAY have no effect on the serial data.

### *1) PROTOCOL: 0=NONE, 1=XON/XOFF*

- 0 \*      No PROTOCOL is used. The serial buffer can contain a maximum of 256 characters.
  
- 1         XON/XOFF PROTOCOL is selected. In this mode, the reader will transmit an XOFF (control S) character to stop incoming serial data. This prevents the serial buffer from overflowing. Once the reader is ready to accept more data, an XON (control Q) character will be transmitted to enable reception of more serial data. The XOFF will be transmitted when the buffer fills to 250 characters.

### *2) RECORD TERMINATOR CHAR*

- ON        (Valid only if option (0) is set for BATCH MODE.) The reader will search for the RECORD TERMINATOR CHARACTER, defined with option (4), which indicates the end of the data. There are two ways to trigger the transmission of the serial data buffer: (1) the reader detects the RECORD TERMINATOR CHARACTER or, (2) a TIMEOUT occurs.
  
- OFF \*    The reader will wait for a TIMEOUT before sending the serial data buffer out the keyboard interface. No check will be made for a RECORD TERMINATOR CHARACTER.

### 3) *SEND RECORD TERMINATOR CHAR*

ON Transmit the RECORD TERMINATOR CHARACTER along with the serial data buffer.

OFF \* Do not transmit the RECORD TERMINATOR CHARACTER. Send only the serial data buffer.

### 4) *ENTER RECORD TERMINATOR CHAR*

(This option valid only if option (0) is set to BATCH MODE and option (2) is enabled.) The record terminator character can be scanned from the FULL ASCII CHART on the back of the menu. This character is used to identify the end of the serial data stream. Once the reader detects this character, the buffered data is transmitted in a block to the computer through the keyboard interface. The default is a Carriage Return.

### 5) *TIMEOUT DELAY (0.0 - 9.9 SEC)*

This parameter defines the maximum period allowed to elapse before the reader assumes the transmission has ended. The timer is activated on receipt of the first character from the serial input port. Any incoming character that arrives before the timeout occurs will reset the timer. The TIMEOUT DELAY can be programmed from 0 to 9.9 seconds in increments of 0.1 seconds. The default setting is 0.0 seconds. (To select a value, for example, 2.0, scan the "2" label, then the "0" label.)

NOTE: TIMEOUT DELAY is used as a host response timeout delay when host response mode is enabled, at which point, the delay is from 0-99 seconds.
--

### 6) *ENTER SERIAL COMMAND STRING*

This option allows bar code data to be redirected out the serial port instead of the keyboard interface. When the start of the bar code data matches the COMMAND STRING, the reader will strip the COMMAND STRING from the bar code data and then transmit the remaining data out the serial port instead of the keyboard interface. This feature is especially useful for interrogating electronic scales with RS-232C serial interfaces.

To define this COMMAND STRING, scan up to 5 characters from the FULL ASCII CHART on the MENU and then scan the "ON" bar code when finished.

### 7) *READER OUTPUT*

This option defines how the reader will output all data. Select one of the following:

- 0\* Keyboard output only.
- 1 Keyboard and RS-232 Serial output.
- 2 RS-232 Serial output only.
- 3 Keyboard and RS-232 Serial output using serial port preambles and postambles.

8) SERIAL CONTROL: 0=NONE, 1=DAISY CHAIN,  
2=HOST RESPONSE

This option defines the control mode of the RS-232C serial port, which allows the M2000/2002 to be used as a daisy chain controller and also allows for a host response through the serial port.

- 0\* This is the normal mode of operation. M2000 operates as a stand alone unit.
- 1 This mode allows multiple M2500 serial output decoders to be "daisy chained" into the serial port of the M2000.
- 2 In this mode, M2000's can receive a serial response from the host computer after transmitting data.
- CR - data ok, no action needed  
CTRL G - single beep  
CTRL R - high/low error warble tone

NOTE: TIMEOUT DELAY is used as a host response timeout delay when host response mode is enabled.

## BAUD RATE

The BAUD RATE sets the data transmission speed for the serial input port on the reader. The reader's BAUD RATE must match the serial input device (electronic scale, portable terminal, etc...). Select one of the following:

- |    |      |   |        |
|----|------|---|--------|
| 0  | 150  | 1 | 300    |
| 2  | 600  | 3 | 1200   |
| 4  | 2400 | 5 | 4800   |
| 6* | 9600 | 7 | 19,200 |

## PARITY

Sets the PARITY for the incoming serial data. This setting must match the serial input device (electronic scale, portable terminal, etc...). Select one of the following:

- |    |      |   |      |
|----|------|---|------|
| 0* | NONE | 1 | EVEN |
| 2  | ODD  | 3 | MARK |

## DATA BITS

Sets the character length (number of DATA BITS per character) for the incoming serial data. This setting must match the serial input device (electronic scale, portable terminal, etc...). Select one of the following:

- |    |        |
|----|--------|
| 0  | 7 BITS |
| 1* | 8 BITS |

## PREAMBLES

PREAMBLE refers to a user-defined set of characters transmitted at the beginning of each type of input data. There are three different PREAMBLES; one set each for bar code data, magnetic stripe data, and serial input port data.

### *0) ENTER BAR CODE PREAMBLE*

This set of user-defined characters is transmitted at the beginning of BAR CODE data. To define this preamble, scan up to 15 characters from the FULL ASCII chart on the reverse side of the SETUP MENU. Scan the "ON" bar code when complete.

### *1) ENTER MAG STRIPE PREAMBLE*

This set of user-defined characters is transmitted at the beginning of MAG STRIPE data. To define this preamble, scan up to 15 characters from the FULL ASCII chart on the reverse side of the SETUP MENU. Scan the "ON" bar code when complete.

### *2) ENTER SERIAL PORT PREAMBLE*

This set of user-defined characters is transmitted at the beginning of SERIAL port data. To define this preamble, scan up to 15 characters from the FULL ASCII chart on the reverse side of the SETUP MENU. Scan the "ON" bar code when complete.

### *3) BAR CODE SEND DELAY (0.0 - 9.9 SEC)*

This option specifies the amount of delay to occur after the BAR CODE preamble is transmitted. The delay period is programmable from 0.0 to 9.9 seconds.

### *4) MAG SEND DELAY (0.0 - 9.9 SEC)*

This option specifies the amount of delay to occur after the MAG STRIPE preamble is transmitted. The delay period is programmable from 0.0 to 9.9 seconds.

### *5) SERIAL SEND DELAY (0.0 - 9.9 SEC)*

This option specifies the amount of delay to occur after the SERIAL port preamble is transmitted. The delay period is programmable from 0.0 to 9.9 seconds.

### *6) ACTIVE TYPES*

Specifies the types of bar codes that use preambles. Select one of the following:

A CODE 39	E EAN-8	I CODE 93
B UPC-A	F I 2 of 5	J MSI/PLESSEY
C UPC-E	G CODABAR	K CODE 11
D EAN-13	H CODE 128	L ISBN
	X* ALL BAR CODES	

## POSTAMBLES

POSTAMBLE refers to a user-defined set of characters transmitted at the end of each type of input data. There are three different postambles; one set each for bar code data, magnetic stripe data, and serial input port data.

### *0) ENTER BAR CODE POSTAMBLE*

This set of user-defined characters is transmitted at the end of BAR CODE data. To define this postamble, scan up to 15 characters from the FULL ASCII chart on the reverse side of the SETUP MENU. Scan the "ON" bar code when complete.

### *1) ENTER MAG STRIPE POSTAMBLE*

This set of user-defined characters is transmitted at the end of MAG STRIPE code data. To define this postamble, scan up to 15 characters from the FULL ASCII chart on the reverse side of the SETUP MENU. Scan the "ON" bar code when complete.

### *2) ENTER SERIAL PORT POSTAMBLE*

This set of user-defined characters is transmitted at the end of SERIAL port data. To define this postamble, scan up to 15 characters from the FULL ASCII chart on the reverse side of the SETUP MENU. Scan the "ON" bar code when complete.

### *3) BAR CODE SEND DELAY (0.0 - 9.9 SEC)*

This option specifies the amount of delay to occur after the BAR CODE postamble is transmitted. The delay period is programmable from 0.0 to 9.9 seconds.

### *4) MAG SEND DELAY (0.0 - 9.9 SEC)*

This option specifies the amount of delay to occur after the MAG STRIPE postamble is transmitted. The delay period is programmable from 0.0 to 9.9 seconds.

### *5) SERIAL SEND DELAY (0.0 - 9.9 SEC)*

This option specifies the amount of delay to occur after the SERIAL port postamble is transmitted. The delay period is programmable from 0.0 to 9.9 seconds.

### *6) ACTIVE TYPES*

Specifies the types of bar codes that use postambles. Select one of the following:

A	CODE 39	E	EAN-8	I	CODE 93
B	UPC-A	F	12 of 5	J	MSI/PLESSEY
C	UPC-E	G	CODABAR	K	CODE 11
D	EAN-13	H	CODE 128	L	ISBN
		X*	ALL BAR CODES		



## TERMINATION CHARACTER

The optional TERMINATION CHARACTER is transmitted at the end of the data. This option applies to bar code, mag stripe, and serial data.

If a USER DEFINED TERMINATION CHARACTER is desired, select setting (4) below, then scan a single character from the FULL ASCII section of the MENU.

- 0 NONE
- 1 HORIZONTAL TAB (ASCII 09)
- 2 \* CARRIAGE RETURN (ASCII 13)
- 3 CARRIAGE RETURN & LINE FEED  
(ASCII 13 & ASCII 10)
- 4 USER DEFINED TERMINATION CHARACTER

## BEEP LENGTH & TONE

Settings (0-3) set the LENGTH of the BEEP. Settings (4-7) set the TONE (pitch) of the BEEP. Setting (8), when selected, will override the other BEEP selections and shut the BEEP off.

### LENGTH:

- 0 SHORT
- 1 \* MEDIUM SHORT
- 2 MEDIUM LONG
- 3 LONG

### TONE:

- 4 LOW
- 5 MEDIUM LOW
- 6 \* MEDIUM HIGH
- 7 HIGH

### OFF:

- 8 NO BEEP

## MAG STRIPE OPTIONS #1

### *0) SEND ACCOUNT NUMBER*

(This option valid only if option (3) below is OFF.)

ON \* Transmit the ACCOUNT NUMBER data from the magnetic card. On major credit cards, the account number is available on TRACKS 1 & 2.

OFF Do not transmit the ACCOUNT NUMBER.

### *1) SEND NAME (TRACK 1 ONLY)*

(This option valid only if option (3) below is OFF.)

ON \* Transmit the NAME data from the magnetic card. On major credit cards, the NAME is available only on TRACK 1.

OFF Do not transmit the NAME.

### *2) SEND EXPIRATION DATE*

(This option valid only if option (3) below is OFF.)

ON \* Transmit the EXPIRATION DATE. On major credit cards, the EXPIRATION DATE is available on TRACKS 1 & 2.

OFF Do not transmit the EXPIRATION DATE.

### *3) SEND ALL TRACK DATA*

ON \* Transmit ALL the data from each enabled track. The data is transmitted as it appears on the card with NO formatting. However, SEPARATOR CHARACTERS will be inserted between fields; see options (4) and (6) for information on SEPARATOR CHARACTERS.

OFF Disables this option.

NOTE: If this option is ON, it overrides options (0), (1), (2), and (5).

### *4) ENTER TRACK 1 SEPARATOR CHARACTER*

(This option valid only if option (3) is ON.)

The TRACK 1 SEPARATOR CHARACTER, which separates the Track 1 fields, can be programmed by the user. Scan a single character from the FULL ASCII section of the MENU. The default is "" (ASCII 94).

*5) FORMAT EXPIRATION DATE MMY*

(This option valid only if option (3) is OFF.)

ON      EXPIRATION DATE format = MMY

OFF \*   EXPIRATION DATE format = YMM

*6) ENTER TRACKS 2 & 3 SEPARATOR CHAR*

(This option valid only if option (3) is ON.)

The TRACKS 2 & 3 SEPARATOR CHARACTER, which separates the fields on tracks 2 and 3, can be programmed by scanning a single character from the FULL ASCII section of the MENU. The default is "=" (ASCII 61).

## MAG STRIPE OPTIONS #2

### 0) OUTPUT

This option designates which track(s) will be output, and in what order. (To use a Dual Track decoder with a Single Track application, select FIRST TRACK (only) or SECOND TRACK (only)). Select one of the following:

- 0) FIRST TRACK (only)
- 1) SECOND TRACK (only)
- 2) \* BOTH (output in order)
- 3) BOTH (REVERSE ORDER)

NOTE: For a dual track (tracks 2&3) mag stripe reader, FIRST TRACK represents track 2, and SECOND TRACK represents track 3.

### 1) REQUIRE TWO TRACKS

ON Two tracks of mag stripe data must be read for a "good read" to occur. (Only for use with dual track readers.)

OFF \* The decoder will accept one (*or more*) valid tracks as a "good read".

NOTE: THIS OPTION MUST BE OFF FOR ALL SINGLE TRACK READERS.  
(Optional for dual track readers.)

### 2) SEND START & END SENTINELS

(This option valid only if SEND ALL TRACK DATA is ON.)

ON \* The START/END SENTINEL characters for each enabled track will be transmitted. The characters for each type of sentinel are listed below:

- 1) Track 1 START SENTINEL = " % "
- 2) Tracks 2 & 3 START SENTINEL = " ; "
- 3) Tracks 1, 2, & 3 END SENTINEL = " ? "

OFF Do not transmit the START/END SENTINEL characters.

### 3) *BETWEEN TRACKS/FIELDS TERM CHARACTER*

The CHARACTER to be output is defined from the TERMINATION CHARACTER option. The default is a carriage return (ENTER).

- ON Transmit the TERMINATION CHARACTER between each track/field which is read. The insertion location is according to the following:
  - a) IF the SEND ALL TRACK DATA option is ON, the character will be inserted between TRACKS.
  - b) IF the SEND ALL TRACK DATA option is OFF, the character will be inserted between FIELDS.
- OFF \* Do not transmit the BETWEEN TRACKS/FIELDS TERMINATION CHARACTER.

### 4) *SEND ENDING TERMINATION CHARACTER*

The CHARACTER to be output is defined from the TERMINATION CHARACTER option. The default is a carriage return (ENTER).

- ON \* Transmit the TERMINATION CHARACTER after all data has been sent.
- OFF Do not transmit the ENDING TERMINATION CHARACTER.

### 5) *STRIP SPACES*

(This option valid only if SEND ALL TRACK DATA is OFF.)

- ON \* All spaces will be stripped from the ACCOUNT NUMBER FIELD, and any leading or trailing spaces will be stripped from the NAME FIELD.
- OFF Do not strip any spaces from the mag stripe data.

## COMPUTER TYPE

This option defines the type of computer, the type of keyboard and whether or not the keyboard is installed. The selections must be made properly for the data to transmit correctly. Note the UNIVERSAL keyboard setting below, which can be used for all international keyboards.

Select a COMPUTER TYPE from settings (0-3), a KEYBOARD TYPE from option (4), and a KEYBOARD INSTALLED setting from option (5).

- 0 IBM PC/XT (8088 and 8086 processors)
- 1 \* IBM AT (286, 386, and 486 processors)
- 2 IBM PS/2 MODELS 25, 30, 57 & 90  
(and some MODEL 70's)
- 3 IBM PS/2 MODELS 30-286, 50, 55, 60, 70 & 80
  
- 4) KEYBOARD TYPE. Select from the following:
  - 0 \* USA
  - 1 FRENCH
  - 2 GERMAN
  - 3 ITALIAN
  - 9 UNIVERSAL

**NOTE:** For all PC/XT computers, select UNIVERSAL as the KEYBOARD TYPE to ensure proper upper/lower case transmission.

- 5) KEYBOARD INSTALLED
  - ON\* The computer has a keyboard installed .
  
  - OFF The computer does not have a keyboard installed. The reader will indicate to the PC that a keyboard is installed.

## TRANSMIT SPEED

This option sets the speed at which data will be transmitted to the computer. Some computer systems may require the transmission speed set to a slower speed. The default setting is (3), FAST.

- 0 SLOW
- 1 MEDIUM SLOW
- 2 MEDIUM FAST
- 3 \* FAST

## DATA EDIT

This option allows data editing before transmittal.

### 0) DATA EDITING

(Must be ON for any of the editing options below to be valid.)

ON Enable Data Editing.

OFF \* Disable Data Editing.

### 1) ENTER # OF LEADING CHAR TO STRIP (0-9, A-F)

(Option (0) above must be ON.) Refers to the number (0-15) of characters to be stripped, i.e., removed, from the beginning of the data entry.

### 2) ENTER # OF TRAILING CHAR TO STRIP (0-9, A-F)

(Option (0) above must be ON.) Refers to the number (0-15) of characters to be stripped, i.e., removed, from the end of the data entry.

NOTE: If the total number of strip characters (both Leading and Trailing) is greater than the number of characters of the bar code, no characters will be stripped.

### 3) ENTER DATA TYPE TO EDIT

(Option (0) above must be ON.) Refers to the type of bar codes for which editing can be enabled. The choices are listed below:

A	CODE 39	G	CODABAR
B	UPC-A	H	CODE 128
C	UPC-E	I	CODE 93
D	EAN-13	J	MSI/PLESSEY
E	EAN-8	K	CODE 11
F	INTERLEAVED 2 of 5	O	MAG STRIPE
	X *		ALL BAR CODES

### 4) STRIP LEADING & TRAILING SPACES

(Option (0) above must be ON.)

ON Any LEADING & TRAILING SPACES will be stripped from the data.

OFF \* No spaces will be stripped.

## OPTIONS #1

### *0) SEND BAR CODE TYPE ID*

ON Transmit the bar code identifier character at the beginning of the bar code data. There is one space between the ID character and the bar code data. The identifier characters are defined below:

A	CODE 39	G	CODABAR
B	UPC-A	H	CODE 128
C	UPC-E	I	CODE 93
D	EAN-13	J	MSI/PLESSEY
E	EAN-8	K	CODE 11
F	INTERLEAVED 2 of 5		

OFF \* Do not transmit BAR CODE TYPE ID.

### *1) DUPLICATE READS ALLOWED*

ON \* Enable reading the same bar code multiple times.

OFF Disable reading the same bar code twice in a row.

### *2) LASER / CCD TIMEOUT (0 - 9)*

If the LASER or CCD has not read a bar code within the designated time period, the device will be turned off. Select from 0 to 9 seconds; the default is 1 second.

**CAUTION: IF THE ABOVE OPTION IS SET AT ZERO (0) SECONDS, IT WILL OVERRIDE THIS SAFETY FEATURE.**

### *3) LASER / CCD TRIGGER SHUTOFF*

ON \* Releasing the trigger will turn off the LASER or CCD.

OFF The LASER or CCD will continue to run until a successful read or until the timeout period (from option (2), LASER/CCD TIMEOUT) lapses.

**NOTE: To use "Blink Mode" with a CCD or laser, set this option OFF, and set option (4), LASER/CCD CONTINUOUS RUN, ON. (Note that "Blink Mode" will not operate properly for lasers which employ thermal shut-down.)**



#### 4) LASER / CCD CONTINUOUS RUN

- ON The LASER or CCD runs continuously as long as the trigger is pulled. The scanner will not be affected by the LASER/CCD TIMEOUT and will not shut off after a "good read".
- OFF \* The LASER or CCD runs only when the trigger is pulled. (The LASER/CCD TIMEOUT option remains in effect.)

#### 5) CONTINUOUS RUN READ DELAY (0.0 - 9.9 SEC)

(Valid only if option (4) above is ON.) This option sets the DELAY period between successive reads of the same bar code. This allows the removal of the bar code from the scan field without multiple reads. The default setting is 1.0 second. (To select a value, for example, 2.0, scan the "2" label, then the "0" label.)

#### 6) BAR CODE FUNCTION KEYS

- ON Applies to BAR CODE data, preambles, postambles, and user defined termination characters. FUNCTION KEYS F1 through F10 will be transmitted in place of the ASCII characters "DC1" (11H) through "SUB" (1AH). The FUNCTION KEY values are listed in the Full ASCII Chart on back of the MENU, and in *Appendix A*.
- OFF \* Disable FUNCTION KEYS.  
(Standard ASCII characters are transmitted.)

NOTE: See "*Options #2*", (0) for a related example.

#### 7) KEYBOARD CAPS LOCK STATUS

Setting this function is necessary only if KEYBOARD AUTO CAPS/NUM LOCK (from "*Options #2*", (2) ) does not operate on your computer. See "*Options #2*", (2) to determine whether KEYBOARD CAPS LOCK STATUS is required.

To use this option, scan either ON or OFF to match the computer keyboard's CAPS LOCK status.

- ON \* Scan ON to indicate that the keyboard's CAPS LOCK is turned ON. The result is lower case Alpha characters being output as Shifted characters.
- OFF Scan OFF to indicate that the keyboard's CAPS LOCK is turned OFF. The result is upper case Alpha characters being output as Shifted characters.

## OPTIONS #2

### 0) BAR CODE SPECIAL KEYS

This option applies only to BAR CODE data, preambles, postambles, and user defined termination characters.

ON SPECIAL KEY characters will be transmitted in place of a specific set of ASCII characters. The SPECIAL KEYS are listed in the Full ASCII Chart provided on back of the SETUP MENU and in *Appendix A*.

OFF \* Disable SPECIAL KEYS. (Standard ASCII Characters are transmitted.)

EXAMPLE: With SPECIAL KEYS ON, the bar code character "STX" will be transmitted as a right arrow, having the effect of pressing the "→" key at the keyboard.

NOTE: If the Bar Code Reader is not transmitting the special characters with SPECIAL KEYS ON, or if the computer is an XT, see option (2), "*Keyboard Auto Caps/Num Lock*".

### 1) KEYBOARD NUM LOCK STATUS

Setting this function is necessary only if KEYBOARD AUTO CAPS/NUM LOCK (from (2) which follows) does not operate on your computer. See (2) to determine whether KEYBOARD NUM LOCK STATUS is required.

To use this option, scan either ON or OFF to match the computer keyboard's NUM LOCK status.

ON Scan ON to indicate that the computer keyboard's NUM LOCK is turned ON.

OFF \* Scan OFF to indicate that the computer keyboard's NUM LOCK is turned OFF.

### 2) *KEYBOARD AUTO CAPS/NUM LOCK*

With this option ON, data is automatically transmitted in the correct upper/lower case, whether the keyboard's settings are turned ON or OFF.

ON \*    Enable KEYBOARD AUTO CAPS/NUM LOCK.

OFF     Disable KEYBOARD AUTO CAPS

NOTE: The KEYBOARD AUTO CAPS/NUM LOCK option is NOT effective on some computers, such as XT's. Indications that this option is NOT functioning are as follows:

Upper/Lower Case are reversed.  
SPECIAL KEY characters are not transmitted when SPECIAL KEYS are ON.

If KEYBOARD AUTO CAPS/NUM LOCK is NOT operating properly on your system, take the following steps:

Set KEYBOARD AUTO CAPS/NUM LOCK to OFF.  
Set KEYBOARD NUM LOCK STATUS. (See "Options #1", (7)).  
Set KEYBOARD CAPS LOCK STATUS. (See (1), the preceding option.)

### 3) *ALTERNATE KEYBOARD SCAN CODES*

This option is necessary ONLY for computers that use SCAN CODE Set 3. Note that it might be necessary to disable KEYBOARD AUTO CAPS/NUM LOCK. See (2), the preceding option, for further information.

ON        Enable ALTERNATE KEYBOARD SCAN CODES.

OFF \*    Disable ALTERNATE KEYBOARD SCAN CODES.

#### 4) MAG STRIPE SPECIAL / FUNCTION KEYS

This option applies to MAG STRIPE data, preambles, postambles, and user-defined termination characters.

ON SPECIAL KEYS and FUNCTION KEYS will be transmitted in place of a specific set of ASCII characters. The SPECIAL and FUNCTION KEY values are listed in the Full ASCII Chart provided on back of the SETUP MENU and in *Appendix A*.

OFF \* Disable SPECIAL / FUNCTION KEYS.  
(Standard ASCII characters are transmitted.)

#### 5) SERIAL DATA SPECIAL / FUNCTION KEYS

This option applies to SERIAL data, preambles, postambles and user-defined termination characters.

ON SPECIAL KEYS and FUNCTION KEYS will be transmitted in place of a special set of ASCII Characters. The SPECIAL and FUNCTION KEY values are listed in the Full Ascii Chart provided on the back of the SETUP MENU and in *Appendix A*.

OFF \* Disable SPECIAL / FUNCTION KEYS.  
(Standard ASCII characters are transmitted.)

#### 6) BAR CODE TERM CHAR OVERRIDE

ON If any control character or special character (ie., function key, arrow key, etc...) is embedded in the bar code data, the TERMINATION CHARACTER, the BAR CODE PREAMBLE, and the BAR CODE POSTAMBLE will not be transmitted.

OFF \* The TERMINATION CHARACTER, the BAR CODE PREAMBLE, and the BAR CODE POSTAMBLE will be transmitted with all bar code data.

## DIAGNOSTICS

This option executes a self-test program which performs the following tests on the reader:

- \* EPROM Version Number
- \* Internal and External Ram Test
- \* EPROM Checksum Test
- \* Character Set Test
- \* Buzzer Test

The above tests are performed and their status is displayed on the PC monitor.

**NOTE:** Exit your application program and return to DOS before enabling this test.

# CLONING SETUP INFORMATION

When multiple readers are to be setup in the same configuration, it is advantageous to setup the first reader, and clone (copy) that setup to all the other units. The setup information can be (1), stored on a computer for cloning from computer to reader, or (2), cloned directly from one reader to another. These methods are described below:

## CLONING FROM COMPUTER TO READER

BEFORE YOU START, HAVE THE FOLLOWING EQUIPMENT READY:

- A PC CLONE CABLE (with a 9 pin plug (male) and a 25 pin socket (female)).
- A communication software package must be installed on your computer, and it must have the following configuration settings:
  - BAUD RATE: must match the reader's setting
  - DATA BITS: 8 bits
- The configured reader, which is to send the clone information, must have the following configuration setting:
  - DATA BITS: 8 bits (the default setting)

**NOTE:** If the clone information has already been sent to your computer, start at step 10.

- Step 1: Start with the configured reader (denoted as the "SOURCE" reader) connected to the computer as a keyboard wedge.
- Step 2: Plug the 9 pin end of the PC CLONE CABLE into the SOURCE reader's connector labeled "RS-232 SERIAL PORT", located on the rear panel of the reader.
- Step 3: Scan the START bar code on the READER SETUP MENU.
- Step 4: Plug the other end of the PC CLONE CABLE (the 25 pin female) into the computer's RS-232 serial port.
- Step 5: At the computer, run your communications program and put it into RECEIVE mode.

Step 6: Scan the following "CLONE" bar code:

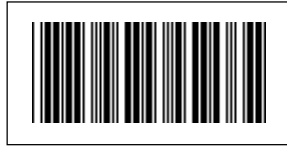

CLONE

Step 7: Once the clone information has been transmitted, take any steps required to save the information on the computer.

Step 8: From the SOURCE reader, scan EXIT (saving OR ignoring changes) on the READER SETUP MENU.

Step 9: Disconnect the SOURCE reader from all cables leading to the computer (the PC CLONE CABLE, the keyboard cable, and the computer keyboard port cable).

Step 10: Plug the 9 pin end of the PC CLONE CABLE into the reader which is to receive the clone information (denoted as the "TARGET" reader). The TARGET reader's connector, located on the rear panel, is labeled "RS-232 SERIAL PORT".

Step 11: Connect the TARGET reader as a keyboard wedge.

Step 12: At the computer, run the communications program. Note that the communications BAUD RATE must be set to match the TARGET reader's BAUD RATE (the default setting is 9600).

Step 13: Set the communications program to TRANSMIT. The reader will beep twice, pause, and beep three times more, indicating the following:

- 2 beeps: indicate the clone information was received
- 3 beeps: indicate the reader is now configured

Step 14: Now you are ready to disconnect the newly configured reader from all cables leading to the computer. (The PC CLONE CABLE, the keyboard cable, and the computer keyboard port cable.)

Step 15: Repeat steps 10 -14 for each additional reader to be cloned.

## CLONING FROM READER TO READER

BEFORE YOU START, HAVE THE FOLLOWING EQUIPMENT READY:

- A READER CLONE CABLE (with two 9 pin male plugs).
- The two readers involved must each be connected as a keyboard wedge to a separate PC, and the power must be ON.
- The reader which is to receive the clone information must have the following configuration settings:
  - BAUD RATE: must match the configured reader's setting
  - DATA BITS: 8 bits (the default setting)

Step 1: Plug one end of the READER CLONE CABLE into the configured reader (denoted as the "SOURCE" reader). The SOURCE's connector, located on the rear panel of the reader, is labeled "RS-232 SERIAL PORT".

Step 2: Plug the other end of the READER CLONE CABLE into the reader which is to receive the clone information; this reader is denoted as the "TARGET".

Step 3: From the "SOURCE" reader, scan the START bar code on the READER SETUP MENU.

Step 4: Still at the "SOURCE" reader, scan the following "CLONE" bar code:



CLONE

Step 5: The "TARGET" reader will beep twice, pause, and beep three times more, indicating it has received the clone information and is now configured.

Step 6: Disconnect the CLONE CABLE from the newly configured TARGET reader.

Step 7: For each additional reader to be cloned, connect a TARGET reader to a computer and repeat steps 2-6.

Step 8: When cloning is complete, go to the SOURCE reader and scan EXIT (saving OR ignoring changes) on the READER SETUP MENU.

Step 9: Next, disconnect the CLONE CABLE from the SOURCE reader.

## RS-232C SERIAL PORT

The RS-232C serial port located on the rear panel of the reader accepts serial ASCII data and re-transmits it to the computer through the keyboard interface. The serial input data appears as though it was typed in from the computer keyboard.

The connector pin assignments for the serial port interface are listed below:

<u>PIN</u>	<u>SIGNAL</u>	<u>DIRECTION</u>
1	Signal Ground	N/A
2	Transmit Data	Output
3	Receive Data	Input
4	Data Terminal Ready	Output
5,6	No Connection	
7	Signal Ground	N/A
8,9	No Connection	

The serial input port will accept almost any type of RS-232C serial device such as:

- Electronic scales
- Table top laser scanners
- Side scan laser scanners
- Portable & fixed terminals

## CONNECTING AN ELECTRONIC SCALE TO THE BAR CODE READER

The M2000/2002 reader will interface with almost any electronic scale that has an RS-232C serial interface port. To connect an electronic scale to the bar code reader, perform the following steps:

- Connect a serial cable between the scale and the bar code reader's serial input port. Verify that the wiring of the serial cable is correct.
- Program the bar code reader's SERIAL PORT setting for PASS THROUGH MODE (see PROGRAMMING GUIDE section in this manual).
- Program the bar code reader's serial port parameters (BAUD RATE, PARITY, DATA BITS) to match the configuration of the scale.



There are two basic types of scale interfaces:

**INTERFACE TYPE #1:** With this type of scale interface the user presses a button (usually located on the scale's front panel) to transmit the scale data through the serial port. The bar code reader will receive this data from its serial input port, and then transmit the data to the computer through the keyboard interface. To the computer, the data appears to have come from the keyboard.

**INTERFACE TYPE #2:** With this type of scale interface, a command must be sent to the scale to initiate data transfer. The bar code reader must be programmed with a SERIAL COMMAND STRING, as defined under "Serial Port", in the "Programming Guide" section. Once a command is received by the scale, data is transmitted out in the same manner as for "Interface Type #1".

**EXAMPLE:** Toledo 8213 BENCH SCALE (Interface Type #2)

**PROBLEM:** To obtain weight data from the 8213 scale's serial port, which is to be sent to the computer appearing as keyboard input.

**SOLUTION:** The 8213 will send the current weight reading if it receives an ASCII "W" through its serial port. First, program the bar code reader to recognize a "unique" SERIAL COMMAND STRING, i.e., "%A5A%" (5 characters maximum). Next, print a bar code that contains this SERIAL COMMAND STRING followed by a "W". Scan this bar code by the usual means (wand, CCD, or LASER). The bar code reader will beep, indicating a successful read. It will recognize the SERIAL COMMAND STRING at the beginning of the bar code data. Instead of transmitting the bar code data through the keyboard interface, as the reader would normally do, it will strip off the SERIAL COMMAND STRING and transmit only the "W", which will be directed through the serial port to the scale. The scale will receive the "W", recognize it as a request, and transmit its weight data through its serial port. The reader will receive the scale data and transmit it on to the computer through the keyboard interface. To the computer, the data appears to have come from the keyboard. (This entire process takes only a fraction of a second.)

SCALE COMMAND TO TRANSMIT WEIGHT=W  
(UNIQUE) SERIAL COMMAND STRING = %A5A%

Here is the example bar code:



%A5A%W

# SPECIFICATIONS

## BAR CODES SUPPORTED

Auto-discriminates between all of the following codes:

- Code 39
- Extended Code 39 (Full ASCII)
- Interleaved 2 of 5 (Variable and Fixed Length, Check Digit)
- UPC-A (Including 2 and 5 Character Supplements)
- UPC-E(0), UPC-E(1)
- EAN (Including 2 and 5 Character Supplements)
- Codabar
- Code 128
- Code 93
- Code 11
- MSI/Plessey

## INPUT DEVICES SUPPORTED

Laser (Helium-Neon, Visible Laser Diode, Infrared)  
CCD Scanners  
Wands (Visible and Infrared)  
Slot Readers (Or Badge Readers)  
Magnetic Stripe Readers (Single or Dual Track)  
RS-232 Input Port (Electronic Scales, Portable Terminals)

## USER PROGRAMMABLE FEATURES

All features are easily programmed with a bar code menu:

Bar Code Selection:	Preambles/Postambles:	Laser Configuration:
• Enable/Disable	• Bar Code (15 Chars Max)	• Laser Time-Out
• Length	• Mag Stripe (15 Chars Max)	• Trigger Function
• Check Digit	• Serial Port (15 Chars Max)	• Continuous Mode
• Start/Stop Transmit	• Transmit Delay	Computer Type
Beep Tone and Length	Mag Stripe Data Format	Transmit Speed

## RS-232 SERIAL PORT

Baud Rates: 150, 300, 600, 1200, 2400, 4800, 9600, 19.2K  
Parity: NONE, ODD, EVEN, MARK  
Data Bits: 7 or 8  
Signals: Transmit Data, Receive Data, Signal Ground, DTR  
Protocol: NONE, XON/XOFF  
Features: Programmable Termination Character and Timeout

## INDICATORS

Audio "BEEP" Indicates Successful Read  
A Red/Green LED Indicates Status of Reader

## POWER REQUIREMENTS

Reader Receives its Power from the Personal Computer Keyboard Interface.  
Power Consumption = 0.5 Watts. (12V Laser Requires External 12V Supply)

## CONNECTORS

Laser Input: 9 Pin "D" Style  
Wand Input: 5 Pin DIN Style  
Mag Stripe Input: 8 Pin DIN Style  
Keyboard Interface: M2000 = 5 Pin DIN Style  
M2002 = 6 Pin MINI-DIN Style  
RS-232 Input: 9 Pin "D" Style  
External Power Input: 2.5 mm Barrel Connector

## ENVIRONMENTAL

Operating Temperature: 0° to +50° C  
Storage Temperature: -30° to +70° C  
Relative Humidity: 5% to 95%  
(Non-Condensing)

## PHYSICAL SPECIFICATIONS

Weight: 14 Ounces      Width: 5 1/8 Inches  
Length: 5 1/4 Inches      Height: 1 1/2 Inches

# SIGNAL DEFINITIONS

## WAND/MAG STRIPE INTERFACE

PIN	SIGNAL
1	+5V
2	DATA ( $\overline{\text{DATA}}$ - MAG STRIPE)
3	GROUND
4	CLOCK (MAG STRIPE)
5	CARD PRESENT (MAG STRIPE)

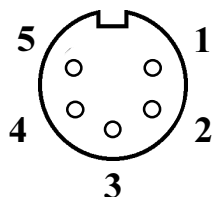

## DUAL MAG STRIPE INTERFACE

PIN	SIGNAL
1	+5V
2	$\overline{\text{DATA}}$ , TRACK 2
3	CLOCK, TRACK 2
4	GROUND
5	$\overline{\text{DATA}}$ , TRACK 1
6	CLOCK, TRACK 1
7	CARD PRESENT
8	GROUND

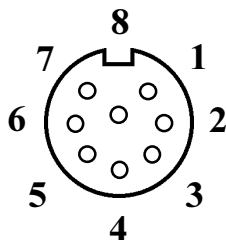

## LASER INTERFACE

PIN	SIGNAL
1	SYNC
2	DATA
3	DECODE LED
4	NO CONNECTION
5	TRIGGER
6	HEAD ENABLE
7	GROUND
8	SHIELD GROUND
9	LASER POWER

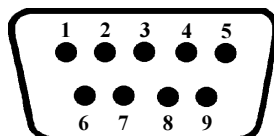

## RS-232C SERIAL INPUT PORT

PIN	SIGNAL
1	SIGNAL GROUND
2	TRANSMIT DATA
3	RECEIVE DATA
4	DATA TERMINAL READY
5,6	NO CONNECTION
7	SIGNAL GROUND
8,9	NO CONNECTION

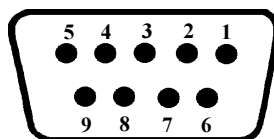

## SIGNAL DEFINITIONS (Cont)

### M2000 KEYBOARD/COMPUTER INTERFACE

PIN	SIGNAL
1	KEYBOARD CLOCK
2	GROUND
3	KEYBOARD DATA
4	+5V
5	SPARE

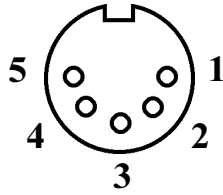

### M2002 KEYBOARD/COMPUTER INTERFACE

PIN	SIGNAL
1	KEYBOARD DATA
2	RESERVED
3	GROUND
4	+5V
5	KEYBOARD CLOCK
6	RESERVED

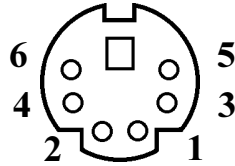

### EXTERNAL POWER SUPPLY INTERFACE

CONNECTOR: FEMALE BARREL 2.5mm x 5.5mm (9 - 12 VDC center positive)



**NOTE: THE EXTERNAL POWER SUPPLY PROVIDES  
POWER TO THE LASER INTERFACE ONLY.**

## APPENDIX A - FUNCTION & SPECIAL KEYS

With FUNCTION KEYS enabled, the decoder can accept a given ASCII character and transmit a corresponding FUNCTION KEY to the computer. The ASCII characters and values are listed in the table below.

ASCII CHARACTERS	FUNCTION KEYS	ASCII VALUES
DC1	F1	17
DC2	F2	18
DC3	F3	19
DC4	F4	20
NAK	<sup>26</sup> F5	21
SYN	F6	22
ETB	F7	23
CAN	F8	24
EM	F9	25
SUB	F10	26

## SPECIAL KEYS

With SPECIAL KEYS enabled, the decoder can accept a given ASCII character and transmit a corresponding SPECIAL KEY to the computer. The ASCII characters and values are listed in the table below.

ASCII CHARACTERS	SPECIAL KEYS	ASCII VALUES
SOH	(Left Arrow)	1
STX	(Right Arrow)	2
ETX	(Up Arrow)	3
EOT	(Down Arrow)	4
ENQ	HOME	5
ACK	END	6
BEL	DELETE	7
VT	PAGE UP	11
FF	PAGE DOWN	12
SO	SHIFT ON	14
SI	SHIFT OFF	15
DLE	INS	16
FS	CTRL ON	28
GS	CTRL OFF	29
RS	ALT ON	30
US	ALT OFF	31

## APPENDIX B - EXTERNAL POWER SUPPLY REQUIREMENTS

The MODEL 2000/2002 can support both 12V and 5V LASERS (and CCD scanners). The power source for the "LASER" connector on the front panel of the reader is determined by a jumper located inside the enclosure.

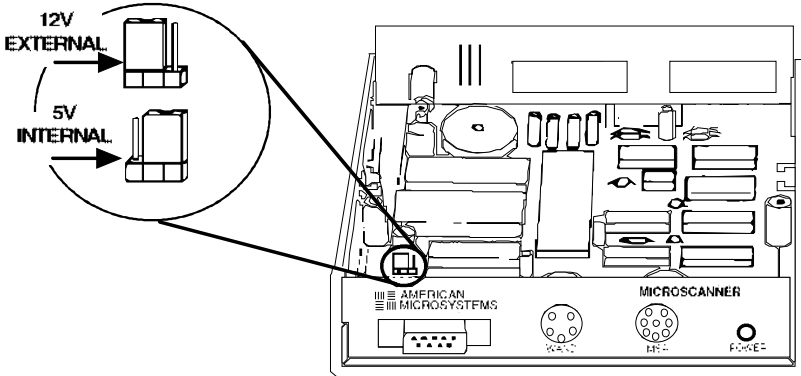

When the jumper is set to the 12V or EXTERNAL position, 12V power is taken from the external power supply. In this configuration an external 12V power supply **MUST** be connected to the reader.

When the jumper is set to the 5V or INTERNAL position, 5V power is taken from the personal computer via the keyboard interface. In this configuration an external power supply is **NOT** required.

The following table lists various configuration requirements:

INPUT DEVICE	POWER REQUIREMENT	JUMPER POSITION	EXTERNAL POWER SUPPLY REQUIRED
LASER	12V	EXTERNAL	YES
LASER	5V	INTERNAL	NO
C C D	5V	INTERNAL	NO

**NOTE:** The reader is shipped from the factory with the jumper set to the INTERNAL position. This position **DOES NOT** require an external power supply for laser operation.

## APPENDIX C - CODE 39 SPECIFICATIONS

Code 39 is a variable length alphanumeric code. Each character is made up of nine elements, five bars and four spaces. Three of the elements are wide and six are narrow. Code 39 is a popular choice for applications because:

- it is easy to print with low cost dot matrix printers
- large character set (A-Z, 0-9, 7 special characters)
- code can be extended to include the entire 128 ASCII character set
- variable length



### CHARACTERISTICS:

Character Set:	26 uppercase letters (A - Z) 10 digits (0 - 9) 7 special characters (SPACE -. \$/ + %)
Symbol Length:	Variable
Check Digit:	Optional
Bi-directional Decoding:	Yes
Maximum Density:	9.8 char./inch (using .0075 inch narrow element)

CODE 39 CHARACTER SET:

Char-acter	Pattern	Bars	Spaces	Char-acter	Pattern	Bars	Spaces
1		10001	0100	M		11000	0001
2		01001	0100	N		00101	0001
3		11000	0100	O		10100	0001
4		00101	0100	P		01100	0001
5		10100	0100	Q		00011	0001
6		01100	0100	R		10010	0001
7		00011	0100	S		01010	0001
8		10010	0100	T		00110	0001
9		01010	0100	U		10001	1000
0		00110	0100	V		01001	1000
A		10001	0010	W		11000	1000
B		01001	0010	X		00101	1000
C		11000	0010	Y		10100	1000
D		00101	0010	Z		01100	1000
E		10100	0010	-		00011	1000
F		01100	0010	.		10010	1000
G		00011	0010	Space		01010	1000
H		10010	0010	*		00110	1000
I		01010	0010	\$		00000	1110
J		00110	0010	/		00000	1101
K		10001	0001	+		00000	1011
L		01001	0001	%		00000	0111

An optional check character can be used for applications requiring higher levels of data security. When used, the check character immediately follows the last data character. The check digit is calculated as follows:

1. Each data character is assigned a numerical value as shown in the following table:

CHAR	VALUE	CHAR	VALUE	CHAR	VALUE
0	0	F	15	U	30
1	1	G	16	V	31
2	2	H	17	W	32
3	3	I	18	X	33
4	4	J	19	Y	34
5	5	K	20	Z	35
6	6	L	21	-	36
7	7	M	22	.	37
8	8	N	23	SPACE	38
9	9	O	24	\$	39
A	10	P	25	/	40
B	11	Q	26	+	41
C	12	R	27	%	42
D	13	S	28		
E	14	T	29		



2. Sum all of the numerical values for each data character in the bar code.
3. Divide this sum by 43.
4. The remainder is the numerical value for the check digit. Use the table in step 1 to look-up the corresponding character.

EXAMPLE: Sample Code 39 data = A394T

1. Use the table to lookup the numerical value for each character.
2.  $10 + 3 + 9 + 4 + 29 = 55$
3.  $55 / 43 = 1$  remainder 12
4. Check digit numerical value = 12  
The check digit = C.  
Bar code with check digit = A394TC

## APPENDIX D - FULL ASCII EXTENSION TO CODE 39

The FULL ASCII EXTENSION expands standard CODE 39 to include the entire 128 ASCII character set. This is accomplished by pairing standard CODE 39 characters. The \$, +, /, and % characters are paired as shown in the following table:

ASCII CODE	ASCII CODE	ASCII CODE	ASCII CODE	ASCII CODE	ASCII CODE	ASCII CODE	ASCII CODE
NUL	%U	!	/A	A	A	a	+A
SOH	\$A	"	/B	B	B	b	+B
STX	\$B	#	/C	C	C	c	+C
ETX	\$C	\$	/D	D	D	d	+D
EOT	\$D	%	/E	E	E	e	+E
ENQ	\$E	&	/F	F	F	f	+F
ACK	\$F	'	/G	G	G	g	+G
BEL	\$G	(	/H	H	H	h	+H
BS	\$H	)	/I	I	I	i	+I
HT	\$I	*	/J	J	J	j	+J
LF	\$J	+	/K	K	K	k	+K
VT	\$K	,	/L	L	L	l	+L
FF	\$L	-	-	M	M	m	+M
CR	\$M	.	.	N	N	n	+N
SO	\$N	/	/O	O	O	o	+O
SI	\$O	0	0 or /P	P	P	p	+P
DLE	\$P	1	1 or /Q	Q	Q	q	+Q
DC1	\$Q	2	2 or /R	R	R	r	+R
DC2	\$R	3	3 or /S	S	S	s	+S
DC3	\$S	4	4 or /T	T	T	t	+T
DC4	\$T	5	5 or /U	U	U	u	+U
NAK	\$U	6	6 or /V	V	V	v	+V
SYN	\$V	7	7 or /W	W	W	w	+W
ETB	\$W	8	8 or /X	X	X	x	+X
CAN	\$X	9	9 or /Y	Y	Y	y	+Y
EM	\$Y	:	/Z	Z	Z	z	+Z
SUB	\$Z	;	%F	[	%K	{	%P
ESC	%A	<	%G	\	%L		%Q
FS	%B	=	%H	]	%M	}	%R
GS	%C	>	%I	^	%N	~	%S
RS	%D	?	%J	_	%O	DEL	%T,%X,
US	%E	@	%V	`	%W		%Y or
SP	SPACE						%Z

## APPENDIX E - UPC SPECIFICATIONS

The Universal Product Code (UPC) symbols can be found on almost all retail products today. The UPC coding system was designed to uniquely identify a product and its manufacturer.

### UPC VERSION A

UPC-A is a fixed length (12 digits) numeric only code with the following features:

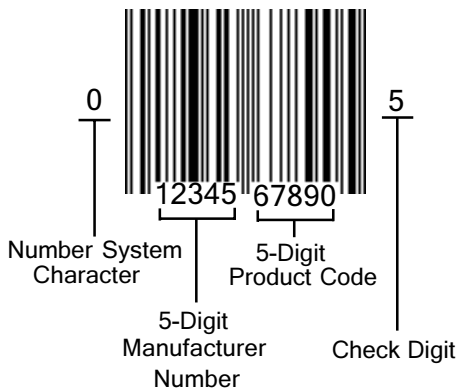

### UPC-A BAR CODE

The NUMBER SYSTEM CHARACTER indicates the type of product the symbol is identifying:

- 0,7 Regular UPC codes with numbers assigned by the Uniform Code Council (see appendix on bar code sources).
- 2 Random-weight items such as meat and produce.
- 3 National Drug Code and National Health Related Items Code.
- 4 For in-store marking of non-food items.
- 5 Reserved for coupons.
  
- 1,6,8,9 Reserved for future use.

The last digit in UPC bar codes is a MODULO 10 CHECK DIGIT. It is calculated in the following manner:

1. From right to left, sum the digits in the odd positions.
2. Multiply this sum by 3.
3. From right to left, sum the digits in the even positions.
4. Add this sum to the product of step 2.
5. The modulo-10 check digit is the smallest number, which when added to the sum of Step 4 produces a multiple of 10.

EXAMPLE: UPC bar code = 01234567890C where C is the CHECK DIGIT.

1. Sum  $0 + 8 + 6 + 4 + 2 + 0 = 20$
2. Multiply  $20 \times 3 = 60$
3. Sum  $9 + 7 + 5 + 3 + 1 = 25$
4. Sum  $60 + 25 = 85$
5.  $85 + 5 = 90$  (check digit = 5)  
Therefore: UPC bar code - 012345678905

## UPC VERSION E

UPC Version E is a six digit variation of the UPC symbology. The last digit indicates the type of compression used. Because of this data compression process, the version E symbol is often referred to as a zero-suppressed symbol.



The following table illustrates the expansion process for converting UPC-E to its UPC-A equivalent:

Version E Number	Insertion Digits	Insertion Location	Resultant Version A
XXXXX0	00000	Position 3	XX00000XXX
XXXXX1	10000	Position 3	XX10000XXX
XXXXX2	20000	Position 3	XX20000XXX
XXXXX3	00000	Position 4	XXX00000XX
XXXXX4	00000	Position 5	XXXX00000X
XXXXX5	0000	Position 6	XXXXX00005
XXXXX6	0000	Position 6	XXXXX00006
XXXXX7	0000	Position 6	XXXXX00007
XXXXX8	0000	Position 6	XXXXX00008
XXXXX9	0000	Position 6	XXXXX00009



VERSION E



VERSION A EQUIVALENT

### UPC/EAN SUPPLEMENTS

UPC and EAN bar codes can contain supplements that provide two or five digits of additional information. The supplements are located to the right of standard UPC/EAN labels. The reader can be programmed to either read or ignore the supplements.



## APPENDIX F - EAN SPECIFICATIONS

The European Article Numbering system (EAN) is a superset of UPC. EAN has two versions: EAN-13 (13 digits) and EAN-8 (8 digits).



EAN 13



EAN 8

Country codes 00, 01, 03, 04, and 06 - 09 are assigned to the U.S. for compatibility with UPC.

# APPENDIX G - INTERLEAVED 2 of 5 SPECIFICATIONS

The Interleaved 2 of 5 bar code symbology is a numeric code (0 - 9) which has different start and stop characters. The name Interleaved 2 of 5 is derived from the fact that two characters are paired together using the bars to represent the first character and spaces to represent the second. Each character has two wide elements and three narrow elements.

## CHARACTERISTICS:

- Character Set: Numeric only (0 - 9)
- Symbol Length: Variable (must be an even number of digits)
- Check Digit: Optional
- Bi-directional Decoding: Yes
- Maximum Density: 18 char./inch  
(using .0075 inch narrow element)

## CHARACTER SET:

The following table illustrates the data patterns. A "1" represents a wide bar or space and a "0" represents a narrow bar or space.

CHARACTER	PATTERN
0	00110
1	10001
2	01001
3	11000
4	00101
5	10100
6	01100
7	00011
8	10010
9	01010
start	0000
stop	100



## OPTIONAL CHECK DIGIT:

Interleaved 2 of 5 may contain an optional check digit. The reader supports two types of check digits:

1. Uniform Symbology Specification (USS) - calculated as modulo 10 check digit based on 3-1-3 weightings.
2. Optical Product Code Council (OPCC) - calculated as modulo 10 check digit based on 2-1-2 weightings.

### *USS CHECK DIGIT CALCULATION:*

1. From right to left, sum the digits in the odd positions.
2. Multiply this sum by 3.
3. From right to left, sum the digits in the even positions.
4. Add this sum to the product of step 2.
5. The modulo-10 check digit is the smallest number which when added to the sum of Step 4 produces a multiple of 10.

EXAMPLE: USS check digit. Sample bar code data:  
513827

1. Sum  $7 + 8 + 1 = 16$
2. Multiply  $16 \times 3 = 48$
3. Sum  $2 + 3 + 5 = 10$
4. Sum  $48 + 10 = 58$
5.  $58 + 2 = 60$  (check digit = 2)

Therefore: Data + check digit = 5138272

NOTE: A leading zero will be required to make it an even number of characters. The resulting bar code will be:  
05138272

### *OPCC CHECK DIGIT CALCULATION:*

1. From right to left, assign every digit a weighting factor from the sequence: 2,1,2,1,2,1,2,1,...
2. Multiply each digit by its weighting factor.
3. Sum the products in step 2, treating two digit products as the sum of the individual digits.
4. The check digit is the smallest number which when added to the sum of step 3 produces a multiple of 10.

EXAMPLE: OPCC check digit

Sample bar code data: 020489713

1. Assign weighting factors: 020489713 212121212
2. Calculate the products: 0 2 0 4 16 9 14 1 6
3. Sum the products:  $0+2+0+4+1+6+9+1+4+1+6 = 34$
4.  $34 + 6 = 40$  (check digit = 6)

Therefore: Data + check digit = 0204897136



# APPENDIX H - CODABAR SPECIFICATIONS

The Codabar bar code symbology is a numeric code (0 - 9) that also contains six special characters and four start/stop characters. The start/stop characters may or may not be transmitted. Characters are constructed of four bars and three spaces. Codabar is commonly used in libraries, blood banks, cotton industry, and the transportation industry.

## CHARACTERISTICS:

Character Set: 10 digits (0 - 9)  
6 special characters (- \$ : / . +)  
4 stop/start characters (a b c d)

Symbol Length: Variable

Check Digit: Optional

Bi-directional Decoding: Yes

Maximum Density: 12.8 char./inch  
(using .0075 inch narrow element)

## CHARACTER SET:

The following table illustrates the data patterns. A "1" represents a wide bar or space and a "0" represents a narrow bar or space.

CHARACTER	PATTERN
0	000011
1	000110
2	0001001
3	1100000
4	0010010
5	1000010
6	0100001
7	0100100
8	0110000
9	1001000
-	0001100
\$	0011000
:	1000101
/	1010001
.	1010100
+	0010101
a	0011010
b	0101001
c	0001011
d	0001110



A123456B

# APPENDIX I - CODE 128 SPECIFICATIONS

The CODE 128 symbology is a variable length alphanumeric code containing the full 128 ASCII character set. Each character is made up of 11 modules containing three bars and three spaces. Bars and spaces can be from 1 to 4 modules wide. Three different start characters are used to select one of three character sets. Code 128 is the bar code of choice for new applications.

## CHARACTERISTICS:

- Character Set: All 128 ASCII characters  
4 function characters  
4 code set selection characters  
3 start/stop characters
- Symbol Length: Variable
- Check Character: 1
- Bi-directional Decoding: Yes
- Maximum Density: 12.1 alphanumeric char./inch  
24.2 numeric digits/inch  
(using .0075 inch module element)



0123456789



ABCD123

## UCC-128 MOD 10 SERIAL SHIPPING CONTAINER CODE:

### FORMAT:

STARTC FNC1 0000012345555555555 8 C STOP  
 (1) (2) (3) (4) (5) (6)

- 1. Start Code "C"
- 2. FNC1 Character
- 3. 19 Digits
- 4. MOD 10 Check Digit
- 5. MOD 103 Check Digit
- 6. Stop Code



0000012345555555555

CHARACTER SET:

The following table contains the character set for Code 128 subsets A, B, and C:

CODE 128 (USD-6)

VALUE	CODE A	CODE B	CODE C	BAR PATTERN					
				B	S	B	S	B	S
0	SP	SP	00	2	1	2	2	2	2
1	!	!	01	2	2	2	1	2	2
2	"	"	02	2	2	2	2	2	1
3	#	#	03	1	2	1	2	2	3
4	\$	\$	04	1	2	1	3	2	2
5	%	%	05	1	3	1	2	2	2
6	&	&	06	1	2	2	2	1	3
7	'	'	07	1	2	2	3	1	2
8	(	(	08	1	3	2	2	1	2
9	)	)	09	2	2	1	2	1	3
10	*	*	10	2	2	1	3	1	2
11	+	+	11	2	3	1	2	1	2
12	,	,	12	1	1	2	2	3	2
13	-	-	13	1	2	2	1	3	2
14	.	.	14	1	2	2	2	3	1
15	/	/	15	1	1	3	2	2	2
16	0	0	16	1	2	3	1	2	2
17	1	1	17	1	2	3	2	2	1
18	2	2	18	2	2	3	2	1	1
19	3	3	19	2	2	1	1	3	2
20	4	4	20	2	2	1	2	3	1
21	5	5	21	2	1	3	2	1	2
22	6	6	22	2	2	3	1	1	2
23	7	7	23	3	1	2	1	3	1
24	8	8	24	3	1	1	2	2	2
25	9	9	25	3	2	1	1	2	2
26	:	:	26	3	2	1	2	2	1
27	;	;	27	3	1	2	2	1	2
28	<	<	28	3	2	2	1	1	2
29	=	=	29	3	2	2	2	1	1
30	>	>	30	2	1	2	1	2	3
31	?	?	31	2	1	2	3	2	1
32	@	@	32	2	3	2	1	2	1
33	A	A	33	1	1	1	3	2	3
34	B	B	34	1	3	1	1	2	3
35	C	C	35	1	3	1	3	2	1
36	D	D	36	1	1	2	3	1	3
37	E	E	37	1	3	2	1	1	3
38	F	F	38	1	3	2	3	1	1
39	G	G	39	2	1	1	3	1	3
40	H	H	40	2	3	1	1	1	3
41	I	I	41	2	3	1	3	1	1
42	J	J	42	1	1	2	1	3	3
43	K	K	43	1	1	2	3	3	1
44	L	L	44	1	3	2	1	3	1
45	M	M	45	1	1	3	1	2	3

CODE 128 (USD-6)

VALUE	CODE A	CODE B	CODE C	BAR PATTERN					
				B	S	B	S	B	S
46	N	N	46	1	1	3	3	2	1
47	O	O	47	1	3	3	1	2	1
48	P	P	48	3	1	3	1	2	1
49	Q	Q	49	2	1	1	3	3	1
50	R	R	50	2	3	1	1	3	1
51	S	S	51	2	1	3	1	1	3
52	T	T	52	2	1	3	3	1	1
53	U	U	53	2	1	3	1	3	1
54	V	V	54	3	1	1	1	2	3
55	W	W	55	3	1	1	3	2	1
56	X	X	56	3	3	1	1	2	1
57	Y	Y	57	3	1	2	1	1	3
58	Z	Z	58	3	1	2	3	1	1
59	[	[	59	3	3	2	1	1	1
60	\	\	60	3	1	4	1	1	1
61	]	]	61	2	2	1	4	1	1
62	^	^	62	4	3	1	1	1	1
63	_	_	63	1	1	1	2	2	4
64	NUL	`	64	1	1	1	4	2	2
65	SOH	a	65	1	2	1	1	2	4
66	STX	b	66	1	2	1	4	2	1
67	ETX	c	67	1	4	1	1	2	2
68	EOT	d	68	1	4	1	2	2	1
69	ENQ	e	69	1	1	2	2	1	4
70	ACK	f	70	1	1	2	4	1	2
71	BEL	g	71	1	2	2	1	1	4
72	BS	h	72	1	2	2	4	1	1
73	HT	i	73	1	4	2	1	1	2
74	LF	j	74	1	4	2	2	1	1
75	VT	k	75	2	4	1	2	1	1
76	FF	l	76	2	2	1	1	1	4
77	CR	m	77	4	1	3	1	1	1
78	SO	n	78	2	4	1	1	1	2
79	SI	o	79	1	3	4	1	1	1
80	DLE	p	80	1	1	1	2	4	2
81	DC1	q	81	1	2	1	1	4	2
82	DC2	r	82	1	2	1	2	4	1
83	DC3	s	83	1	1	4	2	1	2
84	DC4	t	84	1	2	4	1	1	2
85	NAK	u	85	1	2	4	2	1	1
86	SYN	v	86	4	1	1	2	1	2
87	ETB	w	87	4	2	1	1	1	2
88	CAN	x	88	4	2	1	2	1	1
89	EM	y	89	2	1	2	1	4	1
90	SUB	z	90	2	1	4	1	2	1

CODE 128 (USD-6)

VALUE	CODE A	CODE B	CODE C	BAR PATTERN					
				B	S	B	S	B	S
91	ESC	{	91	4	1	2	1	2	1
92	FS		92	1	1	1	1	4	3
93	GS	}	93	1	1	1	3	4	1
94	RS	~	94	1	3	1	1	4	1
95	US	DEL	95	1	1	4	1	1	3
96	FNC 3	FNC 3	96	1	1	4	3	1	1
97	FNC 2	FNC 2	97	4	1	1	1	1	3
98	SHIFT	SHIFT	98	4	1	1	3	1	1
99	CODE C	CODE C	99	1	1	3	1	4	1
100	CODE B	FNC 4	CODE B	1	1	4	1	3	1
101	FNC 4	CODE A	CODE A	3	1	1	1	4	1
102	FNC 1	FNC 1	FNC 1	4	1	1	1	3	1

			B	S	B	S	B	S
103	START (CODE A)		2	1	1	4	1	2
104	START (CODE B)		2	1	1	2	1	4
105	START (CODE C)		2	1	1	2	3	2

		B	S	B	S	B	S	B
	STOP	2	3	3	1	1	1	2

# APPENDIX J - CODE 93 SPECIFICATIONS

The Code 93 bar code symbology is a variable length alphanumeric code containing the full 128 ASCII character set. Each character is made up of 9 modules with three bars and three spaces. The bars can be 1, 2, or 3 modules wide except for the start/stop character. The spaces can be 1, 2, 3, or 4 modules wide. Code 93 bar codes contain a mandatory two digits for data integrity.

## CHARACTERISTICS

Character Set:	128 ASCII character set
Symbol Length:	Variable
Check Digit:	2
Bi-directional Decoding:	Yes
Maximum Density:	14.8 char./inch (using .0075 inch narrow element)

## CHARACTER SET

The following tables represent Code 93 data. Table 1 defines all of the USS-93 character assignments. Table 2 shows the full ASCII character set with the special control characters.

Table 1. USS-93 Character Assignments

Character	Value (for Check Digit Purposes)	Pattern	Encoding	Character	Value (for Check Digit Purposes)	Pattern	Encoding
0	0		100010100	O	24		100101100
1	1		101001000	P	25		100010110
2	2		101000100	Q	26		110110100
3	3		101000010	R	27		110110010
4	4		100101000	S	28		110101100
5	5		100100100	T	29		110100110
6	6		100100010	U	30		110010110
7	7		101010000	V	31		110011010
8	8		100010010	W	32		101101100
9	9		100001010	X	33		101100110
A	10		110101000	Y	34		100110110
B	11		110100100	Z	35		100111010
C	12		110100010	-	36		100101110
D	13		110010100	.	37		111010100
E	14		110010010	Space	38		111010010
F	15		110001010	\$	39		111001010
G	16		101101000	/	40		101101110
H	17		101100100	+	41		101110110
I	18		101100010	%	42		110101110
J	19		100110100	Ⓢ	43		100100110
K	20		100011010	Ⓢ	44		111011010
L	21		101011000	Ⓣ	45		111010110
M	22		101001100	Ⓟ	46		100110010
N	23		101000110	Ⓡ			101011110

Table 2. Encoding the Full ASCII Character Set

ASCII	CODE 93	ASCII	CODE 93	ASCII	CODE 93	ASCII	CODE 93
NUL	(%) U	SP	Space	@	(%) V	`	(%) W
SOH	(%) A	!	(/) A	A	A	a	(%) A
STX	(%) B	"	(/) B	B	B	b	(+) B
ETX	(%) C	#	(/) C	C	C	c	(+) C
EOT	(%) D	\$	(%) S	D	D	d	(+) D
ENQ	(%) E	%	(%) %	E	E	e	(+) E
ACK	(%) F	&	(/) F	F	F	f	(+) F
BEL	(%) G	'	(/) G	G	G	g	(+) G
BS	(%) H	(	(/) H	H	H	h	(+) H
HT	(%) I	)	(/) I	I	I	i	(+) I
LF	(%) J	*	(/) J	J	J	j	(+) J
VT	(%) K	+	(%) +	K	K	k	(+) K
FF	(%) L	,	(/) L	L	L	l	(+) L
CR	(%) M	-	(%) -	M	M	m	(+) M
SO	(%) N	.	(%) .	N	N	n	(+) N
SI	(%) O	/	(%) /	O	O	o	(+) O
DLE	(%) P	0	(%) 0	P	P	p	(+) P
DC1	(%) Q	1	(%) 1	Q	Q	q	(+) Q
DC2	(%) R	2	(%) 2	R	R	r	(+) R
DC3	(%) S	3	(%) 3	S	S	s	(+) S
DC4	(%) T	4	(%) 4	T	T	t	(+) T
NAK	(%) U	5	(%) 5	U	U	u	(+) U
SYN	(%) V	6	(%) 6	V	V	v	(+) V
ETB	(%) W	7	(%) 7	W	W	w	(+) W
CAN	(%) X	8	(%) 8	X	X	x	(+) X
EM	(%) Y	9	(%) 9	Y	Y	y	(+) Y
SUB	(%) Z	:	(/) Z	Z	Z	z	(+) Z
ESC	(%) A	;	(%) F	[	(%) K	{	(%) P
FS	(%) B	<	(%) G	\	(%) L	;	(%) Q
GS	(%) C	=	(%) H	]	(%) M	}	(%) R
RS	(%) D	>	(%) I	^	(%) N	~	(%) S
US	(%) E	?	(%) J	_	(%) O	DEL	(%) T



0123456789

# APPENDIX K

## CARD DATA FORMAT FOR TRANSACTION CARDS

	Recording Density (bits per inch)	Character Configuration (includes Parity)	Information Content (Max characters)
TRACK 1	210 bpi	7 bits per char.	79 alpha-numeric
TRACK 2	75 bpi	5 bits per char.	40 numeric
TRACK 3	210 bpi	5 bits per char.	107 numeric

TRACK	COMMON FIELD ENCODING							
1	Start Sentinel	Account Number	Field Separator	Name	Field Separator	Exp Date & Addit'l Data	End Sentinel	LRC Char.
2	Start Sentinel	Account Number	Field Separator	Exp Date & Addit'l Data	End Sentinel	LRC Char.		
3	Start Sentinel	Account Number	Field Separator	Use & Security*	Addit'l Data*	End Sentinel	LRC Char.	

- NOTES: Track 3 Use & Security Data includes the following:
- Country Code (opt) 3 or FS
  - Currency Code 3
  - Currency Exponent 1
  - Amt. Authorized Per Cycle 4
  - Amt. Remaining This Cycle 4
  - Cycle Begin (Validity Date) 4
  - Cycle Length 2
  - Reentry Count 1
  - \*Pin Control Param. (opt.) 6 or FS
  - Interchange Control 1
  - Acct. No. Service Restriction 2
  - SAN-1 Service Restriction 2
  - SAN-2 Service Restriction 2
  - Expiration Date (opt.) 4 or FS
  - Card Sequence Number 1
  - Card Security No. (opt) 9 or FS
- Track 3 Additional Data includes the following:
- First Subsidiary Acct. No. (opt.)
  - Second Subsidiary Acct No. (opt.)
  - Relay Marker 1
  - Cryptographic Chk Digits (opt.) 6 or FS
  - Discretionary Data

### NON-STANDARD USE OF MAGNETIC STRIPE DATA

Many applications exist for non-standard use of the magnetic stripe card, such as access control, inventory, data entry, insurance information, medical, etc.... In those applications the data content, code, format and even densities can be changed to fit the application.



## APPENDIX L - SOURCES OF BAR CODE AND MAGNETIC STRIPE STANDARDS

ABC (American Blood Commission)  
1117 North 19th Street  
Suite 501  
Arlington, VA 22209-1749  
(703) 522-8414

- \* Committee for Commonality in Blood Banking Automation (CCBBA)  
Report (Codabar)

AIM (Automatic Identification Manufacturers Inc.)  
1326 Freeport Road  
Pittsburgh, PA 15238  
(412) 963-8588

- \* USD-1 (Interleaved 2 of 5)
- \* USD-2 (A Subset of Code 39)
- \* USD-3 (Code 39)
- \* USD-4 (Codabar)
- \* USD-6 (Code 128)
- \* USD-7 (Code 93)
- \* USD-8 (Code 11)

AIAG (Automotive Industry Action Group)  
26200 Lahser Road  
Suite 200  
Southfield, MI 48034  
(313) 358-3570

- \* AIAG-B-1 1984 Bar Code Symbology Standard
- \* AIAG-B-3 Shipping/Parts Identification Label Standard
- \* AIAG-B-6 Standard for Bar Code Data Identifiers

ANSI (American National Standards Institute)  
11 West 42nd Street  
New York, NY 10036  
(212)624-4900

- \* ANSI MH10.8M-1983 Specification for Bar Code Symbols on Transport  
Packages and Unit Loads. (Code 39, Interleaved 2 of 5, Codabar)
- \* ANSI X3A1.3 Bar Code Print Quality (Draft)

- \* ANSI X4.16-1983 Specifications for Magnetic Stripe Encoding (Financial Transaction Cards)
- \* ANSI X4.13-1983 Specifications for Financial Services - Financial Transaction Cards
- \* ANSI X9.1-1984 Specifications for Track 3 Magnetic Stripe Data Content

DOD (Department of Defense)  
 Naval Publications & Forms Center  
 5801 Tabor Avenue  
 Philadelphia, PA 19120  
 (215) 697-2000

- \* MIL-STD-1189A (B) - Standard Department of Defense Bar Code Symbology
- \* MIL-STD-129J - Military Standard - Marking for Shipment & Storage - Bar Code Markings
- \* FED-STD-123D - Federal Standard - Marking for Shipment (Civil Agencies) Bar Code Markings

EAN (International Article Numbering Association)  
 Rue des Colonies, Bte 8  
 1000 Brussels  
 BELGIUM  
 011 322 218 7585

HIBCC (Health Industry Business Communications Council)  
 5110 North 40th Street, Suite 250  
 Phoenix, AZ 85018  
 (602) 381-1091

- \* HIBC Supplier Labeling Standard
- \* HIBC Provider Applications Standard
- \* HIBC Guidelines

UCC (Uniform Code Council)  
 8163 Old Yankee Rd., Suite J  
 Dayton, OH 45458  
 (513) 435-3870

- \* UPC Symbol Specification
- \* UPC Location Guidelines
- \* UPC Shipping Container Symbol Specifications Manual
- \* UPC Industrial Code Guidelines Manual
- \* UPC Film Master Verification Manual