



AT-FS724L

Fast Ethernet Switch

Installation Guide

Copyright © 2003 Allied Telesyn, Inc.
960 Stewart Drive, Suite B, Sunnyvale, CA 94085, USA

All rights reserved. No part of this publication may be reproduced without prior written permission from Allied Telesyn, Inc.

Ethernet is a registered trademark of Xerox Corporation. All other product names, company names, logos or other designations mentioned herein are trademarks or registered trademarks of their respective owners.

Allied Telesyn, Inc. reserves the right to make changes in specifications and other information contained in this document without prior written notice. The information provided herein is subject to change without notice. In no event shall Allied Telesyn, Inc. be liable for any incidental, special, indirect, or consequential damages whatsoever, including but not limited to lost profits, arising out of or related to this manual or the information contained herein, even if Allied Telesyn, Inc. has been advised of, known, or should have known, the possibility of such damages.

Electrical Safety and Emission Compliance Statement

Standards: This product meets the following standards.

U.S. Federal Communications Commission

Declaration Of Conformity

Manufacturer Name: Allied Telesyn, Inc.
Manufacturer Address: 960 Stewart Drive, Suite B
Sunnyvale, CA 94085, USA
Manufacturer Telephone: 408-730-0950
Declares that the product: Fast Ethernet Switch
Model Number: AT-FS724L

This product complies with FCC Part 15B, Class B Limits:

This device complies with part 15 of the FCC Rules. Operation is subject to the following two conditions: (1) This device must not cause harmful interference, and (2) this device must accept any interference received, including interference that may cause undesired operation.

Radiated Energy

Note: This equipment has been tested and found to comply with the limits for a Class B digital device pursuant to Part 15 of FCC Rules. These limits are designed to provide reasonable protection against harmful interference in a residential installation. This equipment generates, uses and can radiate radio frequency energy and, if not installed and used in accordance with instructions, may cause harmful interference to radio or television reception, which can be determined by turning the equipment off and on. The user is encouraged to try to correct the interference by one or more of the following measures:

- Reorient or relocate the receiving antenna.
- Increase the separation between the equipment and the receiver.
- Connect the equipment into an outlet on a circuit different from that to which the receiver is connected.
- Consult the dealer or an experienced radio/TV technician for help.

Changes and modifications not expressly approved by the manufacturer or registrant of this equipment can void your authority to operate this equipment under Federal Communications Commission rules.

Industry Canada

This Class B digital apparatus meets all requirements of the Canadian Interference-Causing Equipment Regulations.

Cet appareil numérique de la classe B respecte toutes les exigences du Règlement sur le matériel brouilleur du Canada.

RFI Emission

FCC Class B, EN55022 Class B,
VCCI Class B, C-TICK  1



Warning: In a domestic environment this product may cause radio interference in which case the user may be required to take adequate measures.  2

Immunity

EN55024  3

Electrical Safety

EN60950 (TUV), UL60950 (cUL_{us})  4

Important: Appendix B contains translated safety statements for installing this equipment. When you see the , go to Appendix B for the translated safety statement in your language.

Wichtig: Anhang B enthält übersetzte Sicherheitshinweise für die Installation dieses Geräts. Wenn Sie  sehen, schlagen Sie in Anhang B den übersetzten Sicherheitshinweis in Ihrer Sprache nach.

Vigtigt: Tillæg B indeholder oversatte sikkerhedsadvarsler, der vedrører installation af dette udstyr. Når De ser symbolet , skal De slå op i tillæg B og finde de oversatte sikkerhedsadvarsler i Deres eget sprog.

Belangrijk: Appendix B bevat vertaalde veiligheidsopmerkingen voor het installeren van deze apparatuur. Wanneer u de  ziet, raadpleeg Appendix B voor vertaalde veiligheidsinstructies in uw taal.

Important: L'annexe B contient les instructions de sécurité relatives à l'installation de cet équipement. Lorsque vous voyez le symbole , reportez-vous à l'annexe B pour consulter la traduction de ces instructions dans votre langue.

Tärkeää: Liite B sisältää tämän laitteen asentamiseen liittyvät käännetyt turvaohjeet. Kun näet -symbolin, katso käännettyä turvaohjetta liitteestä B.

Importante: l'Appendice B contiene avvisi di sicurezza tradotti per l'installazione di questa apparecchiatura. Il simbolo , indica di consultare l'Appendice B per l'avviso di sicurezza nella propria lingua.

Viktig: Tillegg B inneholder oversatt sikkerhetsinformasjon for installering av dette utstyret. Når du ser , åpner du til Tillegg B for å finne den oversatte sikkerhetsinformasjonen på ønsket språk.

Importante: O Anexo B contém advertências de segurança traduzidas para instalar este equipamento. Quando vir o símbolo , leia a advertência de segurança traduzida no seu idioma no Anexo B.

Importante: El Apéndice B contiene mensajes de seguridad traducidos para la instalación de este equipo. Cuando vea el símbolo , vaya al Apéndice B para ver el mensaje de seguridad traducido a su idioma.

Obs! Bilaga B innehåller översatta säkerhetsmeddelanden avseende installationen av denna utrustning. När du ser , skall du gå till Bilaga B för att läsa det översatta säkerhetsmeddelandet på ditt språk.

Table of Contents

Electrical Safety and Emission Compliance Statement	iii
Table of Contents	v
Welcome to Allied Telesyn	vii
Where to Find Related Guides	vii
Document Conventions	vii
Contacting Allied Telesyn	viii
Online Support	viii
E-mail and Telephone Support	viii
Returning Products	viii
For Sales or Corporate Information	viii
Chapter 1	
Overview	1
Key Features	2
Status LEDs	3
Twisted Pair Ports	3
Port Speed	3
Duplex Mode	4
Auto MDI/MDI-X	4
MAC Address Table	5
Store and Forward	6
Backpressure and Flow Control	6
Internal Power Supply	7
Network Topologies	8
Power Workgroup Topology	8
Cascade Topology	9
Chapter 2	
Installation	11
Verifying the Package Contents	11
Planning the Installation	12
Selecting a Site	12
Reviewing Safety Guidelines	13
Installing the Switch on a Table or Desktop	14
Rackmounting the Switch	15
Warranty Registration	17

Chapter 3

Troubleshooting 19

Appendix A

Technical Specifications 21

Physical 21

Environmental 21

Electrical Rating 22

Agency Compliance..... 22

Pinout Assignments..... 23

Appendix A

Translated Safety and Emission Information 25

Welcome to Allied Telesyn

This guide contains instructions on how to install the AT-FS724L Fast Ethernet Switch.

Where to Find Related Guides

The Allied Telesyn web site at **www.alliedtelesyn.com** offers you an easy way to access the most recent documentation, software, and technical information for all of our products. For product guides, select “Support & Services” from our web site.

Document Conventions

This guide uses the following conventions:

Note

Notes provide additional information.



Caution

Caution informs you that performing or omitting a specific action may result in equipment damage or loss of data.



Warning

Warnings informs you that performing or omitting a specific action may result in bodily injury.

Contacting Allied Telesyn

This section provides Allied Telesyn contact information for technical support as well as sales or corporate information.

Online Support

You can request technical support online by accessing the Allied Telesyn Knowledge Base from the following web site: **<http://kb.alliedtelesyn.com>**. You can use the Knowledge Base to submit questions to our technical support staff and review answers to previously asked questions.

E-mail and Telephone Support

For Technical Support via E-mail or telephone, refer to the Support & Services section of the Allied Telesyn web site: **<http://www.alliedtelesyn.com>**.

Returning Products

Products for return or repair must first be assigned a Return Materials Authorization (RMA) number. A product sent to Allied Telesyn without a RMA number will be returned to the sender at the sender's expense.

To obtain a RMA number, contact Allied Telesyn's Technical Support at our web site: **<http://www.alliedtelesyn.com>**.

For Sales or Corporate Information

You can contact Allied Telesyn for sales or corporate information at our web site: **<http://www.alliedtelesyn.com>**. To find the contact information for your country, select "Contact Us" then "Worldwide Contacts."

Chapter 1

Overview

The AT-FS724L is Fast Ethernet switch that provides simple, cost-effective solutions for switching between 10 Mbps and 100 Mbps.

The AT-FS724L switch features 24 10/100Base-TX twisted pair ports. Each twisted pair port has a RJ-45 connector and a maximum operating distance of 100 meters (328 feet). These ports are capable of Auto-Negotiating at 10 or 100 Mbps and feature half- and full-duplex operation.

The AT-FS724L features an internal power supply and are designed for desktop or rackmount installation.

These switches are easy to install and do not require software configuration or management.

Figure 1 illustrates the front panel of the AT-FS724L switch.

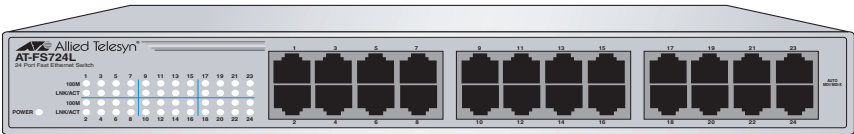

Figure 1 AT-FS724L Front Panel

Table 1 lists the number of ports, connector type, and maximum operating distance for each switch.

Table 1 AT-FS724L Switch

Model	Number of Ports	10/100Base-TX	
		Connector	Maximum Operating Distance
AT-FS724L	24	RJ-45	100 m (328 ft)

Key Features

The AT-FS724L switch has the following key features:

- ❑ 24 10/100Base-TX ports
- ❑ System and port LEDs
- ❑ Auto MDI/MDI-X on all ports
- ❑ Auto-Negotiation on all ports (IEEE 802.3u-compliant)
- ❑ Store and forward switching mode
- ❑ Backpressure and flow control (IEEE 802.3x-compliant)
- ❑ Store and forward packet handling
- ❑ Storage for up to 4,000 MAC addresses
- ❑ MAC address aging time at 300 seconds
- ❑ Embedded 256KB packet buffer or more
- ❑ Broadcast storm protection
- ❑ For use on a desktop or rackmount

Status LEDs

Table 2 lists the status LEDs for the AT-FS724L switch.

Table 2 Status LEDs

LED	Color	Description
POWER	Green	Power is applied to the switch.
	OFF	No power is applied to the switch.
LNK/ACT	Green	A valid link has been established on the port.
	Blinking	The port is transmitting data.
	OFF	A link has not been detected on the port.
100M	Green	The port is operating at 100 Mbps.
	OFF	The port is operating at 10 Mbps.

Twisted Pair Ports

The AT-FS724L switch has 24 10Base-T/100Base-TX twisted pair ports. Each twisted pair port features a RJ-45 connector. The maximum operating distance for the twisted pair ports is 100 meters (328 feet) when operating at either 10 Mbps or 100 Mbps.

Port Speed

The twisted pair ports are compliant with the 10Base-T and 100Base-TX standards and are capable of either 10 Mbps or 100 Mbps operation. Since the ports are IEEE 802.3u Auto-Negotiation compliant, the switch will set the port speed automatically. With Auto-Negotiation, the speed of the ports are set automatically by the switch after it determines the speed of the end-node connected to the port. Auto-Negotiation is designed to ensure that the port on the switch and the end-node are operating at the same speed and that they are communicating at the highest possible common speed between the devices. For example, if an end-node is capable of only 10 Mbps, the switch then sets the port connected to the end-node to 10 Mbps.

Duplex Mode

Duplex mode refers to the way an end-node sends and receives data on the network. An end-node can operate in either half- or full-duplex mode depending on its capabilities. An end-node that is operating in half-duplex mode can either send data or receive data, but it cannot do both at the same time. An end-node that is operating in full-duplex mode can send and receive data simultaneously. The best network performance is achieved when an end-node can operate at full-duplex, since the end-node is able to send and receive data simultaneously.

The twisted pair ports on the AT-FS724L switch can operate in either half-duplex or full-duplex mode and can deliver up to 200 Mbps of bandwidth to the end-nodes. Since these twisted pair ports are IEEE 802.3u-compliant, the duplex mode can be set automatically through Auto-Negotiation. With Auto-Negotiation, if the end-node is capable of full-duplex, the port is set automatically to full-duplex mode. If the end-node is capable of half-duplex, the port is set automatically to half-duplex mode.

Note

In order for the twisted pair port on the AT-FS724L switch to successfully Auto-Negotiate its duplex mode with an end-node, the end-node should also be using Auto-Negotiation. Otherwise, a duplex mode mismatch can occur. The twisted pair port, using Auto-Negotiation, will default to half-duplex if it detects that the end-node is not using Auto-Negotiation. This will result in a mismatch if the end-node is operating at a fixed duplex mode of full-duplex.

Auto MDI/MDI-X

A twisted pair port on a 10 Mbps or 100 Mbps Ethernet network device can have one of two possible wiring configurations: MDI or MDI-X. A twisted pair port on a PC, router, or bridge is typically wired as MDI, while a twisted pair port on a switch or hubs is usually MDI-X.

To connect two 10 Mbps or 100 Mbps network devices together that have dissimilar port wiring configurations, such as an MDI to MDI-X, you would use a straight-through twisted pair cable. To connect two network devices that have the same wiring configuration, such as MDI to MDI, you would use a crossover cable.

The AT-FS724L switch features automatic MDI/MDI-X. The twisted pair port automatically determines the configurations of the port on the device to which it is connected and then configures itself appropriately. For example, if a port on a switch is connected to a port on a bridge, which is typically wired as MDI,

the port on the switch automatically configures itself as MDI-X. This feature allows you to use either a crossover cable or a straight-through cable when connecting a device to a twisted pair port.

MAC Address Table

The heart of an Ethernet switch is the Media Access Control (MAC) address table. Every device that you attach to an Ethernet network has a MAC address. This address is assigned to the device by the device's manufacturer. For example, each Network Interface Card (NIC) that you install into your network computers has a MAC address that was assigned to it by the card's manufacturer.

A switch's MAC address table is a list of the MAC addresses of the devices that are connected to its ports. The switch uses this table to direct data frames to their appropriate destination end-nodes, and in some cases, to discard frames that it receives. The switch creates the MAC address table by examining the frames that it receives on its ports. Each frame is examined for its source address; that is, the MAC address of the end-node that sent the frame. The switch checks to determine whether the address is already in its MAC address table. If it is not, the switch adds the address to the table along with the port number on which the frame was received. The result is a table that contains a list of all the MAC addresses of end-nodes that have sent frames to the switch and the ports on the switch to which the end-nodes are connected.

The switch also checks the destination MAC address of each frame it receives. The destination address is the MAC address of the end-node to which the frame is intended. If the address is in the table, the switch directs the frame directly to the port where the end-node is located. This helps to ensure that end-nodes will only receive traffic that is intended for them and not have to deal with traffic intended for other end-nodes.

If the destination address is not in the MAC address table, the switch broadcasts the frame to all switch ports. When the destination end-node responds, the switch will be able to match the address to a port so that the next time a frame is destined to that particular end-node, the switch will be able to forward the frame to the correct port instead of having to broadcast the frame to all ports.

In some cases a switch will even discard a frame. If the switch receives a frame that is destined to an end-node on the same port on which the frame was received, the switch discards the frame.

The MAC address table in the AT-FS724L switch can store up to 4,000 MAC addresses. To prevent the table from becoming filled with addresses of end-nodes that are no longer active, the switch has a MAC address aging timer.

This timer will delete a MAC address from the table if it does not see a frame from the end-node with the address on any port after five minutes (300 seconds). The aging timer also helps to ensure that the table is correct should an end-node be moved from one port on the switch to another port.

Store and Forward

These Fast Ethernet Switches use store and forward as the method for receiving and transmitting frames. When an Ethernet frame is received on a switch port, the switch does not retransmit the frame out the destination port until it has received the entire frame and stored the frame in a port buffer. It then examines the frame to determine if it is a valid frame. Invalid frames, such as fragments or runts, are discarded by the switch. This insures that only valid frames are transmitted out the switch ports and that damaged frames are not propagated on your network.

Backpressure and Flow Control

In order to maintain the orderly movement of data between the end-nodes, an Ethernet switch may periodically need to signal an end-node to stop sending data. This can occur under several circumstances. For example, if two end-nodes are operating at different speeds, the switch, while transferring data between the end-nodes, might need to instruct the faster end-node to stop transmitting data to allow the slower end-node to catch up. An example of this would be when a server operating at 100 Mbps is sending data to a workstation operating at only 10 Mbps.

How a switch signals an end-node to stop transmitting data differs depending on the speed and duplex mode of the end-node and switch port. A twisted pair port operating at 100 Mbps port and half-duplex mode stops an end-node from transmitting data by forcing a collision. A collision on an Ethernet network occurs when two end-nodes attempt to transmit data using the same data link at the same time. A collision causes end-nodes to stop sending data. When the switch needs to stop a 100 Mbps, half-duplex end-node from transmitting data, it forces a collision on the data link, which stops the end-node. Once the switch is ready to receive data again, the switch stops forcing collisions. This is referred to as backpressure.

A port operating at 100 Mbps and full-duplex mode uses PAUSE frames, as specified in the IEEE 802.3x standard, to stop the transmission of data from an end-node. Whenever the switch wants an end-node to stop transmitting data, it issues this frame. The frame instructs the end-node to cease transmission. The switch continues to issue PAUSE frames until it is ready again to receive data from the end-node. This is referred to as flow control.

Internal Power Supply

The AT-FS724L uses a universal internal switching power supply operating at 100-120/200-240V AC. The frequencies are 50/60 Hz, 0.5A at all input voltage +/-3%. Allied Telesyn ships power cords with these units to the U.S., Continental Europe, and the U.K. The switches require input of 100-120 or 200-240V AC. The AT-FS724L switch has a maximum power consumption of 15W.

Network Topologies

The AT-FS724L switch can be used in a variety of network topologies, such as a power workgroup or cascade. Both topologies are described below.

Power Workgroup Topology

A power workgroup topology, shown in Figure 2, allows each end-node to directly connect to a 10/100Base-TX port on an AT-FS724L switch. This gives each end-node a dedicated 10 Mbps or 100 Mbps link.

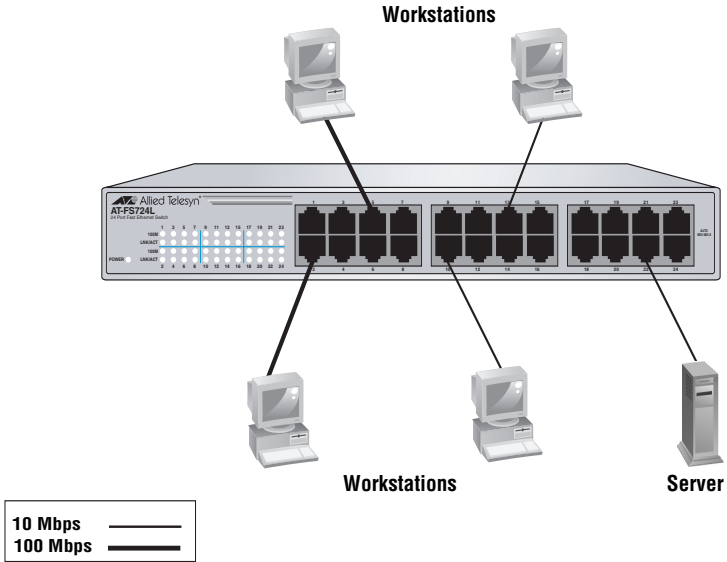

Figure 2 Power Workgroup Topology

Cascade Topology

Connecting two similar networking devices together is called ‘cascading’. Figure 3 illustrates this topology where Port 24 on the AT-FS724L switch is connected to Port 8 on the AT-FS716 switch. Since Port 24 is wired as auto MDI/MDI-X, a crossover or straight-through Category 5 or better twisted pair cable can be used.

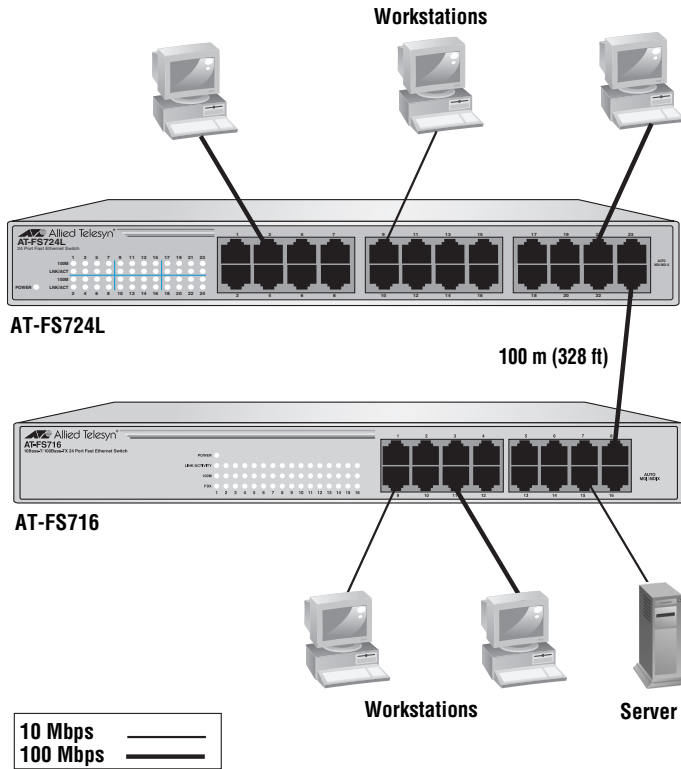

Figure 3 Cascade Topology

Chapter 2

Installation

Verifying the Package Contents

Make sure the following items are included in your package. If any item is missing or damaged, contact your Allied Telesyn sales representative for assistance.

- One AT-FS724L Fast Ethernet Switch
- Four protective feet (for desktop use only)
- This installation guide
- Warranty card
- An AC power cord
- Rackmounting kit

Planning the Installation

Be sure to observe the following guidelines when planning the installation of your switch.

- ❑ The end-nodes connected to the twisted pair port can operated at either 10 Mbps or 100 Mbps and half- or full-duplex mode.
- ❑ The end-node connected to a port on the switch can be a network adapter card, repeater, router, hub, or another switch.
- ❑ Refer to Table 3 for the cabling specifications for the twisted pair ports.

Table 3 10/100Base-TX Twisted Pair Port Cabling Specifications

Operating Mode	Twisted Pair Cable	Maximum Operating Distance
10Base-T	Shielded or unshielded Category 3 or better	100 m (328 ft)
100Base-TX	Shielded or unshielded Category 5 or better	100 m (328 ft)

Selecting a Site

Be sure to observe the following guidelines when selecting a site for your switch.

- ❑ Select a site that is dust-free and moisture-free.
- ❑ Select a site that will allow you to easily access the switch’s power and data cables.
- ❑ The twisted pair port cabling must be kept away from sources of electrical noise, such as radios, transmitters, power lines, broadband amplifiers electrical motors, and fluorescent fixtures.
- ❑ Make sure the air flow around the switch and through its vents on the side and back are not restricted.
- ❑ Use dedicated power circuits or power conditioners to supply reliable power to the switch.

Reviewing Safety Guidelines

Please review the following safety guidelines before you begin to install the switch.



Warning

Electrical Shock Hazard: To prevent electrical shock, do not remove the cover. There are no user-serviceable parts inside. The unit contains hazardous voltages and should only be opened by a trained and qualified technician. *See 5*



Warning

Lightning Danger: Do not work on equipment or cables during periods of lightning activity. *See 6*



Caution

Power Cord: The power cord is used as a disconnection device. to de-energize equipment, disconnect the power cord. *See 7*



Caution

Pluggable Equipment: The socket outlet should be installed near the equipment and should be easily accessible. *See 8*



Caution

Air Vents: The air vents must not be blocked on the unit and must have free access to the room ambient air for cooling. *See 9*



Caution

Operating Temperature: This product is designed for a maximum ambient temperature of 40 degrees C. *See 10*



Caution

All Countries: Install product in accordance with local and National Electrical Codes. *See 11*

Installing the Switch on a Table or Desktop

If you are rackmounting an AT-FS724L switch, refer to “Rackmounting the Switch” on page 15.

To install the switch on a table or desktop, perform the following procedure:

1. Remove all equipment from the packaging and store the packing material in a safe place. In the event a problem occurs and you need to return the unit, please use as much of the original shipping material as possible.
2. Attach the four protective feet to the bottom of the unit. See Figure 4.

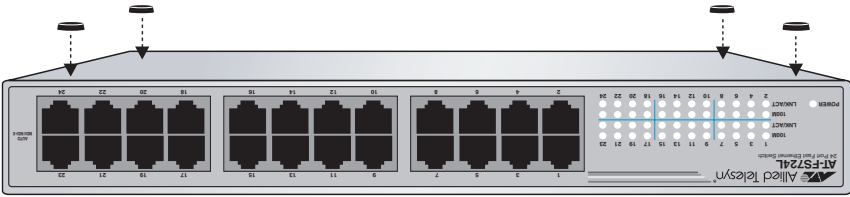

Figure 4 Attaching the Rubber Feet

3. Place the switch on a flat, secure surface leaving ample space around the switch for ventilation.
4. Apply power to the switch by plugging the AC/DC power adapter into an AC power outlet, then plug the DC connector to the power receptacle located on the back of the switch.
5. Verify that the POWER LED is green. If the LED is OFF, refer to “Troubleshooting” on page 19.

Note

The switch performs a self-diagnostic test upon power up. This takes about 20 seconds to complete.

6. Connect the twisted pair cables to a twisted pair ports on the switch and on the end-nodes.
7. Power ON the end-nodes connected to the switch.
8. Check that the LINK/ACTIVITY LED for each port on the switch is green. If a LED is OFF, refer to “Troubleshooting” on page 19.

The switch is now ready for use.

Rackmounting the Switch

The AT-FS724L switch can be used on a desktop or installed in a rack. For desktop installation, refer to “Installing the Switch on a Table or Desktop” on page 14.

To install an AT-FS724L in a rack, perform the following procedure:

1. If attached, remove the four protective feet from the bottom of the switch as shown in Figure 5.

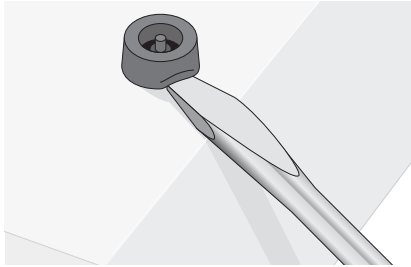

Figure 5 Removing the Rubber Feet

2. Remove the data cables and power cord from the switch.
3. Attach the rackmounting brackets to each side of the switch using the screws provided. See Figure 6.

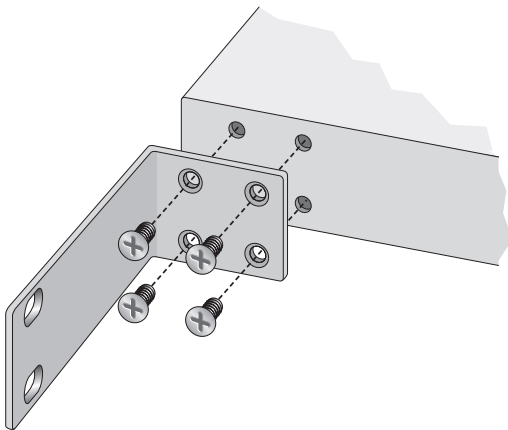

Figure 6 Attaching the Rackmounting Brackets to the Switch

4. Secure the switch to the rack using 2 screws (not provided) for each side as shown in Figure 7.

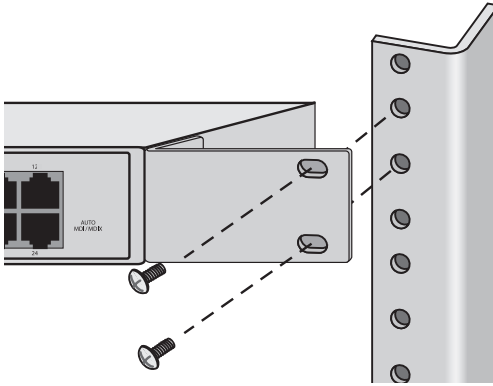

Figure 7 Installing the Switch to the Rack

5. Apply power to the switch by plugging one end of the power cord to the power receptacle and the other end to a power outlet. Verify that the POWER LED is green. If the LED is OFF, refer to “Troubleshooting” on page 19.

Note

The switch performs a self-diagnostic test upon power up. This takes about 20 seconds to complete.

6. Connect the twisted pair cables to a twisted pair ports on the switch and on the end-nodes.
7. Power ON the end-nodes connected to the switch.
8. Check that the LINK/ACTIVITY LED for each port on the switch is green. If a LED is OFF, refer to “Troubleshooting” on page 19.

The switch is now ready for use.

Warranty Registration

When you finish installing the product, you should register you product by completing the enclosed warranty card and sending it in.

Chapter 3

Troubleshooting

Follow the guidelines below to test and troubleshoot the installation in the event a problem occurs.

If the POWER LED is OFF, do the following:

- ❑ For an external power supply, check to be sure that the power adapter is securely connected to a power outlet and that the power adapter cable is securely connected to the back of the switch.
- ❑ For an internal power supply, check to be sure that the power cord is securely connected to a power outlet and that the other end of the power cord is securely connected to the back of the switch.
- ❑ Verify that the power outlet has power by connecting another device to it.
- ❑ Try using another power adapter or power cord, depending on your model.

If a LINK/ACTIVITY LED is OFF, do the following:

- ❑ Check that the end-node connected to the port is powered ON and is operating properly.
- ❑ Check that the twisted pair cable is securely connected to the twisted pair port on the switch and to the port on the remote end-node.
- ❑ Make sure that the twisted pair cable does not exceed 100 meters (328 feet) and that you are using Category 3 or better cable for 10Base-T operation or Category 5 or better cable for 100Base-TX operation.
- ❑ Verify that the end-node is operating at 10 Mbps or 100 Mbps.

If you are still experiencing problems after testing and troubleshooting the installation, contact Allied Telesyn Technical Support for assistance. Refer to “Contacting Allied Telesyn” on page viii or visit our web site at www.alliedtelesyn.com for support information.

Appendix A

Technical Specifications

Physical

Dimensions: W x D x H
11.6 in x 7.8 in x 1.72 in)

Weight: 2.5 kg (5.5 lbs)

Environmental

Maximum Operating: 0° to 40° C (32° to 104° F)

Maximum Storage: -25° to 70° C (-13° F to 158° F)

Relative Humidity Operating: 5% to 80% (non-condensing)

Relative Humidity Storage: 5% to 95% (non-condensing)

Operating and Storage Altitude: Up to 3,048 meters (10,000 feet)

Electrical Rating

Internal Universal Power Supply: 100 - 240 V AC, 50/60 Hz, 0.5A input

Agency Compliance

EMI/RFI:	FCC Class B, EN55022 Class B, VCCI Class B, CISPR Class B
Electrical Safety:	EN60950 (TUV), UL 60950 (_c UL _{us})
Immunity:	EN55024

Pinout Assignments

Figure 8 shows the pin assignments of the RJ-45 connector.

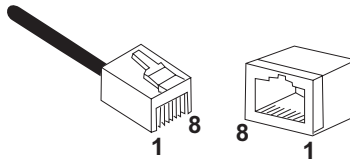

Figure 8 RJ-45 Connector

Table 4 lists the 100Base-TX connector pins and their signals when the port is operating in either MDI or MDI-X configuration.

Table 4 RJ-45 Pin Signals

MDI-X (Default)	Signal	MDI	Signal
1	RX+	1	TX+
2	RX-	2	TX-
3	TX+	3	RX+
4	-	4	-
5	-	5	-
6	TX-	6	RX-
7	-	7	-
8	-	8	-

Appendix A

Translated Safety and Emission Information

Important: This appendix contains multiple-language translations for the safety statements in this guide.

Wichtig: Dieser Anhang enthält Übersetzungen der in diesem Handbuch enthaltenen Sicherheitshinweise in mehreren Sprachen.

Vigtigt: Dette tillæg indeholder oversættelser i flere sprog af sikkerhedsadvarslerne i denne håndbog.

Belangrijk: Deze appendix bevat vertalingen in meerdere talen van de veiligheidsopmerkingen in deze gids.

Important: Cette annexe contient la traduction en plusieurs langues des instructions de sécurité figurant dans ce guide.

Tärkeää: Tämä liite sisältää tässä oppaassa esiintyvät turvaohjeet usealla kielellä.

Importante: questa appendice contiene traduzioni in più lingue degli avvisi di sicurezza di questa guida.

Viktig: Dette tillegget inneholder oversettelser til flere språk av sikkerhetsinformasjonen i denne veiledningen.

Importante: Este anexo contém traduções em vários idiomas das advertências de segurança neste guia.

Importante: Este apéndice contiene traducciones en múltiples idiomas de los mensajes de seguridad incluidos en esta guía.

Obs! Denna bilaga innehåller flerspråkiga översättningar av säkerhetsmeddelandena i denna handledning.

Standards: This product meets the following standards:

U.S. Federal Communications Commission

Declaration Of Conformity

Manufacturer Name: Allied Telesyn, Inc.
Manufacturer Address: 960 Stewart Drive, Suite B
Sunnyvale, CA 94085, USA
Manufacturer Telephone: 408-730-0950
Declares that the product: Fast Ethernet Switches
Model Numbers: AT-FS724L

This product complies with FCC Part 15B, Class B Limits:

This device complies with part 15 of the FCC Rules. Operation is subject to the following two conditions: (1) This device must not cause harmful interference, and (2) this device must accept any interference received, including interference that may cause undesired operation.

Radiated Energy

Note: This equipment has been tested and found to comply with the limits for a Class B digital device pursuant to Part 15 of FCC Rules. These limits are designed to provide reasonable protection against harmful interference in a residential installation. This equipment generates, uses and can radiate radio frequency energy and, if not installed and used in accordance with instructions, may cause harmful interference to radio or television reception, which can be determined by turning the equipment off and on. The user is encouraged to try to correct the interference by one or more of the following measures:









- Reorient or relocate the receiving antenna.
- Increase the separation between the equipment and the receiver.
- Connect the equipment into an outlet on a circuit different from that to which the receiver is connected.
- Consult the dealer or an experienced radio/TV technician for help.

Changes and modifications not expressly approved by the manufacturer or registrant of this equipment can void your authority to operate this equipment under Federal Communications Commission rules.

Industry Canada

This Class B digital apparatus meets all requirements of the Canadian Interference-Causing Equipment Regulations.

Cet appareil numérique de la classe B respecte toutes les exigences du Règlement sur le matériel brouilleur du Canada.

- 1 **RFI Emission** FCC Class B, EN55022 Class B, VCCI Class B, C-TICK
- 2  **Warning:** In a domestic environment this product may cause radio interference in which case the user may be required to take adequate measures.
- 3 **Immunity** EN55024
- 4 **Electrical Safety** EN60950 (TUV), UL60950 (cUL_{us})
- 5  **Electrical Notices**
Warning: ELECTRIC SHOCK HAZARD
 To prevent ELECTRIC shock, do not remove the cover. No user-serviceable parts inside. This unit contains HAZARDOUS VOLTAGES and should only be opened by a trained and qualified technician. To avoid the possibility of ELECTRIC SHOCK, disconnect electric power to the product before connecting or disconnecting the LAN cables.
- 6  **Lightning Danger**
Danger: DO NOT WORK on equipment or CABLES during periods of LIGHTNING ACTIVITY.
- 7  **Caution:** The power cord is used as a disconnection device. to de-energize equipment, disconnect the power cord.
- 8  **Caution:** Pluggable equipment, the socket outlet should be installed near the equipment and should be easily accessible.
- Electrical—Auto Voltage Adjustment**
 This product will automatically adjust to any voltage between the ranges shown on the label.
- Electrical—Type Class 1 Equipment**
 THIS EQUIPMENT MUST BE EARTHED. Power plug must be connected to a properly wired earth ground socket outlet. An improperly wired socket outlet could place hazardous voltages on accessible metal parts.
- 9  **Caution:** Air vents must not be blocked and must have free access to the room ambient air for cooling.
- 10  **Operating Temperature:** This product is designed for a maximum ambient temperature of 40 degrees C.
- 11  **All Countries:** Install product in accordance with local and National Electrical Codes.

Normen: Dieses Produkt erfüllt die Anforderungen der nachfolgenden Normen.

- 1 **Hochfrequenzstörung** FCC Klasse B, EN55022 Klasse B, VCCI Klasse B, C-TICK

- 2  **Warnung:** Bei Verwendung zu Hause kann dieses Produkt Funkstörungen hervorrufen. In diesem Fall müßte der Anwender angemessene Gegenmaßnahmen ergreifen.

- 3 **Störsicherheit** EN55024

- 4 **Elektrische Sicherheit** EN60950 (TUV), UL60950 (cUL-us)

- 5  **Achtung: GEFÄHRLICHE SPANNUNG**
Das Gehäuse nicht öffnen. Das Gerät enthält keine vom Benutzer wartbaren Teile. Das Gerät steht unter Hochspannung und darf nur von qualifiziertem technischem Personal geöffnet werden. Vor Anschluß der LAN-Kabel, Gerät vom Netz trennen.

- 6  **Gefahr Durch Blitzschlag**
Gefahr: Keine Arbeiten am Gerät oder an den Kabeln während eines Gewitters ausführen.

- 7  **Vorsicht:** Das netzkabel dient zum trennen der stromversorgung. Zur trennung vom netz, kabel aus der steckdose ziehen.









- 8  **Steckbares Gerät:** Die Anschlußbuchse sollte in der Nähe der Einrichtung angebracht werden und leicht zugänglich sein.”
Automatische Spannungseinstellung
Dieses Gerät stellt sich automatisch auf die auf dem Etikett aufgeführten Spannungswerte ein.
Geräte Der Klasse 1
DIESE GERÄTE MÜSSEN GEERDET SEIN. Der Netzstecker darf nur mit einer vorschriftsmäßig geerdeten Steckdose verbunden werden. Ein unvorschriftsmäßiger Anschluß kann die Metallteile des Gehäuses unter gefährliche elektrische Spannungen setzen.

- 9  **Vorsicht**
Die Entlüftungsöffnungen dürfen nicht versperrt sein und müssen zum Kühlen freien Zugang zur Raumluft haben.









- 10  **Betriebstemperatur**
Dieses Produkt wurde für den Betrieb in einer Umgebungstemperatur von nicht mehr als 40° C entworfen.

- 11  **Alle Länder:** Installation muß örtlichen und nationalen elektrischen Vorschriften entsprechen.









Standarder: Dette produkt tilfredsstiller de følgende standarder.

- 1 **Radiofrekvens forstyrrelsesemission** FCC Klasse B, EN55022 Klasse B, VCCI Klasse B, C-TICK
- 2  **Advarsel:** I et hjemligt miljø kunne dette produkt forårsage radio forstyrrelse. Bliver det tilfældet, påkræves brugeren muligvis at tage tilstrækkelige foranstaltninger.
- 3 **Immunitet** EN55024
- 4 **Elektrisk sikkerhed** EN60950 (TUV), UL60950 (cUL_{us})
- 5  **Elektriske Forholdsregler**
Advarsel: RISIKO FOR ELEKTRISK STØD
 For at forebygge ELEKTRISK stød, undlad at åbne apparatet. Der er ingen indre dele, der kan repareres af brugeren. Denne enhed indeholder LIVSFARLIGE STRØMSPÆNDINGER og bør kun åbnes af en uddannet og kvalificeret tekniker. For at undgå risiko for ELEKTRISK STØD, afbrydes den elektriske strøm til produktet, før LAN-kablerne monteres eller afmonteres.
- 6  **Fare Under Uvejr**
Fare: UNDLAD at arbejde på udstyr eller KABLER i perioder med LYNAKTIVITET.
- 7  **Waarschuwing:** Het toestel wordt uitgeschakeld door de stroomkabel te ontkoppelen. Om het toestel stroomloos te maken: de stroomkabel ontkoppelen.
- 8  **Udstyr Til Stikkontakt:** stikkontakten bør installeres nær ved udstyret og skal være lettilgængelig.
Elektrisk—Automatisk Spændingsregulering
 Dette apparat vil automatisk tilpasse sig enhver spænding indenfor de værdier, der er angivet på etiketten.
Elektrisk—Klasse 1-Udstyr
 DETTE UDS TYR KRÆVER JORDFORBINDELSE. Stikket skal være forbundet med en korrekt installeret jordforbunden stikkontakt. En ukorrekt installeret stikkontakt kan sætte livsfarlig spænding til tilgængelige metaldele.
- 9  **Opgelet:** De ventilatiegaten mogen niet worden gesperd en moeten de omgevingslucht ongehinderd toelaten voor afkoeling
- 10  **Betjeningstemperatur:** Dette apparat er konstrueret til en omgivende temperatur på maksimum 40 grader C.
- 11  **Alle Lande:** Installation af produktet skal ske i overensstemmelse med lokal og national lovgivning for elektriske installationer.





Eisen: Dit product voldoet aan de volgende eisen.

- 1 **RFI Emissie** FCC Klasse B, EN55022 Klasse B, VCCI Klasse B, C-TICK
- 2  **Waarschuwing:** Binnenshuis kan dit product radiostoring veroorzaken, in welk geval de gebruiker verplicht kan worden om gepaste maatregelen te nemen.
- 3 **Immunititeit** EN55024
- 4 **Electrische Veiligheid** EN60950 (TUV), UL60950 (cUL_{us})
- 5  **Elektrische Forholdsregler**
Advarsel: RISIKO FOR ELEKTRISK STØD For at forebygge ELEKTRISK stød, undlad at åbne apparatet. Der er ingen indre dele, der kan repareres af brugeren. Denne enhed indeholder LIVSFARLIGE STRØMSPÆNDINGER og bør kun åbnes af en uddannet og kvalificeret tekniker. For at undgå risiko for ELEKTRISK STØD, afbrydes den elektriske strøm til produktet, før LAN-kablerne monteres eller afmonteres.
- 6  **Gevaar Voor Blikseminslag**
Gevaar: NIET aan toestellen of KABELS WERKEN bij BLIKSEM.
- 7  **Attention:** Le cordon d'alimentation sert de mise hors circuit. Pour couper l'alimentation du matériel, débrancher le cordon.
- 8  **Aan Te Sluiten Apparatuur,** de contactdoos wordt in de nabijheid van de apparatuur geïnstalleerd en is gemakkelijk te bereiken.”
Elektrische Toestellen Van Klasse 1
DIT TOESTEL MOET GEAARD WORDEN. De stekker moet aangesloten zijn op een juist geaarde contactdoos. Een onjuist geaarde contactdoos kan de metalen onderdelen waarmee de gebruiker eventueel in aanraking komt onder gevaarlijke spanning stellen.
- 9  **Attention:** Ne pas bloquer les fentes d'aération, ceci empêcherait l'air ambiant de circuler librement pour le refroidissement
- 10  **Bedrijfstemperatuur:** De omgevingstemperatuur voor dit produkt mag niet meer bedragen dan 40 graden Celsius.
- 11  **Alle Landen:** het toestel installeren overeenkomstig de lokale en nationale elektrische voorschriften.









Normes: Ce produit est conforme aux normes de suivantes.

- 1 **Emission d'interférences radioélectriques** FCC Classe B, EN55022 Classe B, VCCI Classe B, C-TICK
- 2  **Mise En Garde:** Dans un environnement domestique, ce produit peut provoquer des interférences radioélectriques. Auquel cas, l'utilisateur devra prendre les mesures adéquates.
- 3 **Immunité** EN55024
- 4 **Sécurité électrique** EN60950 (TUV), UL60950 (cUL_{us})
- 5  **Information Sur Les Risques Électriques**
Avertissement: DANGER D'ÉLECTROCUTION
 Pour éviter toute ÉLECTROCUTION, ne pas ôter le revêtement protecteur du matériel. Ce matériel ne contient aucun élément réparable par l'utilisateur. Il comprend des TENSIONS DANGEREUSES et ne doit être ouvert que par un technicien dûment qualifié. Pour éviter tout risque d'ÉLECTROCUTION, débrancher le matériel avant de connecter ou de déconnecter les câbles LAN.
- 6  **Danger De Foudre**
Danger: NE PAS MANIER le matériel ou les CÂBLES lors d'activité orageuse.
- 7  **Attention:** Le cordon d'alimentation sert de mise hors circuit. Pour couper l'alimentation du matériel, débrancher le cordon.
- 8  **Équipement Pour Branchement Électrique,** la prise de sortie doit être placée près de l'équipement et facilement accessible".
- Réglage De Tension Automatique Électriquez**
 Ce matériel peut s'ajuster automatiquement sur n'importe quelle tension comprise dans la plage indiquée sur l'étiquette.
- Équipement De Classe 1 Électrique**
 CE MATÉRIEL DOIT ÊTRE MIS A LA TERRE. La prise de courant doit être branchée dans une prise femelle correctement mise à la terre car des tensions dangereuses risqueraient d'atteindre les pièces métalliques accessibles à l'utilisateur.
- 9  **Attention:** Ne pas bloquer les fentes d'aération, ceci empêcherait l'air ambiant de circuler librement pour le refroidissement.
- 10  **Température De Fonctionnement**
 Ce matériel est capable de tolérer une température ambiante maximum de 40 degrés Celsius.
- 11  **Pour Tous Pays:** Installer le matériel conformément aux normes électriques nationales et locales.









Standardit: Tämä tuote on seuraavien standardien mukainen.

-  **1 Radioaaltojen häirintä** FCC Luokka B, EN55022 Luokka B, VCCI Luokka B, C-TICK
-  **2**  **Varoitus:** Kotiolosuhteissa tämä laite voi aiheuttaa radioaaltojen häirintä, missä tapauksessa laitteen käyttäjän on mahdollisesti ryhdyttävä tarpeellisiin toimenpiteisiin.
-  **3 Kestävyys** EN55024
-  **4 Sähköturvallisuus** EN60950 (TUV), UL60950 (cUL-us)
-  **5**  **Sähköön Liittyviä Huomautuksia**
Varoitus: SÄHKÖISKUVAARA Estääksesi SÄHKÖISKUN älä poista kantta. Sisällä ei ole käyttäjän huollettavissa olevia osia. Tämä laite sisältää VAARALLISIA JÄNNITTEITÄ ja sen voi avata vain koulutettu ja pätevä tekniikko. Vältääksesi SÄHKÖISKUN mahdollisuuden katkaise sähkövirta tuotteeseen ennen kuin liität tai irrotat paikallisverkon (LAN) kaapelit.
-  **6**  **Salamaniskuvaara**
Engenvaara: ÄLÄ TYÖSKENTELE laitteiden tai KAAPELEIDEN KANSSA SALAMOINNIN AIKANA.
-  **7**  **Huomautus:** VIRTajohtoa KÄYTETÄÄN VIRRANKATKAISULAITTEENA. VIRTa KATKAISTAAN irrottamalla virtajohto.
-  **8**  **Pistorasiaan Kytkettävä Laite;** pistorasia on asennettava laitteen lähelle ja siihen on oltava esteetön pääsy.”
Sähkö—Automaattinen Jänniteensäätö
Tämä tuote säättää automaattisesti mihin tahansa jännitteeseen ohjetarrassa annettujen arvojen välillä.
Sähkö—Tyypiluokan 1 Laitteet
TÄMÄ LAITE TÄYTYY MAADOITTAA. Pistoke täytyy liittää kunnollisesti maadoitettuun pistorasiaan. Virheellisesti johdotettu pistorasia voi altistaa metalliosat vaarallisille jännitteille.
-  **9**  **Huomautus:** Ilmavaihtoreikiä ei pidä tukkia ja niillä täytyy olla vapaa yhteys ympäröivään huoneilmaan, jotta ilmanvaihto tapahtuisi.
-  **10**  **Käyttölämpötila**
Tämä tuote on suunniteltu ympäröivän ilman maksimilämpötilalle 40° C.
-  **11**  **Kaikki Maat:** Asenna tuote paikallisten ja kansallisten sähköturvallisuusmääräysten mukaisesti.









Standard: Questo prodotto è conforme ai seguenti standard.

- 1 **Emissione RFI (interferenza di radiofrequenza)** FCC Classe B, EN55022 Classe B, VCCI Classe B, C-TICK
- 2  **Avvertenza:** in ambiente domestico questo prodotto potrebbe causare radio interferenza. In questo caso potrebbe richiedersi all'utente di prendere gli adeguati provvedimenti.
- 3 **Immunità** EN55024
- 4 **Sicurezza elettrica** EN60950 (TUV), UL60950 (cUL_{us})
- 5  **Avvertenze Elettriche**
Attenzione: PERICOLO DI SCOSSE ELETTRICHE
 Per evitare SCOSSE ELETTRICHE non asportare il coperchio. Le componenti interne non sono riparabili dall'utente. Questa unità ha TENSIONI PERICOLOSE e va aperta solamente da un tecnico specializzato e qualificato. Per evitare ogni possibilità di SCOSSE ELETTRICHE, interrompere l'alimentazione del dispositivo prima di collegare o staccare i cavi LAN.
- 6  **Pericolo Di Fulmini**
Pericolo: NON LAVORARE sul dispositivo o sui CAVI durante PRECIPITAZIONI TEMPORALESCHIE.
- 7  **Attenzione:** Il cavo di alimentazione è usato come dispositivo di disattivazione. Per togliere la corrente al dispositivo staccare il cavo di alimentazione.
- 8  **Apparecchiatura Collegabile**, la presa va installata vicino all'apparecchio per risultare facilmente accessibile".
Elettricità—Regolazione Automatica Della Tensione
 Questo prodotto regolerà automaticamente la tensione ad un valore compreso nella gamma indicata sull'etichetta.
Elettricità—Dispositivi Di Classe 1
 QUESTO DISPOSITIVO DEVE AVERE LA MESSA A TERRA. La spina deve essere inserita in una presa di corrente specificamente dotata di messa a terra. Una presa non cablata in maniera corretta rischia di scaricare una tensione pericolosa su parti metalliche accessibili.
- 9  **Attenzione:** le prese d'aria non vanno ostruite e devono consentire il libero ricircolo dell'aria ambiente per il raffreddamento.
- 10  **Temperatura Di Funzionamento**
 Questo prodotto è concepito per una temperatura ambientale massima di 40 gradi centigradi.
- 11  **Tutti I Paesi** installare il prodotto in conformità delle vigenti normative elettriche nazionali.









Sikkerhetsnormer: Dette produktet tilfredsstiller følgende sikkerhetsnormer.

- 1 **RFI stråling** FCC Klasse B, EN55022 Klasse B, VCCI Klasse B, C-TICK
- 2  **Advarsel:** Hvis dette produktet benyttes til privat bruk, kan produktet forårsake radioforstyrrelse. Hvis dette skjer, må brukeren ta de nødvendige forholdsregler.
- 3 **Immunitet** EN55024
- 4 **Elektrisk sikkerhet** EN60950 (TUV), UL60950 (cUL_{us})
- 5  **Elektrisitet**
Advarsel: FARE FOR ELEKTRISK SJOKK
For å unngå ELEKTRISK sjokk, må dekslet ikke tas av. Det finnes ingen deler som brukeren kan reparere på innsiden. Denne enheten inneholder FARLIGE SPENNINGER, og må kun åpnes av en faglig kvalifisert tekniker. For å unngå ELEKTRISK SJOKK må den elektriske strømmen til produktet være avslått før LAN-kablene til- eller frakobles.
- 6  **Fare For Lynnedslag**
Fare: ARBEID IKKE på utstyr eller KABLER i TORDENVÆR.
- 7  **Forsiktig:** STRØMLEDNINGEN BRUKES TIL Å FRAKOBLE UTSTYRET. FOR Å DEAKTIVISERE UTSTYRET, må strømforsyningen kobles fra.
- 8  **Utstyr For Stikkontakt.** Stikkontakten skal monteres i nærheten av utstyret og skal være lett tilgjengelig.”
Elektrisk—Auto Spenningstilpasning
Dette produktet vil automatisk bli tilpasset hvilken som helst strømspenning i de områdene som vises på etiketten.
Elektrisk—Type 1- Klasse Utstyr
DETTE UTSTYRET MÅ JORDES. Strømkontakten må være tilkopleet en korrekt jordet kontakt. En kontakt som ikke er korrekt jordet kan føre til farlig spenninger i lett tilgjengelige metalldeleer.
- 9  **Forsiktig:** Lufteventilene må ikke blokkeres, og må ha fri tilgang til luft med romtemperatur for avkjøling.
- 10  **Driftstemperatur:** Dette produktet er konstruert for bruk i maksimum romtemperatur på 40 grader celsius.
- 11  **Alle Land:** Produktet må installeres i samsvar med de lokale og nasjonale elektriske koder.









Padrões: Este produto atende aos seguintes padrões.

- 1 **Emissão De Interferência De Radiofrequência** FCC Classe B, EN55022 Classe B, VCCI Classe B, C-TICK
- 2  **Aviso:** Num ambiente doméstico este produto pode causar interferência na radiorrecepção e, neste caso, pode ser necessário que o utente tome as medidas adequadas.
- 3 **Imunidade** EN55024
- 4 **Segurança Eléctrica** EN60950 (TUV), UL60950 (cUL_{us})
- 5  **Avisos Sobre Características Eléctricas**
Atenção: PERIGO DE CHOQUE ELÉTRICO
 Para evitar CHOQUE ELÉTRICO, não retire a tampa. Não contém peças que possam ser consertadas pelo usuário. Este aparelho contém VOLTAGENS PERIGOSAS e só deve ser aberto por um técnico qualificado e treinado. Para evitar a possibilidade de CHOQUE ELÉTRICO, desconecte o aparelho da fonte de energia eléctrica antes de conectar e desconectar os cabos da LAN.
- 6  **Perigo De Choque Causado Por Raio**
Perigo: NÃO TRABALHE no equipamento ou nos CABOS durante períodos suscetíveis a QUEDAS DE RAIOS.
- 7  **Cuidado:** O cabo de alimentação é utilizado como um dispositivo de desconexão. Para deseletrificar o equipamento, desconecte o cabo de alimentação.
- 8  **Equipamento De Ligação,** a tomada eléctrica deve estar instalada perto do equipamento e ser de fácil acesso.”
Eléctrico—Ajuste Automático De Voltagem
 Este produto ajustar-se-á automaticamente a qualquer voltagem que esteja dentro dos limites indicados no rótulo.
Eléctrico—Equipamentos Do Tipo Classe 1
 DEVE SER FEITA LIGAÇÃO DE FIO TERRA PARA ESTE EQUIPAMENTO. O plugue de alimentação deve ser conectado a uma tomada com adequada ligação de fio terra. Tomadas sem adequada ligação de fio terra podem transmitir voltagens perigosas a peças metálicas expostas.
- 9  **Cuidado:** As aberturas de ventilação não devem ser bloqueadas e devem ter acesso livre ao ar ambiente para arrefecimento adequado do aparelho.
- 10  **Temperatura De Funcionamento:** Este produto foi projetado para uma temperatura ambiente máxima de 40 graus centígrados.
- 11  **Todos Os Países:** Instale o produto de acordo com as normas nacionais e locais para instalações eléctricas.

Estándares: Este producto cumple con los siguientes estándares.

- 1 **Emisión RFI** FCC Clase B, EN55022 Clase B, VCCI Clase B, C-TICK
- 2  **Advertencia:** en un entorno doméstico, este producto puede causar radiointerferencias, en cuyo caso, puede requerirse del usuario que tome las medidas que sean convenientes al respecto.
- 3 **Inmunidad** EN55024
- 4 **Seguridad eléctrica** EN60950 (TUV), UL60950 (cUL-us)
- 5  **Avisos Electricos**
Advertencia: PELIGRO DE ELECTROCHOQUE
Para evitar un ELECTROCHOQUE, no quite la tapa. No hay ningún componente en el interior al cual puede prestar servicio el usuario. Esta unidad contiene VOLTAJES PELIGROSOS y sólo deberá abrirla un técnico entrenado y calificado. Para evitar la posibilidad de ELECTROCHOQUE desconecte la corriente eléctrica que llega al producto antes de conectar o desconectar los cables LAN.
- 6  **Peligro De Rayos**
Eligro: NO REALICE NINGUN TIPO DE TRABAJO O CONEXION en los equipos o en LOS CABLES durante TORMENTAS ELECTRICAS.
- 7  **Atencion:** EL CABLE DE ALIMENTACION SE USA COMO UN DISPOSITIVO DE DESCONEXION. PARA DESACTIVAR EL EQUIPO, desconecte el cable de alimentación.
- 8  **Equipo Conectable,** el tomacorriente se debe instalar cerca del equipo, en un lugar con acceso fácil”.
- Electrico—Auto-Ajuste De Tension**
Este producto se ajustará automáticamente a cualquier tensión entre los valores máximos y mínimos indicados en la etiqueta.
- Electrico—Equipo Del Tipo Clase 1**
ESTE EQUIPO TIENE QUE TENER CONEXION A TIERRA. El cable tiene que conectarse a un enchufe a tierra debidamente instalado. Un enchufe que no está correctamente instalado podría ocasionar tensiones peligrosas en las partes metálicas que están expuestas.
- 9  **Atencion:** Las aberturas para ventilación no deberán bloquearse y deberán tener acceso libre al aire ambiental de la sala para su enfriamiento.
- 10  **Temperatura Requerida Para La Operación:** Este producto está diseñado para una temperatura ambiental máxima de 40 grados C.
- 11  **Para Todos Los Países:** Monte el producto de acuerdo con los Códigos Eléctricos locales y nacionales.

Standarder: Denna produkt uppfyller följande standarder.

- ☞ **1 Radiostörning** FCC Klass B, EN55022 Klass B, VCCI Klass B, C-TICK
- ☞ **2  Varning:** Denna produkt kan ge upphov till radiostörningar i hemmet, vilket kan tvinga användaren till att vidtaga erforderliga åtgärder.
- ☞ **3 Immunitet** EN55024
- ☞ **4 Elsäkerhet** EN60950 (TUV), UL60950 (cUL-us)
- ☞ **5  tillkännagivanden beträffande elektricitetsrisk:**
RISK FÖR ELEKTRISK STÖTFör att undvika ELEKTRISK stöt, ta ej av locket. Det finns inga delar inuti som behöver underhållas. Denna apparat är under HÖGSPÄNNING och får endast öppnas av en utbildad kvalificerad tekniker. För att undvika ELEKTRISK STÖT, koppla ifrån produktens strömanslutning innan LAN-kablarna ansluts eller kopplas ur.
- ☞ **6  Fara För Blixtnedslag**
Fara: ARBETA EJ på utrustningen eller kablarna vid ÅSKVÄDER.
- ☞ **7  Varning:** Nätkabeln används som strömbrytare för att koppla från strömmen, dra ur nätkabeln.
- ☞ **8  Utrustning Med Plugg.** Uttaget skall installeras i utrustningens närhet och vara lättåtkomligt”.
Elektriskt —automatisk Spänningsjustering
 Denna produkt justeras automatiskt till alla spänningar inom omfånget som indikeras på produktens märkning.
Elektriskt—Typ Klass 1 Utrustning
 DENNA UTRUSTNING MÅSTE VARA JORDAD. Nätkabeln måste vara ansluten till ett ordentligt jordat uttag. Ett felaktigt uttag kan göra att närliggande metalldelar utsätts för högspänning. Apparaten skall anslutas till jordat uttag, när den ansluts till ett nätverk.
- ☞ **9  Varning:** Luftventilerna får ej blockeras och måste ha fri tillgång till omgivande rumsluft för avsvaning.
- ☞ **10  Driftstemperatur:** Denna produkt är konstruerad för rumstemperatur ej överstigande 40 grader Celsius.
- ☞ **11  Alla Länder:** Installera produkten i enlighet med lokala och statliga bestämmelser för elektrisk utrustning.

