



Allen-Bradley

*2-D Hand-Held
Bar Code
Scanners*

(Cat. No. 2755-HTG-4)

Bar Code Programming Guide

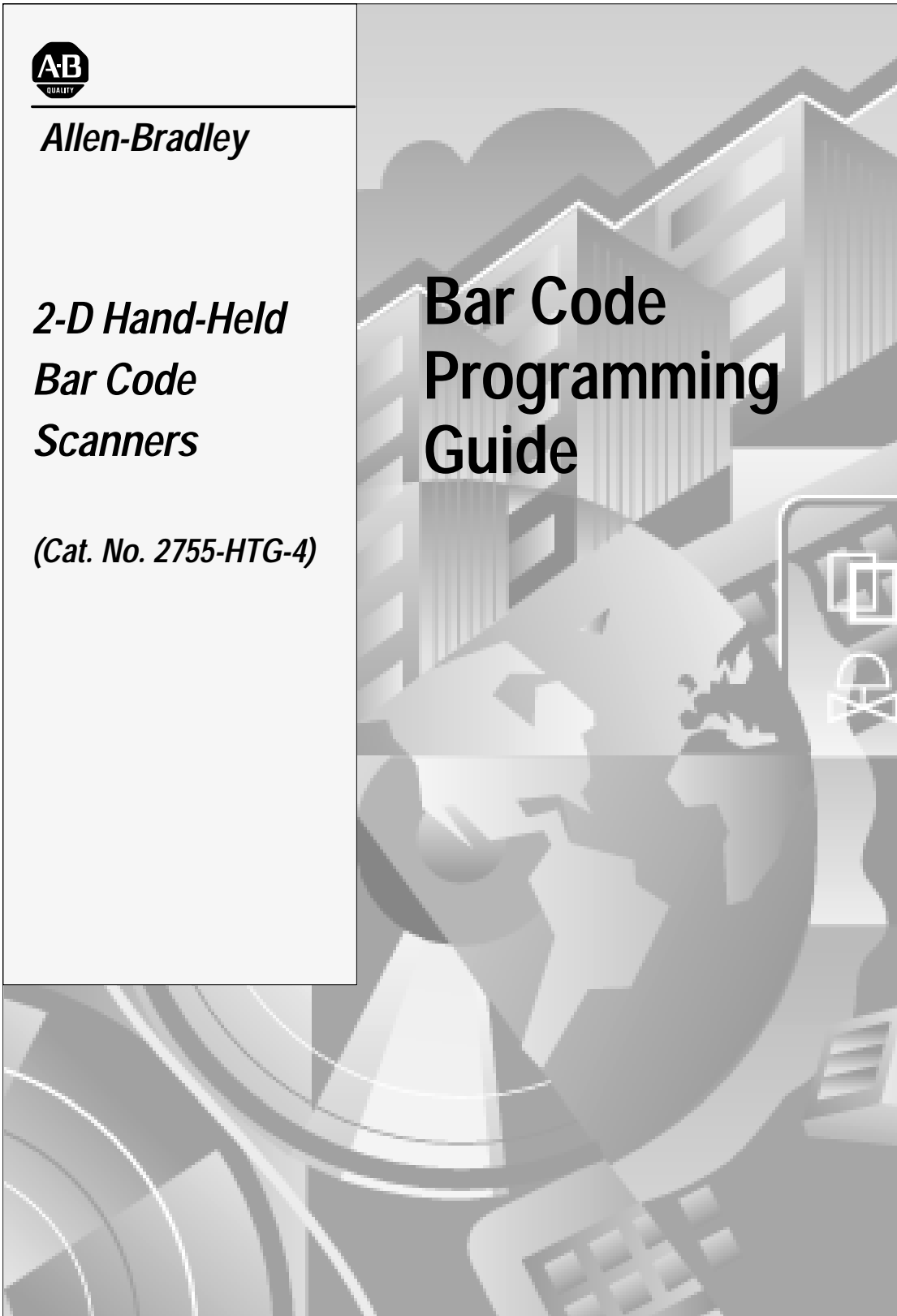

Important User Information

The illustrations, charts, sample programs and layout examples shown in this guide are intended solely for purposes of example. Since there are many variables and requirements associated with any particular installation, Allen-Bradley does not assume responsibility or liability (to include intellectual property liability) for actual use based upon the examples shown in this publication.

Allen-Bradley publication SGI-1.1, *Safety Guidelines for the Application, Installation, and Maintenance of Solid-State Control* (available from your local Allen-Bradley office), describes some important differences between solid-state equipment and electromechanical devices that should be taken into consideration when applying products such as those described in this publication.

Reproduction of the contents of this copyrighted publication, in whole or in part, without written permission of Allen-Bradley Company, Inc., is prohibited.

Throughout this manual we use notes to make you aware of safety considerations:



ATTENTION: Identifies information about practices or circumstances that can lead to personal injury or death, property damage or economic loss.

Attention statements help you to:

- identify a hazard
- avoid the hazard
- recognize the consequences

Important: Identifies information that is critical for successful application and understanding of the product.

Table of Contents

Preface

| | |
|--------------------------------------|-----|
| Configuration Bar Code Symbols | P-1 |
| How to Use this Guide | P-2 |

Chapter 1 Scanner Configuration

| | |
|---|------|
| Set Default Parameters | 1-1 |
| Select the Symbologies You Want to Enable or Disable | 1-3 |
| Select Code 39 Options | 1-6 |
| Transmit UPC-A / UPC-E Check Digit | 1-7 |
| Convert UPC-E to UPC-A | 1-7 |
| Decode UPC/EAN Supplements | 1-8 |
| Convert EAN-8 to EAN-13 | 1-8 |
| Select UPC-A Preamble | 1-9 |
| Select UPC-E Preamble | 1-9 |
| Select Code 39 – Code Lengths | 1-10 |
| Select Codabar Code Lengths | 1-11 |
| Select Interleaved 2 of 5 Code Lengths | 1-12 |
| Select Prefix / Suffix Options | 1-14 |
| Data Transmission Format | 1-16 |
| Transmit No-Read Message | 1-17 |
| Transmit LRC Checksum | 1-17 |
| Transmit Code ID Character | 1-18 |
| Beeper After Good Decode / Beeper Tone | 1-19 |
| Decode Buffering | 1-19 |
| Pause Duration | 1-20 |
| Decode Attempt Duration | 1-20 |
| Time Delay to Low Power Mode | 1-22 |
| Timeout Between Decode Values, Same/Different Symbology | 1-22 |
| Smart Raster | 1-24 |
| Hand-Held Options | 1-24 |

Chapter 2 RS-232 Synapse Cable (Communication Setup)

| | |
|-------------------------------------|------|
| RS-232 Synapse Cable Defaults | 2-2 |
| Fixed Format Hosts | 2-3 |
| Baud Rate | 2-4 |
| Parity Options | 2-5 |
| Stop and Data Bits | 2-6 |
| Hardware Handshaking | 2-8 |
| Software Handshaking | 2-7 |
| Beep on <BEL> | 2-9 |
| Unknown Characters | 2-9 |
| Response Timeout | 2-10 |
| Advanced Features | 2-12 |

Chapter 3 IBM Keyboard Wedge Synapse Cable (Communication Setup)

| | |
|---|-----|
| IBM Keyboard Wedge Synapse Cable Defaults | 3-1 |
| Host | 3-2 |
| Country Selection | 3-3 |
| Unknown Characters | 3-4 |
| Intercharacter Delay | 3-4 |
| Advanced Features | 3-5 |

Chapter 4 DEC VT520 Keyboard Wedge Synapse Cable (Communication Setup)

| | |
|---|-----|
| DEC VT520 Keyboard Wedge Synapse Cable Defaults | 4-1 |
| Host | 4-2 |
| Country Selection | 4-2 |
| Unknown Characters | 4-4 |
| Intercharacter Delay | 4-4 |
| Advanced Features | 4-5 |

Chapter 5 DEC VT220/320/420 Keyboard Wedge Synapse Cable (Communication Setup)

| | |
|---|-----|
| DEC VT220/320/420 Keyboard Wedge Synapse Cable Defaults . . . | 5-1 |
| Host | 5-2 |
| Country Selection | 5-2 |
| Unknown Characters | 5-4 |
| Intercharacter Delay | 5-4 |
| Advanced Features | 5-5 |

Chapter 6 Scanner Emulation Synapse Cable (Communication Setup)

| | |
|--|-----|
| Scanner Emulation Synapse Cable Defaults | 6-1 |
| Host | 6-2 |
| Variable Leading Margin | 6-3 |
| Check for Decode LED | 6-3 |
| Timeout | 6-4 |
| Polarity | 6-5 |
| Unknown Characters | 6-5 |
| Convert All to Code 39 | 6-6 |
| Code 39 to Code 39 Full ASCII | 6-6 |
| Advanced Features | 6-7 |

Appendix A Advanced Data Formatting Codes

| | |
|---|------|
| Special Commands | A-2 |
| Start/Save Rule | A-2 |
| Erase/Quit Rule | A-3 |
| Disable Rule Sets | A-4 |
| Criteria | A-5 |
| Code Types | A-5 |
| Code Lengths | A-7 |
| Specific Data String / Numeric Keypad | A-10 |
| Rule Belongs to Set | A-13 |
| Actions | A-14 |
| Send Characters / Data | A-14 |
| Skip Ahead / Back | A-18 |
| Spaces and Zeros | A-22 |
| Send Value | A-23 |
| Beeps | A-24 |
| Pad Spaces | A-25 |
| Pad Zeros | A-29 |
| Send Control Characters | A-33 |
| Send Keyboard Characters | A-37 |
| AlphaNumeric Keyboard | A-49 |
| Turn on Rule Set | A-60 |

Appendix B Enhanced Decoder Application

| | |
|--|-----|
| Hardware Connections | B-2 |
| Scanner Configuration | B-2 |
| Configuration Codes for Enhanced Decoder Application | B-3 |
| Enhanced Decoder Setup for Scanner Input | B-4 |
| Enhanced Decoder Setup for Auxiliary Port Pass Through | B-5 |

Appendix C Flexible Interface (RB) Module Application

| | |
|---|-----|
| Hardware Connections | C-2 |
| Scanner Configuration | C-2 |
| Configuration Codes for Flexible Interface Module Application | C-3 |
| Flexible Interface Module Setup | C-4 |

Appendix D SLC 5/03, 5/04 Application

| | |
|---|-----|
| Hardware Connections | D-2 |
| Scanner Configuration | D-2 |
| Configuration Codes for SLC Application | D-3 |
| SLC 5/03, 5/04 Setup | D-5 |
| SLC Program | D-7 |

Appendix E PLC-5 Controller Application

| | |
|---|-----|
| Hardware Connections | E-2 |
| Scanner Configuration | E-2 |
| Configuration Codes for PLC Application | E-3 |
| PLC Setup | E-5 |
| PLC Program | E-7 |

Appendix F DTAM Plus DeviceNet Application

| | |
|---|-----|
| Hardware Connections | F-2 |
| Configuration Codes for DTAM Plus DeviceNet Application | F-3 |
| DTAM Plus Setup | F-5 |
| DeviceNet Operation | F-6 |

Appendix G ASCII Chart

Read this First

This guide provides the configuration bar codes for the following:

- 2-D Hand-Held Bar Code Scanners
(Catalog No. 2755-HTG-4)
- RS-232 Synapse Cables
(Catalog No. 2755-HFC-SR2-01, 2755-HFC-SR3-01)
- IBM or Compatible Keyboard Wedge Synapse Cables
(Catalog No. 2755-HFC-SP1-01, 2755-HFC-SP2-01)
- DEC Keyboard Wedge Synapse Cables
(Catalog No. 2755-SV1-01, 2755-SV2-01)
- Scanner Emulation Synapse Cable
(Catalog No. 2755-HFC-SA1-01)

Configuration Bar Code Symbols

The configuration bar code symbols are all Code 128. The scanner is always enabled to read Code 128 symbols. Default settings are indicated by an asterisk.



9600 *

Indicates this Symbol
is the Default Setting

Refer to the user manual for the 2-D Hand-Held Bar Code Scanners (Publication 2755-6.4) for descriptions of the configuration settings.

How to Use this Guide

The following shows a typical sequence for configuring a scanner.

1. Connect scanner to host and apply power.
2. Configure scanner.
3. Configure communications. Is the scanner connected to an Allen-Bradley host device?

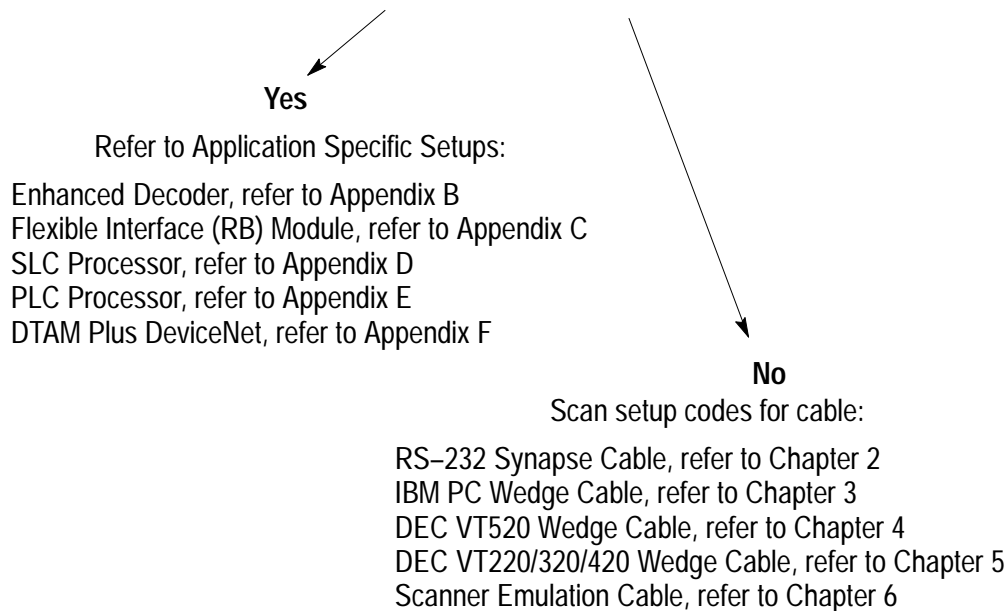

5. If the decoded data needs to be modified before being transmitted to a host device, scan Advanced Data Format codes in Appendix A.
4. Scanner is ready for operation. Use the test codes found on the inside back cover of this guide.

Scanner Configuration

Set Default Parameters

Scan the following labels to set the scanner to default settings.
The table on the next page lists the defaults.

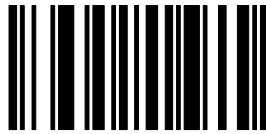

Set Defaults

The scanner is now set to these defaults:

| Scanner Configuration Parameters | Default Setting | Code on Page: |
|---|------------------|---------------|
| Set Default Parameters | | 1-1 |
| Symbologies | All Enabled | 1-3 |
| Code 39 Full ASCII | Enabled | 1-6 |
| Transmit Code 39 Check Digit | Enabled | 1-6 |
| Transmit UPC-A Check Digit | Enabled | 1-7 |
| Transmit UPC-E Check Digit | Enabled | 1-7 |
| Convert UPC-E to UPC-A | Disabled | 1-7 |
| Decode UPC / EAN Supplements | Disabled | 1-8 |
| Convert EAN-8 to EAN-13 | Disabled | 1-9 |
| UPC-A Preamble | System Character | 1-9 |
| UPC-E Preamble | System Character | 1-9 |
| Code 39 Code Lengths | 1-55 | 1-10 |
| Codabar Code Length | 2-55 | 1-11 |
| Interleaved 2 of 5 Code Length | 14 | 1-12 |
| Prefix/Suffix | Enter | 1-17 |
| Data Transmission Format | Data As Is | 1-16 |
| Transmit No-Read Message | Disabled | 1-17 |
| Transmit LRC Checksum | Disabled | 1-17 |
| Transmit Code ID Character | Disabled | 1-18 |
| Beep After Good Decode | Enabled | 1-19 |
| Beeper Tone | High | 1-19 |
| Decode Buffering | Disabled | 1-19 |
| Pause Duration | 0.0 seconds | 1-20 |
| Decode Attempt Duration | 0.5 seconds | 1-20 |
| Time Delay to Power Mode | 30 seconds | NO TAG |
| Timeout Between Decodes - Same Symbol | 0.6 seconds | NO TAG |
| Timeout Between Decodes - Different Symbols | 0.0 seconds | NO TAG |
| Smart Raster | Enabled | 1-22 |
| Hand-Held Options | Slab Raster | 1-22 |

Select The Symbologies You Want to Enable or Disable

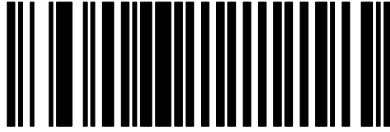

Enable Code 39*

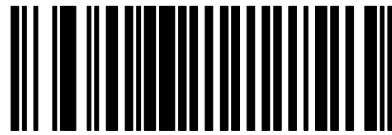

Disable Code 39

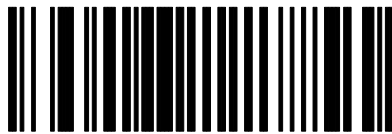

Enable UPC-A*



Disable UPC-A

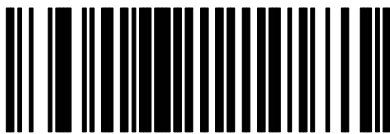

Enable UPC-E*

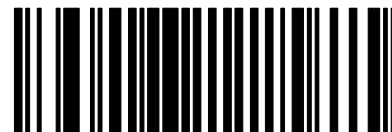

Disable UPC-E

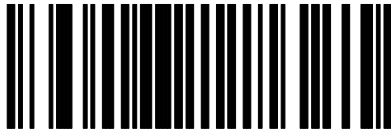

Enable Codabar

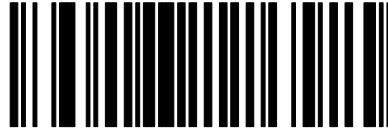

Disable Codabar*

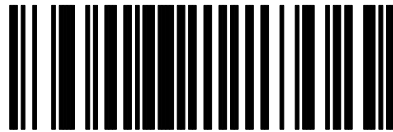

Enable EAN 8*

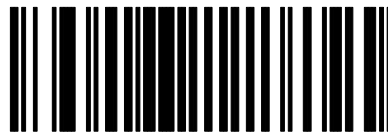

Disable EAN 8

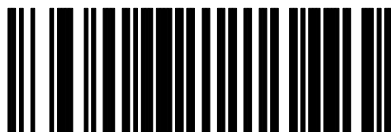

Enable EAN 13*

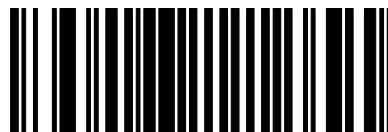

Disable EAN 13

Select The Symbologies You Want to Enable or Disable

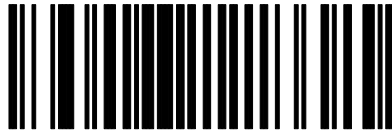

Enable Interleaved 2 of 5

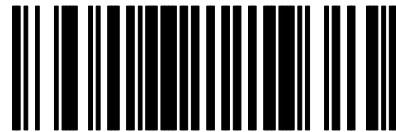

Disable Interleaved 2 of 5*

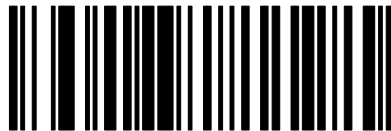

Enable UCC/EAN-128*



Disable UCC/EAN-128



Enable Code 128*



Disable Code 128

Note: The scanner is always enabled to read Code 128 configuration codes.

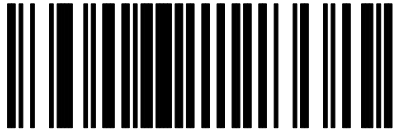

Enable PDF417 *

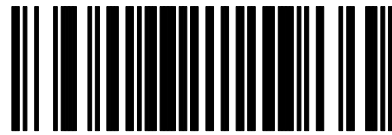

Disable PDF417

Select Code 39 Options

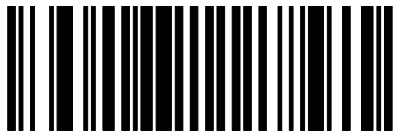

Enable Code 39 Full ASCII*

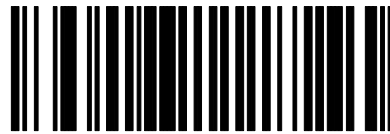

Disable Code 39 Full ASCII

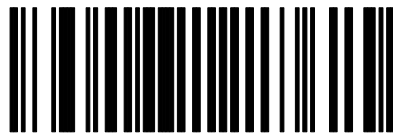

Enable Code 39 Check Digit*



Disable Code 39 Check Digit

Transmit UPC-A / UPC-E Check Digit

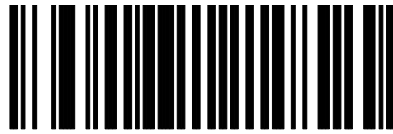

Transmit UPC-A Check Digit*

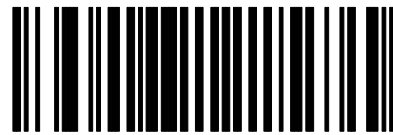

Do Not Transmit UPC-A Check Digit

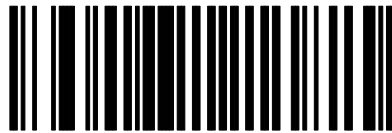

Transmit UPC-E Check Digit*

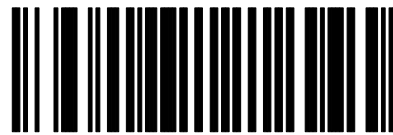

Do Not Transmit UPC-E Check Digit

Convert UPC-E to UPC-A

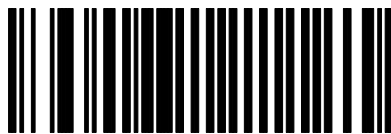

Convert UPC-E to UPC-A

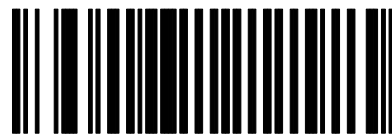

Do Not Convert UPC-E to UPC-A*

Decode UPC / EAN Supplements

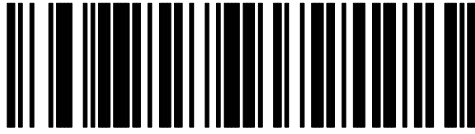

Decode UPC / EAN Supplemental

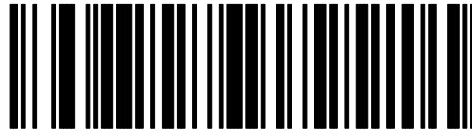

Ignore UPC / EAN With Supplementals*



Autodiscriminate UPC / EAN with Supplementals

Convert EAN-8 to EAN-13

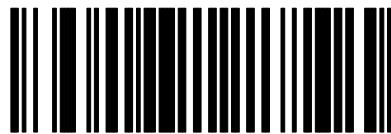

Convert EAN-8 to EAN-13



Disable Convert EAN-8 to EAN-13*

Select UPC-A Preamble

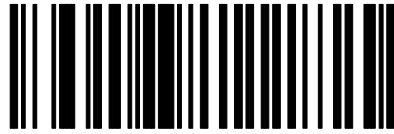

No UPC-A Preamble

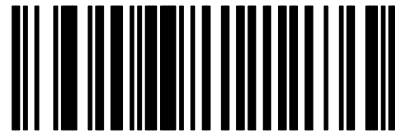

UPC-A System Character Preamble*

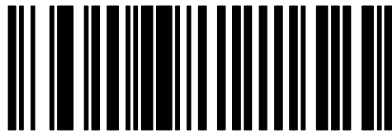

UPC-A System Character and Country Code Preamble

Select UPC-E Preamble

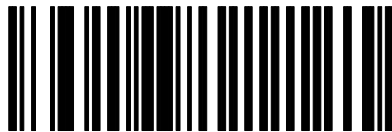

No UPC-E Preamble

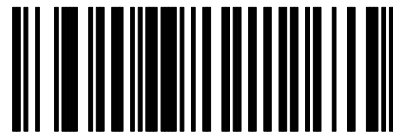

UPC-E System Character Preamble*

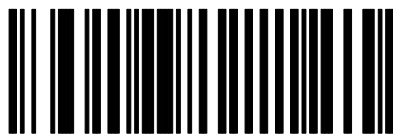

UPC-E System Character and Country Code Preamble

Select Code 39 – Code Lengths



Code 39 Any Length



Code 39 Length Within Range
(Range 01-55*)

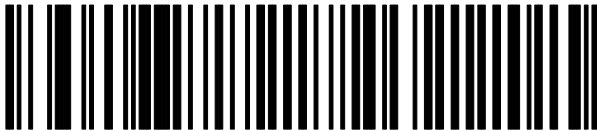

Code 39 – One Discrete Length
(Range 01-55) Default is None



Code 39 – Two Discrete Lengths
(Range 01-55) Default is None

Select Codabar Code Lengths

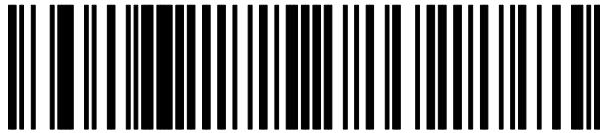

Codabar Any Length

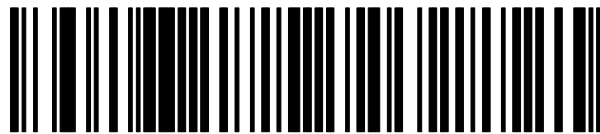

Codabar Length Within Range
(Range 01-55) Default is 02 -55

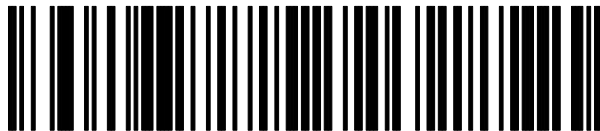

Codabar - One Discrete Length
(Range 01-55) Default is None



Codabar - Two Discrete Lengths
(Range 01-55) Default is None

Select Interleaved 2 of 5 Code Lengths

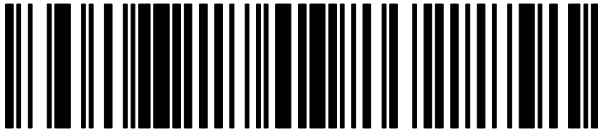

Interleaved 2 of 5 Any Length

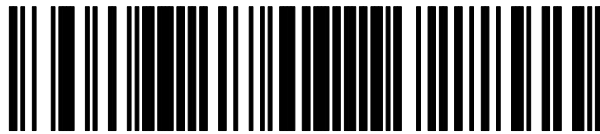

Interleaved 2 of 5 - Length Within Range
(Range 02-55) Default is None

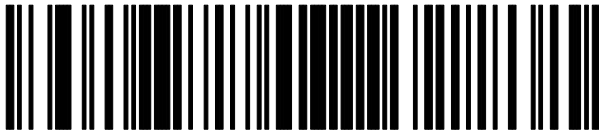

Interleaved 2 of 5 - One Discrete Length
(Range 02-54) Default is 14

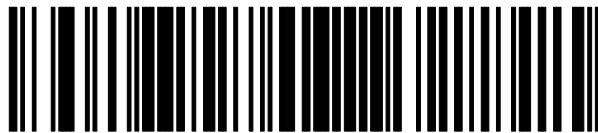

Interleaved 2 of 5 - Two Discrete Lengths
(Range 02-54) Default is None

Scan 2 Digit Code Length

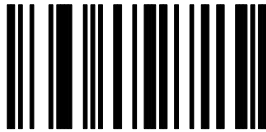

0



1

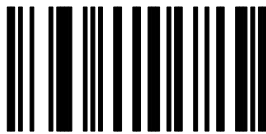

2

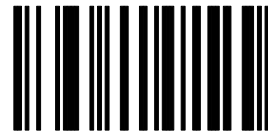

3

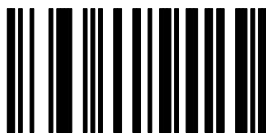

4



5

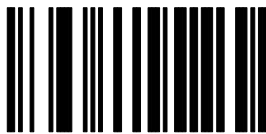

6



7

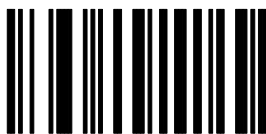

8



9



Cancel (Clears Code Length)

Select Prefix/Suffix Options

To set a suffix or prefix, scan the appropriate label below and then scan the 4 digit ASCII equivalent for the character you want to use as the prefix or suffix. See the ASCII Chart in Appendix G.

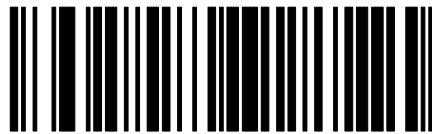

Prefix

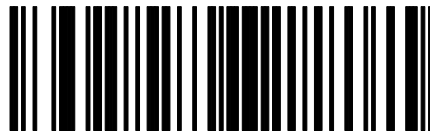

Suffix

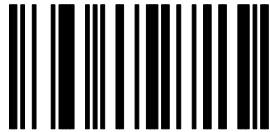
Prefix/Suffix – 4 Digit ASCII Equivalent Value

0



1

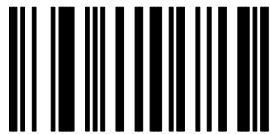

2



3

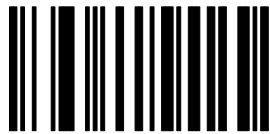

4



5



6

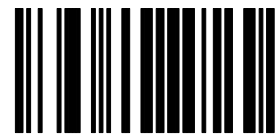

7

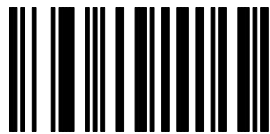

8

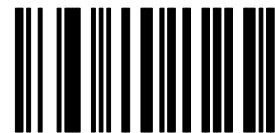

9

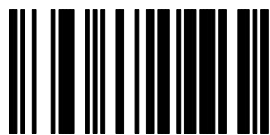
**Cancel (Clears Code Length)**

Data Transmission Format



Scan this Symbol First



Send <Data> As Is*
(No Prefix or Suffix)

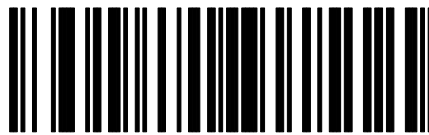

Send <Prefix> <Data>

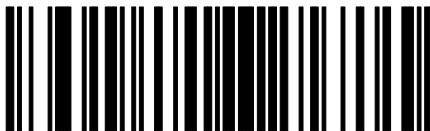

Send <Data> <Suffix>

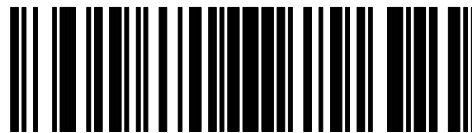

Send <Prefix> <Data> <Suffix>

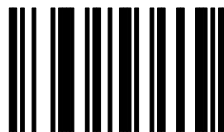

Scan Enter after Scanning Option



Cancel

Transmit No-Read Message

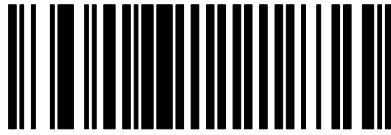

Send NR Message When Symbol Does Not Decode

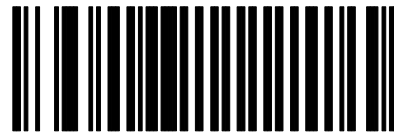

Do Not Send NR Message

Transmit LRC Checksum



Enable LRC Checksum

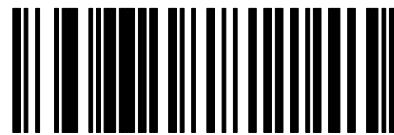

Disable LRC Checksum

Transmit Code ID Character

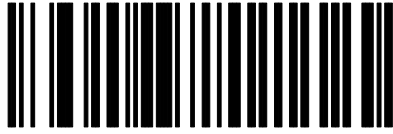

Transmit Symbol Code ID Character

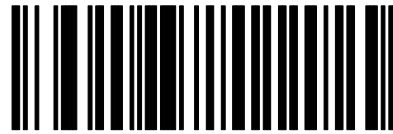

Transmit AIM Code ID Character

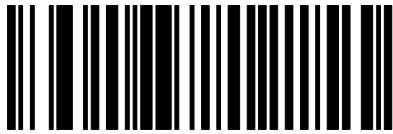

Do Not Transmit Code ID Character

Beeper After Good Decode / Beeper Tone

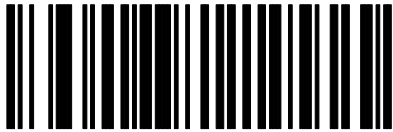

Beep After Good Decode*

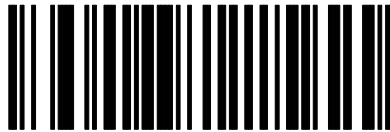

Do Not Beep After Good Decode

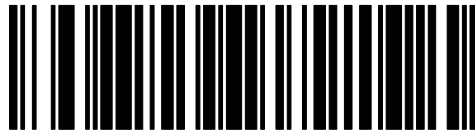

Low Tone

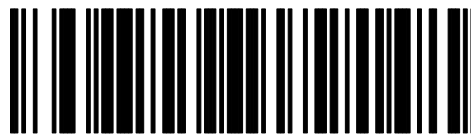

Medium Tone

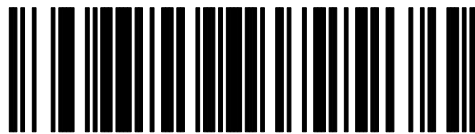

High Tone

Decode Buffering

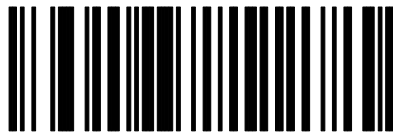

Enable Decode Buffering

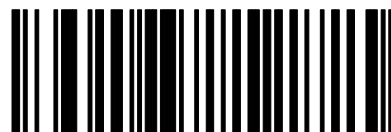

Disable Decode Buffering

Pause Duration



Enter a Pause Duration
Default is 0.0 Seconds

Decode Attempt Duration

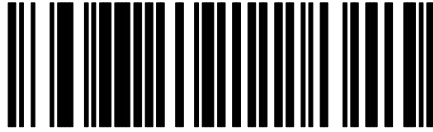

Enter a Decode Attempt Duration
Default is 5.0 seconds

Pause/Decode Attempt Duration Values

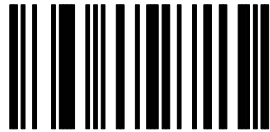

0

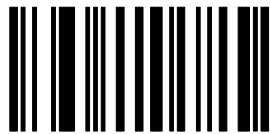

2

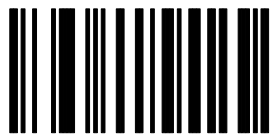

4



6



8



Cancel



1



3

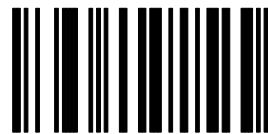

5



7

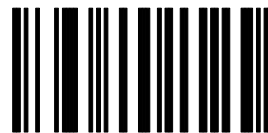

9

Smart Raster

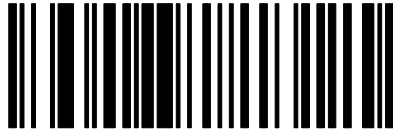

Enable Smart Raster*

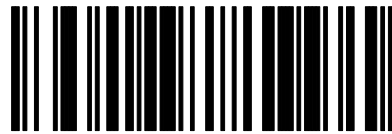

Disable Smart Raster

Hand-Held Options

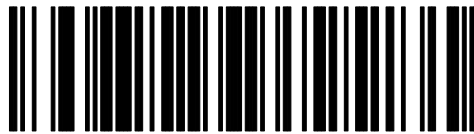

Slab Raster*

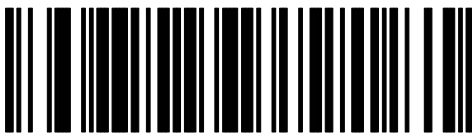

Aiming Dot (Normal Timeout)



Aiming Dot (Extended Timeout)

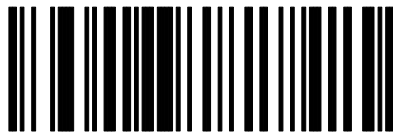

Enable Always Raster

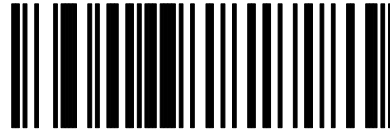

Disable Always Raster

RS-232 Synapse Cable (Communication Setup)

This chapter provides the configuration bar codes for the following RS-232 Synapse cables:

- (Catalog No. 2755-HFC-SR2-01)
- (Catalog No. 2755-HFC-SR3-01)

Set RS-232 Synapse Cable Defaults

Scan this label to set the default settings for the RS-232 Synapse cable. Defaults are indicated with an asterisk.

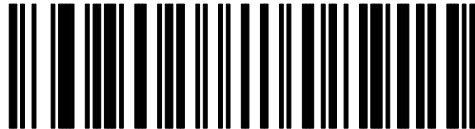

Set RS-232 Synapse Cable Defaults

Scan this label to set the RS-232 Synapse cable to the default settings shown below.

| RS-232 Synapse Cable Parameters | Default Setting | Code on Page: |
|---------------------------------|--|---------------|
| Host | Standard RS-232 | 2-3 |
| Baud Rate | 9600 | 2-4 |
| Parity | None | 2-5 |
| Check Parity | Enabled | 2-5 |
| Stop Bits | 1 | 2-6 |
| Data Bits | 8 | 2-6 |
| RTS State | Low | 2-7 |
| Hardware Handshaking | None | 2-7 |
| Software Handshaking | None | 2-8 |
| Beep on BEL | Disabled | 2-9 |
| Unknown Characters | Send Bar Codes With Unknown Characters | 2-9 |
| Response Timeout | 2 Seconds | 2-10 |
| Parameter Set | Set #1 | 2-12 |

Scan the bar code symbols for the settings you need to change.

RS-232 Synapse Cable Fixed Format Hosts

Currently only one option for fixed format hosts is available. Scan the Standard RS-232 host bar code symbol. Additional hosts may be added at a future date.

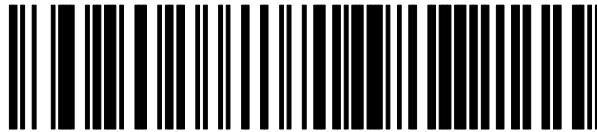

Standard RS-232 *

RS-232 Synapse Cable Baud Rate

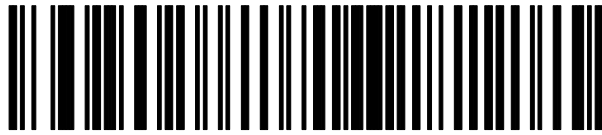

110

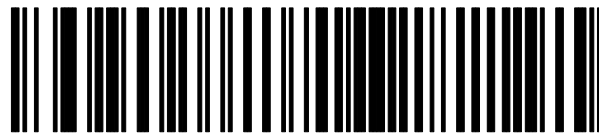

300

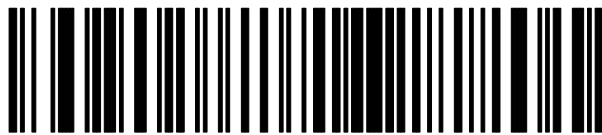

600

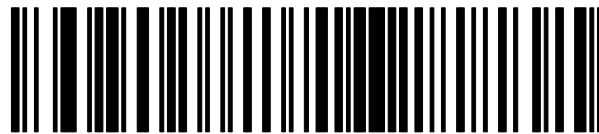

1200

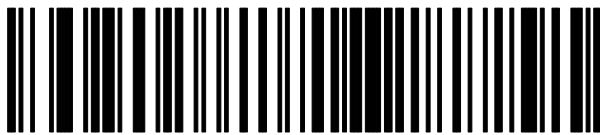

2400

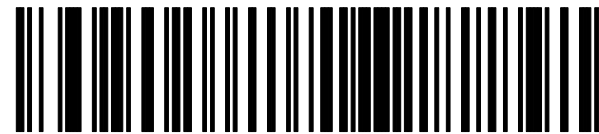

4800

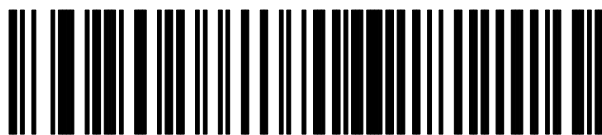

9600 *

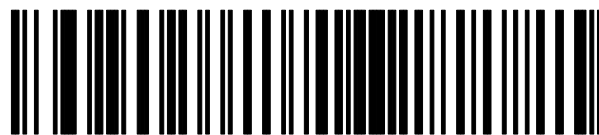

19200

RS-232 Synapse Cable Parity Options

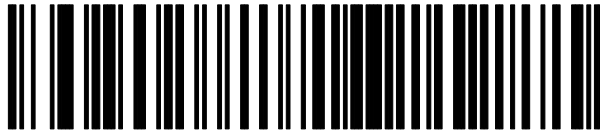

None *

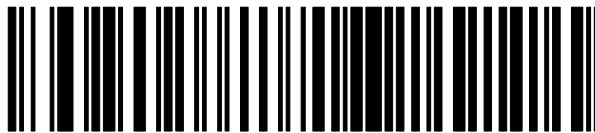

Odd

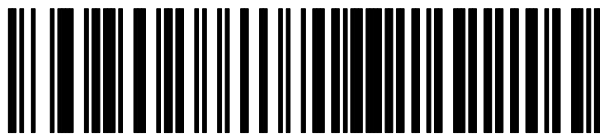

Even

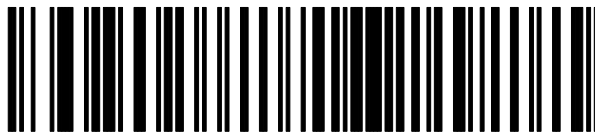

Mark

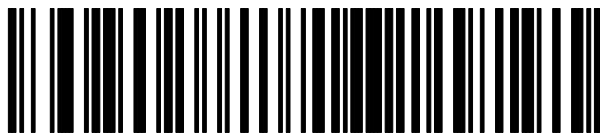

Space

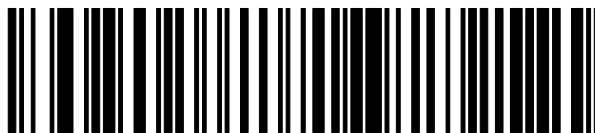

Check Parity*

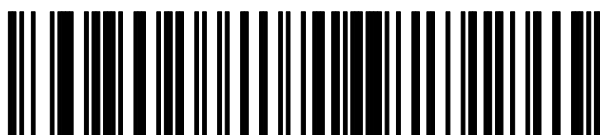

Do Not Check Parity

RS-232 Synapse Cable Stop and Data Bits

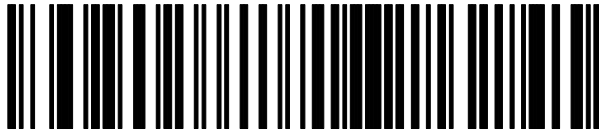

One Stop Bit *

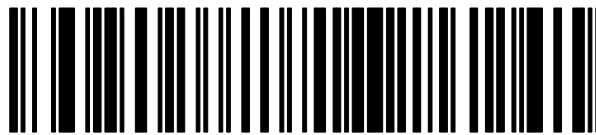

Two Stop Bits

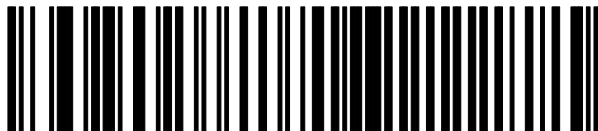

8 Data Bits *

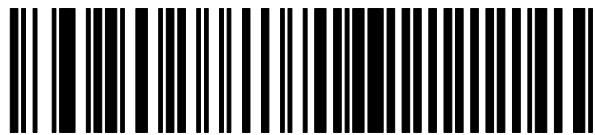

7 Data Bits

RS-232 Synapse Cable Hardware Handshaking

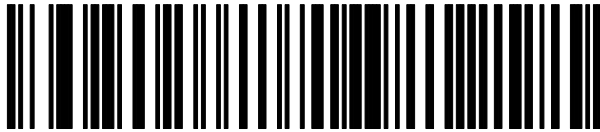

No Hardware Handshaking*

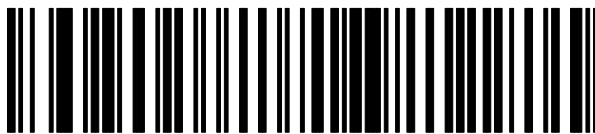

RTS / CTS Enable

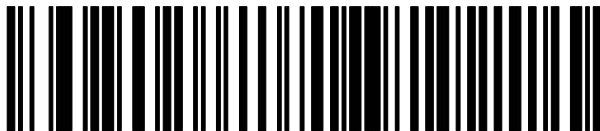

RTS Low *

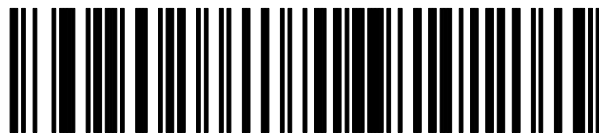

RTS High

RS-232 Synapse Cable Software Handshaking

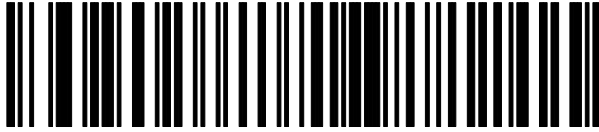

No Software Handshaking*

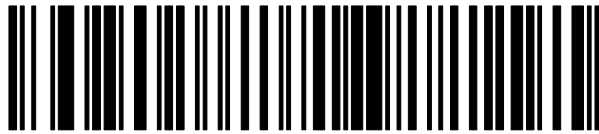

ACK / NAK

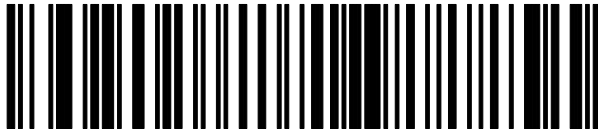

ENQ Only

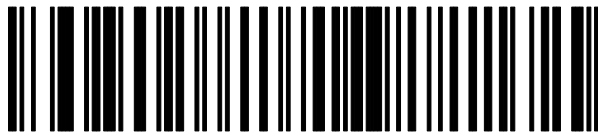

ACK / NAK with ENQ

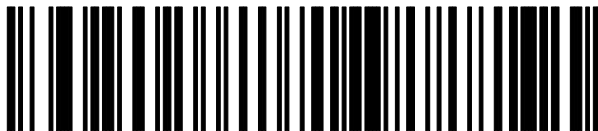

XON / XOFF

RS-232 Synapse Cable Beep On <BEL>

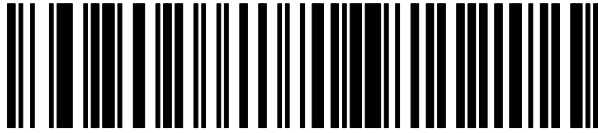

Do Not Beep on <BEL> *

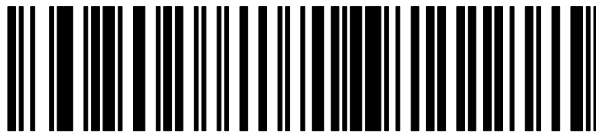

Beep on <BEL>

RS-232 Synapse Cable Unknown Characters

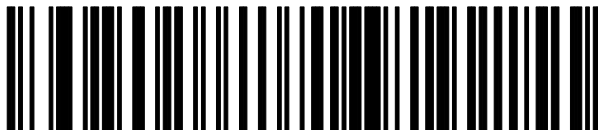

Send Bar Codes with Unknown Characters *

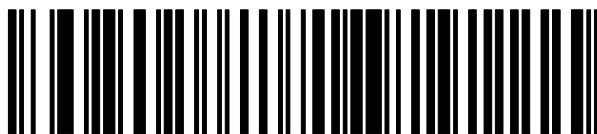

Do Not Send Bar Codes with Unknown Characters

RS-232 Synapse Cable Response Timeout

Scan the following symbol followed by the two digit timeout from 0.0 to 9.9 (default is 2.0 seconds).

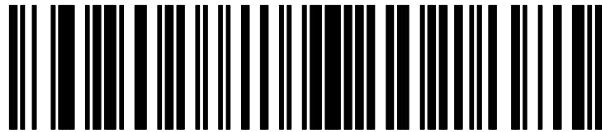

Enter Response Timeout

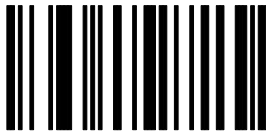

0



1



2



3

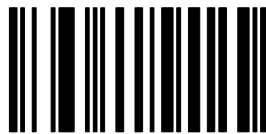

4

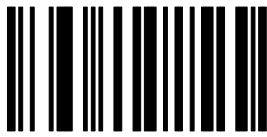

5

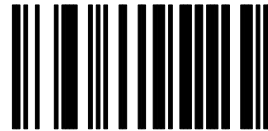

6

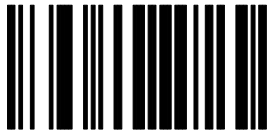

7



8



9



Cancel (Clears Entry)

RS-232 Synapse Cable Advanced Features

Scan the following symbols to select the current parameter set and/or set the defaults for each parameter set.

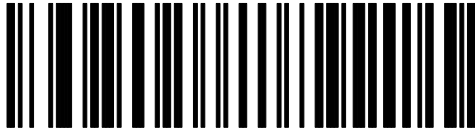

Parameter Set 1 *

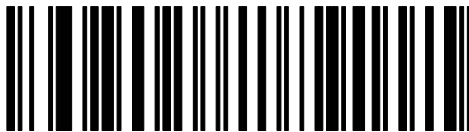

Parameter Set 2



Set Cable Defaults Current Parameter Set



Set Cable Defaults Both Parameter Sets

IBM Keyboard Wedge (Communication Setup)

This chapter provides the configuration bar codes for the IBM Keyboard Wedge Synapse cables:

- (Catalog No. 2755-HFC-SP1-01)
- (Catalog No. 2755-HFC-SP2-01)

IBM Keyboard Wedge Synapse Cable Defaults

Scan the following bar code to set the IBM Keyboard Wedge Cables to their default values. Defaults are indicated with an asterisk *.



Scan this label to set the IBM PC Wedge Synapse cable to the default settings shown below.

| IBM Keyboard Wedge Parameters | Default Setting | Code on Page: |
|-----------------------------------|--|---------------|
| Host | IBM PC/AT IBM PS/2-50, 55SX, 60, 70, 80 | 3-2 |
| Country | North American | 3-3 |
| Bar Codes with Unknown Characters | Send Bar Codes With Unknown Characters | 3-4 |
| Intercharacter Delay | 5 milliseconds | 3-4 |
| Parameter Set | Parameter Set 1 | 3-5 |

Scan the bar code symbols for the settings you need to change.

IBM Keyboard Wedge Cable Host

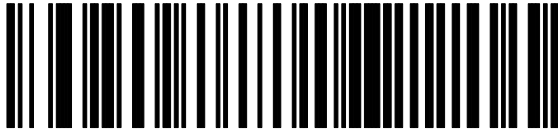

IBM PC / AT *
IBM PS/2-50, 55SX, 60, 70, 80

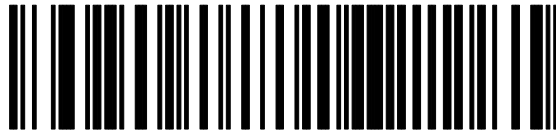

IBM PC / XT

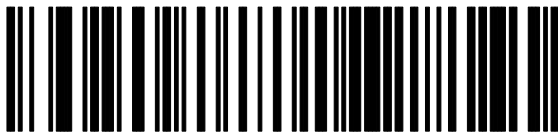

IBM PS/2-30

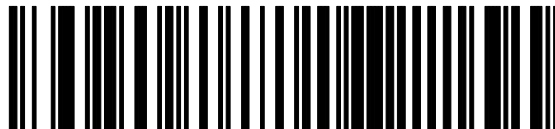

NCR 7052

IBM Keyboard Wedge Country Selection

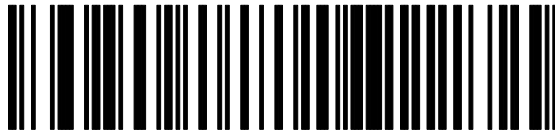

North American *



German

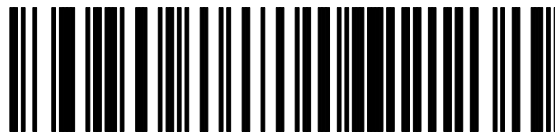

French

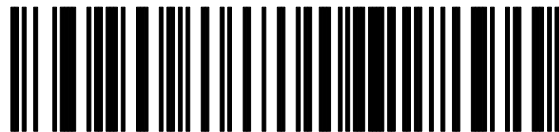

French International

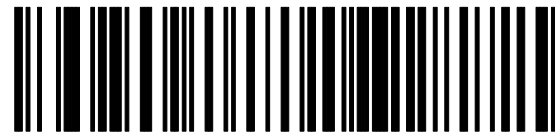

Spanish



Italian



Swedish



British

IBM Keyboard Wedge Unknown Characters

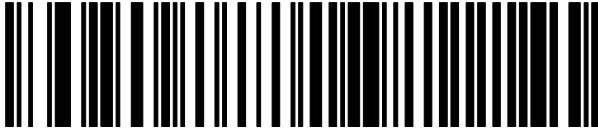

Send Bar Codes with Unknown Characters *

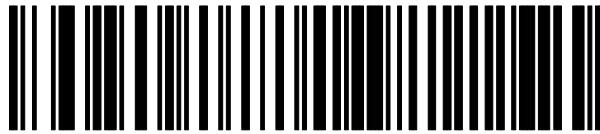

Do Not Send Bar Codes with Unknown Characters

IBM Keyboard Wedge Intercharacter Delay

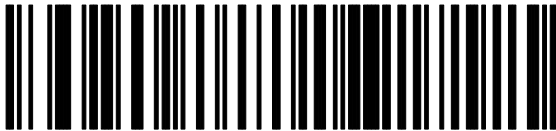

Short 5 Millisecond Delay *

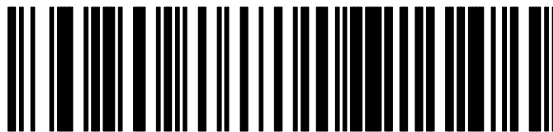

Medium 50 Millisecond Delay



Long 99 Millisecond Delay

IBM Keyboard Wedge Cable Advanced Features

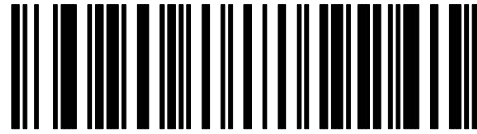

Parameter Set 1 *

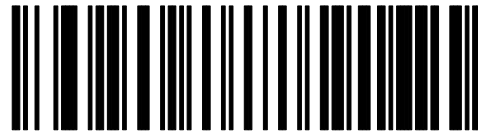

Parameter Set 2

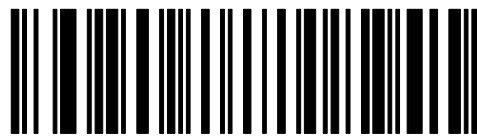

Set Cable Defaults Current Parameter Set



Set Cable Defaults Both Parameter Sets

DEC VT520 Keyboard Wedge (Communication Setup)

This chapter provides the configuration bar codes for the DEC keyboard Synapse cable:

- (Catalog No. 2755-HFC-SV2-01)

DEC VT520 Keyboard Wedge Synapse Cable Defaults

Scan the following bar code to set the IBM Keyboard Wedge Cables to their default values. Defaults are indicated with an asterisk.

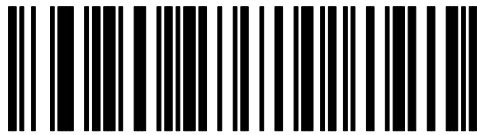

Set DEC VT520 Keyboard Wedge Synapse Cable Defaults

Scan this label to set the DEC VT520 Synapse cable to the default settings shown below.

| DEC VT520 Keyboard Wedge Cable Parameters | Default Setting | Code on Page: |
|---|--|---------------|
| Host | DEC VT520 | 4-2 |
| Country | North American | 4-2 |
| Bar Codes with Unknown Characters | Send Bar Codes With Unknown Characters | 4-4 |
| Intercharacter Delay | 5 milliseconds | 4-4 |
| Parameter Set | Parameter Set 1 | 4-5 |

Scan the bar code symbols for the settings you need to change.

DEC VT520 Wedge Synapse Cable Host



DEC VT520 *

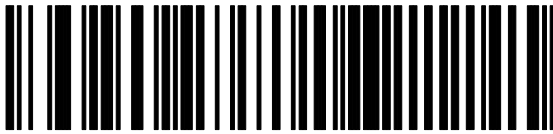

DEC VT520 with PS/2 Keyboard

DEC VT520 Keyboard Wedge Country Selection

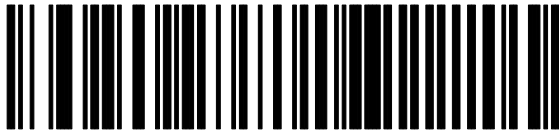

North American *



German



French

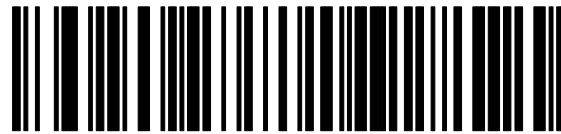

French International

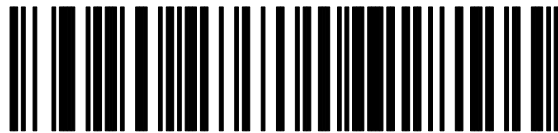

Spanish

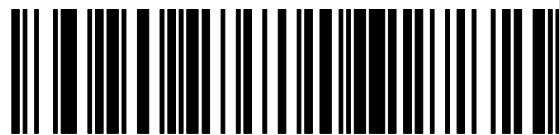

Italian

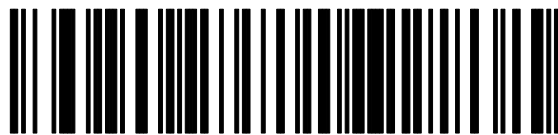

Swedish



British

DEC VT520 Cable Unknown Characters

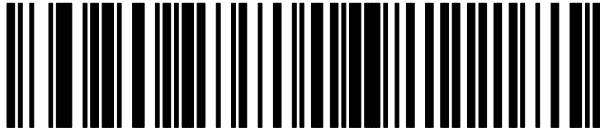

Send Bar Codes with Unknown Characters *

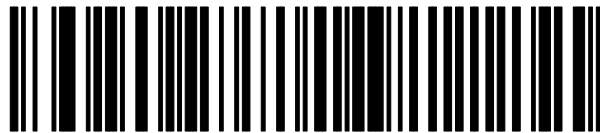

Do Not Send Bar Codes with Unknown Characters

DEC VT520 Keyboard Wedge Intercharacter Delay

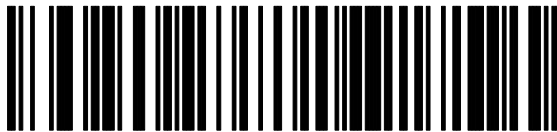

Short 5 Millisecond Delay *



Medium 50 Millisecond Delay

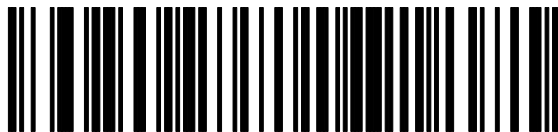

Long 99 Millisecond Delay

DEC VT520 Keyboard Wedge Synapse Cable Advanced Features

Scan the following symbols to select the current parameter set and/or set the defaults for each parameter set.

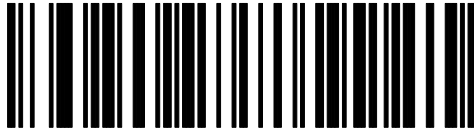

Parameter Set 1 *

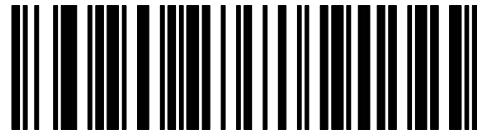

Parameter Set 2

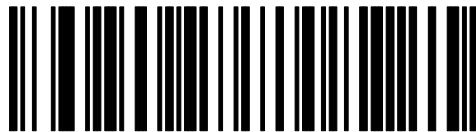

Set Cable Defaults Current Parameter Set

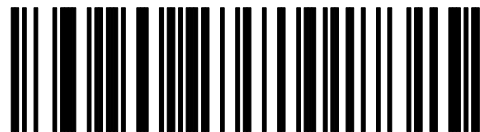

Set Cable Defaults Both Parameter Sets

DEC VT220/320/420 Keyboard Wedge Cable (Communication Setup)

This chapter provides the configuration bar codes for the DEC VT220/320/420 keyboard wedge Synapse cable:

- (Catalog No. 2755-HFC-SV1-01)

DEC VT220/320/420 Keyboard Wedge Interface Cable Defaults

Scan the following bar code to set the DEC VT220/320/420 Keyboard Wedge Cables to their default values. Defaults are indicated with an asterisk *.

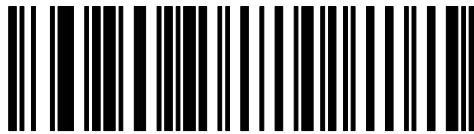

Set DEC VT220/320/420 Wedge Synapse Cable Defaults

Scan this label to set the DEC VT220/320/420 Synapse cable to the default settings shown below.

| DEC VT220/320/420 Keyboard Wedge Cable | Default Setting | Code on Page: |
|---|---|------------------|
| Host | DEC VT220 / 320 | 5-2 |
| Country | North American | 5-2 |
| Bar Codes with Unknown Characters | Send Bar Codes With Unknown Characters | 5-4 |
| Intercharacter Delay | 5 milliseconds | 5-4 |
| Parameter Set | Parameter Set 1 | 5-5 |

Scan the bar code symbols for the settings you need to change.

DEC VT220 / 320 / 420 Keyboard Wedge Synapse Cable Host

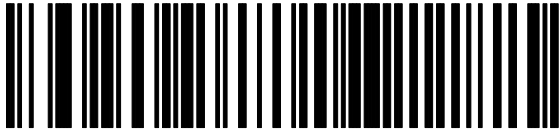

DEC VT220 / 320 *

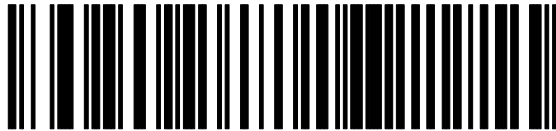

DEC VT420

DEC VT220 / 320 / 420 Keyboard Wedge Country Selection

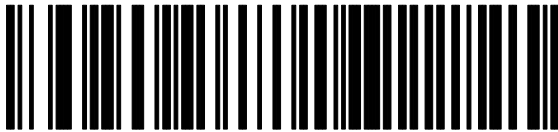

North American *

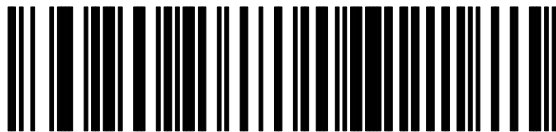

German



French

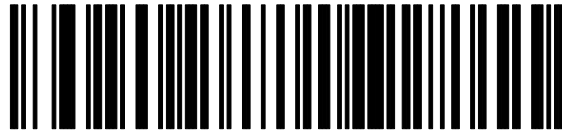

French International

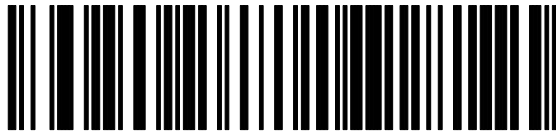

Spanish

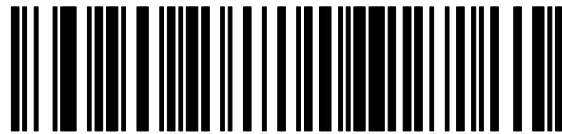

Italian

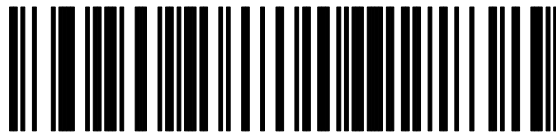

Swedish

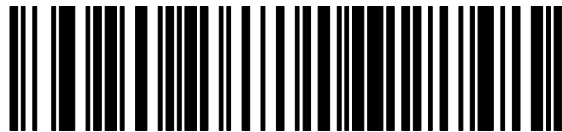

British

DEC VT220/320/420 Keyboard Wedge Unknown Characters

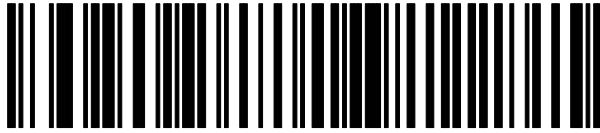

Send Bar Codes with Unknown Characters *

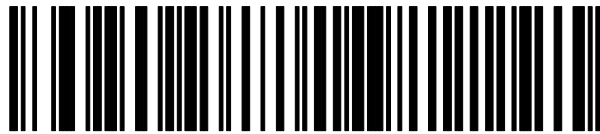

Do Not Send Bar Codes with Unknown Characters

DEC VT220/320/420 Keyboard Wedge Intercharacter Delay

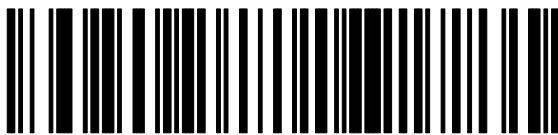

Short 5 Millisecond Delay *

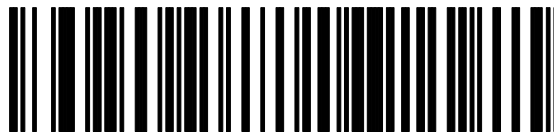

Medium 50 Millisecond Delay

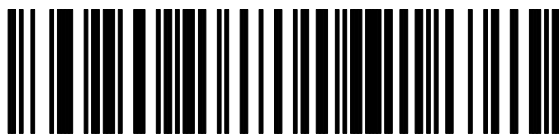

Long 99 Millisecond Delay

DEC VT220/320/420 Keyboard Wedge Advanced Features

Scan the following symbols to select the current parameter set and/or set the defaults for each parameter set.

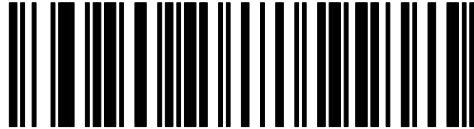

Parameter Set 1 *

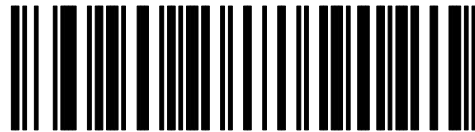

Parameter Set 2

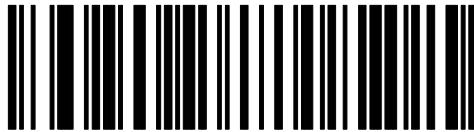

Set Cable Defaults Current Parameter Set

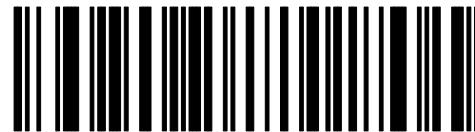

Set Cable Defaults Both Parameter Sets

Scanner Emulation Cable (Communication Setup)

This chapter provides the configuration bar codes for the scanner emulation Synapse cable:

- (Catalog No. 2755-HFC-SA1-01)

Scanner Emulation Synapse Cable Defaults

Scan the following bar code to set the scanner emulation cable to its default values. Defaults are indicated with an asterisk *.

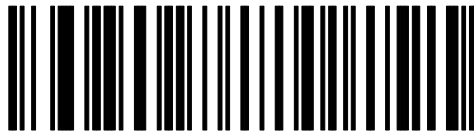

Set Scanner Emulation Cable Defaults

Scan this label to set the Scanner Emulation Synapse cable to the default settings shown below.

| Scanner Emulation Synapse Cable | Default Setting | Code on Page: |
|---------------------------------|--|---------------|
| Emulation | Standard | 6-2 |
| Leading Margin | 80 Millisecond | 6-3 |
| Decode LED | Enabled | 6-3 |
| Emulation Timeout | 3 Seconds | 6-4 |
| Polarity | Margin Low / Bar High | 6-5 |
| Unknown Characters | Send Bar Codes with Unknown Characters | 6-5 |
| Convert All to Code 39 | Disabled | 6-6 |
| Code 39 to Code 39 Full ASCII | Disabled | 6-6 |
| Parameter Set | Parameter Set 1 | 6-7 |

Scanner Emulation Host



Standard Wand Emulation *

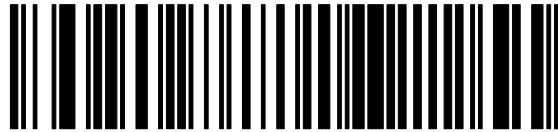

MSI Wand Emulation

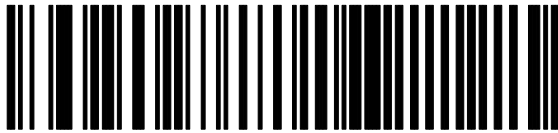

Telxon Wand Emulation

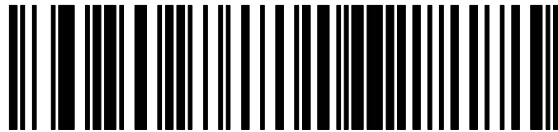

Norand Wand Emulation

Scanner Emulation Variable Leading Margin

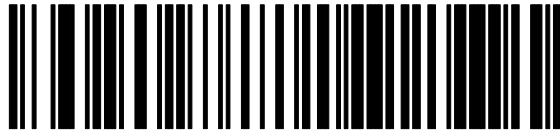

80 Millisecond *



140 Millisecond

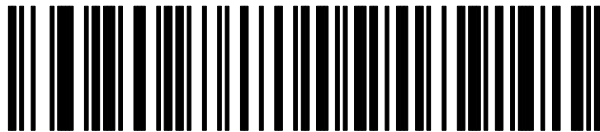

200 Millisecond

Scanner Emulation Check for Decode LED

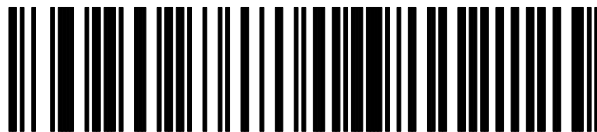

Check for Decode LED *

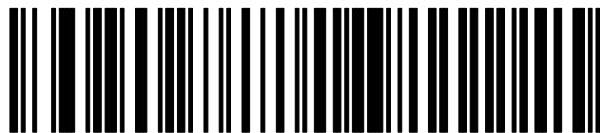

Do Not Check for Decode LED

Scanner Emulation Timeout

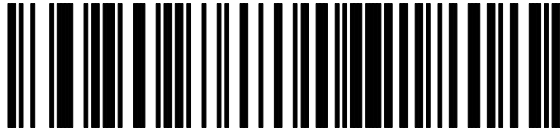

3 Second Timeout *

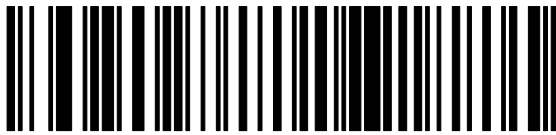

4 Second Timeout

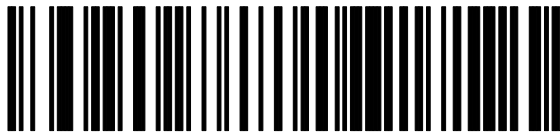

5 Second Timeout

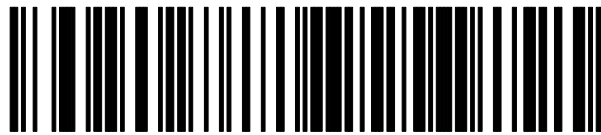

10 Second Timeout

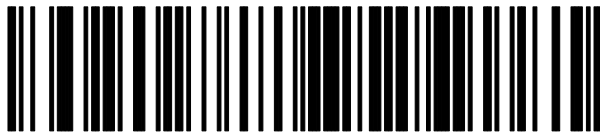

30 Second Timeout

Scanner Emulation Polarity

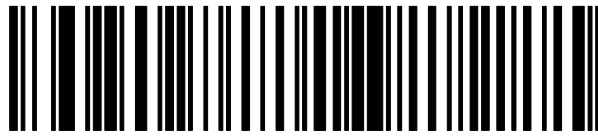

Margin Low / Bar High *

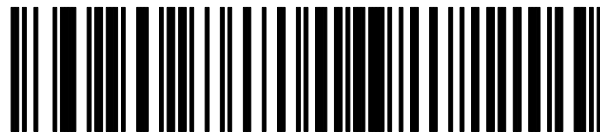

Margin High / Bar Low

Send Bar Codes with Unknown Characters

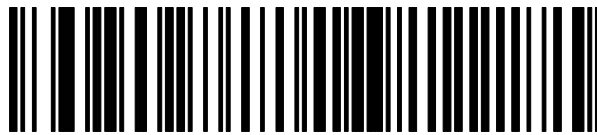

Send Bar Codes with Unknown Characters *

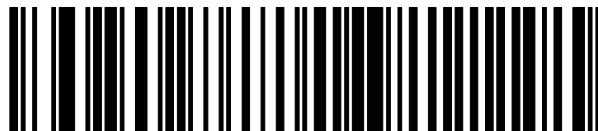

Do Not Send Bar Codes with Unknown Characters

Scanner Emulation Convert All to Code 39

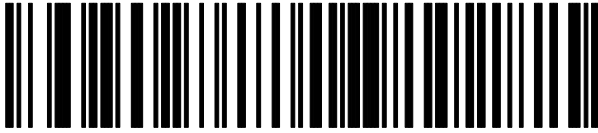

Do Not Convert All to Code 39 *

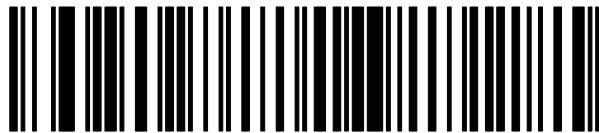

Convert All to Code 39

Scanner Emulation Code 39 to Code 39 Full ASCII

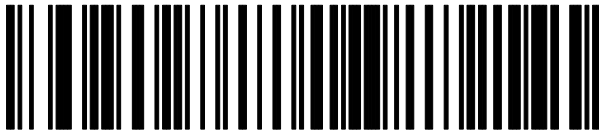

Do Not Do Not Convert Code 39 to Code 39 Full ASCII *

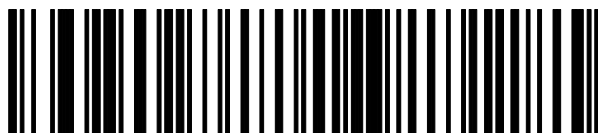

Convert Code 39 to Code 39 Full ASCII

Scanner Emulation Cable Advanced Features

Scan the following symbols to select the current parameter set and/or set the defaults for each parameter set.

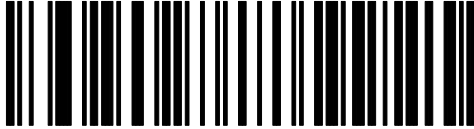

Parameter Set 1 *

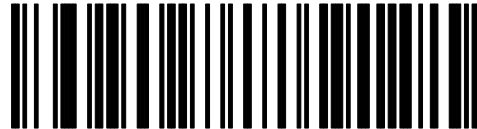

Parameter Set 2

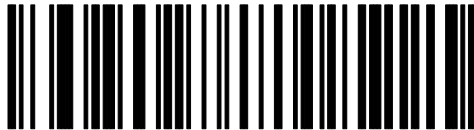

Set Cable Defaults Current Parameter Set



Set Cable Defaults Both Parameter Sets

ADF Bar Codes

This Appendix contains all of the bar codes for Advanced Data Formatting (ADF). The table below lists the group of ADF codes and their corresponding page numbers. See Appendix E in the Scanner Configuration manual for a description of the ADF codes.

| ADF Bar Codes | Page |
|---------------------------------------|------|
| Special Commands | |
| Start/Save Rule | A-2 |
| Erase/Quit Rule | A-3 |
| Disable Rule Sets | A-4 |
| Criteria | |
| Code Types | A-5 |
| Code Lengths | A-7 |
| Specific Data String / Numeric Keypad | A-10 |
| Rule Belongs to Set | A-13 |
| Actions | |
| Send Characters/Data | A-14 |
| Skip Ahead/Back | A-18 |
| Spaces and Zeros | A-22 |
| Send Value | A-23 |
| Beeps | A-24 |
| Pad Spaces | A-25 |
| Pad Zeros | A-29 |
| Send Control Characters | A-33 |
| Send Keyboard Characters | A-37 |
| AlphaNumeric Keyboard | A-49 |
| Turn on Rule Set | A-60 |

Special Commands – Start/Save Rules



Start New Rule



Save Rule

Special Commands – Erase/Quit Rules

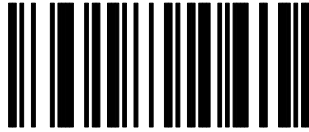

Erase Criteria and Start Again



Erase Actions and Start Again

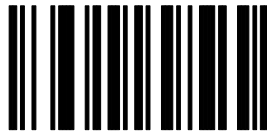

Quit Entering Rules

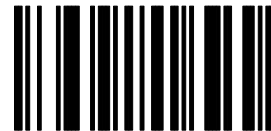

Erase Previously Saved Rule



Erase All Rules

Special Commands – Disable Rule Sets

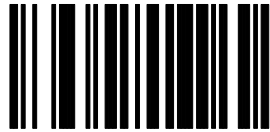

Disable Rule Set 1

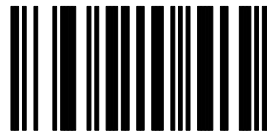

Disable Rule Set 2

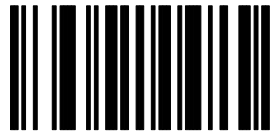

Disable Rule Set 3

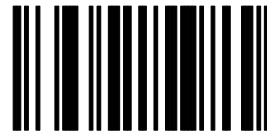

Disable Rule Set 4



Disable All Rule Sets

Criteria – Code Types

You must scan code types before scanning other criteria.



Code 39

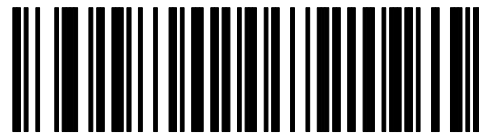

Codabar



Code 128

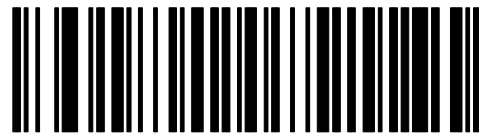

Interleaved 2 of 5



EAN 128

Criteria – Code Types

You must scan code types before scanning other criteria.



UPC-A

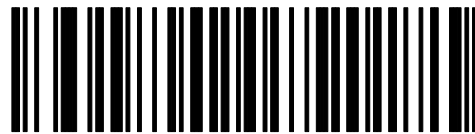

UPC-E

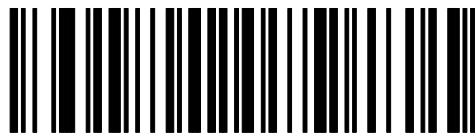

EAN-8



EAN-13

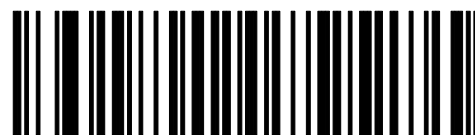

PDF417

Criteria – Code Lengths

This is not a keypad. Select one length per rule.



1

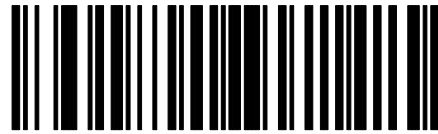

2

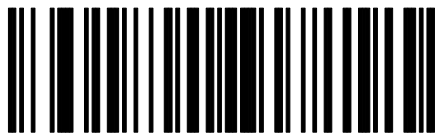

3

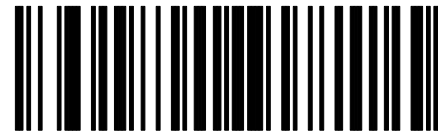

4

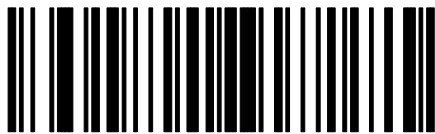

5

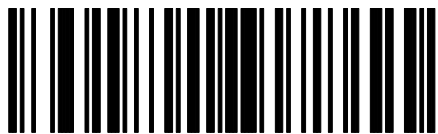

6



7

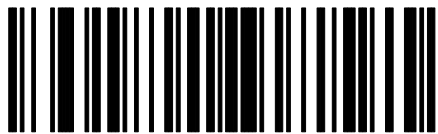

8

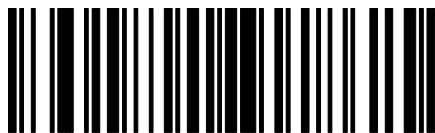

9



10

Criteria – Code Lengths

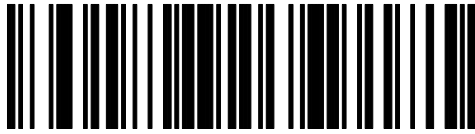

11

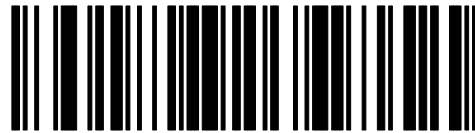

12

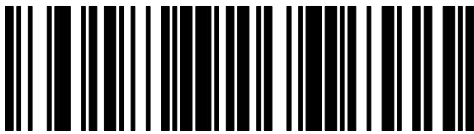

13

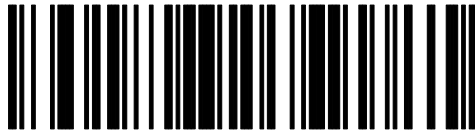

14

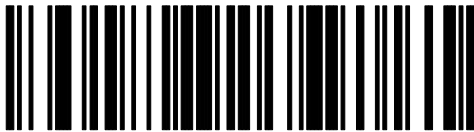

15

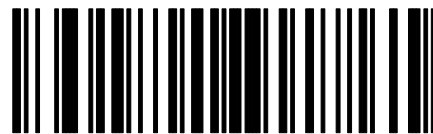

16

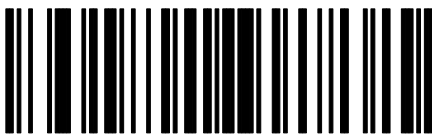

17



18

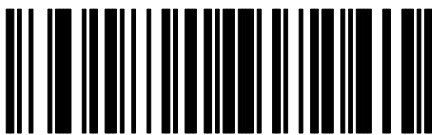

19

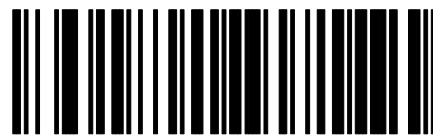

20

Criteria – Code Lengths



Criteria – Specific Data String

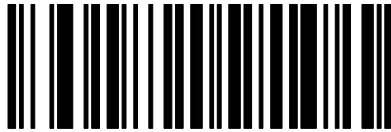

Specific String at Start

1. Go to **Alphanumeric Keyboard** (page A-49) to enter string
2. Scan **End of Message** bar code (page A-56).

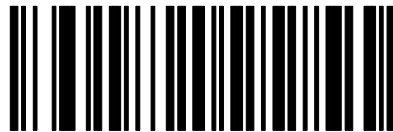

Specific String Any Location

1. Scan 2-digit length on **Numeric Keypad** (page A-11) to enter location.
2. Go to **Alphanumeric Keyboard** (page A-49) to enter string.
2. Scan **End of Message** bar code (page A-56).

Criteria – Numeric Keypad



0



2

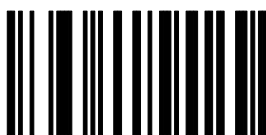

4



6



8



Cancel



1



3



5



7



9

Criteria – Specific Data String



Send Up to Character ①

Note: If there is no match when the rule is interpreted and the rule fails, the next rule is checked.

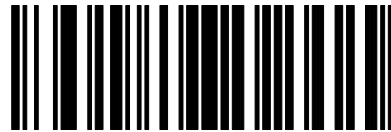

Move to Character ①

Note: If there is no match when the rule is interpreted and the rule fails, the next rule is checked.

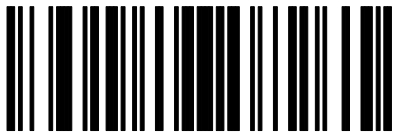

Move Past Character ①

① Enter character using **AlphaNumeric Keyboard** (page A-49).

Criteria – Rules Belongs to Sets

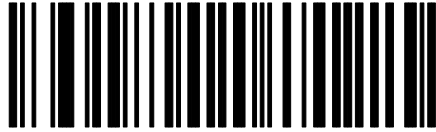

Rule Belongs to Set 1

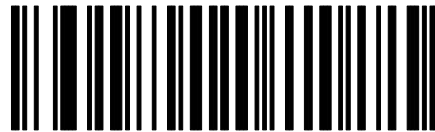

Rule Belongs to Set 2



Rule Belongs to Sets 3

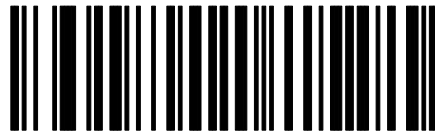

Rule Belongs to Set 4

Actions – Send Characters / Data

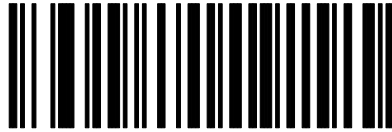

Send Pause

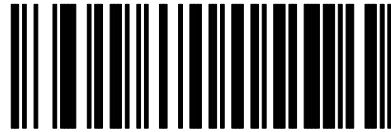

Send All Remaining Data



Send Next Character

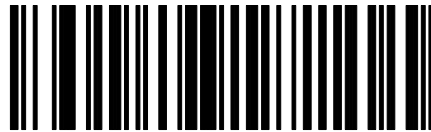

Send Next 2 Characters

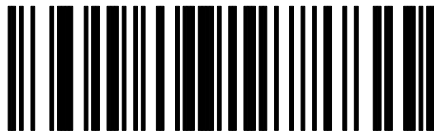

Send Next 3 Characters

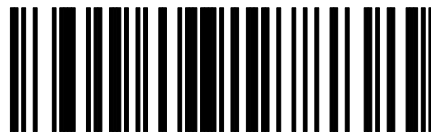

Send Next 4 Characters



Send Next 5 Characters



Send Next 6 Characters

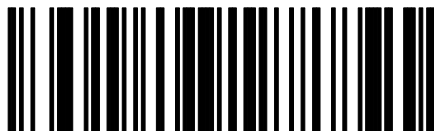

Send Next 7 Characters

Actions – Send Characters / Data



Send Next 8 Characters

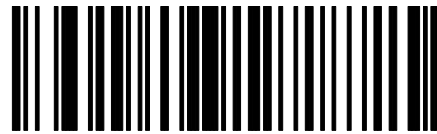

Send Next 9 Characters

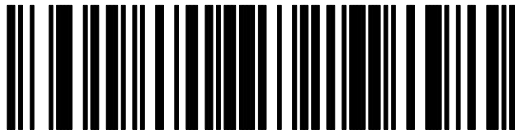

Send Next 10 Characters

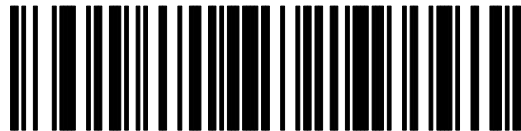

Send Next 11 Characters



Send Next 12 Characters



Send Next 13 Characters

Actions – Send Characters / Data

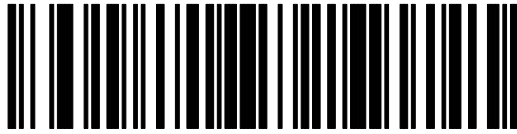

Send Next 14 Characters



Send Next 15 Characters

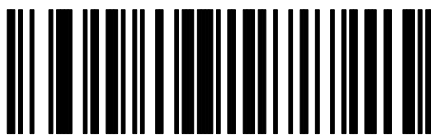

Send Next 16 Characters

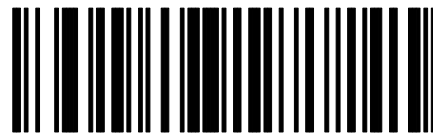

Send Next 17 Characters

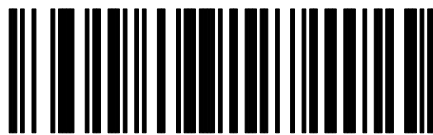

Send Next 18 Characters

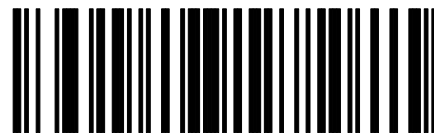

Send Next 19 Characters

Actions – Send Characters / Data



Send Next 20 Characters



Send Next 50 Characters



Send Next 100 Characters



Send Next 150 Characters

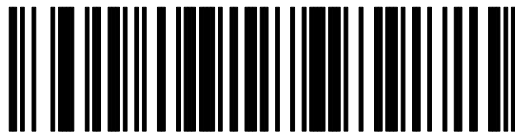

Send Next 200 Characters



Send Next 250 Characters

Actions – Skip Ahead / Back



Skip Ahead 1 Character



Skip Ahead 2 Characters



Skip Ahead 3 Characters

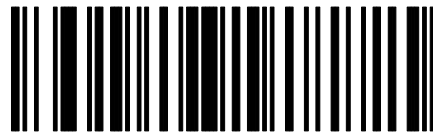

Skip Ahead 4 Characters



Skip Ahead 5 Characters

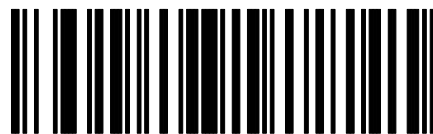

Skip Ahead 6 Characters

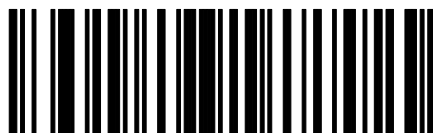

Skip Ahead 7 Characters

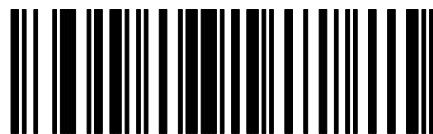

Skip Ahead 8 Characters

Actions – Skip Ahead / Back



Skip Ahead 9 Characters

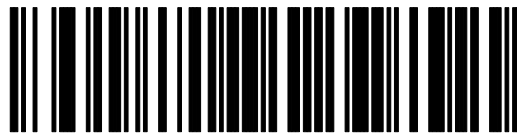

Skip Ahead 10 Characters

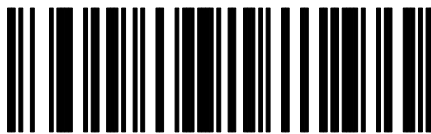

Skip Ahead 50 Characters

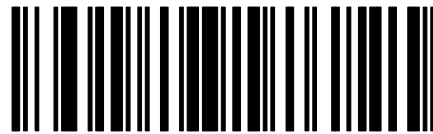

Skip Ahead 100 Characters



Skip Ahead 150 Characters

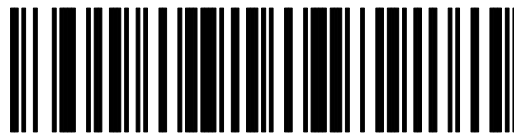

Skip Ahead 200 Characters

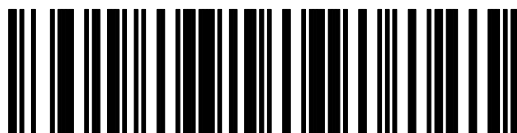

Skip Ahead 250 Characters

Actions – Skip Ahead / Back



Skip Back 1 Character

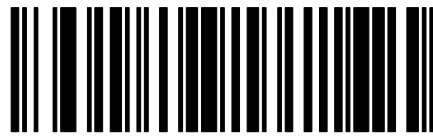

Skip Back 2 Characters



Skip Back 3 Characters

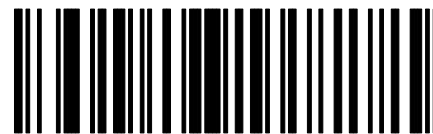

Skip Back 4 Characters

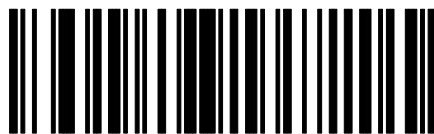

Skip Back 5 Characters

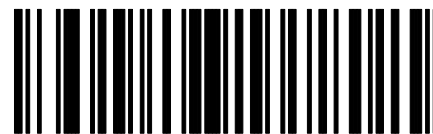

Skip Back 6 Characters



Skip Back 7 Characters



Skip Back 8 Characters

Actions – Skip Ahead / Back

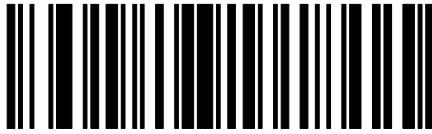

Skip Back 9 Characters

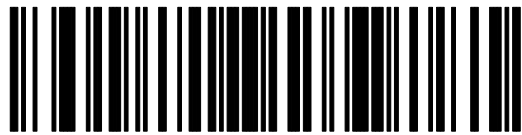

Skip Back 10 Characters

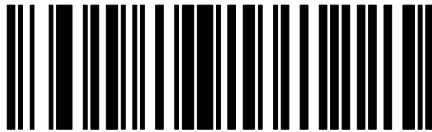

Skip Back 50 Characters

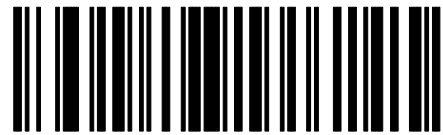

Skip Back 100 Characters



Skip Back 150 Characters

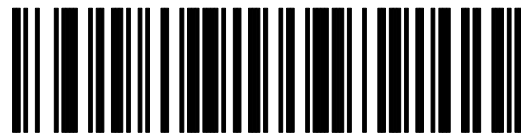

Skip Back 200 Characters



Skip Back 250 Characters



Skip to Start of Data

Actions – Spaces and Zeross



Remove All Spaces



Crunch All Spaces

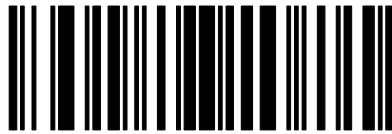

Stop Space Removal



Remove Leading Zeroes

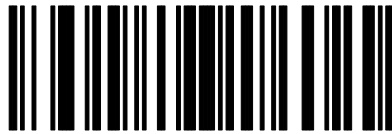

Stop Zero Removal

Actions – Send Value

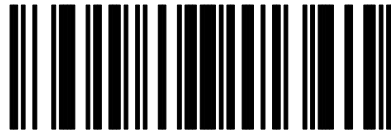

Send Value 1



Send Value 2

Actions – Beeps



Beep Once ①



Beep Twice ②



Beep Three Times ②

② Choose only one beep sequence per AFD Rule

Actions – Pad Spaces

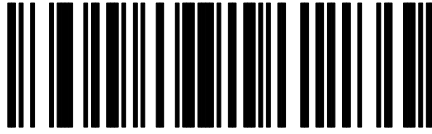

Pad Spaces to Length 1



Pad Spaces to Length 2

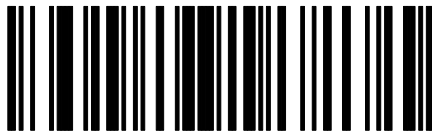

Pad Spaces to Length 3



Pad Spaces to Length 4

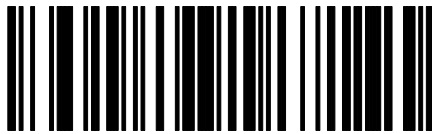

Pad Spaces to Length 5



Pad Spaces to Length 6



Pad Spaces to Length 7



Pad Spaces to Length 8

Actions – Pad Spaces



Pad Spaces to Length 9

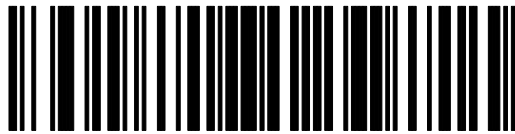

Pad Spaces to Length 10

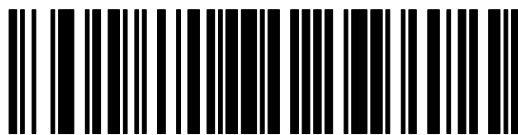

Pad Spaces to Length 11

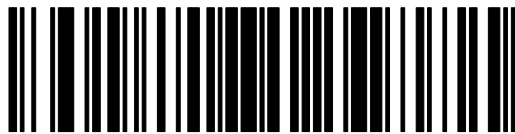

Pad Spaces to Length 12

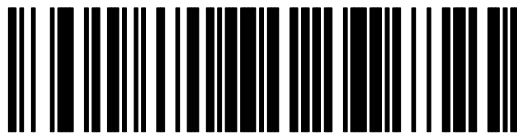

Pad Spaces to Length 13

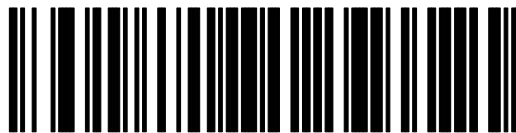

Pad Spaces to Length 14

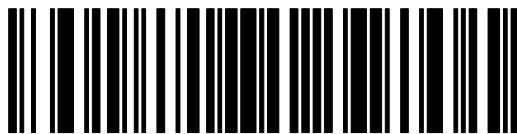

Pad Spaces to Length 15

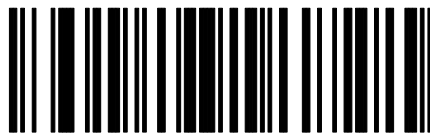

Pad Spaces to Length 16

Actions – Pad Spaces



Pad Spaces to Length 17



Pad Spaces to Length 18



Pad Spaces to Length 19

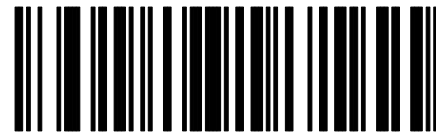

Pad Spaces to Length 20

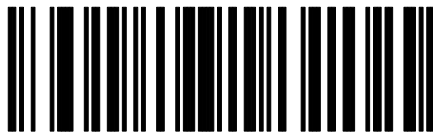

Pad Spaces to Length 21

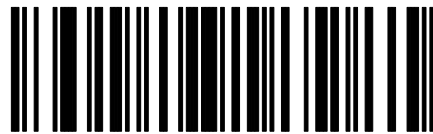

Pad Spaces to Length 22

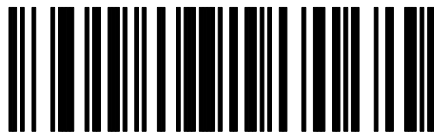

Pad Spaces to Length 23

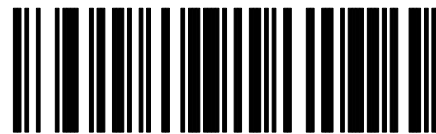

Pad Spaces to Length 24

Actions – Pad Spaces

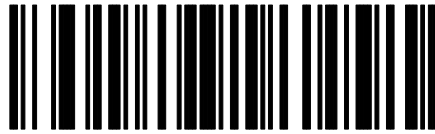

Pad Spaces to Length 25

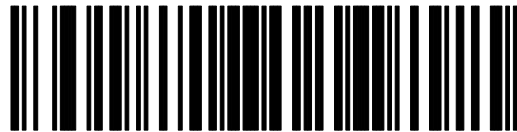

Pad Spaces to Length 26

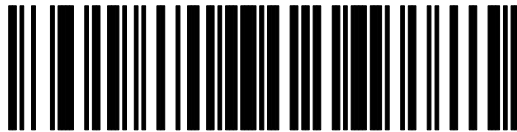

Pad Spaces to Length 27

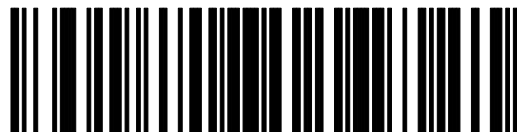

Pad Spaces to Length 28

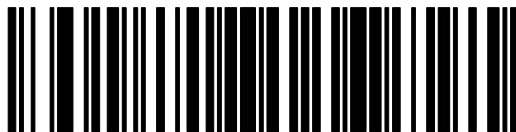

Pad Spaces to Length 29



Pad Spaces to Length 30



Stop Pad Spaces

Actions – Pad Zeros



Pad Zeros to Length 1



Pad Zeros to Length 2

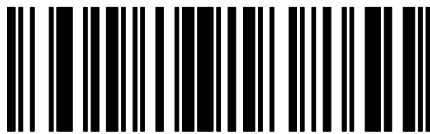

Pad Zeros to Length 3



Pad Zeros to Length 4

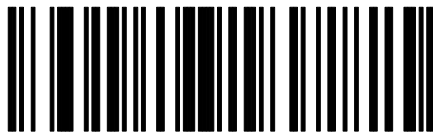

Pad Zeros to Length 5



Pad Spaces to Length 6



Pad Spaces to Length 7

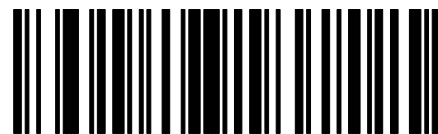

Pad Spaces to Length 8

Actions – Pad Zeros

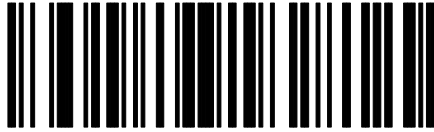

Pad Zeros to Length 9

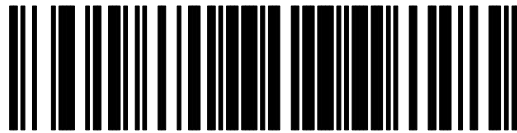

Pad Zeros to Length 10

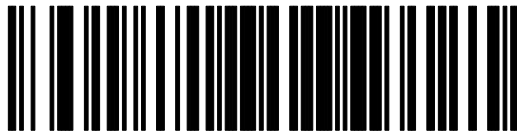

Pad Zeros to Length 11

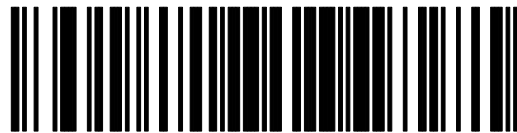

Pad Zeros to Length 12



Pad Zeros to Length 13

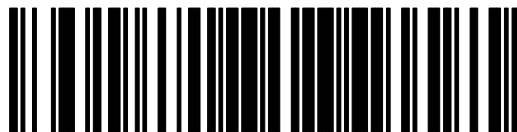

Pad Spaces to Length 14

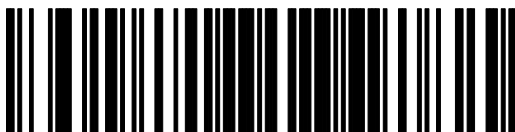

Pad Spaces to Length 15

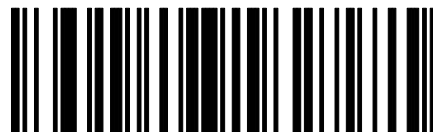

Pad Spaces to Length 16

Actions – Pad Zeros



Pad Zeros to Length 17



Pad Zeros to Length 18



Pad Zeros to Length 19

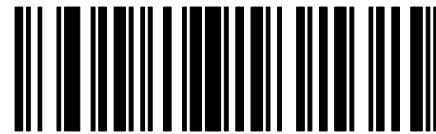

Pad Zeros to Length 20



Pad Zeros to Length 21

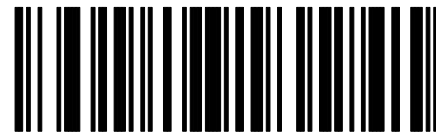

Pad Spaces to Length 22

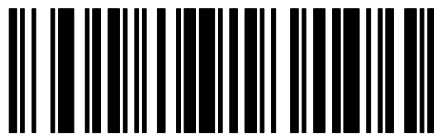

Pad Spaces to Length 23

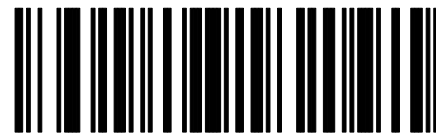

Pad Spaces to Length 24

Actions – Pad Zeros



Pad Zeros to Length 25

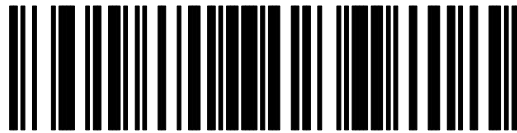

Pad Zeros to Length 26

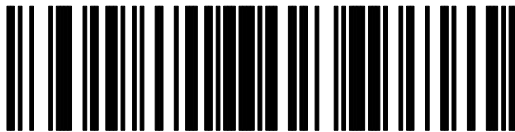

Pad Zeros to Length 27

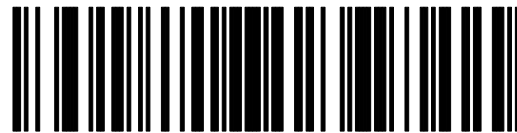

Pad Zeros to Length 28

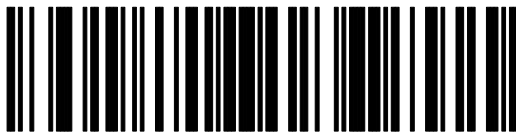

Pad Zeros to Length 29

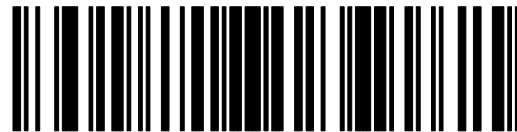

Pad Spaces to Length 30

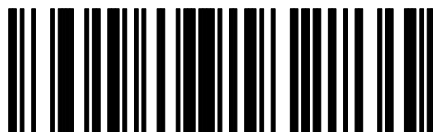

Stop Pad Zeros

Actions – Send Control Characters



Send Control 2



Send Control A



Send Control B



Send Control C



Send Control D



Send Control E



Send Control F



Send Control G

Actions – Send Control Characters



Send Control H



Send Control I

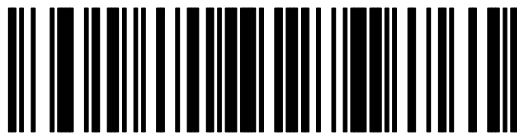

Send Control J

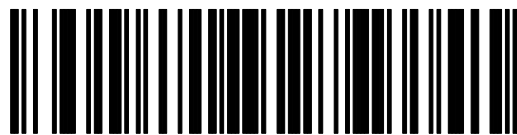

Send Control K

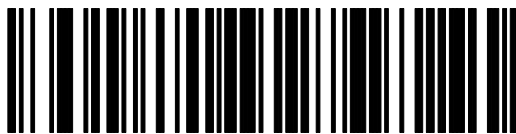

Send Control L

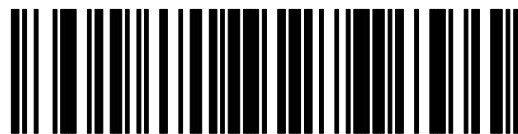

Send Control M

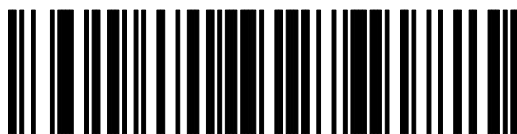

Send Control N



Send Control O

Actions – Send Control Characters

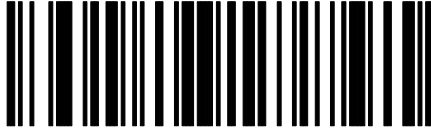

Send Control P



Send Control Q

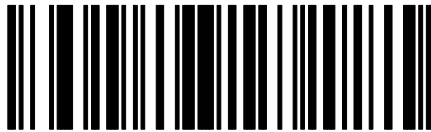

Send Control R



Send Control S



Send Control T

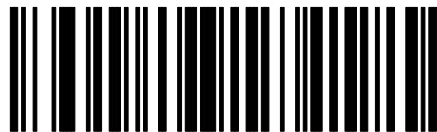

Send Control U



Send Control V

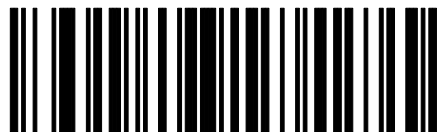

Send Control W

Actions – Send Control Characters

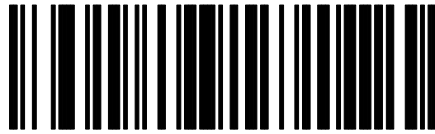

Send Control X

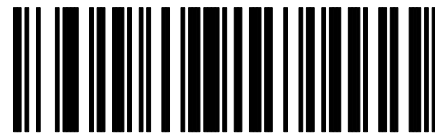

Send Control Y

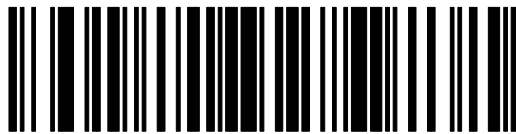

Send Control Z

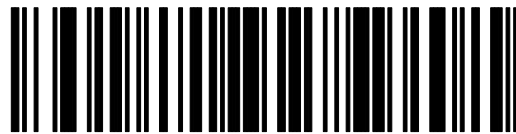

Send Control [

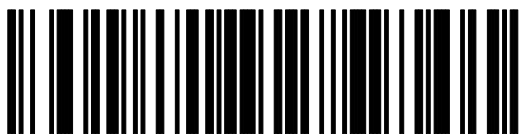

Send Control \

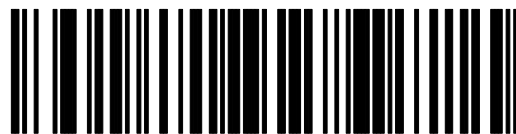

Send Control]

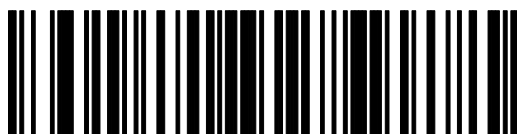

Send Control ^

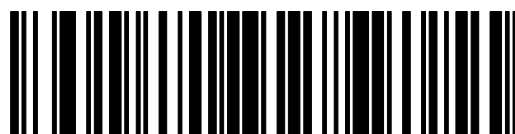

Send Control _

Actions – Send Keyboard Characters



Send Space



Send !



Send "



Send #



Send \$



Send %

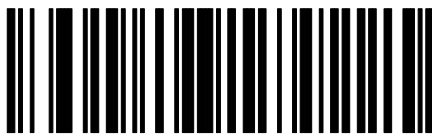

Send &



Send '

Actions – Keyboard Characters

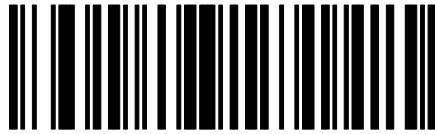

Send (



Send)

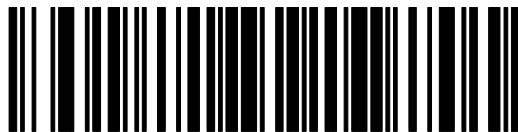

Send *

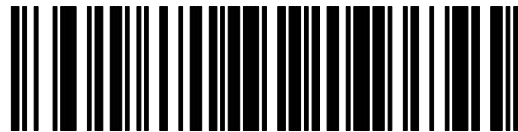

Send +

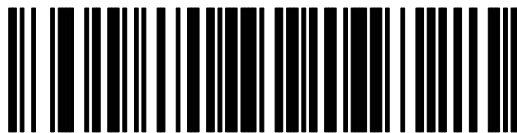

Send ,

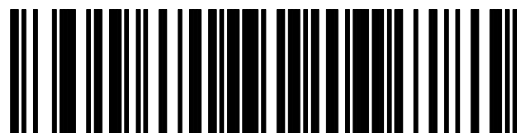

Send -

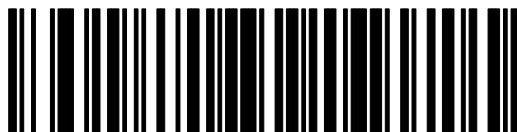

Send .



Send /

Actions – Send Keyboard Characters

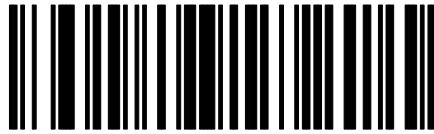

Send 0



Send 1

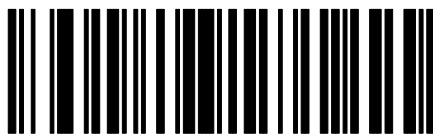

Send 2



Send 3



Send 4

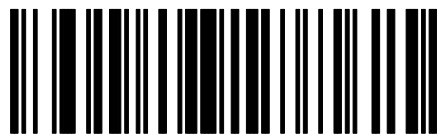

Send 5

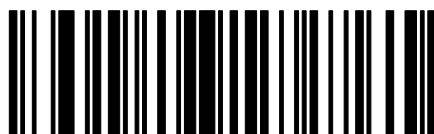

Send 6



Send 7

Actions – Send Keyboard Characters

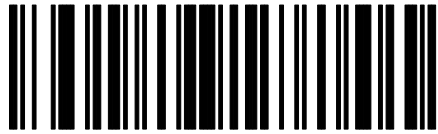

Send 8

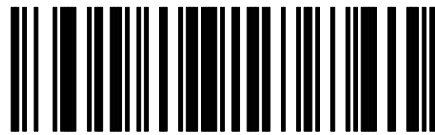

Send 9

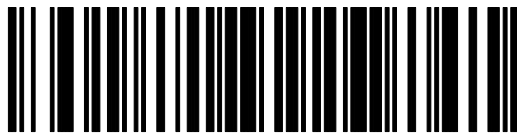

Send :

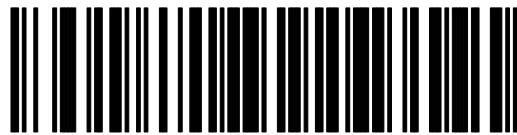

Send ;

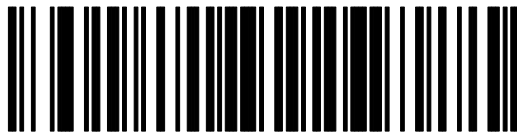

Send <

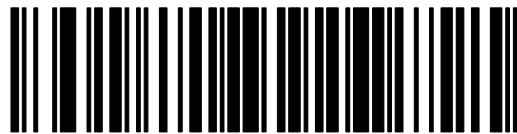

Send =

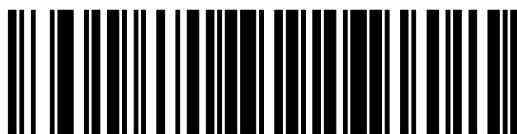

Send >

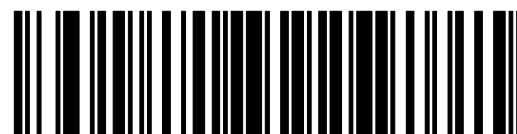

Send ?

Actions – Send Keyboard Characters



Send @



Send A



Send B

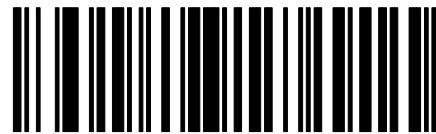

Send C

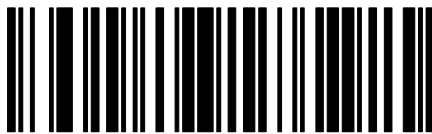

Send D



Send E



Send F

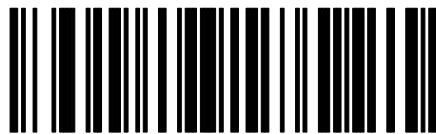

Send G

Actions – Send Keyboard Characters

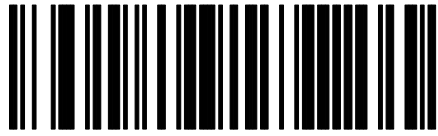

Send H



Send I

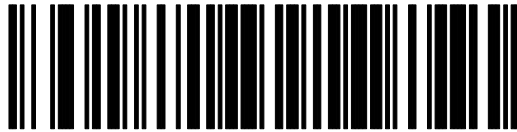

Send J

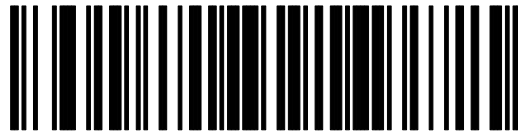

Send K

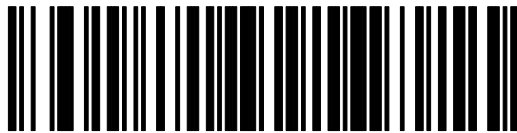

Send L

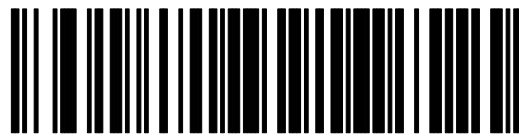

Send M

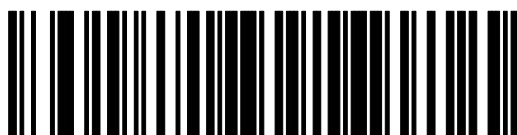

Send N

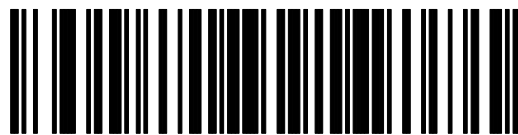

Send O

Actions – Send Keyboard Characters

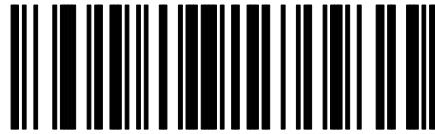

Send P



Send Q

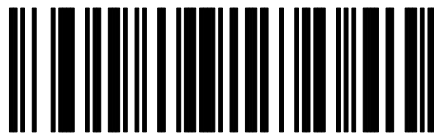

Send R



Send S

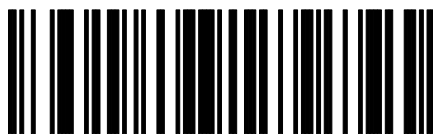

Send T

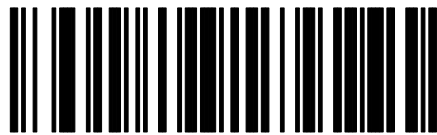

Send U



Send V



Send W

Actions – Send Keyboard Characters



Send X

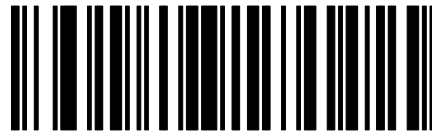

Send Y

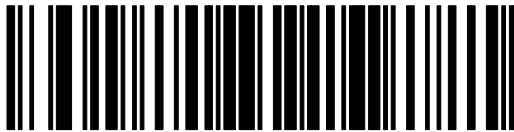

Send Z

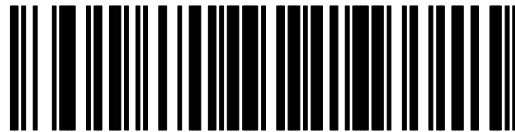

Send [

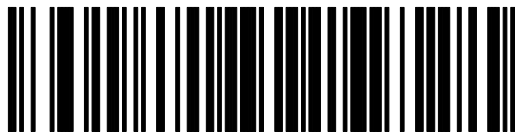

Send \

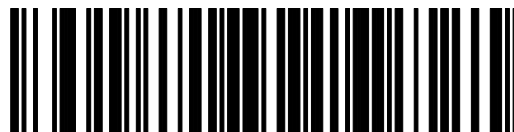

Send]

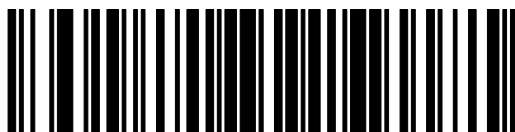

Send ^

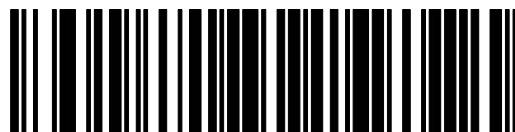

Send _

Actions – Send Keyboard Characters

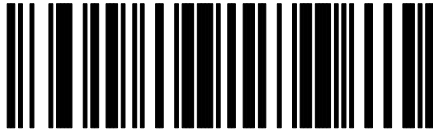

Send '



Send a



Send b



Send c



Send d



Send e



Send f

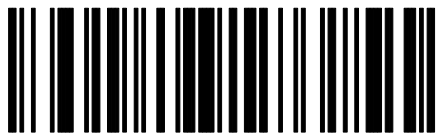

Send g

Actions – Send Keyboard Characters

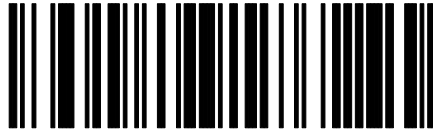

Send h



Send i

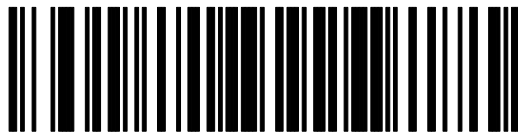

Send j

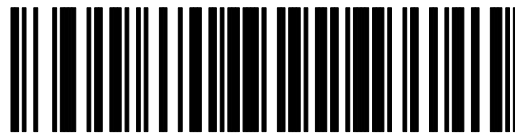

Send k

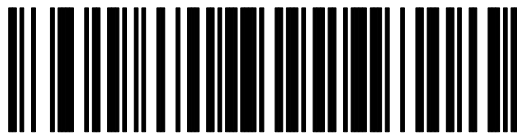

Send l

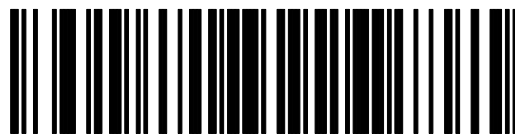

Send m

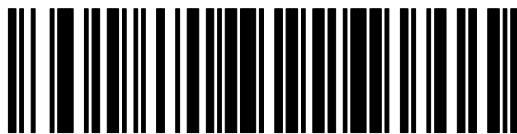

Send n

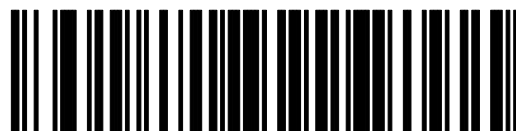

Send o

Actions – Send Keyboard Characters

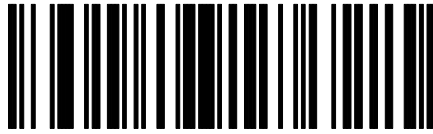

Send p



Send q

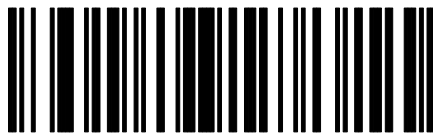

Send r



Send s

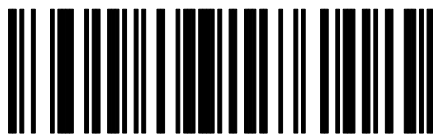

Send t

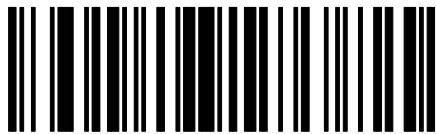

Send u

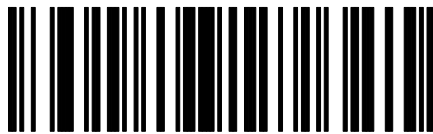

Send v

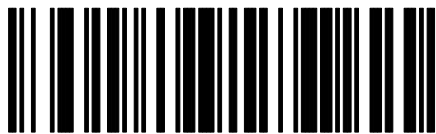

Send w

Actions – Send Keyboard Characters



Send x

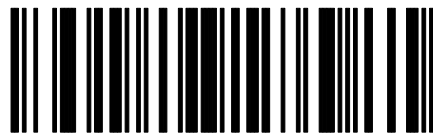

Send y

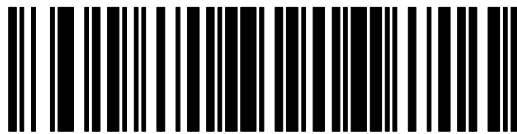

Send z

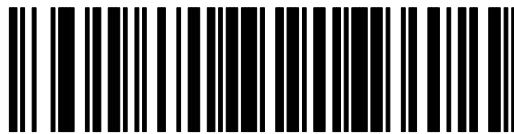

Send {

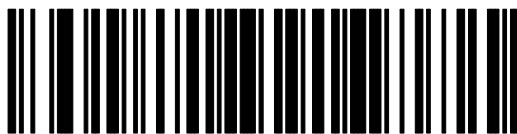

Send |

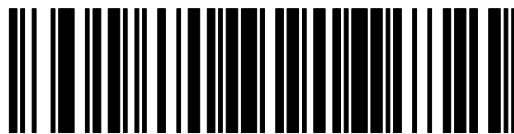

Send }

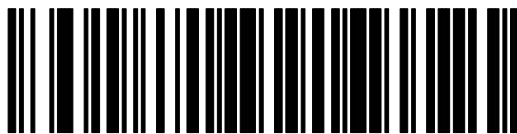

Send -

Actions – AlphaNumeric Keyboard

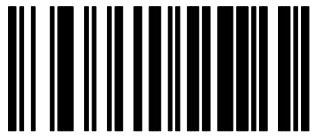

SPACE

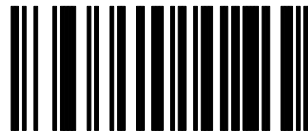

#

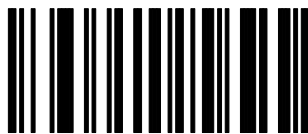

\$



%



*

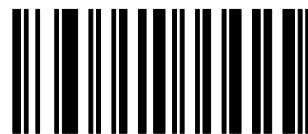

+

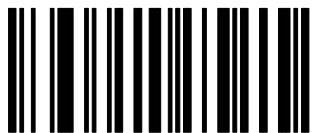

-



.

Actions – AlphaNumeric Keyboard

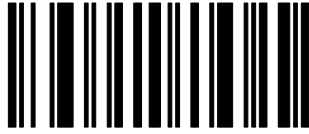

/

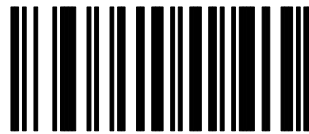

!

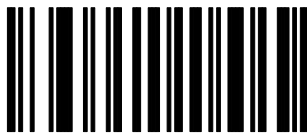

"

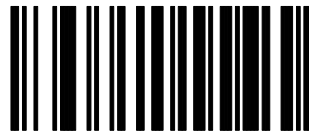

&

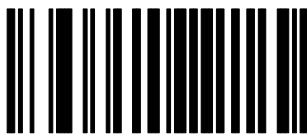

'

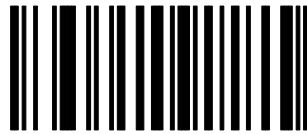

(

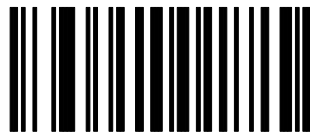

)

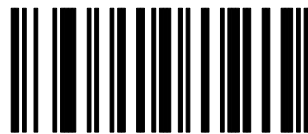

:

Actions – AlphaNumeric Keyboard



;



<



=



>



?

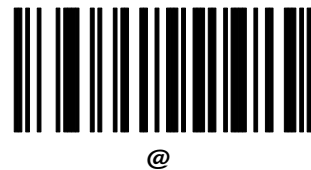

@



[



\

Actions – AlphaNumeric Keyboard



Actions – AlphaNumeric Keyboard

Do not confuse these bar codes with those on the numeric keypad.

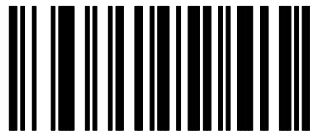

0

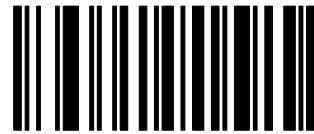

1

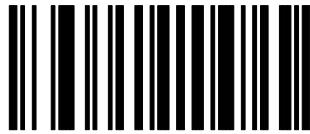

2

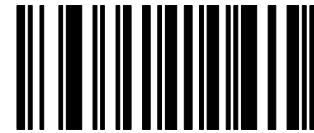

3

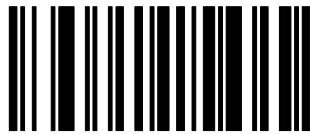

4

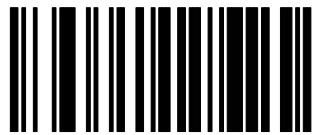

5

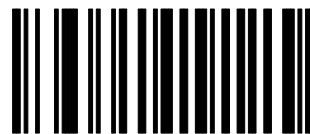

6

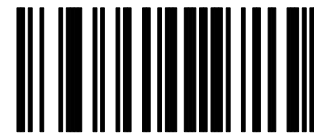

7

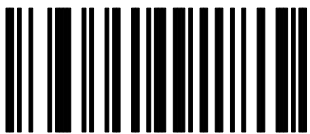

8



9

Actions – AlphaNumeric Keyboard

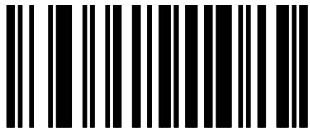

A

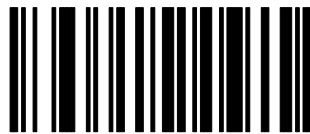

C

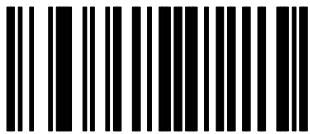

E

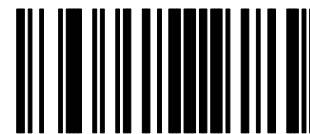

G



I



B

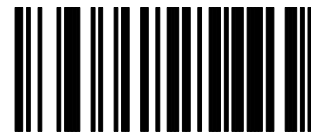

D



F

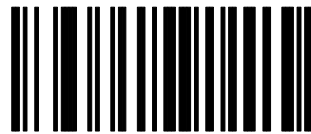

H



J

Actions – AlphaNumeric Keyboard



K

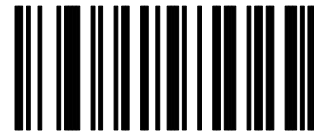

L



M

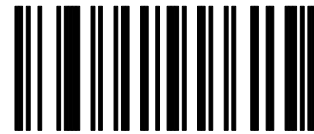

N

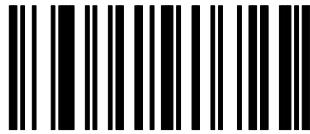

O



P

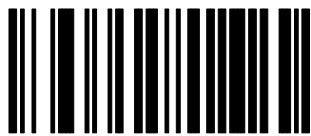

Q

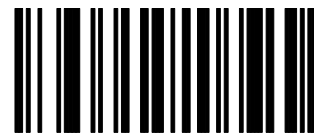

R

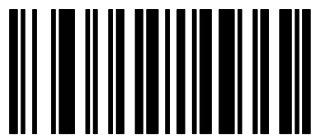

S

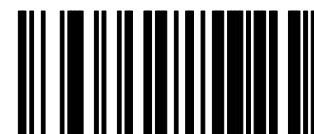

T

Actions – AlphaNumeric Keyboard

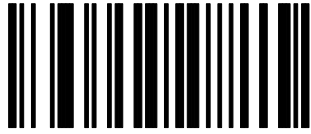

U

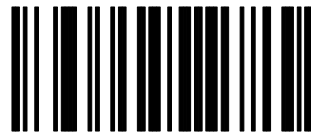

W

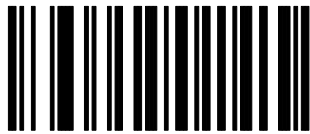

Y

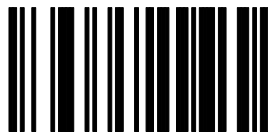

CANCEL

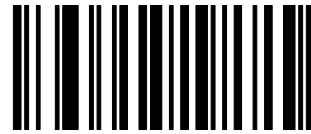

V



X



Z



END OF MESSAGE

Actions – AlphaNumeric Keyboard

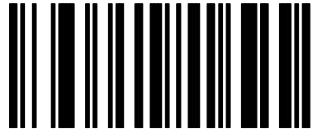

a

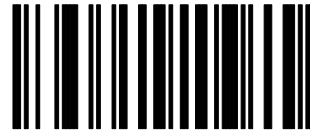

b

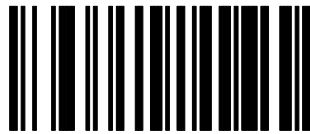

c

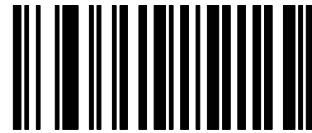

d

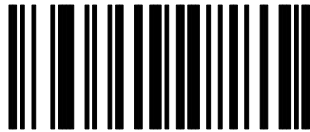

e



f

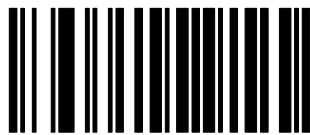

g



h



i



j

Actions – AlphaNumeric Keyboard

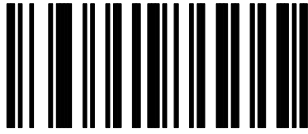

k

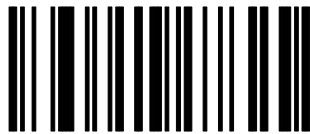

m

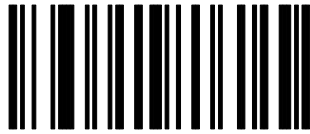

o

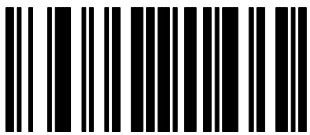

q

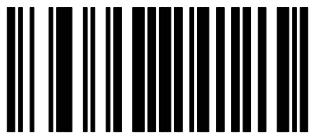

s

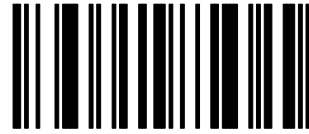

l

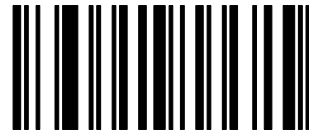

n

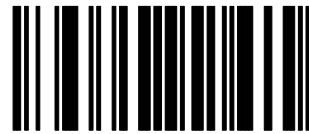

p

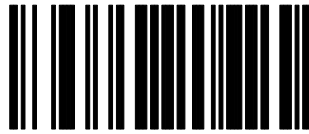

r

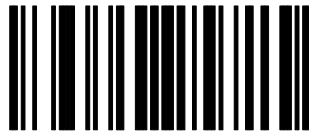

t

Actions – AlphaNumeric Keyboard

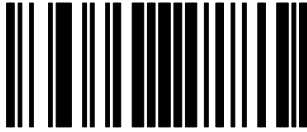

u

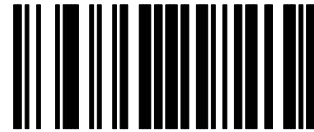

v

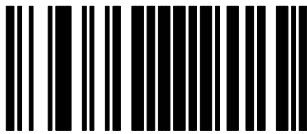

w

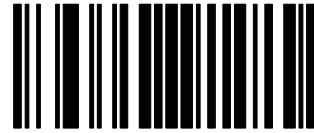

x

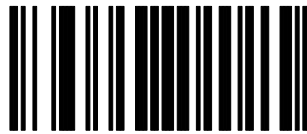

y

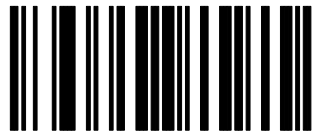

z

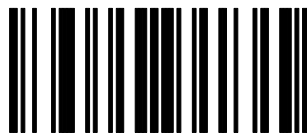

{

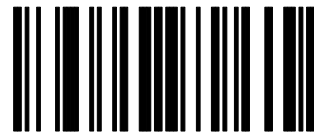

|

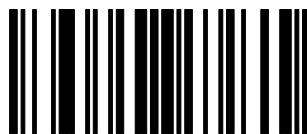

}



~

Actions – Turn of Rule Set



Turn on Rule Set 1

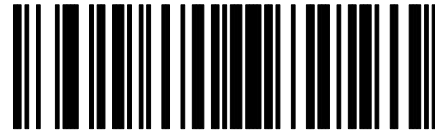

Turn on Rule Set 2

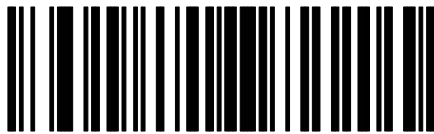

Turn on Rule Set 3

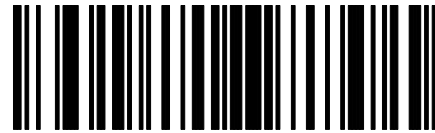

Turn on Rule Set 4

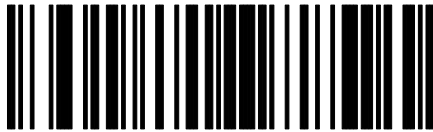

Turn off Rule Set 1



Turn off Rule Set 2

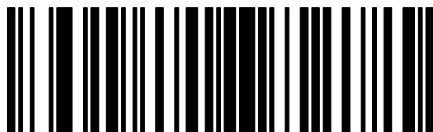

Turn off Rule Set 3



Turn off Rule Set 4

Enhanced Decoder Application

This appendix describes how to configure and operate the scanner when connected to an Allen-Bradley Enhanced Decoder (Catalog No. 2755-DD/DS).

- using the RS-232 port for output
- using the AUX port for Pass-Through

This section also provides configuration information for an Auxiliary Port Pass Through application for the enhanced decoder.



ATTENTION: Do not install the scanner emulation Synapse cable with power applied to either the Synapse cable or enhanced decoder. Failure to follow this caution may result in damage to the scanner, Synapse cable, or enhanced decoder.

For additional reference you should refer to the following publications:

- DS/DS Enhanced Decoder User Manual (Publication No. 2755-833)
- Gun Adapter Product Data Sheet (Publication No. 2755-2.37)

Enhanced Decoder Application using Scanner Port

Hardware Connections for Scanner Output

The scanner connects to an input port on the Enhanced Decoder with a Scanner Emulation Synapse cable (Catalog No. 2755-HFC-SA1-01) and Gun Adapter (Catalog No. 2755-NC16).

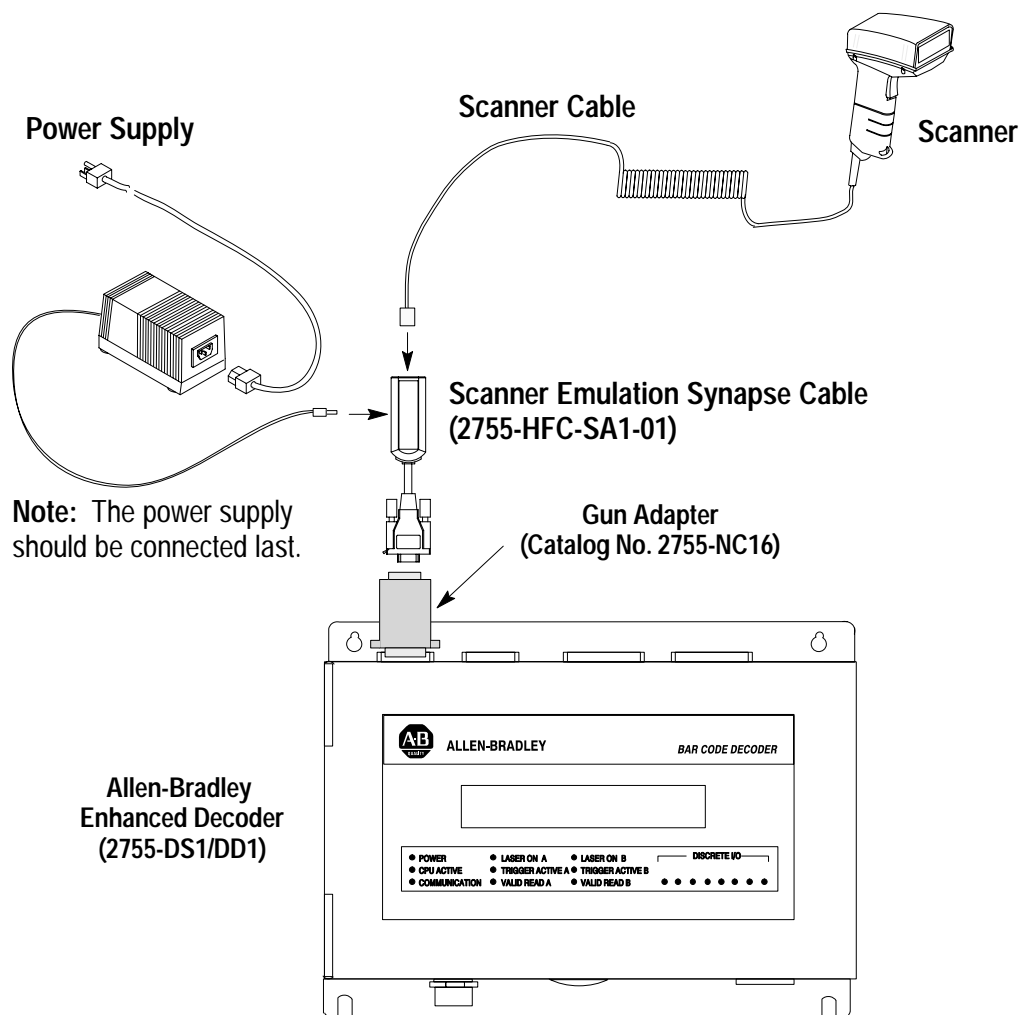

Scanner Configuration for Scanner Emulation Output

You will need to setup the scanner for operation with the cable and configure the cable as described on the next page.

Configuration Codes for Scanner Emulation Output

1. After making the necessary connections, scan the following following bar code symbol to set the scanner to its default settings.

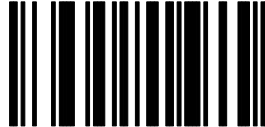

Set Scanner Defaults

2. Set the scanner emulation cable to defaults by scanning the following:

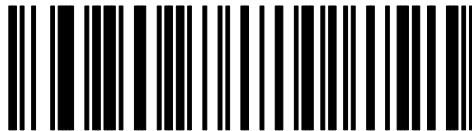

Set Scanner Cable Defaults

3. The Scanner Emulation Synapse cable defaults will work with the enhanced decoder. Your application may have specific requirements. Chapter 7 lists the settings that can be modified.

Enhanced Decoder Setup for Scanner Input

You will need to configure the Allen-Bradley Enhanced decoder.
Refer to the Enhanced Decoder user manual (Publication 2755-833).

- 1. Set Response Mode = Valid Package**
- 2. Set Package Detect Input Filter = Yes; Sense = Lo = Package**
- 3. Set Laser On Mode = Triggered**
- 4. Set Decode Trigger = Package Detect**
- 5. No Read Timer \cong 8000 ms**

Enhanced Decoder Application using AUX Port for Pass Through

Hardware Connections for AUX Port Pass-Through

The scanner connects to an input port on the Enhanced Decoder with a 25-pin RS-232 Synapse cable (Catalog No. 2755-HFC-SR2-01) and a null modem adapter.

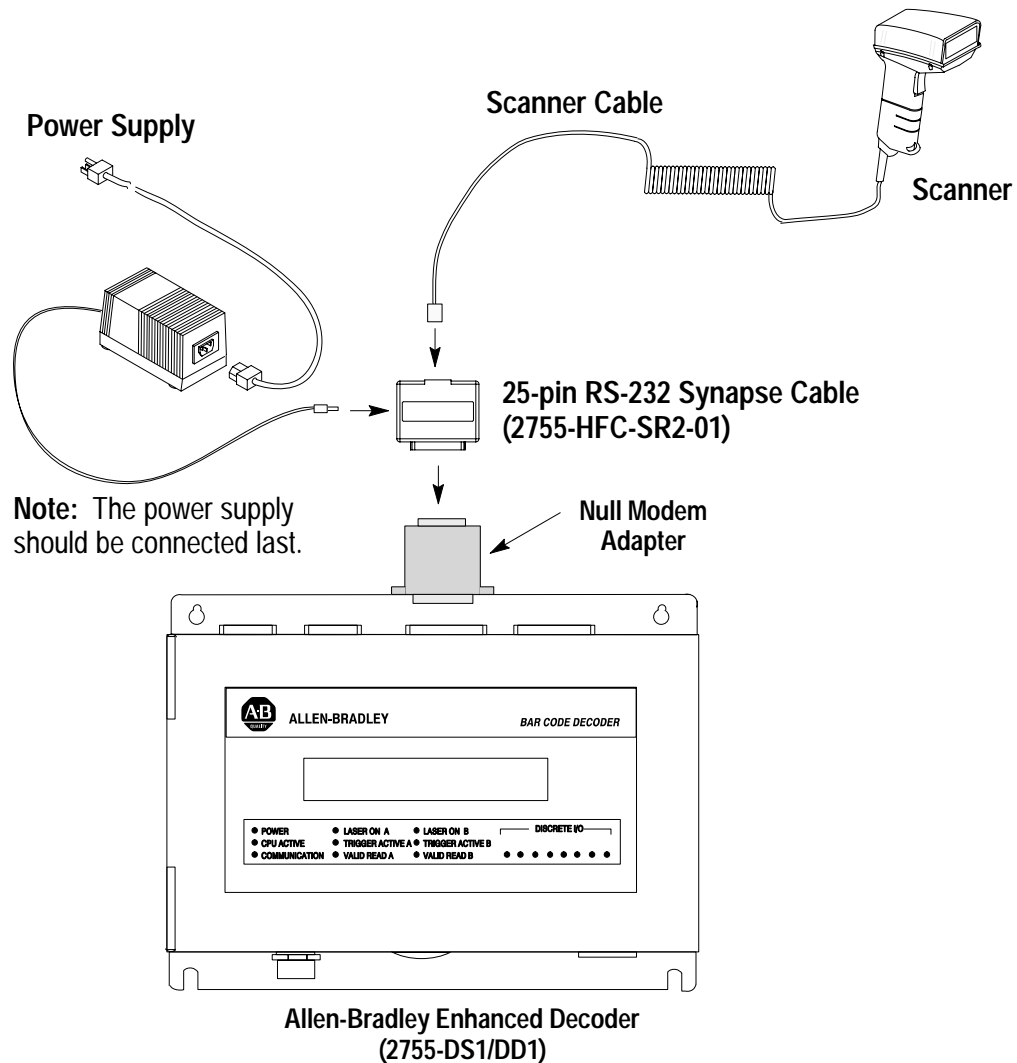

Scanner Configuration for AUX Port Pass-Through

You will need to setup the scanner for operation with the cable and configure the cable as described on the next page.

Configuration Codes for AUX Port Pass Through

1. After making the necessary connections, scan the following following bar code symbol to set the scanner to its default settings.



Set Scanner Defaults

2. Set the RS-232 Synapse cable to defaults by scanning the following:



Set RS-232 Synapse Cable Defaults

3. Set No Parity.

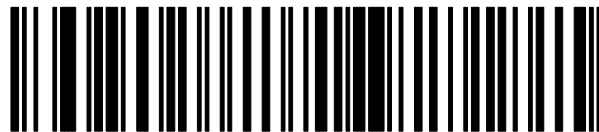

Do Not Check Parity

Enhanced Decoder Setup for AUX Port Pass Through

You will need to configure the Allen-Bradley Enhanced decoder. Refer to the Enhanced Decoder user manual (Publication 2755-833).

- 1.** Select Aux Terminal Data Entry (Screen 8) from the Main Menu.
- 2.** Set Enable Keyboard Entry = **Yes**
- 3.** Save and Exit the configuration.
- 4.** Move internal selector (jumper) to the data entry position on the system board (B-5, B-6).
- 5.** Make sure the hand-held scanner baud rate = **9600**, parity = **None**, data bits = **8**, and stop bits = **1**.
- 6.** See Chapter 13 of Enhanced Decoder user manual (Publication 2755-833) for additional information.

Flexible Interface Module Application

This appendix describes how to configure and operate the scanner when connected to a Flexible Interface Module (Catalog No. 2760-RB).



ATTENTION: Do not install the RS-232 Synapse cable with power applied to either the Synapse cable or Flexible Interface Module. Failure to follow this caution may result in damage to the scanner, Synapse cable, or Flexible Interface Module.

For additional reference you should refer to the following publications:

- Flexible Interface Module User Manual (Publication No. 2760-ND001)
- SFC1 or SFC2 Protocol Cartridge User Manuals (Publication No. 2760-ND002 and 2760-822)

Hardware Connections

The scanner connects to one of the three communication ports on the Flexible Interface Module with an RS-232 Synapse cable (Catalog No. 2755-HFC-SR2-01). The interface module requires an SFC2 Protocol Cartridge.

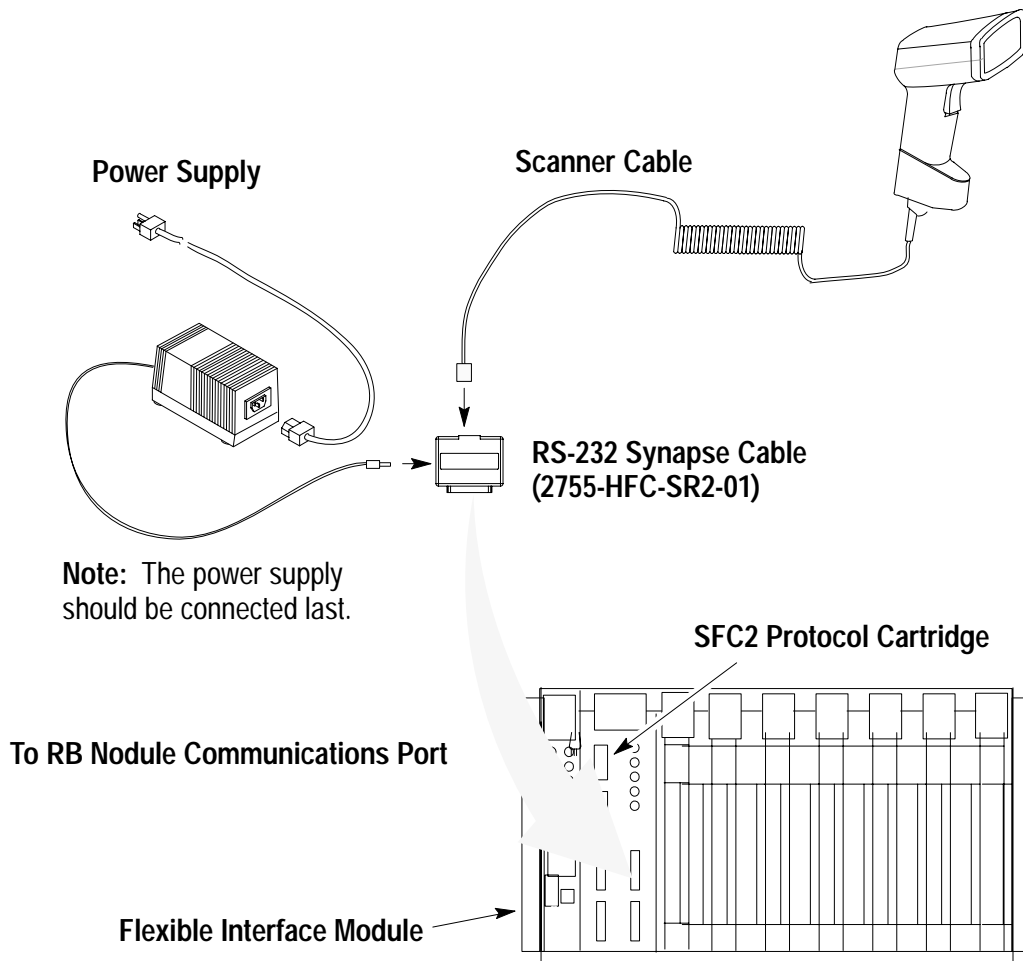

Scanner Configuration

Configure the scanner using the bar codes described in Chapter 1. The Flexible Interface Module does not require any specific scanner configuration. However, you will need to configure the cable communication parameters as described on the next page.

Configuration Codes for Flexible Interface Module Application

1. After making the necessary connections, scan the following following bar code symbol to set the scanner to its default settings.

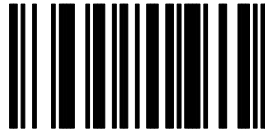

Set Scanner Defaults

2. Set the RS-232 Synapse cable to defaults by scanning the following:



Set RS-232 Synapse Cable Defaults

3. The cable defaults will work with the Flexible Interface Module. Your application may have specific requirements. Chapter 3 lists the settings that can be modified. If you change a communication setting, make sure the Flexible Interface Module is configured to accept the change.

Flexible Interface Module Setup

You will need to configure the Flexible Interface Module. Refer to the user manual for the protocol cartridge and interface module.

- 1.** When configuring the Flexible Interface Module, first select 90B to reset the configuration to factory defaults.
- 2.** Configure screens 3, 21, and 11 (in this order) as shown on the following pages:

2760-RB SERIES A REVISION J
COPYRIGHT 1989 ALLEN-BRADLEY COMPANY, INC.

| | |
|----------------------------------|-----------------------------------|
| 1X - CONFIGURATION PARAMETERS | 2X - IDENTIFICATION NUMBERS |
| 3 - DEVICE PORT PROTOCOL NAMES | 4DM - MATCH CODE ENTRIES |
| 5I - DISCRETE BYTE INPUT ENTRIES | 6 - THE DATA MATRIX ENTRIES |
| 7 - THE PASS THROUGH ENTRIES | 8 - NON-VOLATILE SCRATCH PAD AREA |
| 9XF - RB MODULE FUNCTIONS | AX - HARDWARE DIAGNOSTICS |
| BX - SOFTWARE DIAGNOSTICS | C - EXIT CONFIGURATION MODE |

WHERE X (0 TO 7) AND D (1 TO 3) ARE PORT NUMBERS WHICH ARE DEFINED BELOW :

0 - RB CMMND PRCSS 2 - SERIAL PORT 2 4 - CONFIG PORT 6 - I/O RACK SLT 1
1 - SERIAL PORT 1 3 - SERIAL PORT 3 5 - I/O RACK SLT 0 7 - RESERVED

WHERE F (A TO E) ARE FUNCTIONS THAT RB CAN PERFORM WHICH ARE DEFINED BELOW :

A - RESET B - SET DEFAULTS C - FLUSH D - INITIALIZE E - CLEAR DIAGS

WHERE M (A TO T) AND I (A TO H) ARE ENTRY NUMBERS FOR THE SELECTION MADE ABOVE.

ENTER A MAIN MENU SELECTION:

ENTER A MAIN MENU SELECTION: 3

PORT 1 = COPYRIGHT 1989 ALLEN-BRADLEY COMPANY, INC.
2760-SFC1 DT , SERIES A , REVISION B (YES/NO) = YES.

PORT 2 = COPYRIGHT 1989 ALLEN-BRADLEY COMPANY, INC.
2760-SFC1 DT , SERIES A , REVISION B (YES/NO) = YES.

PORT 3 = COPYRIGHT 1989 ALLEN-BRADLEY COMPANY, INC.
2760-SFC1 DT , SERIES A , REVISION B (YES/NO) = YES.

EDIT THIS SELECTION (YES/NO) ?

ENTER A MAIN MENU SELECTION: 21

DUMB TERM. UNSPECIFIED PROTOCOL, 13fh (YES/NO) = YES.

EDIT THIS SELECTION (YES/NO) ?

ENTER A MAIN MENU SELECTION: 11

MODEM CONTROL (ENABLE/DISABLE) = DISABLE.

9600 BITS PER SECOND (YES/NO) = YES.

8 BITS NO PARITY (YES/NO) = YES.

XON/XOFF (ENABLE/DISABLE) = DISABLE.

RS232 (YES/NO) = YES.

RECEIVE MATRIXING (ENABLE/DISABLE) = DISABLE.

BYTE SWAPPING (ENABLE/DISABLE) = ENABLE.

BINARY DATA NO CONVERSIONS (YES/NO) = YES.

HDR/TLR ON OUTPUT (ENABLE/DISABLE) = ENABLE.

HEADER BYTE LENGTH (DEC 0...4) = 0.

HEADER DATA[0] (HEX 0...ff) = 0.

HEADER DATA[1] (HEX 0...ff) = 0.

HEADER DATA[2] (HEX 0...ff) = 0.

HEADER DATA[3] (HEX 0...ff) = 0.

TRAILER BYTE LENGTH (DEC 0...4) = 2.

TRAILER DATA[0] (HEX 0...ff) = a.

TRAILER DATA[1] (HEX 0...ff) = d.

TRAILER DATA[2] (HEX 0...ff) = 0.

TRAILER DATA[3] (HEX 0...ff) = 0.

MAX DATA BYTE LENGTH (DEC 0...124) = 0.

MIN DATA BYTE LENGTH (DEC 0...124) = 0.

CONTINUE THIS SELECTION (YES/NO) ?

3. Make sure PLC program is written to access Flexible Interface Module data.

SLC 5/03, 5/04 Controller Application

This appendix describes how to configure and operate the scanner when connected to an SLC 5/03, 5/04 controller.



ATTENTION: Do not install the RS-232 Synapse cable with power applied to either the Synapse cable or SLC controller. Failure to follow this caution may result in damage to the scanner, Synapse cable, or SLC.

For additional reference you should refer to the following publications:

- Advanced Programming Software (APS) User Manual
- Advanced Programming Software (APS) Reference Manual

Hardware Connections

The scanner connects to the Channel 0 port of the SLC with an RS-232 Synapse cable (Catalog No. 2755-HFC-SR2-01).

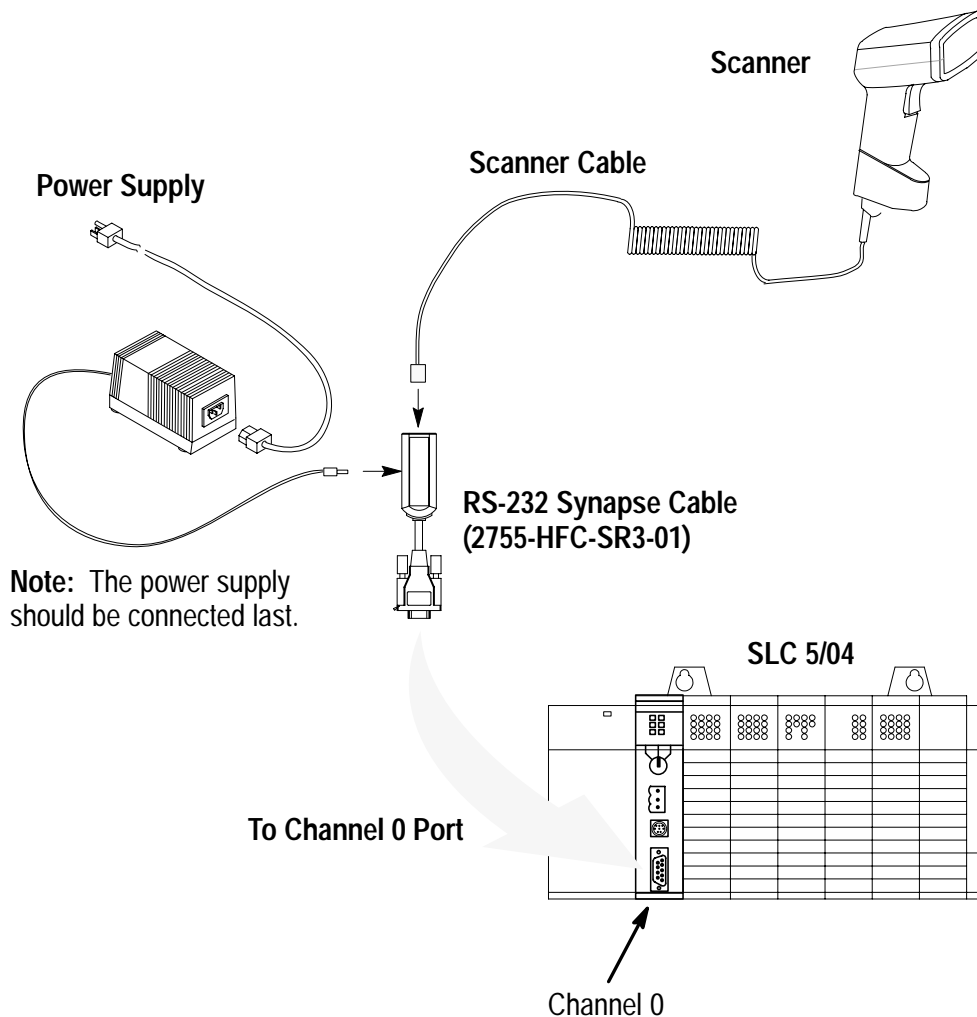

Scanner Configuration

Configure the scanner using the bar codes described in Chapter 1. The SLC controller does not require any specific scanner configuration. However, you will need to configure the cable communication parameters as described on the next page.

Configuration Codes for SLC Application

1. After making the necessary connections, scan this symbol to set the scanner to its default settings.

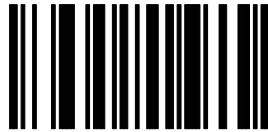

Set Scanner Defaults

2. Set the bar code suffix to CR LF (ASCII equivalent 7013) by scanning the following labels.

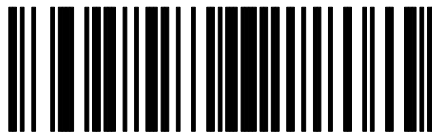

Suffix



7

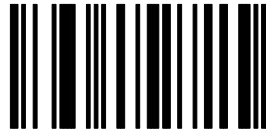

0

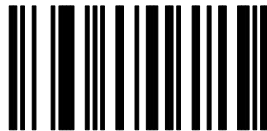

1

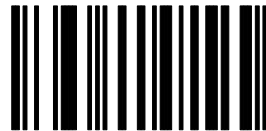

3

3. Send the data then the suffix by scanning these labels.

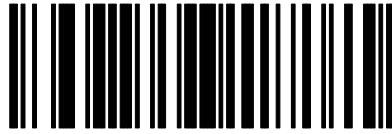

Scan this Symbol First

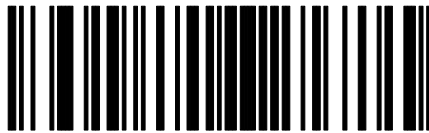

Send <Data> <Suffix>

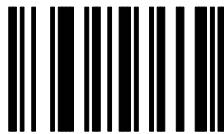

Scan Enter after Scanning Option

4. Set the RS-232 Synapse cable to defaults by scanning the following:

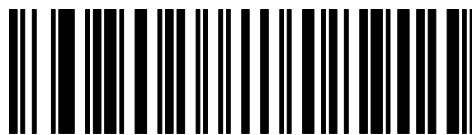

Set RS-232 Synapse Cable Defaults

5. The cable defaults will work with the SLC 5/03, 5/04. Your application may have specific requirements. Chapter 3 lists the settings that can be modified. If you change a communication setting, make sure the SLC controller is configured to accept the change.

SLC 5/03, 5/04 Setup

You will need to configure the SLC, refer to the user manuals and following instructions:

1. Set the SLC Channel 0 to **User** in the Channel 0 Configuration screen

```

CHANNEL CONFIGURATION
CHANNEL 0 CONFIGURATION
  Current Communication Mode: USER
  System Mode Driver: SHUTDOWN
  User Mode Driver: GENERIC ASCII
  Write Protect: DISABLED
  Mode Changes: DISABLED
  Mode Attention Character: \1b
  System Mode Character: S
  User Mode Character: U
  Edit Resource/File Owner Timeout: 60 (seconds)
  Passthru Link ID: 1 (decimal)
CHANNEL 1 CONFIGURATION
  System Mode Driver: DH-485 MASTER
  Write Protect: DISABLED
  Edit Resource/File Owner Timeout: 60 (seconds)
  Passthru Link ID: 2 (decimal)

```

Press a function key

| | | | | | |
|---------|-----------|-------------|---------|---------|-------------|
| offline | no forces | EDITS: NONE | | | File ADAPTA |
| ACCEPT | UNDO | CH0 SYS | CH0 USR | CH1 SYS | SELECT |
| EDITS | EDITS | CONFIG | CONFIG | CONFIG | OPTION |
| F1 | F2 | F4 | F5 | F7 | F10 |

2. Configure Channel 0 in the Channel 0 User Mode Configuration screen.

```

CHANNEL 0 USER MODE CONFIGURATION

Communication Driver:    GENERIC ASCII
Diagnostic File:        Reserved

Baud Rate:              9600          Parity:                    NONE
Stop Bits:              1             Data Bits:                 8
Delete Mode:            IGNORE        RTS Off Delay [x20 ms]:    0
Echo:                   DISABLED      RTS Send Delay [x20 ms]:  0

Control Line: NO HANDSHAKING          XON/XOFF:                  DISABLED

Termination 1:          \a            Append 1:                  \f
Termination 2:          \d            Append 2:                  \f

Press a function key

offline      no forces      EDITS: NONE      File ADAPTA
ACCEPT      UNDO           CHANSEL SELECT
EDITS      EDITS           STATUS  OPTION
F1         F2              F9     F10
  
```

Note that Termination 1 is set for **\a** or Line Feed [**LF**], and Termination 2 is set for **\d** or Carriage Return [**CR**]. These terminators, along with the **ARL** instruction in the SLC, allow you to read one message at a time with [**CR**] [**LF**] terminators.

SLC Program

The sample ladder logic listing below instructs the SLC 5/03 or 5/04 to:

Rung 2:0 – Read one string of ASCII data terminated with a **[CR] [LF]**.

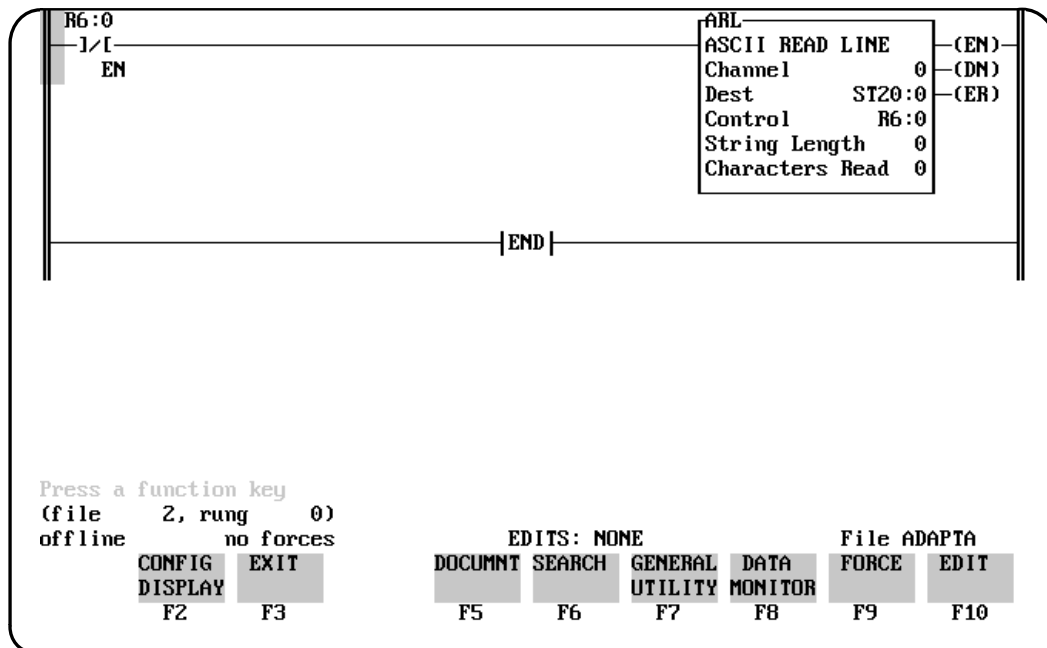

Refer to the SLC 5/03 user manual for detailed information on using the SLC 5/03 or 5/04 programming software.

PLC-5 Controller Application

This appendix describes how to configure and operate the scanner when connected to a PLC-5 controller.



ATTENTION: Do not install the RS-232 Synapse cable with power applied to either the Synapse cable or PLC controller. Failure to follow this caution may result in damage to the scanner, Synapse cable, or PLC.

For additional reference you should refer to the following publications:

- PLC-5 User Manual
- 6200 Series Programming Software User Manual

Hardware Connections

The scanner connects to the Channel 0 port of the PLC with an RS-232 Synapse cable (Catalog No. 2755-HFC-SR2-01). The connections are shown in the scanner user manual (Publication 2755-6.2).

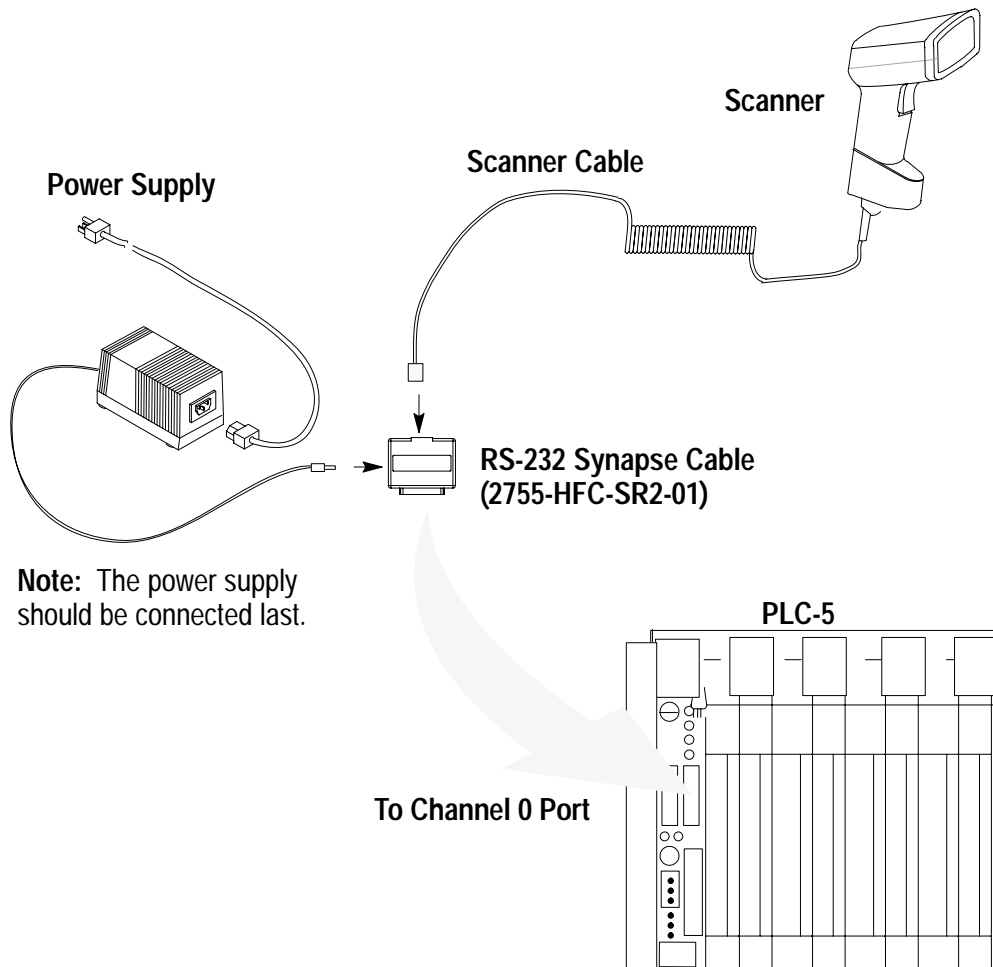

Scanner Configuration

Configure the scanner using the bar codes described in Chapter 1. The PLC controller does not require any specific scanner configuration. However, you will need to configure the cable communication parameters as described on the next page.

Configuration Codes for PLC Application

1. After making the necessary connections, scan the following following bar code symbol to set the scanner to its default settings.

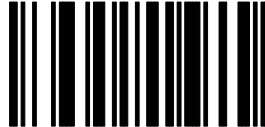

Set Scanner Defaults

2. Set the RS-232 Synapse cable to defaults by scanning this label.



Set RS-232 Synapse Cable Defaults

3. Set the bar code suffix to CR LF (ASCII equivalent 7013) by scanning the following labels.

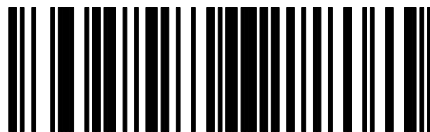

Suffix



7



0



1



3

4. Send the data then the suffix by scanning these labels.

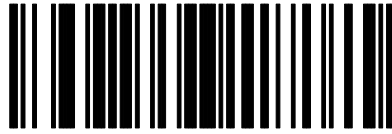

Scan this Symbol First

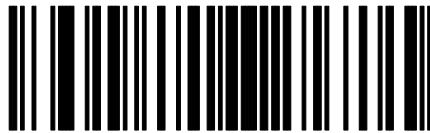

Send <Data> <Suffix>

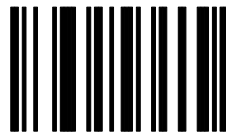

Scan Enter after Scanning Option

5. The cable defaults will work with the PLC-5. Your application may have specific requirements. Chapter 3 lists the settings that can be modified. If you change a communication setting, make sure the PLC controller is configured to accept the change.

PLC-5 Setup

You will need to configure the Channel 0 port of the PLC-5. Refer to the 6200 Series Programming Software user manual and the following instructions.

1. Set the PLC-5 Channel 0 to **User** in the Channel 0 Configuration screen.

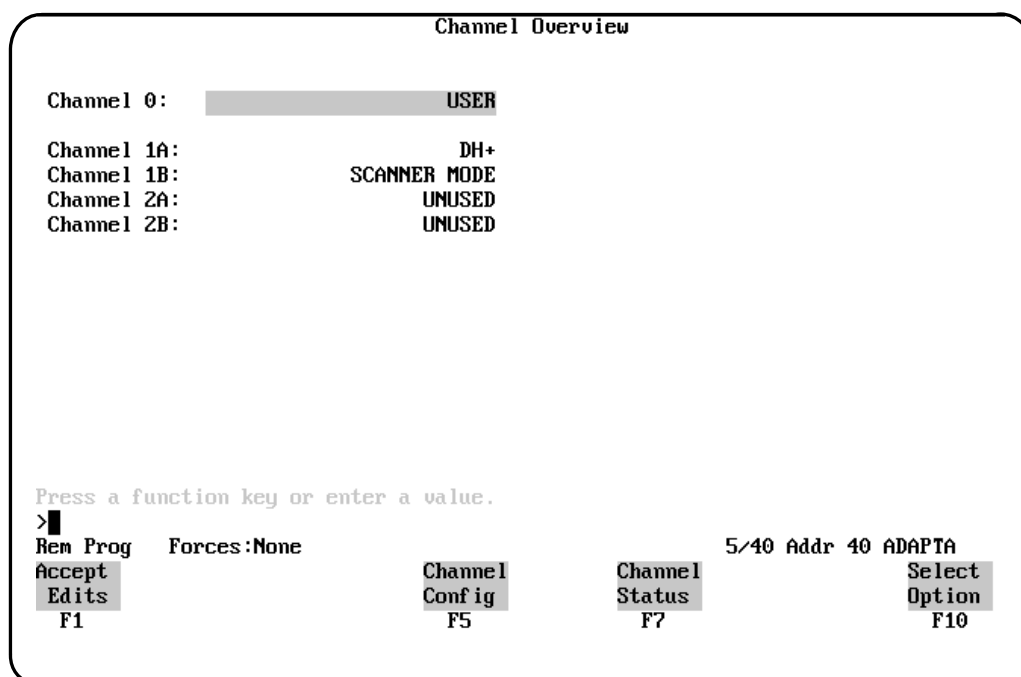

2. Configure Channel 0 in the User Mode Channel 0 Configuration screen.

```

User Mode
Channel 0 Configuration

Diag. file:      N21      XON/XOFF:      DISABLED
Remote mode change: DISABLED
Mode attention char.: \0x1b
System mode char.: S
User mode char.:  U

Baud rate:      9600      Parity:         NONE
Stop bits:      1        Bits per character: 8
Control line: NO HANDSHAKING

Echo/delete mode: DISABLED
RTS send delay (20 ms): 0
RTS off delay (20 ms): 0

Termination 1:  \0xd      Append 1:      \0xf
Termination 2:  \0xa      Append 2:      \0xf

Press a function key or enter a value.
>
Rem Prog      Forces:None      5/40 File ADAPTA
Accept      Chan 0 Select
Edits      Status Option
F1          F9      F10

```

Note that Termination 1 is set for `\0xa` or Line Feed [LF], and Termination 2 is set for `\0xd` or Carriage Return [CR]. These terminators, along with the **ARL** instruction in the PLC-5, allow you to read one message at a time with [CR] [LF] terminators.

PLC Program

The sample ladder logic listing below instructs the PLC-5 to:

Rung 2:0 – Read one string of ASCII data terminated with a **[CR] [LF]**.

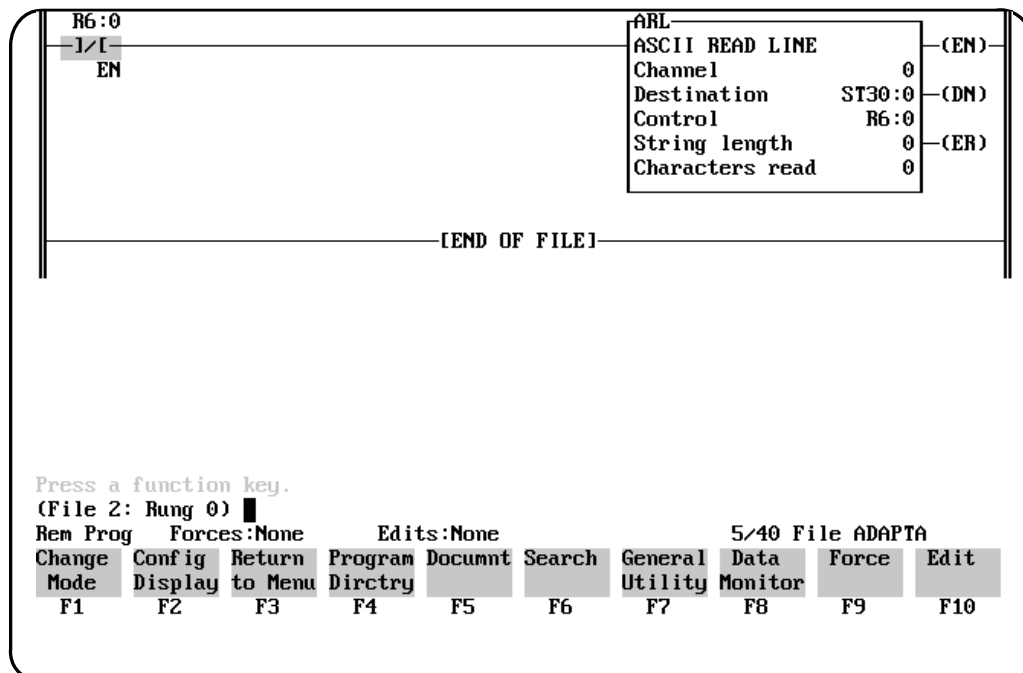

Refer to the PLC-5 user manual for detailed information on using the PLC programming software.

DTAM™ Plus DeviceNet™ Application

This appendix describes how to configure and operate the scanner when connected to a DTAM Plus Operator Interface on a DeviceNet network.

Related Publications

Below is a list of related publications you may need to refer to when using the DTAM Plus Operator Interface.

| Publication No. | Title |
|------------------------|--|
| 2707-800 | DTAM Plus Operator Interface Module User Manual |
| 2707-800.5 | DTAM Plus DeviceNet Operator Interface Document Update |
| 2707-801 | DTAM Programming Software Programming Manual |
| 2707-802 | Getting Started with DTAM Plus User Manual |

Hardware Connections

The scanner connects to the DTAM Plus with the 9-Pin RS-232 Synapse cable (Catalog No. 2755-HFC-SR3-01). The cables and connections are shown in Chapter 2 of the scanner user manual (Publication 2755-6.2).

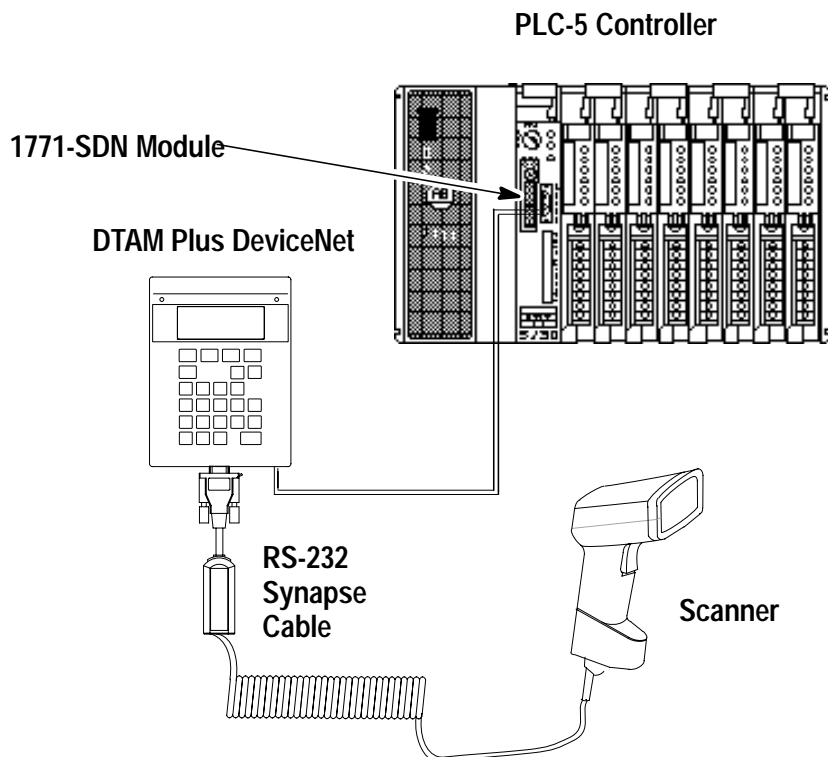

Codes for DTAM Plus Operator Interface DeviceNet Application

1. After making the necessary connections, scan the following following bar code symbol to set the scanner to its default settings.

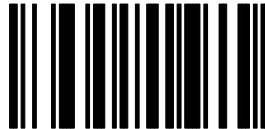

Set Scanner Defaults

2. Set the bar code suffix to CR LF (ASCII equivalent 7013) by scanning the following labels.

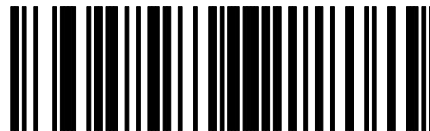

Suffix

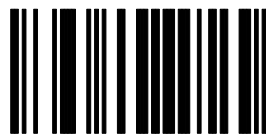

7



0

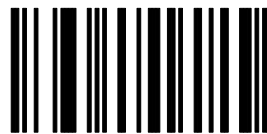

1

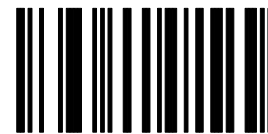

3

3. Send the data then the suffix by scanning these labels.

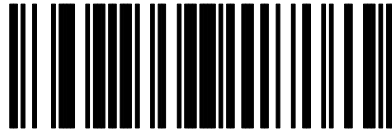

Scan this Symbol First

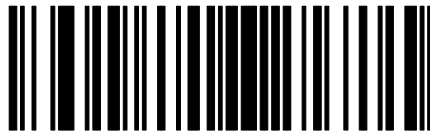

Send <Data> <Suffix>

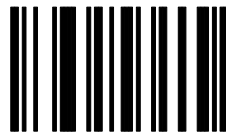

Scan Enter after Scanning Option

4. Set the RS-232 Synapse cable to defaults by scanning this label.



Set RS-232 Synapse Cable Defaults

5. The cable defaults will work with the DTAM Plus. Your application may have specific requirements. Chapter 3 lists the settings that can be modified. If you change a communication setting, make sure the PLC controller is configured to accept the change.

DTAM Plus Operator Interface Setup

You may need to configure the DTAM Plus Operator Interface RS-232 port to accept the scanner data. Refer to the *DTAM Programming Software Programming Manual*. Configure the DTAM Plus Operator Interface serial port as shown below.

1. Open Screen Builder.
2. Open Create Screen.
3. Open Data Entry Screen.
4. Select Set Up Screen.
5. Select Data Entry.
6. Select ASCII Input.
7. Set up DTAM.

DeviceNet Operation

The DTAM Plus DeviceNet operates as a Group 2 Server on the DeviceNet network. It supports the Unconnected Message Manager (UCMM). The DTAM Plus DeviceNet implements the predefined master/slave connection set, operating as a slave device. It does not initiate communications except for a Duplicate Node Address check on power-up.

The DTAM Plus DeviceNet supports the polled I/O method of exchanging data with a master, in the following sequence:

1. The designated master writes an output image to the DTAM Plus DeviceNet using the Poll Command message.
2. The DTAM Plus DeviceNet responds to the poll command by returning an input image back to the master in a Poll Response message.

Note: The size of the input and output images (also referred to as files) are individually configurable from 0 words to 121 words each, to optimize DeviceNet network loading.

3. The DTAM Plus DeviceNet application program interacts with data contained in the input and output files.
4. Data Display screens are used to view input and output data.
5. Data Entry screens are used to modify input and output data from the scanner.

ASCII Chart

| ASCII Value | Full ASCII Code 39 Encode Char. | Character (Control Code) | ASCII Value | Full ASCII Code 39 Encode Char. | Character (Control Code) |
|-------------|---------------------------------|--------------------------|-------------|---------------------------------|--------------------------|
| 1000 | %U | NULL (CTRL 2) | 1016 | \$P | DLE (CTRL P) |
| 1001 | \$A | SOH (CTRL A) | 1017 | \$Q | DC1 (CTRL Q) |
| 1002 | \$B | STX (CTRL B) | 1018 | \$R | DC2 (CTRL R) |
| 1003 | \$C | ETX (CTRL C) | 1019 | \$S | DC3 (CTRL S) |
| 1004 | \$D | EOT (CTRL D) | 1020 | \$T | DC4 (CTRL T) |
| 1005 | \$E | ENQ (CTRL E) | 1021 | \$U | NAK (CTRL U) |
| 1006 | \$F | ACK (CTRL F) | 1022 | \$V | SYN (CTRL V) |
| 1007 | \$G | BEL (CTRL G) | 1023 | \$W | ETB (CTRL W) |
| 1008 | \$H | BS (CTRL H) | 1024 | \$X | CAN (CTRL X) |
| 1009 | \$I | HT (CTRL I) | 1025 | \$Y | EM (CTRL Y) |
| 1010 | \$J | LF (CTRL J) | 1026 | \$Z | SUB (CTRL Z) |
| 1011 | \$K | VT (CTRL K) | 1027 | %A | ESC (CTRL) |
| 1012 | \$L | FF (CTRL L) | 1028 | %B | FS (CTRL \) |
| 1013 | \$M | CR (CTRL M) | 1029 | %C | GS (CTRL I) |
| 1014 | \$N | SO (CTRL N) | 1030 | %D | RS (CTRL 6) |
| 1015 | \$O | SI (CTRL O) | 1031 | %E | US (CTRL _) |

| ASCII Value | Full ASCII Code 39 Encode Char. | Character | ASCII Value | Full ASCII Code 39 Encode Char. | Character |
|-------------|---------------------------------|-----------|-------------|---------------------------------|-----------|
| 1032 | SP | SP | 1057 | 9 | 9 |
| 1033 | /A | ! | 1058 | /Z | : |
| 1034 | /B | ' | 1059 | %F | ; |
| 1035 | /C | # | 1060 | %G | < |
| 1036 | /D | \$ | 1061 | %H | = |
| 1037 | /E | % | 1062 | %I | > |
| 1038 | /F | & | 1063 | %J | ? |
| 1039 | /G | ' | 1064 | %V | @ |
| 1040 | /H | (| 1065 | A | A |
| 1041 | /I |) | 1066 | B | A |
| 1042 | /J | * | 1067 | C | C |
| 1043 | /K | + | 1068 | D | D |
| 1044 | /L | , | 1069 | E | E |
| 1045 | - | - | 1070 | F | F |
| 1046 | . | . | 1071 | G | G |
| 1047 | / | / | 1072 | H | H |
| 1048 | 0 | 0 | 1073 | I | I |
| 1049 | 1 | 1 | 1074 | J | J |
| 1050 | 2 | 2 | 1075 | K | K |
| 1051 | 3 | 3 | 1076 | L | L |
| 1052 | 4 | 4 | 1077 | M | M |
| 1053 | 5 | 5 | 1078 | N | N |
| 1054 | 6 | 6 | 1079 | O | O |
| 1055 | 7 | 7 | 1080 | P | P |
| 1056 | 8 | 8 | 1081 | Q | Q |

| ASCII Value | Full ASCII Code 39 Encode Char. | Character | ASCII Value | Full ASCII Code 39 Encode Char. | Character |
|-------------|---------------------------------|-----------|-------------|---------------------------------|-----------|
| 1082 | R | R | 1105 | +I | i |
| 1083 | S | S | 1106 | +J | j |
| 1084 | T | T | 1107 | +K | k |
| 1085 | U | U | 1108 | +L | l |
| 1086 | V | V | 1109 | +M | m |
| 1087 | W | W | 1110 | +N | n |
| 1088 | X | X | 1111 | +O | o |
| 1089 | Y | Y | 1112 | +P | p |
| 1090 | Z | Z | 1113 | +Q | q |
| 1091 | %K | [| 1114 | +R | r |
| 1092 | %L | \ | 1115 | +S | s |
| 1093 | %M |] | 1116 | +T | t |
| 1094 | %N | ^ | 1117 | +U | u |
| 1095 | %O | _ | 1118 | +V | v |
| 1096 | %W | ' | 1119 | +W | w |
| 1097 | +A | a | 1120 | +X | x |
| 1098 | +B | b | 1121 | +Y | y |
| 1099 | +C | c | 1122 | +Z | z |
| 1100 | +D | d | 1123 | %P | { |
| 1101 | +E | e | 1124 | %Q | |
| 1102 | +F | f | 1125 | %R | } |
| 1103 | +G | g | 1126 | %S | ~ |
| 1104 | +H | h | 1127 | | Undefined |

ALT Key Values

| ALT Key Value | Keystroke | ALT Key Value | Keystroke | ALT Key Value | Keystroke |
|---------------|-----------|---------------|-----------|---------------|-----------|
| 2064 | ALT 2 | 2075 | ALT K | 2086 | ALT V |
| 2065 | ALT A | 2076 | ALT L | 2087 | ALT W |
| 2066 | ALT B | 2077 | ALT M | 2088 | ALT X |
| 2067 | ALT C | 2078 | ALT N | 2089 | ALT Y |
| 2068 | ALT D | 2079 | ALT O | 2090 | ALT Z |
| 2069 | ALT E | 2080 | ALT P | 2091 | ALT [|
| 2070 | ALT F | 2081 | ALT Q | 2092 | ALT \ |
| 2071 | ALT G | 2082 | ALT R | 2093 | ALT] |
| 2072 | ALT H | 2083 | ALT S | 2094 | ALT 6 |
| 2073 | ALT I | 2084 | ALT T | 2095 | ALT - |
| 2074 | ALT J | 2085 | ALT U | | |

Miscellaneous Key Values

| Misc. Key Value | Keystroke | Misc. Key Value | Keystroke | Misc. Key Value | Keystroke |
|-----------------|-----------|-----------------|-----------|-----------------|---------------|
| 3001 | PA 1 | 3009 | CMD 7 | 3017 | |
| 3002 | PA 2 | 3010 | CMD 8 | 3018 | $\frac{1}{2}$ |
| 3003 | CMD 1 | 3011 | CMD 9 | 3019 | |
| 3004 | CMD 2 | 3012 | CMD 10 | 3020 | |
| 3005 | CMD 3 | 3013 | | 3021 | |
| 3006 | CMD 4 | 3014 | | 3022 | 0/00 |
| 3007 | CMD 5 | 3015 | | | |
| 3008 | CMD 6 | 3016 | - | | |

Numeric Key Values

| Numeric Key Value | Keystroke | Numeric Key Value | Keystroke | Numeric Key Value | Keystroke |
|-------------------|-----------|-------------------|-----------|-------------------|-----------|
| 6042 | * | 6049 | 1 | 6056 | 8 |
| 6043 | + | 6050 | 2 | 6057 | 9 |
| 6044 | Undefined | 6051 | 3 | 6058 | Enter |
| 6045 | - | 6052 | 4 | 6059 | Num Lock |
| 6046 | . | 6053 | 5 | 6060 | 00 |
| 6047 | / | 6054 | 6 | | |
| 6048 | 0 | 6055 | 7 | | |

Extended Keyapd Key Values

| Numeric Key Value | Keystroke | Numeric Key Value | Keystroke | Numeric Key Value | Keystroke |
|-------------------|-------------|-------------------|--------------|-------------------|-------------|
| 7001 | Break | 7008 | Backspace | 7015 | Up Arrow |
| 7002 | Delete | 7009 | Tab | 7016 | Down Arrow |
| 7003 | Page Up | 7010 | Print Screen | 7017 | Left Arrow |
| 7004 | End | 7011 | Insert | 7018 | Right Arrow |
| 7005 | Page Down | 7012 | Home | 7019 | Back Tab |
| 7006 | Pause | 7013 | Enter | | |
| 7007 | Scroll Lock | 7014 | Escape | | |

TEST SYMBOLS

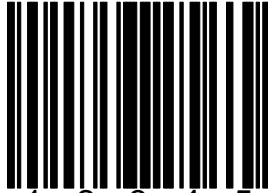

1 2 3 4 5
Code 128

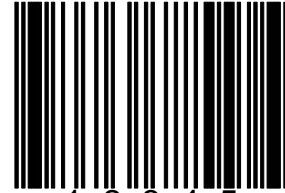

1 2 3 4 5
Code 93

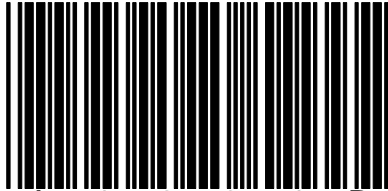

A 1 2 3 4 B
Code 39

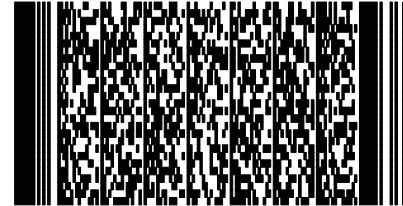

PDF-417

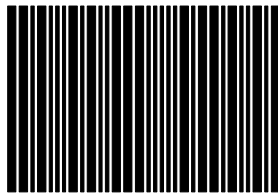

1 2 3 4 5
Discrete 2 of 5

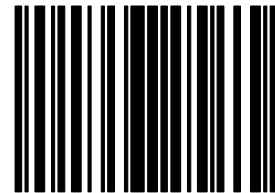

1 2 3 4 5
EAN 128



1 2 3 4 5 6 7 8 9 10 19
EAN 13

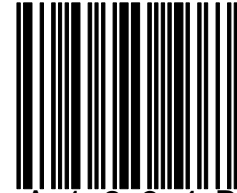

A 1 2 3 4 B
Codabar

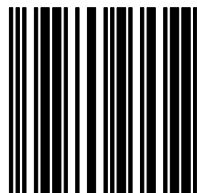

0 1 2 3 4 5
Interleaved 2 of 5



1 2 3 4 5 6 7 0
EAN 8

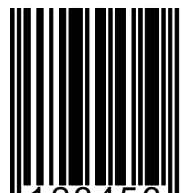

0 1 2 3 4 5 6
UPC E



1 2 3 4 5 6 7 8 9 0 1 2
UPC A

Synapse™ is a trademark of Symbol Technologies Inc.

AdaptaScan™ is a trademark of Allen-Bradley

 **Rockwell** Automation

Allen-Bradley

Worldwide representation.

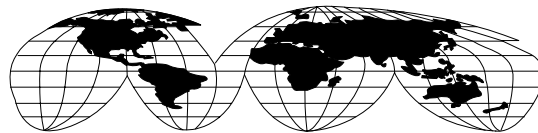

Argentina • Australia • Austria • Bahrain • Belgium • Brazil • Bulgaria • Canada • Chile • China, PRC • Colombia • Costa Rica • Croatia • Cyprus • Czech Republic • Denmark • Ecuador • Egypt • El Salvador • Finland • France • Germany • Greece • Guatemala • Honduras • Hong Kong • Hungary • Iceland • India • Indonesia • Ireland • Israel • Italy • Jamaica • Japan • Jordan • Korea • Kuwait • Lebanon • Malaysia • Mexico • Netherlands • New Zealand • Norway • Pakistan • Peru • Philippines • Poland • Portugal • Puerto Rico • Qatar • Romania • Russia–CIS • Saudi Arabia • Singapore • Slovakia • Slovenia • South Africa, Republic • Spain • Sweden • Switzerland • Taiwan • Thailand • Turkey • United Arab Emirates • United Kingdom • United States • Uruguay • Venezuela • Yugoslavia

Allen-Bradley Headquarters, 1201 South Second Street, Milwaukee, WI 53204 USA, Tel: (1) 414 382-2000 Fax: (1) 414 382-4444

Publication 2755-6.7 – September 1996

40062-358-01(A)

Copyright 1996 Allen-Bradley Company, Inc. Printed in USA