

Wasp WLP 4170 CCD Programming Guide



Please Read

Note:

The Wasp WLP 4170 CCD Scanner is ready to scan the most popular bar codes out of the box. ***This manual should only be used to make changes in the configuration of the scanner for specific applications.*** This scanner does not require software or drivers to operate. The scanner enters data as keyboard data. Please review this manual before scanning any of the programming bar codes in this manual.



Tech Tip

If you are unsure of the scanner configuration or have scanned the incorrect codes, please scan the default bar code on page 6. This will reset the scanner to its factory settings.

© Copyright Wasp Technologies 2002.
All rights reserved.
Version 1.0

No part of this publication may be reproduced or transmitted in any form or by any means without the written permission of Wasp Technologies. The information contained in this document is subject to change without notice.

Wasp is a trademark of Wasp Technologies. All other trademarks or registered trademarks are the property of their respective owners.

Table of Contents

Chapter 1.	Introduction.....	1
Chapter 2.	Installation.....	2
Chapter 3.	Quick Start	3
Chapter 4.	Bar Code Symbologies.....	4
Chapter 5.	Setup & Configuration.....	5-34
	1. Factory Default	6
	2. Beep and Delay	7
	3. Intercharacter Delay	8
	4. Keyboard Wedge.....	9
	5. Scanning Modes	10
	6. Preamble/Postamble Configuration.....	11
	5. Bar Code Symbology.....	12-29
	Code 39.....	12-13
	Code 128.....	14-15
	UPC-A	16-17
	UPC-E	18-19
	EAN-13	20-21
	EAN-8	22-23
	Code 93	24
	Interleaved 2 of 5	25
	Codabar.....	26-27
	MSI/Plessey	28
	PDF417.....	29
Appendix A.	Bar Code Test Symbols.....	30-33
	Specifications	34
	Product Support, Warranty.....	35
	ASCII Code Table	36

Introduction

Bar coding is the most common Automated Data Collection (ADC) technology providing timely, error-free information that can be used to increase productivity, accuracy, and efficiency in the workplace. Virtually every type of industry is using bar codes to replace keyboard data entry. Studies have shown that a proficient data entry operator will make one error for every 300 characters that are manually entered. The error rate using bar codes is almost negligible and can be error-free using bar code symbologies with the check digit enabled.

The Wasp Charged Coupled Device (CCD) technology is a technique whereby a bar code is photographed, digitized, and electronically sampled by built-in photodetectors. The detectors process the measurement of every bar and space using the number of adjacent photodetectors which contrast a black mark and a white space. Wasp WLP 4170 CCD is extremely rugged since it has no moving parts. Wasp WLP 4170 CCD reader supports PC AT/XT and PS/2 keyboard interfaces and easily wedges between the computer and keyboard. Bar code data is passed directly into the keyboard buffer as if it had been typed in by hand by a data entry operator.

Of all the hand held bar code scanning devices on the market, the CCD reader is the easiest to use and most cost effective for the typical business user. To activate the scanner, the user simply points the scanning aperture towards the bar code, pulls the trigger, and aims the red LED beam across the bar code.

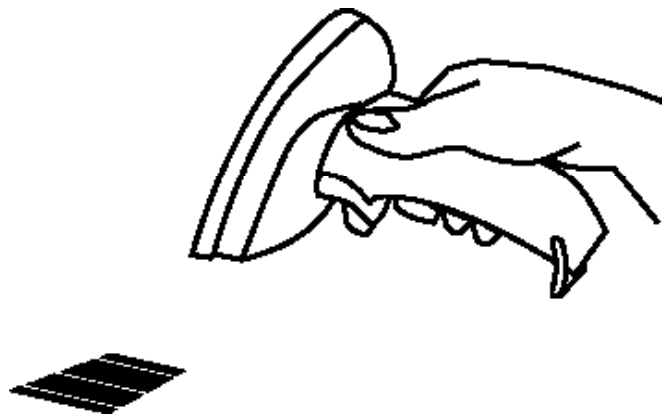

Installation

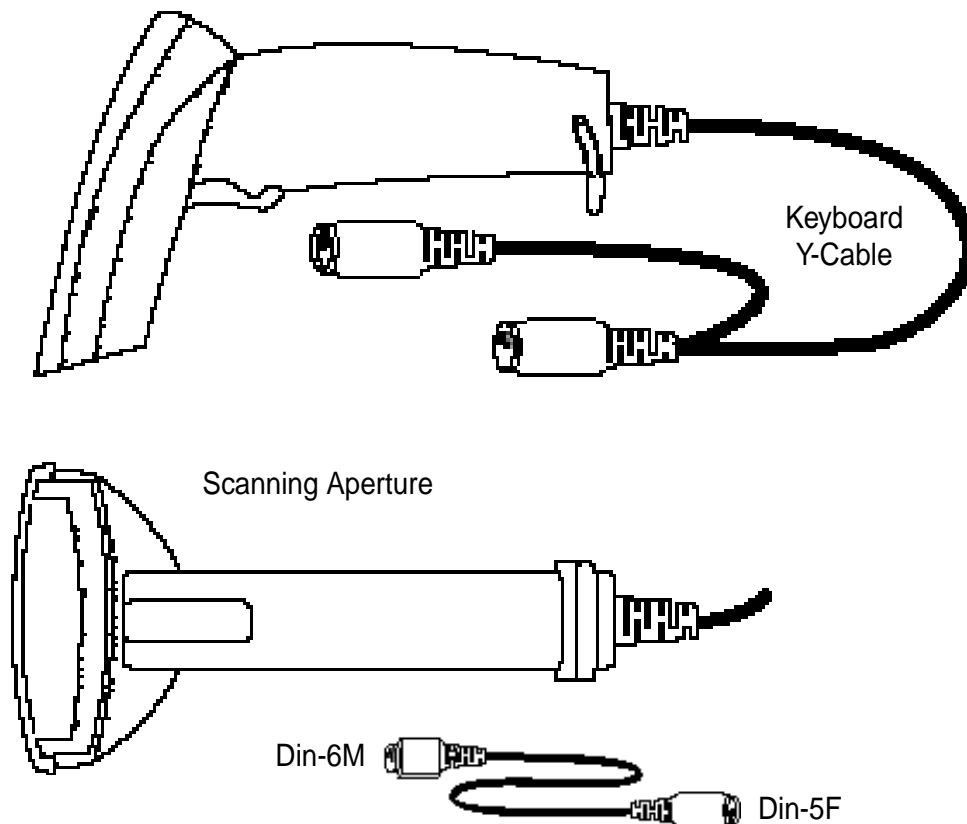

1. Turn off your computer.
2. Unplug your PC keyboard cable and plug the male end (Din 5) of the Wasp WLP 4170 CCD Scanner directly into your PC keyboard port. Plug your keyboard cable into the other end (female Din 5) of the the Wasp WLP 4170 CCD Scanner. If your keyboard and PC support a Din 6 connection, use the enclosed Din 5 to Din 6 converter cable to connect to the keyboard power tap cable.
3. Turn your computer on.

Quick Start

Your Wasp WLP 4170 CCD Scanner is ready to go. The default settings of the Wasp WLP 4170 CCD Scanner have been pre-programmed for the most common bar code configurations. Use the "Setup & Configuration" sections only to customize the Wasp settings.

Tip: Use the pre-printed "Bar Code Test Symbols" in Appendix A on page 30 as a test chart to begin practicing scanning.

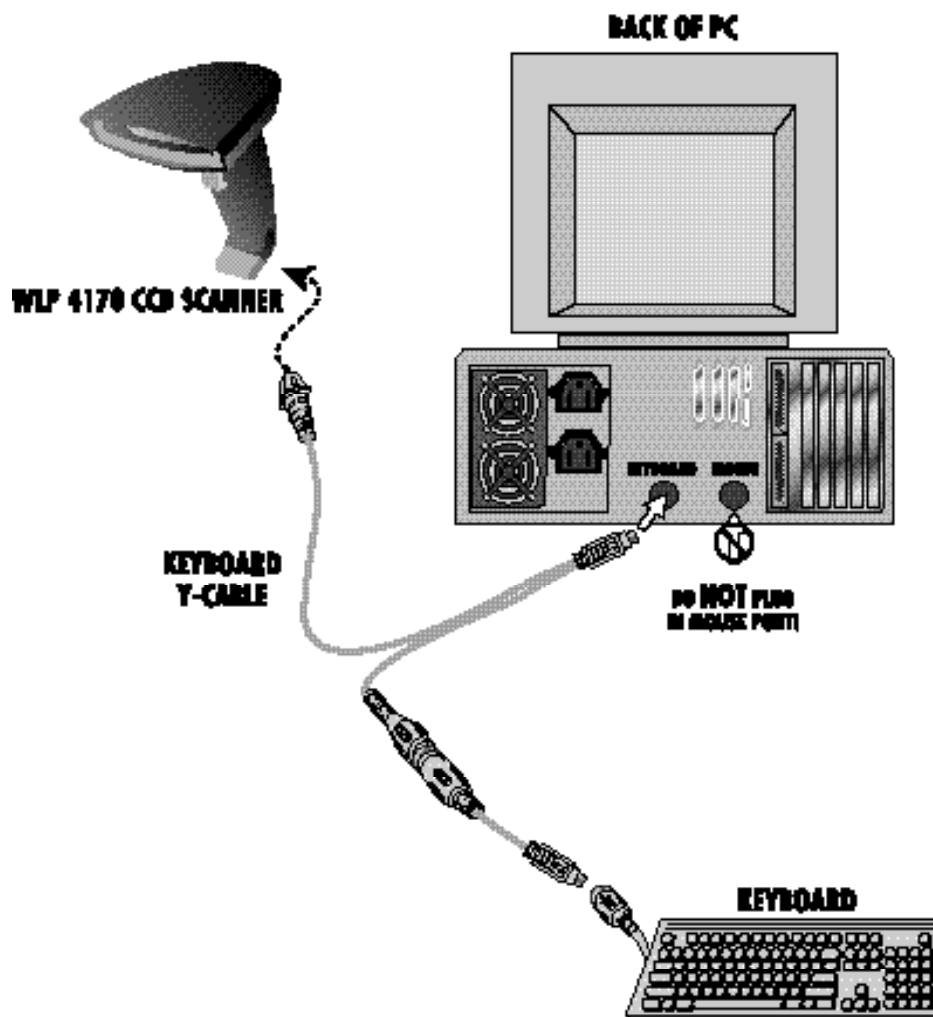

Bar Code Symbologies

Bar codes are symbols consisting of a series of bars and spaces which can be applied to packages, cartons, bottles, and other commercial products. The bars and spaces in each symbol are grouped in such a way to represent a specific ASCII character or function. The interpretation of these groups is based on a particular set of rules called symbologies. Various symbologies have been developed for particular applications. Some examples are shipping and receiving, manufacturing, retail, healthcare, transportation, document processing and tracking, and libraries.

The resolution of a bar code is dependent on the narrowest element of a bar code (X dimension), and can vary from high density (nominally less than 0.009 in./0.23 mm), medium density (between 0.009 in./0.23 mm and 0.020 in./0.50 mm), and low density (greater than 0.020 in./0.50 mm). Medium and low densities are the most common since these are the easiest to read (scan) with nearly all scanning devices. Wasp WLP 4170 CCD Scanner can read bar codes with X-dimensions as low as 4 mils (0.10mm).

Wasp WLP 4170 CCD Scanner can read the most popular linear bar code symbologies including Code 39, Code 93, Code 128, Interleaved 2 of 5, UPC-A, UPC-E, EAN/JAN-8, EAN/JAN-13, Codabar, and MSI Plessey, and also the 2D bar code symbology PDF417.

Please see test chart on pages 30-33.

Setup & Configuration

In order to configure Wasp WLP 4170 CCD Scanner, you must familiarize yourself with the setup procedures on the following pages. The default settings of Wasp WLP 4170 CCD Scanner are identified on each page and clearly marked using an asterisk (*). **The default settings have been preprogrammed for the most common bar code configurations. Use the Setup & Configuration only to customize the Wasp settings.** If you need to configure Wasp WLP 4170 CCD Scanner, the default settings will be overwritten. All the programmed settings are stored permanently in non-volatile memory. Therefore, your configuration will be maintained even if keyboard power to Wasp WLP 4170 CCD Scanner is removed by turning off your PC.

In order to configure Wasp WLP 4170 CCD Scanner, seven basic steps need to be followed for each programmed setting:

- (1) Determine what, if any, options on EACH PAGE that you wish to change.
- (2) Scan the "Begin" bar code. WLP 4170 CCD Scanner will sound an ascending tone to indicate that setup is in progress.
- (3) Scan the bar code representing the option to be changed.
- (4) Scan the bar codes representing the option values (e.g. 01, 02, 3A etc.). These option values can be found on the inside back cover flap of this manual. **You must scan two digits for each option setting.**
- (5) Repeat the above two steps, if necessary, to change the options in the same group.
- (6) Scan the "Set" bar code on the back cover flap to confirm your selections.
- (7) Scan the "Exit" bar code to exit the group currently selected. Wasp WLP 4170 CCD Scanner will sound a descending tone.

NOTE: Pages 6 and 7 are designed as walk through example pages. Use these pages as examples on how to change an option for the rest of the manual.

Setup & Configuration

—Factory Default

Tip: Use this configuration to restore the factory default settings if you are unsure how your scanner has been configured. The 'Factory Default' configuration is very useful when you need to reprogram your Wasp WLP 4170 CCD Scanner after the defaults have been changed. By setting the default configuration, the user knows precisely the configuration for each programmed setting.

1. Scan “Begin ”



Begin

2. Scan “Default” to restore scanner to default settings



Default

NOTE: Scanning these bar codes returns the scanner to the factory default settings

Setup & Configuration

—Beep and Delay

The 'Beep Volume' configuration changes the volume of the audible indicator of the WLP 4170 CCD Scanner.

NOTE: For help in configuring these settings, consult the programming steps on page 5.

1. Scan "Begin "



Begin

2. Scan "Set Beep Volume"



Set Beep Volume

3. Pick a setting from the table at right, then turn to the back cover flap and scan the corresponding two digits. For example: if you desire no beep, scan 0 and 0 on the back cover flap

Beep Volume Settings

00	None
01	Lowest
02	Low
03	Medium (Default)
04	Medium-High
05	High
06	High-Medium
07	Highest

4. Scan the "Set" barcode on the back cover flap

5. Scan the "Exit" barcode

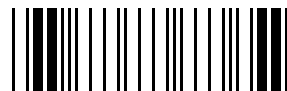

Exit

Setup & Configuration

—Intercharacter Delay

The 'Intercharacter Delay' configuration sets the speed at which the WLP 4170 CCD Scanner sends data. The intercharacter delay should be changed only if the transfer rate cannot be maintained between WLP 4170 CCD Scanner and the keyboard buffer of the computer.

Note: The default for the intercharacter delay is set to '2ms' and is the most common configuration; however, your PC may be different. When you scan a bar code, if some characters are missing, decrease the intercharacter delay speed to speed up the transfer rate. If some stray or scrambled characters appear on your screen, increase the intercharacter delay to slow down the transfer rate.

NOTE: For help in configuring these settings, consult the programming steps on page 5.



Begin

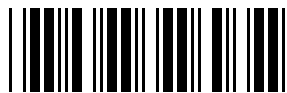

Set Intercharacter
Delay

Intercharacter Delay Settings

00	Slowest
01	Slow
02	Default
50	Medium
75	Fast
99	Fastest



Exit

Setup & Configuration

—Keyboard Wedge

The 'Keyboard Wedge' configuration supports options related to managing keyboard operations. The 'Function Code' option enables/disables support for your keyboard function keys. The 'Caps Lock' option toggles the case sensitivity of your keyboard. The 'Laptop/No Keyboard' setting should be enabled if you are connecting this scanner to a laptop or to a PC with no keyboard.

NOTE: For help in configuring these settings, consult the programming steps on page 5.



Begin



Set Function Code



Set Caps Lock

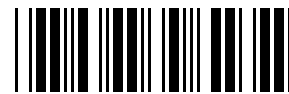

Set Laptop/No Keyboard



Exit

Function Code Settings

00	Off*
01	On

Caps Lock Settings

00	Caps Lock On
01	Caps Lock Off*

Laptop/No Keyboard Settings

00	Keyboard Present*
01	Laptop/No keyboard

Setup & Configuration

—Scanning Modes

The 'Scanning Mode' option controls the trigger and LED settings for the WLP 4170 CCD Scanner.

NOTE: For help in configuring these settings, consult the programming steps on page 5.



Begin



Set Scanning Mode

00	Default*	04	Continuous
----	----------	----	------------

Continuous Mode

When this option is selected, the LEDs are visible at all times. Under this option, you cannot read the same bar code back-to-back.

*** Trigger with 10 Sec. Delay**

This is the default option for the Wasp WLP 4170 CCD Scanner. When this option is selected, the scanner will stop scanning when there is a successful read or no code is scanned after 10 seconds.



Exit

Setup & Configuration

—Preamble and Postamble

The 'Preamble' and 'Postamble' options are used to add prefix and suffix characters to the bar code value. Up to 22 characters may be added for each option separately.

Note: This example illustrates how data will be formatted when each option is configured.

Data Stream Example		
Preamble	Data	Postamble

NOTE: For help in configuring these settings, consult the programming steps on page 5.



Begin



Set Preamble

Preamble

Scan 'Begin'. Scan "Set Preamble" to program preamble. Scan characters from the back cover flap using the ASCII Table on page 36. Scan "Set" on the back cover flap to end. Scan 'Exit'.



Set Postamble

Postamble

Scan 'Begin'. Scan "Set Postamble" to program postamble. Scan characters from the back cover flap using the ASCII Table on page 36. Scan "Set" on the back cover flap to end. Scan 'Exit'.



Exit

Setup & Configuration

—Code 39

Code 39 is variable length and is the most frequently used symbology in industrial bar code systems today and is extensively used within the Department of Defense (DOD). The principal feature is to encode messages using the full alphanumeric character set.

NOTE: For help in configuring these settings, consult the programming steps on page 5.



Begin

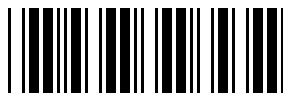

On/Off

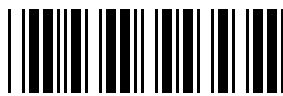

Verify Check Digit

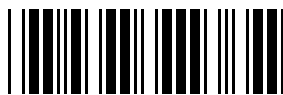

Transmit Check Digit



Exit

Option	Alpha/Numeric Entry (Back Flap)
Disable	00
Enable	01*
Disable	00
Enable	01*
Disable	00*
Enable	01

Setup & Configuration

—Code 39 (cont.)

Standard Code 39 contains only 43 characters (0-9, A-Z, \$, /, %, +, -, ., SPACE) and can be extended to a 128 character symbology (full ASCII) by combining one of the special characters (\$, /, %, +) with a letter (A-Z) to form the characters that are not present in the standard Code 39 symbology.

NOTE: For help in configuring these settings, consult the programming steps on page 5.



Begin



Set Maximum Length

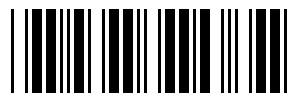

Set Minimum Length



Format



Start/Stop Transmission



Exit

Option	Alpha/Numeric Entry (Back Flap)
00 - 64	00 - 64 00*
00 - 64	00 - 64 00*
Standard Full ASCII	00* 01
Disable Enable	00* 01

Setup & Configuration

—Code128

Code 128 is variable length and encodes the full 128 ASCII character set. Each character is represented by 11 modules that can be one of four bar widths. Code 128 is the most easily read code with the highest message integrity due to several separate message check routines. Code 128 is usually the best choice when implementing a new symbology.

NOTE: For help in configuring these settings, consult the programming steps on page 5.



Begin

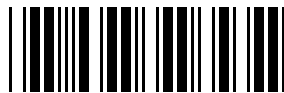

On/Off



Verify Check Digit



Transmit Check Digit



Exit

Option	Alpha/Numeric Entry (Back Flap)
Disable	00
Enable	01*
Disable	00
Enable	01*
Disable	00*
Enable	01

Setup & Configuration

—Code128 (cont.)

Code 128 is the most flexible of all the common linear symbologies. It supports alpha and numeric characters easily, has the highest number of characters per inch, and is variable length.

NOTE: For help in configuring these settings, consult the programming steps on page 5.



Begin

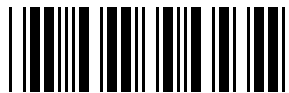

Set Maximum Length

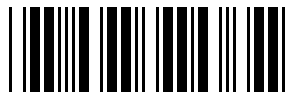

Set Minimum Length



Format



Exit

Option	Alpha/Numeric Entry (Back Flap)
64 - Minimum	00 - 64 00*
64 - Maximum	00 - 64 00*
Standard UCC/EAN-128	00* 01

Setup & Configuration

—UPC-A

UPC-A (Universal Product Code-A) is fixed length and is the most common UPC bar code for retail product labeling. It is seen in most grocery stores across the United States. The symbology encodes a 12-digit number.

NOTE: For help in configuring these settings, consult the programming steps on page 5.



Begin

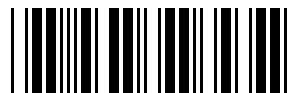

On/Off



Verify Check Digit



Transmit Check Digit



Exit

Option	Alpha/Numeric Entry (Back Flap)
Disable Enable	00 01*
Disable Enable (two digits)	00 01*
Disable Enable	00 01*

Setup & Configuration

—UPC-A (cont.)

The first six digits of the UPC-A bar code are assigned from the Uniform Code Council (UCC). The next five digits are assigned by the manufacturer, and the final digit is a modulo 10 check digit. The nominal height for the UPC-A bar code is one inch. The reduced size is 80% of the nominal size.

NOTE: For help in configuring these settings, consult the programming steps on page 5.



Begin



Supplement Digits

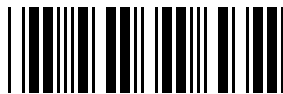

Truncate Leading Zero



Exit

Option	Alpha/Numeric Entry (Back Flap)
None	00*
2 digits	01
5 digits	02
2 / 5 digits or None	03
Disable	00*
Enable	01

Setup & Configuration

—UPC-E

UPC-E (Universal Product Code-E) is fixed length and is a compressed six digit code used for marking small packages, including magazines and paperback books. UPC-E symbols are UPC-A symbols that have been zero suppressed (i.e. consecutive zeros are not included in the symbol).

NOTE: For help in configuring these settings, consult the programming steps on page 5.



Begin

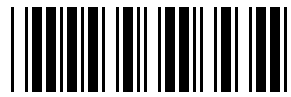

On/Off



Verify Check Digit



Transmit Check Digit



Exit

Option	Alpha/Numeric Entry (Back Flap)
Disable	00
Enable	01*
Disable	00
Enable	01*
Disable	00
Enable	01*

Setup & Configuration

—UPC-E (cont.)

The printed value of the UPC-E code is a twelve digit code. The nominal height for the UPC-E bar code is one inch. The reduced size is 80% of the nominal size.

NOTE: For help in configuring these settings, consult the programming steps on page 5.



Begin

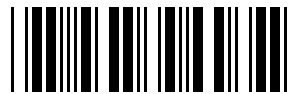

Supplement Digits

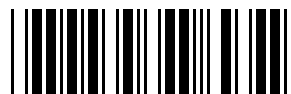

Truncate Leading Zero



Expansion



Exit

Option	Alpha/Numeric Entry (Back Flap)
None	00*
2 digits	01
5 digits	02
2 / 5 digits or None	03
Disable	00*
Enable	01
Disable	00*
Enable	01

Setup & Configuration

—EAN-13

The EAN/JAN-13 (European Article Number/Japanese Article Number) is fixed length and is similar to the UPC-A symbology, but encodes a 13th digit. The nominal height for the EAN/JAN-8 bar code is one inch. The reduced size is 80% of the nominal size.

NOTE: For help in configuring these settings, consult the programming steps on page 5.



Begin

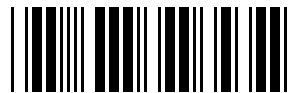

On/Off



Verify Check Digit



Transmit Check Digit



Exit

Option	Alpha/Numeric Entry (Back Flap)
Disable	00
Enable	01*
Disable	00
Enable	01*
Disable	00
Enable	01*

Setup & Configuration

—EAN-13 (cont.)

The EAN/JAN-13 (European Article Number/Japanese Article Number) is fixed length and is similar to the UPC-A symbology, but encodes a 13th digit. The nominal height for the EAN/JAN-8 bar code is one inch. The reduced size is 80% of the nominal size.

NOTE: For help in configuring these settings, consult the programming steps on page 5.



Begin

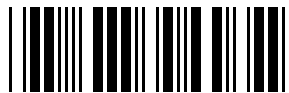

Supplement Digits

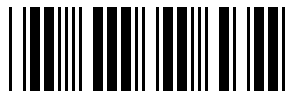

Truncate Leading Zero

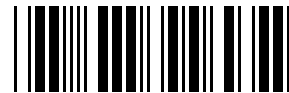

Convert to ISBN/ISSN



Exit

Option	Alpha/Numeric Entry (Back Flap)
None	00*
2 digits	01
5 digits	02
2 / 5 digits or None	03
Disable	00*
Enable	01
Disable	00*
Enable	01

Setup & Configuration

—EAN-8

The EAN/JAN-8 is fixed length and is similar to the UPC-E code, but includes two more digits for the country code. The nominal height for the EAN/JAN-8 bar code is one inch. The reduced size is 80% of the nominal size.

NOTE: For help in configuring these settings, consult the programming steps on page 5.



Begin

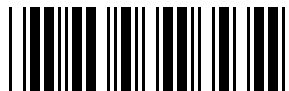

On/Off



Verify Check Digit



Transmit Check Digit



Exit

Option	Alpha/Numeric Entry (Back Flap)
Disable	00
Enable	01*
Disable	00
Enable	01*
Disable	00
Enable	01*

Setup & Configuration

—EAN-8 (cont.)

The EAN/JAN-8 is fixed length and is similar to the UPC-E code, but includes two more digits for the country code. The nominal height for the EAN/JAN-8 bar code is one inch. The reduced size is 80% of the nominal size.

NOTE: For help in configuring these settings, consult the programming steps on page 5.



Begin



Supplement Digits



Truncate Leading Zero



Expansion



Exit

Option	Alpha/Numeric Entry (Back Flap)
None	00*
2 digits	01
5 digits	02
2 / 5 digits or None	03
Disable	00*
Enable	01
Disable	00*
Enable	01

Setup & Configuration

—Code 93

Code 93 encodes the full 128 ASCII character set using 9 modules arranged into 3 bars with adjacent spaces. Two of the characters are check characters. Code 93 is similar to Code 39 but encodes more characters per inch. Code 93 encodes the full 128 ASCII character set and is encoded similarly to the extended Code 39.

NOTE: For help in configuring these settings, consult the programming steps on page 5.



Begin



On/Off



Verify Check Digit



Transmit Check Digit



Set Maximum Length



Set Minimum Length



Exit

Option	Alpha/Numeric Entry (Back Flap)
Disable Enable	00* 01
Disable Enable (two digits)	00 01*
Disable Enable	00* 01
64 - Minimum	64 - 00 00*
00 - Maximum	00 - 64 00*

Setup & Configuration

—Interleaved 2 of 5

Interleaved 2 of 5 is a variable length, even numbered, numeric bar code. It is typically used in industrial and master carton labeling and also in the automobile industry. The symbology uses bars to represent the first digit of a pair and the interleaved (white) spaces to represent the second digit of a character pair. See page 24 for information on setting the minimum and maximum lengths.

NOTE: For help in configuring these settings, consult the programming steps on page 5.



Begin

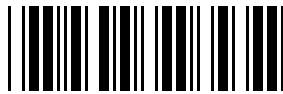

On/Off



Verify Check Digit



Transmit Check Digit



Exit

Option	Alpha/Numeric Entry (Back Flap)
Disable	00
Enable	01*
Disable	00
Enable	01*
Disable	00*
Enable	01

Setup & Configuration

—Codabar

Codabar is a variable length symbology capable of encoding six special alphanumeric characters, capital letters A through D, T, N, *, E, and all numeric digits. Codabar is one of the oldest bar code symbologies and is still used in some library applications. It should not be considered for new applications except under unusual circumstances.

NOTE: For help in configuring these settings, consult the programming steps on page 5.



Begin



On/Off



Verify Check Digit

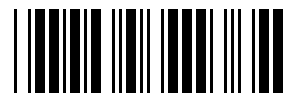

Transmit Check Digit



Set Maximum Length



Exit

Option	Alpha/Numeric Entry (Back Flap)
Disable	00
Enable	01*
Disable	00*
Enable	01
Disable	00*
Enable	01
64 - minimum	64 - 00 00*

Setup & Configuration

—Codabar (cont.)

Codabar is a variable length symbology capable of encoding six special alphanumeric characters, capital letters A through D, T, N, *, E, and all numeric digits. Codabar is one of the oldest bar code symbologies and is still used in some library applications. It should not be considered for new applications except under unusual circumstances.

NOTE: For help in configuring these settings, consult the programming steps on page 5.



Begin

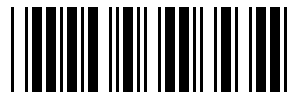

Set Minimum Length



Start/Stop Type



Start/Stop Transmission



Exit

Option	Alpha/Numeric Entry (Back Flap)
00 - Maximum	00 - 64 00*
ABCD/ABCD abcd/abcd ABCD/TN*E Abcd/tn*e	00* 01 02 03
Disable Enable	00* 01

Setup & Configuration

—MSI Plessey

MSI Plessey is a variable length numeric symbology and is primarily used in marking retail shelves. Each character consists of four bars with intervening spaces for each encoded digit, one or two symbol check digits, and a reverse start code.

NOTE: For help in configuring these settings, consult the programming steps on page 5.



Begin



On/Off



Verify Check Digit

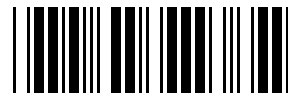

Transmit Check Digit

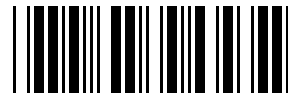

Set Maximum Length



Set Minimum Length



Exit

Option	Alpha/Numeric Entry (Back Flap)
Disable Enable	00* 01
Disable Mod 10 Mod 10/10 Mod 11/10	00* 01 02 03
Disable Enable	00* 01
64 - Minimum	64 - 00 00*
00 - Maximum	00 - 64 00*

Setup & Configuration

—PDF417

PDF417 is a 2D variable length symbology that can encode virtually any letter, number, or character. Each character consists of 4 bars and 4 spaces in a 17 module structure. The name of the symbol is derived from the format of the code. PDF stands for "Portable Data File" and "417" is derived from the module structure. Each PDF417 symbol consists of 3 to 90 stacked rows surrounded by a quiet zone on all four sides. Each row consists of a leading quiet zone, start pattern, left row indicator character, one to thirty data characters, right row indicator character, stop pattern, and trailing quiet zone.

PDF417 supports text compaction, numeric compaction, and byte compaction that correlate the mapping between code word values and decoded data. PDF417 can accommodate up to 340 characters per square inch with a maximum data capacity of 1850 text characters.

NOTE: For help in configuring these settings, consult the programming steps on page 5.



Begin

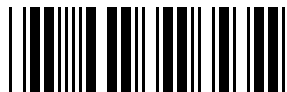

On/Off

Option	Alpha/Numeric Entry (Back Flap)
Disable	00*
Enable	01



Exit

Setup & Configuration

—Bar Code Test Symbols—Appendix A

Note: Make sure that the appropriate bar code symbology is configured properly and enabled before trying to scan. Use the 'Bar Code Symbologies' configuration beginning on page 14 to enable specific symbologies.

Code 39*



Code 93*



Interleaved 2 of 5



Codabar*



Code 128*



MSI/Plessey



Setup & Configuration

—Bar Code Test Symbols—Appendix A (cont.)

UPC-A*



UPC-A
w/5 digit supplement

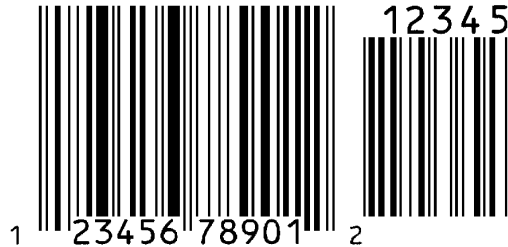

UPC-A
w/2 digit supplement



UPC-E*



UPC-E
w/5 digit supplement



UPC-E
w/2 digit supplement



Setup & Configuration

—Bar Code Test Symbols—Appendix A (cont.)

EAN/JAN 13*



EAN/JAN 13
w/5 digit supplement



EAN/JAN 13
w/2 digit supplement



Setup & Configuration

—Bar Code Test Symbols—Appendix A (cont.)

EAN/JAN 8*



EAN/JAN 8+5
w/5 digit supplement



EAN/JAN 8
w/2 digit supplement



PDF417

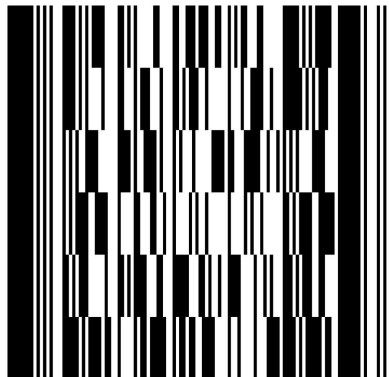

Setup & Configuration

—WLP 4170 CCD Specifications

MODEL	WLP 4170
OPTICAL	
Scanning Width	3.2 in (120 mil)
Depth of Field	0 to 3 in (0 to 200 mil)
Scan Rate	200 scans / second
ELECTRICAL	
Light Source	660 nm red visible LED
Sensor	2,048 pixel CCD array
Operating Voltage	+5 VDC \pm 0.25V
Current Consumption	Standby 100 mA @ 5 VDC / Sleep 25 mA @ 5 VDC Operating 180 mA @ 5 VDC
MECHANICAL	
Dimensions	W3.5" x T4.5" x H7.2"
Weight	150 g (without cable)
Cable	6 ft
ENVIRONMENTAL	
Operating Temperature	0°C to 40°C
Storage Temperature	-40°C to 60°C
Relative Humidity	5% to 90% non-condensing
Safety Certification	Conforms FCC Class A and CE requirements

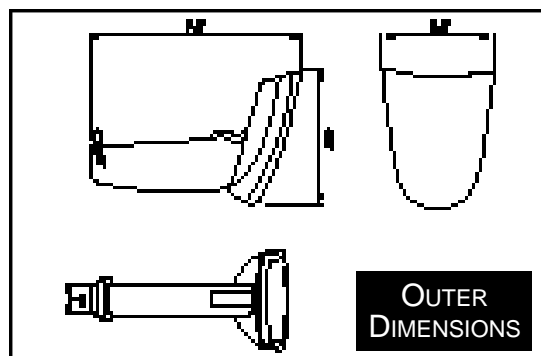

Product Support

If you experience any problems with Wasp WLP 4170 CCD Scanner that you are unable to resolve, call for technical assistance at (214) 547-4100, Monday through Friday, 8:00 AM - 5:00 PM Central Standard Time. Our web site is

www.waspbarcode.com

You may also contact us in writing at:

Wasp Technologies
1400 10th Street
Plano, TX 75074
(214) 547-4100
(214) 547-4101 Fax

Warranty Information

Wasp Bar Code products are warranted against defects in workmanship and materials for a period of one year from the date of shipment, provided that the product remains unmodified and is operated under normal and proper conditions.

This warranty is limited to repair or replacement at Wasp Bar Code's option, with reasonable promptness after being notified. These provisions do not prolong the original warranty term for any product which has been repaired or replaced by Wasp Bar Code.

This warranty applies to the original owner and does not extend to any product which has been subject to misuse, neglect, accidental damage, unauthorized repair, or tampering.

No other express warranty is given. The replacement or repair of a product is your exclusive remedy. Any other implied warranty of merchantability or fitness is limited to the duration of this written warranty. Some states, provinces, and countries do not allow how long an implied warranty lasts, so the above limitation may not apply to you.

In no event shall Wasp Bar Code be liable for consequential damages. Some states, provinces, and countries do not allow the exclusion or limitation of incidental or consequential damages, so the above limitations may not apply to you.

ASCII Code Table

ASCII Preamble/Postamble Code Table							
Code	ASCII	Code	ASCII	Code	ASCII	Code	ASCII
00	Null	23	#	43	C	63	c
01	Up	24	\$	44	D	64	d
02	Down	25	%	45	E	65	e
03	Left	26	&	46	F	66	f
04	Right	27	'	47	G	67	g
05	PgUp	28	(48	H	68	h
06	PgDn	29)	49	I	69	i
08	BS	2A	★	4A	J	6A	j
09	Tab	2B	+	4B	K	6B	k
0B	Home	2C	□	4C	L	6C	l
0C	End	2D	-	4D	M	6D	m
0D	Enter	2E	.	4E	N	6E	n
0E	Insert	2F	/	4F	O	6F	o
0F	Delete	30	0	50	P	70	p
11	F1	31	1	51	Q	71	q
12	F2	32	2	52	R	72	r
13	F3	33	3	53	S	73	s
14	F4	34	4	54	T	74	t
15	F5	35	5	55	U	75	u
16	F6	36	6	56	V	76	v
17	F7	37	7	57	W	77	w
18	F8	38	8	58	X	78	x
19	F9	39	9	59	Y	79	y
1A	F10	3A	:	5A	Z	7A	z
1B	ESC	3B	;	5B	[7B	□
1C	F11	3C	<	5C	□	7C	□
1D	F12	3D	=	5D]	7D	□
1E	Ctrl+	3E	>	5E	^	7E	~
1F	Alt+	3F	?	5F	`	7F	Delete
20	Space	40	@	60	`		
21	!	41	A	61	a		
22	"	42	B	62	b		

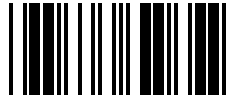

0



A



1

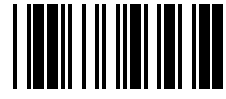

B



2

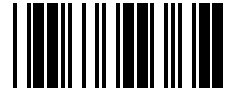

C

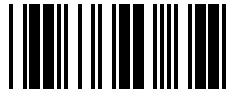

3

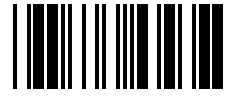

D

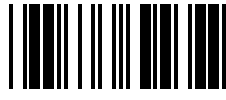

4

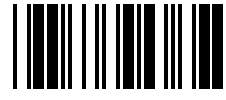

E

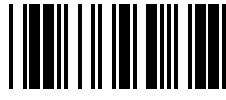

5

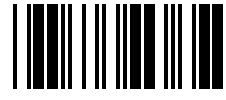

F



6



FINISH

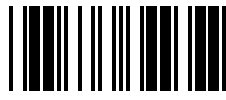

7



8

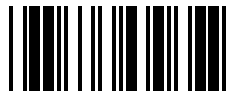

9

BACK COVER BAR CODES